



# FCC RADIO TEST REPORT

## FCC ID:P3SM71G

**Product :** Tablet PC

**Trade Name :** Great Wall, Digital2

**Model Name :** M71G

**Serial Model :** D2-7\*\*\*\_\*\* (The first, second and third symbol \* in type designation can be any alphanumeric character or blank and denote different client or different sales area The fourth and fifth symbol \* in type designation can be any alphanumeric character or blank and denote different colour of enclosure)

**Report No. :** NTEK-2013NT0619589F

### Prepared for

China Greatwall Computer Shenzhen Co., Ltd.  
Greatwall Computer Bldg, Kefa Road, Nanshan  
District, Shenzhen, Guangdong, PRC

### Prepared by

Shenzhen NTEK Testing Technology Co., Ltd.  
1/F, Building E, Fenda Science Park, Sanwei Community, Xixiang Street  
Bao'an District, Shenzhen P.R. China  
Tel.: +86-0755-61156588 Fax.: +86-0755-61156599  
Website: www.ntek.org.cn

## TEST RESULT CERTIFICATION

**Applicant's name** ..... : China Greatwall Computer Shenzhen Co., Ltd.

**Address** ..... : Greatwall Computer Bldg, Kefa Road, Nanshan District, Shenzhen, Guangdong, PRC

**Manufacturer's Name** ..... : China Greatwall Computer Shenzhen Co., Ltd.

**Address** ..... : Greatwall Computer Bldg, Kefa Road, Nanshan District, Shenzhen, Guangdong, PRC

### Product description

**Product name** ..... : Tablet PC

**Model and/or type reference** : M71G

**Serial Model** ..... : D2-7\*\*\*\_\*\* (The first, second and third symbol \* in type designation can be any alphanumeric character or blank and denote different client or different sales area The fourth and fifth symbol \* in type designation can be any alphanumeric character or blank and denote different colour of enclosure)

**Standards** ..... : FCC Part15.247

**Test procedure** ..... ANSI C63.4-2003

This device described above has been tested by NTEK, and the test results show that the equipment under test (EUT) is in compliance with the FCC requirements. And it is applicable only to the tested sample identified in the report.

This report shall not be reproduced except in full, without the written approval of NTEK, this document may be altered or revised by NTEK, personal only, and shall be noted in the revision of the document.

**Date of Test** ..... :

**Date (s) of performance of tests** ..... : 19 Jun. 2013 ~22 Jun. 2013

**Date of Issue** ..... : 22 Jun. 2013

**Test Result** ..... : **Pass**

**Testing Engineer** : Apple Huang  
(Apple Huang)

**Technical Manager** : Tom Zhang  
(Tom Zhang)

**Authorized Signatory** : Bovey Yang  
(Bovey Yang)

**Table of Contents**

	<b>Page</b>
<b>1 . SUMMARY OF TEST RESULTS</b>	<b>5</b>
1.1 TEST FACILITY	6
1.2 MEASUREMENT UNCERTAINTY	6
<b>2 . GENERAL INFORMATION</b>	<b>7</b>
2.1 GENERAL DESCRIPTION OF EUT	7
2.2 DESCRIPTION OF TEST MODES	9
2.3 BLOCK DIGRAM SHOWING THE CONFIGURATION OF SYSTEM TESTED	10
2.4 DESCRIPTION OF SUPPORT UNITS(CONDUCTED MODE)	11
2.5 EQUIPMENTS LIST FOR ALL TEST ITEMS	12
<b>3 . EMC EMISSION TEST</b>	<b>13</b>
3.1 CONDUCTED EMISSION MEASUREMENT	13
3.1.1 POWER LINE CONDUCTED EMISSION LIMITS	13
3.1.2 TEST PROCEDURE	14
3.1.3 DEVIATION FROM TEST STANDARD	14
3.1.4 TEST SETUP	14
3.1.5 EUT OPERATING CONDITIONS	14
3.1.6 TEST RESULTS	15
3.2 RADIATED EMISSION MEASUREMENT	17
3.2.1 RADIATED EMISSION LIMITS	17
3.2.2 TEST PROCEDURE	18
3.2.3 DEVIATION FROM TEST STANDARD	18
3.2.4 TEST SETUP	19
3.2.5 EUT OPERATING CONDITIONS	20
3.2.6 TEST RESULTS (BETWEEN 9KHZ – 30 MHZ)	21
3.2.7 TEST RESULTS (BETWEEN 30MHZ – 1GHZ)	22
3.2.8 TEST RESULTS (ABOVE 1000 MHZ)	23
<b>4 . POWER SPECTRAL DENSITY TEST</b>	<b>33</b>
4.1 APPLIED PROCEDURES / LIMIT	33
4.1.1 TEST PROCEDURE	33
4.1.2 DEVIATION FROM STANDARD	33
4.1.3 TEST SETUP	33
4.1.4 EUT OPERATION CONDITIONS	33
4.1.5 TEST RESULTS	34
<b>5 . BANDWIDTH TEST</b>	<b>40</b>
5.1 APPLIED PROCEDURES / LIMIT	40
5.1.1 TEST PROCEDURE	40

**Table of Contents**

	<b>Page</b>
5.1.2 DEVIATION FROM STANDARD	40
5.1.3 TEST SETUP	40
5.1.4 EUT OPERATION CONDITIONS	40
5.1.5 TEST RESULTS	41
<b>6 . PEAK OUTPUT POWER TEST</b>	<b>47</b>
6.1 APPLIED PROCEDURES / LIMIT	47
6.1.1 TEST PROCEDURE	47
6.1.2 DEVIATION FROM STANDARD	47
6.1.3 TEST SETUP	47
6.1.4 EUT OPERATION CONDITIONS	47
6.1.5 TEST RESULTS	48
<b>7 . 100 KHZ BANDWIDTH OF FREQUENCY BAND EDGE</b>	<b>49</b>
7.1 DEVIATION FROM STANDARD	49
7.2 TEST SETUP	49
7.3 EUT OPERATION CONDITIONS	49
7.4 TEST RESULTS	50
<b>8 . ANTENNA REQUIREMENT</b>	<b>54</b>
8.1 STANDARD REQUIREMENT	54
8.2 EUT ANTENNA	54
<b>9 . EUT TEST PHOTO</b>	<b>55</b>
<b>APPENDIX-PHOTOGRAPHS OF EUT CONSTRUCTIONAL DETAILS</b>	

### 1. SUMMARY OF TEST RESULTS

Test procedures according to the technical standards:

FCC Part15 (15.247) , Subpart C			
Standard Section	Test Item	Judgment	Remark
15.207	Conducted Emission	PASS	
15.247 (a)(2)	6dB Bandwidth	PASS	
15.247 (b)	Peak Output Power	PASS	
15.247 (c)	Radiated Spurious Emission	PASS	
15.247 (d)	Power Spectral Density	PASS	
15.205	Band Edge Emission	PASS	
15.203	Antenna Requirement	PASS	

**NOTE:**

(1) "N/A" denotes test is not applicable in this Test Report

### 1.1 TEST FACILITY

NTEK Testing Technology Co., Ltd

Add.:1/F, Building E, Fenda Science Park, Sanwei Community, Xixiang Street, Bao'an District, Shenzhen P.R. China.

FCC Registration No.:238937; IC Registration No.:9270A-1

CNAS Registration No.:L5516

### 1.2 MEASUREMENT UNCERTAINTY

The reported uncertainty of measurement  $y \pm U$ , where expanded uncertainty  $U$  is based on a standard uncertainty multiplied by a coverage factor of  $k=2$ , providing a level of confidence of approximately 95 %.

No.	Item	Uncertainty
1	Conducted Emission Test	$\pm 1.38\text{dB}$
2	RF power,conducted	$\pm 0.16\text{dB}$
3	Spurious emissions,conducted	$\pm 0.21\text{dB}$
4	All emissions,radiated(<1G)	$\pm 4.68\text{dB}$
5	All emissions,radiated(>1G)	$\pm 4.89\text{dB}$
6	Temperature	$\pm 0.5^{\circ}\text{C}$
7	Humidity	$\pm 2\%$

## 2. GENERAL INFORMATION

### 2.1 GENERAL DESCRIPTION OF EUT

Equipment	Tablet PC	
Trade Name	Great Wall, Digital2	
Model Name	M71G	
Serial Model	D2-7*** **	
Model Difference	The first, second and third symbol * in type designation can be any alphanumeric character or blank and denote different client or different sales area The fourth and fifth symbol * in type designation can be any alphanumeric character or blank and denote different colour of enclosure	
Product Description	The EUT is a Tablet PC	
	Operation Frequency:	802.11b/g/n:2412~2462 MHz
	Modulation Type:	CCK/OFDM/DBPSK/DAPSK
	Bit Rate of Transmitter	802.11b:11/5.5/2/1 Mbps
		802.11g:54/48/36/24/18/12/9/6Mbps
		802.11n:150/144.44/130/117/115.56/104/86.67/78/52/6.5Mbps
	Number Of Channel	802.11b/g/n:11CH
	Antenna Designation:	Please see Note 3.
	Output Power(Conducted):	802.11b: 12.87 dBm (Max.)
802.11g: 11.90 dBm (Max.)		
802.11n: 10.89 dBm (Max.)		
Antenna Gain (dBi)	1.0dbi	
Based on the application, features, or specification exhibited in User's Manual, the EUT is considered as an ITE/Computing Device. More details of EUT technical specification, please refer to the User's Manual.		
Channel List	Please refer to the Note 2.	
Ratings	DC 3.7V	
Adapter	Model: ASSA2-050200 AC Power Input: 100-240V~, 50/60Hz, Max. 1.0A Output: 5V $\overline{\text{---}}$ , 2A	
Battery	DC 3.7V, 5000mAh	
Connecting I/O Port(s)	Please refer to the User's Manual	

Note:

1. For a more detailed features description, please refer to the manufacturer's specifications or the User's Manual.

2.

Channel List for 802.11b/g/n(20)							
Channel	Frequency (MHz)	Channel	Frequency (MHz)	Channel	Frequency (MHz)	Channel	Frequency (MHz)
01	2412	04	2427	07	2442	10	2457
02	2417	05	2432	08	2447	11	2462
03	2422	06	2437	09	2452		

3.

Table for Filed Antenna

Ant	Brand	Model Name	Antenna Type	Connector	Gain (dBi)	NOTE
A	N/A	N/A	FPCB Antenna	N/A	1.0	Wifi Antenna



## 2.2 DESCRIPTION OF TEST MODES

To investigate the maximum EMI emission characteristics generates from EUT, the test system was pre-scanning tested base on the consideration of following EUT operation mode or test configuration mode which possible have effect on EMI emission level. Each of these EUT operation mode(s) or test configuration mode(s) mentioned above was evaluated respectively.

Pretest Mode	Description
Mode 1	802.11b CH1/ CH6/ CH11
Mode 2	802.11g CH1/ CH6/ CH11
Mode 3	802.11n CH1/ CH6/ CH11
Mode 4	Link Mode

For Conducted Emission	
Final Test Mode	Description
Mode 4	Link Mode

For Radiated Emission	
Final Test Mode	Description
Mode 1	802.11b CH1/ CH6/ CH11
Mode 2	802.11g CH1/ CH6/ CH11
Mode 3	802.11n CH1/ CH6/ CH11

Note:

- (1) The measurements are performed at the highest, middle, lowest available channels.
- (2) The measurements are performed at all Bit Rate of Transmitter, the worst data was reported

### 2.3 BLOCK DIGRAM SHOWING THE CONFIGURATION OF SYSTEM TESTED

Conducted Emission Test

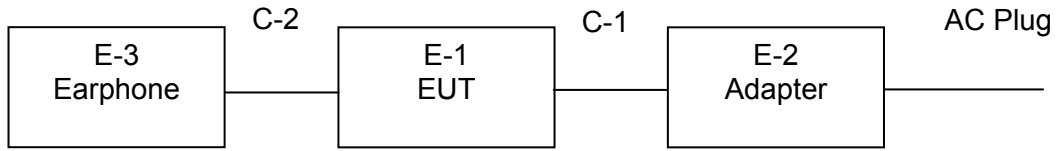

Radiated Spurious Emission Test

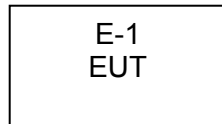

**2.4 DESCRIPTION OF SUPPORT UNITS(CONDUCTED MODE)**

The EUT has been tested as an independent unit together with other necessary accessories or support units. The following support units or accessories were used to form a representative test configuration during the tests.

Item	Equipment	Brand	Model/Type No.	Series No.	Note
E-1	Tablet PC	Great Wall, Digital2	M71G	N/A	EUT
E-2	Adapter	N/A	ASSA2-050200	N/A	
E-3	Earphone	N/A	2688	N/A	

Item	Shielded Type	Ferrite Core	Length	Note
C-1	NO	NO	1.0m	
C-2	NO	NO	0.8m	

Note:

- (1) The support equipment was authorized by Declaration of Confirmation.
- (2) For detachable type I/O cable should be specified the length in cm in 『Length』 column.

## 2.5 EQUIPMENTS LIST FOR ALL TEST ITEMS

### Radiation Test equipment

Item	Kind of Equipment	Manufacturer	Type No.	Serial No.	Last calibration	Calibrated until	Calibration period
1	Spectrum Analyzer	Agilent	E4407B	MY45108040	2012.07.06	2013.07.05	1 year
2	Test Receiver	R&S	ESPI	101318	2013.06.07	2014.06.06	1 year
3	Bilog Antenna	TESEQ	CBL6111D	31216	2012.07.06	2013.07.05	1 year
4	50Ω Coaxial Switch	Anritsu	MP59B	6200264416	2013.06.07	2014.06.06	1 year
5	Spectrum Analyzer	ADVANTEST	R3132	150900201	2013.06.07	2014.06.06	1 year
6	Horn Antenna	EM	EM-AH-10180	2011071402	2012.07.06	2013.07.05	1 year
7	Horn Ant	Schwarzbeck	BBHA 9170	9170-181	2012.07.06	2013.07.05	1 year
8	Amplifier	EM	EM-30180	060538	2012.12.22	2013.12.21	1 year
9	Loop Antenna	ARA	PLA-1030/B	1029	2013.06.08	2014.06.07	1 year
10	Power Meter	R&S	NRVS	100696	2012.07.06	2013.07.05	1 year
11	Power Sensor	R&S	URV5-Z4	0395.1619.05	2012.07.06	2013.07.05	1 year

### Conduction Test equipment

Item	Kind of Equipment	Manufacturer	Type No.	Serial No.	Last calibration	Calibrated until	Calibration period
1	Test Receiver	R&S	ESCI	101160	2013.06.06	2014.06.05	1 year
2	LISN	R&S	ENV216	101313	2012.08.24	2013.08.23	1 year
3	LISN	EMCO	3816/2	00042990	2012.08.24	2013.08.23	1 year
4	50Ω Coaxial Switch	Anritsu	MP59B	6200264417	2013.06.07	2014.06.06	1 year
5	Passive Voltage Probe	R&S	ESH2-Z3	100196	2013.06.07	2014.06.06	1 year
6	Absorbing clamp	R&S	MOS-21	100423	2013.06.08	2014.06.07	1 year

### 3. EMC EMISSION TEST

#### 3.1 CONDUCTED EMISSION MEASUREMENT

##### 3.1.1 POWER LINE CONDUCTED EMISSION Limits (Frequency Range 150KHz-30MHz)

FREQUENCY (MHz)	Class A (dBuV)		Class B (dBuV)		Standard
	Quasi-peak	Average	Quasi-peak	Average	
0.15 -0.5	79.00	66.00	66 - 56 *	56 - 46 *	CISPR
0.50 -5.0	73.00	60.00	56.00	46.00	CISPR
5.0 -30.0	73.00	60.00	60.00	50.00	CISPR

0.15 -0.5	79.00	66.00	66 - 56 *	56 - 46 *	FCC
0.50 -5.0	73.00	60.00	56.00	46.00	FCC
5.0 -30.0	73.00	60.00	60.00	50.00	FCC

Note:

- (1) The tighter limit applies at the band edges.
- (2) The limit of " \* " marked band means the limitation decreases linearly with the logarithm of the frequency in the range.

The following table is the setting of the receiver

Receiver Parameters	Setting
Attenuation	10 dB
Start Frequency	0.15 MHz
Stop Frequency	30 MHz
IF Bandwidth	9 kHz

**3.1.2 TEST PROCEDURE**

- a. The EUT was placed 0.8 meters from the horizontal ground plane with EUT being connected to the power mains through a line impedance stabilization network (LISN). All other support equipments powered from additional LISN(s). The LISN provide 50 Ohm/ 50uH of coupling impedance for the measuring instrument.
- b. Interconnecting cables that hang closer than 40 cm to the ground plane shall be folded back and forth in the center forming a bundle 30 to 40 cm long.
- c. I/O cables that are not connected to a peripheral shall be bundled in the center. The end of the cable may be terminated, if required, using the correct terminating impedance. The overall length shall not exceed 1 m.
- d. LISN at least 80 cm from nearest part of EUT chassis.
- e. For the actual test configuration, please refer to the related Item –EUT Test Photos.

**3.1.3 DEVIATION FROM TEST STANDARD**

No deviation

**3.1.4 TEST SETUP**

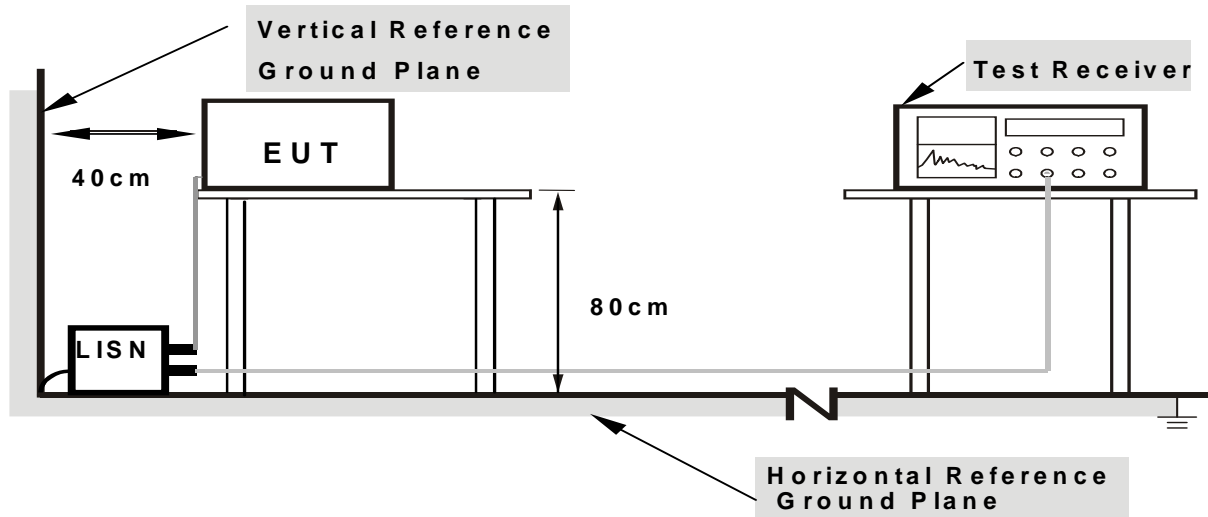

- Note:**
- 1. Support units were connected to second LISN.
  - 2. Both of LISNs (AMN) are 80 cm from EUT and at least 80 from other units and other metal planes

**3.1.5 EUT OPERATING CONDITIONS**

The EUT was configured for testing in a typical fashion (as a customer would normally use it). The EUT has been programmed to continuously transmit during test. This operating condition was tested and used to collect the included data.

### 3.1.6 TEST RESULTS

EUT :	Tablet PC	Model Name. :	M71G
Temperature :	26 °C	Relative Humidity :	54%
Pressure :	1010hPa	Phase :	L
Test Voltage :	DC 5.0V from adapter AC 120V/60Hz	Test Mode :	Mode 1

Frequency (MHz)	Meter Reading (dBμV)	Factor (dB)	Emission Level (dBμV)	Limits (dBμV)	Margin (dB)	Detector Type
0.1539	35.59	11.43	47.02	65.78	-18.76	QP
0.1539	17.53	11.43	28.96	55.78	-26.82	AVG
0.2059	29.22	10.69	39.91	63.37	-23.46	QP
0.2059	7.91	10.69	18.60	53.37	-34.77	AVG
0.4500	27.65	10.64	38.29	56.87	-18.58	QP
0.4500	14.62	10.64	25.26	46.87	-21.61	AVG
1.2019	26.16	10.52	36.68	56.00	-19.32	QP
1.2019	15.04	10.52	25.56	46.00	-20.44	AVG
2.1179	25.79	10.52	36.31	56.00	-19.69	QP
2.1179	12.29	10.52	22.81	46.00	-23.19	AVG
13.1418	27.15	10.89	38.04	60.00	-21.96	QP
13.1418	16.31	10.89	27.20	50.00	-22.80	AVG

**Remark:**

1. All readings are Quasi-Peak and Average values.
2. Factor = Insertion Loss + Cable Loss.

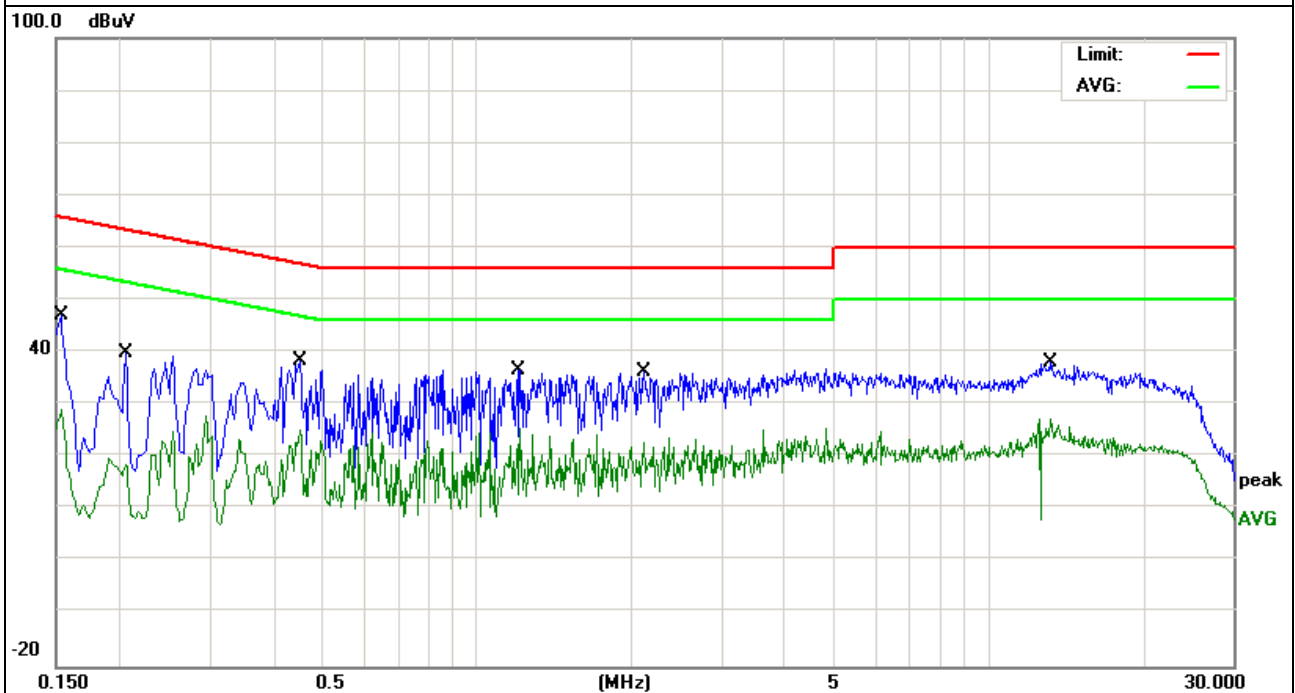

EUT :	Tablet PC	Model Name. :	M71G
Temperature :	26 °C	Relative Humidity :	54%
Pressure :	1010hPa	Phase :	N
Test Voltage :	DC 5.0V from adapter AC 120V/60Hz	Test Mode :	Mode 1

Frequency (MHz)	Meter Reading (dBμV)	Factor (dB)	Emission Level (dBμV)	Limits (dBμV)	Margin (dB)	Detector Type
0.1539	35.59	11.43	47.02	65.78	-18.76	QP
0.1539	17.53	11.43	28.96	55.78	-26.82	AVG
0.2058	29.22	10.69	39.91	63.37	-23.46	QP
0.2058	7.91	10.69	18.60	53.37	-34.77	AVG
0.4500	27.65	10.64	38.29	56.87	-18.58	QP
0.4500	14.62	10.64	25.26	46.87	-21.61	AVG
1.2018	26.16	10.52	36.68	56.00	-19.32	QP
1.2018	15.04	10.52	25.56	46.00	-20.44	AVG
2.6299	25.40	10.54	35.94	56.00	-20.06	QP
2.6699	12.95	10.54	23.49	46.00	-22.51	AVG
13.1417	27.15	10.89	38.04	60.00	-21.96	QP
13.1417	16.31	10.89	27.20	50.00	-22.80	AVG

Remark:

1. All readings are Quasi-Peak and Average values.
2. Factor = Insertion Loss + Cable Loss.

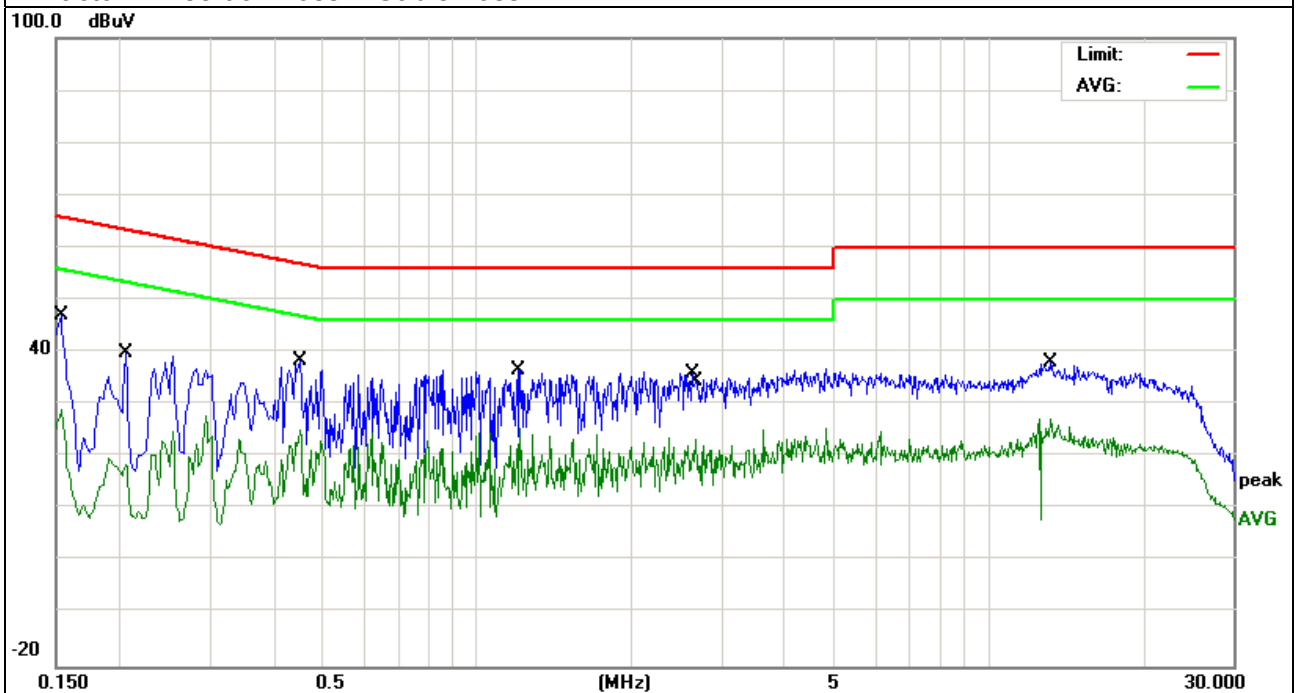



### 3.2 RADIATED EMISSION MEASUREMENT

#### 3.2.1 RADIATED EMISSION LIMITS (Frequency Range 9kHz-1000MHz)

20dBc in any 100 kHz bandwidth outside the operating frequency band. In case the emission fall within the restricted band specified on 15.205(a), then the 15.209(a) limit in the table below has to be followed.

Frequencies (MHz)	Field Strength (micorvolts/meter)	Measurement Distance (meters)
0.009~0.490	2400/F(KHz)	300
0.490~1.705	24000/F(KHz)	30
1.705~30.0	30	30
30~88	100	3
88~216	150	3
216~960	200	3
Above 960	500	3

#### LIMITS OF RADIATED EMISSION MEASUREMENT (Above 1000MHz)

FREQUENCY (MHz)	Class A (dBuV/m) (at 3M)		Class B (dBuV/m) (at 3M)	
	PEAK	AVERAGE	PEAK	AVERAGE
Above 1000	80	60	74	54

Notes:

- (1) The limit for radiated test was performed according to FCC PART 15C.
- (2) The tighter limit applies at the band edges.
- (3) Emission level (dBuV/m)=20log Emission level (uV/m).

Spectrum Parameter	Setting
Attenuation	Auto
Start Frequency	1000 MHz
Stop Frequency	10th carrier harmonic
RB / VB (emission in restricted band)	1 MHz / 1 MHz for Peak, 1 MHz / 10Hz for Average

Receiver Parameter	Setting
Attenuation	Auto
Start ~ Stop Frequency	9kHz~150kHz / RB 200Hz for QP
Start ~ Stop Frequency	150kHz~30MHz / RB 9kHz for QP
Start ~ Stop Frequency	30MHz~1000MHz / RB 120kHz for QP

### 3.2.2 TEST PROCEDURE

- a. The measuring distance of at 3 m shall be used for measurements at frequency up to 1GHz. For frequencies above 1GHz, any suitable measuring distance may be used.
- b. The EUT was placed on the top of a rotating table 0.8 meters above the ground at a 3 meter open area test site. The table was rotated 360 degrees to determine the position of the highest radiation.
- c. The height of the equipment or of the substitution antenna shall be 0.8 m; the height of the test antenna shall vary between 1 m to 4 m. Both horizontal and vertical polarizations of the antenna are set to make the measurement.
- d. The initial step in collecting conducted emission data is a spectrum analyzer peak detector mode pre-scanning the measurement frequency range. Significant peaks are then marked and then Quasi Peak detector mode re-measured.
- e. If the Peak Mode measured value compliance with and lower than Quasi Peak Mode Limit, the EUT shall be deemed to meet QP Limits and then no additional QP Mode measurement performed.
- f. For the actual test configuration, please refer to the related Item –EUT Test Photos.

Note:

Both horizontal and vertical antenna polarities were tested and performed pretest to three orthogonal axis. The worst case emissions were reported

### 3.2.3 DEVIATION FROM TEST STANDARD

No deviation

**3.2.4 TEST SETUP**

(A) Radiated Emission Test-Up Frequency Below 30MHz

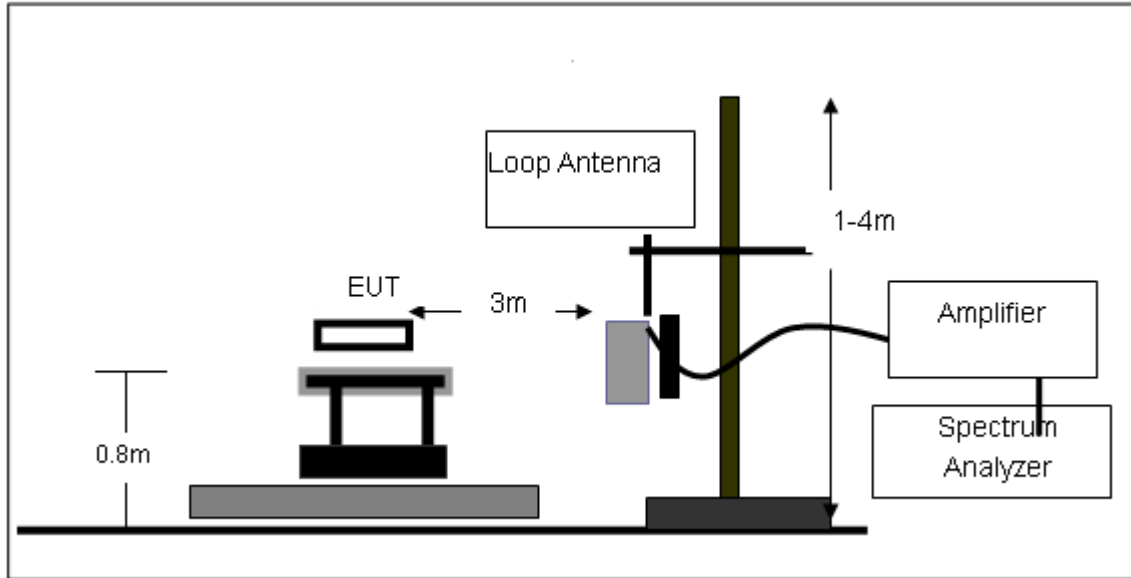

(B) Radiated Emission Test-Up Frequency 30MHz~1GHz

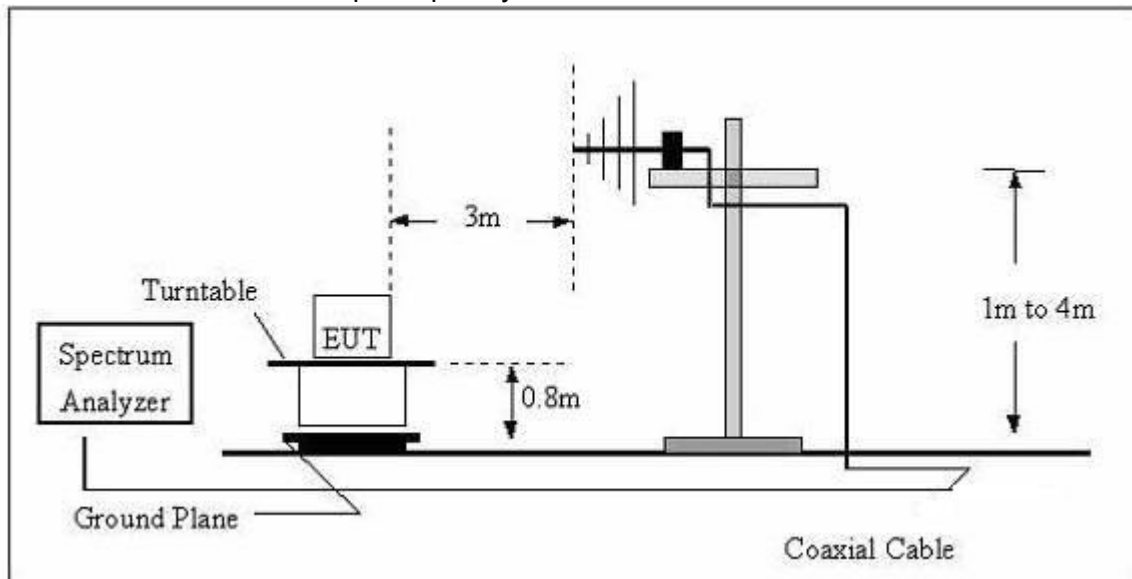

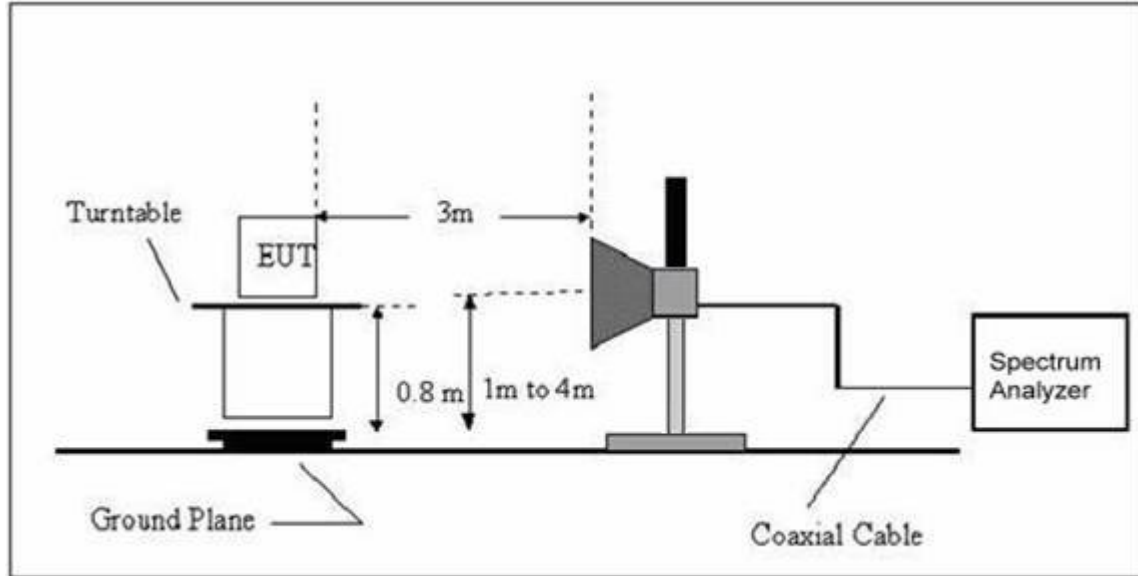
**(C) Radiated Emission Test-Up Frequency Above 1GHz****3.2.5 EUT OPERATING CONDITIONS**

The EUT tested system was configured as the statements of 2.4 Unless otherwise a special operating condition is specified in the follows during the testing.

**3.2.6 TEST RESULTS (BETWEEN 9KHZ – 30 MHZ)**

EUT:	Tablet PC	Model Name. :	M71G
Temperature:	20 °C	Relative Humidity:	48%
Pressure:	1010 hPa	Test Voltage :	DC 5.0V from adapter AC 120V/60Hz
Test Mode :	TX	Polarization :	--

Freq.	Reading	Limit	Margin	State
(MHz)	(dBuV/m)	(dBuV/m)	(dB)	P/F
--	--	--	--	PASS
--	--	--	--	PASS

**NOTE:**

The amplitude of spurious emissions which are attenuated by more than 20dB below the permissible value has no need to be reported.

Distance extrapolation factor =  $40 \log (\text{specific distance}/\text{test distance})(\text{dB})$ ;

Limit line = specific limits(dBuv) + distance extrapolation factor.

**3.2.7 TEST RESULTS (BETWEEN 30MHZ – 1GHZ)**

EUT :	Tablet PC	Model Name :	M71G
Temperature :	20 °C	Relative Humidity :	48%
Pressure:	1010 hPa	Test Voltage :	DC 5.0V from adapter
Test Mode :	TX		

Polar (H/V)	Frequency	Meter Reading	Factor	Emission Level	Limits	Margin	Detector Type
	(MHz)	(dBuV)	(dB)	(dBuV/m)	(dBuV/m)	(dB)	
V	119.4360	17.21	12.08	29.29	43.50	-14.21	QP
V	128.1129	17.17	12.20	29.37	43.50	-14.13	QP
V	170.7926	21.57	10.35	31.92	43.50	-11.58	QP
V	341.9786	13.35	16.19	29.54	46.00	-16.46	QP
V	468.8761	18.47	19.69	38.16	46.00	-7.84	QP
V	935.5462	10.35	29.42	39.77	46.00	-6.23	QP
H	170.7923	28.59	10.35	38.94	43.50	-4.56	QP
H	341.9786	26.15	16.19	42.34	46.00	-3.66	QP
H	468.8761	22.10	19.69	41.79	46.00	-4.21	QP
H	726.8052	15.78	26.00	41.78	46.00	-4.22	QP
H	813.1114	17.32	26.35	43.67	46.00	-2.33	QP
H	854.0247	13.49	27.51	41.00	46.00	-5.00	QP

**Remark:**

Absolute Level= ReadingLevel+ Factor, Margin= Absolute Level- Limit

### 3.2.8 TEST RESULTS (ABOVE 1000 MHZ)

#### 802.11b

Normal Voltage

Polar (H/V)	Frequency	Meter Reading	Factor	Emission Level	Limits	Margin	Detector Type
	(MHz)	(dBuV)	(dB)	(dBuV/m)	(dBuV/m)	(dB)	
<b>Mid Channel (2412 MHz)</b>							
Vertical	2491.777	59.40	-11.65	47.75	74	-26.25	Pk
Horizontal	2498.247	56.30	-12.73	43.57	74	-30.43	Pk
Vertical	4821.884	56.40	-3.60	52.8	74	-21.2	Pk
Horizontal	4821.749	56.40	-9.23	44.54	74	-29.46	Pk
Vertical	1485.838	60.10	-17.10	43.00	74	-31.00	Pk
Vertical	1636.784	59.79	-16.06	43.73	74	-30.27	Pk
Vertical	2095.928	58.60	-11.88	46.72	74	-27.28	Pk
Horizontal	1074.301	60.33	-19.69	40.64	74	-33.36	Pk
Horizontal	1483.178	59.32	-17.09	42.23	74	-31.77	Pk
Horizontal	1895.832	56.34	-14.25	42.09	74	-31.91	Pk
<b>Mid Channel (2437 MHz)</b>							
Vertical	2474.777	56.14	-11.65	44.49	74	-29.51	Pk
Horizontal	2474.144	56.83	-9.37	47.46	74	-26.54	Pk
Vertical	4818.425	56.21	-6.15	47.47	74	-26.53	Pk
Horizontal	4818.979	56.21	-6.83	49.38	74	-24.62	Pk
Vertical	1433.535	63.20	-17.12	46.08	74	-27.92	Pk
Vertical	1636.784	60.53	-16.06	44.47	74	-29.53	Pk
Vertical	2284.166	54.27	-12.83	41.44	74	-32.56	Pk
Horizontal	1280.515	59.93	-17.82	42.11	74	-31.89	Pk
Horizontal	1636.784	58.76	-16.06	42.7	74	-31.3	Pk
Horizontal	1892.438	58.88	-14.28	44.6	74	-29.4	Pk
<b>High Channel (2462 MHz)</b>							
Vertical	2453.883	56.89	-12.91	43.98	74	-30.02	Pk
Horizontal	2453.839	56.89	-11.59	44.65	74	-29.35	Pk
Vertical	4926.325	53.40	-9.22	44.18	74	-29.82	Pk
Horizontal	4926.683	53.40	-3.64	49.62	74	-24.38	Pk
Vertical	1187.688	57.92	-18.27	39.65	74	-34.35	Pk
Vertical	1636.784	56.73	-16.06	40.67	74	-33.33	Pk
Vertical	2084.693	54.32	-11.99	42.33	74	-31.67	Pk
Horizontal	1534.540	56.98	-16.94	40.04	74	-33.96	Pk
Horizontal	1786.985	56.69	-15.04	41.65	74	-32.35	Pk
Horizontal	1892.438	56.57	-14.28	42.29	74	-31.71	Pk

Note: "802.11b" mode is the worst mode.

Conducted Spurious Emissions at Antenna Port:  
802.11b Low Channel

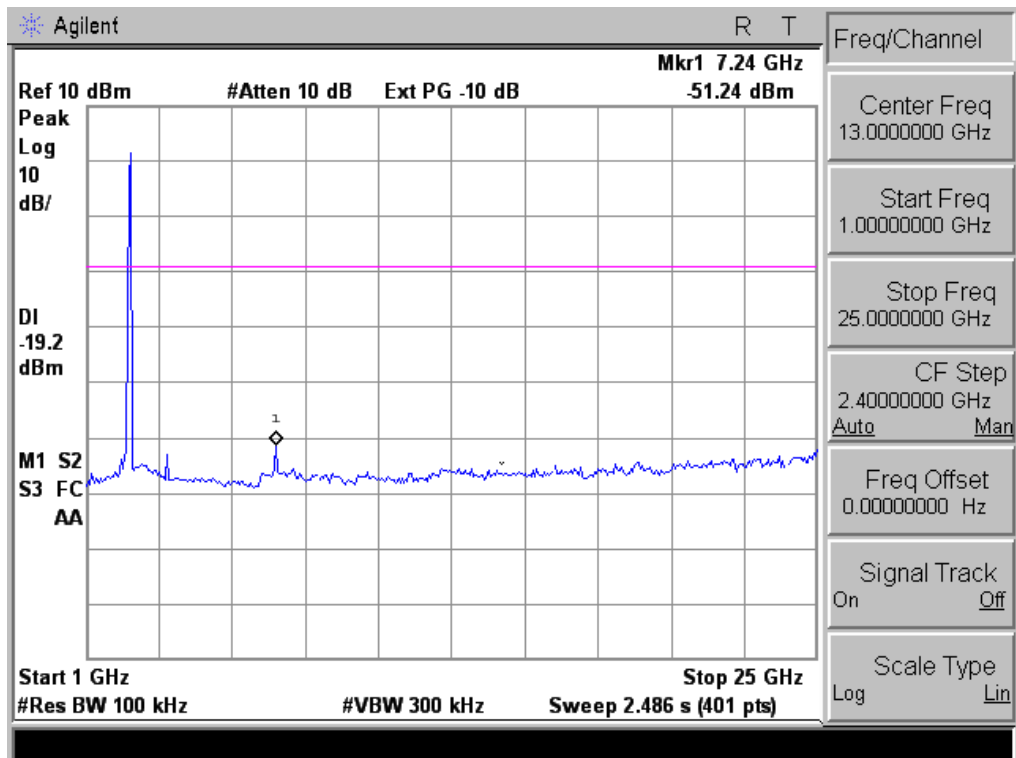
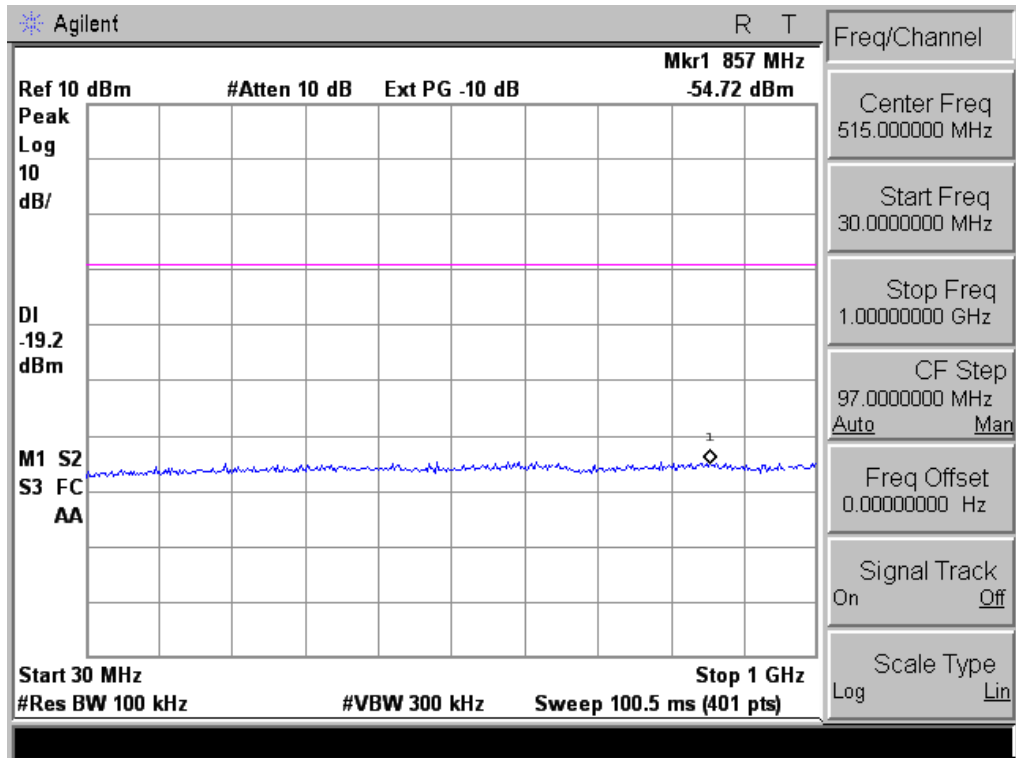



802.11b Middle Channel

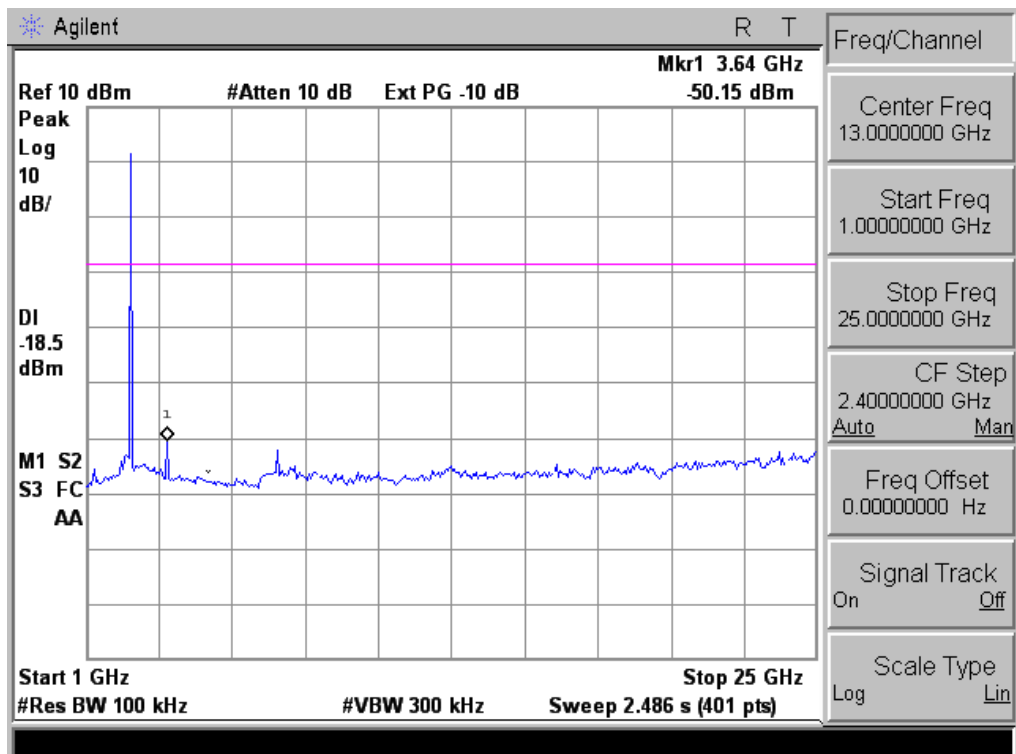
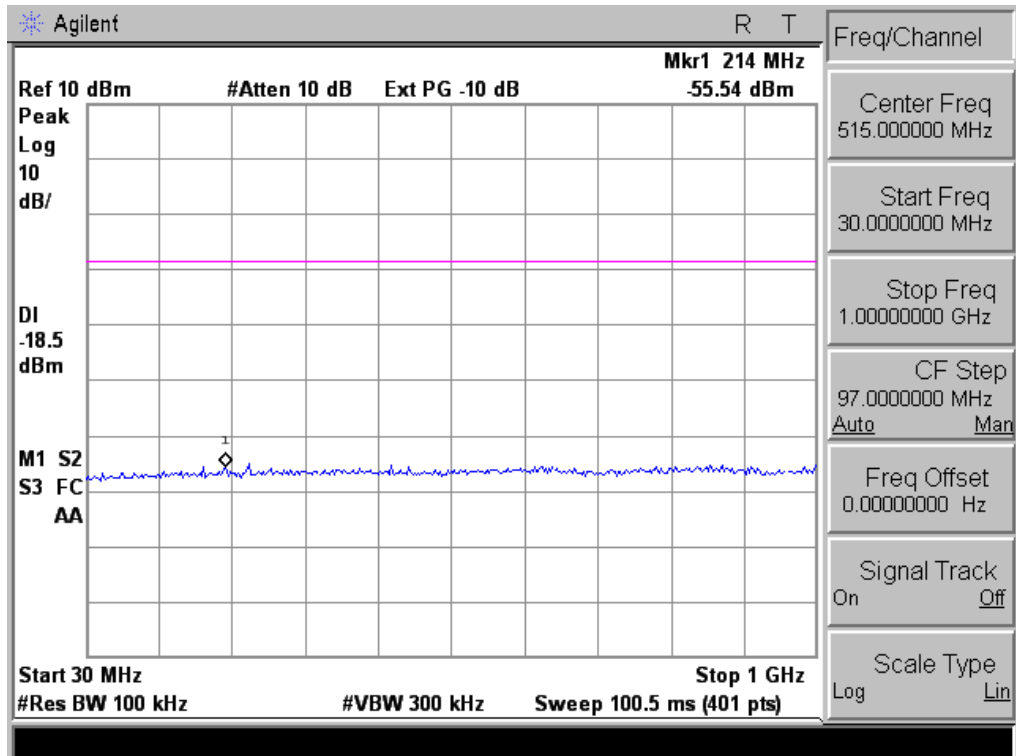

### 802.11b High Channel

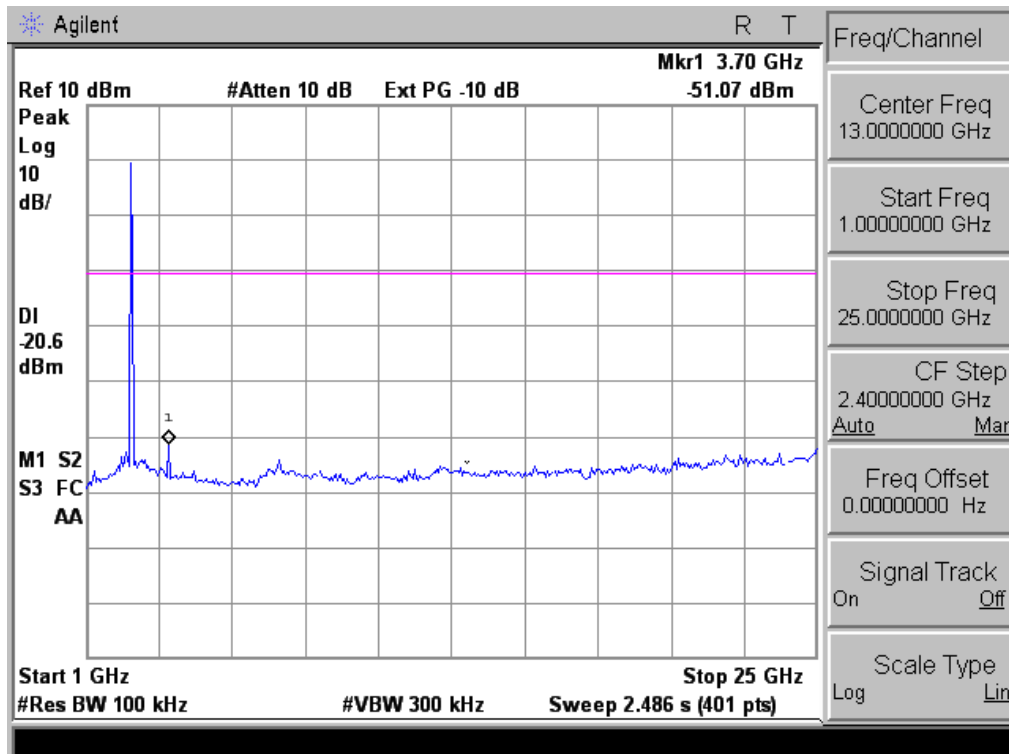
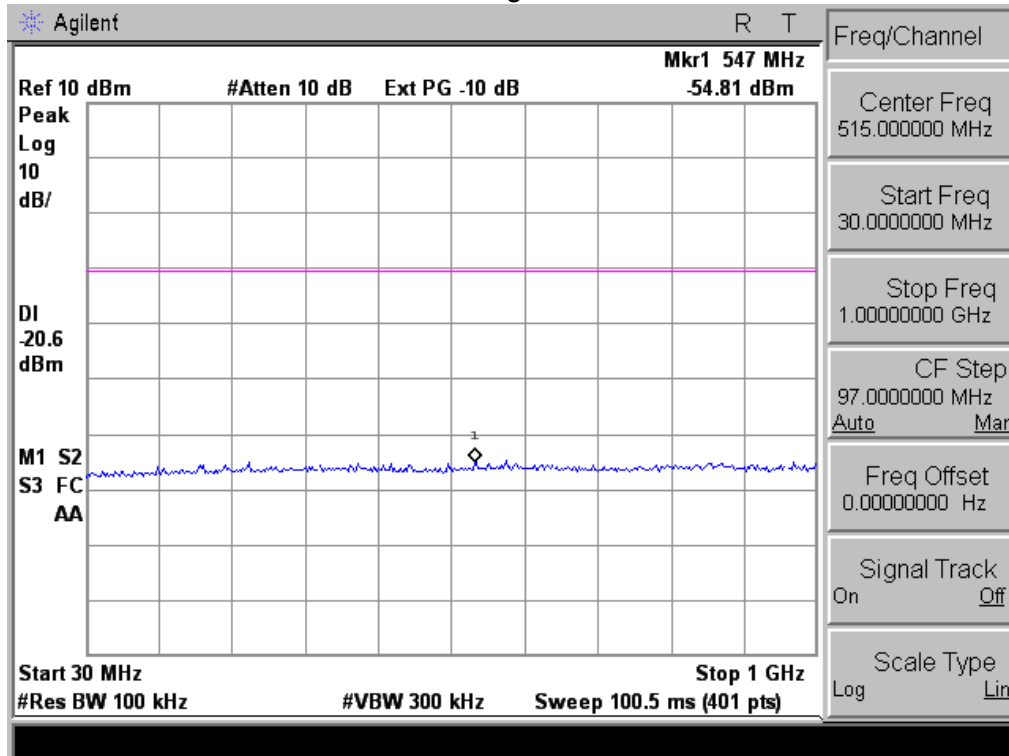

### 802.11g Low Channel

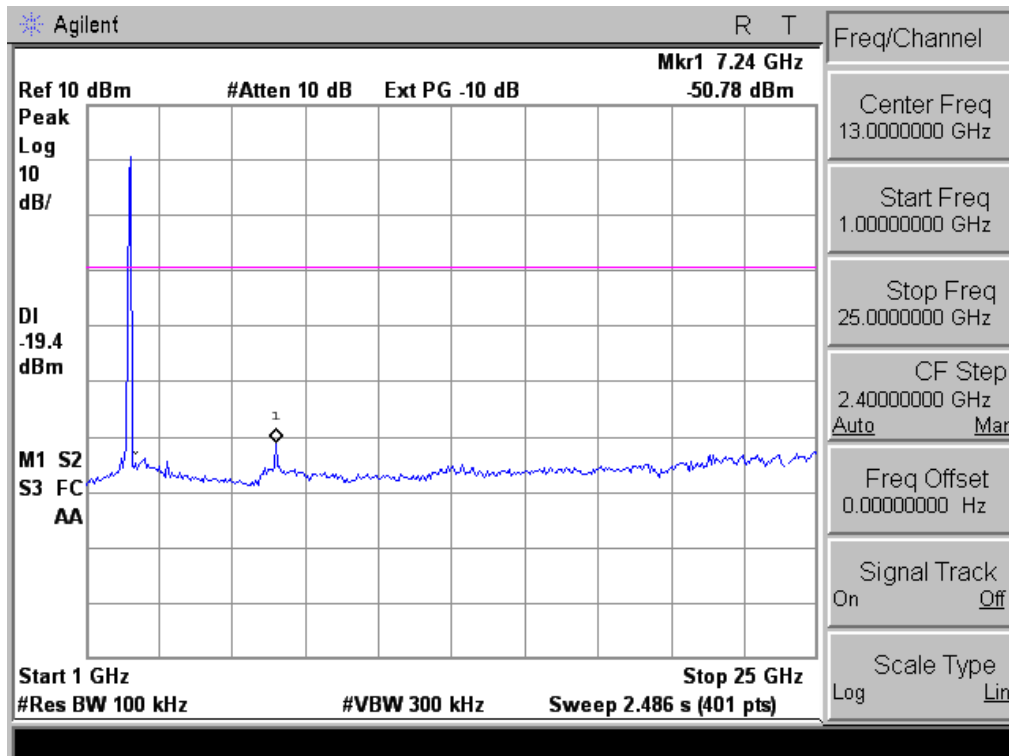
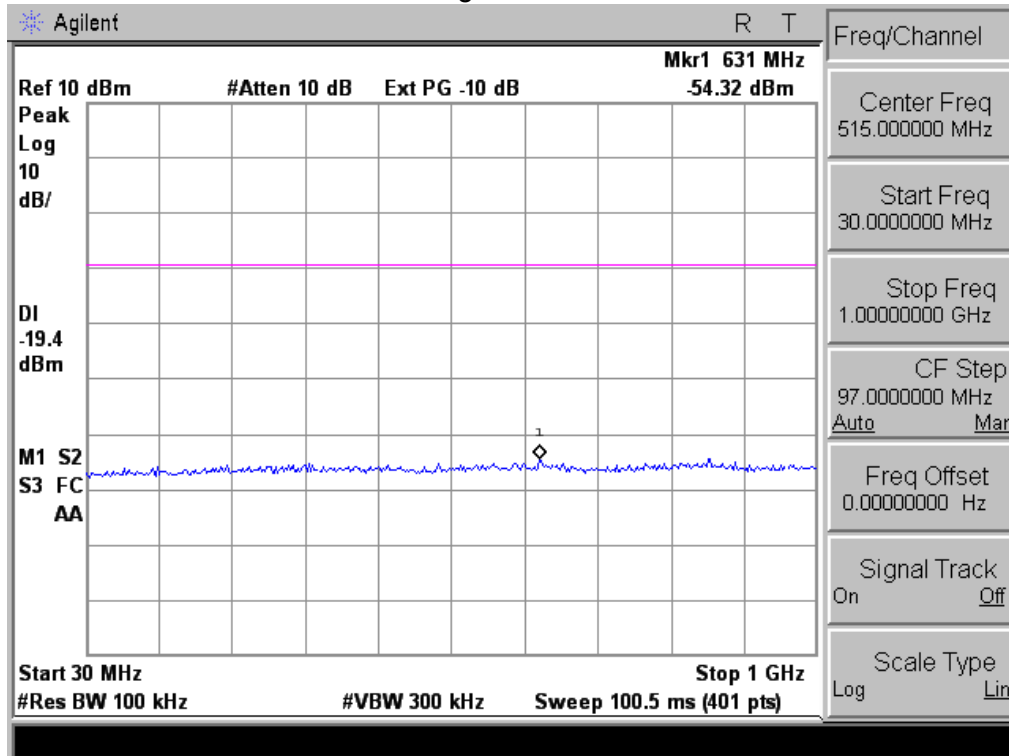

### 802.11g Middle Channel

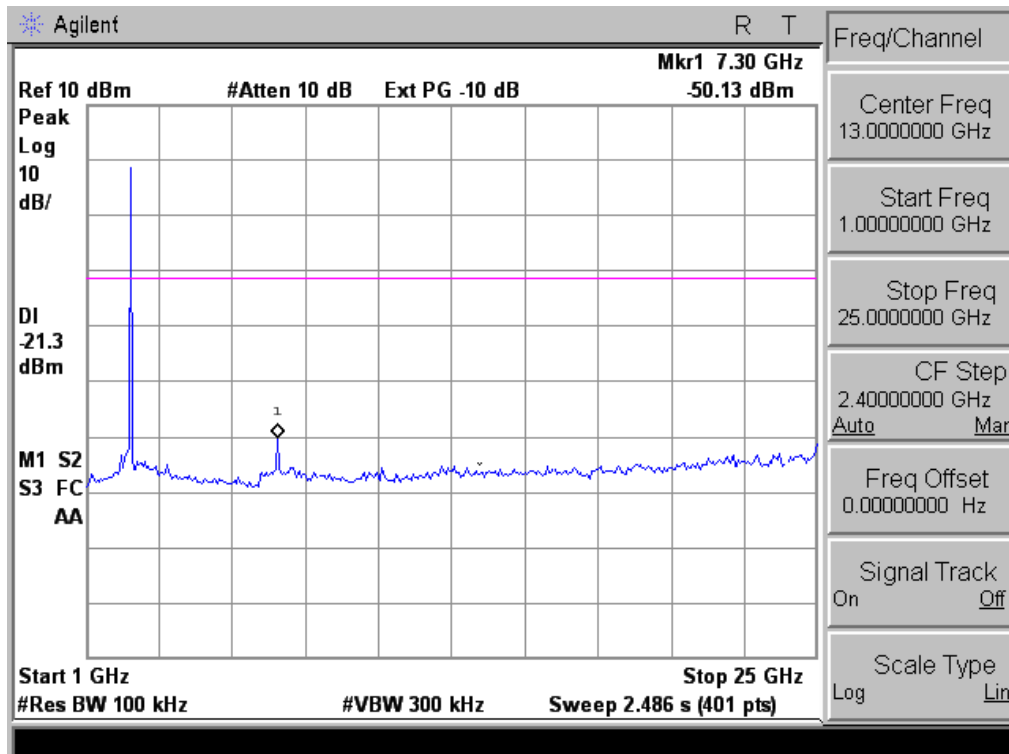
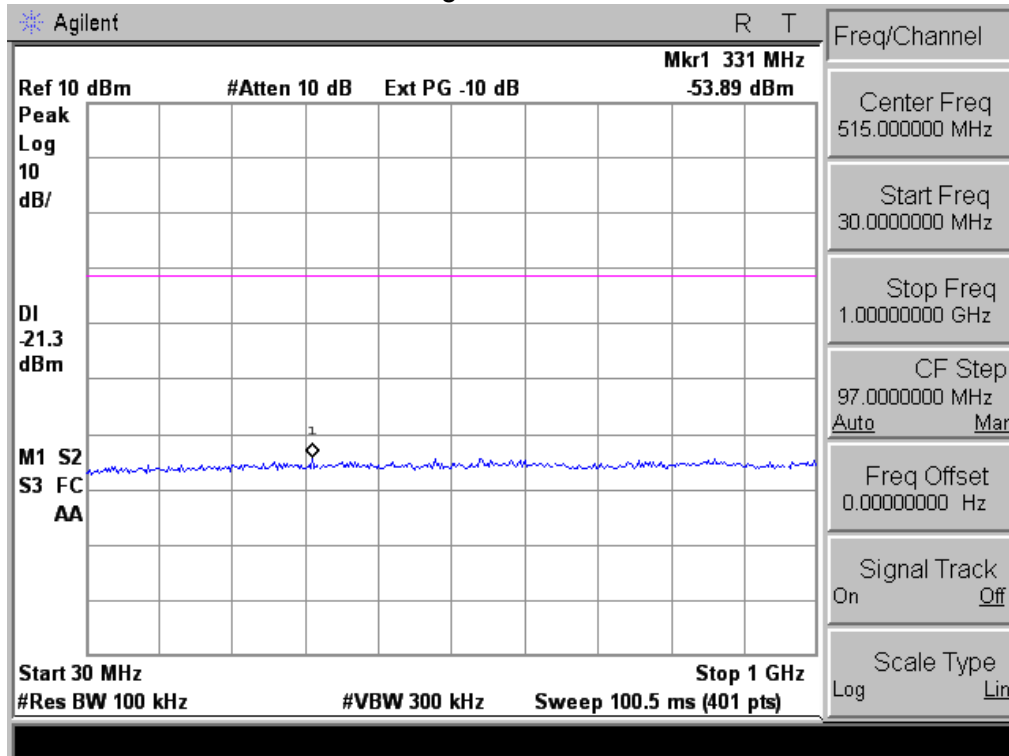

### 802.11g High Channel

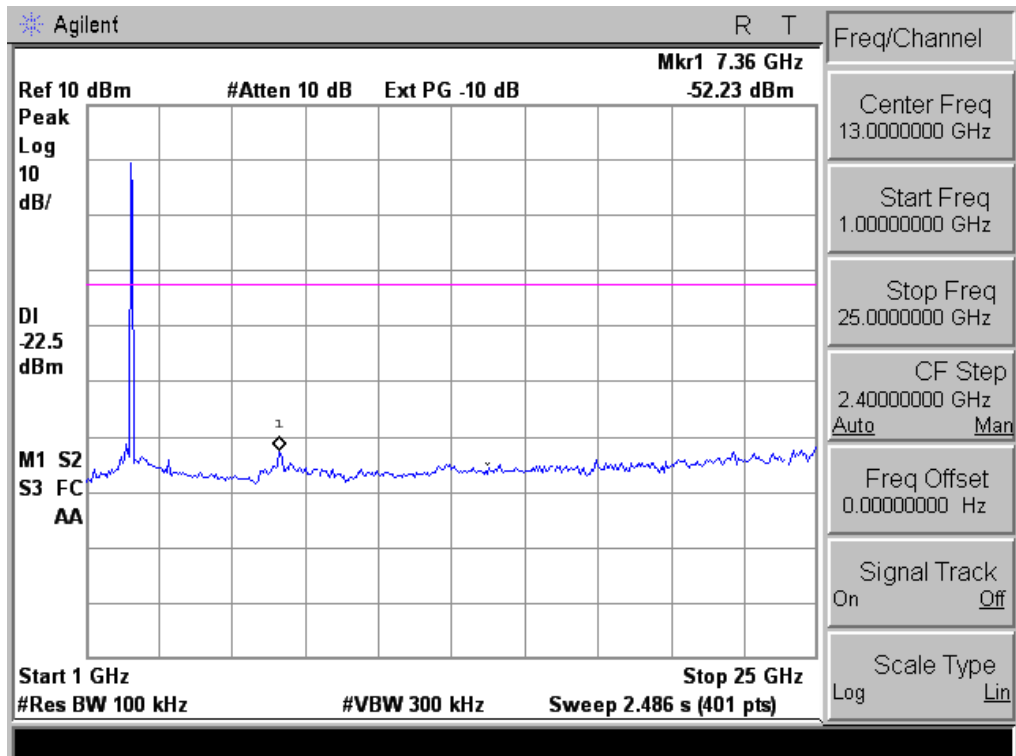
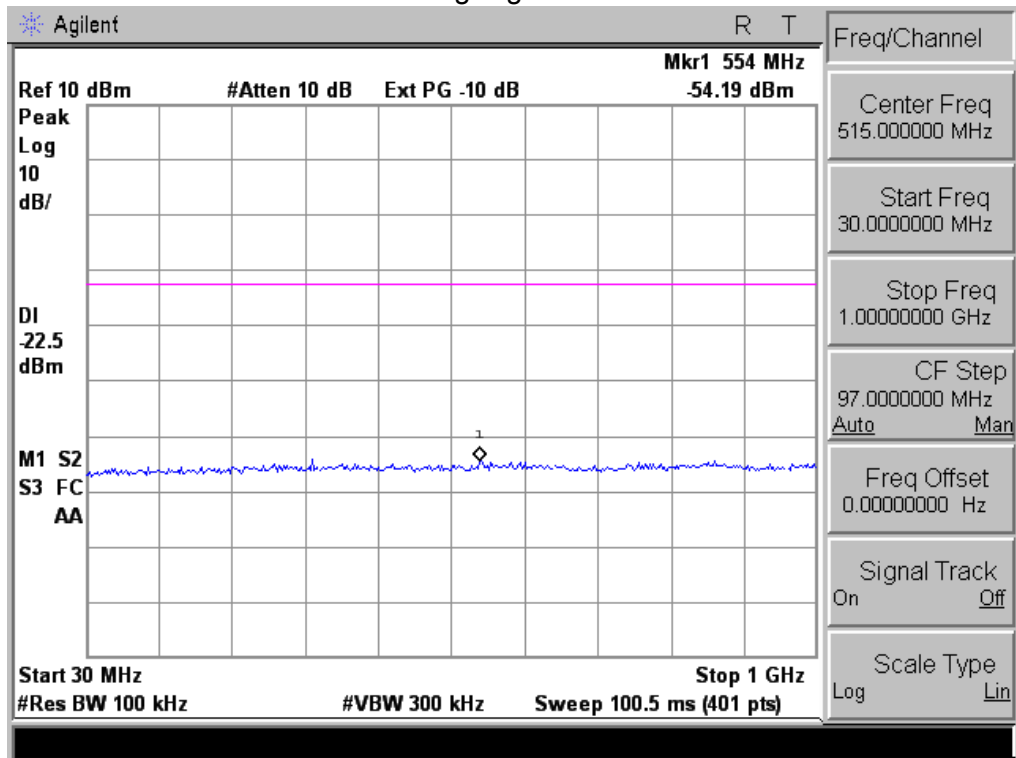

802.11n Low Channel

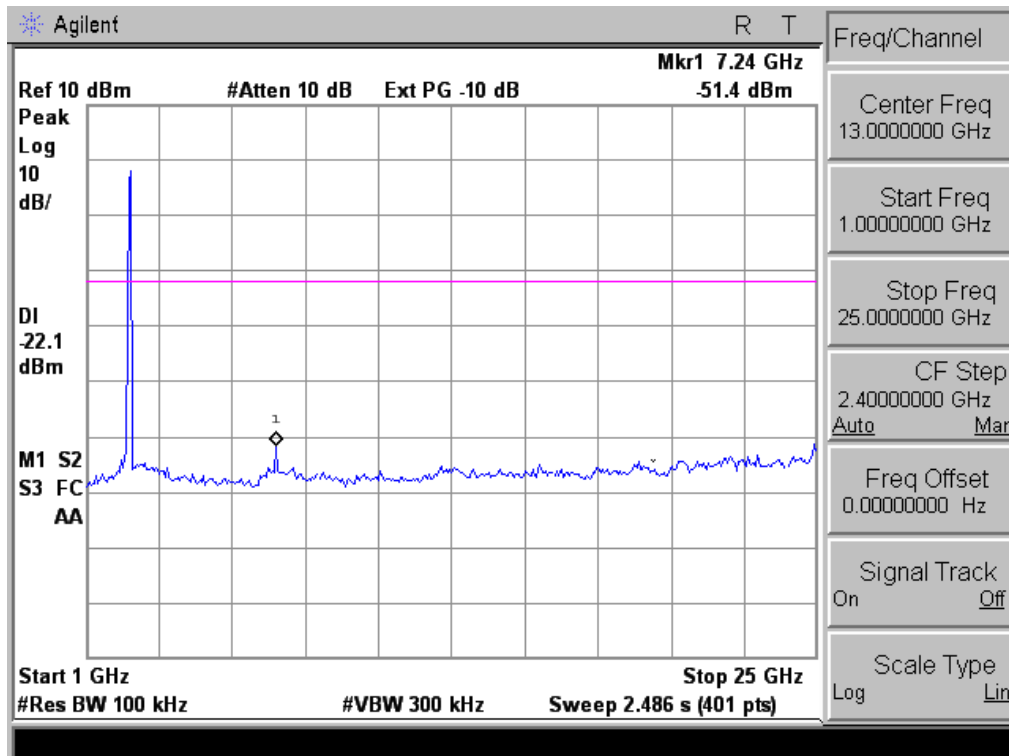
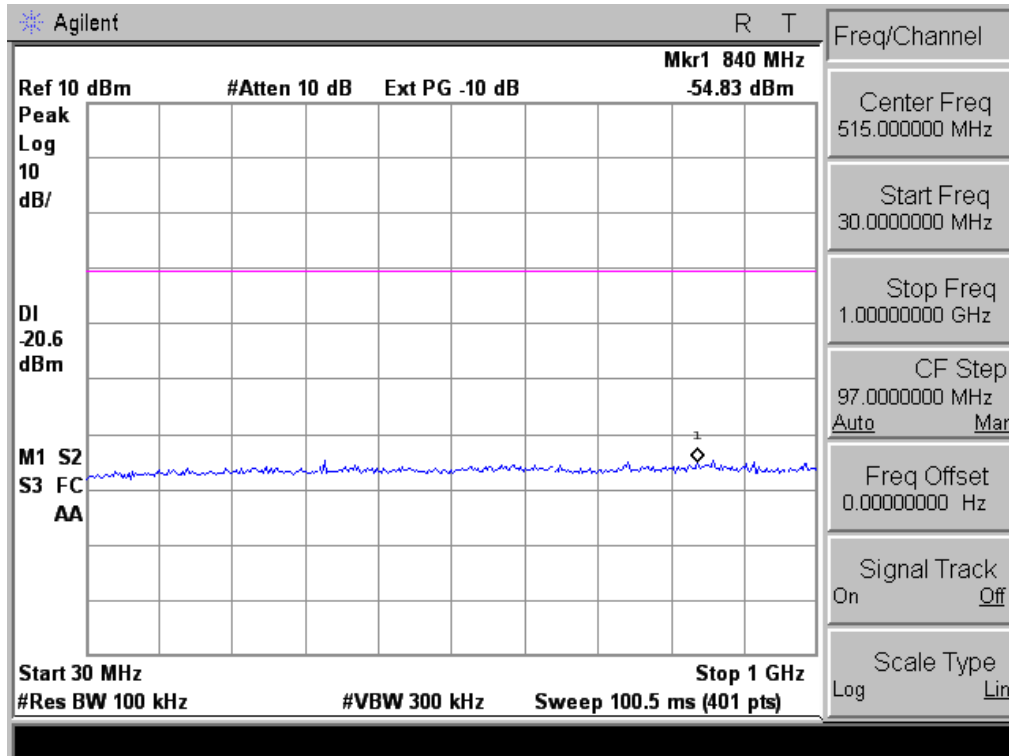

802.11n Middle Channel

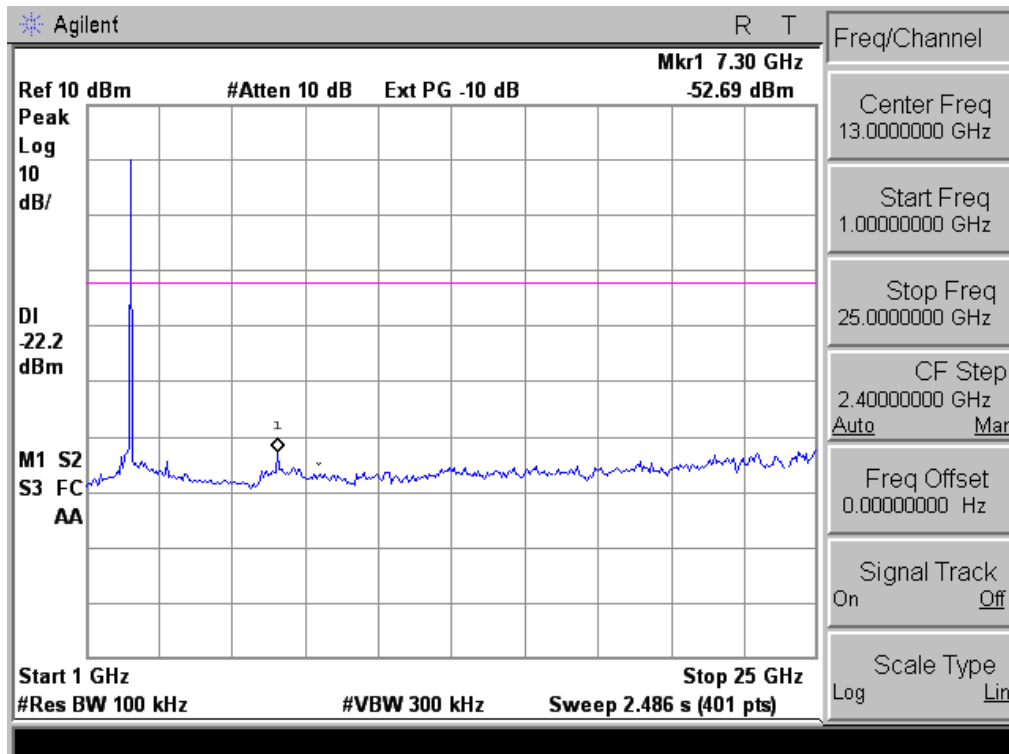
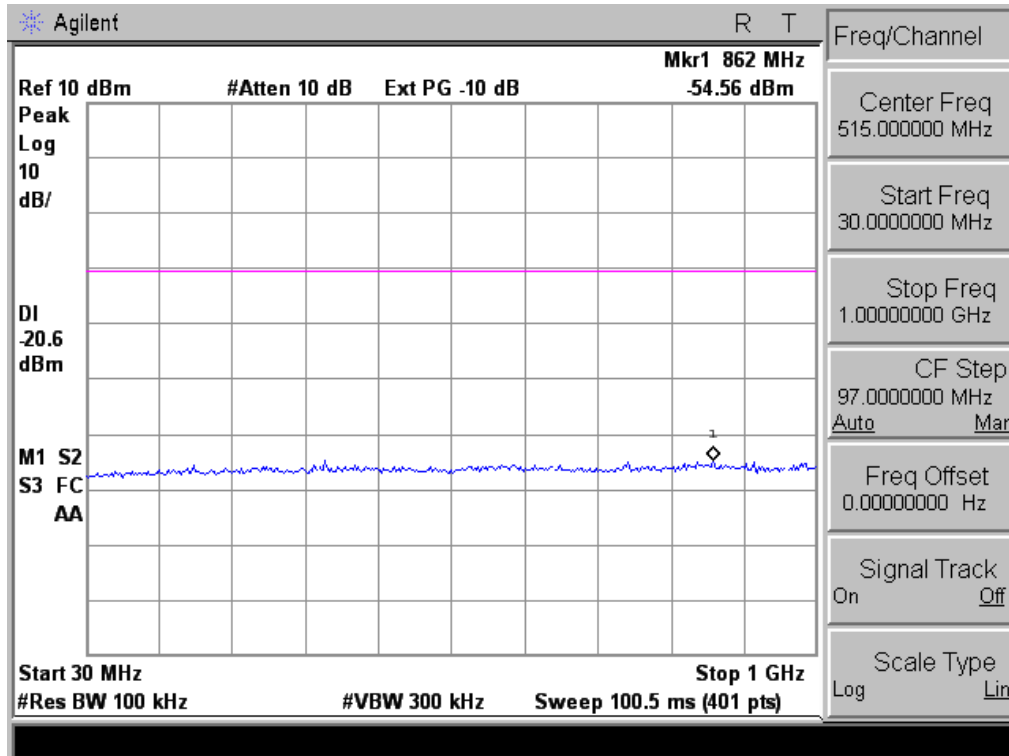

### 802.11n High Channel

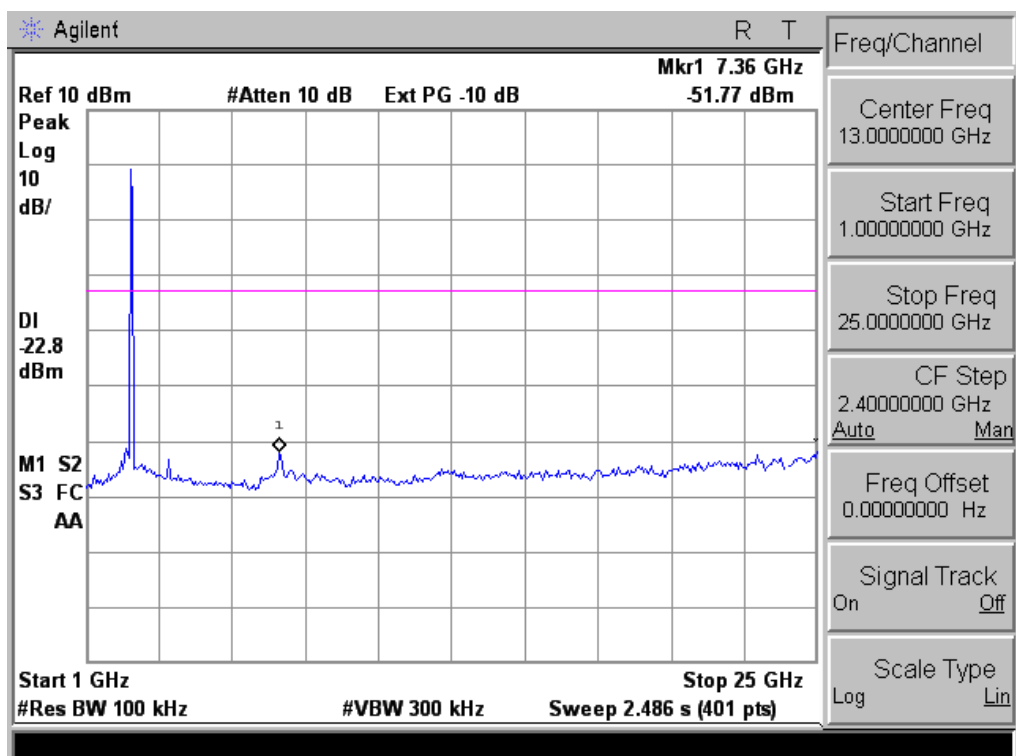
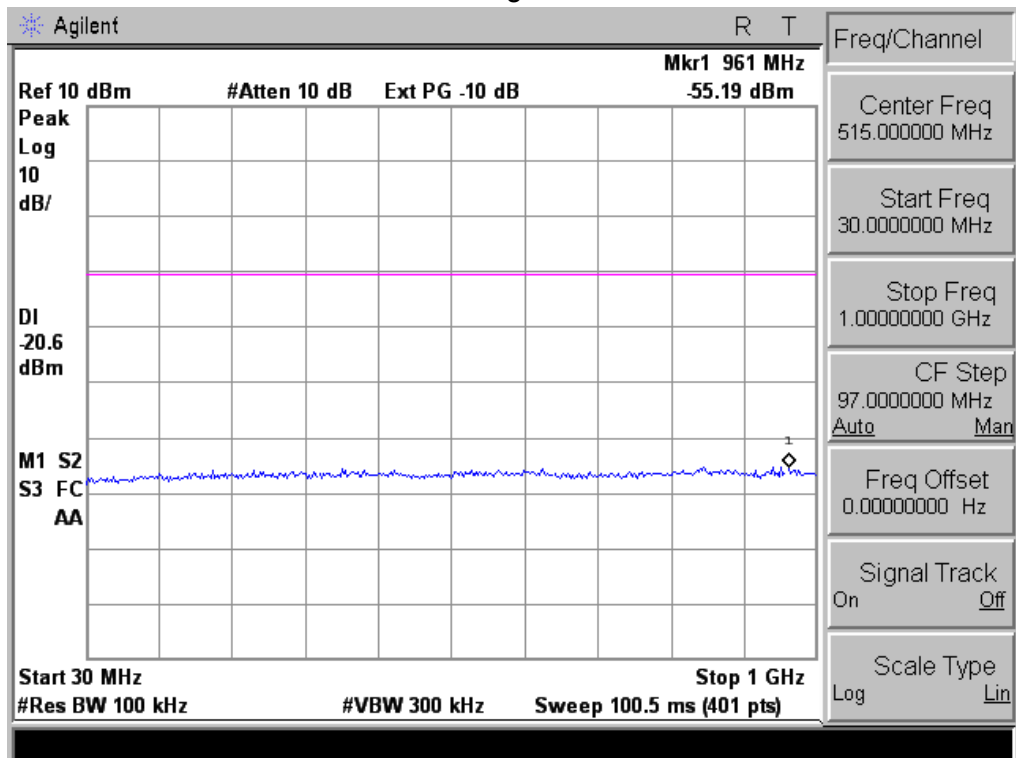



#### 4. POWER SPECTRAL DENSITY TEST

##### 4.1 APPLIED PROCEDURES / LIMIT

FCC Part15 (15.247) , Subpart C				
Section	Test Item	Limit	Frequency Range (MHz)	Result
15.247	Power Spectral Density	8 dBm (in any 3KHz)	2400-2483.5	PASS

##### 4.1.1 TEST PROCEDURE

1. Set analyzer center frequency to DTS channel center frequency.
2. Set the span to 1.5 times the DTS channel bandwidth.
3. Set the RBW  $\geq$  3 kHz.
4. Set the VBW  $\geq$  3 x RBW.
5. Detector = peak.
6. Sweep time = auto couple.
7. Trace mode = max hold.
8. Allow trace to fully stabilize.
9. Use the peak marker function to determine the maximum amplitude level.
10. If measured value exceeds limit, reduce RBW (no less than 3 kHz) and repeat.

##### 4.1.2 DEVIATION FROM STANDARD

No deviation.

##### 4.1.3 TEST SETUP

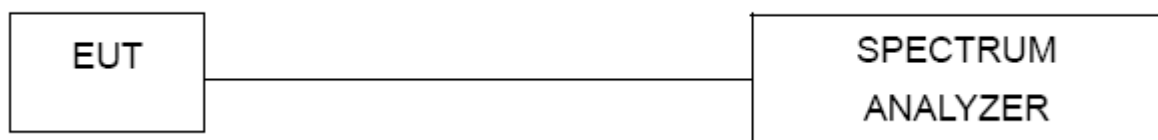

##### 4.1.4 EUT OPERATION CONDITIONS

The EUT tested system was configured as the statements of 2.1 Unless otherwise a special operating condition is specified in the follows during the testing.

### 4.1.5 TEST RESULTS

EUT :	Tablet PC	Model Name :	M71G
Temperature :	25 °C	Relative Humidity :	60%
Pressure :	1015 hPa	Test Voltage :	DC 5.0V from adapter
Test Mode :	TX b Mode /CH01, CH06, CH11		

Frequency	Power Density (dBm)	Limit (dBm)	Result
2412 MHz	-11.26	8	PASS
2437 MHz	-11.68	8	PASS
2462 MHz	-12.19	8	PASS

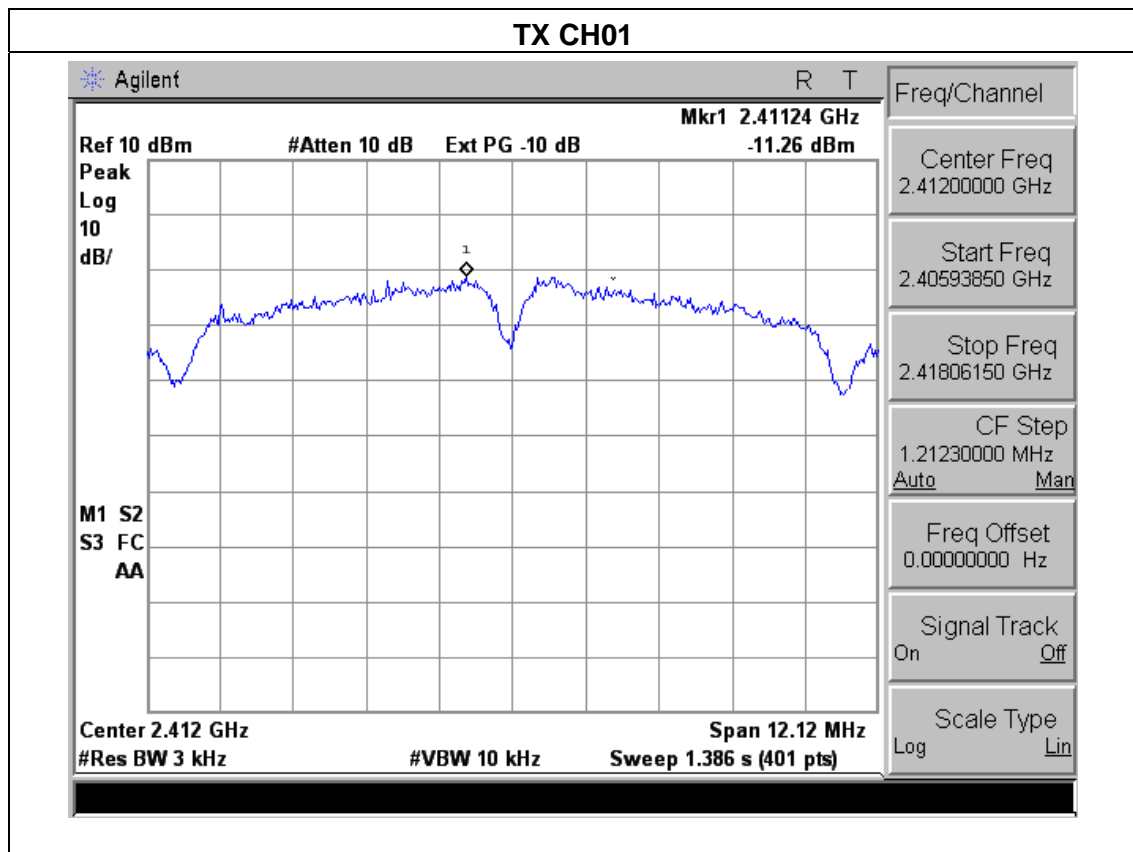

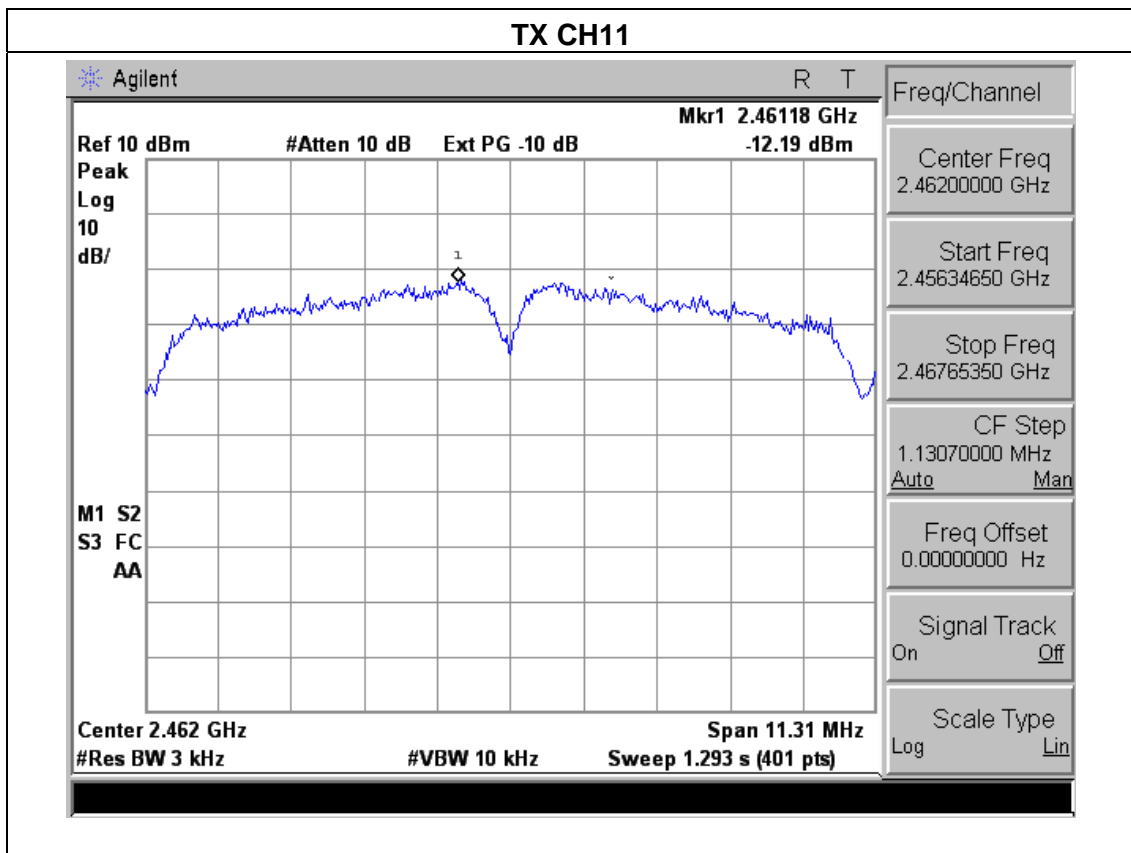
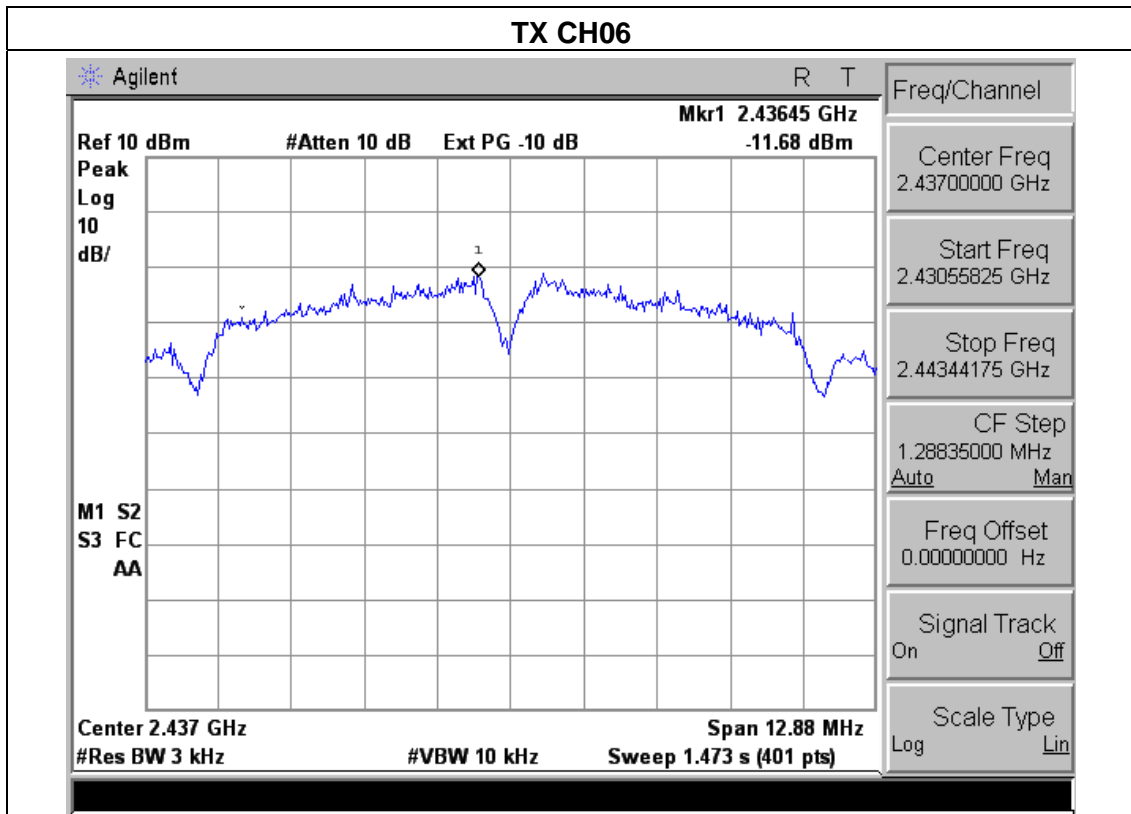

EUT :	Tablet PC	Model Name :	M71G
Temperature :	25 °C	Relative Humidity :	60%
Pressure :	1015 hPa	Test Voltage :	DC 5.0V from adapter
Test Mode :	TX g Mode /CH01, CH06, CH11		

Frequency	Power Density (dBm)	Limit (dBm)	Result
2412 MHz	-13.74	8	PASS
2437 MHz	-13.73	8	PASS
2462 MHz	-13.90	8	PASS

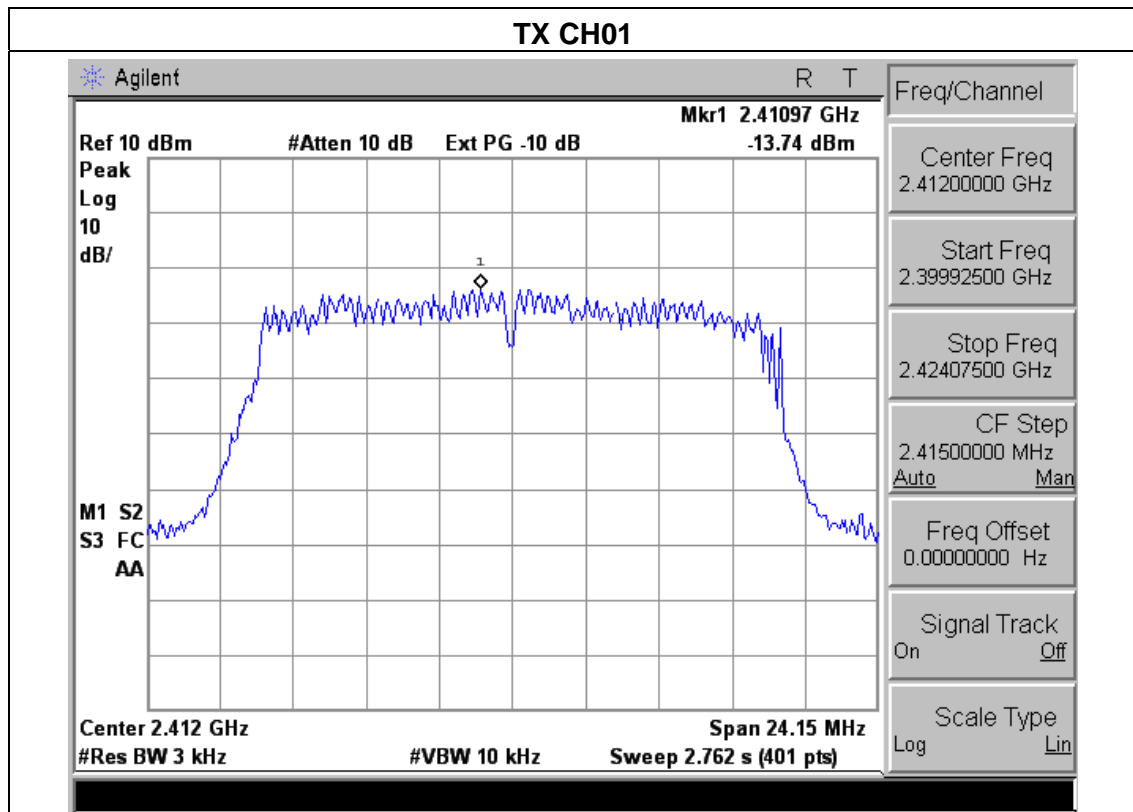

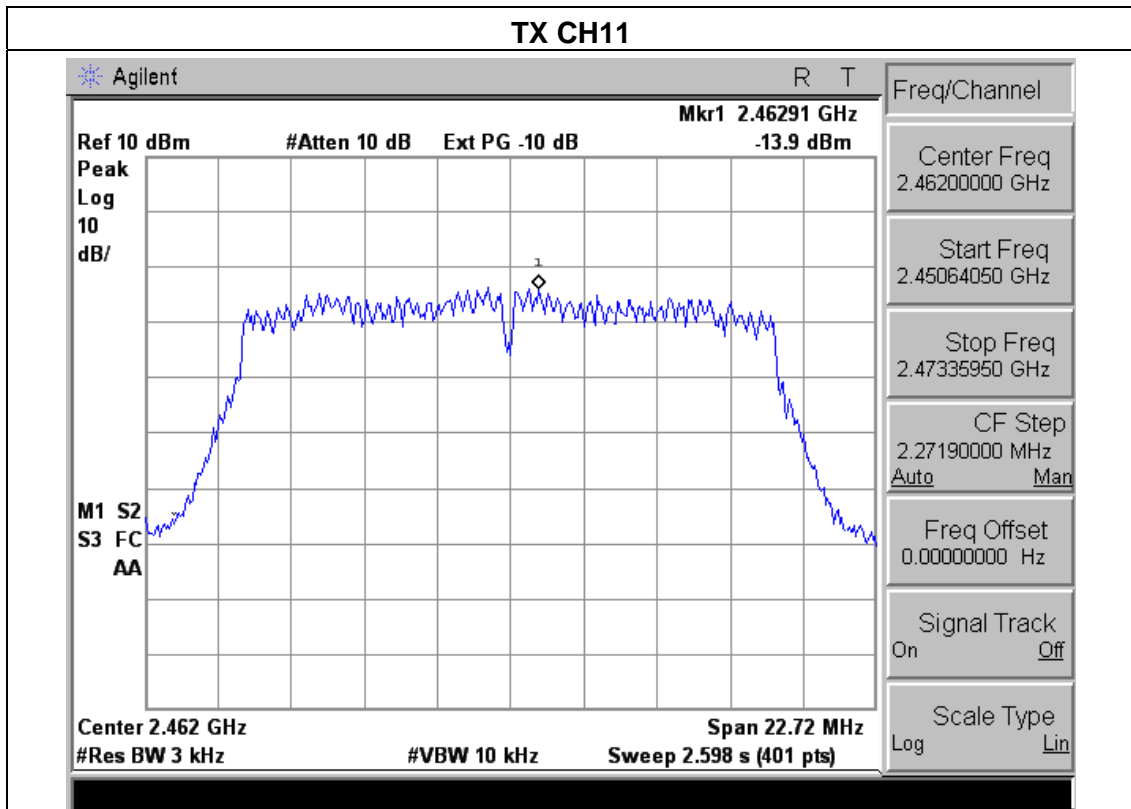
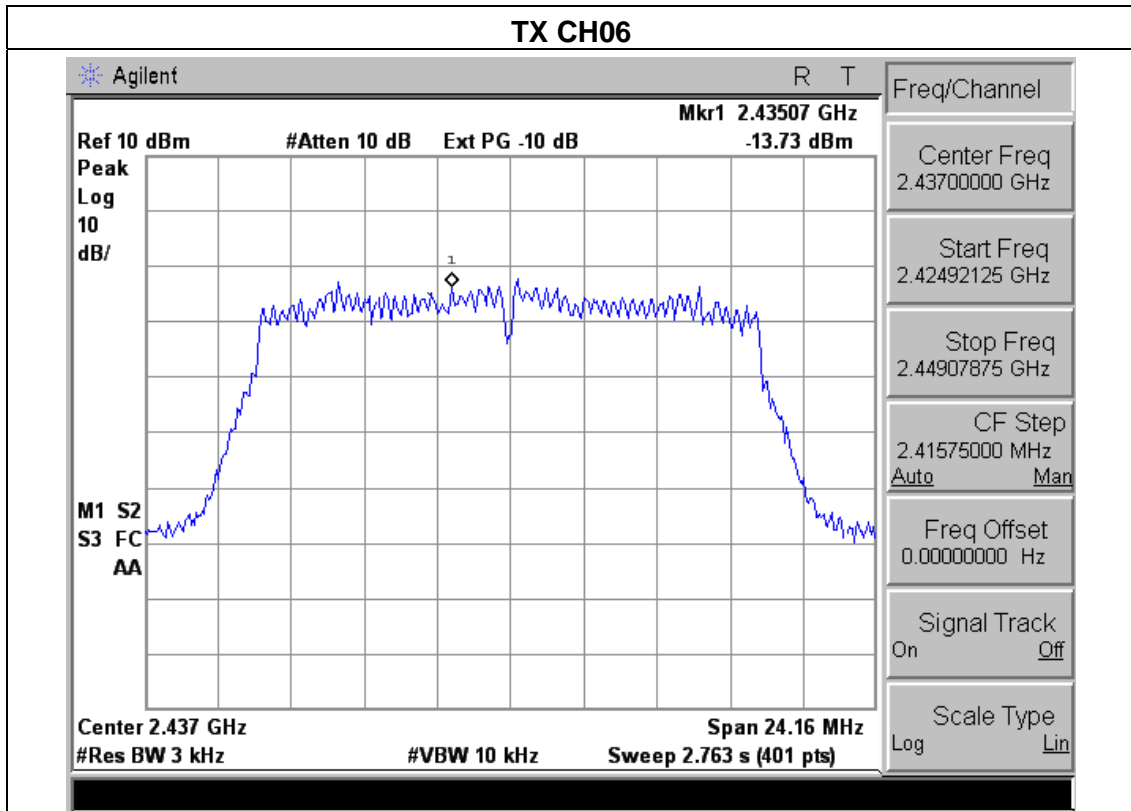

EUT :	Tablet PC	Model Name :	M71G
Temperature :	25 °C	Relative Humidity :	60%
Pressure :	1015 hPa	Test Voltage :	DC 5.0V from adapter
Test Mode :	TX n Mode /CH01, CH06, CH11		

Frequency	Power Density (dBm)	Limit (dBm)	Result
2412 MHz	-13.92	8	PASS
2437 MHz	-13.68	8	PASS
2462 MHz	-13.50	8	PASS

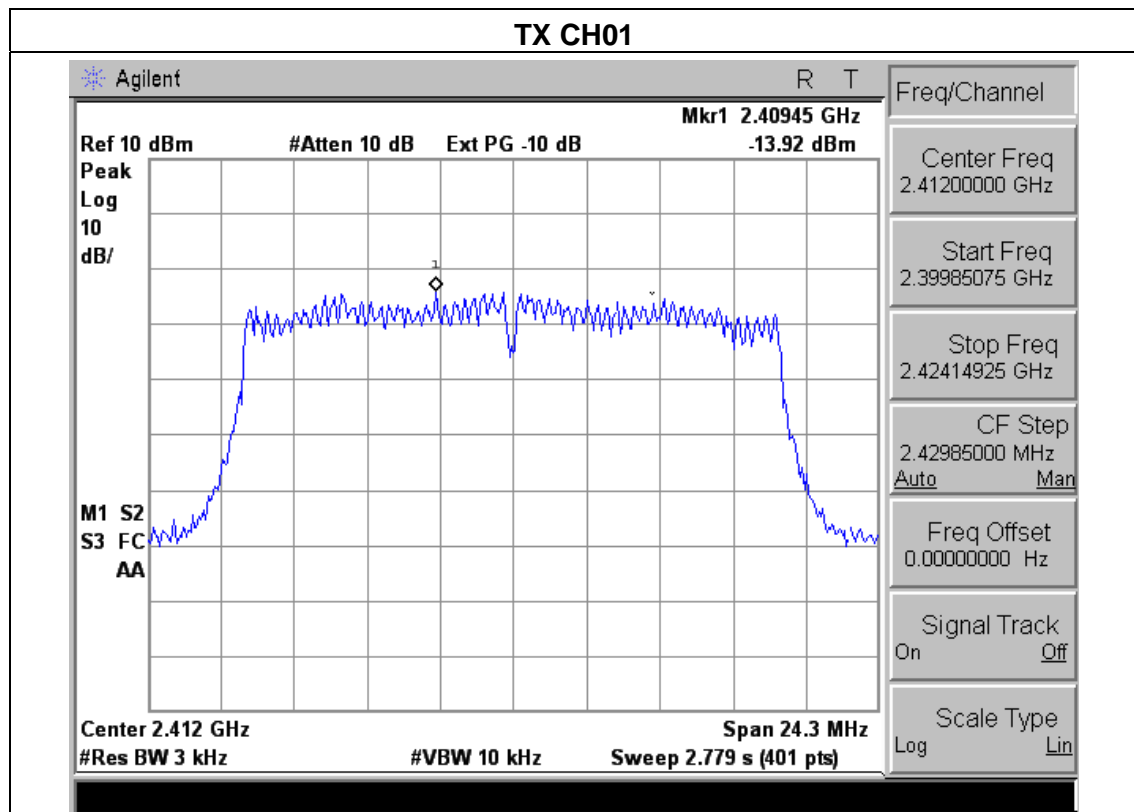

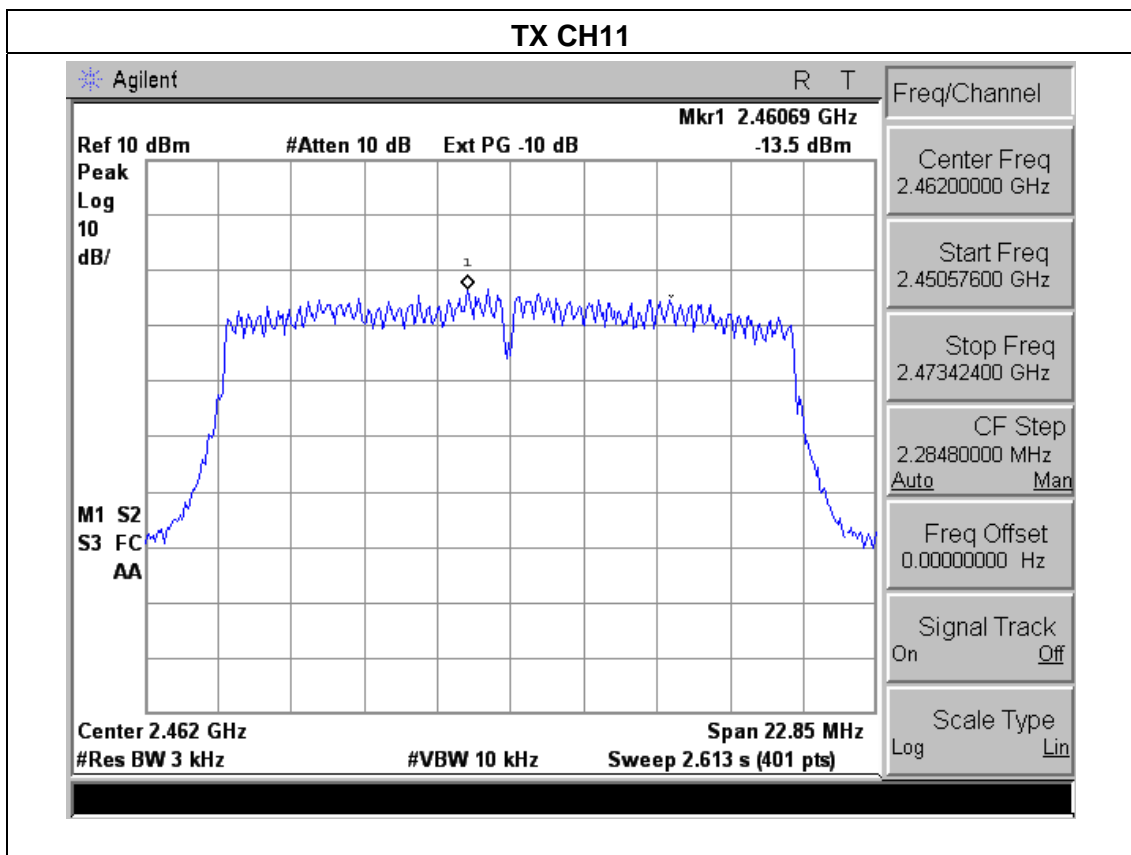
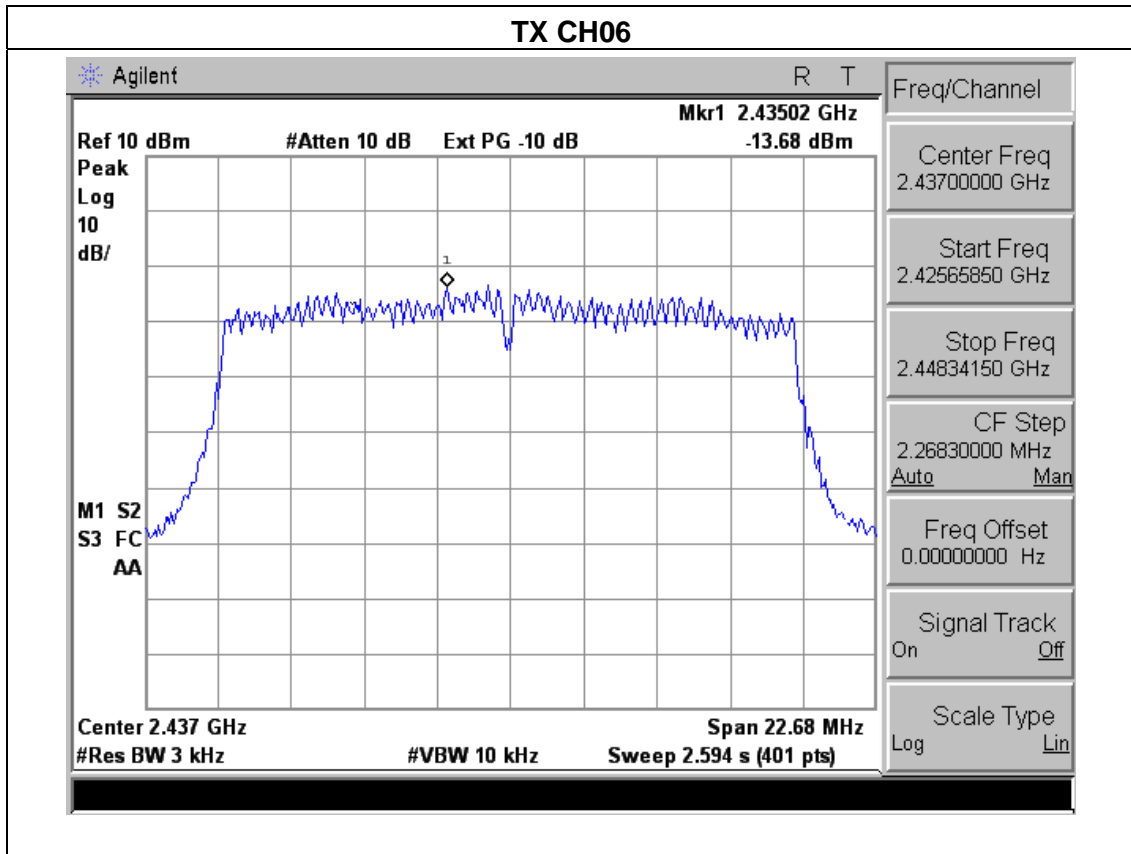

## 5. BANDWIDTH TEST

### 5.1 APPLIED PROCEDURES / LIMIT

FCC Part15 (15.247) , Subpart C				
Section	Test Item	Limit	Frequency Range (MHz)	Result
15.247(a)(2)	Bandwidth	$\geq 500\text{KHz}$ (6dB bandwidth)	2400-2483.5	PASS

#### 5.1.1 TEST PROCEDURE

1. Set RBW= 100 kHz.
2. Set the video bandwidth (VBW)  $\geq 3 \times$  RBW.
3. Detector = Peak.
4. Trace mode = max hold.
5. Sweep = auto couple.
6. Allow the trace to stabilize.
7. Measure the maximum width of the emission that is constrained by the frequencies associated with the two outermost amplitude points (upper and lower) that are attenuated by 6 dB relative to the maximum level measured in the fundamental emission.

#### 5.1.2 DEVIATION FROM STANDARD

No deviation.

#### 5.1.3 TEST SETUP



#### 5.1.4 EUT OPERATION CONDITIONS

The EUT tested system was configured as the statements of 2.4 Unless otherwise a special operating condition is specified in the follows during the testing.



### 5.1.5 TEST RESULTS

EUT :	Tablet PC	Model Name :	M71G
Temperature :	25 °C	Relative Humidity :	60%
Pressure :	1012 hPa	Test Voltage :	DC 5.0V from adapter
Test Mode :	TX b Mode /CH01, CH06, CH11		

Channel	Frequency (MHz)	6dB bandwidth (MHz)	Limit (kHz)	Result
Low	2412	8.08	500	Pass
Middle	2437	8.59	500	Pass
High	2462	7.54	500	Pass

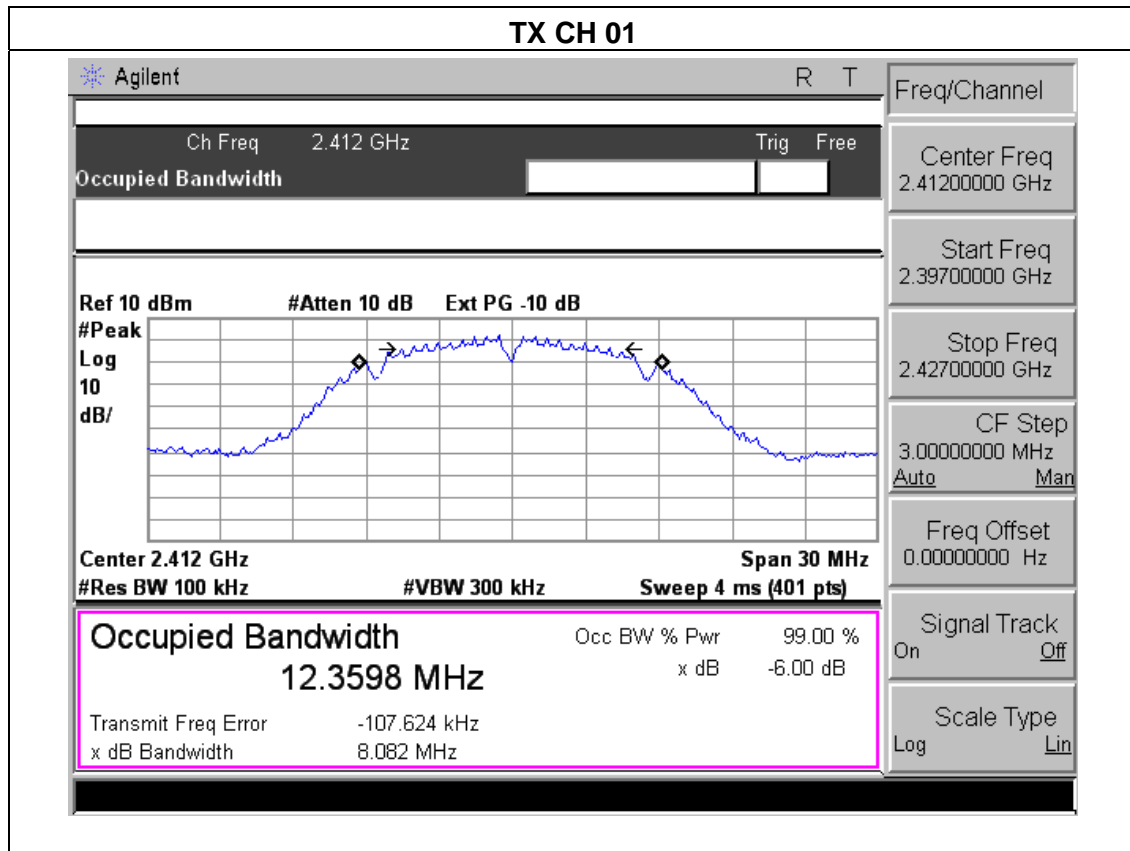

### TX CH 06

Agilent		R	T	Freq/Channel	
Ch Freq 2.437 GHz		Trig Free		Center Freq 2.43700000 GHz	
Occupied Bandwidth				Start Freq 2.42200000 GHz	
Ref 10 dBm #Atten 10 dB Ext PG -10 dB				Stop Freq 2.45200000 GHz	
				CF Step 3.00000000 MHz Auto Man	
Center 2.437 GHz		Span 30 MHz		Freq Offset 0.00000000 Hz	
#Res BW 100 kHz		#VBW 300 kHz		Sweep 4 ms (401 pts)	
<b>Occupied Bandwidth</b> <b>12.3574 MHz</b>		Occ BW % Pwr 99.00 %		Signal Track On Off	
		x dB -6.00 dB		Scale Type Log Lin	
Transmit Freq Error -98.256 kHz					
x dB Bandwidth 8.589 MHz					

### TX CH 11

Agilent		R	T	Freq/Channel	
Ch Freq 2.462 GHz		Trig Free		Center Freq 2.46200000 GHz	
Occupied Bandwidth				Start Freq 2.44700000 GHz	
Ref 10 dBm #Atten 10 dB Ext PG -10 dB				Stop Freq 2.47700000 GHz	
				CF Step 3.00000000 MHz Auto Man	
Center 2.462 GHz		Span 30 MHz		Freq Offset 0.00000000 Hz	
#Res BW 100 kHz		#VBW 300 kHz		Sweep 4 ms (401 pts)	
<b>Occupied Bandwidth</b> <b>12.3466 MHz</b>		Occ BW % Pwr 99.00 %		Signal Track On Off	
		x dB -6.00 dB		Scale Type Log Lin	
Transmit Freq Error -98.634 kHz					
x dB Bandwidth 7.538 MHz					

EUT :	Tablet PC	Model Name :	M71G
Temperature :	25 °C	Relative Humidity :	60%
Pressure :	1012 hPa	Test Voltage :	DC 5.0V from adapter
Test Mode :	TX g Mode /CH01, CH06, CH11		

Channel	Frequency (MHz)	6dB bandwidth (MHz)	Limit (kHz)	Result
Low	2412	16.10	500	Pass
Middle	2437	16.11	500	Pass
High	2462	15.15	500	Pass

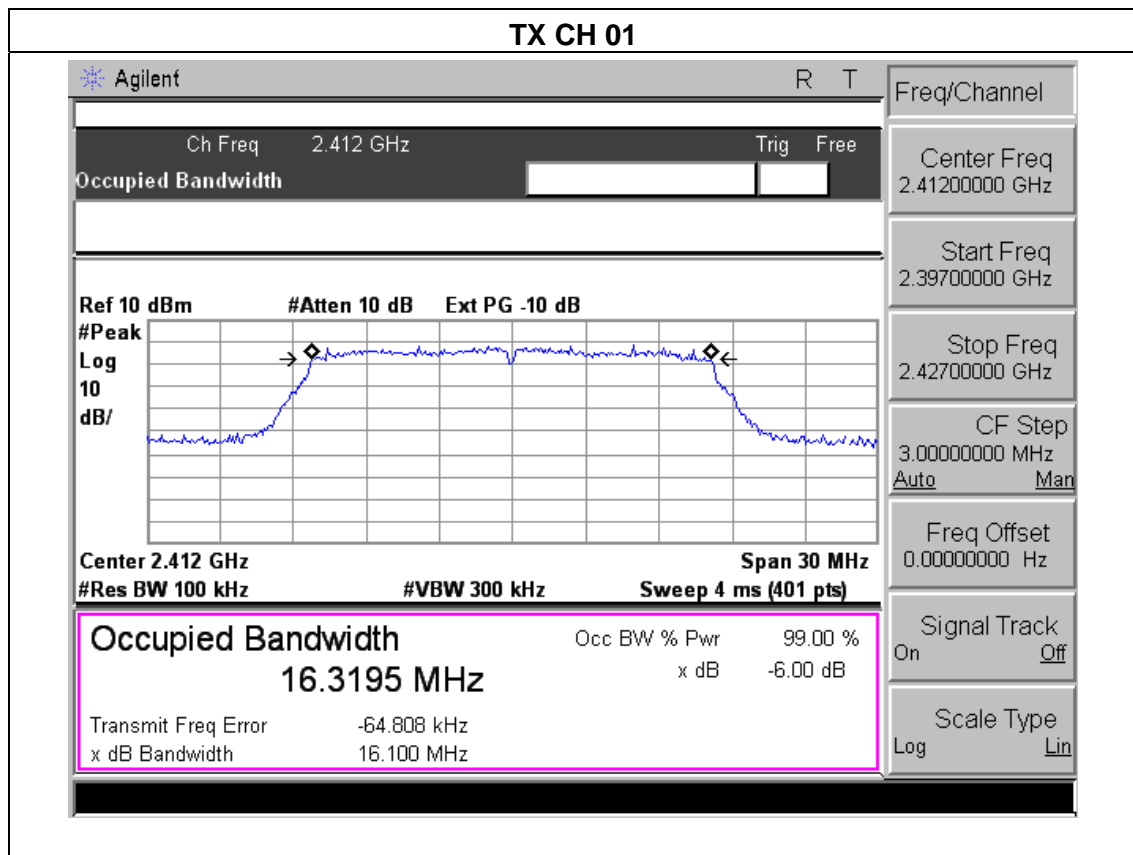

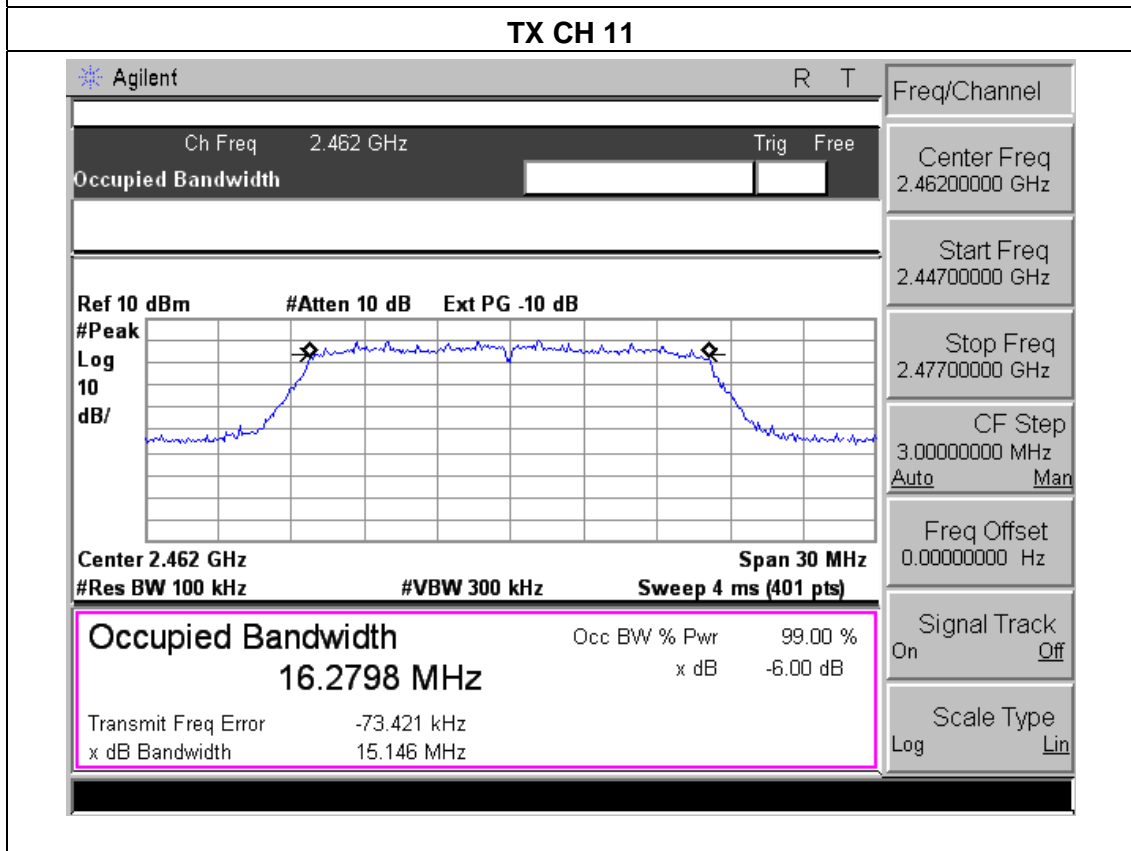
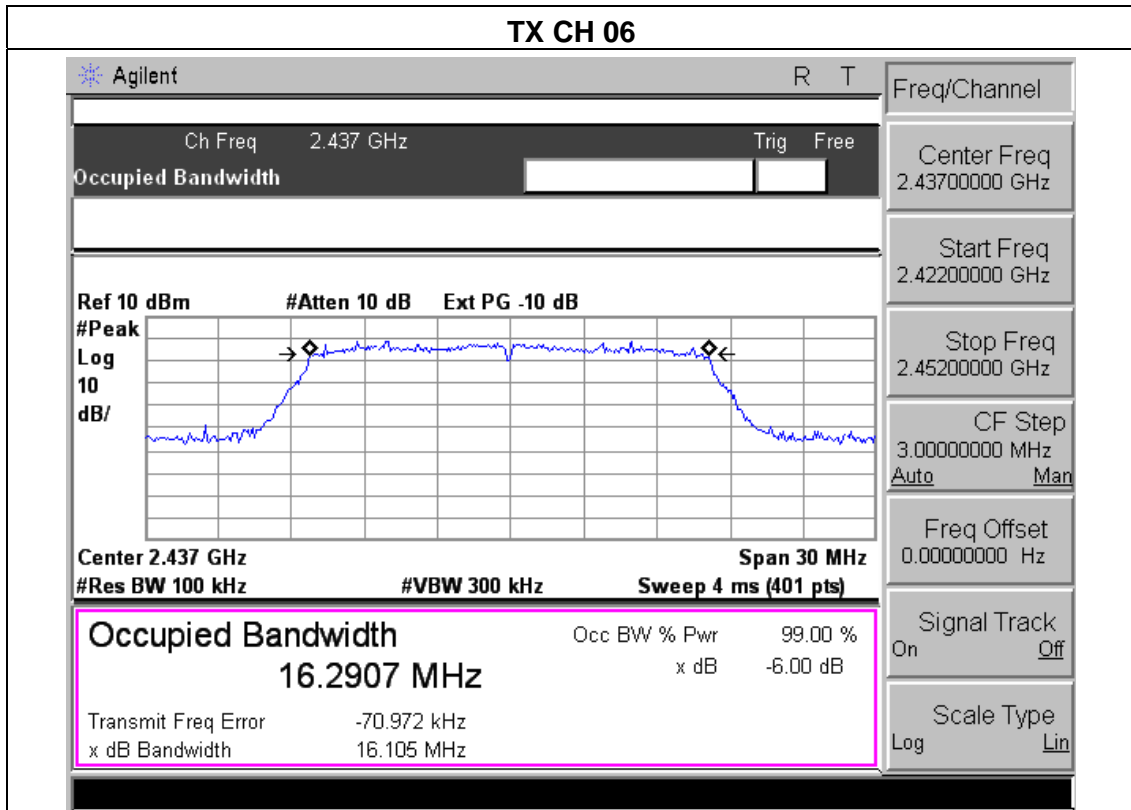

EUT :	Tablet PC	Model Name :	M71G
Temperature :	25 °C	Relative Humidity :	60%
Pressure :	1012 hPa	Test Voltage :	DC 5.0V from adapter
Test Mode :	TX n Mode /CH01, CH06, CH11		

Channel	Frequency (MHz)	6dB bandwidth (MHz)	Limit (kHz)	Result
Low	2412	16.20	500	Pass
Middle	2437	15.12	500	Pass
High	2462	15.23	500	Pass

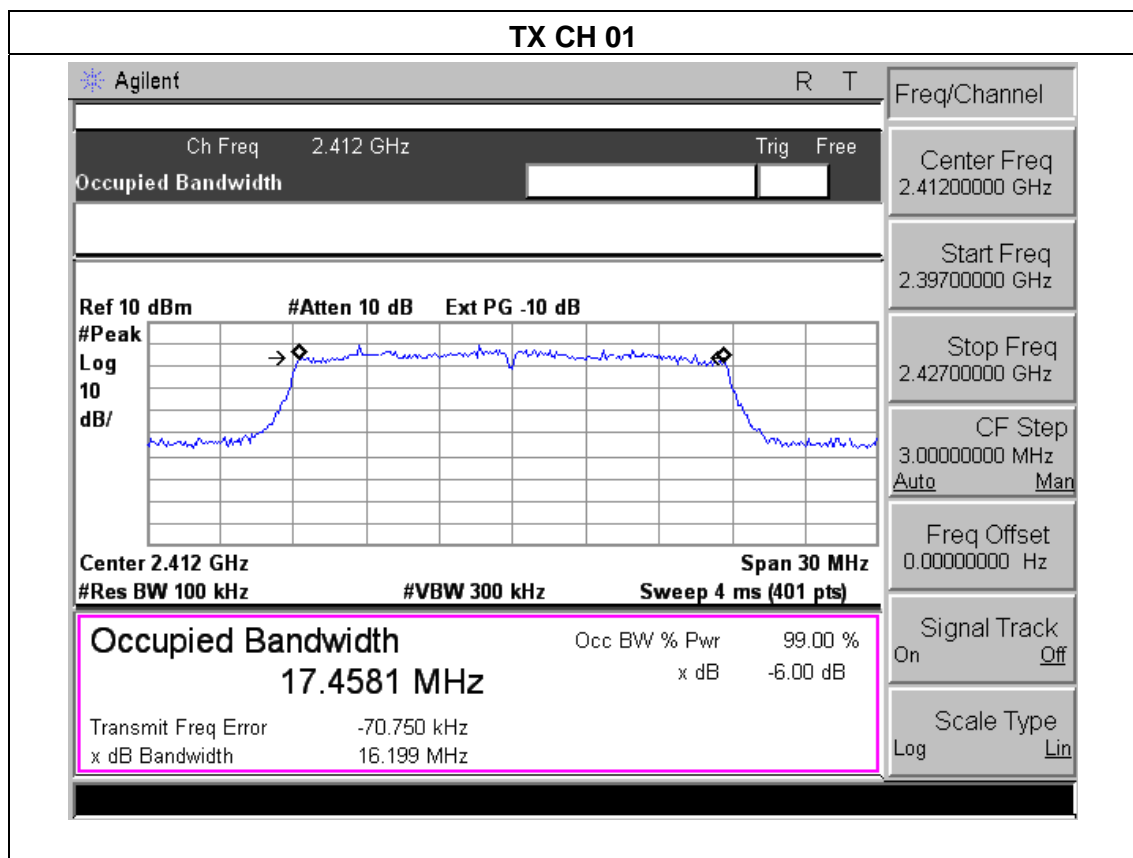

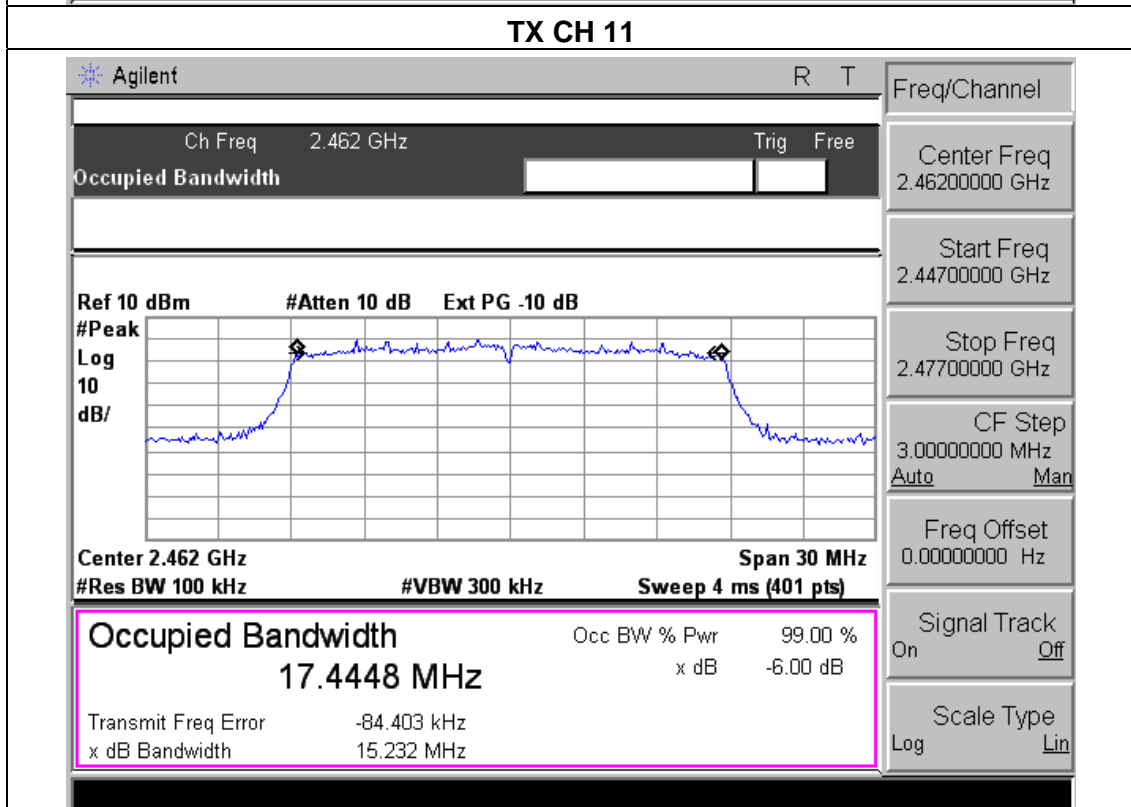
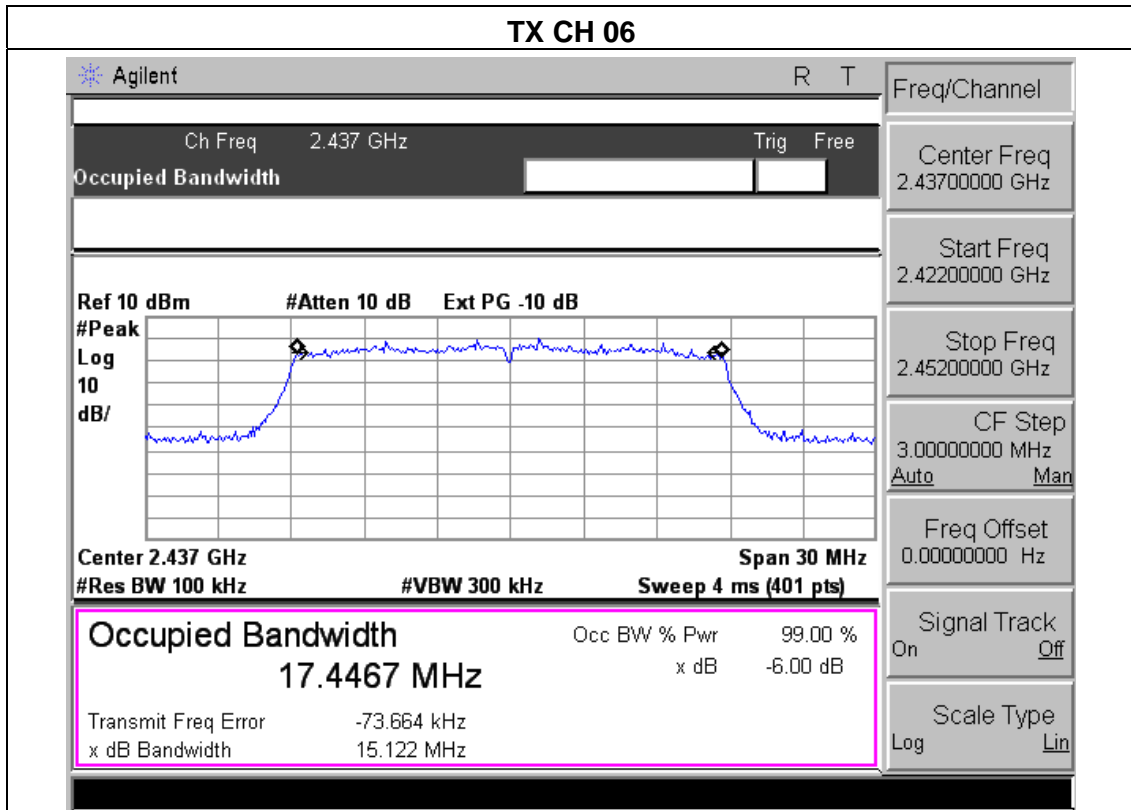

**6. PEAK OUTPUT POWER TEST**

**6.1 APPLIED PROCEDURES / LIMIT**

FCC Part15 (15.247) , Subpart C				
Section	Test Item	Limit	Frequency Range (MHz)	Result
15.247(b)(3)	Peak Output Power	1 watt or 30dBm	2400-2483.5	PASS

**6.1.1 TEST PROCEDURE**

- a. The EUT was directly connected to the Power meter

**6.1.2 DEVIATION FROM STANDARD**

No deviation.

**6.1.3 TEST SETUP**



**6.1.4 EUT OPERATION CONDITIONS**

The EUT tested system was configured as the statements of 2.4 Unless otherwise a special operating condition is specified in the follows during the testing.

**6.1.5 TEST RESULTS**

EUT :	Tablet PC	Model Name :	M71G
Temperature :	25 °C	Relative Humidity :	60%
Pressure :	1012 hPa	Test Voltage :	DC 5.0V from adapter
Test Mode :	TX b/g/n Mode /CH01, CH06, CH11		

<b>TX 802.11b Mode</b>				
Test Channel	Frequency	Maximum Conducted Output Power(PK)	Maximum Conducted Output Power(AV)	LIMIT
	(MHz)	(dBm)	(dBm)	dBm
CH01	2412	12.87	9.51	30
CH06	2437	12.70	9.35	30
CH11	2462	12.53	9.29	30
<b>TX 802.11g Mode</b>				
CH01	2412	11.90	9.13	30
CH06	2437	11.76	8.83	30
CH11	2462	11.81	8.89	30
<b>TX 802.11n Mode</b>				
CH01	2412	10.89	8.20	30
CH06	2437	10.83	8.09	30
CH11	2462	10.75	7.86	30



## 7. 100 KHZ BANDWIDTH OF FREQUENCY BAND EDGE

### APPLICABLE STANDARD

In any 100 kHz bandwidth outside the frequency band in which the spread spectrum or digitally modulated intentional radiator is operating, the radio frequency power that is produced by the intentional radiator shall be at least 20 dB below that in the 100 kHz bandwidth within the band that contains the highest level of the desired power, based on either an RF conducted or a radiated measurement, provided the transmitter demonstrates compliance with the peak conducted power limits. If the transmitter complies with the conducted power limits based on the use of RMS averaging over a time interval, as permitted under paragraph (b)(3) of this section, the attenuation required under this paragraph shall be 30 dB instead of 20 dB. Attenuation below the general limits specified in §15.209(a) is not required. In addition, radiated emissions which fall in the restricted bands, as defined in §15.205(a), must also comply with the radiated emission limits specified in §15.209(a) (see §15.205(c)).

### TEST PROCEDURE

- a) Check the calibration of the measuring instrument using either an internal calibrator or a known signal from an external generator.
- b) Position the EUT without connection to measurement instrument. Turn on the EUT and connect its antenna terminal to measurement instrument via a low loss cable. Then set it to any one measured frequency within its operating range, and make sure the instrument is operated in its linear range.
- c) Set RBW to 100 kHz and VBW of spectrum analyzer to 300 kHz with a convenient frequency span including 100 kHz bandwidth from band edge.
- d) Measure the highest amplitude appearing on spectral display and set it as a reference level. Plot the graph with marking the highest point and edge frequency.
- e) Repeat above procedures until all measured frequencies were complete.

### 7.1 DEVIATION FROM STANDARD

No deviation.

### 7.2 TEST SETUP

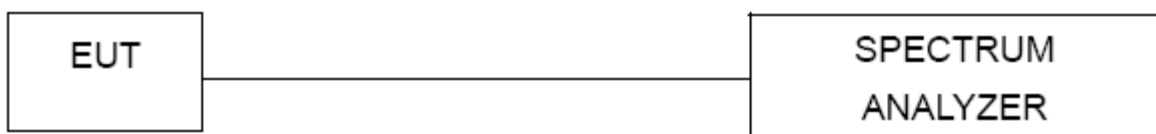

### 7.3 EUT OPERATION CONDITIONS

The EUT tested system was configured as the statements of 2.4 Unless otherwise a special operating condition is specified in the follows during the testing.

### 7.4 TEST RESULTS

EUT :	Tablet PC	Model Name :	M71G
Temperature :	25 °C	Relative Humidity :	60%
Pressure :	1012 hPa	Test Voltage :	DC 5.0V from adapter

Frequency Band	Delta Peak to band emission (dBc)	> Limit (dBc)	Result
802.11b mode			
Left-band	49.66	20	Pass
Right-band	57.39	20	Pass
802.11g mode			
Left-band	34.37	20	Pass
Right-band	47.30	20	Pass
802.11n mode			
Left-band	40.29	20	Pass
Right-band	48.56	20	Pass

Frequency (MHz)	Meter Reading (dBμV)	Factor (dB)	Emission Level (dBμV/m)	Limits (dBμV/m)	Margin (dB)	Detector Type	Comment
802.11b							
2390	57.42	-13.06	44.36	74	-29.64	peak	Vertical
2390	58.53	-13.06	45.47	74	-28.53	peak	Horizontal
2483.5	57.66	-12.78	44.88	74	-29.12	peak	Vertical
2483.5	53.69	-12.78	40.91	74	-33.09	peak	Horizontal
802.11g							
2390	57.54	-13.06	44.48	74	-29.52	peak	Vertical
2390	56.62	-13.06	43.56	74	-30.44	peak	Horizontal
2483.5	61.25	-12.78	48.47	74	-25.53	peak	Vertical
2483.5	62.43	-12.78	49.65	74	-24.35	peak	Horizontal
802.11n							
2390	62.58	-13.06	49.52	74	-24.48	peak	Vertical
2390	62.74	-13.06	49.68	74	-24.32	peak	Horizontal
2483.5	57.38	-12.78	44.60	74	-29.40	peak	Vertical
2483.5	56.28	-12.78	43.50	74	-30.50	peak	Horizontal

### 802.11b: Band Edge, Left Side

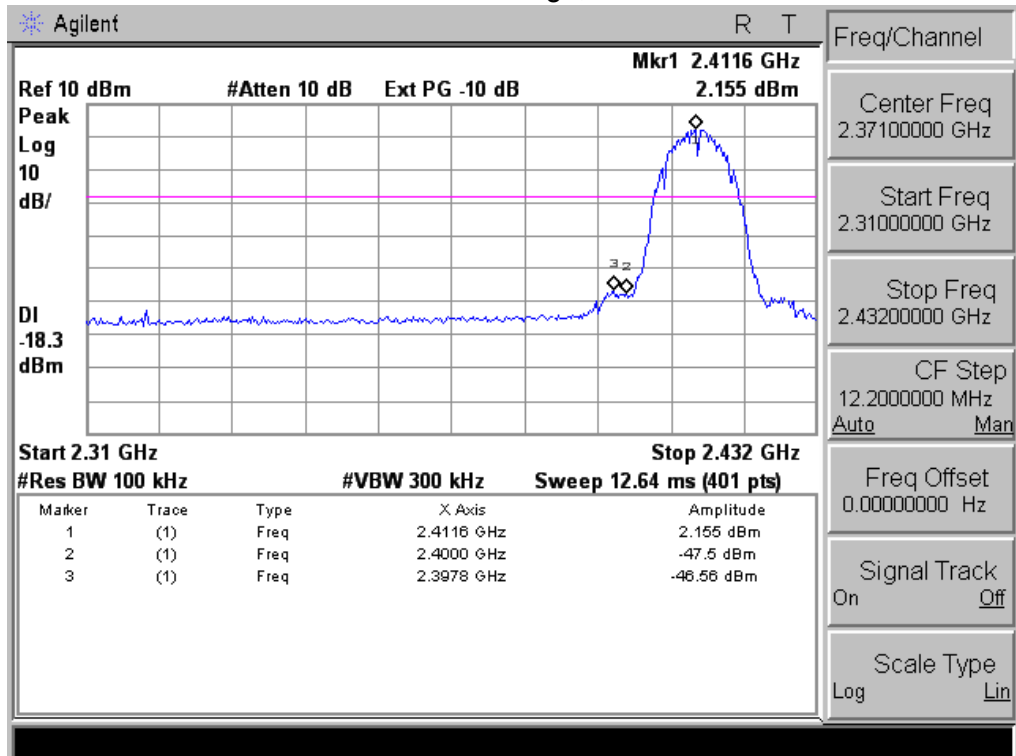

### 802.11b: Band Edge, Right Side

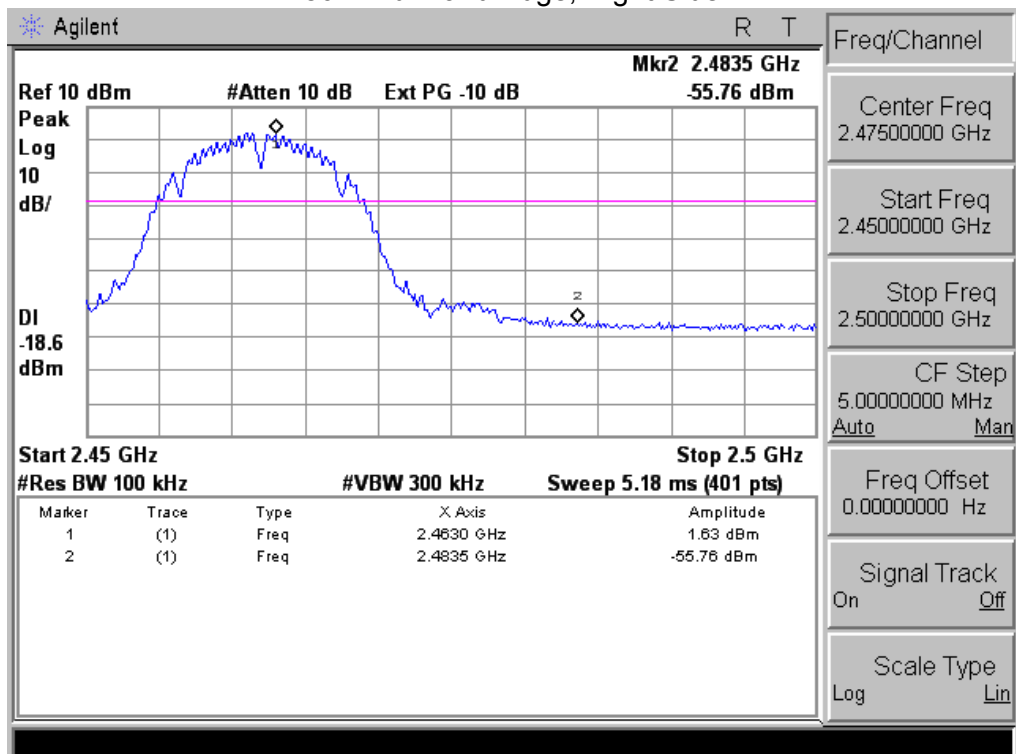

### 802.11g: Band Edge, Left Side

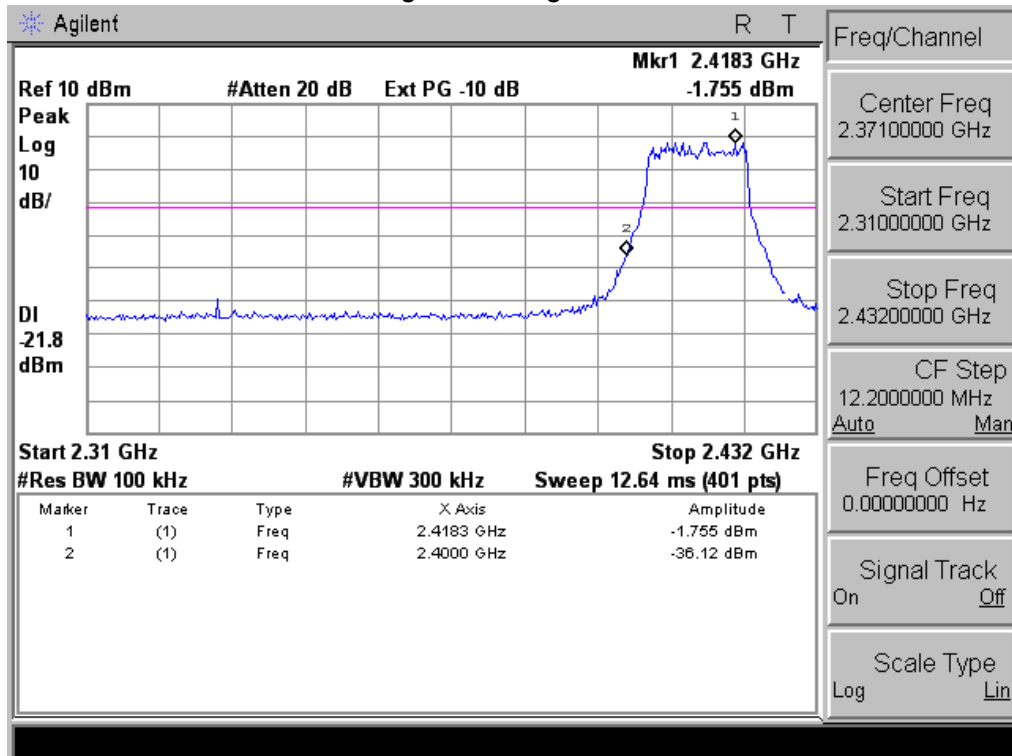

### 802.11g: Band Edge, Right Side

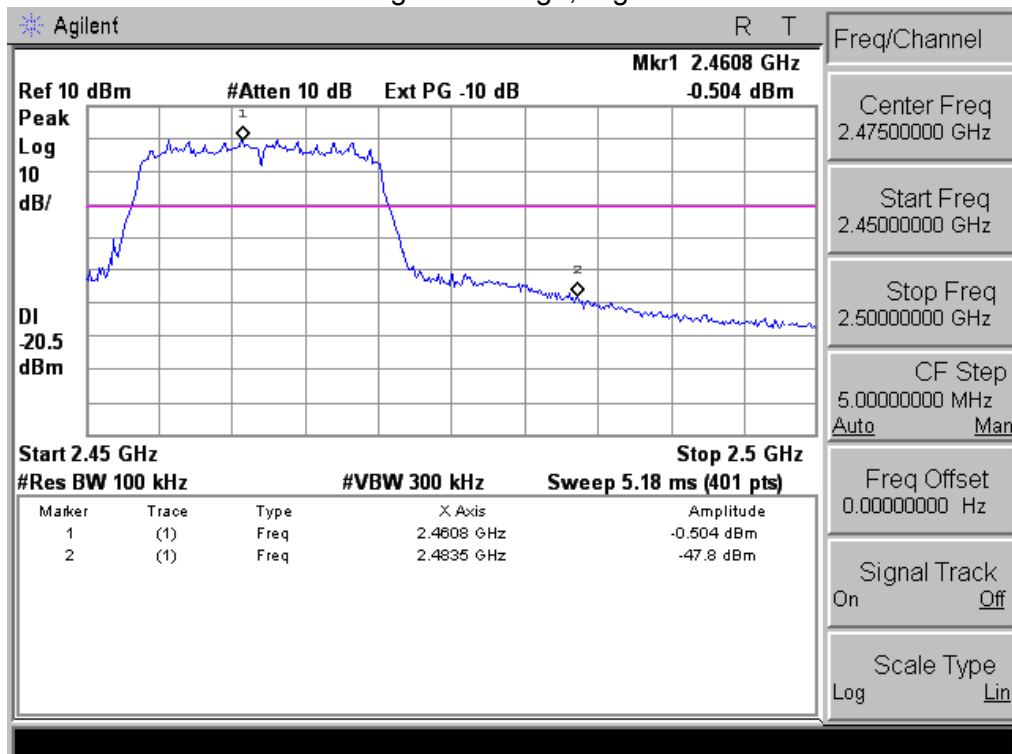

### 802.11n: Band Edge, Left Side

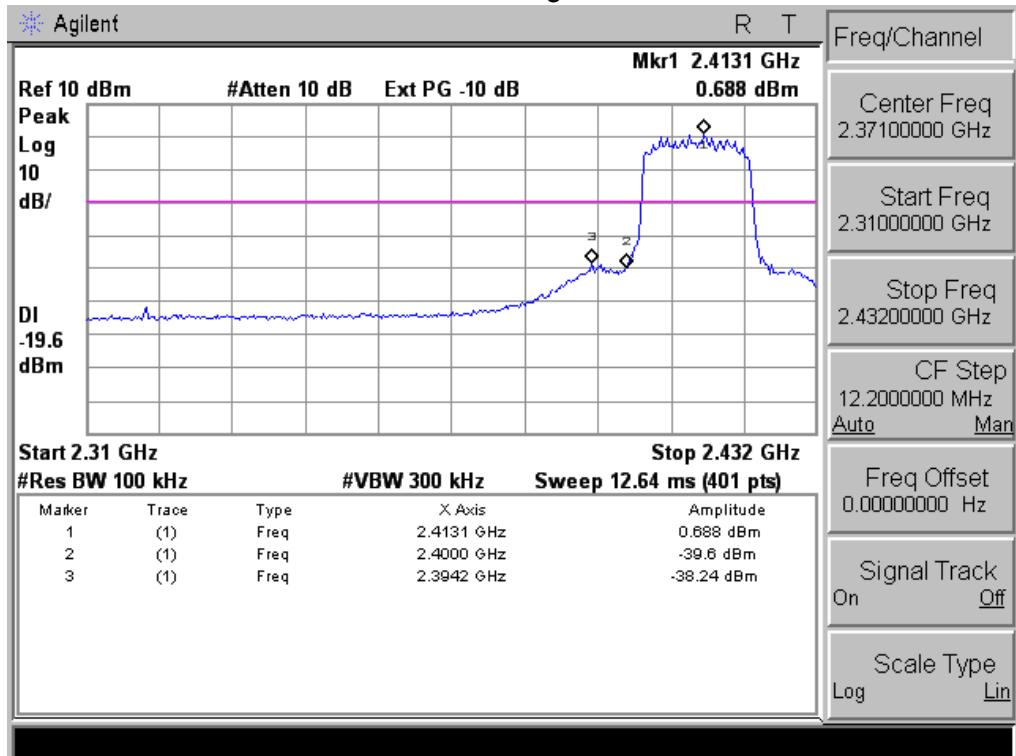

### 802.11n: Band Edge, Right Side

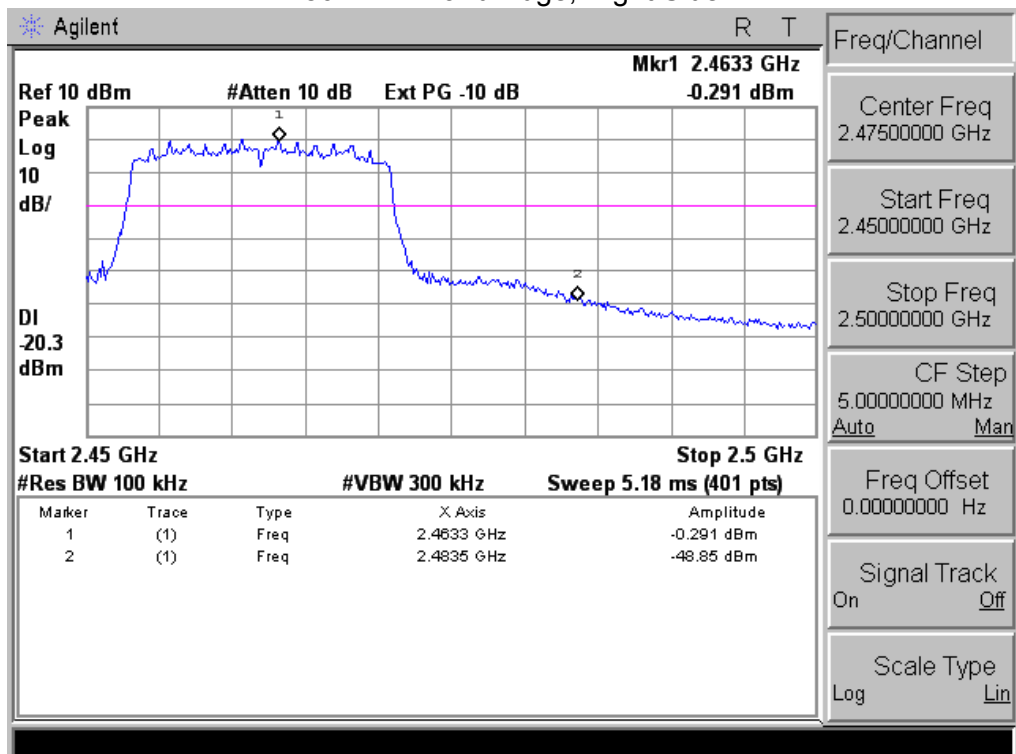

## **8. ANTENNA REQUIREMENT**

### **8.1 STANDARD REQUIREMENT**

15.203 requirement: For intentional device, according to 15.203: an intentional radiator shall be designed to ensure that no antenna other than that furnished by the responsible party shall be used with the device.

### **8.2 EUT ANTENNA**

The EUT antenna is Integrated(FPCB) antenna. It comply with the standard requirement.

**9. EUT TEST PHOTO**

**Radiated Measurement Photos**

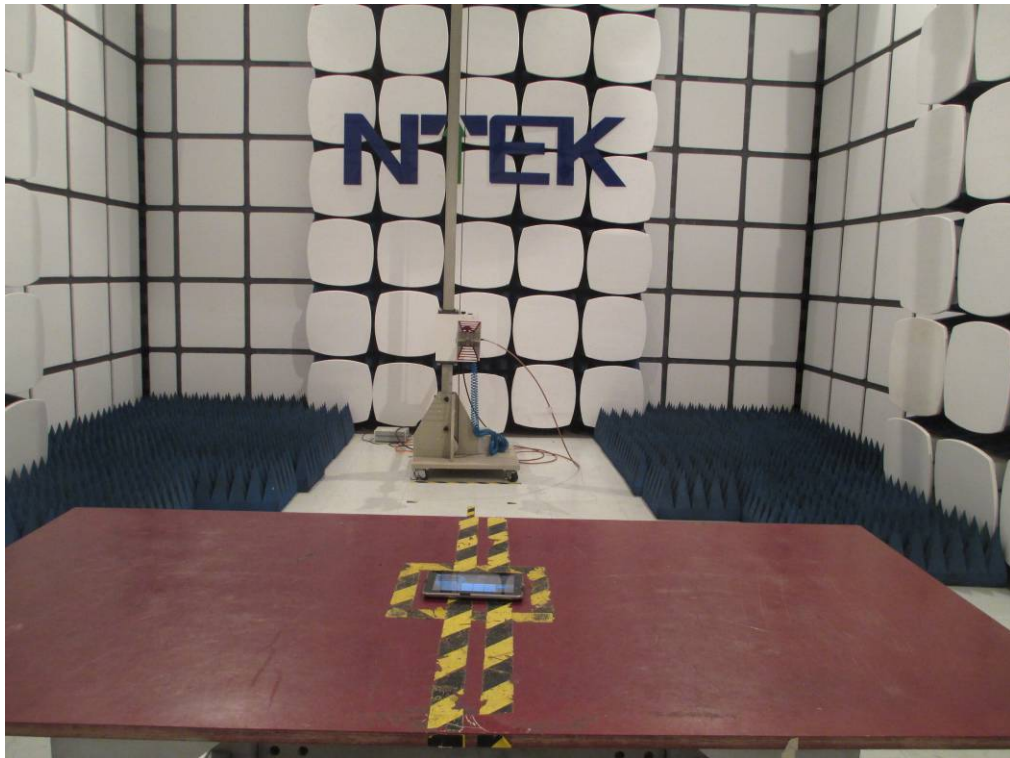
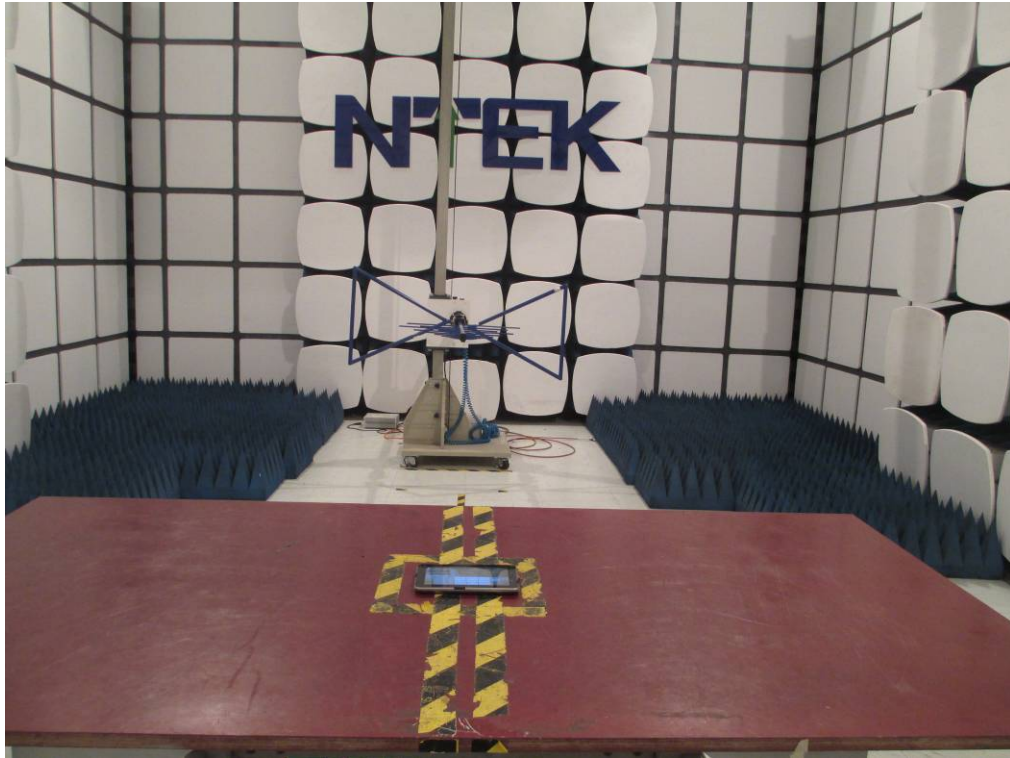

**Conducted Measurement Photos**

