

Certification Test Report

**FCC ID: P2SBELTCLIP
IC: 4171B-BELTCLIP**

**FCC Rule Part: 15.249
IC Radio Standards Specification: RSS-210**

ACS Report Number: 13-0249.W06.1A

**Manufacturer: Neptune Technology Group, Inc.
Model: 13253-000**

**Test Begin Date: August 9, 2013
Test End Date: September 29, 2013**

Report Issue Date: December 9, 2013



FOR THE SCOPE OF ACCREDITATION UNDER LAB Code 200612-0

This report must not be used by the client to claim product certification, approval, or endorsement by NVLAP, NIST, or any agency of the Federal Government.

Reviewed by:

A handwritten signature in black ink, appearing to read 'Kirby Munroe', is written over a horizontal line.

**Kirby Munroe
Director, Wireless Certifications
ACS, Inc.**

This test report shall not be reproduced except in full. This report may be reproduced in part with prior written consent of ACS, Inc. The results contained in this report are representative of the sample(s) submitted for evaluation.

This report contains 20 pages

TABLE OF CONTENTS

1	GENERAL	3
1.1	PURPOSE.....	3
1.2	PRODUCT DESCRIPTION	3
1.3	TEST METHODOLOGY AND CONSIDERATIONS	3
2	TEST FACILITIES	5
2.1	LOCATION	5
2.2	LABORATORY ACCREDITATIONS/RECOGNITIONS/CERTIFICATIONS	5
2.3	RADIATED EMISSIONS TEST SITE DESCRIPTION	6
2.3.1	<i>Semi-Anechoic Chamber Test Site</i>	6
2.3.2	<i>Open Area Tests Site (OATS)</i>	7
2.4	CONDUCTED EMISSIONS TEST SITE DESCRIPTION	8
3	APPLICABLE STANDARD REFERENCES	8
4	LIST OF TEST EQUIPMENT	9
5	SUPPORT EQUIPMENT	10
6	EQUIPMENT UNDER TEST SETUP BLOCK DIAGRAM	10
7	SUMMARY OF TESTS	11
7.1	ANTENNA REQUIREMENT – FCC 15.203	11
7.2	POWER LINE CONDUCTED EMISSIONS – FCC 15.207; IC RSS-GEN 7.2.4	11
7.2.1	<i>Measurement Procedure</i>	11
7.2.2	<i>Measurement Results</i>	11
7.3	20dB / 99% BANDWIDTH – FCC 15.215; IC RSS-GEN 4.6.....	12
7.3.1	<i>Measurement Procedure</i>	12
7.3.2	<i>Measurement Results</i>	12
7.4	FUNDAMENTAL FIELD STRENGTH – FCC 15.249(A); IC RSS-210 A2.9(A)	16
7.4.1	<i>Measurement Procedure</i>	16
7.4.2	<i>Measurement Results</i>	16
7.5	RADIATED SPURIOUS EMISSIONS – FCC 15.249(A)(D)(E); IC RSS-210 A2.9(A)(B)	17
7.5.1	<i>Measurement Procedure</i>	17
7.5.2	<i>Duty Cycle Correction</i>	17
7.5.3	<i>Measurement Results</i>	18
7.5.4	<i>Sample Calculation:</i>	19
8	CONCLUSION	19

1 GENERAL

1.1 Purpose

The purpose of this report is to demonstrate compliance with Part 15 Subpart C of the FCC's Code of Federal Regulations and Industry Canada's Radio Standards Specification RSS-210.

1.2 Product description

The 13253-000 R900 Belt Clip Receiver (BCR) is a body-worn, software-defined receiver capable of simultaneously receiving R900, Advantage, and Pocket Pro Reader RF transmissions. The R900 BCR collects readings and then transfers these readings to the handheld through the Bluetooth connection. The R900 BCR also has the capability to receive and store R900 readings that can be imported into the billing system without the use of a handheld.

Technical Details:

Table1.3-1: Bluetooth Radio Properties

Modulation	Frequency Range (MHz)	Number of Channels	Channel Separation (kHz)	Data Rate (Mbps)
GFSK	2402 - 2480	79	1000	1
$\pi/4$ -DQPSK	2402 - 2480	79	1000	2
8DPSK	2402 - 2480	79	1000	3

Antenna Type/Gain: Chip Antenna, 1.3 dBi Gain
Operating Voltage: 4.2Vdc Battery

Manufacturer Information:
Neptune Technology Group, Inc.
1600 Alabama Highway 229
Tallahassee, AL 36078

EUT Serial Numbers: BC000127

Test Sample Condition: The test samples were provided in good working order with no visible defects.

1.3 Test Methodology and Considerations

The EUT was tested for the Bluetooth radio for all available modulations. Where applicable, data is provided for the modulation / data rate corresponding to the worst case.

The radiated emissions evaluations were conducted up to the 10th harmonic for all available modulations. Preliminary measurements were collected for the EUT set in three orthogonal orientations. The measurements reported herein correspond to the orientation and modulation / data rate leading to the highest emissions relative to the limits.

The EUT operates from internal batteries but can be connected to an external charger or computer via a USB port. The Bluetooth radio is not operable when an external device is connected via the USB port. The EUT was evaluated for radiated emissions in the stand-alone configuration only.

Table 1.3-1: Bluetooth Radio Test configuration

Frequency (MHz)	Channel Number	Modulation	Data Rate (Mbps)
2402	0	GFSK	1
2441	39		
2480	78		
2402	0	$\pi/4$ DQPSK	2
2441	39		
2480	78		
2402	0	8 DPSK	3
2441	39		
2480	78		

2 TEST FACILITIES**2.1 Location**

The radiated and conducted emissions test sites are located at the following address:

Advanced Compliance Solutions
5015 B.U. Bowman Drive
Buford, GA 30518
Phone: (770) 831-8048
Fax: (770) 831-8598

2.2 Laboratory Accreditations/Recognitions/Certifications

ACS is accredited to ISO/IEC 17025 by the National Institute of Standards and Technology under their National Voluntary Laboratory Accreditation Program (NVLAP), Lab Code 200612-0. Unless otherwise specified, all tests methods described within this report are covered under the ISO/IEC 17025 scope of accreditation.

The Semi-Anechoic Chamber Test Site, Open Area Test Site (OATS) and Conducted Emissions Site have been fully described, submitted to, and accepted by the FCC, Industry Canada and the Japanese Voluntary Control Council for Interference by information technology equipment.

FCC Registration Number: 511277
Industry Canada Lab Code: 4175A-1
VCCI Member Number: 1831

- VCCI OATS Registration Number R-1526
- VCCI Conducted Emissions Site Registration Number: C-1608

2.3 Radiated Emissions Test Site Description

2.3.1 Semi-Anechoic Chamber Test Site

The Semi-Anechoic Chamber Test Site consists of a 20' x 30' x 18' shielded enclosure. The chamber is lined with Toyo Ferrite Grid Absorber, model number FFG-1000. The ferrite tile grid is 101 x 101 x 19mm thick and weighs approximately 550 grams. These tiles are mounted on steel panels and installed directly on the inner walls of the chamber.

The turntable is 150cm in diameter and is located 160cm from the back wall of the chamber. The chamber is grounded via 1 - 8' copper ground rod, installed at the center of the back wall, it is bound to the ground plane using 3/4" stainless steel braided cable.

The turntable is all steel, flush mounted table installed in an all steel frame. The table is remotely operated from inside the control room located 25' from the range. The turntable is electrically bonded to the surrounding ground plane via steel fingers installed on the edge of the turn table. The steel fingers make constant contact with the ground plane during operation.

Behind the turntable is a 3' x 6' x 4' deep shielded pit used for support equipment if necessary. The pit is equipped with 1 - 4" PVC chases from the turntable to the pit that allow for cabling to the EUT if necessary. The underside of the turntable can be accessed from the pit so cables can be supplied to the EUT from the pit.

A diagram of the Semi-Anechoic Chamber Test Site is shown in Figure 2.3-1 below:

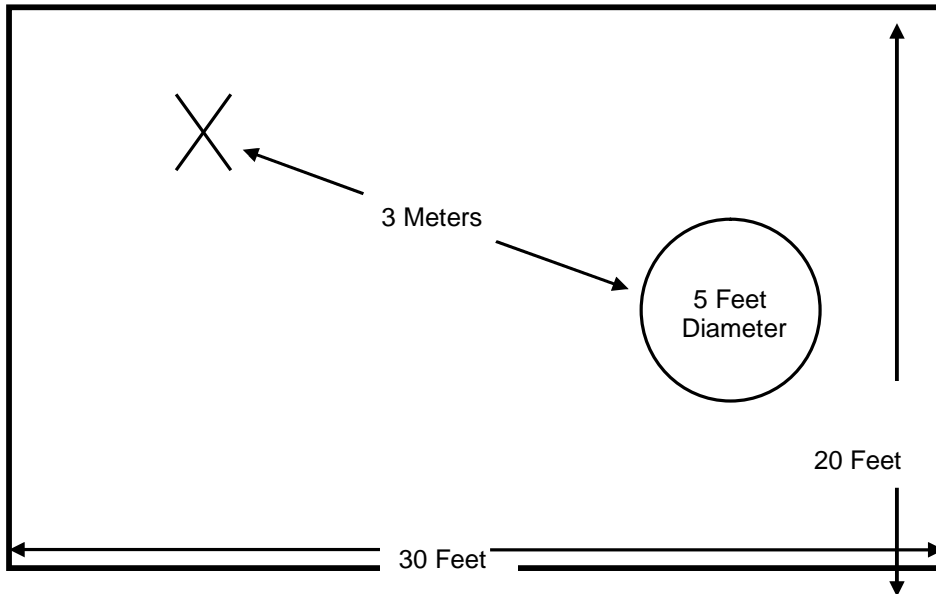

Figure 2.3-1: Semi-Anechoic Chamber Test Site

2.3.2 Open Area Tests Site (OATS)

The open area test site consists of a 40' x 66' concrete pad covered with a perforated electro-plated galvanized sheet metal. The perforations in the sheet metal are 1/8" holes that are staggered every 3/16". The individual sheets are placed to overlap each other by 1/4" and are riveted together to provide a continuous seam. Rivets are spaced every 3" in a 3 x 20 meter perimeter around the antenna mast and EUT area. Rivets in the remaining area are spaced as necessary to properly secure the ground plane and maintain the electrical continuity.

The entire ground plane extends 12' beyond the turntable edge and 16' beyond the antenna mast when set to a 10 meter measurement distance. The ground plane is grounded via 4 - 8' copper ground rods, each installed at a corner of the ground plane and bound to the ground plane using 3/4" stainless steel braided cable.

The turntable is an all aluminum 10' flush mounted table installed in an all aluminum frame. The table is remotely operated from inside the control room located 40' from the range. The turntable is electrically bonded to the surrounding ground plane via steel fingers installed on the edge of the turn table. The steel fingers make constant contact with the ground plane during operation.

Adjacent to the turntable is a 7' x 7' square and 4' deep concrete pit used for support equipment if necessary. The pit is equipped with 5 - 4" PVC chases from the pit to the control room that allow for cabling to the EUT if necessary. The underside of the turntable can be accessed from the pit so cables can be supplied to the EUT from the pit. The pit is covered with 2 sheets of 1/4" diamond style re-enforced steel sheets. The sheets are painted to match the perforated steel ground plane; however the underside edges have been masked off to maintain the electrical continuity of the ground plane. All reflecting objects are located outside of the ellipse defined in ANSI C63.4.

A diagram of the Open Area Test Site is shown in Figure 2.3-2 below:

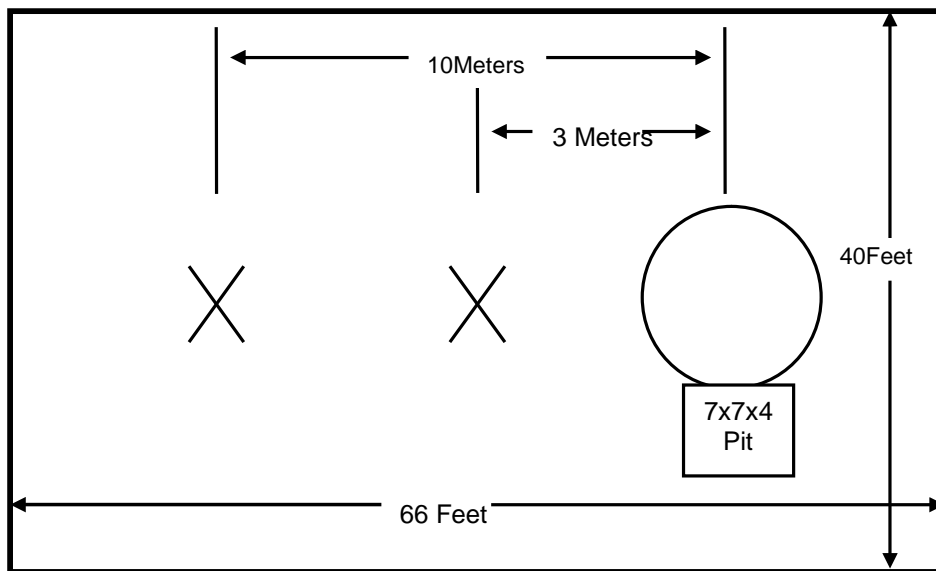

Figure 2.3-2: Open Area Test Site

2.4 Conducted Emissions Test Site Description

The AC mains conducted EMI site is located in the main EMC lab. It consists of an 8' x 8' solid aluminum horizontal ground reference plane (GRP) bonded every 3" to an 8' X 8' vertical ground plane.

The site is of sufficient size to test table top and floor standing equipment in accordance with section 6.1.4 of ANSI C63.4.

A diagram of the room is shown below in figure 4.1.3-1:

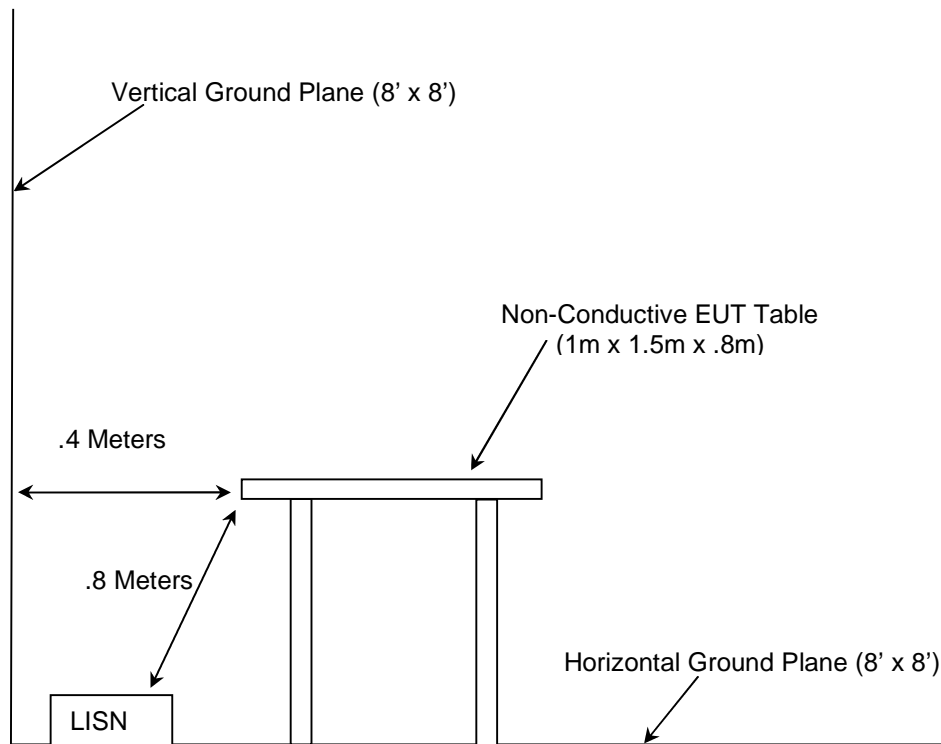

Figure 2.4-1: AC Mains Conducted EMI Site

3 APPLICABLE STANDARD REFERENCES

The following standards were used:

- ❖ ANSI C63.4-2003: Method of Measurements of Radio-Noise Emissions from Low-Voltage Electrical and Electronic Equipment in the 9KHz to 40GHz
- ❖ ANSI C63.10-2009: American National Standard for Testing Unlicensed Wireless Devices
- ❖ US Code of Federal Regulations (CFR): Title 47, Part 2, Subpart J: Equipment Authorization Procedures, 2013
- ❖ US Code of Federal Regulations (CFR): Title 47, Part 15, Subpart C: Radio Frequency Devices, Intentional Radiators, 2013
- ❖ Industry Canada Radio Standards Specification: RSS-210 - Low-power License-exempt Radiocommunication Devices (All Frequency Bands): Category I Equipment, Issue 8, December 2010
- ❖ Industry Canada Radio Standards Specification: RSS-GEN – General Requirements and Information for the Certification of Radiocommunication Equipment, Issue 3, December 2010.

4 LIST OF TEST EQUIPMENT

The calibration interval of test equipment is annually or the manufacturer's recommendations. Where the calibration interval deviates from the annual cycle based on the instrument manufacturer's recommendations, it shall be stated below.

Table 4-1: Test Equipment

AssetID	Manufacturer	Model #	Equipment Type	Serial #	Last Calibration Date	Calibration Due Date
1	Rohde & Schwarz	ESMI - Display	Spectrum Analyzers	833771/007	8/2/2012	8/2/2014
2	Rohde & Schwarz	ESMI-Receiver	Spectrum Analyzers	839587/003	8/2/2012	8/2/2014
30	Spectrum Technologies	DRH-0118	Antennas	970102	4/23/2013	4/23/2015
40	EMCO	3104	Antennas	3211	2/14/2013	2/14/2015
73	Agilent	8447D	Amplifiers	2727A05624	7/16/2013	7/16/2014
153	EMCO	3825/2	LISN	9411-2268	7/31/2012	7/31/2014
167	ACS	Chamber EMI Cable Set	Cable Set	167	12/17/2012	12/17/2013
168	Hewlett Packard	11947A	Attenuators	44829	2/1/2013	2/1/2014
267	Agilent	N1911A	Meters	MY45100129	1/23/2012	1/23/2014
268	Agilent	N1921A	Sensors	MY45240184	1/17/2012	1/17/2014
283	Rohde & Schwarz	FSP40	Spectrum Analyzers	1000033	7/30/2013	7/30/2015
291	Florida RF Cables	SMRE-200W-12.0-SMRE	Cables	None	11/20/2012	11/20/2013
292	Florida RF Cables	SMR-290AW-480.0-SMR	Cables	None	3/26/2013	3/26/2014
324	ACS	Belden	Cables	8214	6/17/2013	6/17/2014
334	Rohde&Schwarz	3160-09	Antennas	49404	11/4/2010	NCR
335	Suhner	SF-102A	Cables	882/2A	7/29/2013	7/29/2014
338	Hewlett Packard	8449B	Amplifiers	3008A01111	7/30/2013	7/30/2015
340	Aeroflex/Weinschel	AS-20	Attenuators	7136	7/30/2013	7/30/2014
345	Suhner Sucoflex	102A	Cables	1077/2A	7/29/2013	7/29/2014
412	Electro Metrics	LPA-25	Antennas	1241	7/27/2012	7/27/2014
422	Florida RF	SMS-200AW-72.0-SMR	Cables	805	11/20/2012	11/20/2013
432	Microwave Circuits	H3G020G4	Filters	264066	6/19/2013	6/19/2014
RE90	Agilent	E7404A	Analyzers	US40240143	11/28/2012	11/28/2013

5 SUPPORT EQUIPMENT

Table 5-1: Support Equipment

Item	Equipment Type	Manufacturer	Model Number	Serial Number
1	Laptop Computer	Dell	D410	N/A
2	Laptop Power Supply	Dell	PA-1900-02D	CN-09T215-71615-417-05A0
3	Ethernet Hub	Netgear	GS105 v3	27310A3406D01
4	DC Power Supply	Bestec	EA0121WAA	10G030813

6 EQUIPMENT UNDER TEST SETUP BLOCK DIAGRAM

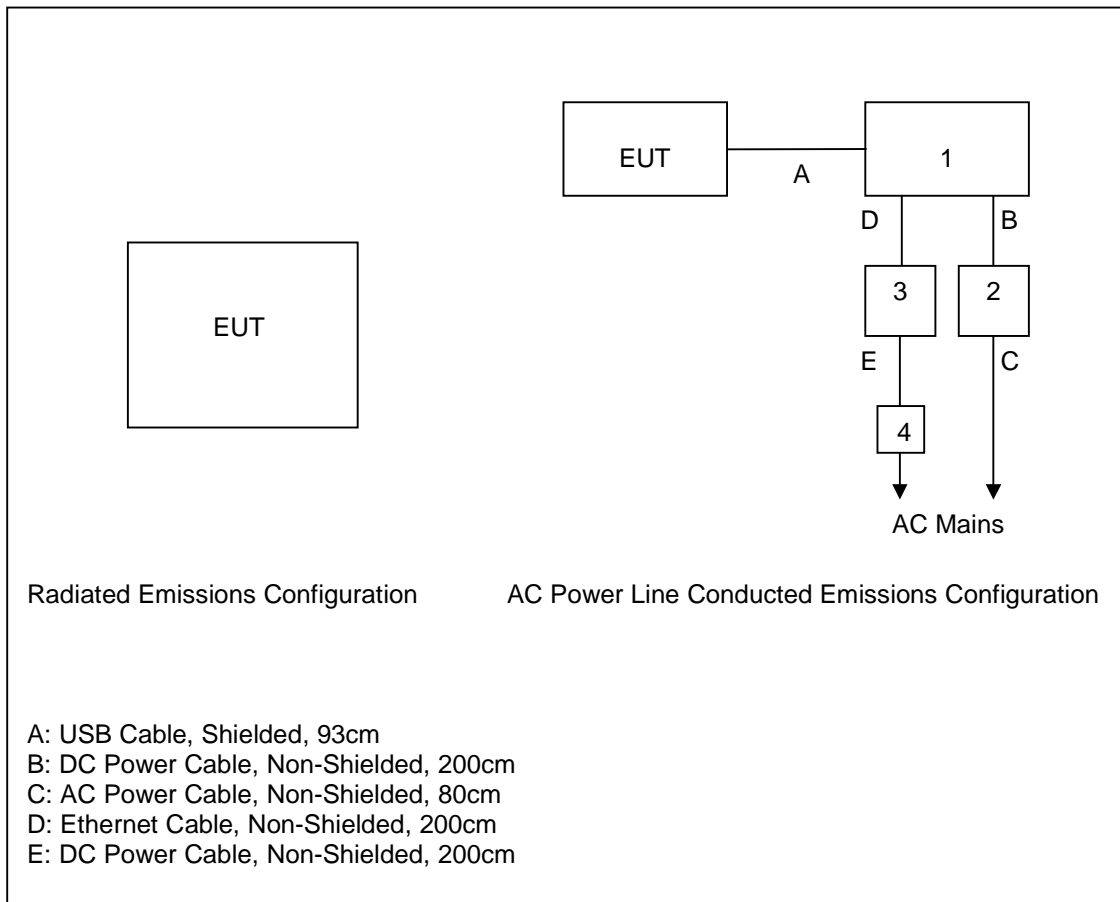

Figure 6-1: Test Setup Block Diagram

7 SUMMARY OF TESTS

Along with the tabular data shown below, plots were taken of all signals deemed important enough to document.

7.1 Antenna Requirement – FCC 15.203

The antenna used is an integral chip antenna with 1.3 dBi gain, which therefore meets the requirements of Section 15.203.

7.2 Power Line Conducted Emissions – FCC 15.207; IC RSS-Gen 7.2.4

7.2.1 Measurement Procedure

ANSI C63.4 sections 6 and 7 were the guiding documents for this evaluation. Conducted emissions were performed from 150kHz to 30MHz with the spectrum analyzer’s resolution bandwidth set to 9kHz and the video bandwidth set to 30kHz. The calculation for the conducted emissions is as follows:

Corrected Reading = Analyzer Reading + LISN Loss + Cable Loss
Margin = Applicable Limit - Corrected Reading

7.2.2 Measurement Results

Results of the test are shown below in Tables 7.2.2-1 and 7.2.2-2.

Table 7.2.2-1: Conducted EMI Results Line 1

Frequency (MHz)	Uncorrected Reading		Total Correction Factor (dB)	Corrected Level		Limit		Margin (dB)	
	Quasi-Peak	Average		Quasi-Peak	Average	Quasi-Peak	Average	Quasi-Peak	Average
0.637356	26.984	16.942	10.026	37.01	26.968	56	46	18.99	19.032
0.621074	29.627	20.205	10.011	39.637	30.216	56	46	16.363	15.784
0.48415	29.805	15.764	9.989	39.794	25.753	56.453	46.453	16.659	20.699
0.311024	29.57	27.412	9.994	39.563	37.406	61.399	51.399	21.836	13.993
0.206444	33.002	23.587	10.101	43.103	33.688	64.387	54.387	21.285	20.7
0.150016	37.1	23.144	10.182	47.282	33.326	66	56	18.718	22.674

Table 7.2.2-2: Conducted EMI Results Line 2

Frequency (MHz)	Uncorrected Reading		Total Correction Factor (dB)	Corrected Level		Limit		Margin (dB)	
	Quasi-Peak	Average		Quasi-Peak	Average	Quasi-Peak	Average	Quasi-Peak	Average
0.617825	32.209	21.101	10.008	42.216	31.109	56	46	13.784	14.891
0.480499	32.481	17.841	9.989	42.47	27.83	56.557	46.557	14.087	18.727
0.459605	33.162	19.906	9.989	43.151	29.896	57.154	47.154	14.003	17.258
0.423431	32.684	22.608	9.989	42.673	32.597	58.188	48.188	15.515	15.591
0.270631	34.017	28.363	10.026	44.043	38.389	62.553	52.553	18.51	14.164
0.212481	36.892	26.54	10.094	46.985	36.634	64.215	54.215	17.229	17.581

7.3 20dB / 99% Bandwidth – FCC 15.215; IC RSS-Gen 4.6**7.3.1 Measurement Procedure**

The span of the spectrum analyzer display was set between two times and five times the occupied bandwidth (OBW) of the emission. The RBW of the spectrum analyzer was set to approximately 1 % to 5 % of the OBW. The trace was set to max hold with a peak detector active. The Delta function of the analyzer was utilized to determine the 20 dB bandwidth of the emission.

The occupied bandwidth measurement function of the analyzer was used for the 99% bandwidth. The span of the analyzer shall be set to capture all products of the modulation process, including the emission skirts. The resolution bandwidth shall be set to as close to 1% of the selected span as is possible without being below 1%. The video bandwidth shall be set to 3 times the resolution bandwidth. A sampling detector was used.

7.3.2 Measurement Results

Results are shown below in Table 7.3.2-1 and Figures 7.3.2-1 to 7.3.2-18.

Table 7.3.2-1: 20dB / 99% Bandwidth

Frequency (MHz)	20dB Bandwidth (kHz)	99% Bandwidth (kHz)	Modulation	Data Rate (Mbps)
2402	867.0	849.0	GFSK	1
2441	873.0	841.5		
2480	867.0	853.5		
2402	1260.0	1195.5	$\pi/4$ -DQPSK	2
2441	1183.5	1177.5		
2480	1198.5	1174.5		
2402	1212.0	1146.0	8DPSK	3
2441	1194.0	1149.0		
2480	1188.0	1140.0		

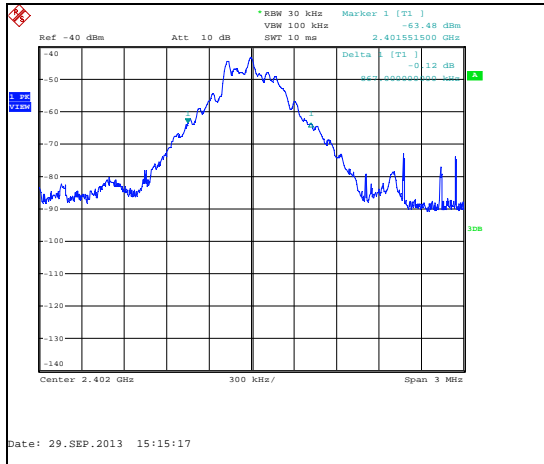

Figure 7.3.2-1: 20dB BW Low CH (GFSK - 1Mbps)

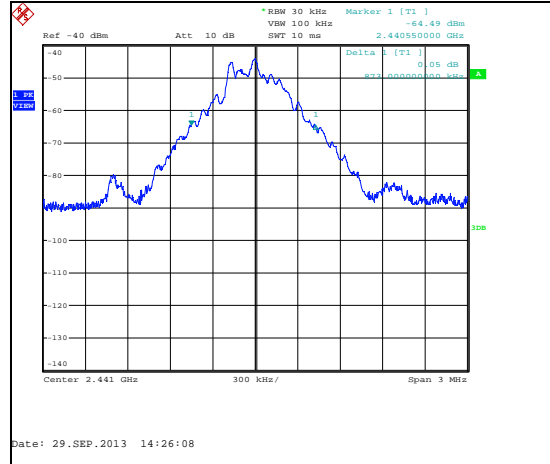

Figure 7.3.2-2: 20dB BW Mid CH (GFSK - 1Mbps)

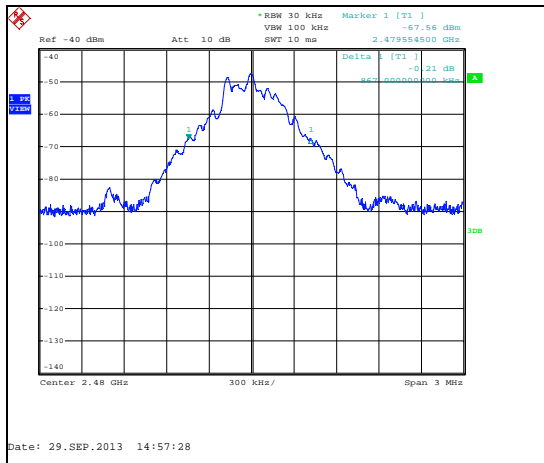

Figure 7.3.2-3: 20dB BW High CH (GFSK - 1Mbps)

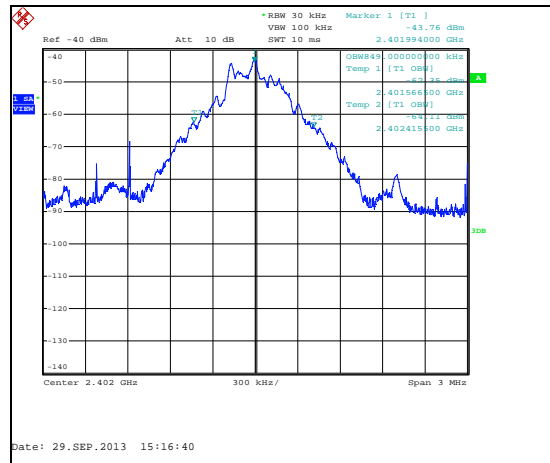

Figure 7.3.2-4: 99% OBW Low CH (GFSK - 1Mbps)

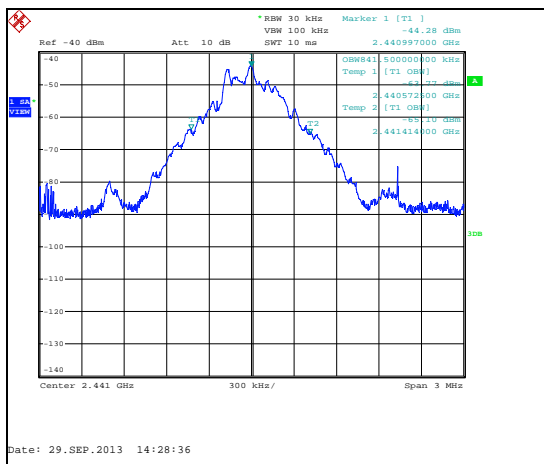

Figure 7.3.2-5: 99% OBW Mid CH (GFSK - 1Mbps)

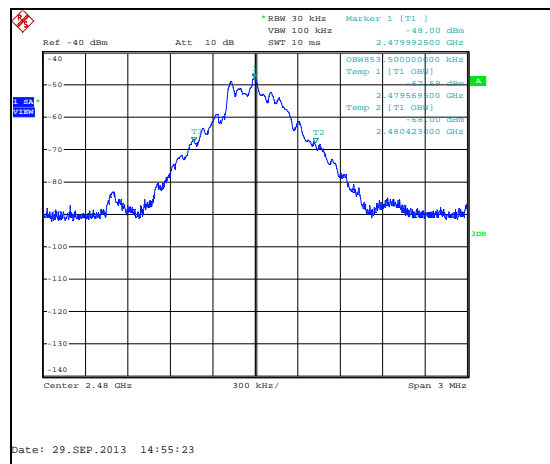

Figure 7.3.2-6: 99% OBW High CH (GFSK - 1Mbps)

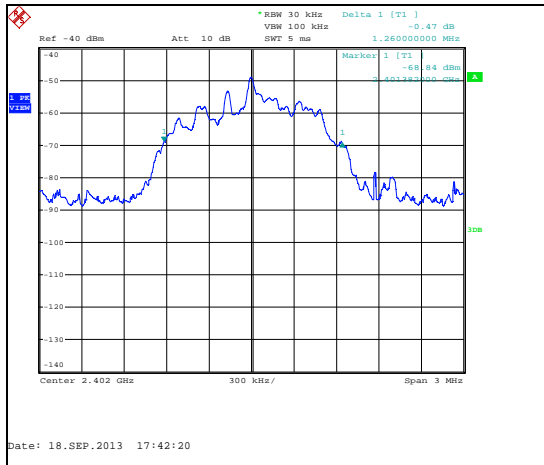

Figure 7.3.2-7: 20dB BW Low CH ($\pi/4$ DQPSK - 2Mbps)

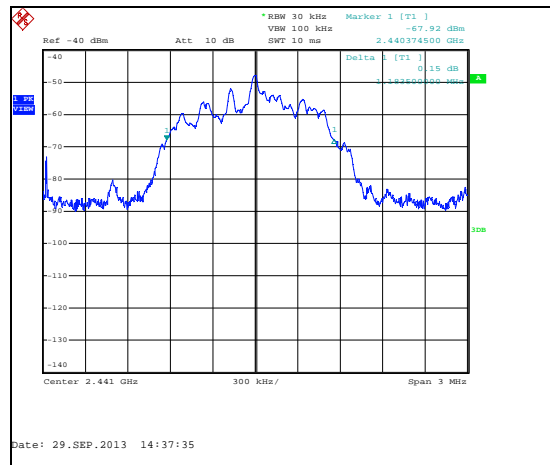

Figure 7.3.2-8: 20dB BW Mid CH ($\pi/4$ DQPSK - 2Mbps)

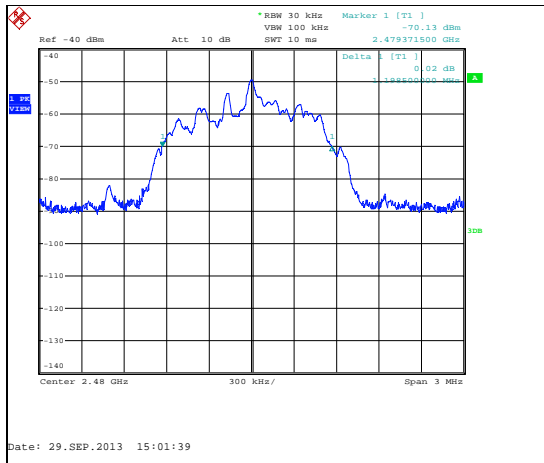

Figure 7.3.2-9: 20dB BW High CH ($\pi/4$ DQPSK - 2Mbps)

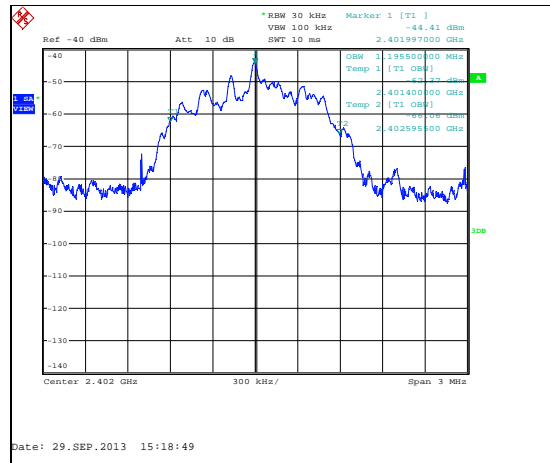

Figure 7.3.2-10: 99% OBW Low CH ($\pi/4$ DQPSK - 2Mbps)

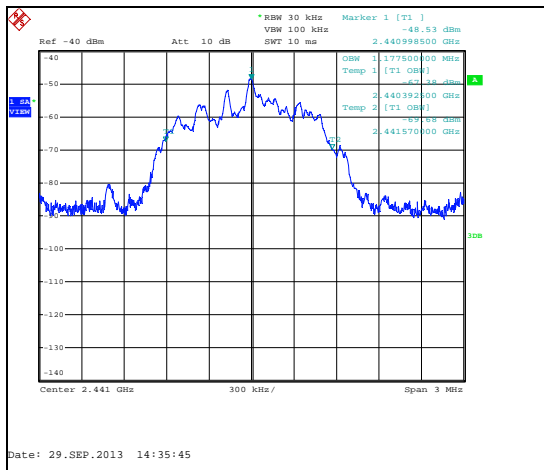

Figure 7.3.2-11: 99% OBW Mid CH ($\pi/4$ DQPSK - 2Mbps)

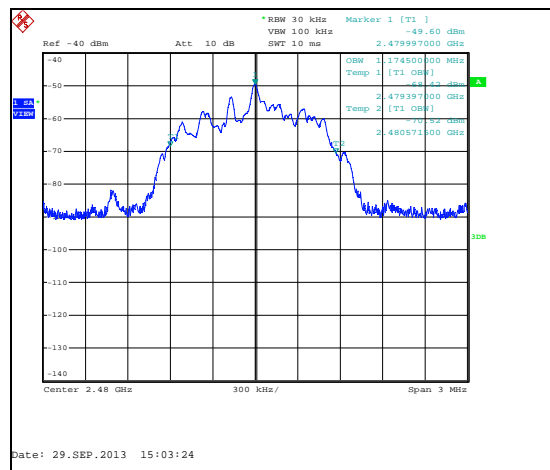

Figure 7.3.2-12: 99% OBW High CH ($\pi/4$ DQPSK - 2Mbps)

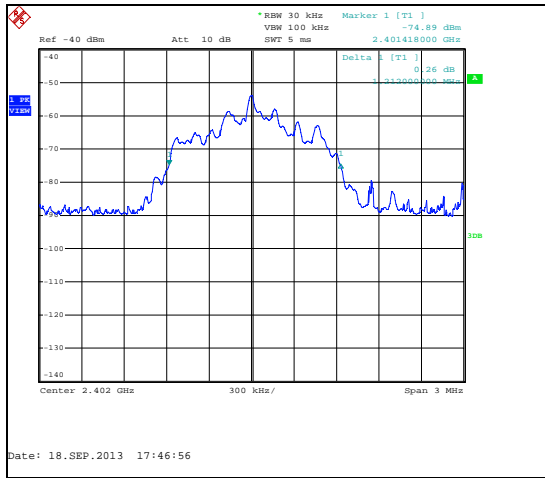

Figure 7.3.2-13: 20dB BW Low CH (8DPSK - 3Mbps)

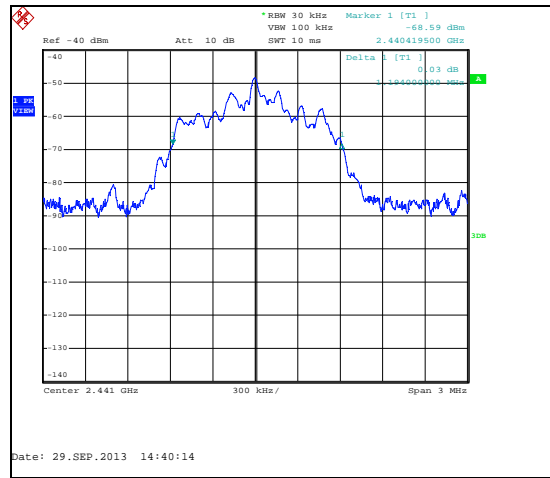

Figure 7.3.2-14: 20dB BW Mid CH (8DPSK - 3Mbps)

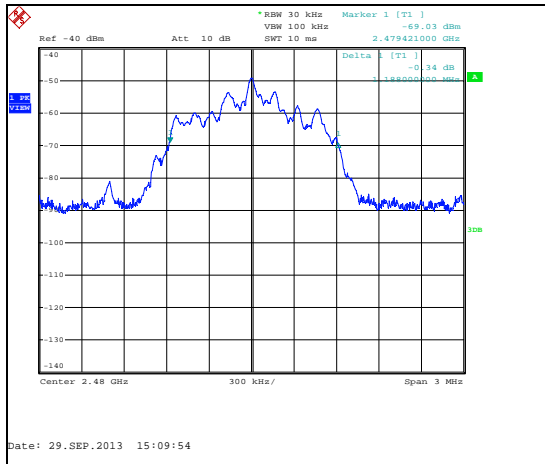

Figure 7.3.2-15: 20dB BW High CH (8DPSK - 3Mbps)

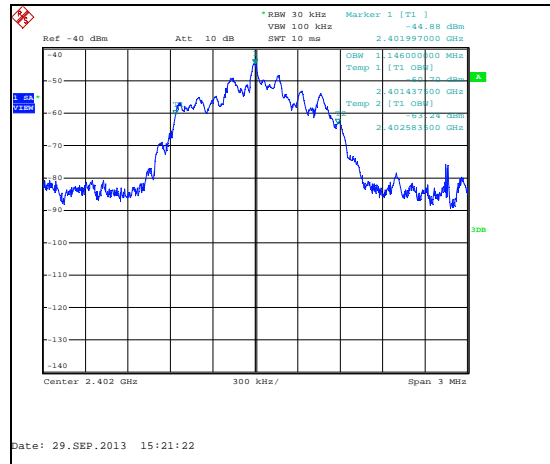

Figure 7.3.2-16: 99% OBW Low CH (8DPSK - 3Mbps)

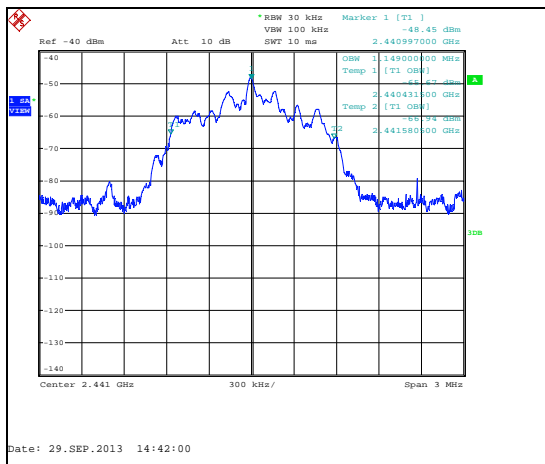

Figure 7.3.2-17: 99% OBW Mid CH (8DPSK - 3Mbps)

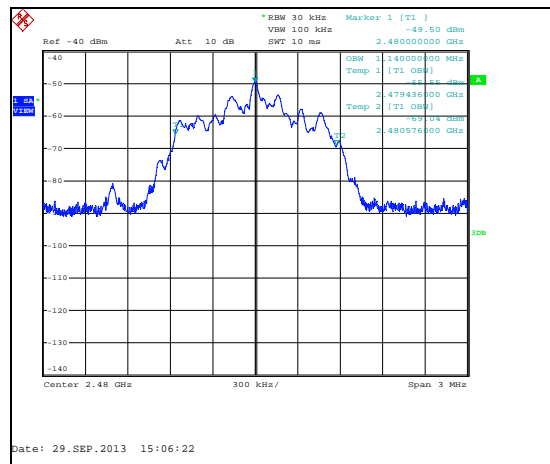

Figure 7.3.2-18: 99% OBW High CH (8DPSK - 3Mbps)

7.4 Fundamental Field Strength – FCC 15.249(a); IC RSS-210 A2.9(a)

7.4.1 Measurement Procedure

The EUT was rotated through 360° and the receive antenna height was varied from 1m to 4m so that the maximum radiated emissions level would be detected. Peak and average measurements were made with RBW and VBW of 3 MHz and 10 MHz respectively.

7.4.2 Measurement Results

Results are shown below in Tables 7.4.2-1 to 7.4.2-3.

Table 7.4.2-1: Fundamental Field Strength (GFSK - 1Mbps)

Frequency (MHz)	Level (dBuV)		Antenna Polarity (H/V)	Correction Factors (dB)	Corrected Level (dBuV/m)		Limit (dBuV/m)		Margin (dB)	
	pk	Qpk/Avg			pk	Qpk/Avg	pk	Qpk/Avg	pk	Qpk/Avg
2402	91.95	87.08	H	-6.38	85.57	80.70	114.0	94.0	28.4	13.3
2402	86.17	81.02	V	-6.38	79.79	74.64	114.0	94.0	34.2	19.3
2441	90.43	85.78	H	-6.17	84.26	79.61	114.0	94.0	29.7	14.4
2441	84.19	79.34	V	-6.17	78.02	73.17	114.0	94.0	36.0	20.8
2480	87.07	82.43	H	-5.96	81.11	76.47	114.0	94.0	32.9	17.5
2480	79.79	74.41	V	-5.96	73.83	68.45	114.0	94.0	40.2	25.5

Table 7.4.2-2: Fundamental Field Strength (π/4 DQPSK - 2Mbps)

Frequency (MHz)	Level (dBuV)		Antenna Polarity (H/V)	Correction Factors (dB)	Corrected Level (dBuV/m)		Limit (dBuV/m)		Margin (dB)	
	pk	Qpk/Avg			pk	Qpk/Avg	pk	Qpk/Avg	pk	Qpk/Avg
2402	90.21	81.49	H	-6.38	83.83	75.11	114.0	94.0	30.2	18.9
2402	84.82	76.24	V	-6.38	78.44	69.86	114.0	94.0	35.6	24.1
2441	89.59	81.49	H	-6.17	83.42	75.32	114.0	94.0	30.6	18.7
2441	82.56	74.21	V	-6.17	76.39	68.04	114.0	94.0	37.6	25.9
2480	85.35	77.38	H	-5.96	79.39	71.42	114.0	94.0	34.6	22.6
2480	78.73	70.15	V	-5.96	72.77	64.19	114.0	94.0	41.2	29.8

Table 7.4.2-3: Fundamental Field Strength (8DPSK - 3Mbps)

Frequency (MHz)	Level (dBuV)		Antenna Polarity (H/V)	Correction Factors (dB)	Corrected Level (dBuV/m)		Limit (dBuV/m)		Margin (dB)	
	pk	Qpk/Avg			pk	Qpk/Avg	pk	Qpk/Avg	pk	Qpk/Avg
2402	91.57	82.30	H	-6.38	85.19	75.92	114.0	94.0	28.8	18.1
2402	85.31	75.76	V	-6.38	78.93	69.38	114.0	94.0	35.1	24.6
2441	89.74	80.52	H	-6.17	83.57	74.35	114.0	94.0	30.4	19.6
2441	82.79	73.40	V	-6.17	76.62	67.23	114.0	94.0	37.4	26.8
2480	85.57	76.23	H	-5.96	79.61	70.27	114.0	94.0	34.4	23.7
2480	78.37	69.13	V	-5.96	72.41	63.17	114.0	94.0	41.6	30.8

7.5 Radiated Spurious Emissions – FCC 15.249(a)(d)(e); IC RSS-210 A2.9(a)(b)**7.5.1 Measurement Procedure**

Radiated emissions tests were made over the frequency range of 30MHz to 25 GHz, 10 times the highest fundamental frequency.

The EUT was rotated through 360° and the receive antenna height was varied from 1m to 4m so that the maximum radiated emissions level would be detected. For frequencies below 1000MHz, quasi-peak measurements were made using a resolution bandwidth RBW of 120 kHz and a video bandwidth VBW of 300 kHz. For frequencies above 1000MHz, peak and average measurements were made with RBW and VBW of 1 MHz and 3MHz respectively. The average emissions were further corrected by applying the duty cycle correction of the EUT for comparison to the average limit.

Radiated emissions were evaluated for all modulations and data rates.

All out of band emissions were evaluated, including any emissions at or near the band-edge.

7.5.2 Duty Cycle Correction

For average radiated measurements, using a 6.25% duty cycle, the measured level was reduced by a factor 24.08dB. The duty cycle correction factor is determined using the formula: $20\log(6.25/100)$.

A detail explanation of the duty cycle is provided in the theory of operation accompanying this report.

7.5.3 Measurement Results

Radiated spurious emissions are reported in the table 7.5.3-1 to 7.5.3-3 below.

Table 7.5.3-1: Radiated Spurious Emissions Tabulated Data (GFSK - 1Mbps)

Frequency (MHz)	Level (dBuV)		Antenna Polarity (H/V)	Correction Factors (dB)	Corrected Level (dBuV/m)		Limit (dBuV/m)		Margin (dB)	
	pk	Qpk/Avg			pk	Qpk/Avg	pk	Qpk/Avg	pk	Qpk/Avg
2402 MHz (Low Channel)										
4804	58.17	47.85	H	1.41	59.58	25.18	74.0	54.0	14.4	28.8
4804	57.23	46.46	V	1.41	58.64	23.79	74.0	54.0	15.4	30.2
2400	58.42	43.38	H	-6.40	52.02	12.90	74.0	54.0	22.0	41.1
2400	55.18	39.07	V	-6.40	48.78	8.59	74.0	54.0	25.2	45.4
1601.9	53.44	43.56	H	-10.68	42.76	8.80	74.0	54.0	31.2	45.2
1601.9	55.09	44.75	V	-10.68	44.41	9.99	74.0	54.0	29.6	44.0
2441 MHz (Middle Channel)										
4882	57.10	44.53	H	1.54	58.64	21.99	74.0	54.0	15.4	32.0
4882	54.52	41.81	V	1.54	56.06	19.27	74.0	54.0	17.9	34.7
1626.6	52.34	41.20	V	-10.55	41.79	6.57	74.0	54.0	32.2	47.4
2480 MHz (High Channel)										
4960	60.47	50.47	H	1.67	62.14	28.06	74.0	54.0	11.9	25.9
4960	54.41	44.96	V	1.67	56.08	22.55	74.0	54.0	17.9	31.4
2483.5	46.57	34.73	H	-5.94	40.63	4.71	74.0	54.0	33.4	49.3
2483.5	46.27	34.52	V	-5.94	40.33	4.50	74.0	54.0	33.7	49.5
1652.6	52.34	43.56	V	-10.41	41.93	9.07	74.0	54.0	32.1	44.9

Table 7.5.3-2: Radiated Spurious Emissions Tabulated Data ($\pi/4$ DQPSK - 2Mbps)

Frequency (MHz)	Level (dBuV)		Antenna Polarity (H/V)	Correction Factors (dB)	Corrected Level (dBuV/m)		Limit (dBuV/m)		Margin (dB)	
	pk	Qpk/Avg			pk	Qpk/Avg	pk	Qpk/Avg	pk	Qpk/Avg
2402 MHz (Low Channel)										
4804	55.15	41.56	H	1.41	56.56	18.89	74.0	54.0	17.4	35.1
4804	52.64	38.86	V	1.41	54.05	16.19	74.0	54.0	20.0	37.8
2400	62.13	41.87	H	-6.40	55.73	11.39	74.0	54.0	18.3	42.6
2400	57.35	38.23	V	-6.40	50.95	7.75	74.0	54.0	23.0	46.2
1601.9	54.20	45.19	H	-10.68	43.52	10.43	74.0	54.0	30.5	43.6
1601.9	56.71	47.17	V	-10.68	46.03	12.41	74.0	54.0	28.0	41.6
2441 MHz (Middle Channel)										
4882	54.86	40.36	H	1.54	56.40	17.82	74.0	54.0	17.6	36.2
4882	51.62	37.24	V	1.54	53.16	14.70	74.0	54.0	20.8	39.3
1626.5	53.87	43.31	H	-10.55	43.32	8.68	74.0	54.0	30.7	45.3
1626.5	55.36	45.14	V	-10.55	44.81	10.51	74.0	54.0	29.2	43.5
2480 MHz (High Channel)										
4960	55.61	41.33	H	1.67	57.28	18.92	74.0	54.0	16.7	35.1
4960	50.92	37.14	V	1.67	52.59	14.73	74.0	54.0	21.4	39.3
2483.5	46.32	34.57	H	-5.94	40.38	4.55	74.0	54.0	33.6	49.5
2483.5	46.68	34.37	V	-5.94	40.74	4.35	74.0	54.0	33.3	49.7
1652.6	51.35	41.77	H	-10.41	40.94	7.28	74.0	54.0	33.1	46.7
1652.6	52.87	42.57	V	-10.41	42.46	8.08	74.0	54.0	31.5	45.9

Table 7.5.3-3: Radiated Spurious Emissions Tabulated Data (8DPSK - 3Mbps)

Frequency (MHz)	Level (dBuV)		Antenna Polarity (H/V)	Correction Factors (dB)	Corrected Level (dBuV/m)		Limit (dBuV/m)		Margin (dB)	
	pk	Qpk/Avg			pk	Qpk/Avg	pk	Qpk/Avg	pk	Qpk/Avg
2402 MHz (Low Channel)										
4804	55.33	41.28	H	1.41	56.74	18.61	74.0	54.0	17.3	35.4
4804	51.72	38.46	V	1.41	53.13	15.79	74.0	54.0	20.9	38.2
2400	63.41	42.34	H	-6.40	57.01	11.86	74.0	54.0	17.0	42.1
2400	57.70	38.41	V	-6.40	51.30	7.93	74.0	54.0	22.7	46.1
1601.9	54.36	44.20	H	-10.68	43.68	9.44	74.0	54.0	30.3	44.6
1601.9	56.40	45.85	V	-10.68	45.72	11.09	74.0	54.0	28.3	42.9
2441 MHz (Middle Channel)										
4882	54.78	40.31	H	1.54	56.32	17.77	74.0	54.0	17.7	36.2
4882	50.91	37.37	V	1.54	52.45	14.83	74.0	54.0	21.5	39.2
1626.5	51.92	40.80	H	-10.55	41.37	6.17	74.0	54.0	32.6	47.8
1626.5	55.30	43.87	V	-10.55	44.75	9.24	74.0	54.0	29.3	44.8
2480 MHz (High Channel)										
4960	55.62	41.05	H	1.67	57.29	18.64	74.0	54.0	16.7	35.4
4960	50.83	36.88	V	1.67	52.50	14.47	74.0	54.0	21.5	39.5
2483.5	46.57	34.57	H	-5.94	40.63	4.55	74.0	54.0	33.4	49.5
2483.5	46.65	34.40	V	-5.94	40.71	4.38	74.0	54.0	33.3	49.6
1652.6	51.21	41.23	H	-10.41	40.80	6.74	74.0	54.0	33.2	47.3
1652.6	52.43	41.96	V	-10.41	42.02	7.47	74.0	54.0	32.0	46.5

7.5.4 Sample Calculation:

$$R_c = R_u + CF_T$$

Where:

- CF_T = Total Correction Factor (AF+CA+AG)-DC (Average Measurements Only)
- R_u = Uncorrected Reading
- R_c = Corrected Level
- AF = Antenna Factor
- CA = Cable Attenuation
- AG = Amplifier Gain
- DC = Duty Cycle Correction Factor

Example Calculation: Peak (GFSK - 1Mbps) ZPOS

Corrected Level: 58.17 + 1.41 = 59.58dBuV

Margin: 74dBuV – 59.58dBuV = 14.4dB

Example Calculation: Average (GFSK - 1Mbps) ZPOS

Corrected Level: 47.85 + 1.41 - 24.08 = 25.18dBuV

Margin: 54dBuV – 25.18dBuV = 28.8dB

8 CONCLUSION

In the opinion of ACS, Inc. the 13253-000, manufactured by Neptune Technology Group, Inc. meets the requirements of FCC Part 15 subpart C and Industry Canada’s Radio Standards Specification RSS-210.

END REPORT