

FCC Test Report

Report No.: RF150903D01-1

FCC ID: P27XW3

Test Model: XW3

Series Model: XW3xxx (“xxx” could be 0 to 9, A to Z, “blank”, for marking purpose)

Received Date: Sep. 3, 2015

Test Date: Sep. 14 ~ 17, 2015

Issued Date: Sep. 18, 2015

Applicant: Sercomm Corp.

Address: 8F, No. 3-1, YuangQu St., NanKang, Taipei 115, Taiwan, R.O.C. (NanKang Software Park)

Issued By: Bureau Veritas Consumer Products Services (H.K.) Ltd., Taoyuan Branch

Lab Address: No. 47-2, 14th Ling, Chia Pau Vil., Lin Kou Dist., New Taipei City, Taiwan (R.O.C.)



This report is for your exclusive use. Any copying or replication of this report to or for any other person or entity, or use of our name or trademark, is permitted only with our prior written permission. This report sets forth our findings solely with respect to the test samples identified herein. The results set forth in this report are not indicative or representative of the quality or characteristics of the lot from which a test sample was taken or any similar or identical product unless specifically and expressly noted. Our report includes all of the tests requested by you and the results thereof based upon the information that you provided to us. You have 60 days from date of issuance of this report to notify us of any material error or omission caused by our negligence, provided, however, that such notice shall be in writing and shall specifically address the issue you wish to raise. A failure to raise such issue within the prescribed time shall constitute your unqualified acceptance of the completeness of this report, the tests conducted and the correctness of the report contents. Unless specific mention, the uncertainty of measurement has been explicitly taken into account to declare the compliance or non-compliance to the specification. The report must not be used by the client to claim product certification, approval, or endorsement by TAF or any government agencies.

Table of Contents

Release Control Record	4
1 Certificate of Conformity	5
2 Summary of Test Results	6
2.1 Measurement Uncertainty.....	6
2.2 Modification Record.....	6
3 General Information	7
3.1 General Description of EUT.....	7
3.2 Description of Test Modes.....	8
3.2.1 Test Mode Applicability and Tested Channel Detail.....	9
3.3 Duty Cycle of Test Signal.....	11
3.4 Description of Support Units.....	12
3.4.1 Configuration of System under Test.....	12
3.5 General Description of Applied Standard.....	13
4 Test Types and Results	14
4.1 Radiated Emission and Bandedge Measurement.....	14
4.1.1 Limits of Radiated Emission and Bandedge Measurement.....	14
4.1.2 Test Instruments.....	15
4.1.3 Test Procedure.....	16
4.1.4 Deviation from Test Standard.....	16
4.1.5 Test Setup.....	17
4.1.6 EUT Operating Condition.....	17
4.1.7 Test Results.....	18
4.2 Conducted Emission Measurement.....	35
4.2.1 Limits of Conducted Emission Measurement.....	35
4.2.2 Test Instruments.....	35
4.2.3 Test Procedure.....	36
4.2.4 Deviation from Test Standard.....	36
4.2.5 Test Setup.....	36
4.2.6 EUT Operating Condition.....	36
4.2.7 Test Results.....	37
4.3 Transmit Power Measurement.....	39
4.3.1 Limits of Transmit Power Measurement.....	39
4.3.2 Test Setup.....	39
4.3.3 Test Instruments.....	39
4.3.4 Test Procedure.....	40
4.3.5 Deviation from Test Standard.....	40
4.3.6 EUT Operating Condition.....	40
4.3.7 Test Result.....	41
4.4 Peak Power Spectral Density Measurement.....	46
4.4.1 Limits of Peak Power Spectral Density Measurement.....	46
4.4.2 Test Setup.....	46
4.4.3 Test Instruments.....	46
4.4.4 Test Procedure.....	46
4.4.5 Deviation from Test Standard.....	47
4.4.6 EUT Operating Condition.....	47
4.4.7 Test Results.....	48
4.5 Frequency Stability Measurement.....	52
4.5.1 Limits of Frequency Stability Measurement.....	52
4.5.2 Test Setup.....	52
4.5.3 Test Instruments.....	52
4.5.4 Test Procedure.....	52
4.5.5 Deviation from Test Standard.....	52

4.5.6 EUT Operating Condition.....	52
4.5.7 Test Results.....	53
4.6 6dB Bandwidth Measurement.....	54
4.6.1 Limits of 6dB Bandwidth Measurement.....	54
4.6.2 Test Setup.....	54
4.6.3 Test Instruments.....	54
4.6.4 Test Procedure.....	54
4.6.5 Deviation from Test Standard.....	54
4.6.6 EUT Operating Condition.....	54
4.6.7 Test Results.....	55
5 Pictures of Test Arrangements.....	57
Appendix – Information on the Testing Laboratories.....	58



Release Control Record

Issue No.	Description	Date Issued
RF150903D01-1	Original release.	Sep. 18, 2015

1 Certificate of Conformity

Product: WiFi Adapter

Brand: Sercomm; Xfinity

Test Model: XW3

Series Model: XW3xxx (“xxx” could be 0 to 9, A to Z, “blank” , for marking purpose)

Sample Status: Engineering sample

Applicant: Sercomm Corp.

Test Date: Sep. 14 ~ 17, 2015

Standard: 47 CFR FCC Part 15, Subpart E (Section 15.407)
ANSI C63.10: 2013

The above equipment has been tested by **Bureau Veritas Consumer Products Services (H.K.) Ltd., Taoyuan Branch**, and found compliance with the requirement of the above standards. The test record, data evaluation & Equipment Under Test (EUT) configurations represented herein are true and accurate accounts of the measurements of the sample’s EMC characteristics under the conditions specified in this report.

Prepared by : Celia Chen , **Date:** Sep. 18, 2015
Celia Chen / Senior Specialist

Approved by : Rex Lai , **Date:** Sep. 18, 2015
Rex Lai / Assistant Manager

2 Summary of Test Results

47 CFR FCC Part 15, Subpart E (SECTION 15.407)			
FCC Clause	Test Item	Result	Remarks
15.407(b)(6)	AC Power Conducted Emissions	PASS	Meet the requirement of limit. Minimum passing margin is -21.05dB at 4.61719MHz.
15.407(b)(1/2/3/4/6)	Radiated Emissions & Band Edge Measurement	PASS	Meet the requirement of limit. Minimum passing margin is -1.0dB at 5725.00MHz.
15.407(a)(1/2/3)	Max Average Transmit Power	PASS	Meet the requirement of limit.
15.407(a)(1/2/3)	Peak Power Spectral Density	PASS	Meet the requirement of limit.
15.407(e)	6dB bandwidth	PASS	Meet the requirement of limit. (U-NII-3 Band only)
15.407(g)	Frequency Stability	PASS	Meet the requirement of limit.
15.203	Antenna Requirement	PASS	No antenna connector is used.

2.1 Measurement Uncertainty

Where relevant, the following measurement uncertainty levels have been estimated for tests performed on the EUT as specified in CISPR 16-4-2:

Measurement	Frequency	Expanded Uncertainty (k=2) (\pm)
Conducted Emissions at mains ports	150kHz ~ 30MHz	3.43 dB
Radiated Emissions up to 1 GHz	30MHz ~ 1000MHz	4.00 dB
Radiated Emissions above 1 GHz	1GHz ~ 40GHz	3.36 dB

2.2 Modification Record

There were no modifications required for compliance.

3 General Information

3.1 General Description of EUT

Product	WiFi Adapter
Brand	Sercomm; Xfinity
Test Model	XW3
Series Model	XW3xxx (“xxx” could be 0 to 9, A to Z, “blank” , for marking purpose)
Model Difference	For marking purpose
Status of EUT	Engineering sample
Power Supply Rating	AC I/P: 100-240 V, 50-60 Hz DC O/P: 12V, 350mA
Modulation Type	64QAM, 16QAM, QPSK, BPSK
Modulation Technology	OFDM
Transfer Rate	802.11a: 54/48/36/24/18/12/9/6Mbps 802.11n: up to 300Mbps
Operating Frequency	5180 ~ 5240MHz 5745 ~ 5825MHz
Number of Channel	5180 ~ 5240MHz 4 for 802.11a, 802.11n (HT20) 2 for 802.11n (HT40) 5745 ~ 5825MHz 5 for 802.11a, 802.11n (HT20) 2 for 802.11n (HT40)
Output Power	5180 ~ 5240MHz 158.926 mW 5745 ~ 5825MHz 67.162mW
Antenna Type	Printed antenna with 3.60dBi gain
Antenna Connector	N/A
Accessory Device	N/A
Data Cable Supplied	N/A

Note:

- The EUT incorporates a MIMO function. Physically, the EUT provides two completed transmitters and two receivers.

Modulation Mode	TX FUNCTION
802.11a	2TX
802.11n (HT20)	2TX
802.11n (HT40)	2TX

- The above EUT information is declared by manufacturer and for more detailed features description, please refer to the manufacturer's specifications or user's manual.

3.2 Description of Test Modes

FOR 5180 ~ 5240MHz

4 channels are provided for 802.11a, 802.11n (HT20):

Channel	Frequency	Channel	Frequency
36	5180 MHz	44	5220 MHz
40	5200 MHz	48	5240 MHz

2 channels are provided for 802.11n (HT40):

Channel	Frequency	Channel	Frequency
38	5190 MHz	46	5230 MHz

FOR 5745 ~ 5825MHz:

5 channels are provided for 802.11a, 802.11n (HT20):

Channel	Frequency	Channel	Frequency
149	5745MHz	161	5805MHz
153	5765MHz	165	5825MHz
157	5785MHz		

2 channels are provided for 802.11n (HT40):

Channel	Frequency	Channel	Frequency
151	5755MHz	159	5795MHz

3.2.1 Test Mode Applicability and Tested Channel Detail

EUT CONFIGURE MODE	APPLICABLE TO				DESCRIPTION
	RE ³ 1G	RE<1G	PLC	APCM	
-	√	√	√	√	-

Where **RE³1G**: Radiated Emission above 1GHz **RE<1G**: Radiated Emission below 1GHz
PLC: Power Line Conducted Emission **APCM**: Antenna Port Conducted Measurement

NOTE: The EUT had been pre-tested on the positioned of each 3 axis. The worst case was found when positioned on **Z-plane**.

Radiated Emission Test (Above 1GHz):

- Pre-Scan has been conducted to determine the worst-case mode from all possible combinations between available modulations, data rates and antenna ports (if EUT with antenna diversity architecture).
- Following channel(s) was (were) selected for the final test as listed below.

EUT CONFIGURE MODE	MODE	FREQ. BAND (MHz)	AVAILABLE CHANNEL	TESTED CHANNEL	MODULATION TECHNOLOGY	MODULATION TYPE	DATA RATE (Mbps)
-	802.11a	5180-5240	36 to 48	36, 40, 48	OFDM	BPSK	6.0
-	802.11n (HT20)		36 to 48	36, 40, 48	OFDM	BPSK	6.5
-	802.11n (HT40)		38 to 46	38, 46	OFDM	BPSK	13.5
-	802.11a	5745-5825	149 to 165	149, 157, 165	OFDM	BPSK	6.0
-	802.11n (HT20)		149 to 165	149, 157, 165	OFDM	BPSK	6.5
-	802.11n (HT40)		151 to 159	151, 159	OFDM	BPSK	13.5

Radiated Emission Test (Below 1GHz):

- Pre-Scan has been conducted to determine the worst-case mode from all possible combinations between available modulations, data rates and antenna ports (if EUT with antenna diversity architecture).
- Following channel(s) was (were) selected for the final test as listed below.

EUT CONFIGURE MODE	MODE	FREQ. BAND (MHz)	AVAILABLE CHANNEL	TESTED CHANNEL	MODULATION TECHNOLOGY	MODULATION TYPE	DATA RATE (Mbps)
-	802.11n (HT40)	5180-5240	38 to 46	46	OFDM	BPSK	13.5

Power Line Conducted Emission Test:

- Pre-Scan has been conducted to determine the worst-case mode from all possible combinations between available modulations, data rates and antenna ports (if EUT with antenna diversity architecture).
- Following channel(s) was (were) selected for the final test as listed below.

EUT CONFIGURE MODE	MODE	FREQ. BAND (MHz)	AVAILABLE CHANNEL	TESTED CHANNEL	MODULATION TECHNOLOGY	MODULATION TYPE	DATA RATE (Mbps)
-	802.11n (HT40)	5180-5240	38 to 46	46	OFDM	BPSK	13.5

Antenna Port Conducted Measurement:

- This item includes all test value of each mode, but only includes spectrum plot of worst value of each mode.
- Pre-Scan has been conducted to determine the worst-case mode from all possible combinations between available modulations, data rates and antenna ports (if EUT with antenna diversity architecture).
- Following channel(s) was (were) selected for the final test as listed below.

EUT CONFIGURE MODE	MODE	FREQ. BAND (MHz)	AVAILABLE CHANNEL	TESTED CHANNEL	MODULATION TECHNOLOGY	MODULATION TYPE	DATA RATE (Mbps)
-	802.11a	5180-5240	36 to 48	36, 40, 48	OFDM	BPSK	6.0
-	802.11n (HT20)		36 to 48	36, 40, 48	OFDM	BPSK	6.5
-	802.11n (HT40)		38 to 46	38, 46	OFDM	BPSK	13.5
-	802.11a	5745-5825	149 to 165	149, 157, 165	OFDM	BPSK	6.0
-	802.11n (HT20)		149 to 165	149, 157, 165	OFDM	BPSK	6.5
-	802.11n (HT40)		151 to 159	151, 159	OFDM	BPSK	13.5

Test Condition:

APPLICABLE TO	ENVIRONMENTAL CONDITIONS	INPUT POWER	TESTED BY
RE³1G	28deg. C, 69%RH	120Vac, 60Hz	Aaron You
RE<1G	28deg. C, 69%RH	120Vac, 60Hz	Aaron You
PLC	26deg. C, 77%RH	120Vac, 60Hz	Dalen Dai
APCM	25deg. C, 60%RH	120Vac, 60Hz	Saxon Lee

3.3 Duty Cycle of Test Signal

Duty cycle of test signal is < 98 %, duty factor is required

802.11a: Duty cycle = $1.384/1.586 = 0.873$, Duty factor = $10 * \log(1/0.873) = 0.59$

802.11n (HT20): Duty cycle = $1.289/1.442 = 0.894$, Duty factor = $10 * \log(1/0.894) = 0.49$

802.11n (HT40): Duty cycle = $0.608/0.768 = 0.792$, Duty factor = $10 * \log(1/0.792) = 1.01$

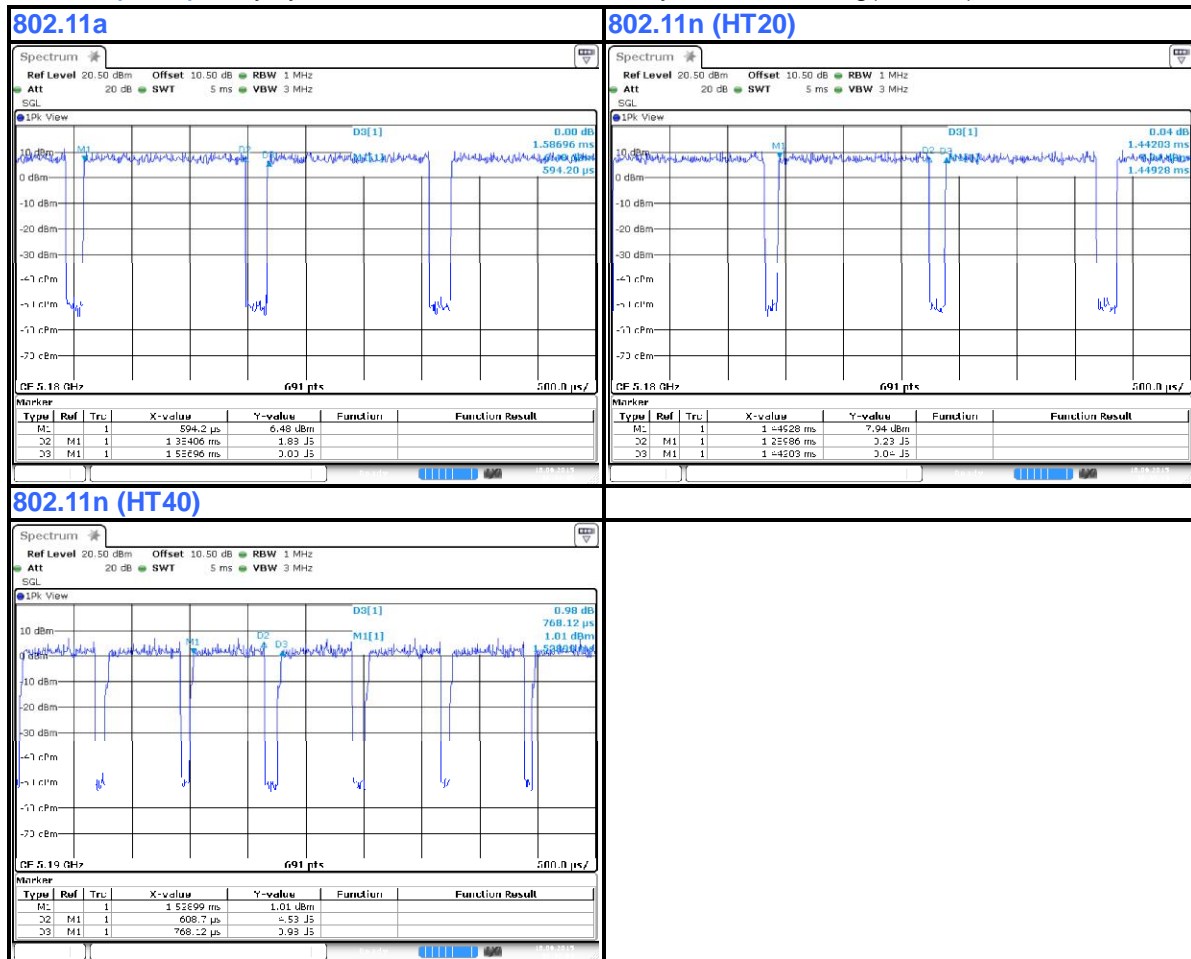

3.4 Description of Support Units

The EUT has been tested as an independent unit together with other necessary accessories or support units. The following support units or accessories were used to form a representative test configuration during the tests.

ID	Product	Brand	Model No.	Serial No.	FCC ID	Remarks
A.	EUT	Sercomm; Xfinity	XW3	-	-	-
B.	Notebook	DELL	E5410	BW33YM1	FCC DoC Approved	Provided by Lab

Note:

1. All power cords of the above support units are non-shielded (1.8m).
2. Item B acted as communication partners to transfer data.

ID	Descriptions	Qty.	Length (m)	Shielding (Yes/No)	Cores (Qty.)	Remarks
1.	LAN cable	1	10	N	0	Provided by Lab

Note: The core(s) is(are) originally attached to the cable(s).

3.4.1 Configuration of System under Test

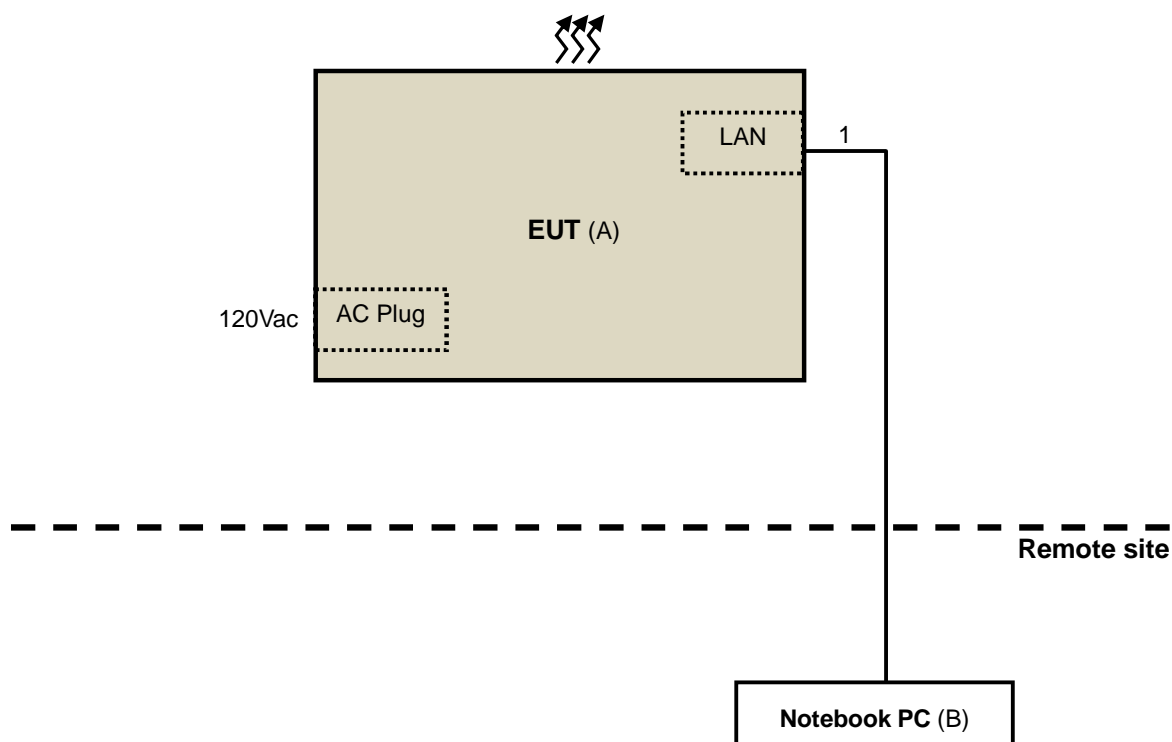

3.5 General Description of Applied Standard

The EUT is a RF Product. According to the specifications of the manufacturer, it must comply with the requirements of the following standards:

FCC Part 15, Subpart E (15.407)

789033 D02 General UNII Test Procedure New Rules v01

662911 D01 Multiple Transmitter Output v02r01

ANSI C63.10-2013

All test items have been performed and recorded as per the above standards.

NOTE: The EUT has been verified to comply with the requirements of FCC Part 15, Subpart B, Class B (DoC). The test report has been issued separately.

4 Test Types and Results

4.1 Radiated Emission and Bandedge Measurement

4.1.1 Limits of Radiated Emission and Bandedge Measurement

Radiated emissions which fall in the restricted bands must comply with the radiated emission limits specified as below table.

Frequencies (MHz)	Field Strength (microvolts/meter)	Measurement Distance (meters)
0.009 ~ 0.490	2400/F(kHz)	300
0.490 ~ 1.705	24000/F(kHz)	30
1.705 ~ 30.0	30	30
30 ~ 88	100	3
88 ~ 216	150	3
216 ~ 960	200	3
Above 960	500	3

NOTE:

1. The lower limit shall apply at the transition frequencies.
2. Emission level (dBuV/m) = 20 log Emission level (uV/m).
3. For frequencies above 1000MHz, the field strength limits are based on average detector, however, the peak field strength of any emission shall not exceed the maximum permitted average limits, specified above by more than 20dB under any condition of modulation.

LIMITS OF UNWANTED EMISSION OUT OF THE RESTRICTED BANDS

APPLICABLE TO	LIMIT	
789033 D02 General UNII Test Procedure New Rules v01	FIELD STRENGTH AT 3m	
	PK:74 (dBμV/m)	AV:54 (dBμV/m)
APPLICABLE TO	EIRP LIMIT	EQUIVALENT FIELD STRENGTH AT 3m
15.407(b)(1)	PK:-27 (dBm/MHz)	PK:68.2(dBμV/m)
15.407(b)(2)		
15.407(b)(3)		
15.407(b)(4)	PK:-27 (dBm/MHz) ^{*1} PK:-17 (dBm/MHz) ^{*2}	PK: 68.2(dBμV/m) ^{*1} PK:78.2 (dBμV/m) ^{*2}

NOTE: ^{*1} beyond 10MHz of the band edge ^{*2} within 10 MHz of band edge

The following formula is used to convert the equipment isotropic radiated power (eirp) to field strength:

$$E = \frac{1000000\sqrt{30P}}{3} \mu\text{V/m, where } P \text{ is the eirp (Watts).}$$



4.1.2 Test Instruments

DESCRIPTION & MANUFACTURER	MODEL NO.	SERIAL NO.	CALIBRATED DATE	CALIBRATED UNTIL
HP Preamplifier	8447D	2432A03504	Feb. 26, 2015	Feb. 25, 2016
HP Preamplifier	8449B	3008A01201	Feb. 26, 2015	Feb. 25, 2016
MITEQ Preamplifier	AMF-6F-260400-3 3-8P	892164	Mar. 01, 2015	Feb. 28, 2016
Agilent Spectrum	E4446A	MY51100050	Oct. 24, 2014	Oct. 23, 2015
Agilent TEST RECEIVER	N9038A	MY51210129	Jan. 20, 2015	Jan. 19, 2016
Schwarzbeck Antenna	VULB 9168	139	Feb. 04, 2015	Feb. 03, 2016
Schwarzbeck Antenna	VHBA 9123	480	May 29, 2015	May 28, 2017
Schwarzbeck Horn Antenna	BBHA-9170	212	Feb. 09, 2015	Feb. 08, 2016
Schwarzbeck Horn Antenna	BBHA 9120-D1	D130	Feb. 10, 2015	Feb. 09, 2016
ADT. Turn Table	TT100	0306	NA	NA
ADT. Tower	AT100	0306	NA	NA
Software	Radiated_V7.6.15. 9.4	NA	NA	NA
SUHNER RF cable With 4dB PAD	SF104	CABLE-CH6	Aug. 15, 2015	Aug. 14, 2016
SUHNER RF cable With 3dB PAD	SF102	Cable-CH8-3.6m	Aug. 15, 2015	Aug. 14, 2016
EMCO Horn Antenna	3115	00028257	Feb. 05, 2015	Feb. 04, 2016
Highpass filter Wainwright Instruments	WHK 3.1/18G-10SS	SN 8	NA	NA
ROHDE & SCHWARZ Spectrum Analyzer	FSV40	101042	Sep. 29, 2014	Sep. 28, 2015
Anritsu Power Sensor	MA2411B	0738404	Apr. 21, 2015	Apr. 20, 2016
Anritsu Power Meter	ML2495A	0842014	Apr. 21, 2015	Apr. 20, 2016

- NOTE:**
1. The calibration interval of the above test instruments is 12/24 months. And the calibrations are traceable to NML/ROC and NIST/USA.
 2. The horn antenna and HP preamplifier (model: 8449B) are used only for the measurement of emission frequency above 1GHz if tested.
 3. The test was performed in Chamber No. 6.
 4. The Industry Canada Reference No. IC 7450E-6.
 5. The FCC Site Registration No. is 447212.

4.1.3 Test Procedure

- a. The EUT was placed on the top of a rotating table 0.8 meters (for below 1GHz) / 1.5 meters (for above 1GHz) above the ground at 3 meter chamber room for test. The table was rotated 360 degrees to determine the position of the highest radiation.
- b. The EUT was set 3 meters away from the interference-receiving antenna, which was mounted on the top of a variable-height antenna tower.
- c. The height of antenna is varied from one meter to four meters above the ground to determine the maximum value of the field strength. Both horizontal and vertical polarizations of the antenna are set to make the measurement.
- d. For each suspected emission, the EUT was arranged to its worst case and then the antenna was tuned to heights from 1 meter to 4 meters and the rotatable table was turned from 0 degrees to 360 degrees to find the maximum reading.
- e. The test-receiver system was set to quasi-peak detect function and specified bandwidth with maximum hold mode when the test frequency is below 1 GHz.
- f. The test-receiver system was set to peak and average detect function and specified bandwidth with maximum hold mode when the test frequency is above 1 GHz. If the peak reading value also meets average limit, measurement with the average detector is unnecessary.

Note:

1. The resolution bandwidth and video bandwidth of test receiver/spectrum analyzer is 120kHz for Quasi-peak detection (QP) at frequency below 1GHz.
2. The resolution bandwidth of test receiver/spectrum analyzer is 1 MHz and the video bandwidth is 3 MHz for Peak detection (PK) at frequency above 1GHz.
3. The resolution bandwidth of test receiver/spectrum analyzer is 1MHz and the video bandwidth is 3MHz for RMS Average (Duty cycle < 98%) for Average detection (AV) at frequency above 1GHz, then the measurement results was added to a correction factor ($10 \log(1/\text{duty cycle})$).
4. The resolution bandwidth of test receiver/spectrum analyzer is 1MHz and the video bandwidth is 10Hz (Duty cycle $\geq 98\%$) for Average detection (AV) at frequency above 1GHz.
5. All modes of operation were investigated and the worst-case emissions are reported.

4.1.4 Deviation from Test Standard

No deviation.

4.1.5 Test Setup

<Frequency Range below 1GHz>

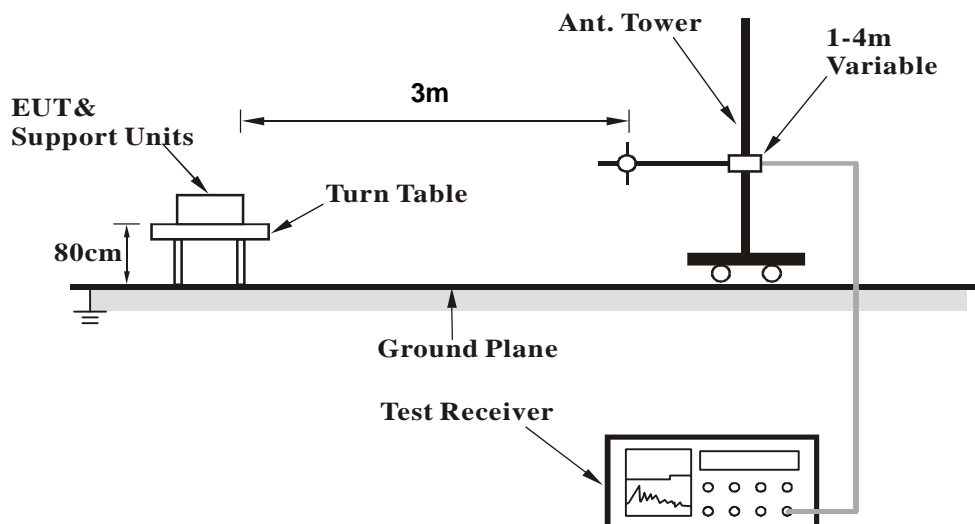

<Frequency Range above 1GHz>

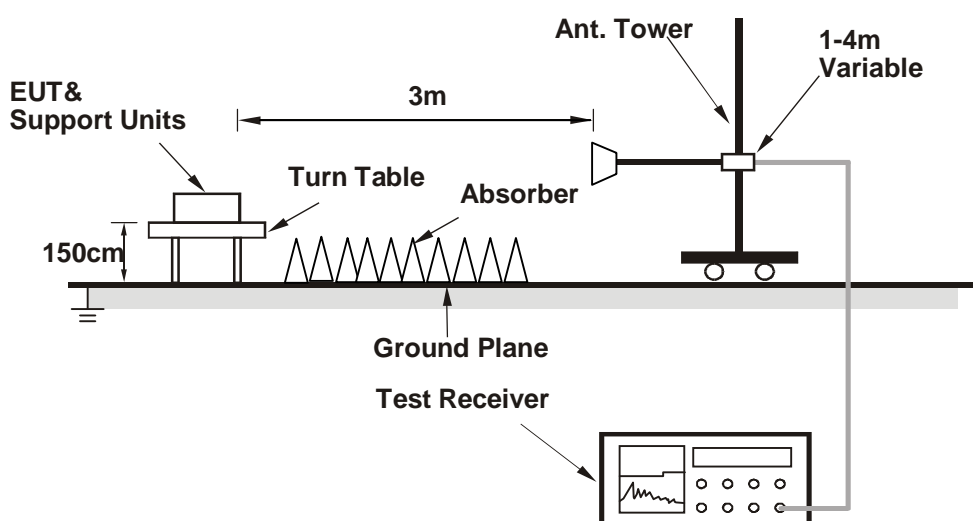

For the actual test configuration, please refer to the attached file (Test Setup Photo).

4.1.6 EUT Operating Condition

- Placed the EUT on the testing table.
- Prepared notebook to act as communication partner and placed it outside of testing area.
- The communication partner connected with EUT via a RJ45 cable and ran a test program (provided by manufacturer) to enable EUT under transmission condition continuously at specific channel frequency.
- The communication partner sent data to EUT by command "PING".
- The necessary accessories enable the system in full functions.

4.1.7 Test Results

BELOW 1GHz WORST-CASE DATA

802.11n (HT40)

CHANNEL	TX Channel 46	DETECTOR FUNCTION	Quasi-Peak (QP)
FREQUENCY RANGE	30MHz ~ 1GHz		

ANTENNA POLARITY & TEST DISTANCE: HORIZONTAL AT 3 M

NO.	FREQ. (MHz)	EMISSION LEVEL (dBuV/m)	LIMIT (dBuV/m)	MARGIN (dB)	ANTENNA HEIGHT (m)	TABLE ANGLE (Degree)	RAW VALUE (dBuV)	CORRECTION FACTOR (dB/m)
1	30.15	29.0 QP	40.0	-11.0	4.00 H	194	39.50	-10.54
2	65.21	26.7 QP	40.0	-13.3	4.00 H	215	36.50	-9.81
3	112.26	26.0 QP	43.5	-17.5	3.58 H	238	37.80	-11.83
4	151.59	33.4 QP	43.5	-10.1	2.91 H	279	41.81	-8.44
5	674.42	30.1 QP	46.0	-15.9	1.64 H	312	29.48	0.63
6	944.61	34.8 QP	46.0	-11.3	1.00 H	236	29.38	5.37

ANTENNA POLARITY & TEST DISTANCE: VERTICAL AT 3 M

NO.	FREQ. (MHz)	EMISSION LEVEL (dBuV/m)	LIMIT (dBuV/m)	MARGIN (dB)	ANTENNA HEIGHT (m)	TABLE ANGLE (Degree)	RAW VALUE (dBuV)	CORRECTION FACTOR (dB/m)
1	36.16	36.1 QP	40.0	-3.9	1.17 V	333	46.26	-10.12
2	67.44	31.8 QP	40.0	-8.2	1.06 V	217	42.14	-10.31
3	97.90	31.2 QP	43.5	-12.3	1.00 V	324	44.97	-13.77
4	151.59	29.9 QP	43.5	-13.6	1.00 V	307	38.37	-8.44
5	842.37	33.1 QP	46.0	-12.9	2.27 V	82	29.86	3.21
6	972.79	34.5 QP	54.0	-19.5	1.85 V	350	28.72	5.82

REMARKS:

1. Emission Level(dBuV/m) = Raw Value(dBuV) + Correction Factor(dB/m)
2. Correction Factor(dB/m) = Antenna Factor(dB/m) + Cable Factor(dB) – Pre-Amplifier Factor(dB)
3. The other emission levels were very low against the limit.
4. Margin value = Emission Level – Limit value

ABOVE 1GHz DATA
802.11a

CHANNEL	TX Channel 36	DETECTOR FUNCTION	Peak (PK)
FREQUENCY RANGE	1GHz ~ 40GHz		Average (AV)

ANTENNA POLARITY & TEST DISTANCE: HORIZONTAL AT 3 M

NO.	FREQ. (MHz)	EMISSION LEVEL (dBuV/m)	LIMIT (dBuV/m)	MARGIN (dB)	ANTENNA HEIGHT (m)	TABLE ANGLE (Degree)	RAW VALUE (dBuV)	CORRECTION FACTOR (dB/m)
1	5150.00	61.9 PK	74.0	-12.2	1.63 H	84	53.42	8.43
2	5150.00	48.7 AV	54.0	-5.3	1.63 H	84	40.24	8.43
3	*5180.00	101.9 PK			1.63 H	84	93.35	8.54
4	*5180.00	93.1 AV			1.63 H	84	84.55	8.54
5	#10360.00	61.9 PK	74.0	-12.1	1.40 H	196	42.05	19.88
6	#10360.00	49.1 AV	54.0	-4.9	1.40 H	196	29.23	19.88

ANTENNA POLARITY & TEST DISTANCE: VERTICAL AT 3 M

NO.	FREQ. (MHz)	EMISSION LEVEL (dBuV/m)	LIMIT (dBuV/m)	MARGIN (dB)	ANTENNA HEIGHT (m)	TABLE ANGLE (Degree)	RAW VALUE (dBuV)	CORRECTION FACTOR (dB/m)
1	5150.00	65.9 PK	74.0	-8.1	1.31 V	151	57.43	8.43
2	5150.00	50.8 AV	54.0	-3.2	1.31 V	151	42.35	8.43
3	*5180.00	109.7 PK			1.31 V	151	101.13	8.54
4	*5180.00	101.0 AV			1.31 V	151	92.46	8.54
5	#10360.00	63.0 PK	74.0	-11.0	1.15 V	289	43.16	19.88
6	#10360.00	51.2 AV	54.0	-2.8	1.15 V	289	31.35	19.88

REMARKS:

- Emission Level(dBuV/m) = Raw Value(dBuV) + Correction Factor(dB/m)
- Correction Factor(dB/m) = Antenna Factor(dB/m) + Cable Factor(dB) – Pre-Amplifier Factor(dB)
- The other emission levels were very low against the limit.
- Margin value = Emission Level – Limit value
- " * ": Fundamental frequency.
- " # ": The radiated frequency is out of the restricted band.

CHANNEL	TX Channel 40	DETECTOR FUNCTION	Peak (PK)
FREQUENCY RANGE	1GHz ~ 40GHz		Average (AV)

ANTENNA POLARITY & TEST DISTANCE: HORIZONTAL AT 3 M								
NO.	FREQ. (MHz)	EMISSION LEVEL (dBuV/m)	LIMIT (dBuV/m)	MARGIN (dB)	ANTENNA HEIGHT (m)	TABLE ANGLE (Degree)	RAW VALUE (dBuV)	CORRECTION FACTOR (dB/m)
1	*5200.00	101.2 PK			1.31 H	239	92.58	8.60
2	*5200.00	92.2 AV			1.31 H	239	83.57	8.60
3	#10400.00	62.1 PK	74.0	-11.9	1.38 H	204	42.16	19.93
4	#10400.00	49.9 AV	54.0	-4.1	1.38 H	204	30.01	19.93

ANTENNA POLARITY & TEST DISTANCE: VERTICAL AT 3 M								
NO.	FREQ. (MHz)	EMISSION LEVEL (dBuV/m)	LIMIT (dBuV/m)	MARGIN (dB)	ANTENNA HEIGHT (m)	TABLE ANGLE (Degree)	RAW VALUE (dBuV)	CORRECTION FACTOR (dB/m)
1	*5200.00	109.7 PK			1.31 V	149	101.05	8.60
2	*5200.00	100.6 AV			1.31 V	149	91.99	8.60
3	#10400.00	63.3 PK	74.0	-10.7	1.26 V	293	43.33	19.93
4	#10400.00	50.5 AV	54.0	-3.5	1.26 V	293	30.57	19.93

REMARKS:

1. Emission Level(dBuV/m) = Raw Value(dBuV) + Correction Factor(dB/m)
2. Correction Factor(dB/m) = Antenna Factor(dB/m) + Cable Factor(dB) – Pre-Amplifier Factor(dB)
3. The other emission levels were very low against the limit.
4. Margin value = Emission Level – Limit value
5. " * ": Fundamental frequency.
6. " # ": The radiated frequency is out of the restricted band.



CHANNEL	TX Channel 48	DETECTOR FUNCTION	Peak (PK)
FREQUENCY RANGE	1GHz ~ 40GHz		Average (AV)

ANTENNA POLARITY & TEST DISTANCE: HORIZONTAL AT 3 M

NO.	FREQ. (MHz)	EMISSION LEVEL (dBuV/m)	LIMIT (dBuV/m)	MARGIN (dB)	ANTENNA HEIGHT (m)	TABLE ANGLE (Degree)	RAW VALUE (dBuV)	CORRECTION FACTOR (dB/m)
1	*5240.00	101.5 PK			1.26 H	246	92.81	8.70
2	*5240.00	92.8 AV			1.26 H	246	84.11	8.70
3	5350.00	59.8 PK	74.0	-14.2	1.26 H	246	50.81	8.96
4	5350.00	47.7 AV	54.0	-6.3	1.26 H	246	38.75	8.96
5	#10480.00	62.3 PK	74.0	-11.7	1.44 H	197	42.15	20.13
6	#10480.00	49.5 AV	54.0	-4.5	1.44 H	197	29.37	20.13

ANTENNA POLARITY & TEST DISTANCE: VERTICAL AT 3 M

NO.	FREQ. (MHz)	EMISSION LEVEL (dBuV/m)	LIMIT (dBuV/m)	MARGIN (dB)	ANTENNA HEIGHT (m)	TABLE ANGLE (Degree)	RAW VALUE (dBuV)	CORRECTION FACTOR (dB/m)
1	*5240.00	109.0 PK			1.67 V	148	100.30	8.70
2	*5240.00	100.4 AV			1.67 V	148	91.73	8.70
3	5350.00	61.1 PK	74.0	-12.9	1.67 V	148	52.11	8.96
4	5350.00	48.5 AV	54.0	-5.5	1.67 V	148	39.54	8.96
5	#10480.00	63.8 PK	74.0	-10.2	1.21 V	291	43.65	20.13
6	#10480.00	50.7 AV	54.0	-3.3	1.21 V	291	30.58	20.13

REMARKS:

- Emission Level(dBuV/m) = Raw Value(dBuV) + Correction Factor(dB/m)
- Correction Factor(dB/m) = Antenna Factor(dB/m) + Cable Factor(dB) – Pre-Amplifier Factor(dB)
- The other emission levels were very low against the limit.
- Margin value = Emission Level – Limit value
- " * ": Fundamental frequency.
- " # ": The radiated frequency is out of the restricted band.

CHANNEL	TX Channel 149	DETECTOR FUNCTION	Peak (PK)
FREQUENCY RANGE	1GHz ~ 40GHz		Average (AV)

ANTENNA POLARITY & TEST DISTANCE: HORIZONTAL AT 3 M								
NO.	FREQ. (MHz)	EMISSION LEVEL (dBuV/m)	LIMIT (dBuV/m)	MARGIN (dB)	ANTENNA HEIGHT (m)	TABLE ANGLE (Degree)	RAW VALUE (dBuV)	CORRECTION FACTOR (dB/m)
1	#5714.99	61.1 PK	68.2	-7.1	1.83 H	280	51.27	9.79
2	#5725.00	62.8 PK	78.2	-15.4	1.83 H	280	52.99	9.80
3	*5745.00	101.3 PK			1.83 H	280	91.40	9.85
4	*5745.00	92.0 AV			1.83 H	280	82.11	9.85
5	11490.00	65.4 PK	74.0	-8.6	1.88 H	77	43.98	21.38
6	11490.00	52.9 AV	54.0	-1.1	1.88 H	77	31.55	21.38

ANTENNA POLARITY & TEST DISTANCE: VERTICAL AT 3 M								
NO.	FREQ. (MHz)	EMISSION LEVEL (dBuV/m)	LIMIT (dBuV/m)	MARGIN (dB)	ANTENNA HEIGHT (m)	TABLE ANGLE (Degree)	RAW VALUE (dBuV)	CORRECTION FACTOR (dB/m)
1	#5714.99	65.9 PK	68.2	-2.3	1.69 V	91	56.10	9.79
2	#5725.00	77.2 PK	78.2	-1.0	1.69 V	91	67.36	9.80
3	*5745.00	107.8 PK			1.69 V	91	97.91	9.85
4	*5745.00	98.7 AV			1.69 V	91	88.84	9.85
5	11490.00	63.7 PK	74.0	-10.3	1.07 V	72	42.29	21.38
6	11490.00	51.2 AV	54.0	-2.8	1.07 V	72	29.82	21.38

REMARKS:

- Emission Level(dBuV/m) = Raw Value(dBuV) + Correction Factor(dB/m)
- Correction Factor(dB/m) = Antenna Factor(dB/m) + Cable Factor(dB) – Pre-Amplifier Factor(dB)
- The other emission levels were very low against the limit.
- Margin value = Emission Level – Limit value
- " * ": Fundamental frequency.
- " # ": The radiated frequency is out of the restricted band.

CHANNEL	TX Channel 157	DETECTOR FUNCTION	Peak (PK)
FREQUENCY RANGE	1GHz ~ 40GHz		Average (AV)

ANTENNA POLARITY & TEST DISTANCE: HORIZONTAL AT 3 M								
NO.	FREQ. (MHz)	EMISSION LEVEL (dBuV/m)	LIMIT (dBuV/m)	MARGIN (dB)	ANTENNA HEIGHT (m)	TABLE ANGLE (Degree)	RAW VALUE (dBuV)	CORRECTION FACTOR (dB/m)
1	*5785.00	99.4 PK			1.83 H	281	89.42	9.94
2	*5785.00	90.2 AV			1.83 H	281	80.29	9.94
3	11570.00	64.4 PK	74.0	-9.6	2.29 H	76	42.98	21.44
4	11570.00	52.9 AV	54.0	-1.1	2.29 H	76	31.50	21.44

ANTENNA POLARITY & TEST DISTANCE: VERTICAL AT 3 M								
NO.	FREQ. (MHz)	EMISSION LEVEL (dBuV/m)	LIMIT (dBuV/m)	MARGIN (dB)	ANTENNA HEIGHT (m)	TABLE ANGLE (Degree)	RAW VALUE (dBuV)	CORRECTION FACTOR (dB/m)
1	*5785.00	105.2 PK			1.82 V	90	95.22	9.94
2	*5785.00	96.1 AV			1.82 V	90	86.18	9.94
3	11570.00	63.8 PK	74.0	-10.2	1.32 V	72	42.39	21.44
4	11570.00	51.0 AV	54.0	-3.0	1.32 V	72	29.57	21.44

REMARKS:

1. Emission Level(dBuV/m) = Raw Value(dBuV) + Correction Factor(dB/m)
2. Correction Factor(dB/m) = Antenna Factor(dB/m) + Cable Factor(dB) – Pre-Amplifier Factor(dB)
3. The other emission levels were very low against the limit.
4. Margin value = Emission Level – Limit value
5. " * ": Fundamental frequency.

CHANNEL	TX Channel 165	DETECTOR FUNCTION	Peak (PK)
FREQUENCY RANGE	1GHz ~ 40GHz		Average (AV)

ANTENNA POLARITY & TEST DISTANCE: HORIZONTAL AT 3 M

NO.	FREQ. (MHz)	EMISSION LEVEL (dBuV/m)	LIMIT (dBuV/m)	MARGIN (dB)	ANTENNA HEIGHT (m)	TABLE ANGLE (Degree)	RAW VALUE (dBuV)	CORRECTION FACTOR (dB/m)
1	*5825.00	99.4 PK			1.95 H	281	89.38	10.04
2	*5825.00	90.3 AV			1.95 H	281	80.25	10.04
3	#5850.00	63.2 PK	78.2	-15.0	1.95 H	281	53.13	10.07
4	#5860.01	61.4 PK	68.2	-6.8	1.95 H	281	51.28	10.09
5	11650.00	64.7 PK	74.0	-9.3	2.10 H	298	43.77	20.90
6	11650.00	52.7 AV	54.0	-1.3	2.10 H	298	31.80	20.90

ANTENNA POLARITY & TEST DISTANCE: VERTICAL AT 3 M

NO.	FREQ. (MHz)	EMISSION LEVEL (dBuV/m)	LIMIT (dBuV/m)	MARGIN (dB)	ANTENNA HEIGHT (m)	TABLE ANGLE (Degree)	RAW VALUE (dBuV)	CORRECTION FACTOR (dB/m)
1	*5825.00	105.3 PK			1.84 V	96	95.29	10.04
2	*5825.00	96.5 AV			1.84 V	96	86.45	10.04
3	#5850.00	66.9 PK	78.2	-11.3	1.84 V	96	56.78	10.07
4	#5860.01	63.6 PK	68.2	-4.6	1.84 V	96	53.49	10.09
5	11650.00	63.5 PK	74.0	-10.5	1.45 V	78	42.58	20.90
6	11650.00	50.9 AV	54.0	-3.1	1.45 V	78	29.97	20.90

REMARKS:

- Emission Level(dBuV/m) = Raw Value(dBuV) + Correction Factor(dB/m)
- Correction Factor(dB/m) = Antenna Factor(dB/m) + Cable Factor(dB) – Pre-Amplifier Factor(dB)
- The other emission levels were very low against the limit.
- Margin value = Emission Level – Limit value
- " * ": Fundamental frequency.
- " # ": The radiated frequency is out of the restricted band.

802.11n (HT20)

CHANNEL	TX Channel 36	DETECTOR FUNCTION	Peak (PK)
FREQUENCY RANGE	1GHz ~ 40GHz		Average (AV)

ANTENNA POLARITY & TEST DISTANCE: HORIZONTAL AT 3 M

NO.	FREQ. (MHz)	EMISSION LEVEL (dBuV/m)	LIMIT (dBuV/m)	MARGIN (dB)	ANTENNA HEIGHT (m)	TABLE ANGLE (Degree)	RAW VALUE (dBuV)	CORRECTION FACTOR (dB/m)
1	5150.00	61.3 PK	74.0	-12.7	1.43 H	87	52.85	8.43
2	5150.00	48.8 AV	54.0	-5.2	1.43 H	87	40.38	8.43
3	*5180.00	99.7 PK			1.43 H	87	91.16	8.54
4	*5180.00	90.3 AV			1.43 H	87	81.78	8.54
5	#10360.00	61.3 PK	74.0	-12.7	1.30 H	198	41.39	19.88
6	#10360.00	48.6 AV	54.0	-5.4	1.30 H	198	28.68	19.88

ANTENNA POLARITY & TEST DISTANCE: VERTICAL AT 3 M

NO.	FREQ. (MHz)	EMISSION LEVEL (dBuV/m)	LIMIT (dBuV/m)	MARGIN (dB)	ANTENNA HEIGHT (m)	TABLE ANGLE (Degree)	RAW VALUE (dBuV)	CORRECTION FACTOR (dB/m)
1	5150.00	63.7 PK	74.0	-10.3	1.70 V	151	55.26	8.43
2	5150.00	49.7 AV	54.0	-4.4	1.70 V	151	41.22	8.43
3	*5180.00	107.9 PK			1.70 V	151	99.33	8.54
4	*5180.00	98.5 AV			1.70 V	151	89.94	8.54
5	#10360.00	62.1 PK	74.0	-12.0	1.26 V	288	42.17	19.88
6	#10360.00	49.6 AV	54.0	-4.4	1.26 V	288	29.72	19.88

REMARKS:

- Emission Level(dBuV/m) = Raw Value(dBuV) + Correction Factor(dB/m)
- Correction Factor(dB/m) = Antenna Factor(dB/m) + Cable Factor(dB) – Pre-Amplifier Factor(dB)
- The other emission levels were very low against the limit.
- Margin value = Emission Level – Limit value
- " * ": Fundamental frequency.
- " # ": The radiated frequency is out of the restricted band.

CHANNEL	TX Channel 40	DETECTOR FUNCTION	Peak (PK)
FREQUENCY RANGE	1GHz ~ 40GHz		Average (AV)

ANTENNA POLARITY & TEST DISTANCE: HORIZONTAL AT 3 M								
NO.	FREQ. (MHz)	EMISSION LEVEL (dBuV/m)	LIMIT (dBuV/m)	MARGIN (dB)	ANTENNA HEIGHT (m)	TABLE ANGLE (Degree)	RAW VALUE (dBuV)	CORRECTION FACTOR (dB/m)
1	*5200.00	99.6 PK			1.31 H	239	91.01	8.60
2	*5200.00	90.0 AV			1.31 H	239	81.42	8.60
3	#10400.00	61.6 PK	74.0	-12.4	1.36 H	194	41.65	19.93
4	#10400.00	48.7 AV	54.0	-5.3	1.36 H	194	28.79	19.93

ANTENNA POLARITY & TEST DISTANCE: VERTICAL AT 3 M								
NO.	FREQ. (MHz)	EMISSION LEVEL (dBuV/m)	LIMIT (dBuV/m)	MARGIN (dB)	ANTENNA HEIGHT (m)	TABLE ANGLE (Degree)	RAW VALUE (dBuV)	CORRECTION FACTOR (dB/m)
1	*5200.00	108.2 PK			1.60 V	151	99.62	8.60
2	*5200.00	98.9 AV			1.60 V	151	90.25	8.60
3	#10400.00	63.6 PK	74.0	-10.4	1.27 V	291	43.65	19.93
4	#10400.00	50.0 AV	54.0	-4.0	1.27 V	291	30.11	19.93

REMARKS:

1. Emission Level(dBuV/m) = Raw Value(dBuV) + Correction Factor(dB/m)
2. Correction Factor(dB/m) = Antenna Factor(dB/m) + Cable Factor(dB) – Pre-Amplifier Factor(dB)
3. The other emission levels were very low against the limit.
4. Margin value = Emission Level – Limit value
5. " * ": Fundamental frequency.
6. " # ": The radiated frequency is out of the restricted band.

CHANNEL	TX Channel 48	DETECTOR FUNCTION	Peak (PK)
FREQUENCY RANGE	1GHz ~ 40GHz		Average (AV)

ANTENNA POLARITY & TEST DISTANCE: HORIZONTAL AT 3 M								
NO.	FREQ. (MHz)	EMISSION LEVEL (dBuV/m)	LIMIT (dBuV/m)	MARGIN (dB)	ANTENNA HEIGHT (m)	TABLE ANGLE (Degree)	RAW VALUE (dBuV)	CORRECTION FACTOR (dB/m)
1	*5240.00	101.4 PK			1.27 H	247	92.66	8.70
2	*5240.00	92.0 AV			1.27 H	247	83.28	8.70
3	5350.00	60.2 PK	74.0	-13.8	1.27 H	247	51.20	8.96
4	5350.00	47.2 AV	54.0	-6.9	1.27 H	247	38.19	8.96
5	#10480.00	61.7 PK	74.0	-12.3	1.29 H	195	41.60	20.13
6	#10480.00	48.9 AV	54.0	-5.1	1.29 H	195	28.75	20.13
ANTENNA POLARITY & TEST DISTANCE: VERTICAL AT 3 M								
NO.	FREQ. (MHz)	EMISSION LEVEL (dBuV/m)	LIMIT (dBuV/m)	MARGIN (dB)	ANTENNA HEIGHT (m)	TABLE ANGLE (Degree)	RAW VALUE (dBuV)	CORRECTION FACTOR (dB/m)
1	*5240.00	108.7 PK			1.29 V	147	99.98	8.70
2	*5240.00	99.5 AV			1.29 V	147	90.84	8.70
3	5350.00	60.9 PK	74.0	-13.1	1.29 V	147	51.98	8.96
4	5350.00	47.5 AV	54.0	-6.5	1.29 V	147	38.54	8.96
5	#10480.00	63.7 PK	74.0	-10.4	1.24 V	290	43.52	20.13
6	#10480.00	50.2 AV	54.0	-3.8	1.24 V	290	30.09	20.13

REMARKS:

1. Emission Level(dBuV/m) = Raw Value(dBuV) + Correction Factor(dB/m)
2. Correction Factor(dB/m) = Antenna Factor(dB/m) + Cable Factor(dB) – Pre-Amplifier Factor(dB)
3. The other emission levels were very low against the limit.
4. Margin value = Emission Level – Limit value
5. " * ": Fundamental frequency.
6. " # ": The radiated frequency is out of the restricted band.

CHANNEL	TX Channel 149	DETECTOR FUNCTION	Peak (PK)
FREQUENCY RANGE	1GHz ~ 40GHz		Average (AV)

ANTENNA POLARITY & TEST DISTANCE: HORIZONTAL AT 3 M								
NO.	FREQ. (MHz)	EMISSION LEVEL (dBuV/m)	LIMIT (dBuV/m)	MARGIN (dB)	ANTENNA HEIGHT (m)	TABLE ANGLE (Degree)	RAW VALUE (dBuV)	CORRECTION FACTOR (dB/m)
1	#5714.99	62.0 PK	68.2	-6.2	1.64 H	297	52.19	9.79
2	#5725.00	69.6 PK	78.2	-8.6	1.64 H	297	59.84	9.80
3	*5745.00	97.7 PK			1.64 H	297	87.86	9.85
4	*5745.00	88.1 AV			1.64 H	297	78.27	9.85
5	11490.00	64.5 PK	74.0	-9.5	1.10 H	282	43.13	21.38
6	11490.00	52.7 AV	54.0	-1.3	1.10 H	282	31.35	21.38

ANTENNA POLARITY & TEST DISTANCE: VERTICAL AT 3 M								
NO.	FREQ. (MHz)	EMISSION LEVEL (dBuV/m)	LIMIT (dBuV/m)	MARGIN (dB)	ANTENNA HEIGHT (m)	TABLE ANGLE (Degree)	RAW VALUE (dBuV)	CORRECTION FACTOR (dB/m)
1	#5714.99	63.9 PK	68.2	-4.3	1.89 V	88	54.07	9.79
2	#5725.00	77.0 PK	78.2	-1.2	1.89 V	88	67.17	9.80
3	*5745.00	104.8 PK			1.89 V	88	94.98	9.85
4	*5745.00	95.5 AV			1.89 V	88	85.67	9.85
5	11490.00	64.0 PK	74.0	-10.0	1.42 V	145	42.65	21.38
6	11490.00	51.5 AV	54.0	-2.5	1.42 V	145	30.08	21.38

REMARKS:

1. Emission Level(dBuV/m) = Raw Value(dBuV) + Correction Factor(dB/m)
2. Correction Factor(dB/m) = Antenna Factor(dB/m) + Cable Factor(dB) – Pre-Amplifier Factor(dB)
3. The other emission levels were very low against the limit.
4. Margin value = Emission Level – Limit value
5. " * ": Fundamental frequency.
6. " # ": The radiated frequency is out of the restricted band.

CHANNEL	TX Channel 157	DETECTOR FUNCTION	Peak (PK)
FREQUENCY RANGE	1GHz ~ 40GHz		Average (AV)

ANTENNA POLARITY & TEST DISTANCE: HORIZONTAL AT 3 M								
NO.	FREQ. (MHz)	EMISSION LEVEL (dBuV/m)	LIMIT (dBuV/m)	MARGIN (dB)	ANTENNA HEIGHT (m)	TABLE ANGLE (Degree)	RAW VALUE (dBuV)	CORRECTION FACTOR (dB/m)
1	*5785.00	100.1 PK			2.00 H	279	90.16	9.94
2	*5785.00	90.2 AV			2.00 H	279	80.29	9.94
3	11570.00	65.9 PK	74.0	-8.1	1.38 H	295	44.48	21.44
4	11570.00	52.8 AV	54.0	-1.2	1.38 H	295	31.33	21.44

ANTENNA POLARITY & TEST DISTANCE: VERTICAL AT 3 M								
NO.	FREQ. (MHz)	EMISSION LEVEL (dBuV/m)	LIMIT (dBuV/m)	MARGIN (dB)	ANTENNA HEIGHT (m)	TABLE ANGLE (Degree)	RAW VALUE (dBuV)	CORRECTION FACTOR (dB/m)
1	*5785.00	106.0 PK			1.77 V	83	96.09	9.94
2	*5785.00	96.4 AV			1.77 V	83	86.47	9.94
3	11570.00	66.9 PK	74.0	-7.1	1.11 V	198	45.43	21.44
4	11570.00	52.9 AV	54.0	-1.2	1.11 V	198	31.41	21.44

REMARKS:

1. Emission Level(dBuV/m) = Raw Value(dBuV) + Correction Factor(dB/m)
2. Correction Factor(dB/m) = Antenna Factor(dB/m) + Cable Factor(dB) – Pre-Amplifier Factor(dB)
3. The other emission levels were very low against the limit.
4. Margin value = Emission Level – Limit value
5. " * ": Fundamental frequency.

CHANNEL	TX Channel 165	DETECTOR FUNCTION	Peak (PK)
FREQUENCY RANGE	1GHz ~ 40GHz		Average (AV)

ANTENNA POLARITY & TEST DISTANCE: HORIZONTAL AT 3 M

NO.	FREQ. (MHz)	EMISSION LEVEL (dBuV/m)	LIMIT (dBuV/m)	MARGIN (dB)	ANTENNA HEIGHT (m)	TABLE ANGLE (Degree)	RAW VALUE (dBuV)	CORRECTION FACTOR (dB/m)
1	*5825.00	99.4 PK			1.80 H	280	89.32	10.04
2	*5825.00	89.6 AV			1.80 H	280	79.51	10.04
3	#5850.00	62.7 PK	78.2	-15.5	1.80 H	280	52.60	10.07
4	#5860.01	60.9 PK	68.2	-7.3	1.80 H	280	50.77	10.09
5	11650.00	66.7 PK	74.0	-7.3	1.53 H	267	45.82	20.90
6	11650.00	52.5 AV	54.0	-1.5	1.53 H	267	31.57	20.90

ANTENNA POLARITY & TEST DISTANCE: VERTICAL AT 3 M

NO.	FREQ. (MHz)	EMISSION LEVEL (dBuV/m)	LIMIT (dBuV/m)	MARGIN (dB)	ANTENNA HEIGHT (m)	TABLE ANGLE (Degree)	RAW VALUE (dBuV)	CORRECTION FACTOR (dB/m)
1	*5825.00	105.9 PK			1.79 V	92	95.86	10.04
2	*5825.00	96.4 AV			1.79 V	92	86.31	10.04
3	#5850.00	67.6 PK	78.2	-10.6	1.79 V	92	57.51	10.07
4	#5860.01	63.3 PK	68.2	-4.9	1.79 V	92	53.25	10.09
5	11650.00	62.8 PK	74.0	-11.3	1.00 V	139	41.85	20.90
6	11650.00	50.3 AV	54.0	-3.7	1.00 V	139	29.44	20.90

REMARKS:

- Emission Level(dBuV/m) = Raw Value(dBuV) + Correction Factor(dB/m)
- Correction Factor(dB/m) = Antenna Factor(dB/m) + Cable Factor(dB) – Pre-Amplifier Factor(dB)
- The other emission levels were very low against the limit.
- Margin value = Emission Level – Limit value
- " * ": Fundamental frequency.
- " # ": The radiated frequency is out of the restricted band.

802.11n (HT40)

CHANNEL	TX Channel 38	DETECTOR FUNCTION	Peak (PK)
FREQUENCY RANGE	1GHz ~ 40GHz		Average (AV)

ANTENNA POLARITY & TEST DISTANCE: HORIZONTAL AT 3 M

NO.	FREQ. (MHz)	EMISSION LEVEL (dBuV/m)	LIMIT (dBuV/m)	MARGIN (dB)	ANTENNA HEIGHT (m)	TABLE ANGLE (Degree)	RAW VALUE (dBuV)	CORRECTION FACTOR (dB/m)
1	5150.00	62.1 PK	74.0	-12.0	1.55 H	87	53.62	8.43
2	5150.00	49.6 AV	54.0	-4.4	1.55 H	87	41.21	8.43
3	*5190.00	93.7 PK			1.55 H	87	85.17	8.57
4	*5190.00	85.3 AV			1.55 H	87	76.68	8.57
5	#10380.00	61.0 PK	74.0	-13.1	1.36 H	199	41.05	19.90
6	#10380.00	47.8 AV	54.0	-6.2	1.36 H	199	27.94	19.90

ANTENNA POLARITY & TEST DISTANCE: VERTICAL AT 3 M

NO.	FREQ. (MHz)	EMISSION LEVEL (dBuV/m)	LIMIT (dBuV/m)	MARGIN (dB)	ANTENNA HEIGHT (m)	TABLE ANGLE (Degree)	RAW VALUE (dBuV)	CORRECTION FACTOR (dB/m)
1	5150.00	65.9 PK	74.0	-8.1	1.77 V	149	57.44	8.43
2	5150.00	52.8 AV	54.0	-1.2	1.77 V	149	44.37	8.43
3	*5190.00	101.4 PK			1.77 V	149	92.86	8.57
4	*5190.00	92.7 AV			1.77 V	149	84.13	8.57
5	#10380.00	62.1 PK	74.0	-11.9	1.17 V	288	42.16	19.90
6	#10380.00	48.9 AV	54.0	-5.1	1.17 V	288	28.97	19.90

REMARKS:

- Emission Level(dBuV/m) = Raw Value(dBuV) + Correction Factor(dB/m)
- Correction Factor(dB/m) = Antenna Factor(dB/m) + Cable Factor(dB) – Pre-Amplifier Factor(dB)
- The other emission levels were very low against the limit.
- Margin value = Emission Level – Limit value
- " * ": Fundamental frequency.
- " # ": The radiated frequency is out of the restricted band.

CHANNEL	TX Channel 46	DETECTOR FUNCTION	Peak (PK)
FREQUENCY RANGE	1GHz ~ 40GHz		Average (AV)

ANTENNA POLARITY & TEST DISTANCE: HORIZONTAL AT 3 M

NO.	FREQ. (MHz)	EMISSION LEVEL (dBuV/m)	LIMIT (dBuV/m)	MARGIN (dB)	ANTENNA HEIGHT (m)	TABLE ANGLE (Degree)	RAW VALUE (dBuV)	CORRECTION FACTOR (dB/m)
1	*5230.00	98.3 PK			1.27 H	247	89.65	8.67
2	*5230.00	89.5 AV			1.27 H	247	80.83	8.67
3	5350.00	59.8 PK	74.0	-14.2	1.27 H	247	50.84	8.96
4	5350.00	48.7 AV	54.0	-5.3	1.27 H	247	39.72	8.96
5	#10460.00	62.0 PK	74.0	-12.0	1.33 H	195	41.93	20.08
6	#10460.00	48.8 AV	54.0	-5.2	1.33 H	195	28.74	20.08

ANTENNA POLARITY & TEST DISTANCE: VERTICAL AT 3 M

NO.	FREQ. (MHz)	EMISSION LEVEL (dBuV/m)	LIMIT (dBuV/m)	MARGIN (dB)	ANTENNA HEIGHT (m)	TABLE ANGLE (Degree)	RAW VALUE (dBuV)	CORRECTION FACTOR (dB/m)
1	*5230.00	105.4 PK			1.52 V	146	96.75	8.67
2	*5230.00	96.7 AV			1.52 V	146	87.99	8.67
3	5350.00	60.9 PK	74.0	-13.2	1.52 V	146	51.89	8.96
4	5350.00	49.1 AV	54.0	-4.9	1.52 V	146	40.10	8.96
5	#10460.00	63.7 PK	74.0	-10.3	1.21 V	283	43.58	20.08
6	#10460.00	51.0 AV	54.0	-3.1	1.21 V	283	30.87	20.08

REMARKS:

- Emission Level(dBuV/m) = Raw Value(dBuV) + Correction Factor(dB/m)
- Correction Factor(dB/m) = Antenna Factor(dB/m) + Cable Factor(dB) – Pre-Amplifier Factor(dB)
- The other emission levels were very low against the limit.
- Margin value = Emission Level – Limit value
- " * ": Fundamental frequency.
- " # ": The radiated frequency is out of the restricted band.

CHANNEL	TX Channel 151	DETECTOR FUNCTION	Peak (PK)
FREQUENCY RANGE	1GHz ~ 40GHz		Average (AV)

ANTENNA POLARITY & TEST DISTANCE: HORIZONTAL AT 3 M								
NO.	FREQ. (MHz)	EMISSION LEVEL (dBuV/m)	LIMIT (dBuV/m)	MARGIN (dB)	ANTENNA HEIGHT (m)	TABLE ANGLE (Degree)	RAW VALUE (dBuV)	CORRECTION FACTOR (dB/m)
1	#5714.99	62.4 PK	68.2	-5.8	1.74 H	281	52.59	9.79
2	#5725.00	66.6 PK	78.2	-11.6	1.74 H	281	56.84	9.80
3	*5755.00	93.7 PK			1.74 H	281	83.78	9.88
4	*5755.00	84.4 AV			1.74 H	281	74.52	9.88
5	11510.00	61.7 PK	74.0	-12.3	1.12 H	278	40.29	21.42
6	11510.00	49.0 AV	54.0	-5.0	1.12 H	278	27.58	21.42

ANTENNA POLARITY & TEST DISTANCE: VERTICAL AT 3 M								
NO.	FREQ. (MHz)	EMISSION LEVEL (dBuV/m)	LIMIT (dBuV/m)	MARGIN (dB)	ANTENNA HEIGHT (m)	TABLE ANGLE (Degree)	RAW VALUE (dBuV)	CORRECTION FACTOR (dB/m)
1	#5714.99	67.1 PK	68.2	-1.1	1.76 V	89	57.26	9.79
2	#5725.00	71.9 PK	78.2	-6.3	1.76 V	89	62.14	9.80
3	*5755.00	99.2 PK			1.76 V	89	89.36	9.88
4	*5755.00	90.2 AV			1.76 V	89	80.35	9.88
5	11510.00	63.6 PK	74.0	-10.4	1.47 V	149	42.15	21.42
6	11510.00	51.3 AV	54.0	-2.7	1.47 V	149	29.84	21.42

REMARKS:

- Emission Level(dBuV/m) = Raw Value(dBuV) + Correction Factor(dB/m)
- Correction Factor(dB/m) = Antenna Factor(dB/m) + Cable Factor(dB) – Pre-Amplifier Factor(dB)
- The other emission levels were very low against the limit.
- Margin value = Emission Level – Limit value
- " * ": Fundamental frequency.
- " # ": The radiated frequency is out of the restricted band.

CHANNEL	TX Channel 159	DETECTOR FUNCTION	Peak (PK)
FREQUENCY RANGE	1GHz ~ 40GHz		Average (AV)

ANTENNA POLARITY & TEST DISTANCE: HORIZONTAL AT 3 M								
NO.	FREQ. (MHz)	EMISSION LEVEL (dBuV/m)	LIMIT (dBuV/m)	MARGIN (dB)	ANTENNA HEIGHT (m)	TABLE ANGLE (Degree)	RAW VALUE (dBuV)	CORRECTION FACTOR (dB/m)
1	*5795.00	98.0 PK			1.77 H	280	88.02	9.96
2	*5795.00	88.4 AV			1.77 H	280	78.40	9.96
3	#5850.00	65.3 PK	78.2	-12.9	1.77 H	280	55.21	10.07
4	#5860.01	63.7 PK	68.2	-4.5	1.77 H	288	53.63	10.09
5	11590.00	64.0 PK	74.0	-10.0	1.09 H	238	42.51	21.45
6	11590.00	52.0 AV	54.0	-2.0	1.09 H	238	30.54	21.45
ANTENNA POLARITY & TEST DISTANCE: VERTICAL AT 3 M								
NO.	FREQ. (MHz)	EMISSION LEVEL (dBuV/m)	LIMIT (dBuV/m)	MARGIN (dB)	ANTENNA HEIGHT (m)	TABLE ANGLE (Degree)	RAW VALUE (dBuV)	CORRECTION FACTOR (dB/m)
1	*5795.00	105.6 PK			1.50 V	83	95.60	9.96
2	*5795.00	96.0 AV			1.50 V	83	86.08	9.96
3	#5850.00	72.0 PK	78.2	-6.2	1.50 V	83	61.88	10.07
4	#5860.01	67.1 PK	68.2	-1.1	1.50 V	83	57.03	10.09
5	11590.00	64.3 PK	74.0	-9.7	1.45 V	141	42.89	21.45
6	11590.00	52.3 AV	54.0	-1.7	1.45 V	141	30.81	21.45

REMARKS:

1. Emission Level(dBuV/m) = Raw Value(dBuV) + Correction Factor(dB/m)
2. Correction Factor(dB/m) = Antenna Factor(dB/m) + Cable Factor(dB) – Pre-Amplifier Factor(dB)
3. The other emission levels were very low against the limit.
4. Margin value = Emission Level – Limit value
5. " * ": Fundamental frequency.
6. " # ": The radiated frequency is out of the restricted band.

4.2 Conducted Emission Measurement

4.2.1 Limits of Conducted Emission Measurement

Frequency (MHz)	Conducted Limit (dBuV)	
	Quasi-peak	Average
0.15 - 0.5	66 - 56	56 - 46
0.50 - 5.0	56	46
5.0 - 30.0	60	50

Note: 1. The lower limit shall apply at the transition frequencies.

2. The limit decreases in line with the logarithm of the frequency in the range of 0.15 to 0.50MHz.

4.2.2 Test Instruments

Description & Manufacturer	Model No.	Serial No.	Cal. Date	Cal. Due
ROHDE & SCHWARZ TEST RECEIVER	ESCS 30	100276	Apr. 01, 2015	Mar. 31, 2016
ROHDE & SCHWARZ Artificial Mains Network (for EUT)	ENV216	101197	Apr. 27, 2015	Apr. 26, 2016
LISN With Adapter (for EUT)	AD10	C10Ada-002	Apr. 27, 2015	Apr. 26, 2016
ROHDE & SCHWARZ Artificial Mains Network (for peripherals)	ESH3-Z5	100218	Nov. 25, 2014	Nov. 24, 2015
SCHWARZBECK Artificial Mains Network (For EUT)	NNLK8129	8129229	May 06, 2015	May 05, 2016
Software	Cond_V7.3.7	NA	NA	NA
RF cable (JYEBAO) With 10dB PAD	5D-FB	Cable-C10.01	Feb. 17, 2015	Feb. 16, 2016
SUHNER Terminator (For ROHDE & SCHWARZ LISN)	65BNC-5001	E1-011484	May 19, 2015	May 18, 2016
ROHDE & SCHWARZ Artificial Mains Network (For TV EUT)	ESH3-Z5	100220	Nov. 20, 2014	Nov. 19, 2015
LISN With Adapter (for TV EUT)	100220	N/A	Nov. 20, 2014	Nov. 19, 2015

Notes: 1. The calibration interval of the above test instruments is 12 months and the calibrations are traceable to NML/ROC and NIST/USA.

2. The test was performed in Shielded Room No. 10.

3. The VCCI Site Registration No. C-1852.

4.2.3 Test Procedure

- The EUT was placed 0.4 meters from the conducting wall of the shielded room with EUT being connected to the power mains through a line impedance stabilization network (LISN). Other support units were connected to the power mains through another LISN. The two LISNs provide 50 ohm/ 50uH of coupling impedance for the measuring instrument.
- Both lines of the power mains connected to the EUT were checked for maximum conducted interference.
- The frequency range from 150kHz to 30MHz was searched. Emission levels under (Limit - 20dB) was not recorded.

NOTE: All modes of operation were investigated and the worst-case emissions are reported.

4.2.4 Deviation from Test Standard

No deviation.

4.2.5 Test Setup

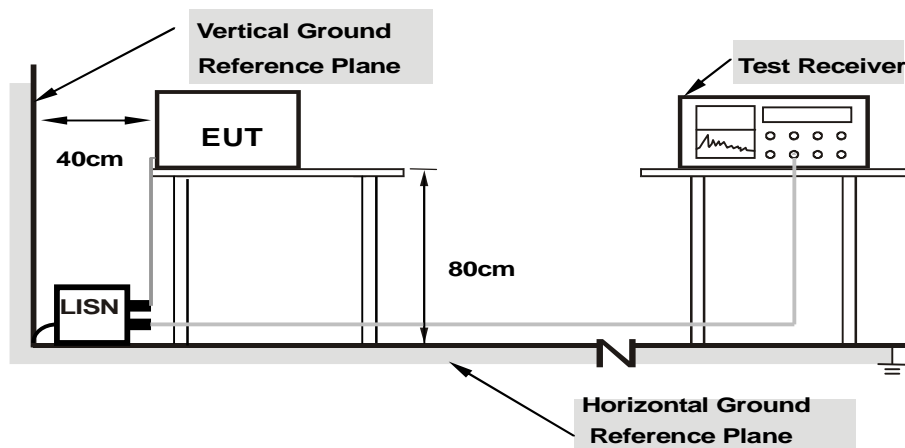

- Note:**
- Support units were connected to second LISN.
 - Both of LISNs (AMN) are 80 cm from EUT and at least 80 from other units and other metal planes

For the actual test configuration, please refer to the attached file (Test Setup Photo).

4.2.6 EUT Operating Condition

Same as 4.1.6.

4.2.7 Test Results

802.11n (HT40): CH46

Phase	Line (L)	Detector Function	Quasi-Peak (QP) / Average (AV)
-------	----------	-------------------	--------------------------------

No	Frequency (MHz)	Correction Factor (dB)	Reading Value (dBuV)		Emission Level (dBuV)		Limit (dBuV)		Margin (dB)	
			Q.P.	AV.	Q.P.	AV.	Q.P.	AV.	Q.P.	AV.
1	0.18125	9.68	13.54	3.26	23.22	12.94	64.43	54.43	-41.21	-41.49
2	0.38828	9.69	16.68	9.08	26.37	18.77	58.10	48.10	-31.73	-29.33
3	1.45313	9.81	14.40	5.77	24.21	15.58	56.00	46.00	-31.79	-30.42
4	2.35156	9.87	17.91	9.32	27.78	19.19	56.00	46.00	-28.22	-26.81
5	3.48438	9.92	20.84	12.86	30.76	22.78	56.00	46.00	-25.24	-23.22
6	4.61719	9.96	22.67	14.99	32.63	24.95	56.00	46.00	-23.37	-21.05

Remarks:

1. Q.P. and AV. are abbreviations of quasi-peak and average individually.
2. The emission levels of other frequencies were very low against the limit.
3. Margin value = Emission level – Limit value
4. Correction factor = Insertion loss + Cable loss
5. Emission Level = Correction Factor + Reading Value

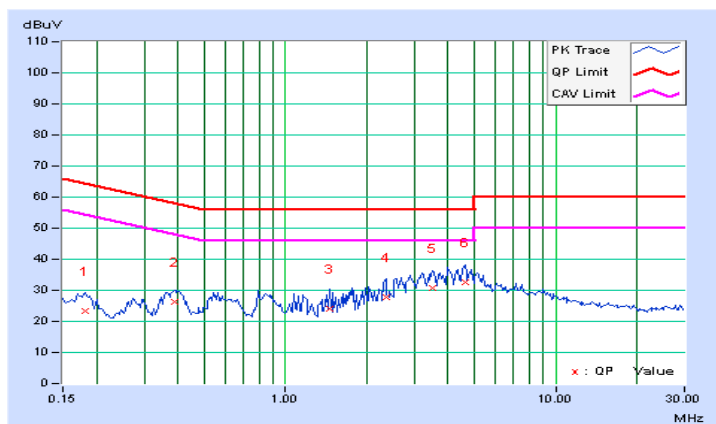

Phase	Neutral (N)	Detector Function	Quasi-Peak (QP) / Average (AV)
-------	-------------	-------------------	--------------------------------

No	Frequency (MHz)	Correction Factor (dB)	Reading Value (dBuV)		Emission Level (dBuV)		Limit (dBuV)		Margin (dB)	
			Q.P.	AV.	Q.P.	AV.	Q.P.	AV.	Q.P.	AV.
1	0.17734	9.73	15.06	5.68	24.79	15.41	64.61	54.61	-39.82	-39.20
2	0.39219	9.74	14.85	9.24	24.59	18.98	58.02	48.02	-33.43	-29.04
3	0.93125	9.78	8.87	2.89	18.65	12.67	56.00	46.00	-37.35	-33.33
4	1.78516	9.84	12.45	5.35	22.29	15.19	56.00	46.00	-33.71	-30.81
5	3.60547	9.96	17.28	10.94	27.24	20.90	56.00	46.00	-28.76	-25.10
6	4.69141	9.99	19.78	13.66	29.77	23.65	56.00	46.00	-26.23	-22.35

Remarks:

1. Q.P. and AV. are abbreviations of quasi-peak and average individually.
2. The emission levels of other frequencies were very low against the limit.
3. Margin value = Emission level – Limit value
4. Correction factor = Insertion loss + Cable loss
5. Emission Level = Correction Factor + Reading Value

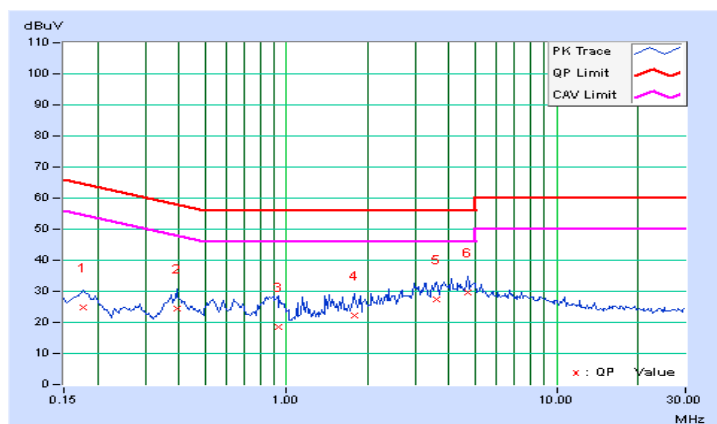

4.3 Transmit Power Measurement

4.3.1 Limits of Transmit Power Measurement

Operation Band	EUT Category		LIMIT
U-NII-1		Outdoor Access Point	1 Watt (30 dBm) (Max. e.i.r.p \leq 125mW(21 dBm) at any elevation angle above 30 degrees as measured from the horizon)
		Fixed point-to-point Access Point	1 Watt (30 dBm)
	√	Indoor Access Point	1 Watt (30 dBm)
		Mobile and Portable client device	250mW (24 dBm)
U-NII-2A	---		250mW (24 dBm) or 11 dBm+10 log B*
U-NII-2C	---		250mW (24 dBm) or 11 dBm+10 log B*
U-NII-3	√		1 Watt (30 dBm)

*B is the 26 dB emission bandwidth in megahertz

Per KDB 662911 Method of conducted output power measurement on IEEE 802.11 devices,

Array Gain = 0 dB (i.e., no array gain) for $N_{ANT} \leq 4$;

Array Gain = 0 dB (i.e., no array gain) for channel widths ≥ 40 MHz for any N_{ANT} ;

Array Gain = $5 \log(N_{ANT}/N_{SS})$ dB or 3 dB, whichever is less for 20-MHz channel widths with $N_{ANT} \geq 5$.

For power measurements on all other devices: Array Gain = $10 \log(N_{ANT}/N_{SS})$ dB.

4.3.2 Test Setup

FOR POWER OUTPUT MEASUREMENT

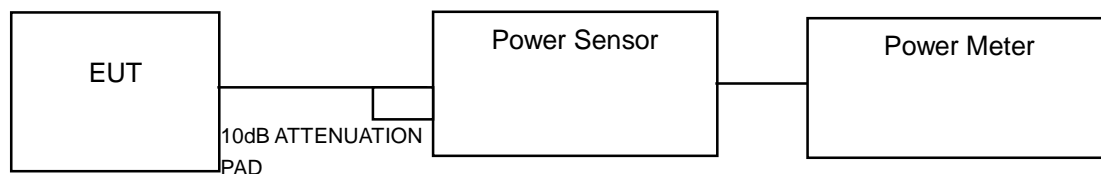

FOR 26dB & OCCUPIED BANDWIDTH

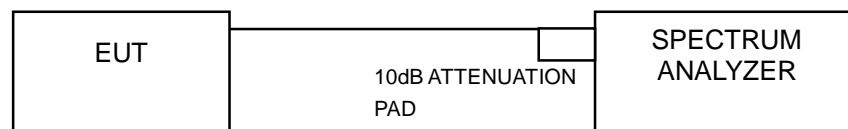

4.3.3 Test Instruments

Refer to section 4.1.2 to get information of above instrument.

4.3.4 Test Procedure

FOR AVERAGE POWER MEASUREMENT

Method PM is used to perform output power measurement, trigger and gating function of wide band power meter is enabled to measure max output power of TX on burst. Duty factor is not added to measured value.

FOR 26 BANDWIDTH

- 1) Set RBW = approximately 1% of the emission bandwidth.
- 2) Set the VBW > RBW.
- 3) Detector = Peak.
- 4) Trace mode = max hold.
- 5) Measure the maximum width of the emission that is 26 dB down from the peak of the emission. Compare this with the RBW setting of the analyzer. Readjust RBW and repeat measurement as needed until the RBW/EBW ratio is approximately 1%.

FOR OCCUPIED BANDWIDTH

The transmitter output was connected to the spectrum analyzer through an attenuator. The bandwidth of the fundamental frequency was measured by spectrum analyzer with resolution bandwidth in the range of 1% to 5% of the anticipated emission bandwidth, and a video bandwidth at least 3x the resolution bandwidth and set the detector to AVERAGE. The width of a frequency band such that, below the lower and above the upper frequency limits, the mean powers emitted are each equal to a specified percentage 0.5 %of the total mean power of a given emission.

4.3.5 Deviation from Test Standard

No deviation.

4.3.6 EUT Operating Condition

The software provided by client to enable the EUT under transmission condition continuously at lowest, middle and highest channel frequencies individually.

4.3.7 Test Result

POWER OUTPUT:

802.11a

CHAN.	FREQ. (MHz)	MAXIMUM CONDUCTED POWER (dBm)		TOTAL POWER (mW)	TOTAL POWER (dBm)	POWER LIMIT (dBm)	PASS / FAIL
		CHAIN 0	CHAIN 1				
36	5180	18.72	18.43	144.136	21.59	30	PASS
40	5200	18.85	18.39	145.76	21.64	30	PASS
48	5240	18.52	18.23	137.648	21.39	30	PASS
149	5745	15.35	15.17	67.162	18.27	30	PASS
157	5785	13.48	13.19	43.129	16.35	30	PASS
165	5825	13.71	13.42	45.475	16.58	30	PASS

802.11n (HT20)

CHAN.	FREQ. (MHz)	MAXIMUM CONDUCTED POWER (dBm)		TOTAL POWER (mW)	TOTAL POWER (dBm)	POWER LIMIT (dBm)	PASS / FAIL
		CHAIN 0	CHAIN 1				
36	5180	19.11	18.82	157.678	21.98	30	PASS
40	5200	19.06	18.74	155.355	21.91	30	PASS
48	5240	18.92	18.59	150.26	21.77	30	PASS
149	5745	13.48	13.19	43.129	16.35	30	PASS
157	5785	13.36	13.21	42.618	16.30	30	PASS
165	5825	13.42	13.30	43.359	16.37	30	PASS

802.11n (HT40)

CHAN.	FREQ. (MHz)	MAXIMUM CONDUCTED POWER (dBm)		TOTAL POWER (mW)	TOTAL POWER (dBm)	POWER LIMIT (dBm)	PASS / FAIL
		CHAIN 0	CHAIN 1				
38	5190	16.23	15.91	80.97	19.08	30	PASS
46	5230	19.12	18.88	158.926	22.01	30	PASS
151	5755	10.95	10.67	24.113	13.82	30	PASS
159	5795	15.38	15.07	66.651	18.24	30	PASS

26dB BANDWIDTH:
802.11a

CHANNEL	CHANNEL FREQUENCY (MHz)	26dBc BANDWIDTH (MHz)		PASS / FAIL
		CHAIN 0	CHAIN 1	
36	5180	36.07	36.10	PASS
40	5200	37.67	37.36	PASS
48	5240	39.78	39.78	PASS

802.11n (HT20)

CHANNEL	CHANNEL FREQUENCY (MHz)	26dBc BANDWIDTH (MHz)		PASS / FAIL
		CHAIN 0	CHAIN 1	
36	5180	40.50	40.52	PASS
40	5200	40.76	40.65	PASS
48	5240	42.73	42.66	PASS

802.11n (HT40)

CHANNEL	CHANNEL FREQUENCY (MHz)	26dBc BANDWIDTH (MHz)		PASS / FAIL
		CHAIN 0	CHAIN 1	
38	5190	47.97	55.45	PASS
46	5230	80.28	81.12	PASS

SPECTRUM PLOT OF WORST VALUE

802.11a

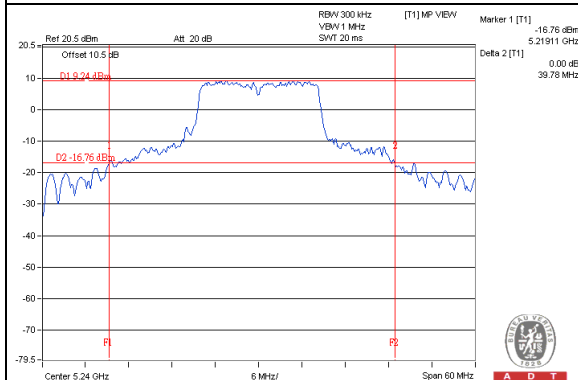

802.11n (HT20)

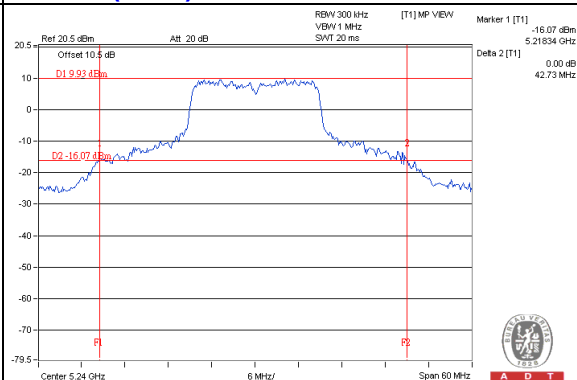

802.11n (HT40)

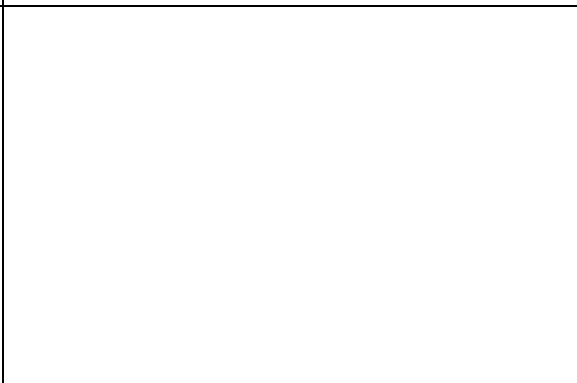
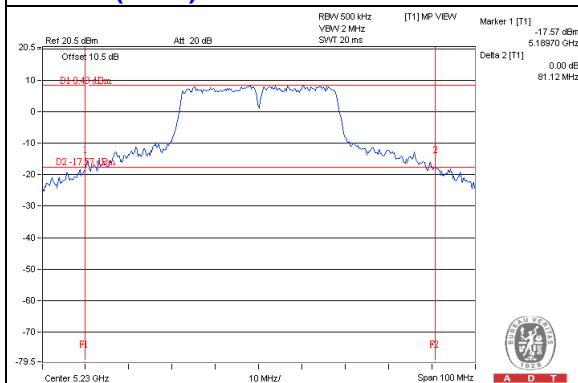

OCCUPIED BANDWIDTH:
802.11a

CHANNEL	CHANNEL FREQUENCY (MHz)	OCCUPIED BANDWIDTH (MHz)		PASS / FAIL
		CHAIN 0	CHAIN 1	
36	5180	18.84	18.72	PASS
40	5200	20.16	20.16	PASS
48	5240	19.74	19.22	PASS
149	5745	17.48	17.00	PASS
157	5785	16.90	17.20	PASS
165	5825	16.90	16.90	PASS

802.11n (HT20)

CHANNEL	CHANNEL FREQUENCY (MHz)	OCCUPIED BANDWIDTH (MHz)		PASS / FAIL
		CHAIN 0	CHAIN 1	
36	5180	20.64	20.28	PASS
40	5200	21.60	21.00	PASS
48	5240	18.78	18.70	PASS
149	5745	17.91	18.00	PASS
157	5785	18.00	18.00	PASS
165	5825	18.10	18.00	PASS

802.11n (HT40)

CHANNEL	CHANNEL FREQUENCY (MHz)	OCCUPIED BANDWIDTH (MHz)		PASS / FAIL
		CHAIN 0	CHAIN 1	
38	5190	37.60	37.20	PASS
46	5230	38.99	38.55	PASS
151	5755	37.39	37.17	PASS
159	5795	38.50	38.17	PASS

SPECTRUM PLOT OF WORST VALUE

802.11a

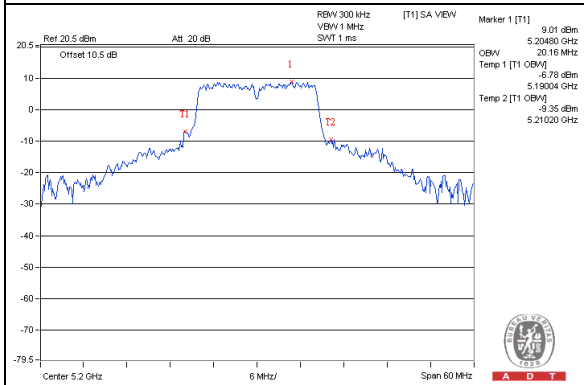

802.11n (HT20)

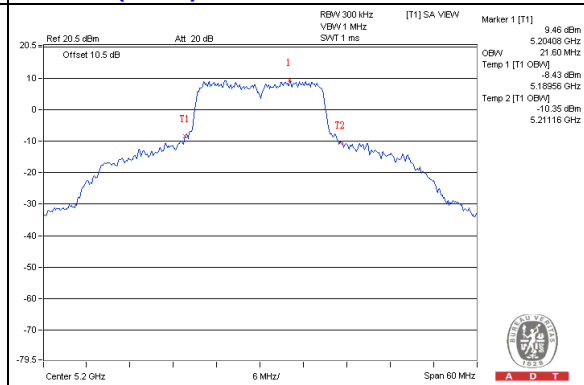

802.11n (HT40)

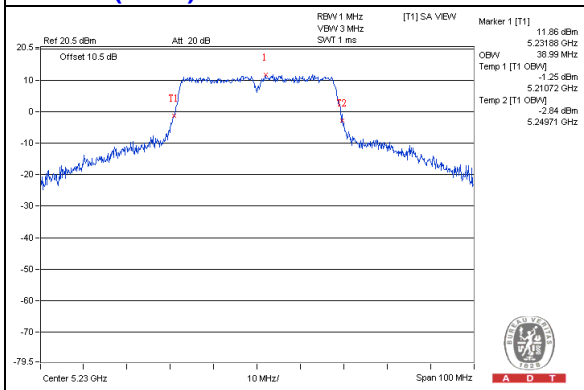

4.4 Peak Power Spectral Density Measurement

4.4.1 Limits of Peak Power Spectral Density Measurement

Operation Band	EUT Category		LIMIT
U-NII-1		Outdoor Access Point	17dBm/ MHz
		Fixed point-to-point Access Point	
	√	Indoor Access Point	
		Mobile and Portable client device	11dBm/ MHz
U-NII-2A	---		11dBm/ MHz
U-NII-2C	---		11dBm/ MHz
U-NII-3	√		30dBm/ 500kHz

4.4.2 Test Setup

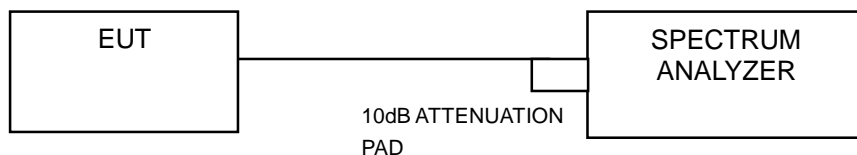

4.4.3 Test Instruments

Refer to section 4.1.2 to get information of above instrument.

4.4.4 Test Procedure

For U-NII-1 band:

Using method SA-2

- 1) Set span to encompass the entire emission bandwidth (EBW) of the signal.
- 2) Set RBW = 1 MHz, Set VBW ≥ 3 MHz, Detector = RMS
- 3) Sweep time = auto, trigger set to “free run”.
- 4) Trace average at least 100 traces in power averaging mode.
- 5) Record the max value and add 10 log (1/duty cycle)

For U-NII-3 band:

- 1) Set span to encompass the entire emission bandwidth (EBW) of the signal.
- 2) Set RBW = 500 kHz, Set VBW ≥ 3 RBW, Detector = RMS
- 3) Sweep time = auto, trigger set to “free run”.
- 4) Trace average at least 100 traces in power averaging mode.
- 5) Record the max value and add 10 log (1/duty cycle)
- 6) Scale the observed power level to an equivalent value in 500 kHz by adjusting (reducing) the measured power by a bandwidth correction factor (BWCF) where BWCF = 10log(500 kHz/300kHz)

4.4.5 Deviation from Test Standard

No deviation.

4.4.6 EUT Operating Condition

Same as Item 4.3.6.

4.4.7 Test Results

For U-NII-1 Band 802.11a

CHAN.	FREQ. (MHz)	PSD (dBm)		TOTAL PSD W/O DUTY FACTOR (dBm)	DUTY FACTOR	TOTAL PSD WITH DUTY FACTOR (dBm)	MAX. LIMIT (dBm)	PASS / FAIL
		CHAIN 0	CHAIN 1					
36	5180	5.18	5.19	8.20	0.59	8.79	16.39	PASS
40	5200	5.76	5.54	8.66	0.59	9.25	16.39	PASS
48	5240	5.85	5.67	8.77	0.59	9.36	16.39	PASS

1. Method 1 of power density measurement of KDB 662911 is using for calculating total power density. Total power density is summing entire spectra across corresponding frequency bins on the various outputs by computer.

2. For U-NII-1 Band:

Directional gain = $3.60\text{dBi} + 10\log(2) = 6.61\text{dBi} > 6\text{dBi}$, so the power density limit shall be reduced to $17-(6.61-6) = 16.39\text{dBm}$.

3. Refer to section 3.3 for duty cycle spectrum plot.

802.11n (HT20)

CHAN.	FREQ. (MHz)	PSD (dBm)		TOTAL PSD W/O DUTY FACTOR (dBm)	DUTY FACTOR	TOTAL PSD WITH DUTY FACTOR (dBm)	MAX. LIMIT (dBm)	PASS / FAIL
		CHAIN 0	CHAIN 1					
36	5180	5.79	5.24	8.53	0.49	9.02	16.39	PASS
40	5200	5.36	5.47	8.42	0.49	8.91	16.39	PASS
48	5240	5.75	5.65	8.71	0.49	9.20	16.39	PASS

NOTE:

1. Method 1 of power density measurement of KDB 662911 is using for calculating total power density. Total power density is summing entire spectra across corresponding frequency bins on the various outputs by computer.

2. For U-NII-1 Band:

Directional gain = $3.60\text{dBi} + 10\log(2) = 6.61\text{dBi} > 6\text{dBi}$, so the power density limit shall be reduced to $17-(6.61-6) = 16.39\text{dBm}$.

3. Refer to section 3.3 for duty cycle spectrum plot.

802.11n (HT40)

CHAN.	FREQ. (MHz)	PSD (dBm)		TOTAL PSD W/O DUTY FACTOR (dBm)	DUTY FACTOR	TOTAL PSD WITH DUTY FACTOR (dBm)	MAX. LIMIT (dBm)	PASS / FAIL
		CHAIN 0	CHAIN 1					
38	5190	-0.15	-0.88	2.51	1.01	3.52	16.39	PASS
46	5230	2.26	2.62	5.46	1.01	6.47	16.39	PASS

NOTE:

1. Method 1 of power density measurement of KDB 662911 is using for calculating total power density. Total power density is summing entire spectra across corresponding frequency bins on the various outputs by computer.

2. For U-NII-1 Band:

Directional gain = $3.60\text{dBi} + 10\log(2) = 6.61\text{dBi} > 6\text{dBi}$, so the power density limit shall be reduced to $17-(6.61-6) = 16.39\text{dBm}$.

3. Refer to section 3.3 for duty cycle spectrum plot.

SPECTRUM PLOT OF WORST VALUE

802.11a

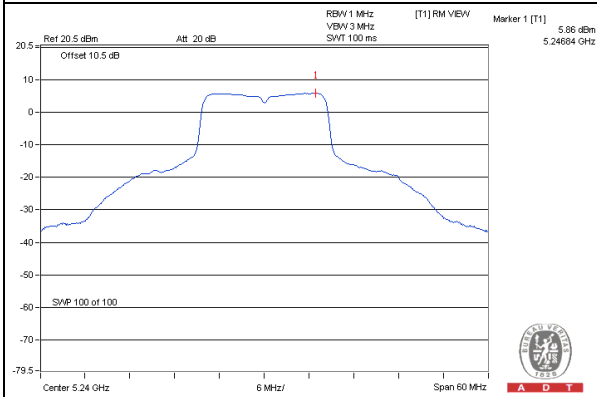

802.11n (HT20)

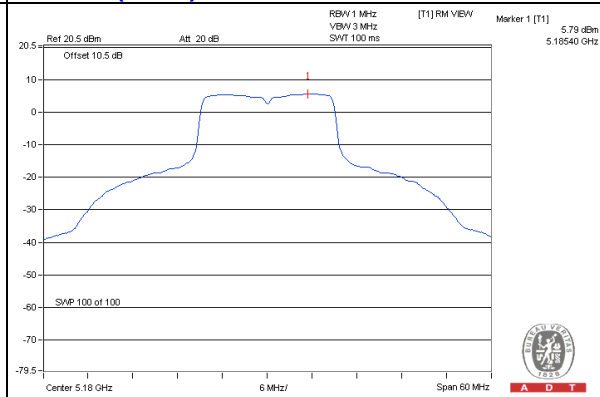

802.11n (HT40)

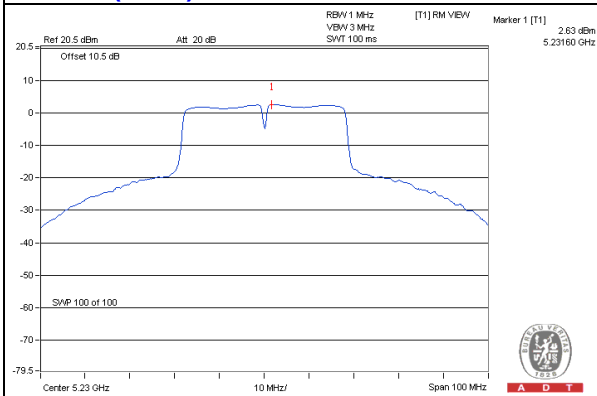

For U-NII-3 Band

802.11a

TX chain	Channel	Freq. (MHz)	PSD (dBm/500kHz)	10 log (N=2) dB	DUTY FACTOR	Total PSD (dBm/500kHz)	Limit (dBm/500kHz)	PASS /FAIL
0	149	5745	7.29	3.01	0.59	10.89	29.39	PASS
	157	5785	5.92	3.01	0.59	9.52	29.39	PASS
	165	5825	5.84	3.01	0.59	9.44	29.39	PASS
1	149	5745	6.90	3.01	0.59	10.50	29.39	PASS
	157	5785	6.20	3.01	0.59	9.80	29.39	PASS
	165	5825	5.74	3.01	0.59	9.34	29.39	PASS

NOTE: Directional gain = $3.60\text{dBi} + 10\log(2) = 6.61 > 6\text{dBi}$, so the power density limit shall be reduced to $30 - (6.61 - 6) = 29.39\text{dBm}$.

802.11n (HT20)

TX chain	Channel	Freq. (MHz)	PSD (dBm/500kHz)	10 log (N=2) dB	DUTY FACTOR	Total PSD (dBm/500kHz)	Limit (dBm/500kHz)	PASS /FAIL
0	149	5745	5.84	3.01	0.49	9.34	29.39	PASS
	157	5785	5.40	3.01	0.49	8.90	29.39	PASS
	165	5825	5.52	3.01	0.49	9.02	29.39	PASS
1	149	5745	5.62	3.01	0.49	9.12	29.39	PASS
	157	5785	5.41	3.01	0.49	8.91	29.39	PASS
	165	5825	5.47	3.01	0.49	8.97	29.39	PASS

NOTE: Directional gain = $3.60\text{dBi} + 10\log(2) = 6.61 > 6\text{dBi}$, so the power density limit shall be reduced to $30 - (6.61 - 6) = 29.39\text{dBm}$.

802.11n (HT40)

TX chain	Channel	Freq. (MHz)	PSD (dBm/500kHz)	10 log (N=2) dB	DUTY FACTOR	Total PSD (dBm/500kHz)	Limit (dBm/500kHz)	PASS /FAIL
0	151	5755	1.11	3.01	1.01	5.13	29.39	PASS
	159	5795	5.51	3.01	1.01	9.53	29.39	PASS
1	151	5755	1.02	3.01	1.01	5.04	29.39	PASS
	159	5795	5.36	3.01	1.01	9.38	29.39	PASS

NOTE: Directional gain = $3.60\text{dBi} + 10\log(2) = 6.61 > 6\text{dBi}$, so the power density limit shall be reduced to $30 - (6.61 - 6) = 29.39\text{dBm}$.

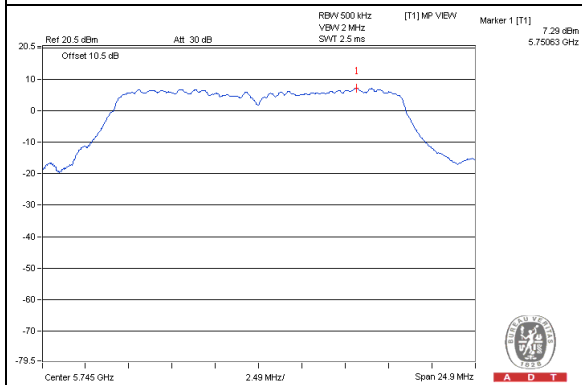
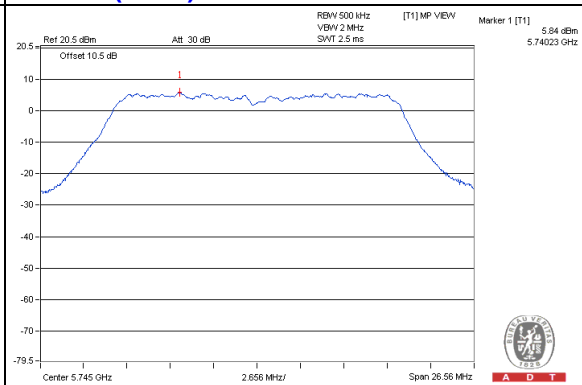
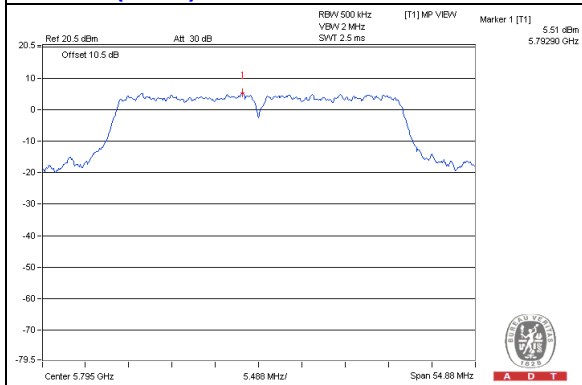
SPECTRUM PLOT OF WORST VALUE**802.11a****802.11n (HT20)****802.11n (HT40)**

4.5 Frequency Stability Measurement

4.5.1 Limits of Frequency Stability Measurement

The frequency of the carrier signal shall be maintained within band of operation

4.5.2 Test Setup

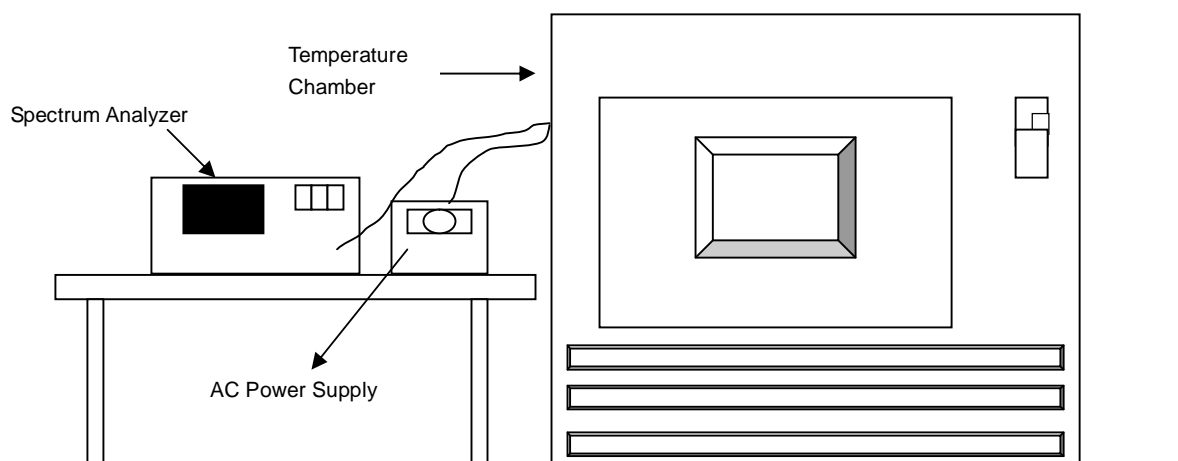

4.5.3 Test Instruments

Refer to section 4.1.2 to get information of above instrument.

4.5.4 Test Procedure

- The EUT was placed inside the environmental test chamber and powered by nominal AC voltage.
- Turn the EUT on and couple its output to a spectrum analyzer.
- Turn the EUT off and set the chamber to the highest temperature specified.
- Allow sufficient time (approximately 30 min) for the temperature of the chamber to stabilize, turn the EUT on and measure the operating frequency after 2, 5, and 10 minutes.
- Repeat step 2 and 3 with the temperature chamber set to the lowest temperature.
- The test chamber was allowed to stabilize at +20 degree C for a minimum of 30 minutes. The supply voltage was then adjusted on the EUT from 85% to 115% and the frequency record.

4.5.5 Deviation from Test Standard

No deviation.

4.5.6 EUT Operating Condition

Set the EUT transmit at un-modulation mode to test frequency stability.

4.5.7 Test Results

FREQUENCY STABILITY VERSUS TEMP.									
OPERATING FREQUENCY: 5180MHz									
TEMP. (°C)	POWER SUPPLY (Vac)	0 MINUTE		2 MINUTE		5 MINUTE		10 MINUTE	
		Measured Frequency (MHz)	Frequency Drift (ppm)	Measured Frequency (MHz)	Frequency Drift (ppm)	Measured Frequency (MHz)	Frequency Drift (ppm)	Measured Frequency (MHz)	Frequency Drift (ppm)
50	120	5180.042616	8.2270925	5180.043119	8.3241313	5180.042643	8.2322394	5180.042795	8.2615830
40	120	5180.043039	8.3087623	5180.043632	8.4231660	5180.043304	8.3598456	5180.04325	8.3494208
30	120	5180.043631	8.4229943	5180.043136	8.3274131	5180.042809	8.2642857	5180.042915	8.2847490
20	120	5180.042764	8.2555735	5180.042743	8.2515444	5180.042523	8.2090734	5180.04245	8.1949807
10	120	5180.042655	8.2346482	5180.04301	8.3030888	5180.043237	8.3469112	5180.043037	8.3083012
0	120	5180.043233	8.3461434	5180.04328	8.3552124	5180.043141	8.3283784	5180.043002	8.3015444
-10	120	5180.043463	8.3905138	5180.042822	8.2667954	5180.042756	8.2540541	5180.042834	8.2691120
-20	120	5180.042845	8.2711574	5180.043037	8.3083012	5180.042985	8.2982625	5180.042968	8.2949807

FREQUENCY STABILITY VERSUS VOLTAGE									
OPERATING FREQUENCY: 5180MHz									
TEMP. (°C)	POWER SUPPLY (Vac)	0 MINUTE		2 MINUTE		5 MINUTE		10 MINUTE	
		Measured Frequency (MHz)	Frequency Drift (ppm)	Measured Frequency (MHz)	Frequency Drift (ppm)	Measured Frequency (MHz)	Frequency Drift (ppm)	Measured Frequency (MHz)	Frequency Drift (ppm)
20	138	5180.043238	8.3470697	5180.042766	8.2559846	5180.042812	8.2648649	5180.042999	8.3009653
	120	5180.042764	8.2555735	5180.042743	8.2515444	5180.042523	8.2090734	5180.04245	8.1949807
	102	5180.042159	8.1388545	5180.042144	8.1359073	5180.042340	8.1737452	5180.042316	8.1691120

4.6 6dB Bandwidth Measurement

4.6.1 Limits of 6dB Bandwidth Measurement

The minimum of 6dB Bandwidth Measurement is 0.5MHz.

4.6.2 Test Setup

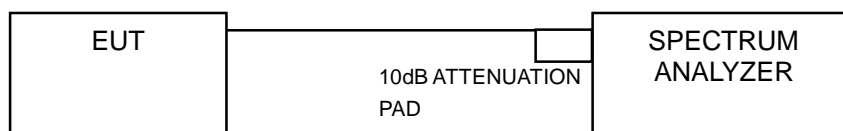

4.6.3 Test Instruments

Refer to section 4.1.2 to get information of above instrument.

4.6.4 Test Procedure

MEASUREMENT PROCEDURE REF

- Set resolution bandwidth (RBW) = 100kHz
- Set the video bandwidth (VBW) $\geq 3 \times$ RBW, Detector = Peak.
- Trace mode = max hold.
- Sweep = auto couple.
- Measure the maximum width of the emission that is constrained by the frequencies associated with the two amplitude points (upper and lower) that are attenuated by 6 dB relative to the maximum level measured in the fundamental emission

4.6.5 Deviation from Test Standard

No deviation.

4.6.6 EUT Operating Condition

The software provided by client to enable the EUT under transmission condition continuously at lowest, middle and highest channel frequencies individually.

4.6.7 Test Results

802.11a

CHANNEL	FREQUENCY (MHz)	6dB BANDWIDTH (MHz)		MINIMUM LIMIT (MHz)	PASS / FAIL
		CHAIN 0	CHAIN 1		
149	5745	16.60	16.61	0.5	PASS
157	5785	16.60	16.62	0.5	PASS
165	5825	16.61	16.61	0.5	PASS

802.11n (HT20)

CHANNEL	FREQUENCY (MHz)	6dB BANDWIDTH (MHz)		MINIMUM LIMIT (MHz)	PASS / FAIL
		CHAIN 0	CHAIN 1		
149	5745	17.71	17.80	0.5	PASS
157	5785	17.79	17.82	0.5	PASS
165	5825	17.80	17.76	0.5	PASS

802.11n (HT40)

CHANNEL	FREQUENCY (MHz)	6dB BANDWIDTH (MHz)		MINIMUM LIMIT (MHz)	PASS / FAIL
		CHAIN 0	CHAIN 1		
151	5755	36.60	36.60	0.5	PASS
159	5795	36.59	36.60	0.5	PASS

SPECTRUM PLOT OF WORST VALUE

802.11a

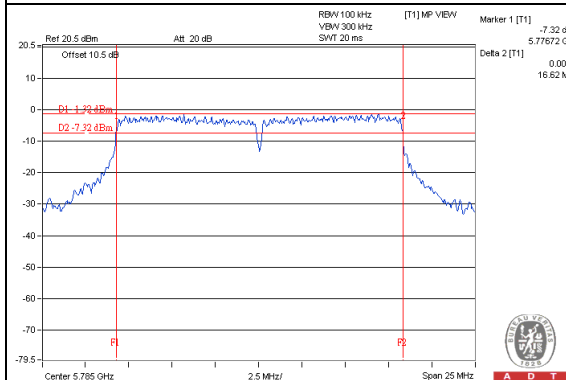

802.11n (HT20)

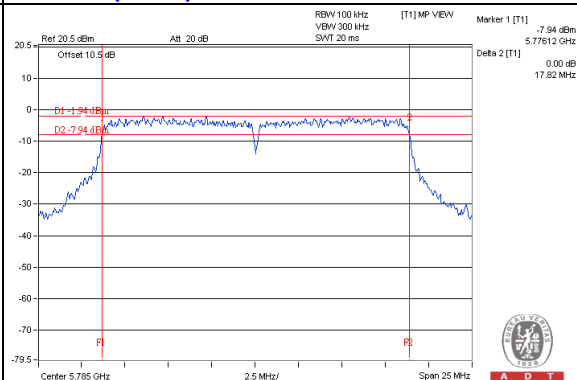

802.11n (HT40)

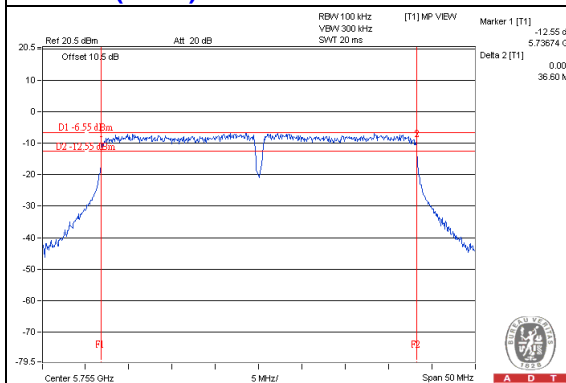

5 Pictures of Test Arrangements

Please refer to the attached file (Test Setup Photo).

Appendix – Information on the Testing Laboratories

We, Bureau Veritas Consumer Products Services (H.K.) Ltd., Taoyuan Branch, were founded in 1988 to provide our best service in EMC, Radio, Telecom and Safety consultation. Our laboratories are accredited and approved according to ISO/IEC 17025.

If you have any comments, please feel free to contact us at the following:

Linko EMC/RF Lab

Tel: 886-2-26052180

Fax: 886-2-26051924

Hsin Chu EMC/RF Lab/Telecom Lab

Tel: 886-3-5935343

Fax: 886-3-5935342

Hwa Ya EMC/RF/Safety

Tel: 886-3-3183232

Fax: 886-3-3270892

Email: service.adt@tw.bureauveritas.com

Web Site: www.bureauveritas-adt.com

The address and road map of all our labs can be found in our web site also.

--- END ---