

FCC Test Report (Co-Located)

Report No.: RF190528D02-3

FCC ID: P27TP20213425

Test Model: INTTP20213425

Received Date: May 28, 2019

Test Date: Jul. 5 to 8, 2019

Issued Date: Jul. 19, 2019

Applicant: Sercomm Corp.

Address: 8F, No. 3-1, YuanQu St., NanKang, Taipei 115, Taiwan, R.O.C. (NanKang Software Park)

Issued By: Bureau Veritas Consumer Products Services (H.K.) Ltd., Taoyuan Branch

Lab Address: No. 47-2, 14th Ling, Chia Pau Vil., Lin Kou Dist., New Taipei City, Taiwan (R.O.C.)

**FCC Registration /
Designation Number:** 198487 / TW2021



This report is for your exclusive use. Any copying or replication of this report to or for any other person or entity, or use of our name or trademark, is permitted only with our prior written permission. This report sets forth our findings solely with respect to the test samples identified herein. The results set forth in this report are not indicative or representative of the quality or characteristics of the lot from which a test sample was taken or any similar or identical product unless specifically and expressly noted. Our report includes all of the tests requested by you and the results thereof based upon the information that you provided to us. You have 60 days from date of issuance of this report to notify us of any material error or omission caused by our negligence, provided, however, that such notice shall be in writing and shall specifically address the issue you wish to raise. A failure to raise such issue within the prescribed time shall constitute your unqualified acceptance of the completeness of this report, the tests conducted and the correctness of the report contents. Unless specific mention, the uncertainty of measurement has been explicitly taken into account to declare the compliance or non-compliance to the specification. The report must not be used by the client to claim product certification, approval, or endorsement by TAF or any government agencies.

Table of Contents

Release Control Record	3
1 Certificate of Conformity	4
2 Summary of Test Results	5
2.1 Measurement Uncertainty.....	5
2.2 Modification Record.....	5
3 General Information	6
3.1 General Description of EUT.....	6
3.2 Test Mode Applicability and Tested Channel Detail.....	7
3.3 Description of Support Units.....	11
3.3.1 Configuration of System under Test.....	11
3.4 General Description of Applied Standard.....	12
4 Test Types and Results	13
4.1 Radiated Emission and Bandedge Measurement.....	13
4.1.1 Limits of Radiated Emission and Bandedge Measurement.....	13
4.1.2 Test Instruments.....	13
4.1.3 Test Procedure.....	14
4.1.4 Deviation from Test Standard.....	14
4.1.5 Test Setup.....	15
4.1.6 EUT Operating Condition.....	15
4.1.7 Test Results (Mode A).....	16
4.1.8 Test Results (Mode B).....	17
4.1.9 Test Results (Mode C).....	18
4.1.10 Test Results (Mode D).....	19
4.1.11 Test Results (Mode E).....	20
4.1.12 Test Results (Mode F).....	21
4.1.13 Test Results (Mode G).....	22
4.1.14 Test Results (Mode H).....	23
4.2 Conducted Spurious Emissions.....	24
4.2.1 Limits of Conducted Spurious Emissions Measurement.....	24
4.2.2 Test Setup.....	24
4.2.3 Test Procedure.....	24
4.2.4 Test Results (Mode A).....	25
4.2.5 Test Results (Mode B).....	28
4.2.6 Test Results (Mode C).....	31
4.2.7 Test Results (Mode D).....	34
4.2.8 Test Results (Mode E).....	37
4.2.9 Test Results (Mode F).....	38
4.2.10 Test Results (Mode G).....	39
4.2.11 Test Results (Mode H).....	40
5 Pictures of Test Arrangements	41
Appendix – Information of the Testing Laboratories	42

Release Control Record

Issue No.	Description	Date Issued
RF190528D02-3	Original release.	Jul. 19, 2019

1 Certificate of Conformity

Product: Verizon LTE

Brand: Verizon

Test Model: INTTP20213425

Sample Status: Engineering sample

Applicant: Sercomm Corp.

Test Date: Jul. 5 to 8, 2019

Standard: FCC Part 22, Subpart H
FCC Part 24, Subpart E
FCC Part 27, Subpart C

The above equipment has been tested by **Bureau Veritas Consumer Products Services (H.K.) Ltd., Taoyuan Branch**, and found compliance with the requirement of the above standards. The test record, data evaluation & Equipment Under Test (EUT) configurations represented herein are true and accurate accounts of the measurements of the sample's RF characteristics under the conditions specified in this report.

Prepared by :



Date: Jul. 19, 2019

Celia Chen / Supervisor

Approved by :



Date: Jul. 19, 2019

Rex Lai / Associate Technical Manager

2 Summary of Test Results

FCC Part 22, Part 24, Part 27, Part 2			
FCC Clause	Test Item	Result	Remarks
2.1053 22.917 24.238 24.238(a) 2.1051 27.53(h)(c)	Radiated Emissions & Band Edge Measurement	Pass	Meet the requirement of limit. Minimum passing margin is -26.67dB at 3874.51MHz.
2.1051 22.917 24.238 27.53(h) 27.53(c)	Conducted Spurious Emissions	Pass	Meet the requirement of limit.

Note: Determining compliance based on the results of the compliance measurement, not taking into account measurement instrumentation uncertainty.

2.1 Measurement Uncertainty

Where relevant, the following measurement uncertainty levels have been estimated for tests performed on the EUT as specified in CISPR 16-4-2:

Measurement	Frequency	Expanded Uncertainty (k=2) (±)
Radiated Emissions up to 1 GHz	30MHz ~ 1000MHz	5.43 dB
Radiated Emissions above 1 GHz	1GHz ~ 40GHz	5.42 dB

2.2 Modification Record

There were no modifications required for compliance.

3 General Information

3.1 General Description of EUT

Product	Verizon LTE		
Brand	Verizon		
Test Model	INTTP20213425		
Status of EUT	Engineering sample		
Power Supply Rating	12Vdc (adapter)		
Modulation Type	QPSK, 16QAM, 64QAM		
Operating Frequency	LTE Band 2	Channel Bandwidth 10MHz	1935MHz ~ 1985MHz
		Channel Bandwidth 20MHz	1940MHz ~ 1980MHz
	LTE Band 4	Channel Bandwidth 10MHz	2115MHz ~ 2150MHz
		Channel Bandwidth 20MHz	2120MHz ~ 2145MHz
	LTE Band 5	Channel Bandwidth 10MHz	874MHz ~ 889MHz
	LTE Band 13	Channel Bandwidth 10MHz	746MHz ~ 756MHz
Max. EIRP Power	LTE Band 2	Channel Bandwidth 10MHz	466.659mW (26.69dBm)
		Channel Bandwidth 20MHz	451.856mW (26.55dBm)
	LTE Band 4	Channel Bandwidth 10MHz	325.087mW (25.12dBm)
		Channel Bandwidth 20MHz	288.403mW (24.60dBm)
Max. ERP Power	LTE Band 5	Channel Bandwidth 10MHz	337.287mW (25.28dBm)
	LTE Band 13	Channel Bandwidth 10MHz	327.341mW (25.15dBm)
Antenna Type	LTE Band 2	Dipole antenna with 2.5dBi gain	
	LTE Band 4	Dipole antenna with 2.5dBi gain	
	LTE Band 5	Dipole antenna with 3.2dBi gain	
	LTE Band 13	Dipole antenna with 1.0dBi gain	
Antenna Connector	RP-SMA		
Accessory Device	Adapter		
Data Cable Supplied	Non-shielded GPS Antenna (9m)*2		

Note:

1. The EUT uses following adapter.

Brand	PHIHONG
Model	PSA120U-120L6
Input Power	100-240Vac, 1.6A, 50-60Hz
Output Power	12Vdc, 9A
Power Line	Non-shielded AC 3 Pin (1.8m) Non-shielded DC cable (1.5m) with one ferrite core

2. The worst channel for each band are as follows:

LTE Band	Channel Bandwidth / CPU / Modulation Type / Channel
2	Channel Bandwidth 10MHz / CPU2 / QPSK / Low channel
	Channel Bandwidth 20MHz / CPU2 / QPSK / Low channel
4	Channel Bandwidth 10MHz / CPU1 / QPSK / Low channel
	Channel Bandwidth 20MHz / CPU1 / QPSK / Low channel
5	Channel Bandwidth 10MHz / CPU2 / QPSK / Low channel
13	Channel Bandwidth 10MHz / CPU1 / QPSK / Low channel

3. The above EUT information is declared by manufacturer and for more detailed features description, please refer to the manufacturer's specifications or user's manual.

3.2 Test Mode Applicability and Tested Channel Detail

EUT CONFIGURE MODE	APPLICABLE TO			DESCRIPTION
	RE \geq 1G	RE $<$ 1G	CE	
A	√	√	√	CA-1 Mode: LTE Band 4 CPU1 (CBW: 10MHz) + LTE Band 13 CPU1 (CBW: 10MHz)
B	√	√	√	CA-1 Mode: LTE Band 4 CPU1 (CBW: 20MHz) + LTE Band 13 CPU1 (CBW: 10MHz)
C	√	√	√	CA-2 Mode: LTE Band 2 CPU2 (CBW: 10MHz) + LTE Band 5 CPU2 (CBW: 10MHz)
D	√	√	√	CA-2 Mode: LTE Band 2 CPU2 (CBW: 20MHz) + LTE Band 5 CPU2 (CBW: 10MHz)
E	√	√	√	CA-1 + CA-2 Mode: LTE Band 4 CPU1 (CBW: 10MHz) + LTE Band 13 CPU1 (CBW: 10MHz) + LTE Band 2 CPU2 (CBW: 10MHz) + LTE Band 5 CPU2 (CBW: 10MHz)
F	√	√	√	CA-1 + CA-2 Mode: LTE Band 4 CPU1 (CBW: 10MHz) + LTE Band 13 CPU1 (CBW: 10MHz) + LTE Band 2 CPU2 (CBW: 20MHz) + LTE Band 5 CPU2 (CBW: 10MHz)
G	√	√	√	CA-1 + CA-2 Mode: LTE Band 4 CPU1 (CBW: 20MHz) + LTE Band 13 CPU1 (CBW: 10MHz) + LTE Band 2 CPU2 (CBW: 10MHz) + LTE Band 5 CPU2 (CBW: 10MHz)
H	√	√	√	CA-1 + CA-2 Mode: LTE Band 4 CPU1 (CBW: 20MHz) + LTE Band 13 CPU1 (CBW: 10MHz) + LTE Band 2 CPU2 (CBW: 20MHz) + LTE Band 5 CPU2 (CBW: 10MHz)

Where **RE \geq 1G**: Radiated Emission above 1GHz **RE $<$ 1G**: Radiated Emission below 1GHz
CE: Conducted Emission

Radiated Emission Test (Above 1GHz):

- Pre-Scan has been conducted to determine the worst-case mode from all possible combinations between available modulations, data rates and antenna ports (if EUT with antenna diversity architecture).
- Following channel(s) was (were) selected for the final test as listed below.

EUT CONFIGURE MODE	MODE
A	CA-1 Mode: LTE Band 4 CPU1 (CBW: 10MHz) + LTE Band 13 CPU1 (CBW: 10MHz)
B	CA-1 Mode: LTE Band 4 CPU1 (CBW: 20MHz) + LTE Band 13 CPU1 (CBW: 10MHz)
C	CA-2 Mode: LTE Band 2 CPU2 (CBW: 10MHz) + LTE Band 5 CPU2 (CBW: 10MHz)
D	CA-2 Mode: LTE Band 2 CPU2 (CBW: 20MHz) + LTE Band 5 CPU2 (CBW: 10MHz)
E	CA-1 + CA-2 Mode: LTE Band 4 CPU1 (CBW: 10MHz) + LTE Band 13 CPU1 (CBW: 10MHz) + LTE Band 2 CPU2 (CBW: 10MHz) + LTE Band 5 CPU2 (CBW: 10MHz)
F	CA-1 + CA-2 Mode: LTE Band 4 CPU1 (CBW: 10MHz) + LTE Band 13 CPU1 (CBW: 10MHz) + LTE Band 2 CPU2 (CBW: 20MHz) + LTE Band 5 CPU2 (CBW: 10MHz)
G	CA-1 + CA-2 Mode: LTE Band 4 CPU1 (CBW: 20MHz) + LTE Band 13 CPU1 (CBW: 10MHz) + LTE Band 2 CPU2 (CBW: 10MHz) + LTE Band 5 CPU2 (CBW: 10MHz)
H	CA-1 + CA-2 Mode: LTE Band 4 CPU1 (CBW: 20MHz) + LTE Band 13 CPU1 (CBW: 10MHz) + LTE Band 2 CPU2 (CBW: 20MHz) + LTE Band 5 CPU2 (CBW: 10MHz)

Radiated Emission Test (Below 1GHz):

- Pre-Scan has been conducted to determine the worst-case mode from all possible combinations between available modulations, data rates and antenna ports (if EUT with antenna diversity architecture).
- Following channel(s) was (were) selected for the final test as listed below.

EUT CONFIGURE MODE	MODE
A	CA-1 Mode: LTE Band 4 CPU1 (CBW: 10MHz) + LTE Band 13 CPU1 (CBW: 10MHz)
B	CA-1 Mode: LTE Band 4 CPU1 (CBW: 20MHz) + LTE Band 13 CPU1 (CBW: 10MHz)
C	CA-2 Mode: LTE Band 2 CPU2 (CBW: 10MHz) + LTE Band 5 CPU2 (CBW: 10MHz)
D	CA-2 Mode: LTE Band 2 CPU2 (CBW: 20MHz) + LTE Band 5 CPU2 (CBW: 10MHz)
E	CA-1 + CA-2 Mode: LTE Band 4 CPU1 (CBW: 10MHz) + LTE Band 13 CPU1 (CBW: 10MHz) + LTE Band 2 CPU2 (CBW: 10MHz) + LTE Band 5 CPU2 (CBW: 10MHz)
F	CA-1 + CA-2 Mode: LTE Band 4 CPU1 (CBW: 10MHz) + LTE Band 13 CPU1 (CBW: 10MHz) + LTE Band 2 CPU2 (CBW: 20MHz) + LTE Band 5 CPU2 (CBW: 10MHz)
G	CA-1 + CA-2 Mode: LTE Band 4 CPU1 (CBW: 20MHz) + LTE Band 13 CPU1 (CBW: 10MHz) + LTE Band 2 CPU2 (CBW: 10MHz) + LTE Band 5 CPU2 (CBW: 10MHz)
H	CA-1 + CA-2 Mode: LTE Band 4 CPU1 (CBW: 20MHz) + LTE Band 13 CPU1 (CBW: 10MHz) + LTE Band 2 CPU2 (CBW: 20MHz) + LTE Band 5 CPU2 (CBW: 10MHz)

Conducted Emission

- Pre-Scan has been conducted to determine the worst-case mode from all possible combinations between available modulations, data rates and antenna ports (if EUT with antenna diversity architecture).
- Following channel(s) was (were) selected for the final test as listed below.

EUT CONFIGURE MODE	MODE
A	CA-1 Mode: LTE Band 4 CPU1 (CBW: 10MHz) + LTE Band 13 CPU1 (CBW: 10MHz)
B	CA-1 Mode: LTE Band 4 CPU1 (CBW: 20MHz) + LTE Band 13 CPU1 (CBW: 10MHz)
C	CA-2 Mode: LTE Band 2 CPU2 (CBW: 10MHz) + LTE Band 5 CPU2 (CBW: 10MHz)
D	CA-2 Mode: LTE Band 2 CPU2 (CBW: 20MHz) + LTE Band 5 CPU2 (CBW: 10MHz)
E	CA-1 + CA-2 Mode: LTE Band 4 CPU1 (CBW: 10MHz) + LTE Band 13 CPU1 (CBW: 10MHz) + LTE Band 2 CPU2 (CBW: 10MHz) + LTE Band 5 CPU2 (CBW: 10MHz)
F	CA-1 + CA-2 Mode: LTE Band 4 CPU1 (CBW: 10MHz) + LTE Band 13 CPU1 (CBW: 10MHz) + LTE Band 2 CPU2 (CBW: 20MHz) + LTE Band 5 CPU2 (CBW: 10MHz)
G	CA-1 + CA-2 Mode: LTE Band 4 CPU1 (CBW: 20MHz) + LTE Band 13 CPU1 (CBW: 10MHz) + LTE Band 2 CPU2 (CBW: 10MHz) + LTE Band 5 CPU2 (CBW: 10MHz)
H	CA-1 + CA-2 Mode: LTE Band 4 CPU1 (CBW: 20MHz) + LTE Band 13 CPU1 (CBW: 10MHz) + LTE Band 2 CPU2 (CBW: 20MHz) + LTE Band 5 CPU2 (CBW: 10MHz)

Test Condition:

Applicable To	Environmental Conditions	Input Power	Tested By
RE \geq 1G	32deg. C, 61%RH	120Vac, 60Hz	Ian Chang
RE<1G	31deg. C, 78%RH	120Vac, 60Hz	Ian Chang
CE	25deg. C, 76%RH	120Vac, 60Hz	Saxon Lee

3.3 Description of Support Units

The EUT has been tested as an independent unit together with other necessary accessories or support units. The following support units or accessories were used to form a representative test configuration during the tests.

ID	Product	Brand	Model No.	Serial No.	FCC ID	Remarks
A.	Notebook	DELL	E5410	BW33YM1	N/A	Provided by Lab
B.	Load	N/A	N/A	N/A	N/A	Provided by Lab

Note:

1. All power cords of the above support units are non-shielded (1.8m).
2. Item A acted as communication partners to transfer data.

ID	Descriptions	Qty.	Length (m)	Shielding (Yes/No)	Cores (Qty.)	Remarks
1.	DC cable	1	1.5	N	1	Supplied by client
2.	AC power cord	1	1.8	N	0	Supplied by client
3.	LAN cable	1	10.0	N	0	Provided by Lab
4.	LAN cable	3	1.0	N	0	Provided by Lab
5.	GPS Antenna	2	9	N	0	Supplied by client

Note: The core(s) is(are) originally attached to the cable(s).

3.3.1 Configuration of System under Test

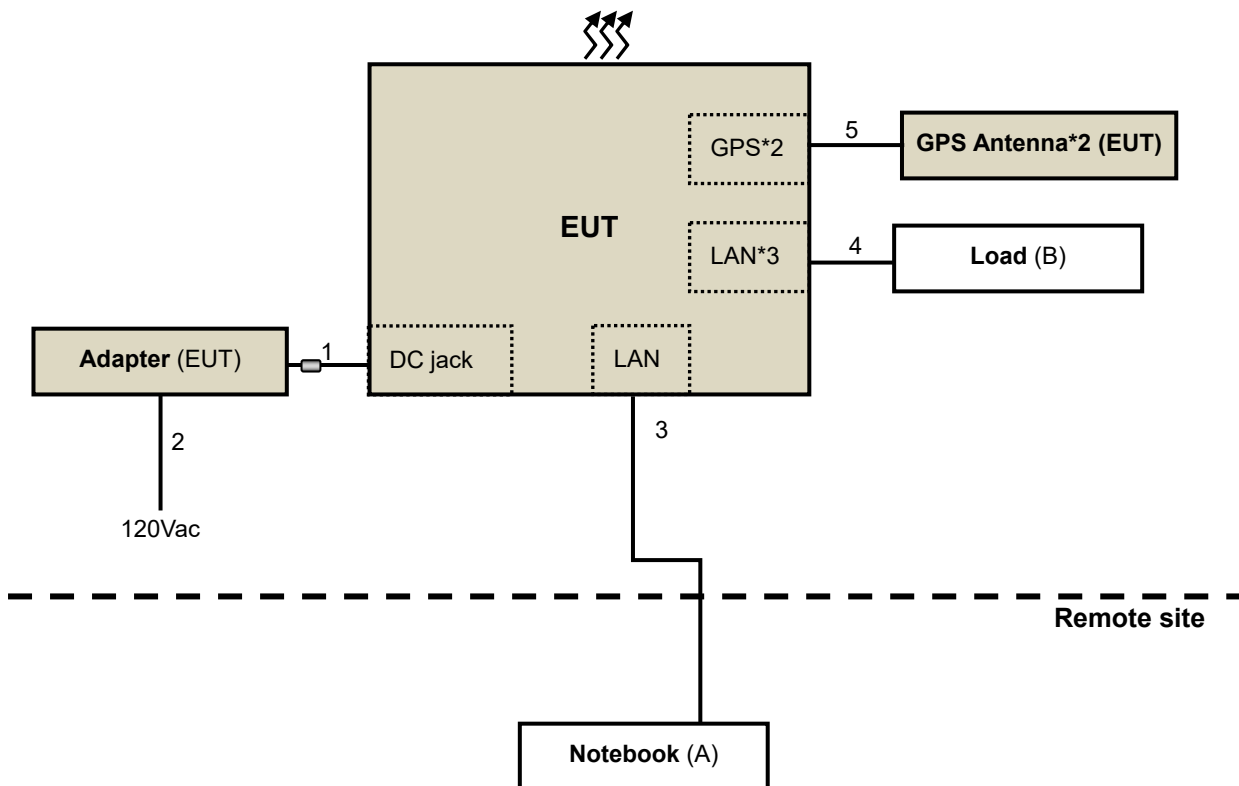

3.4 General Description of Applied Standard

The EUT is a RF Product. According to the specifications of the manufacturer, it must comply with the requirements of the following standards:

FCC 47 CFR Part 2

FCC 47 CFR Part 22

KDB 971168 D01 Power Meas License Digital Systems v02r02

KDB 662911 D01 Multiple Transmitter Output v02r01

ANSI/TIA/EIA-603-E 2016

ANSI 63.26-2015

FCC 47 CFR Part 2

FCC 47 CFR Part 24

KDB 971168 D01 Power Meas License Digital Systems v02r02

KDB 662911 D01 Multiple Transmitter Output v02r01

ANSI/TIA/EIA-603-E 2016

ANSI 63.26-2015

FCC 47 CFR Part 2

FCC 47 CFR Part 27

KDB 971168 D01 Power Meas License Digital Systems v03r01

ANSI/TIA/EIA-603-E 2016

ANSI 63.26-2015

All test items have been performed and recorded as per the above standards.

4 Test Types and Results

4.1 Radiated Emission and Bandedge Measurement

4.1.1 Limits of Radiated Emission and Bandedge Measurement

The power of any emission outside of the authorized operating frequency ranges must be attenuated below the transmitting power (P) by a factor of at least $43 + 10 \log(P)$ dB. The emission limit equal to -13dBm .

4.1.2 Test Instruments

DESCRIPTION & MANUFACTURER	MODEL NO.	SERIAL NO.	CALIBRATED DATE	CALIBRATED UNTIL
HP Preamplifier	8447D	2432A03504	Feb. 20, 2019	Feb. 19, 2020
HP Preamplifier	8449B	3008A01201	Feb. 21, 2019	Feb. 20, 2020
MITEQ Preamplifier	AMF-6F-260400-33-8P	892164	Feb. 20, 2019	Feb. 19, 2020
Agilent TEST RECEIVER	N9038A	MY51210129	Mar. 05, 2019	Mar. 04, 2020
Schwarzbeck Antenna	VULB 9168	139	Nov. 26, 2018	Nov. 25, 2019
Schwarzbeck Antenna	VHBA 9123	480	Jun. 3, 2019	Jun. 2, 2021
Schwarzbeck Horn Antenna	BBHA-9170	212	Nov. 25, 2018	Nov. 24, 2019
Schwarzbeck Horn Antenna	BBHA 9120-D1	D130	Nov. 25, 2018	Nov. 24, 2019
ADT. Turn Table	TT100	0306	NA	NA
ADT. Tower	AT100	0306	NA	NA
Software	Radiated_V7.6.15.9.5	NA	NA	NA
SUHNER RF cable With 4dB PAD	SF102	Cable-CH6-01	Aug. 13, 2018	Aug. 12, 2019
SUHNER RF cable With 3/4dB PAD	SF102	Cable-CH8-3.6m	Aug. 13, 2018	Aug. 12, 2019
KEYSIGHT MIMO Powermeasurement Test set	U2021XA	U2021XA-001	Jun. 11, 2019	Jun. 10, 2020
KEYSIGHT Spectrum Analyzer	N9030A	MY54490260	Aug. 3, 2018	Aug. 2, 2019
Loop Antenna EMCI	LPA600	270	Aug. 11, 2017	Aug. 10, 2019
EMCO Horn Antenna	3115	00028257	Nov. 25, 2018	Nov. 24, 2019
Highpass filter Wainwright Instruments	WHK 3.1/18G-10SS	SN 8	NA	NA
ROHDE & SCHWARZ Spectrum Analyzer	FSV40	101042	Sep. 27, 2018	Sep. 26, 2019
Anritsu Power Sensor	MA2411B	0738404	Apr. 16, 2019	Apr. 15, 2020
Anritsu Power Meter	ML2495A	0842014	Apr. 16, 2019	Apr. 15, 2020
Temperature & Humidity Chamber	MHU-225AU	920409	May 24, 2019	May 23, 2020
DIGITAL POWER METER IDRC	CP-240	240515	Sep. 13, 2018	Sep. 12, 2019
AC Power Source ExTech	CFW-105	E000603	NA	NA

- NOTE:**
1. The calibration interval of the above test instruments is 12/24 months. And the calibrations are traceable to NML/ROC and NIST/USA.
 2. The horn antenna and HP preamplifier (model: 8449B) are used only for the measurement of emission frequency above 1GHz if tested.
 3. The test was performed in Chamber No. 6.

4.1.3 Test Procedure

- a. The EUT was placed on the top of a rotating table 0.8 meters (for below 1GHz) / 1.5 meters (for above 1GHz) above the ground at 3 meter chamber room for test. The table was rotated 360 degrees to determine the position of the highest radiation.
- b. The EUT was set 3 meters away from the interference-receiving antenna, which was mounted on the top of a variable-height antenna tower.
- c. The height of antenna is varied from one meter to four meters above the ground to determine the maximum value of the field strength. Both horizontal and vertical polarizations of the antenna are set to make the measurement.
- d. For each suspected emission, the EUT was arranged to its worst case and then the antenna was tuned to heights from 1 meter to 4 meters and the rotatable table was turned from 0 degrees to 360 degrees to find the maximum reading.
- e. The test-receiver system was set to quasi-peak detect function and specified bandwidth with maximum hold mode when the test frequency is below 1 GHz.
- f. The test-receiver system was set to peak and average detect function and specified bandwidth with maximum hold mode when the test frequency is above 1 GHz. If the peak reading value also meets average limit, measurement with the average detector is unnecessary.

Note:

1. The resolution bandwidth and video bandwidth of test receiver/spectrum analyzer is 120kHz for Quasi-peak detection (QP) at frequency below 1GHz.
2. The resolution bandwidth of test receiver/spectrum analyzer is 1 MHz and the video bandwidth is 3 MHz for Peak detection (PK) at frequency above 1GHz.
3. All modes of operation were investigated and the worst-case emissions are reported.

4.1.4 Deviation from Test Standard

No deviation.

4.1.5 Test Setup

<Frequency Range below 1GHz>

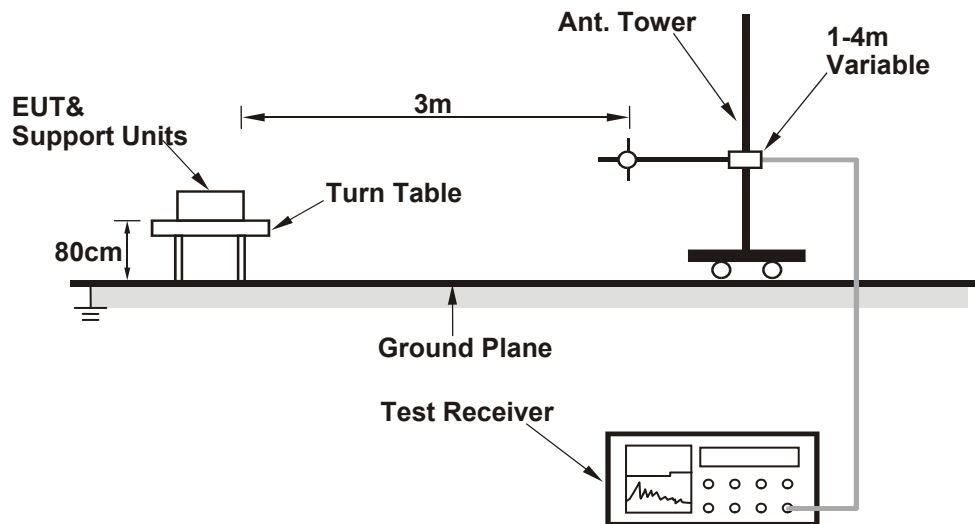

<Frequency Range above 1GHz>

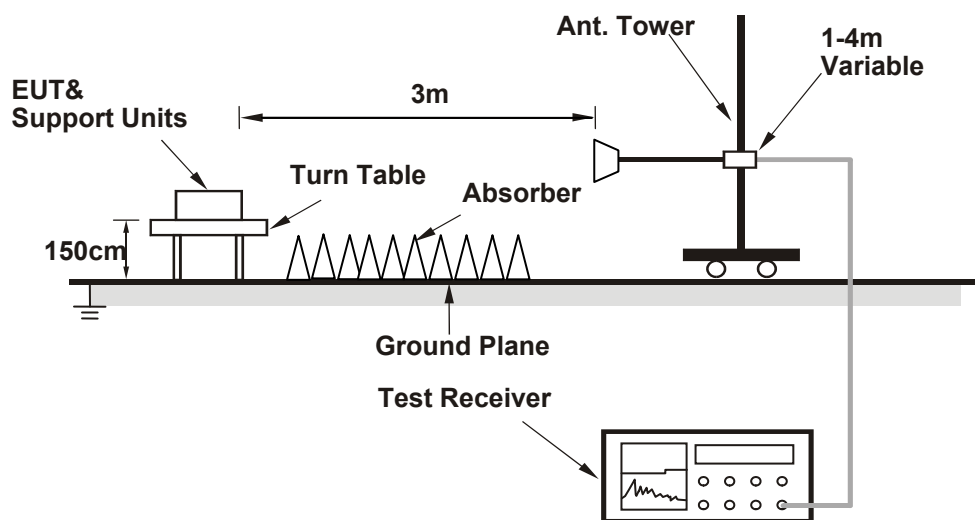

For the actual test configuration, please refer to the attached file (Test Setup Photo).

4.1.6 EUT Operating Condition

- Placed the EUT on the testing table.
- Prepared notebook to act as communication partner and placed it outside of testing area.
- The communication partner connected with EUT via a RJ45 cable and ran a test program (provided by manufacturer) to enable EUT under transmission condition continuously at specific channel frequency.

4.1.7 Test Results (Mode A)

CA-1 Mode: LTE Band 4 CPU1 (CBW: 10MHz) + LTE Band 13 CPU1 (CBW: 10MHz)

ABOVE 1GHz DATA

Frequency Range	1GHz ~ 25GHz	Detector Function	Peak (PK)
-----------------	--------------	-------------------	-----------

Antenna Polarity & Test Distance: Horizontal at 3 M							
No.	Freq. (MHz)	Reading (dBm)	S.G Power Value (dBm)	Correction Factor (dB)	ERP (dBm)	Limit (dBm)	Margin (dB)
1	1503.66	-50.87	-60.69	8.35	-52.34	-13.00	-39.34
2	4235.21	-59.51	-66.64	13.33	-53.31	-13.00	-40.31
Antenna Polarity & Test Distance: Vertical at 3 M							
No.	Freq. (MHz)	Reading (dBm)	S.G Power Value (dBm)	Correction Factor (dB)	ERP (dBm)	Limit (dBm)	Margin (dB)
1	1505.34	-39.72	-49.61	8.35	-41.26	-13.00	-28.26
2	4233.16	-48.48	-55.59	13.33	-42.26	-13.00	-29.26

BELOW 1GHz DATA

Frequency Range	30MHz ~ 1GHz	Detector Function	Quasi-Peak (QP)
-----------------	--------------	-------------------	-----------------

Antenna Polarity & Test Distance: Horizontal at 3 M							
No.	Freq. (MHz)	Reading (dBm)	S.G Power Value (dBm)	Correction Factor (dB)	ERP (dBm)	Limit (dBm)	Margin (dB)
1	185.44	-61.79	-82.88	13.18	-69.70	-13.00	-56.70
2	224.97	-60.95	-81.59	12.80	-68.79	-13.00	-55.79
3	325.00	-57.90	-75.66	16.97	-58.69	-13.00	-45.69
4	374.96	-65.84	-83.72	18.25	-65.47	-13.00	-52.47
5	499.96	-74.89	-92.20	21.29	-70.91	-13.00	-57.91
6	746.83	-73.77	-93.25	26.28	-66.97	-13.00	-53.97
Antenna Polarity & Test Distance: Vertical at 3 M							
No.	Freq. (MHz)	Reading (dBm)	S.G Power Value (dBm)	Correction Factor (dB)	ERP (dBm)	Limit (dBm)	Margin (dB)
1	184.96	-60.88	-82.34	13.23	-69.11	-13.00	-56.11
2	224.97	-59.95	-80.22	12.80	-67.42	-13.00	-54.42
3	325.00	-58.74	-75.64	16.97	-58.67	-13.00	-45.67
4	374.96	-64.53	-82.13	18.25	-63.88	-13.00	-50.88
5	499.96	-67.15	-85.58	21.29	-64.29	-13.00	-51.29
6	624.97	-76.79	-94.92	24.33	-70.59	-13.00	-57.59

4.1.8 Test Results (Mode B)

CA-1 Mode: LTE Band 4 CPU1 (CBW: 20MHz) + LTE Band 13 CPU1 (CBW: 10MHz)

ABOVE 1GHz DATA

Frequency Range	1GHz ~ 25GHz	Detector Function	Peak (PK)
-----------------	--------------	-------------------	-----------

Antenna Polarity & Test Distance: Horizontal at 3 M							
No.	Freq. (MHz)	Reading (dBm)	S.G Power Value (dBm)	Correction Factor (dB)	ERP (dBm)	Limit (dBm)	Margin (dB)
1	1507.18	-49.86	-59.67	8.35	-51.32	-13.00	-38.32
2	4238.65	-58.67	-65.82	13.34	-52.48	-13.00	-39.48
Antenna Polarity & Test Distance: Vertical at 3 M							
No.	Freq. (MHz)	Reading (dBm)	S.G Power Value (dBm)	Correction Factor (dB)	ERP (dBm)	Limit (dBm)	Margin (dB)
1	1506.35	-40.21	-50.11	8.36	-41.75	-13.00	-28.75
2	4244.64	-48.36	-55.53	13.34	-42.19	-13.00	-29.19

BELOW 1GHz DATA

Frequency Range	30MHz ~ 1GHz	Detector Function	Quasi-Peak (QP)
-----------------	--------------	-------------------	-----------------

Antenna Polarity & Test Distance: Horizontal at 3 M							
No.	Freq. (MHz)	Reading (dBm)	S.G Power Value (dBm)	Correction Factor (dB)	ERP (dBm)	Limit (dBm)	Margin (dB)
1	185.08	-60.90	-82.02	13.22	-68.80	-13.00	-55.80
2	224.97	-61.03	-81.67	12.80	-68.87	-13.00	-55.87
3	325.00	-57.83	-75.59	16.97	-58.62	-13.00	-45.62
4	374.96	-65.82	-83.70	18.25	-65.45	-13.00	-52.45
5	499.96	-69.11	-86.42	21.29	-65.13	-13.00	-52.13
6	624.97	-77.78	-95.06	24.33	-70.73	-13.00	-57.73
Antenna Polarity & Test Distance: Vertical at 3 M							
No.	Freq. (MHz)	Reading (dBm)	S.G Power Value (dBm)	Correction Factor (dB)	ERP (dBm)	Limit (dBm)	Margin (dB)
1	35.34	-63.00	-80.45	13.12	-67.33	-13.00	-54.33
2	224.97	-57.68	-77.95	12.80	-65.15	-13.00	-52.15
3	325.00	-62.62	-79.52	16.97	-62.55	-13.00	-49.55
4	374.96	-64.22	-81.82	18.25	-63.57	-13.00	-50.57
5	474.99	-71.67	-90.57	20.87	-69.70	-13.00	-56.70
6	624.97	-78.58	-96.71	24.33	-72.38	-13.00	-59.38

4.1.9 Test Results (Mode C)

CA-2 Mode: LTE Band 2 CPU2 (CBW: 10MHz) + LTE Band 5 CPU2 (CBW: 10MHz)

ABOVE 1GHz DATA

Frequency Range	1GHz ~ 25GHz	Detector Function	Peak (PK)
-----------------	--------------	-------------------	-----------

Antenna Polarity & Test Distance: Horizontal at 3 M

No.	Freq. (MHz)	Reading (dBm)	S.G Power Value (dBm)	Correction Factor (dB)	ERP (dBm)	Limit (dBm)	Margin (dB)
1	1753.61	-52.96	-60.34	8.00	-52.34	-13.00	-39.34
2	3866.59	-57.54	-65.30	12.84	-52.46	-13.00	-39.46

Antenna Polarity & Test Distance: Vertical at 3 M

No.	Freq. (MHz)	Reading (dBm)	S.G Power Value (dBm)	Correction Factor (dB)	ERP (dBm)	Limit (dBm)	Margin (dB)
1	1752.21	-41.00	-48.60	8.01	-40.59	-13.00	-27.59
2	3874.51	-44.50	-52.52	12.85	-39.67	-13.00	-26.67

BELOW 1GHz DATA

Frequency Range	30MHz ~ 1GHz	Detector Function	Quasi-Peak (QP)
-----------------	--------------	-------------------	-----------------

Antenna Polarity & Test Distance: Horizontal at 3 M

No.	Freq. (MHz)	Reading (dBm)	S.G Power Value (dBm)	Correction Factor (dB)	ERP (dBm)	Limit (dBm)	Margin (dB)
1	182.65	-61.74	-82.58	13.37	-69.21	-13.00	-56.21
2	224.97	-60.57	-81.21	12.80	-68.41	-13.00	-55.41
3	275.05	-66.47	-84.82	15.46	-69.36	-13.00	-56.36
4	325.00	-57.82	-75.58	16.97	-58.61	-13.00	-45.61
5	374.96	-65.33	-83.21	18.25	-64.96	-13.00	-51.96
6	499.96	-68.82	-86.13	21.29	-64.84	-13.00	-51.84

Antenna Polarity & Test Distance: Vertical at 3 M

No.	Freq. (MHz)	Reading (dBm)	S.G Power Value (dBm)	Correction Factor (dB)	ERP (dBm)	Limit (dBm)	Margin (dB)
1	35.58	-64.53	-81.76	13.20	-68.56	-13.00	-55.56
2	224.97	-57.89	-78.16	12.80	-65.36	-13.00	-52.36
3	325.00	-62.24	-79.14	16.97	-62.17	-13.00	-49.17
4	374.96	-64.98	-82.58	18.25	-64.33	-13.00	-51.33
5	474.99	-70.94	-89.84	20.87	-68.97	-13.00	-55.97
6	624.97	-78.91	-97.04	24.33	-72.71	-13.00	-59.71

4.1.10 Test Results (Mode D)

CA-2 Mode: LTE Band 2 CPU2 (CBW: 20MHz) + LTE Band 5 CPU2 (CBW: 10MHz)

ABOVE 1GHz DATA

Frequency Range	1GHz ~ 25GHz	Detector Function	Peak (PK)
-----------------	--------------	-------------------	-----------

Antenna Polarity & Test Distance: Horizontal at 3 M							
No.	Freq. (MHz)	Reading (dBm)	S.G Power Value (dBm)	Correction Factor (dB)	ERP (dBm)	Limit (dBm)	Margin (dB)
1	1744.63	-54.85	-62.27	8.01	-54.26	-13.00	-41.26
2	3885.41	-60.67	-68.50	12.88	-55.62	-13.00	-42.62
Antenna Polarity & Test Distance: Vertical at 3 M							
No.	Freq. (MHz)	Reading (dBm)	S.G Power Value (dBm)	Correction Factor (dB)	ERP (dBm)	Limit (dBm)	Margin (dB)
1	1751.32	-41.65	-49.27	8.01	-41.26	-13.00	-28.26
2	3888.22	-47.12	-55.19	12.88	-42.31	-13.00	-29.31

BELOW 1GHz DATA

Frequency Range	30MHz ~ 1GHz	Detector Function	Quasi-Peak (QP)
-----------------	--------------	-------------------	-----------------

Antenna Polarity & Test Distance: Horizontal at 3 M							
No.	Freq. (MHz)	Reading (dBm)	S.G Power Value (dBm)	Correction Factor (dB)	ERP (dBm)	Limit (dBm)	Margin (dB)
1	184.96	-61.11	-82.23	13.23	-69.00	-13.00	-56.00
2	224.97	-60.18	-80.82	12.80	-68.02	-13.00	-55.02
3	325.00	-57.61	-75.37	16.97	-58.40	-13.00	-45.40
4	374.96	-66.34	-84.22	18.25	-65.97	-13.00	-52.97
5	444.80	-72.35	-90.55	20.25	-70.30	-13.00	-57.30
6	499.96	-69.78	-87.09	21.29	-65.80	-13.00	-52.80
Antenna Polarity & Test Distance: Vertical at 3 M							
No.	Freq. (MHz)	Reading (dBm)	S.G Power Value (dBm)	Correction Factor (dB)	ERP (dBm)	Limit (dBm)	Margin (dB)
1	35.34	-63.37	-80.82	13.12	-67.70	-13.00	-54.70
2	224.97	-57.09	-77.36	12.80	-64.56	-13.00	-51.56
3	325.00	-63.39	-80.29	16.97	-63.32	-13.00	-50.32
4	374.96	-63.67	-81.27	18.25	-63.02	-13.00	-50.02
5	474.99	-71.23	-90.13	20.87	-69.26	-13.00	-56.26
6	499.96	-73.55	-91.98	21.29	-70.69	-13.00	-57.69

4.1.11 Test Results (Mode E)

CA-1 + CA-2 Mode: LTE Band 4 CPU1 (CBW: 10MHz) + LTE Band 13 CPU1 (CBW: 10MHz) +
LTE Band 2 CPU2 (CBW: 10MHz) + LTE Band 5 CPU2 (CBW: 10MHz)

ABOVE 1GHz DATA

Frequency Range	1GHz ~ 25GHz	Detector Function	Peak (PK)
-----------------	--------------	-------------------	-----------

Antenna Polarity & Test Distance: Horizontal at 3 m

No.	Freq. (MHz)	Reading (dBm)	S.G Power Value (dBm)	Correction Factor (dB)	ERP (dBm)	Limit (dBm)	Margin (dB)
1	1503.54	-51.17	-60.99	8.35	-52.64	-13.00	-39.64
2	1750.29	-54.87	-62.27	8.01	-54.26	-13.00	-41.26
3	3870.84	-58.73	-66.50	12.84	-53.66	-13.00	-40.66
4	4238.55	-58.88	-66.03	13.34	-52.69	-13.00	-39.69

Antenna Polarity & Test Distance: Vertical at 3 m

No.	Freq. (MHz)	Reading (dBm)	S.G Power Value (dBm)	Correction Factor (dB)	ERP (dBm)	Limit (dBm)	Margin (dB)
1	1506.52	-39.49	-49.39	8.36	-41.03	-13.00	-28.03
2	1752.42	-42.72	-50.31	8.00	-42.31	-13.00	-29.31
3	3874.51	-44.96	-52.98	12.85	-40.13	-13.00	-27.13
4	4236.21	-47.53	-54.65	13.33	-41.32	-13.00	-28.32

BELOW 1GHz DATA

Frequency Range	30MHz ~ 1GHz	Detector Function	Quasi-Peak (QP)
-----------------	--------------	-------------------	-----------------

Antenna Polarity & Test Distance: Horizontal at 3 m

No.	Freq. (MHz)	Reading (dBm)	S.G Power Value (dBm)	Correction Factor (dB)	ERP (dBm)	Limit (dBm)	Margin (dB)
1	186.90	-61.31	-82.34	13.09	-69.25	-13.00	-56.25
2	224.97	-59.80	-80.44	12.80	-67.64	-13.00	-54.64
3	275.05	-67.23	-85.58	15.46	-70.12	-13.00	-57.12
4	325.00	-63.05	-80.81	16.97	-63.84	-13.00	-50.84
5	374.96	-65.09	-82.97	18.25	-64.72	-13.00	-51.72
6	499.96	-68.92	-86.23	21.29	-64.94	-13.00	-51.94

Antenna Polarity & Test Distance: Vertical at 3 m

No.	Freq. (MHz)	Reading (dBm)	S.G Power Value (dBm)	Correction Factor (dB)	ERP (dBm)	Limit (dBm)	Margin (dB)
1	35.21	-60.90	-78.47	13.09	-65.38	-13.00	-52.38
2	224.97	-59.21	-79.48	12.80	-66.68	-13.00	-53.68
3	325.00	-62.18	-79.08	16.97	-62.11	-13.00	-49.11
4	374.96	-67.74	-85.34	18.25	-67.09	-13.00	-54.09
5	442.37	-74.76	-92.25	20.19	-72.06	-13.00	-59.06
6	499.96	-76.44	-94.87	21.29	-73.58	-13.00	-60.58

4.1.12 Test Results (Mode F)

CA-1 + CA-2 Mode: LTE Band 4 CPU1 (CBW: 10MHz) + LTE Band 13 CPU1 (CBW: 10MHz) +
LTE Band 2 CPU2 (CBW: 20MHz) + LTE Band 5 CPU2 (CBW: 10MHz)

ABOVE 1GHz DATA

Frequency Range	1GHz ~ 25GHz	Detector Function	Peak (PK)
-----------------	--------------	-------------------	-----------

Antenna Polarity & Test Distance: Horizontal at 3 m

No.	Freq. (MHz)	Reading (dBm)	S.G Power Value (dBm)	Correction Factor (dB)	ERP (dBm)	Limit (dBm)	Margin (dB)
1	1506.29	-52.15	-61.97	8.36	-53.61	-13.00	-40.61
2	1753.69	-54.46	-61.84	8.00	-53.84	-13.00	-40.84
3	3885.26	-59.56	-67.39	12.88	-54.51	-13.00	-41.51
4	4234.43	-60.04	-67.17	13.33	-53.84	-13.00	-40.84

Antenna Polarity & Test Distance: Vertical at 3 m

No.	Freq. (MHz)	Reading (dBm)	S.G Power Value (dBm)	Correction Factor (dB)	ERP (dBm)	Limit (dBm)	Margin (dB)
1	1500.19	-41.03	-50.92	8.36	-42.56	-13.00	-29.56
2	1750.67	-42.95	-50.58	8.01	-42.57	-13.00	-29.57
3	3883.32	-48.60	-56.65	12.87	-43.78	-13.00	-30.78
4	4231.59	-49.85	-56.95	13.33	-43.62	-13.00	-30.62

BELOW 1GHz DATA

Frequency Range	30MHz ~ 1GHz	Detector Function	Quasi-Peak (QP)
-----------------	--------------	-------------------	-----------------

Antenna Polarity & Test Distance: Horizontal at 3 m

No.	Freq. (MHz)	Reading (dBm)	S.G Power Value (dBm)	Correction Factor (dB)	ERP (dBm)	Limit (dBm)	Margin (dB)
1	185.08	-60.85	-81.97	13.22	-68.75	-13.00	-55.75
2	224.97	-59.72	-80.36	12.80	-67.56	-13.00	-54.56
3	275.05	-68.06	-86.41	15.46	-70.95	-13.00	-57.95
4	325.00	-57.63	-75.39	16.97	-58.42	-13.00	-45.42
5	374.96	-66.30	-84.18	18.25	-65.93	-13.00	-52.93
6	499.96	-69.13	-86.44	21.29	-65.15	-13.00	-52.15

Antenna Polarity & Test Distance: Vertical at 3 m

No.	Freq. (MHz)	Reading (dBm)	S.G Power Value (dBm)	Correction Factor (dB)	ERP (dBm)	Limit (dBm)	Margin (dB)
1	35.70	-64.03	-81.14	13.23	-67.91	-13.00	-54.91
2	224.97	-58.65	-78.92	12.80	-66.12	-13.00	-53.12
3	325.00	-62.33	-79.23	16.97	-62.26	-13.00	-49.26
4	374.96	-61.17	-78.77	18.25	-60.52	-13.00	-47.52
5	474.99	-71.01	-89.91	20.87	-69.04	-13.00	-56.04
6	624.97	-77.41	-95.54	24.33	-71.21	-13.00	-58.21

4.1.13 Test Results (Mode G)

CA-1 + CA-2 Mode: LTE Band 4 CPU1 (CBW: 20MHz) + LTE Band 13 CPU1 (CBW: 10MHz) +
 LTE Band 2 CPU2 (CBW: 10MHz) + LTE Band 5 CPU2 (CBW: 10MHz)

ABOVE 1GHz DATA

Frequency Range	1GHz ~ 25GHz	Detector Function	Peak (PK)
-----------------	--------------	-------------------	-----------

Antenna Polarity & Test Distance: Horizontal at 3 m

No.	Freq. (MHz)	Reading (dBm)	S.G Power Value (dBm)	Correction Factor (dB)	ERP (dBm)	Limit (dBm)	Margin (dB)
1	1504.26	-52.40	-62.22	8.35	-53.87	-13.00	-40.87
2	1750.85	-54.33	-61.73	8.01	-53.72	-13.00	-40.72
3	3882.77	-58.89	-66.71	12.87	-53.84	-13.00	-40.84
4	4232.43	-60.36	-67.49	13.33	-54.16	-13.00	-41.16

Antenna Polarity & Test Distance: Vertical at 3 m

No.	Freq. (MHz)	Reading (dBm)	S.G Power Value (dBm)	Correction Factor (dB)	ERP (dBm)	Limit (dBm)	Margin (dB)
1	1500.24	-40.65	-50.54	8.36	-42.18	-13.00	-29.18
2	1751.98	-43.46	-51.07	8.01	-43.06	-13.00	-30.06
3	3885.43	-47.48	-55.55	12.88	-42.67	-13.00	-29.67
4	4234.53	-49.67	-56.78	13.33	-43.45	-13.00	-30.45

BELOW 1GHz DATA

Frequency Range	30MHz ~ 1GHz	Detector Function	Quasi-Peak (QP)
-----------------	--------------	-------------------	-----------------

Antenna Polarity & Test Distance: Horizontal at 3 m

No.	Freq. (MHz)	Reading (dBm)	S.G Power Value (dBm)	Correction Factor (dB)	ERP (dBm)	Limit (dBm)	Margin (dB)
1	184.23	-61.13	-82.13	13.24	-68.89	-13.00	-55.89
2	224.97	-59.67	-80.31	12.80	-67.51	-13.00	-54.51
3	325.00	-57.98	-75.74	16.97	-58.77	-13.00	-45.77
4	374.96	-64.46	-82.34	18.25	-64.09	-13.00	-51.09
5	445.04	-73.98	-92.18	20.26	-71.92	-13.00	-58.92
6	499.96	-68.11	-85.42	21.29	-64.13	-13.00	-51.13

Antenna Polarity & Test Distance: Vertical at 3 m

No.	Freq. (MHz)	Reading (dBm)	S.G Power Value (dBm)	Correction Factor (dB)	ERP (dBm)	Limit (dBm)	Margin (dB)
1	35.58	-64.65	-81.88	13.20	-68.68	-13.00	-55.68
2	224.97	-56.02	-76.29	12.80	-63.49	-13.00	-50.49
3	325.00	-61.83	-78.73	16.97	-61.76	-13.00	-48.76
4	374.96	-65.43	-83.03	18.25	-64.78	-13.00	-51.78
5	441.28	-73.30	-90.73	20.15	-70.58	-13.00	-57.58
6	499.96	-76.33	-94.76	21.29	-73.47	-13.00	-60.47

4.1.14 Test Results (Mode H)

CA-1 + CA-2 Mode: LTE Band 4 CPU1 (CBW: 20MHz) + LTE Band 13 CPU1 (CBW: 10MHz) +
 LTE Band 2 CPU2 (CBW: 20MHz) + LTE Band 5 CPU2 (CBW: 10MHz)

ABOVE 1GHz DATA

Frequency Range	1GHz ~ 25GHz	Detector Function	Peak (PK)
-----------------	--------------	-------------------	-----------

Antenna Polarity & Test Distance: Horizontal at 3 M

No.	Freq. (MHz)	Reading (dBm)	S.G Power Value (dBm)	Correction Factor (dB)	ERP (dBm)	Limit (dBm)	Margin (dB)
1	1507.33	-52.73	-62.54	8.35	-54.19	-13.00	-41.19
2	1751.37	-55.29	-62.69	8.01	-54.68	-13.00	-41.68
3	3883.67	-59.24	-67.06	12.87	-54.19	-13.00	-41.19
4	4241.67	-60.05	-67.20	13.34	-53.86	-13.00	-40.86

Antenna Polarity & Test Distance: Vertical at 3 M

No.	Freq. (MHz)	Reading (dBm)	S.G Power Value (dBm)	Correction Factor (dB)	ERP (dBm)	Limit (dBm)	Margin (dB)
1	1504.57	-41.61	-51.50	8.35	-43.15	-13.00	-30.15
2	1752.84	-43.45	-51.03	8.00	-43.03	-13.00	-30.03
3	3885.08	-49.44	-57.50	12.88	-44.62	-13.00	-31.62
4	4242.45	-50.12	-57.28	13.34	-43.94	-13.00	-30.94

BELOW 1GHz DATA

Frequency Range	30MHz ~ 1GHz	Detector Function	Quasi-Peak (QP)
-----------------	--------------	-------------------	-----------------

Antenna Polarity & Test Distance: Horizontal at 3 m

No.	Freq. (MHz)	Reading (dBm)	S.G Power Value (dBm)	Correction Factor (dB)	ERP (dBm)	Limit (dBm)	Margin (dB)
1	185.08	-61.94	-83.06	13.22	-69.84	-13.00	-56.84
2	224.97	-60.88	-81.52	12.80	-68.72	-13.00	-55.72
3	275.05	-66.99	-85.34	15.46	-69.88	-13.00	-56.88
4	325.00	-57.74	-75.50	16.97	-58.53	-13.00	-45.53
5	374.96	-65.83	-83.71	18.25	-65.46	-13.00	-52.46
6	499.96	-71.26	-88.57	21.29	-67.28	-13.00	-54.28

Antenna Polarity & Test Distance: Vertical at 3 M

No.	Freq. (MHz)	Reading (dBm)	S.G Power Value (dBm)	Correction Factor (dB)	ERP (dBm)	Limit (dBm)	Margin (dB)
1	35.46	-63.84	-81.18	13.16	-68.02	-13.00	-55.02
2	224.97	-57.63	-77.90	12.80	-65.10	-13.00	-52.10
3	325.00	-62.39	-79.29	16.97	-62.32	-13.00	-49.32
4	374.96	-64.68	-82.28	18.25	-64.03	-13.00	-51.03
5	474.99	-71.58	-90.48	20.87	-69.61	-13.00	-56.61
6	624.97	-77.44	-95.57	24.33	-71.24	-13.00	-58.24

4.2 Conducted Spurious Emissions

4.2.1 Limits of Conducted Spurious Emissions Measurement

For LTE Band 2

The power of any emission outside of the authorized operating frequency ranges must be attenuated below the transmitting power (P) by a factor of at least $43 + 10 \log(P)$ dB. The emission limit equal to -13dBm .

For LTE Band 4

According to FCC 27.53(h) for operations in the 1695-1710 MHz, 1710-1755 MHz, 1755-1780 MHz, 1915-1920 MHz, 1995-2000 MHz, 2000-2020 MHz, 2110-2155 MHz, 2155-2180 MHz, and 2180-2200 bands, the power of any emission outside a licensee's frequency block shall be attenuated below the transmitter power (P) in watts by at least $43 + 10 \log_{10}(P)$ dB.

For LTE Band 5

The power of any emission outside of the authorized operating frequency ranges must be attenuated below the transmitting power (P) by a factor of at least $43 + 10 \log(P)$ dB. The emission limit equal to -13dBm .

For LTE Band 13

According to FCC 27.53(c) (2) for on any frequency outside the 776-788 MHz band, the power of any emission shall be attenuated outside the band below the transmitter power (P) by at least $43 + 10 \log(P)$ dB.

Part 27.53 (f) For operations in the 746-758 MHz, 775-788 MHz, and 805-806 MHz bands, emissions in the band 1559-1610 MHz shall be limited to -70 dBW/MHz equivalent isotropically radiated power (EIRP) for wideband signals, and -80 dBW EIRP for discrete emissions of less than 700 Hz bandwidth. For the purpose of equipment authorization, a transmitter shall be tested with an antenna that is representative of the type that will be used with the equipment in normal operation.

Note:

1. The results for each of the transmit chains shall be individually compared with the limits after these limits have been added by $10 \times \log(N)$ (number of active transmit chains).
2. The other emission levels were very low against the limit in the band 1559-1610

4.2.2 Test Setup

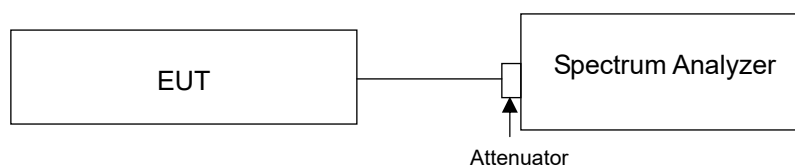

4.2.3 Test Procedure

- a. All measurements were done at 3 channels: low, middle and high operational frequency range.
- b. When the spectrum scanned from 9kHz to 27GHz, it shall be connected to the 20dB pad attenuated the carried frequency. The spectrum set RB = 1MHz, VB = 3MHz.

4.2.4 Test Results (Mode A)

CA-1 Mode:

LTE Band 4 CPU1 (CBW: 10MHz) + LTE Band 13 CPU1 (CBW: 10MHz)

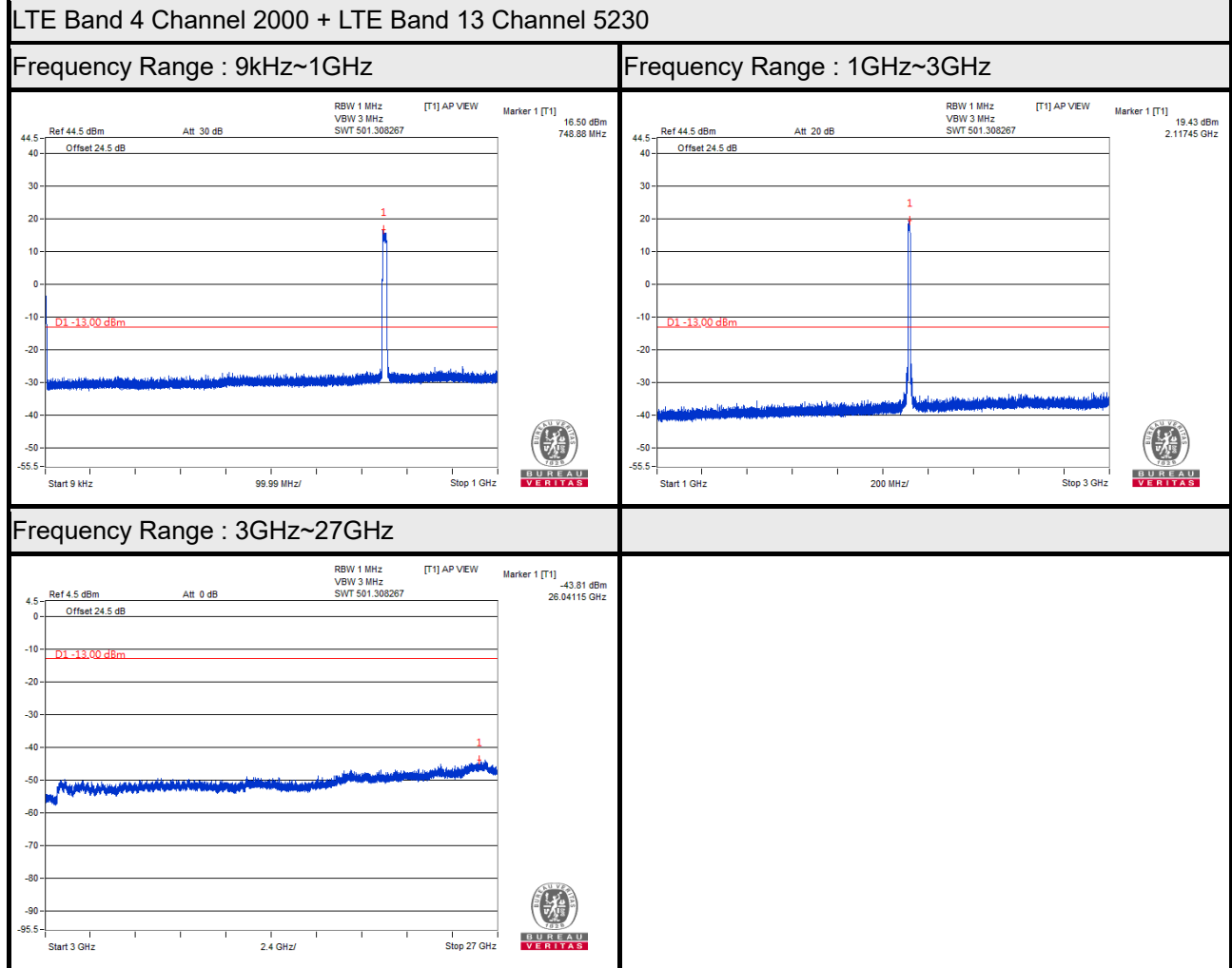

LTE Band 4 Channel 2175 + LTE Band 13 Channel 5230

Frequency Range : 9kHz~1GHz

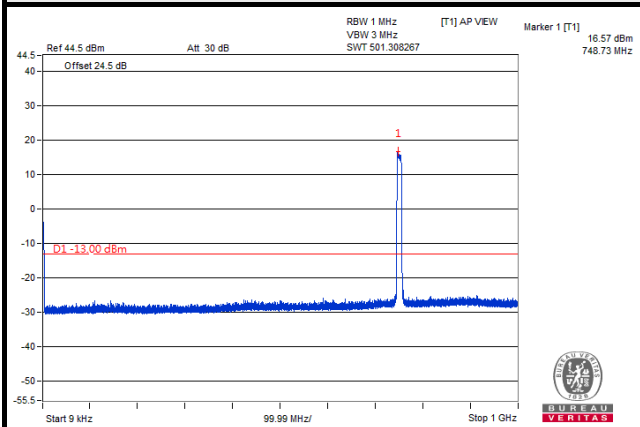

Frequency Range : 1GHz~3GHz

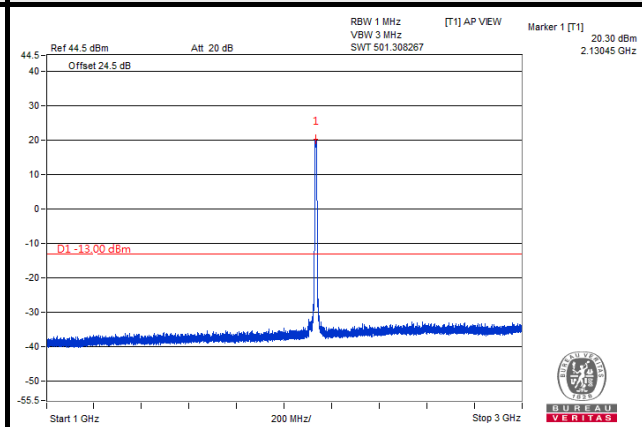

Frequency Range : 3GHz~27GHz

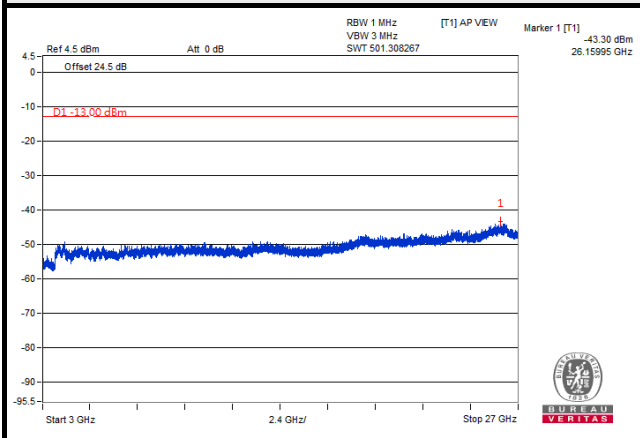

LTE Band 4 Channel 2350 + LTE Band 13 Channel 5230

Frequency Range : 9kHz~1GHz

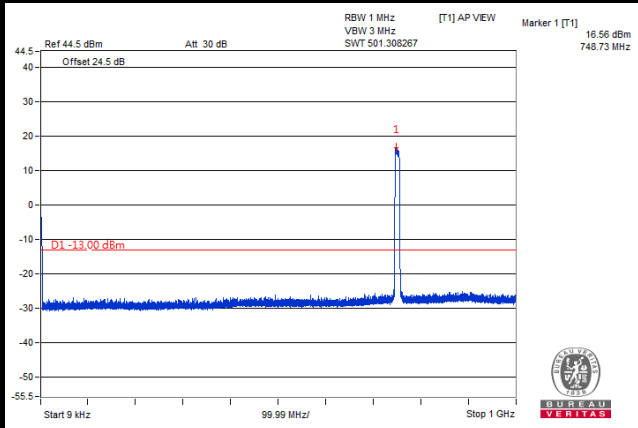

Frequency Range : 1GHz~3GHz

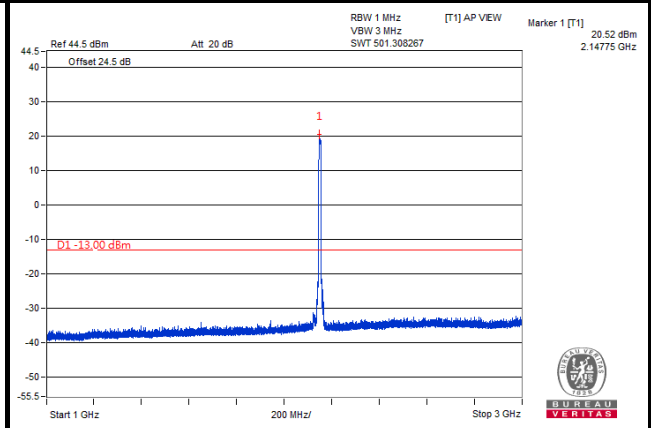

Frequency Range : 3GHz~27GHz

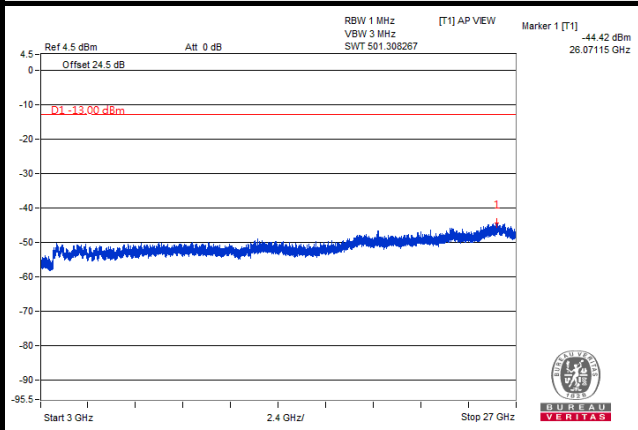

4.2.5 Test Results (Mode B)

CA-1 Mode: LTE Band 4 CPU1 (CBW: 20MHz) + LTE Band 13 CPU1 (CBW: 10MHz)

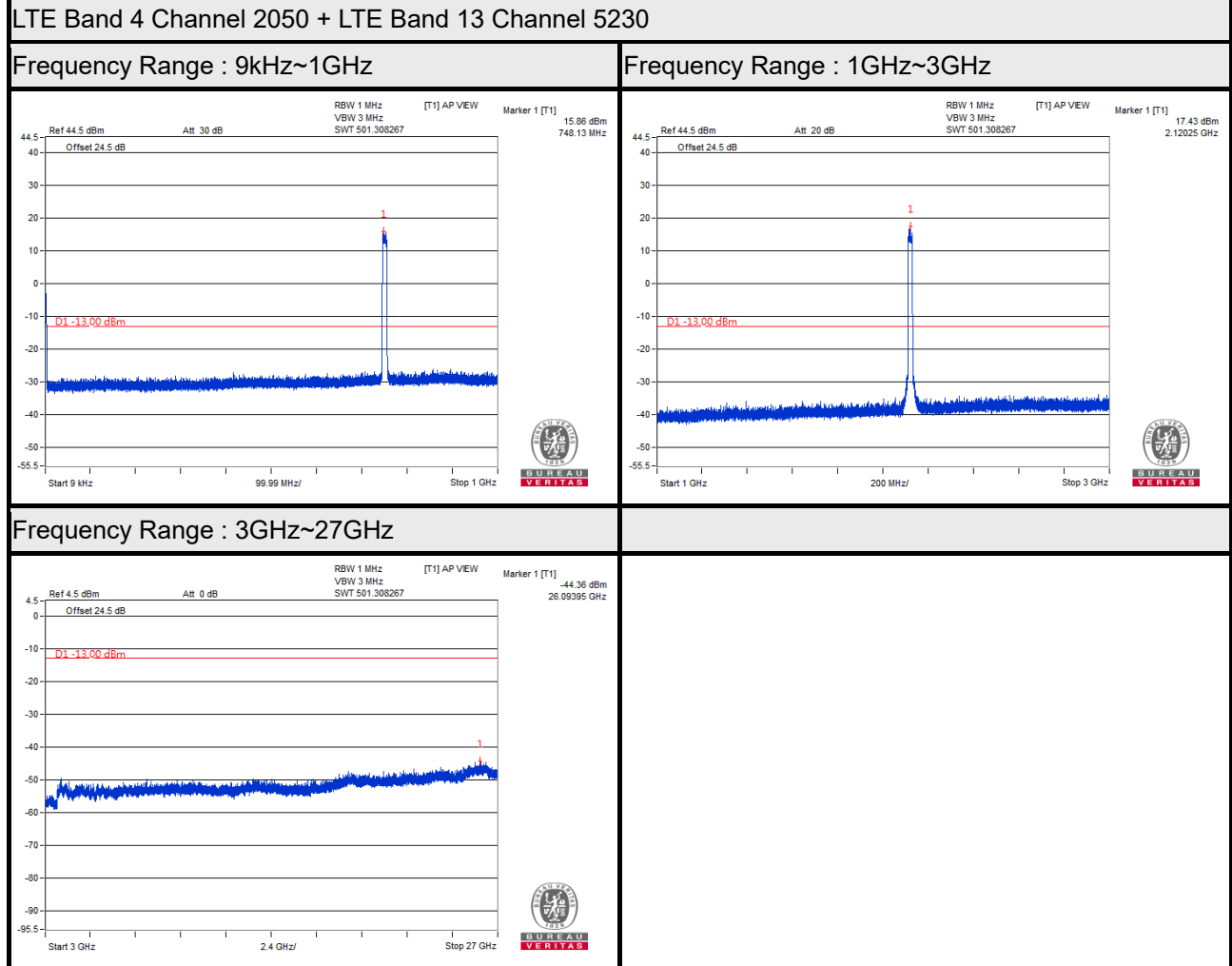

LTE Band 4 Channel 2175 + LTE Band 13 Channel 5230

Frequency Range : 9kHz~1GHz

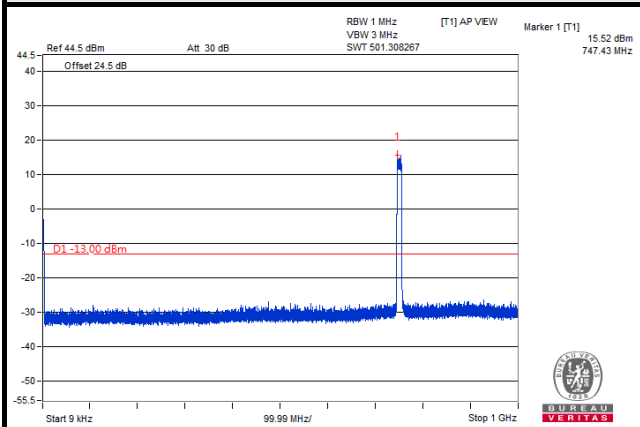

Frequency Range : 1GHz~3GHz

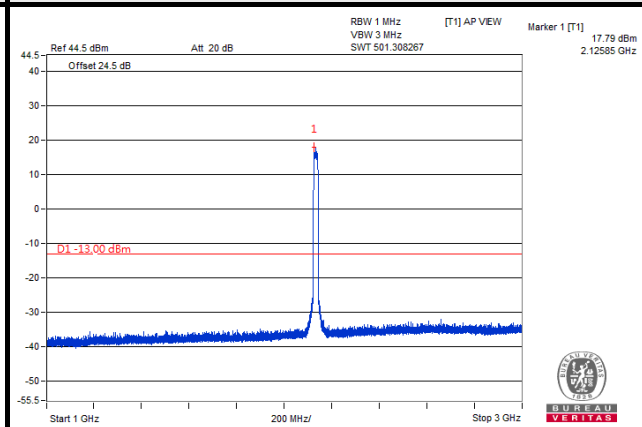

Frequency Range : 3GHz~27GHz

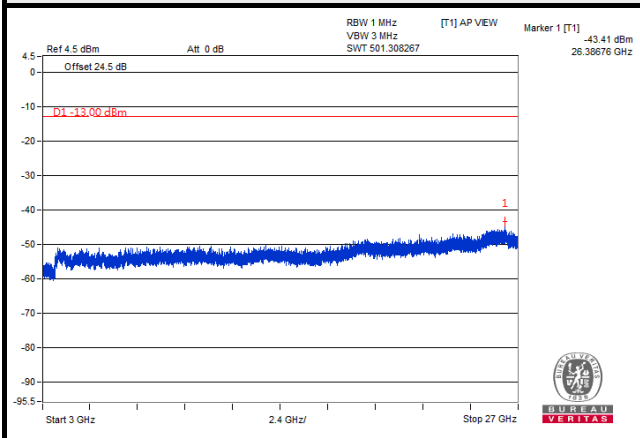

LTE Band 4 Channel 2300 + LTE Band 13 Channel 5230

Frequency Range : 9kHz~1GHz

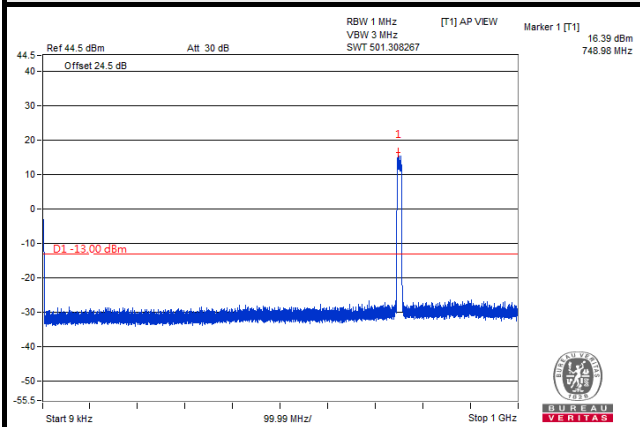

Frequency Range : 1GHz~3GHz

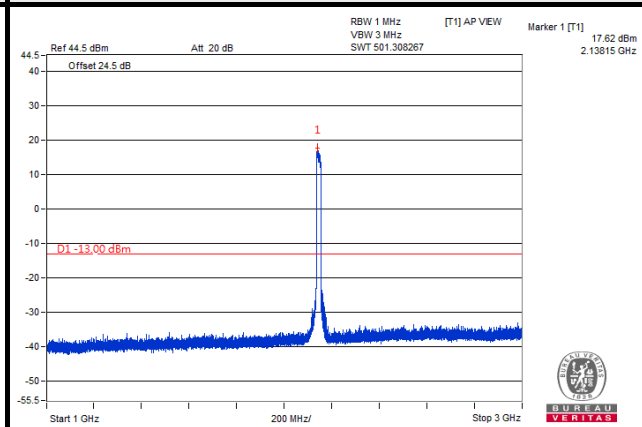

Frequency Range : 3GHz~27GHz

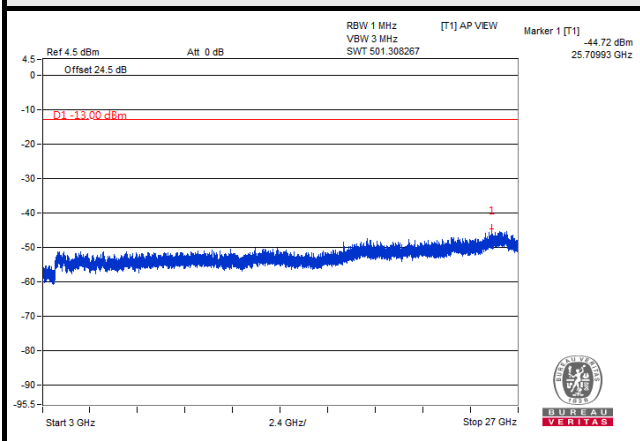

4.2.6 Test Results (Mode C)

CA-2 Mode:

LTE Band 2 CPU2 (CBW: 10MHz) + LTE Band 5 CPU2 (CBW: 10MHz)

LTE Band 2 Channel 650 + LTE Band 5 Channel 2450

Frequency Range : 9kHz~1GHz

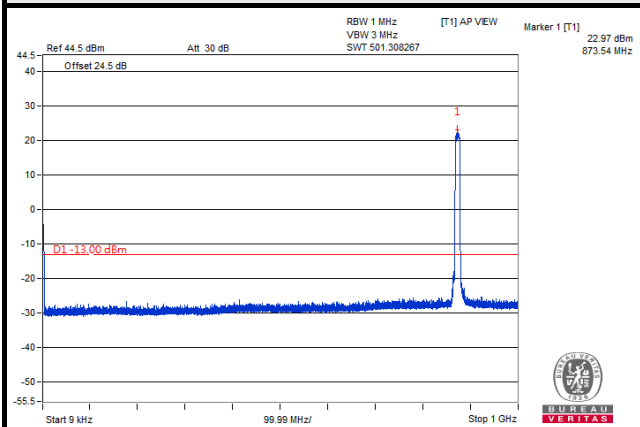

Frequency Range : 1GHz~3GHz

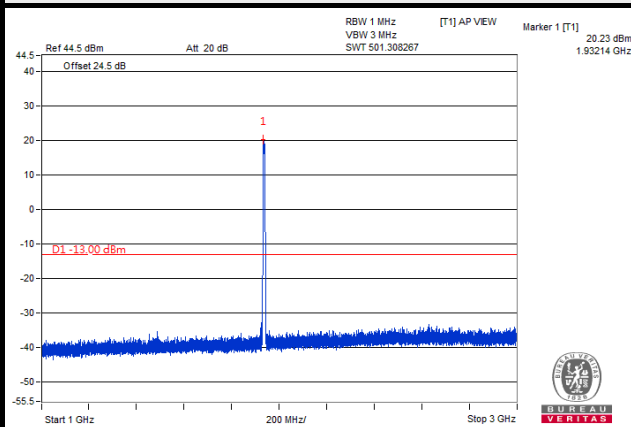

Frequency Range : 3GHz~27GHz

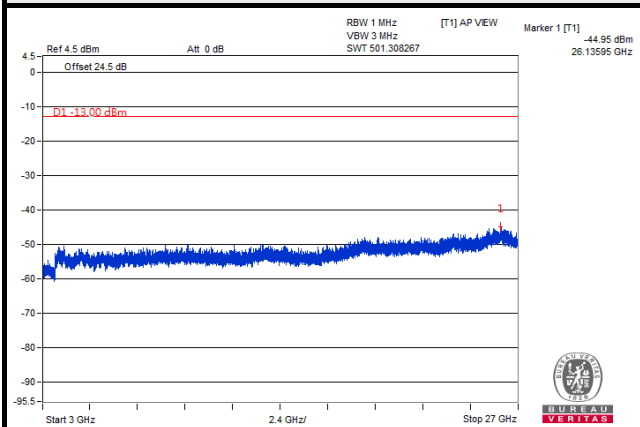

LTE Band 2 Channel 900 + LTE Band 5 Channel 2525

Frequency Range : 9kHz~1GHz

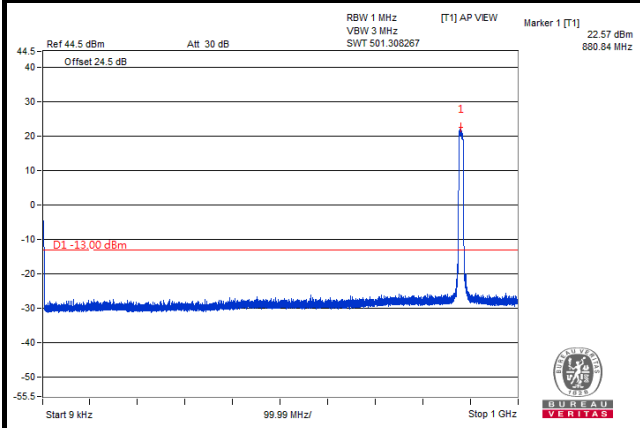

Frequency Range : 1GHz~3GHz

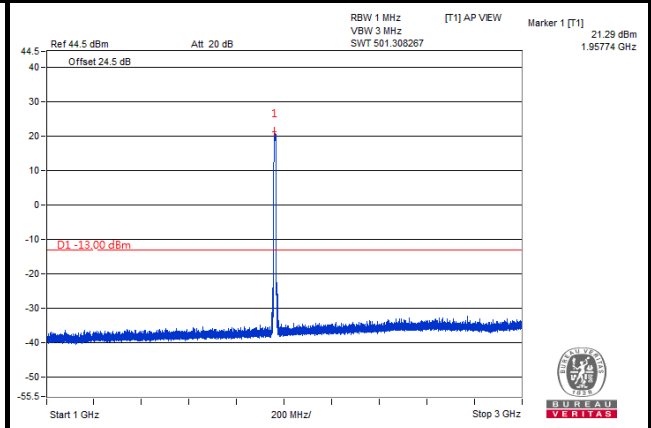

Frequency Range : 3GHz~27GHz

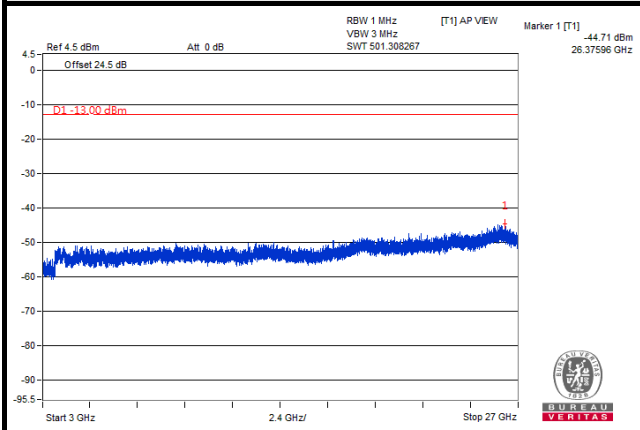

LTE Band 2 Channel 1150 + LTE Band 5 Channel 2600

Frequency Range : 9kHz~1GHz

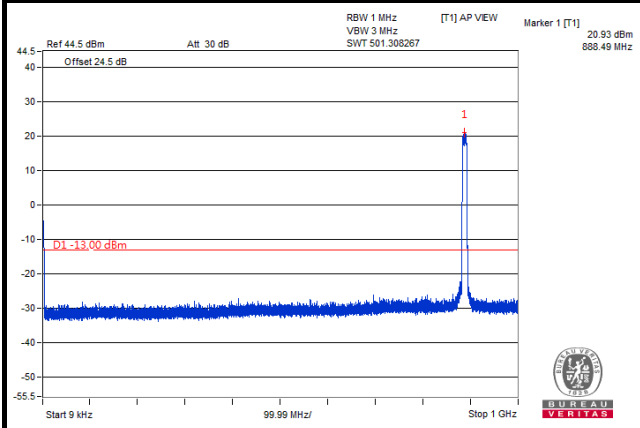

Frequency Range : 1GHz~3GHz

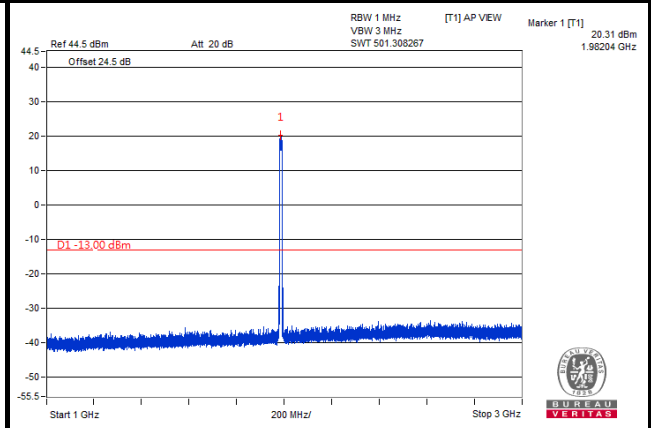

Frequency Range : 3GHz~27GHz

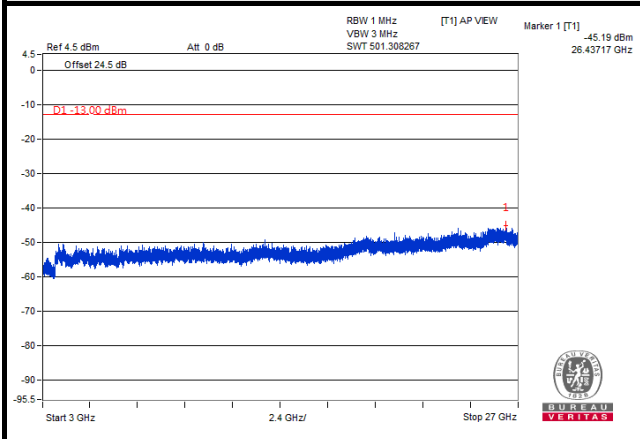

4.2.7 Test Results (Mode D)

CA-2 Mode:

LTE Band 2 CPU2 (CBW: 20MHz) + LTE Band 5 CPU2 (CBW: 10MHz)

LTE Band 2 Channel 700 + LTE Band 5 Channel 2450

Frequency Range : 9kHz~1GHz

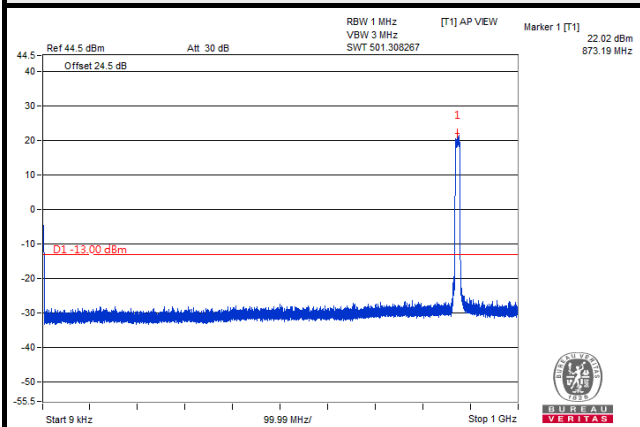

Frequency Range : 1GHz~3GHz

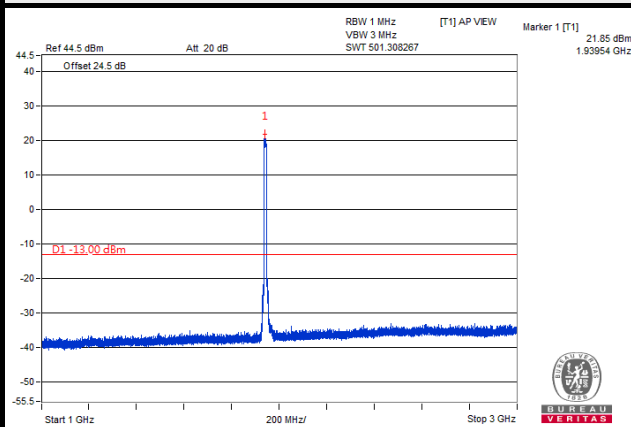

Frequency Range : 3GHz~27GHz

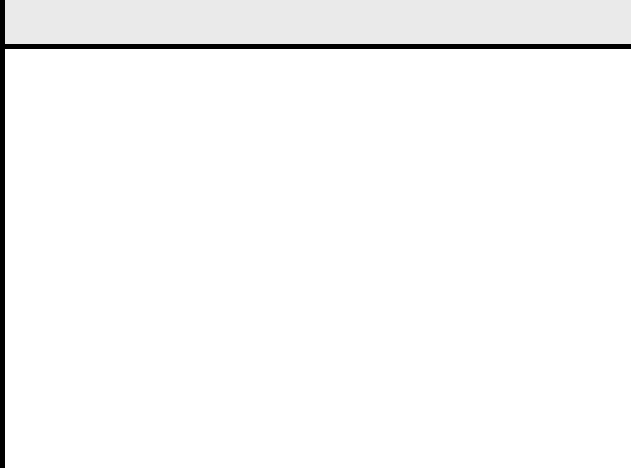
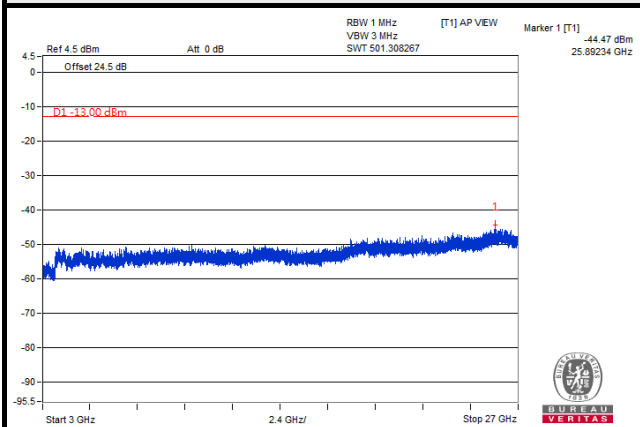

LTE Band 2 Channel 900 + LTE Band 5 Channel 2525

Frequency Range : 9kHz~1GHz

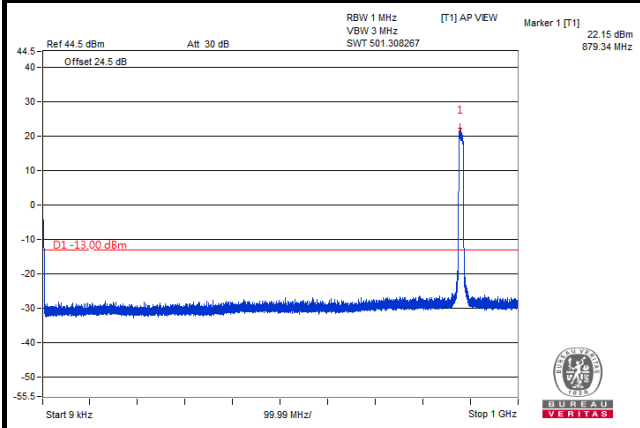

Frequency Range : 1GHz~3GHz

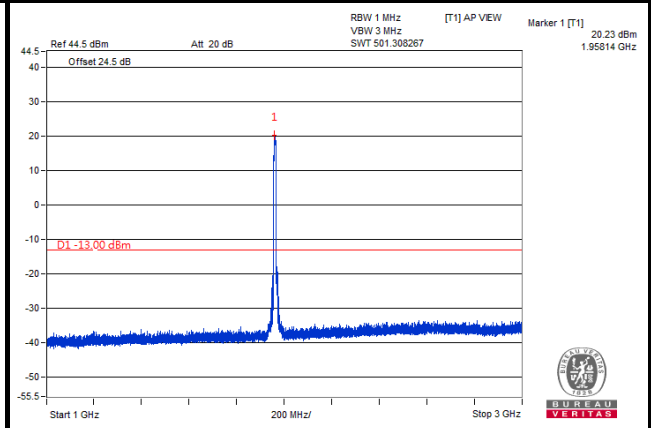

Frequency Range : 3GHz~27GHz

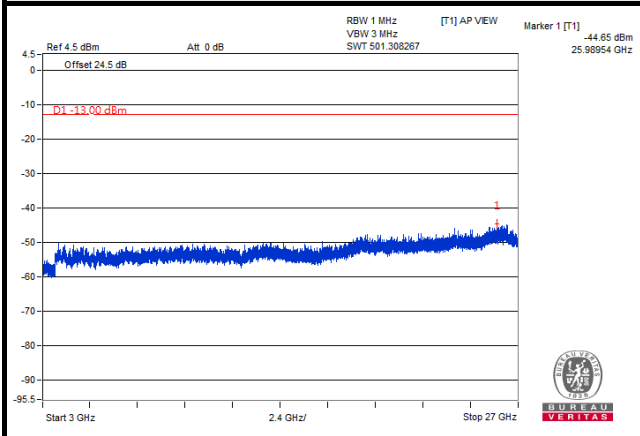

LTE Band 2 Channel 1100 + LTE Band 5 Channel 2600

Frequency Range : 9kHz~1GHz

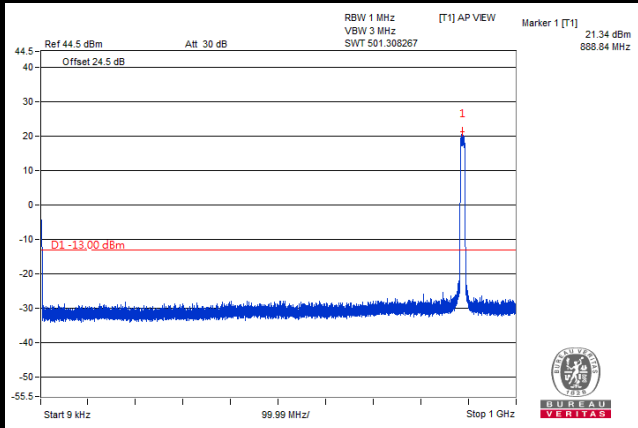

Frequency Range : 1GHz~3GHz

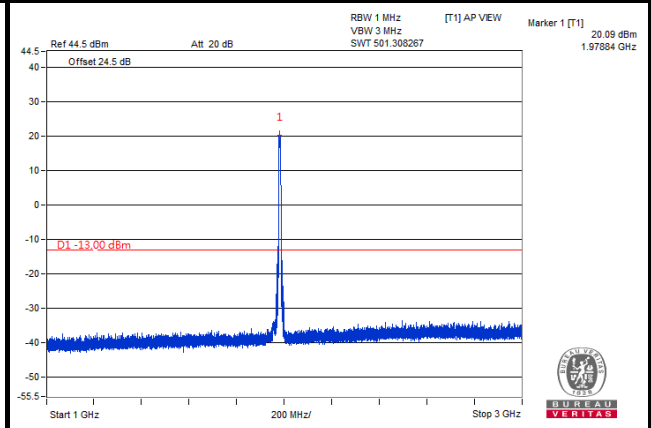

Frequency Range : 3GHz~27GHz

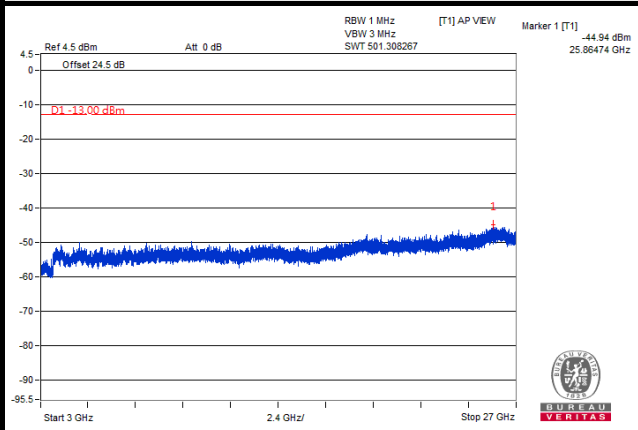

4.2.8 Test Results (Mode E)

CA-1 + CA-2 Mode:

LTE Band 4 CPU1 (CBW: 10MHz) + LTE Band 13 CPU1 (CBW: 10MHz) +
 LTE Band 2 CPU2 (CBW: 10MHz) + LTE Band 5 CPU2 (CBW: 10MHz)

LTE Band 4 Channel 2000 + LTE Band 13 Channel 5230 +
 LTE Band 2 Channel 650 + LTE Band 5 Channel 2450

Frequency Range : 9kHz~1GHz

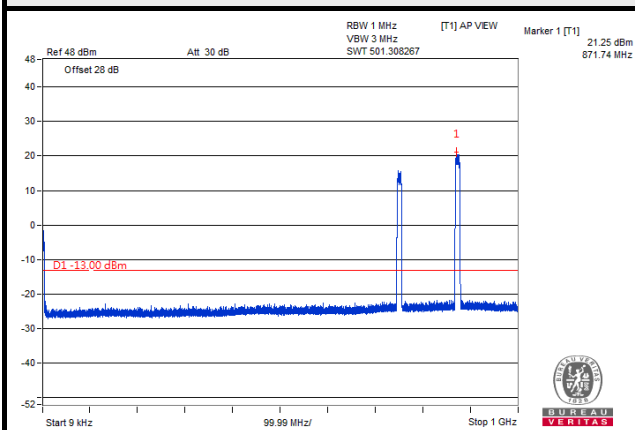

Frequency Range : 1GHz~3GHz

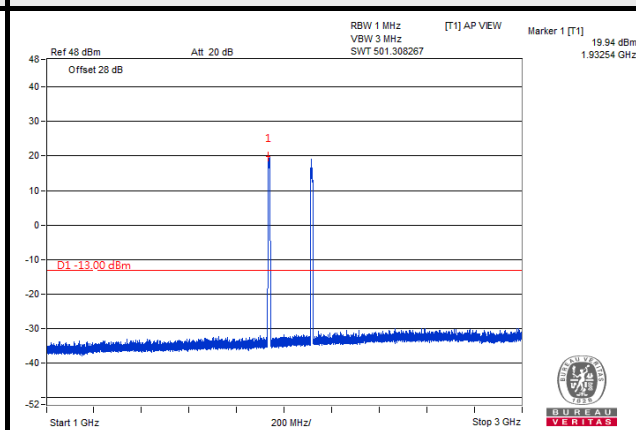

Frequency Range : 3GHz~27GHz

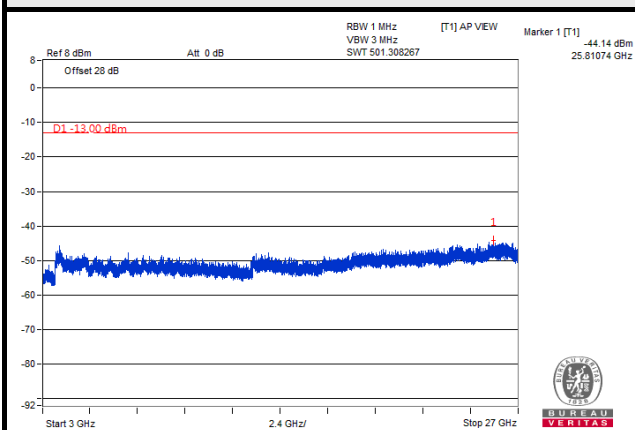

4.2.9 Test Results (Mode F)

CA-1 + CA-2 Mode:

LTE Band 4 CPU1 (CBW: 10MHz) + LTE Band 13 CPU1 (CBW: 10MHz) +
 LTE Band 2 CPU2 (CBW: 20MHz) + LTE Band 5 CPU2 (CBW: 10MHz)

LTE Band 4 Channel 2000 + LTE Band 13 Channel 5230 +
 LTE Band 2 Channel 700 + LTE Band 5 Channel 2450

Frequency Range : 9kHz~1GHz

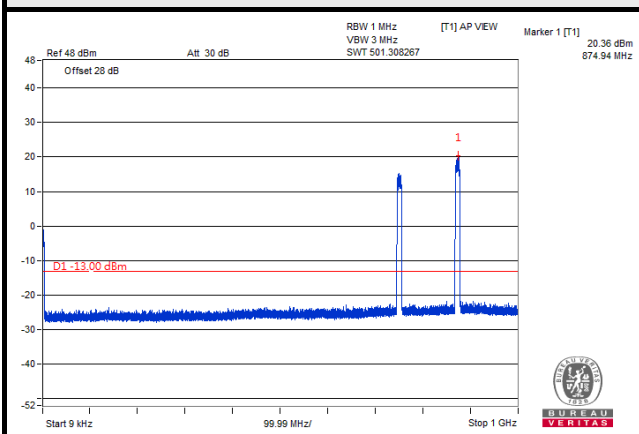

Frequency Range : 1GHz~3GHz

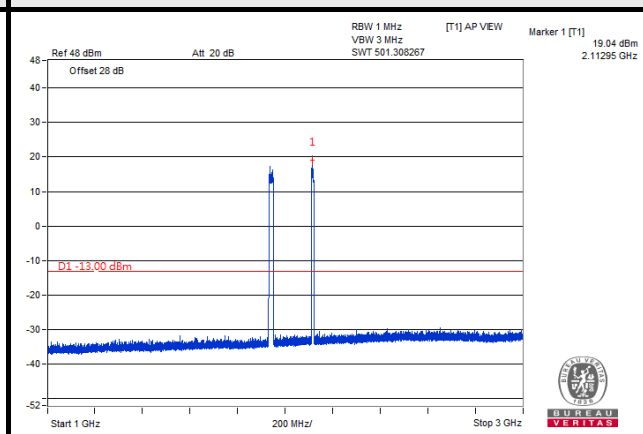

Frequency Range : 3GHz~27GHz

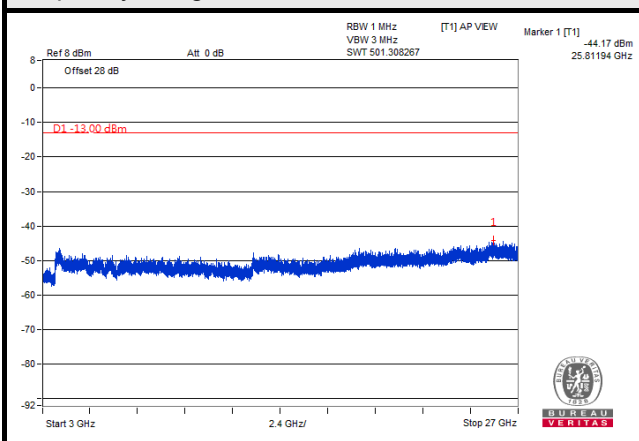

4.2.10 Test Results (Mode G)

CA-1 + CA-2 Mode:

LTE Band 4 CPU1 (CBW: 20MHz) + LTE Band 13 CPU1 (CBW: 10MHz) +
 LTE Band 2 CPU2 (CBW: 10MHz) + LTE Band 5 CPU2 (CBW: 10MHz)

LTE Band 4 Channel 2050 + LTE Band 13 Channel 5230 +
 LTE Band 2 Channel 650 + LTE Band 5 Channel 2450

Frequency Range : 9kHz~1GHz

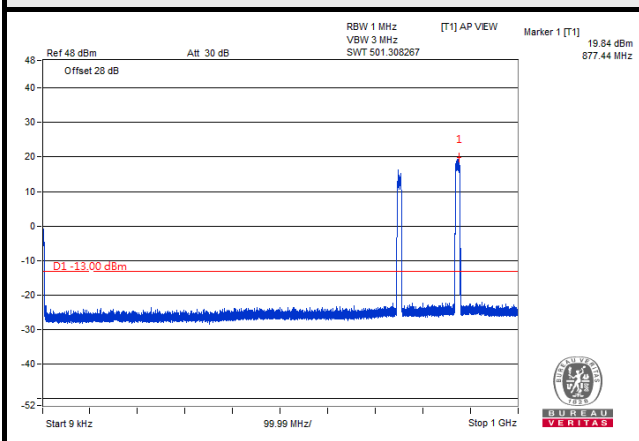

Frequency Range : 1GHz~3GHz

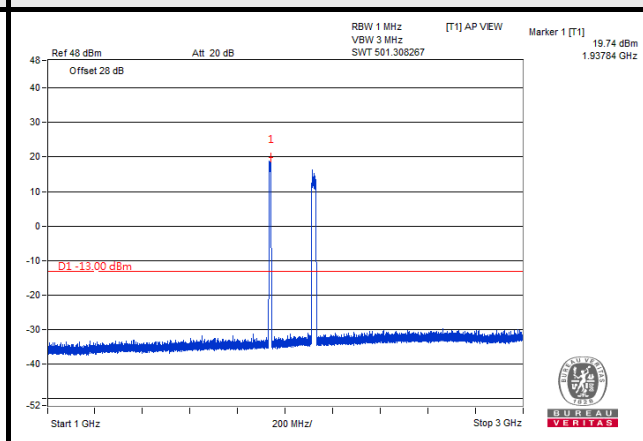

Frequency Range : 3GHz~27GHz

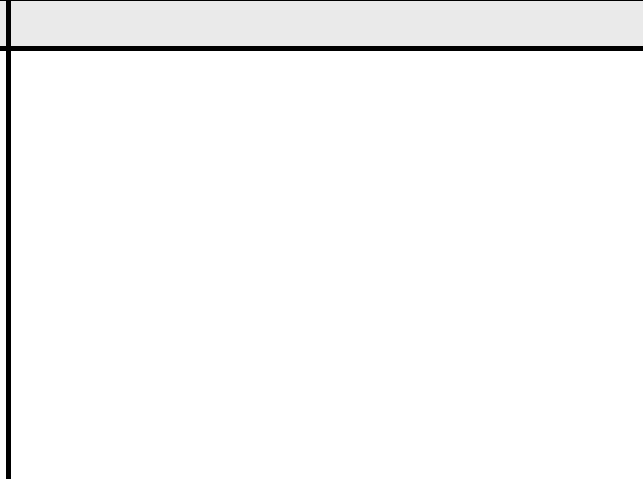
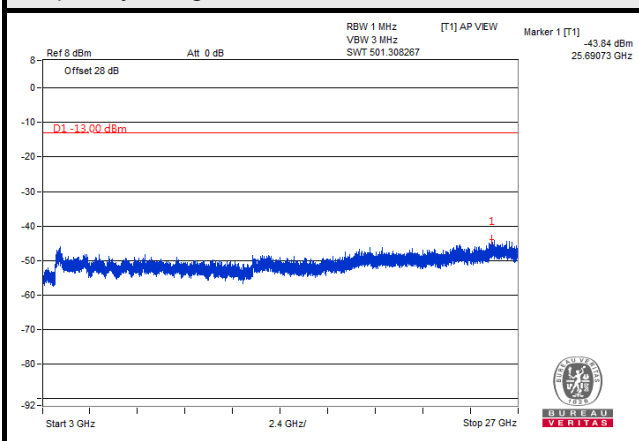

4.2.11 Test Results (Mode H)

CA-1 + CA-2 Mode:

LTE Band 4 CPU1 (CBW: 20MHz) + LTE Band 13 CPU1 (CBW: 10MHz) +

LTE Band 2 CPU2 (CBW: 20MHz) + LTE Band 5 CPU2 (CBW: 10MHz)

LTE Band 4 Channel 2050 + LTE Band 13 Channel 5230 +
 LTE Band 2 Channel 700 + LTE Band 5 Channel 2450

Frequency Range : 9kHz~1GHz

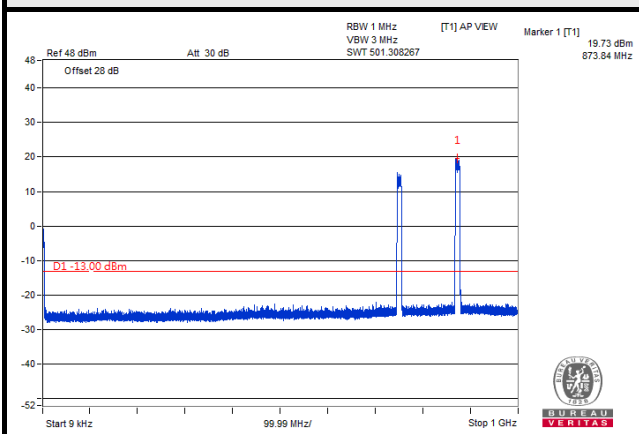

Frequency Range : 1GHz~3GHz

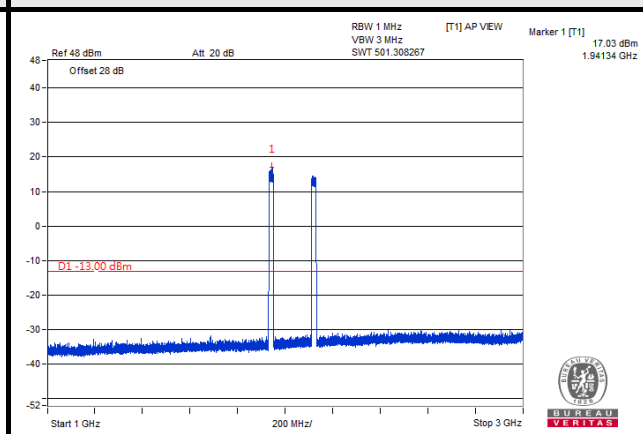

Frequency Range : 3GHz~27GHz

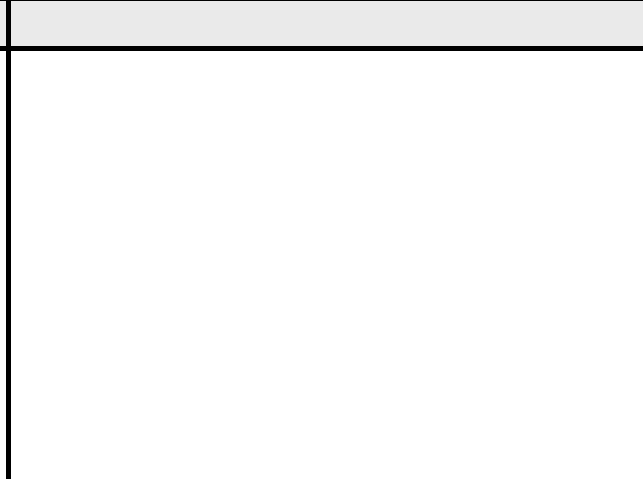
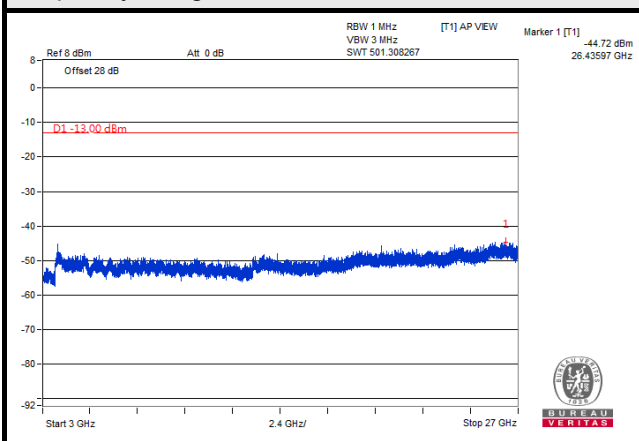

5 Pictures of Test Arrangements

Please refer to the attached file (Test Setup Photo).

Appendix – Information of the Testing Laboratories

We, Bureau Veritas Consumer Products Services (H.K.) Ltd., Taoyuan Branch, were founded in 1988 to provide our best service in EMC, Radio, Telecom and Safety consultation. Our laboratories are FCC recognized accredited test firms and accredited according to ISO/IEC 17025.

If you have any comments, please feel free to contact us at the following:

Lin Kou EMC/RF Lab

Tel: 886-2-26052180

Fax: 886-2-26051924

Hsin Chu EMC/RF/Telecom Lab

Tel: 886-3-6668565

Fax: 886-3-6668323

Hwa Ya EMC/RF/Safety

Tel: 886-3-3183232

Fax: 886-3-3270892

Email: service.adt@tw.bureauveritas.com

Web Site: www.bureauveritas-adt.com

The address and road map of all our labs can be found in our web site also.

--- END ---