



**FCC 47 CFR PART 15 SUBPART C**

**TEST REPORT**

**For**

**ZigBee Smoke Detector**

**Model: SZ-SMK01xxxxxxxx(x= 0~9, A~Z, Blank or any Character)**

**Trade Name: SerComm**

*Issued to*

**SerComm Corporation**

**8F, No. 3-1, YuanQu St., NanKang, Taipei 115, Taiwan, R.O.C.**

*Issued by*

**Compliance Certification Services Inc.**

**No.81-1, Lane 210, Bade 2nd Rd., Lujhu Township,**

**Taoyuan County 33841, Taiwan, R.O.C.**

**TEL: 886-3-324-0332**

**FAX: 886-3-324-5235**

**<http://www.ccsrf.com>**

**[service@ccsrf.com](mailto:service@ccsrf.com)**



**Note:** This report shall not be reproduced except in full, without the written approval of Compliance Certification Services Inc. This document may be altered or revised by Compliance Certification Services Inc. personnel only, and shall be noted in the revision section of the document. The client should not use it to claim product endorsement by TAF, A2LA, NIST or any government agencies. The test results in the report only apply to the tested sample.



**Revision History**

Rev.	Issue Date	Revisions	Effect Page	Revised By
00	March 13, 2013	Initial Issue	ALL	Landy Huang



## TABLE OF CONTENTS

<b>1. TEST RESULT CERTIFICATION .....</b>	<b>4</b>
<b>2. EUT DESCRIPTION .....</b>	<b>5</b>
<b>3. TEST METHODOLOGY .....</b>	<b>6</b>
3.1 EUT CONFIGURATION .....	6
3.2 EUT EXERCISE .....	6
3.3 GENERAL TEST PROCEDURES .....	6
3.4 FCC PART 15.205 RESTRICTED BANDS OF OPERATIONS .....	7
3.5 DESCRIPTION OF TEST MODES .....	7
<b>4. INSTRUMENT CALIBRATION .....</b>	<b>8</b>
4.1 MEASURING INSTRUMENT CALIBRATION .....	8
4.2 MEASUREMENT EQUIPMENT USED .....	8
4.3 MEASUREMENT UNCERTAINTY .....	8
<b>5. FACILITIES AND ACCREDITATIONS .....</b>	<b>9</b>
5.1 FACILITIES .....	9
5.2 EQUIPMENT .....	9
5.3 TABLE OF ACCREDITATIONS AND LISTINGS .....	10
<b>6. SETUP OF EQUIPMENT UNDER TEST .....</b>	<b>11</b>
6.1 SETUP CONFIGURATION OF EUT .....	11
6.2 SUPPORT EQUIPMENT .....	11
<b>7. FCC PART 15.247 REQUIREMENTS .....</b>	<b>12</b>
7.1 6dB BANDWIDTH .....	12
7.2 PEAK POWER .....	15
7.3 AVERAGE POWER .....	16
7.4 BAND EDGES MEASUREMENT .....	17
7.5 PEAK POWER SPECTRAL DENSITY .....	22
7.6 SPURIOUS EMISSIONS .....	25
7.7 POWERLINE CONDUCTED EMISSIONS .....	36
<b>8. APPENDIX I PHOTOGRAPHS OF TEST SETUP .....</b>	<b>37</b>



# 1. TEST RESULT CERTIFICATION

**Applicant:** SerComm Corporation  
8F, No. 3-1, YuanQu St., NanKang, Taipei 115, Taiwan, R.O.C.

**Manufacturer:** SerComm Corporation  
8F, No. 3-1, YuanQu St., NanKang, Taipei 115, Taiwan, R.O.C.

**Equipment Under Test:** ZigBee Smoke Detector

**Trade Name:** SerComm

**Model:** SZ-SMK01xxxxxxxx(x= 0~9, A~Z, Blank or any Character)

**Date of Test:** March 5 ~ March 7, 2013

APPLICABLE STANDARDS	
STANDARD	TEST RESULT
FCC 47 CFR Part 15 Subpart C	No non-compliance noted

## We hereby certify that:

The above equipment was tested by Compliance Certification Services Inc. The test data, data evaluation, test procedures, and equipment configurations shown in this report were made in accordance with the procedures given in ANSI C63.4 and the energy emitted by the sample EUT tested as described in this report is in compliance with the requirements of FCC Rules Part 15.207, 15.209, 15.247.

The test results of this report relate only to the tested sample EUT identified in this report.

**Approved by:**

**Reviewed by:**

\_\_\_\_\_  
Stan Lin  
Section Manager

\_\_\_\_\_  
Angel Hu  
Section Manager



## 2. EUT DESCRIPTION

<b>Product</b>	ZigBee Smoke Detector		
<b>Trade Name</b>	SerComm		
<b>Model Number</b>	SZ-SMK01xxxxxxxx(x= 0~9, A~Z, Blank or any Character)		
<b>Model Discrepancy</b>	1. The mean of "x" (x= 0~9, A~Z, Blank or any Character) on model number just for marketing purpose only. 2. Client consigns only one model sample to test (model number: SZ-SMK01). Therefore, the testing Lab. just guarantees the unit, which has been tested.		
<b>EUT Power Rating</b>	3VDC From Battery		
<b>RF Module Manufacturer</b>	ARM	<b>Model</b>	EM357
<b>Operating Frequency Range</b>	2405 ~ 2480MHz		
<b>Transmit Power</b>	17.59dBm (0.0574W)		
<b>Modulation Technique</b>	OPQSK (Offset Quadrature Phase Shift Keyed)		
<b>Number of Channels</b>	16 Channels		
<b>Antenna Specification</b>	PCB Antenna / Gain: 0.81dBi		

**Remark:**

1. The sample selected for test was production product and was provided by manufacturer.
2. This submittal(s) (test report) is intended for FCC ID: **P27SZSMK01** filing to comply with Section 15.207, 15.209 and 15.247 of the FCC Part 15, Subpart C Rules.



### **3. TEST METHODOLOGY**

The tests documented in this report were performed in accordance with ANSI C63.4 and FCC CFR 47 Part 2, Part 15.207, 15.209 and 15.247.

#### **3.1 EUT CONFIGURATION**

The EUT configuration for testing is installed on RF field strength measurement to meet the Commissions requirement and operating in a manner that intends to maximize its emission characteristics in a continuous normal application.

#### **3.2 EUT EXERCISE**

The EUT was operated in the engineering mode to fix the TX frequency that was for the purpose of the measurements.

According to its specifications, the EUT must comply with the requirements of the Section 15.207, 15.209 and 15.247 under the FCC Rules Part 15 Subpart C.

#### **3.3 GENERAL TEST PROCEDURES**

##### **Conducted Emissions**

The EUT is placed on the turntable, which is 0.8 m above ground plane. According to the requirements in Section 13.1.4.1 of ANSI C63.4 Conducted emissions from the EUT measured in the frequency range between 0.15 MHz and 30MHz using CISPR Quasi-peak and average detector modes.

##### **Radiated Emissions**

The EUT is placed on a turn table, which is 0.8 m above ground plane. The turntable shall rotate 360 degrees to determine the position of maximum emission level. EUT is set 3m away from the receiving antenna, which varied from 1m to 4m to find out the highest emission. And also, each emission was to be maximized by changing the polarization of receiving antenna both horizontal and vertical. In order to find out the maximum emissions, exploratory radiated emission measurements were made according to the requirements in Section 13.1.4.1 of ANSI C63.4.



### 3.4 FCC PART 15.205 RESTRICTED BANDS OF OPERATIONS

(a) Except as shown in paragraph (d) of this section, only spurious emissions are permitted in any of the frequency bands listed below:

MHz	MHz	MHz	GHz
0.090 - 0.110	16.42 - 16.423	399.9 - 410	4.5 - 5.15
<sup>1</sup> 0.495 - 0.505	16.69475 - 16.69525	608 - 614	5.35 - 5.46
2.1735 - 2.1905	16.80425 - 16.80475	960 - 1240	7.25 - 7.75
4.125 - 4.128	25.5 - 25.67	1300 - 1427	8.025 - 8.5
4.17725 - 4.17775	37.5 - 38.25	1435 - 1626.5	9.0 - 9.2
4.20725 - 4.20775	73 - 74.6	1645.5 - 1646.5	9.3 - 9.5
6.215 - 6.218	74.8 - 75.2	1660 - 1710	10.6 - 12.7
6.26775 - 6.26825	108 - 121.94	1718.8 - 1722.2	13.25 - 13.4
6.31175 - 6.31225	123 - 138	2200 - 2300	14.47 - 14.5
8.291 - 8.294	149.9 - 150.05	2310 - 2390	15.35 - 16.2
8.362 - 8.366	156.52475 -	2483.5 - 2500	17.7 - 21.4
8.37625 - 8.38675	156.52525	2655 - 2900	22.01 - 23.12
8.41425 - 8.41475	156.7 - 156.9	3260 - 3267	23.6 - 24.0
12.29 - 12.293	162.0125 - 167.17	3332 - 3339	31.2 - 31.8
12.51975 - 12.52025	167.72 - 173.2	3345.8 - 3358	36.43 - 36.5
12.57675 - 12.57725	240 - 285	3600 - 4400	( <sup>2</sup> )
13.36 - 13.41	322 - 335.4		

<sup>1</sup> Until February 1, 1999, this restricted band shall be 0.490-0.510 MHz.

<sup>2</sup> Above 38.6

(b) Except as provided in paragraphs (d) and (e), the field strength of emissions appearing within these frequency bands shall not exceed the limits shown in Section 15.209. At frequencies equal to or less than 1000 MHz, compliance with the limits in Section 15.209 shall be demonstrated using measurement instrumentation employing a CISPR quasi-peak detector. Above 1000 MHz, compliance with the emission limits in Section 15.209 shall be demonstrated based on the average value of the measured emissions. The provisions in Section 15.35 apply to these measurements.

### 3.5 DESCRIPTION OF TEST MODES

The EUT (model: SZ-SMK01) had been tested under operating condition.

Test program used to control the EUT for staying in continuous transmitting mode was programmed.

After verification, all tests were carried out with the worst case test modes as shown below except radiated spurious emission below 1GHz, which worst case was in transmitting mode only.

Channel Low (2405MHz), Channel Mid (2445MHz) and Channel High (2480MHz) were chosen for the final testing.



### 4. INSTRUMENT CALIBRATION

#### 4.1 MEASURING INSTRUMENT CALIBRATION

The measuring equipment, which was utilized in performing the tests documented herein, has been calibrated in accordance with the manufacturer's recommendations for utilizing calibration equipment, which is traceable to recognized national standards.

#### 4.2 MEASUREMENT EQUIPMENT USED

##### Equipment Used for Emissions Measurement

Conducted Emissions Test Site				
Name of Equipment	Manufacturer	Model	Serial Number	Calibration Due
Spectrum Analyzer	Agilent	E4446A	MY48250064	01/01/2014
Spectrum Analyzer	R&S	FSEB	825829/011	12/18/2013
Power meter	Anritsu	ML2495A	1033009	08/19/2013
Power Sensor	Anritsu	MA2411B	0917221	08/19/2013

3M Semi Anechoic Chamber				
Name of Equipment	Manufacturer	Model	Serial Number	Calibration Due
Spectrum Analyzer	Agilent	E4446A	MY48250064	12/23/2013
Pre-Amplifier	HP	8447D	2944A06530	01/02/2014
Pre-Amplifier	HP	8449B	3008A01738	04/17/2013
Pre-Amplifier	MITEQ	AMF-6F-26040 0-40-8P	985646	05/20/2013
EMI Test Receiver	SCHAFFNER	SCR 3501	430	01/11/2014
Loop Antenna	EMCO	6502	2356	06/11/2013
Bilog Antenna	SCHWAZBECK	VULB9160	3084	09/26/2013
Horn Antenna	EMCO	3115	9602-4659	06/14/2013
Horn Antenna	EMCO	3116	00026370	10/07/2013
Antenna Tower	CCS	CC-A-1F	N/A	N.C.R
Turn Table	CCS	CC-T-1F	N/A	N.C.R
Test S/W	LabVIEW 6.1 (Wugu Chamber EMI Teat V1_4.5.3)			

**Remark:** Each piece of equipment is scheduled for calibration once a year.

#### 4.3 MEASUREMENT UNCERTAINTY

Parameter	Uncertainty
Powerline Conducted Emission	N/A
3M Semi Anechoic Chamber / 30MHz ~ 1GHz	±3.7046
3M Semi Anechoic Chamber / Above 1GHz	±3.0958

**Remark:** This uncertainty represents an expanded uncertainty expressed at approximately the 95% confidence level using a coverage factor of k=2.





## **5. FACILITIES AND ACCREDITATIONS**

### **5.1 FACILITIES**

All measurement facilities used to collect the measurement data are located at

No. 163-1, Jhongsheng Rd., Sindien District, Taipei City 23151, Taiwan Tel:  
886-2-2217-0894 / Fax: 886-2-2217-1029

No 11, Wugong 6th Rd, Wugu District, New Taipei City 24891, Taiwan (R.O.C)  
Tel: 886-2-2299-9720 / Fax: 886-2-2298-4045

No.81-1, Lane 210, Bade 2nd Rd., Lujhu Township, Taoyuan County 33841, Taiwan, R.O.C.  
Tel: 886-3-324-0332 / Fax: 886-3-324-5235

The sites are constructed in conformance with the requirements of ANSI C63.7, ANSI C63.4 and CISPR Publication 22.

### **5.2 EQUIPMENT**

Radiated emissions are measured with one or more of the following types of linearly polarized antennas: tuned dipole, biconical, log periodic, bi-log, and/or ridged waveguide, horn. Spectrum analyzers with pre-selectors and quasi-peak detectors are used to perform radiated measurements.





Conducted emissions are measured with Line Impedance Stabilization Networks and EMI Test Receivers.

Calibrated wideband preamplifiers, coaxial cables, and coaxial attenuators are also used for making measurements.

All receiving equipment conforms to CISPR Publication 16-1, "Radio Interference Measuring Apparatus and Measurement Methods."



### 5.3 TABLE OF ACCREDITATIONS AND LISTINGS

Country	Agency	Scope of Accreditation	Logo
USA	A2LA	CFR 47, FCC Part15/18, CISPR 22, EN 55022, ICES-003, AS/NZS CISPR 22, VCCI V-3, EN 55011, CISPR 11, IEC/EN 61000-4-2/3/4/5/6/8/11, EN 61000-6-1/2/3/4, EN 55024, CISPR 24, AS/NZS CISPR 24, AS/NZS 61000.6.2, EN 55014-1/-2, ETSI EN 300 386 v1.3.2/v1.3.3, IEC/EN 61000-3-2, AS/NZS 61000.3.2, IEC/EN 61000-3-3, AS/NZS 61000.3.3	
USA	FCC MRA	3/10 meter Open Area Test Sites to perform FCC Part 15/18 measurements	
Japan	VCCI	3/10 meter Open Area Test Sites and conducted test sites to perform radiated/conducted measurements	<b>VCCI</b> R-2882/2541/2798/725/1868 C-402/747/912 T-1930/1646
Taiwan	TAF	EN 55014-1, CISPR 14, CNS 13781-1, EN 55013, CISPR 13, CNS 13439, EN 55011, CISPR 11, CNS 13803, PLMN09, IS2045-0, LP0002 FCC Part 27/90, Part 15B/C/D/E, RSS-192/193/210/310 ETSI EN 300 328/ 300 220-1/ 300 220-2/ 301 893/ 301 489-01/ 301 489-03/ 301 489-07 / 301 489-17/ 300 440-1/ 300 440-2 AS/NZS 4268, AS/NZS 4771 CISPR 22, EN 55022, CNS 13438, AS/NZS CISPR 22, VCCI, IEC/EN 61000-4-2/3/4/5/6/8/11, CNS 14676-2/3/4/5/6/8, CNS 14934-2/3, CNS 13783-1, CNS 13439, CNS 13803	
Taiwan	BSMI	CNS 13438, CNS 13783-1, CNS 13439, CNS 14115	SL2-IS-E-0014 / IN-E-0014 /A1-E-0014 /R1-E-0014 /R2-E-0014 /L1-E-0014
Canada	Industry Canada	RSS-Gen Issue 3	

**Note:** No part of this report may be used to claim or imply product endorsement by A2LA, TAF or other government agency.



## 6. SETUP OF EQUIPMENT UNDER TEST

### 6.1 SETUP CONFIGURATION OF EUT

See test photographs attached in Appendix 1 for the actual connections between EUT and support equipment.

### 6.2 SUPPORT EQUIPMENT

For Conducted Emission Measurement:							
No.	Device Type	Model	Series No.	FCC ID	Brand	Data Cable	Power Cord
1.	Notebook PC	D400	0932RY	E2K24GBRL	DELL	N/A	I/P: Unshielded, 1.8m O/P: Unshielded, 1.0m
2	Default Hostname	ISA3	N/A	N/A	ember	Unshielded, 0.5m	N/A

For Radiated Emission measurement:							
No.	Device Type	Model	Series No.	FCC ID	Brand	Data Cable	Power Cord
	N/A						

**\*\*No any support equipment during the test.**

**Remark:** Grounding was established in accordance with the manufacturer's requirements and conditions for the intended use.



## 7. FCC PART 15.247 REQUIREMENTS

### 7.1 6dB BANDWIDTH

#### LIMIT

According to §15.247(a)(2), systems using digital modulation techniques may operate in the 902 - 928 MHz, 2400 - 2483.5 MHz, and 5725 - 5850 MHz bands. The minimum 6 dB bandwidth shall be at least 500 kHz.

#### TEST CONFIGURATION

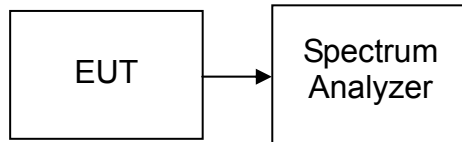

#### TEST PROCEDURE

1. Place the EUT on the table and set it in the transmitting mode.
2. Remove the antenna from the EUT and then connect a low loss RF cable from the antenna port to the spectrum analyzer.
3. Set the spectrum analyzer as RBW = 100kHz, VBW = 300kHz, Span = 3MHz, Sweep = auto.
4. Mark the peak frequency and -6dB (upper and lower) frequency.
5. Repeat until all the rest channels are investigated.

#### TEST RESULTS

*No non-compliance noted*

#### TEST DATA

Channel	Frequency (MHz)	Bandwidth (MHz)	Limit (kHz)	Result
Low	2405	1.600	>500	PASS
Mid	2445	1.610		PASS
High	2480	1.630		PASS



### Test Plot

#### 6dB Bandwidth (CH Low)

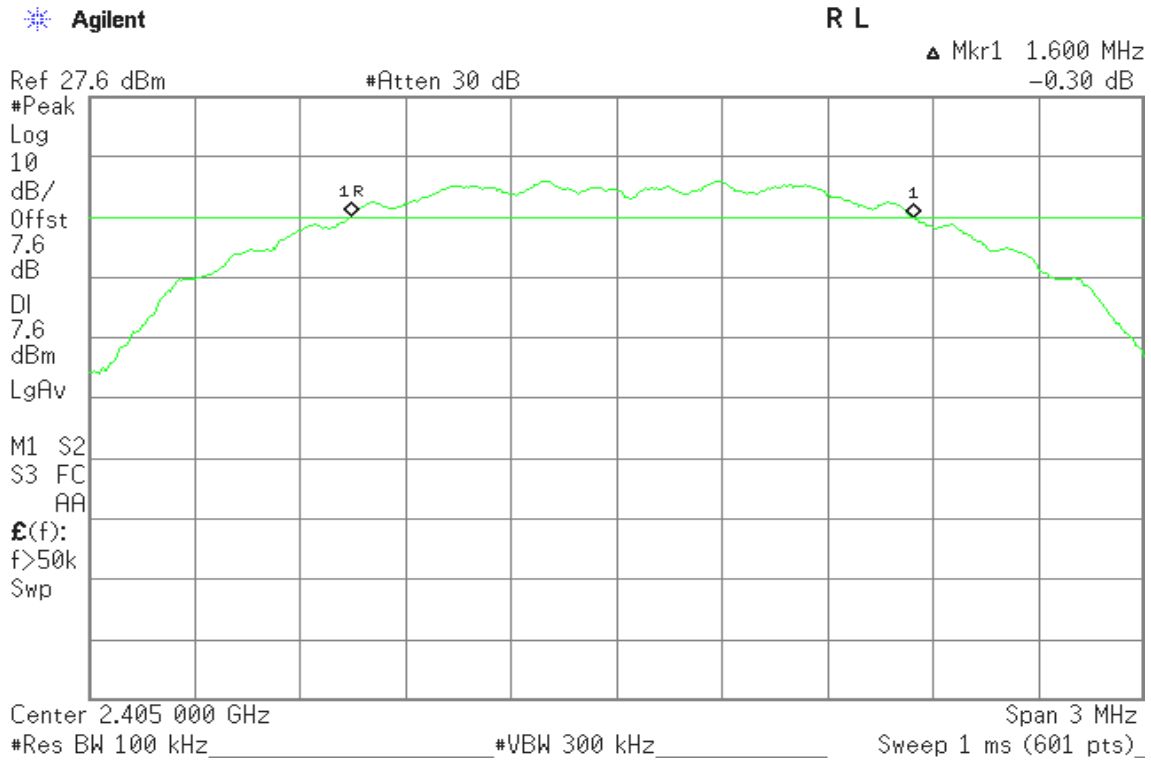

#### 6dB Bandwidth (CH Mid)

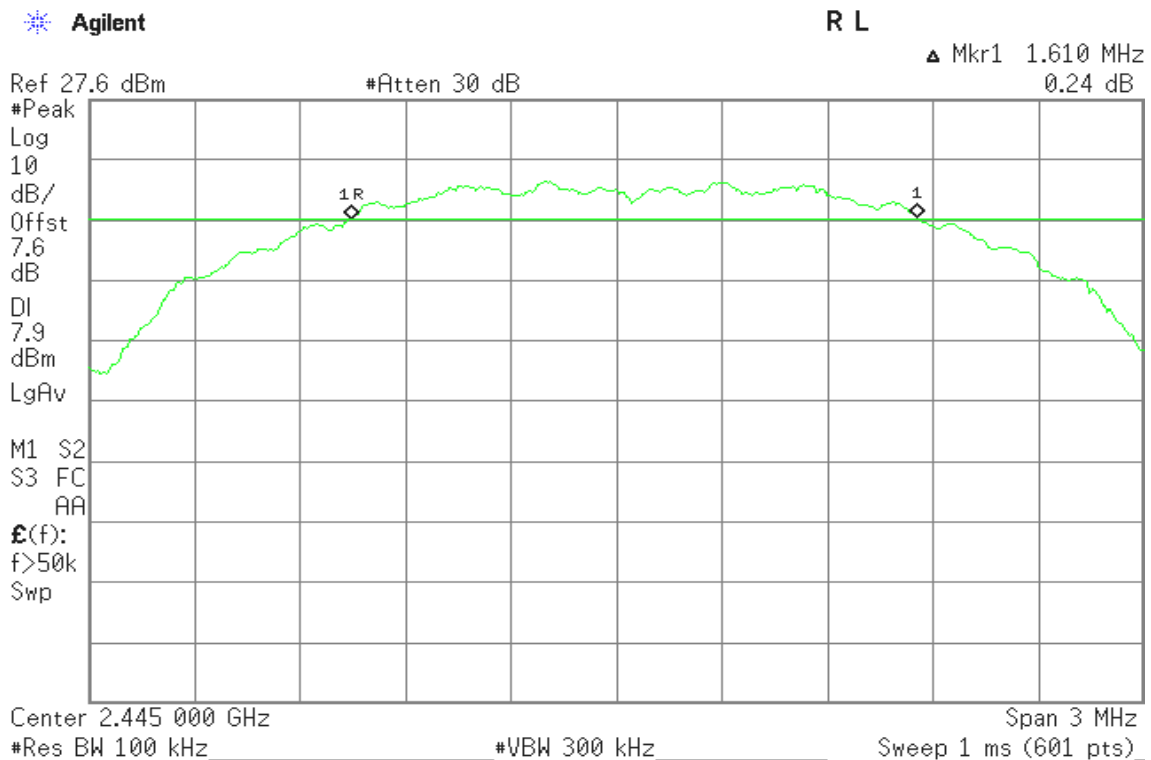



### 6dB Bandwidth (CH High)

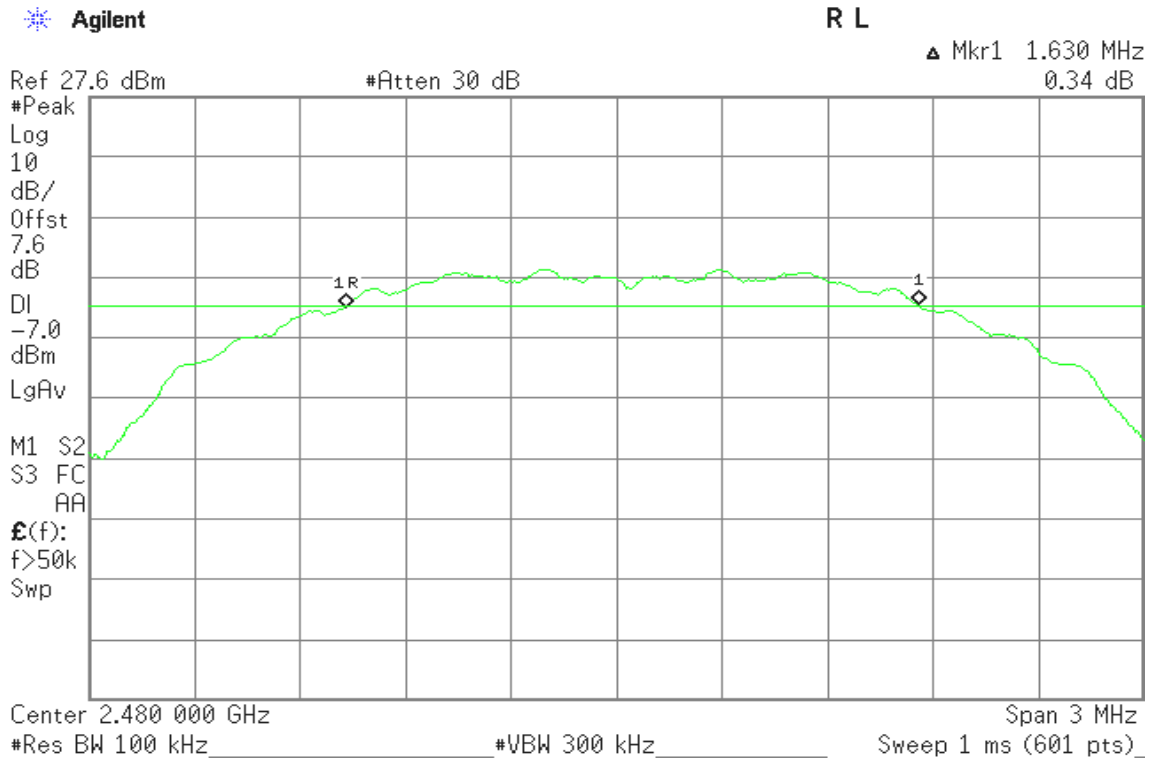



## 7.2 PEAK POWER

### LIMIT

The maximum peak output power of the intentional radiator shall not exceed the following:

1. According to §15.247(b)(3), for systems using digital modulation in the bands of 902-928 MHz, 2400-2483.5 MHz, and 5725-5850 MHz: 1 Watt.
2. According to §15.247(b)(4), the conducted output power limit specified in paragraph (b) of this section is based on the use of antennas with directional gains that do not exceed 6 dBi. Except as shown in paragraph (c) of this section, if transmitting antennas of directional gain greater than 6 dBi are used, the conducted output power from the intentional radiator shall be reduced below the stated values in paragraphs (b)(1), (b)(2), and (b)(3) of this section, as appropriate, by the amount in dB that the directional gain of the antenna exceeds 6 dBi.

### TEST CONFIGURATION

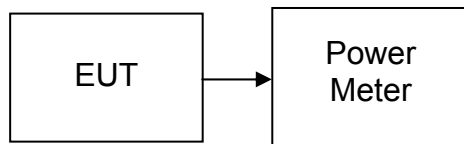

### TEST PROCEDURE

**Per KDB 558074 V02**

The transmitter output is connected to the Power Meter. The Power Meter is set to the peak power detection.

### TEST RESULTS

*No non-compliance noted*

### TEST DATA

Channel	Frequency (MHz)	Output Power (dBm)	Output Power (W)	Limit (W)	Result
Low	2405	16.85	0.0484	1	PASS
Mid	2445	17.59	0.0574		PASS
High	2480	3.01	0.0020		PASS



### **7.3 AVERAGE POWER**

#### **LIMIT**

None; for reporting purposes only.

#### **TEST CONFIGURATION**

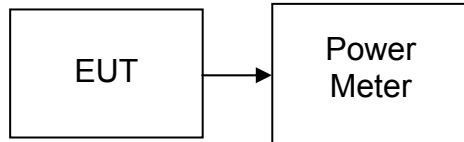

#### **TEST PROCEDURE**

**Per KDB 558074 V02**

The transmitter output is connected to the Power Meter. The Power Meter is set to the peak power detection.

#### **TEST RESULTS**

*No non-compliance noted*

#### **TEST DATA**

Channel	Frequency (MHz)	Output Power (dBm)	Output Power (W)
Low	2405	16.76	0.0474
Mid	2445	17.51	0.0564
High	2480	2.92	0.0020





## 7.4 BAND EDGES MEASUREMENT

### LIMIT

According to §15.247(d), in any 100 kHz bandwidth outside the frequency bands in which the spread spectrum intentional radiator is operating, the radio frequency power that is produced by the intentional radiator shall be at least 20 dB below that in the 100 kHz bandwidth within the band that contains the highest level of the desired power, based on either an RF conducted or a radiated measurement, provided the transmitter demonstrates compliance with the peak conducted power limits. In addition, radiated emissions which fall in the restricted bands, as defined in §15.205(a), must also comply with the radiated emission limits specified in 15.209(a) (see Section 15.205(c)).

### TEST CONFIGURATION

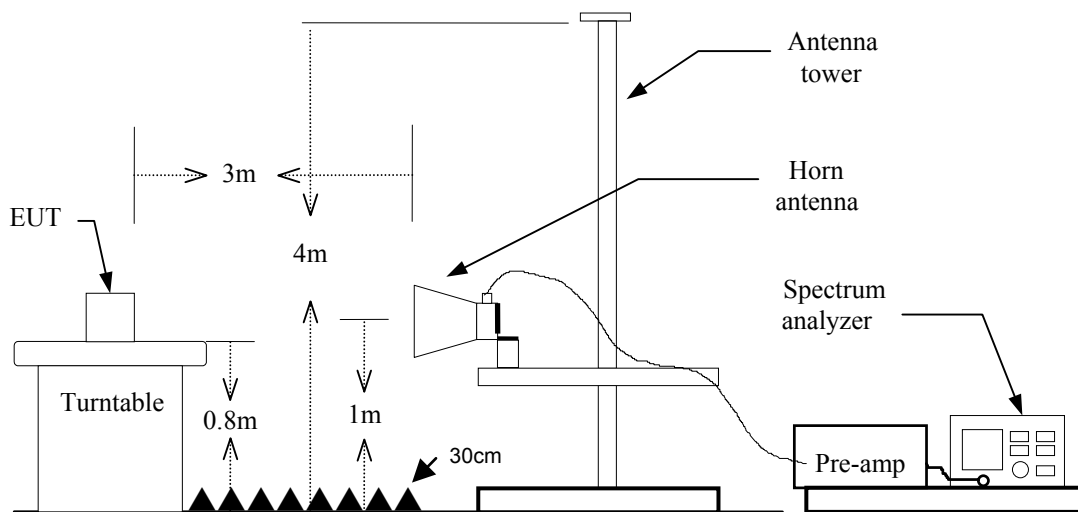

### TEST PROCEDURE

1. The EUT is placed on a turntable, which is 0.8m above the ground plane.
2. The turntable shall be rotated for 360 degrees to determine the position of maximum emission level.
3. EUT is set 3m away from the receiving antenna, which is varied from 1m to 4m to find out the highest emission.
4. Set the spectrum analyzer in the following setting in order to capture the lower and upper band-edges of the emission:
  - (a) PEAK: RBW=VBW=1MHz / Sweep=100ms
  - (b) AVERAGE: RBW=1MHz / VBW=10Hz / Sweep=AUTO
5. Repeat the procedures until all the PEAK and AVERAGE versus POLARIZATION are measured.

### TEST RESULTS

Refer to attach spectrum analyzer data chart.



Test Plot

Band Edges (CH Low)

Detector mode: Peak

Polarity: Vertical

Agilent

R L

Mkr2 2.404 58 GHz  
103.15 dBµV/m

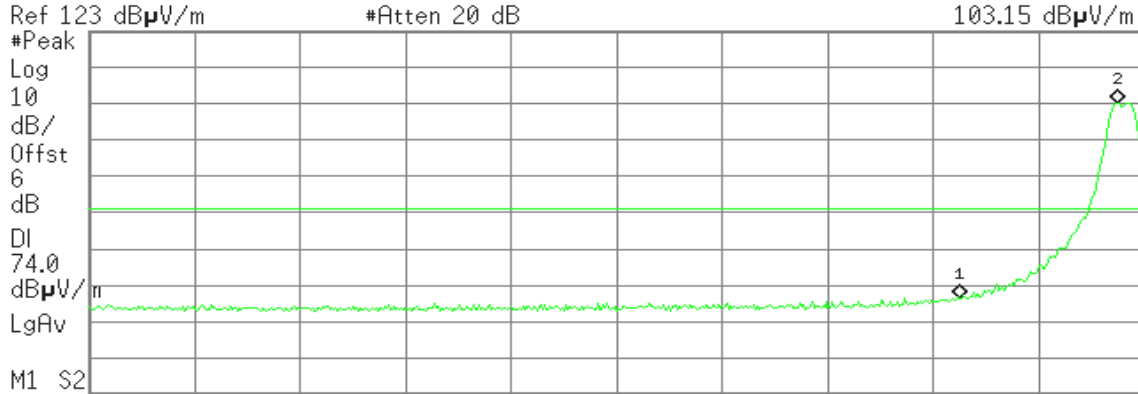

Start 2.310 00 GHz Stop 2.407 00 GHz  
#Res BW 1 MHz #VBW 1 MHz #Sweep 100 ms (601 pts)

Marker	Trace	Type	X Axis	Amplitude
1	(1)	Freq	2.390 00 GHz	49.49 dBµV/m
2	(1)	Freq	2.404 58 GHz	103.15 dBµV/m

Detector mode: Average

Polarity: Vertical

Agilent

R L

Mkr2 2.405 06 GHz  
100.28 dBµV/m

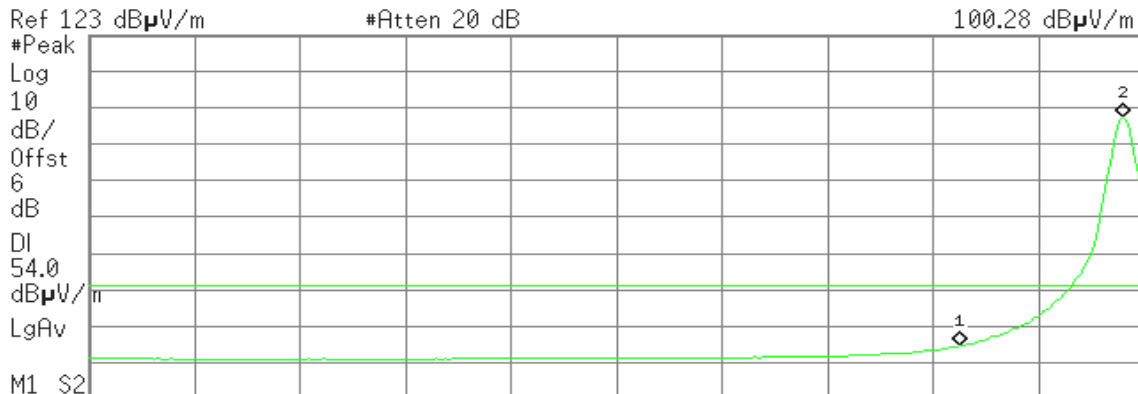

Start 2.310 00 GHz Stop 2.407 00 GHz  
#Res BW 1 MHz #VBW 10 Hz Sweep 7.564 s (601 pts)

Marker	Trace	Type	X Axis	Amplitude
1	(1)	Freq	2.390 00 GHz	37.50 dBµV/m
2	(1)	Freq	2.405 06 GHz	100.28 dBµV/m



Detector mode: Peak

Polarity: Horizontal

Agilent

R L

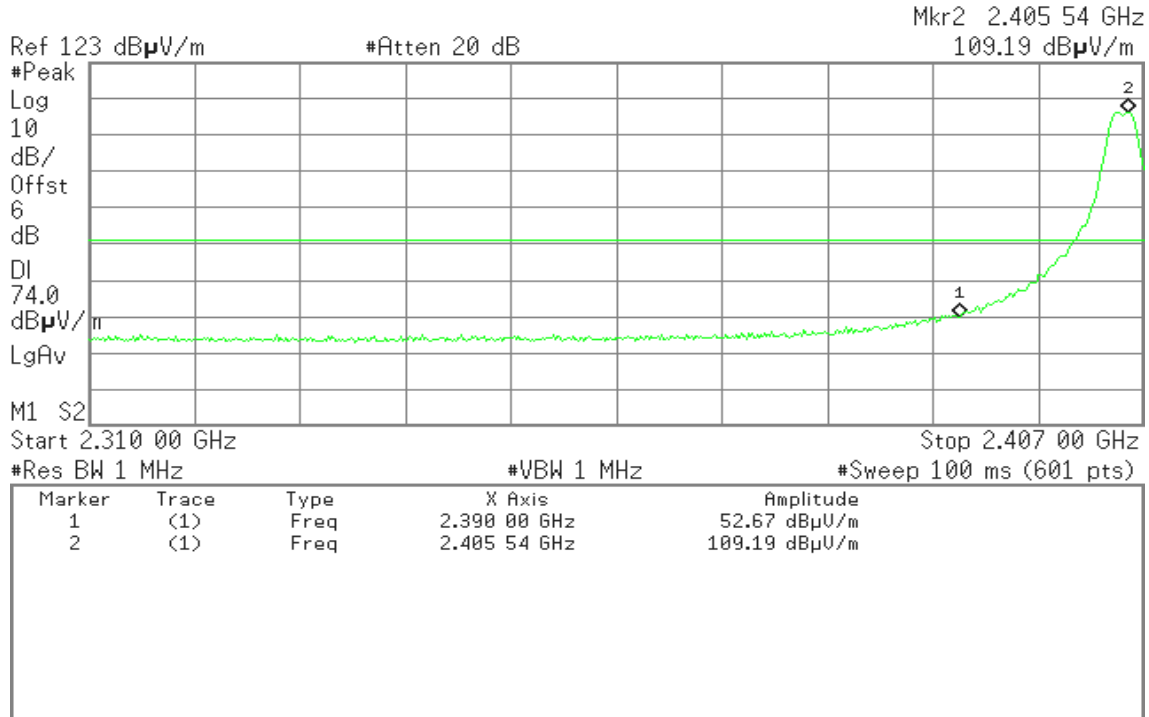

Detector mode: Average

Polarity: Horizontal

Agilent

R L

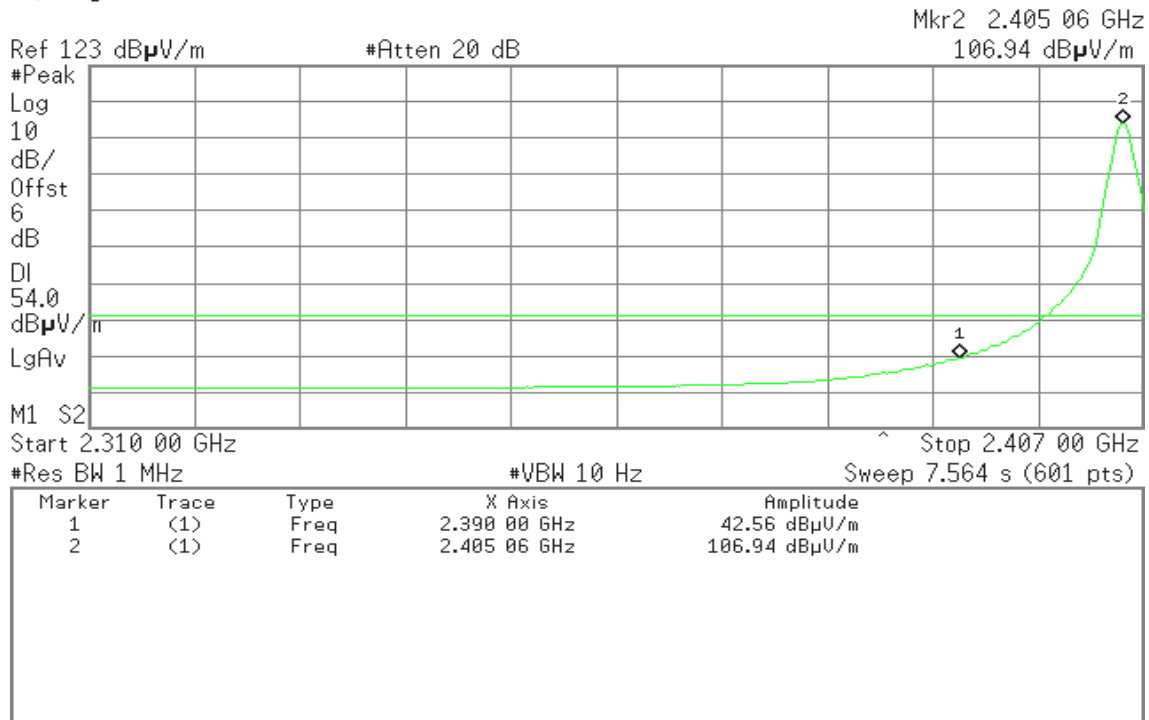



Band Edges (CH High)

Detector mode: Peak

Polarity: Vertical

Agilent

R L

Mkr1 2.480 60 GHz  
87.27 dBµV/m

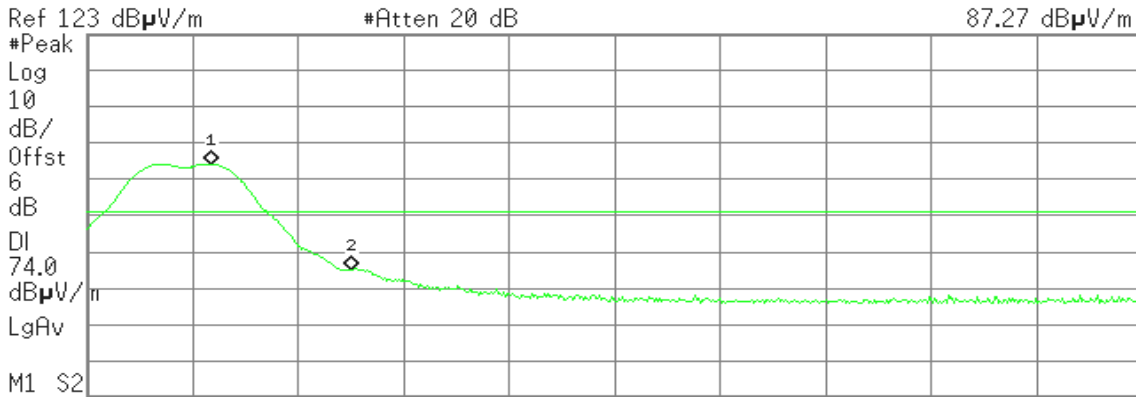

Start 2.478 00 GHz Stop 2.500 00 GHz  
#Res BW 1 MHz #VBW 1 MHz #Sweep 100 ms (601 pts)

Marker	Trace	Type	X Axis	Amplitude
1	(1)	Freq	2.480 60 GHz	87.27 dBµV/m
2	(1)	Freq	2.483 50 GHz	57.92 dBµV/m

Detector mode: Average

Polarity: Vertical

Agilent

R L

Mkr1 2.480 09 GHz  
84.24 dBµV/m



Start 2.478 00 GHz Stop 2.500 00 GHz  
#Res BW 1 MHz #VBW 10 Hz Sweep 1.715 s (601 pts)

Marker	Trace	Type	X Axis	Amplitude
1	(1)	Freq	2.480 09 GHz	84.24 dBµV/m
2	(1)	Freq	2.483 50 GHz	47.33 dBµV/m



**Detector mode: Peak**

**Polarity: Horizontal**

Agilent

R L

Mkr1 2.480 53 GHz  
94.82 dB $\mu$ V/m

Ref 123 dB $\mu$ V/m

#Atten 20 dB

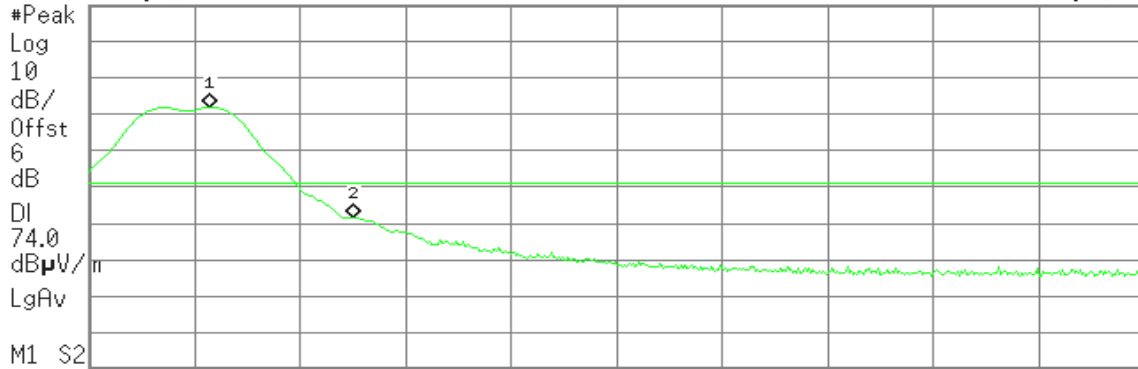

Start 2.478 00 GHz

Stop 2.500 00 GHz

#Res BW 1 MHz

#VBW 1 MHz

#Sweep 100 ms (601 pts)

Marker	Trace	Type	X Axis	Amplitude
1	(1)	Freq	2.480 53 GHz	94.82 dB $\mu$ V/m
2	(1)	Freq	2.483 50 GHz	64.71 dB $\mu$ V/m

**Detector mode: Average**

**Polarity: Horizontal**

Agilent

R L

Mkr1 2.480 09 GHz  
92.58 dB $\mu$ V/m

Ref 123 dB $\mu$ V/m

#Atten 20 dB

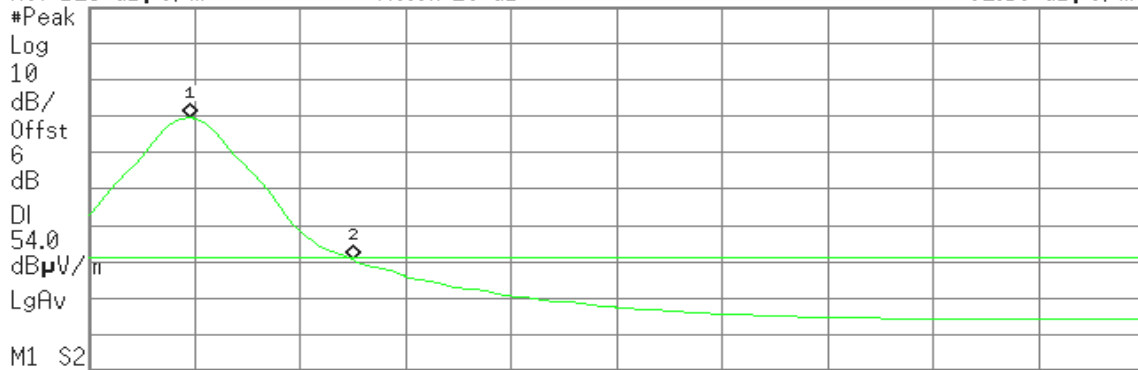

Start 2.478 00 GHz

Stop 2.500 00 GHz

#Res BW 1 MHz

#VBW 10 Hz

Sweep 1.715 s (601 pts)

Marker	Trace	Type	X Axis	Amplitude
1	(1)	Freq	2.480 09 GHz	92.58 dB $\mu$ V/m
2	(1)	Freq	2.483 50 GHz	53.54 dB $\mu$ V/m



## 7.5 PEAK POWER SPECTRAL DENSITY

### LIMIT

1. According to §15.247(e), for digitally modulated systems, the power spectral density conducted from the intentional radiator to the antenna shall not be greater than 8 dBm in any 3 kHz band during any time interval of continuous transmission.
2. According to §15.247(f), the digital modulation operation of the hybrid system, with the frequency hopping turned off, shall comply with the power density requirements of paragraph (d) of this section.

### TEST CONFIGURATION

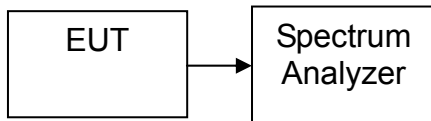

### TEST PROCEDURE

#### Per KDB 558074 V02

1. Place the EUT on the table and set it in transmitting mode. Remove the antenna from the EUT and then connect a low loss RF cable from the antenna port to the spectrum analyzer.
2. Set the spectrum analyzer as RBW = 3kHz, VBW = 10kHz, Span = 3MHz, Sweep= auto.
3. Record the max. reading.
4. Repeat the above procedure until the measurements for all frequencies are completed.

### TEST RESULTS

*No non-compliance noted*

### TEST DATA

Channel	Frequency (MHz)	PPSD (dBm)	Limit (dBm)	Result
Low	2405	2.99	8.00	PASS
Mid	2445	2.46		
High	2480	-12.99		



### Test Plot

#### PPSD (CH Low)

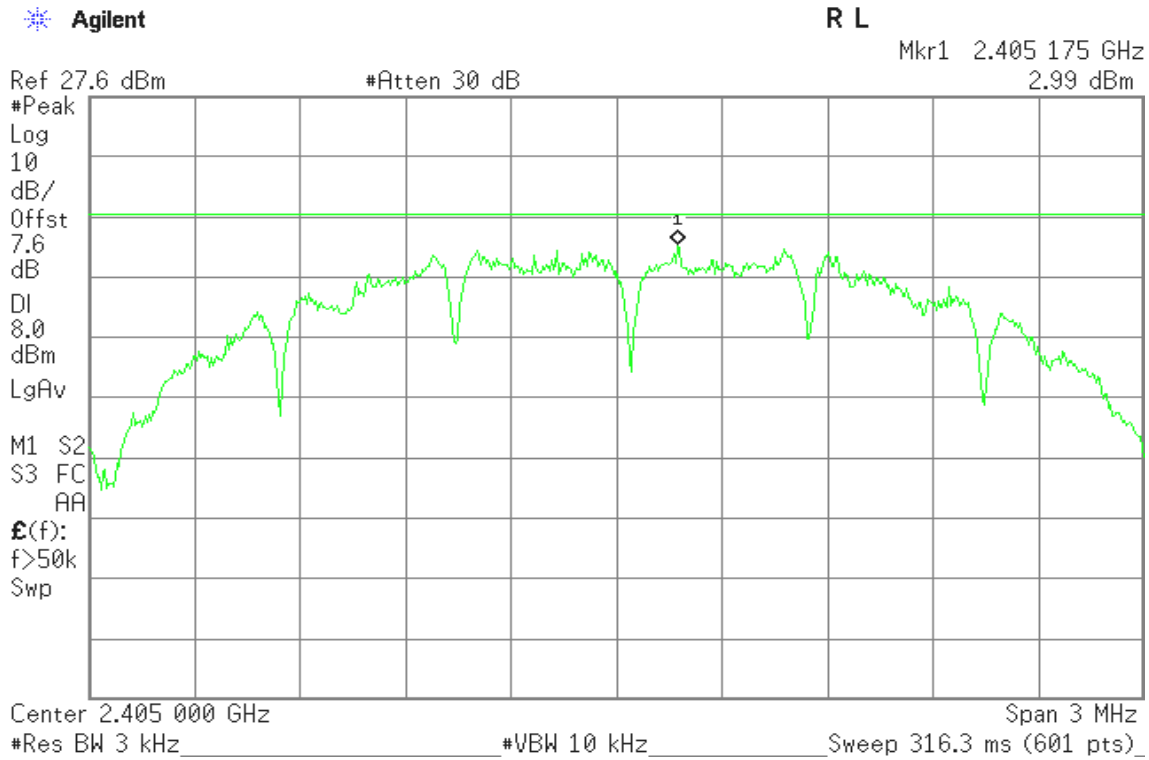

#### PPSD (CH Mid)

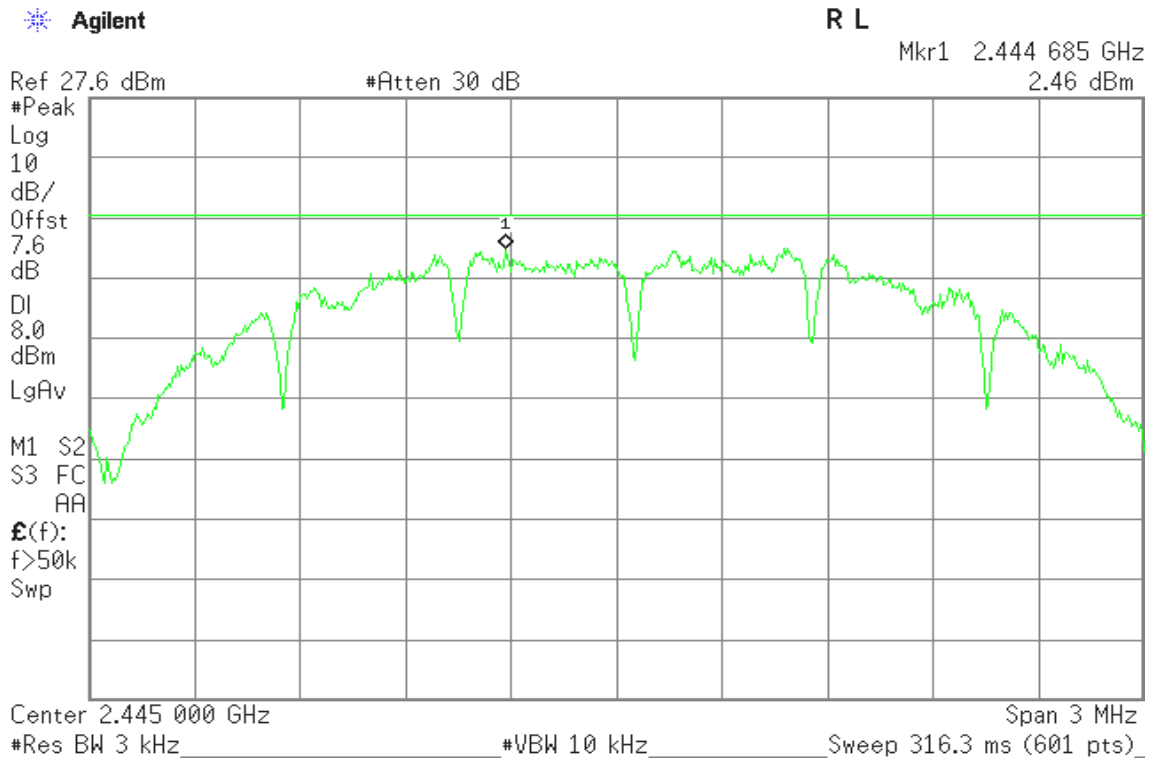



### PPSD (CH High)

Agilent

R T

Mkr1 2.480 155 GHz  
-12.99 dBm

Ref 27.6 dBm

#Atten 30 dB

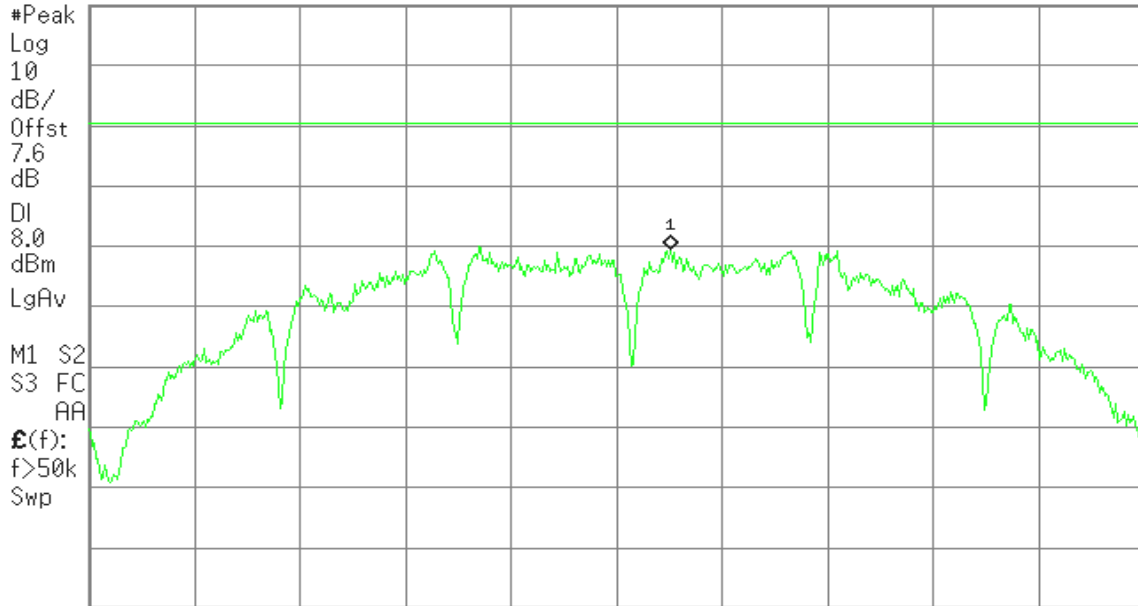

Center 2.480 000 GHz

Span 3 MHz

#Res BW 3 kHz

#VBW 10 kHz

Sweep 316.3 ms (601 pts)





## **7.6 SPURIOUS EMISSIONS**

### **7.6.1 CONDUCTED MEASUREMENT**

#### **LIMIT**

According to §15.247(d), in any 100 kHz bandwidth outside the frequency bands in which the spread spectrum intentional radiator is operating, the radio frequency power that is produced by the intentional radiator shall be at least 20 dB below that in the 100 kHz bandwidth within the band that contains the highest level of the desired power, based on either an RF conducted or a radiated measurement, provided the transmitter demonstrates compliance with the peak conducted power limits. In addition, radiated emissions which fall in the restricted bands, as defined in §15.205(a), must also comply with the radiated emission limits specified in 15.209(a) (see Section 15.205(c)).

#### **TEST CONFIGURATION**

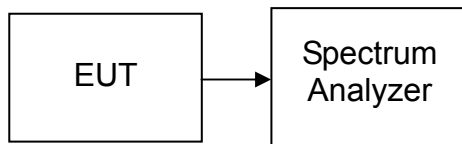

#### **TEST PROCEDURE**

Conducted RF measurements of the transmitter output were made to confirm that the EUT antenna port conducted emissions meet the specified limit and to identify any spurious signals that require further investigation or measurements on the radiated emissions site.

The transmitter output is connected to the spectrum analyzer. The resolution bandwidth is set to 100 kHz. The video bandwidth is set to 100 kHz.

Measurements are made over the 30MHz to 26GHz range with the transmitter set to the lowest, middle, and highest channels.

#### **TEST RESULTS**

*No non-compliance noted.*



Test Plot

Spurious Emissions

CH Low

Agilent

R L

Mkr1 2.41 GHz  
12.62 dBm

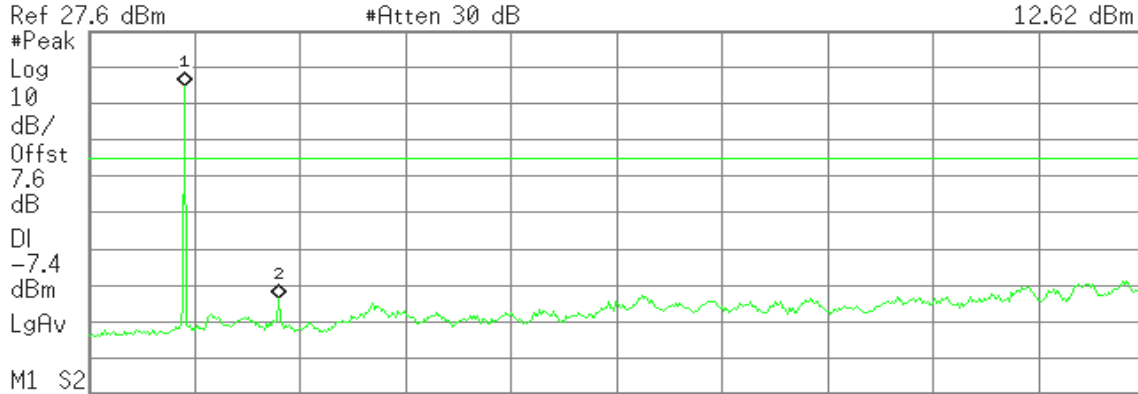

Start 30 MHz #Res BW 100 kHz #VBW 100 kHz Stop 26.50 GHz Sweep 3.192 s (601 pts)

Marker	Trace	Type	X Axis	Amplitude
1	(1)	Freq	2.41 GHz	12.62 dBm
2	(1)	Freq	4.79 GHz	-46.18 dBm

CH Mid

Agilent

R T

Mkr1 2.46 GHz  
13.63 dBm

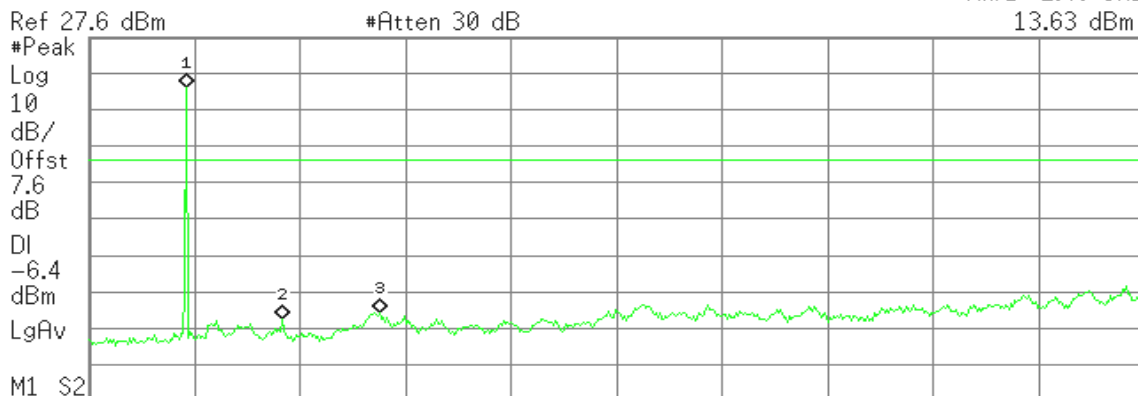

Start 30 MHz #Res BW 100 kHz #VBW 100 kHz Stop 26.50 GHz Sweep 3.192 s (601 pts)

Marker	Trace	Type	X Axis	Amplitude
1	(1)	Freq	2.46 GHz	13.63 dBm
2	(1)	Freq	4.88 GHz	-49.75 dBm
3	(1)	Freq	7.31 GHz	-48.29 dBm



### CH High

Agilent

R T

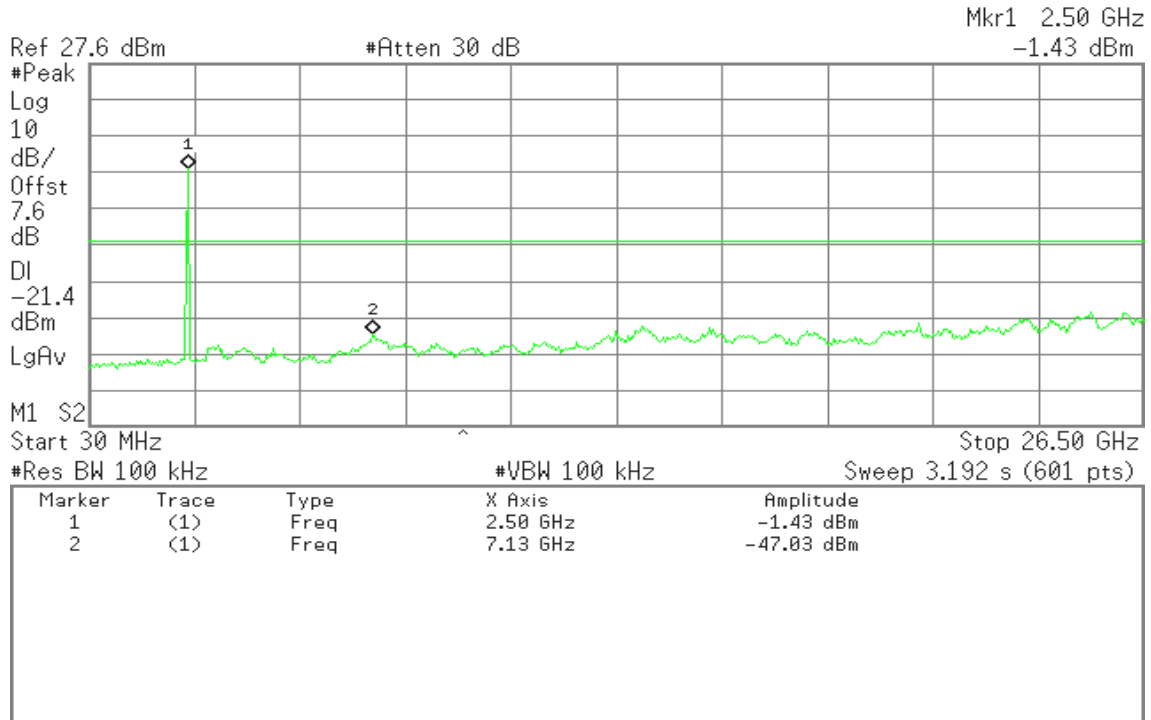



Conducted band-edge

CH Low

Agilent

R T

Mkr1 2.400 000 GHz  
-27.97 dBm

Ref 27.6 dBm

#Atten 30 dB

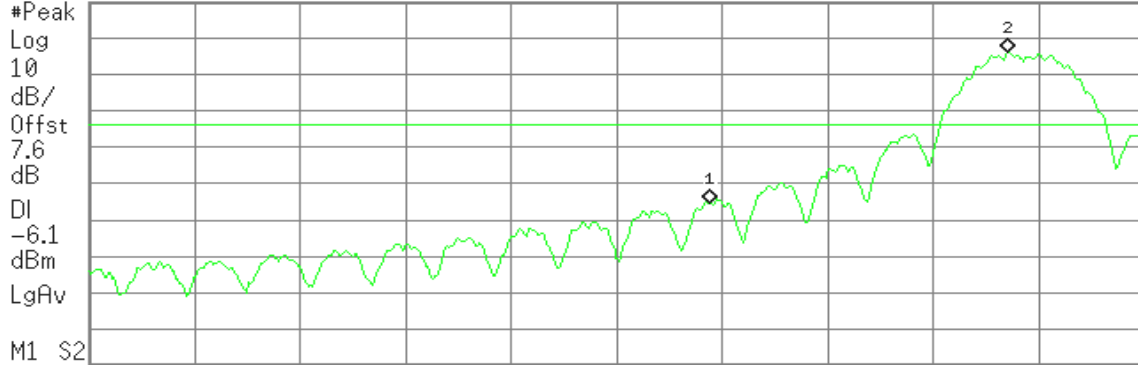

Start 2.390 000 GHz

Stop 2.407 000 GHz

#Res BW 100 kHz

#VBW 100 kHz

Sweep 2.08 ms (601 pts)

Marker	Trace	Type	X Axis	Amplitude
1	(1)	Freq	2.400 000 GHz	-27.97 dBm
2	(1)	Freq	2.404 798 GHz	13.86 dBm

CH High

Agilent

R T

Mkr1 2.479 80 GHz  
-0.47 dBm

Ref 27.6 dBm

#Atten 30 dB

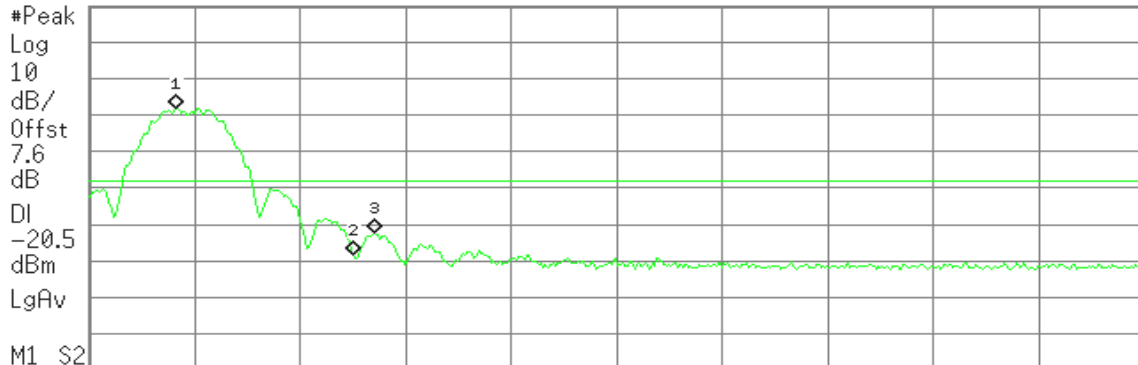

Start 2.478 00 GHz

Stop 2.500 00 GHz

#Res BW 100 kHz

#VBW 100 kHz

Sweep 2.68 ms (601 pts)

Marker	Trace	Type	X Axis	Amplitude
1	(1)	Freq	2.479 80 GHz	-0.47 dBm
2	(1)	Freq	2.483 50 GHz	-41.00 dBm
3	(1)	Freq	2.483 94 GHz	-34.85 dBm



## 7.6.2 RADIATED EMISSIONS

### LIMIT

1. According to §15.209(a), except as provided elsewhere in this Subpart, the emissions from an intentional radiator shall not exceed the field strength levels specified in the following table:

Frequency (MHz)	Field Strength ( $\mu\text{V/m}$ )	Measurement Distance (m)
30-88	100*	3
88-216	150*	3
216-960	200*	3
Above 960	500	3

**Remark:** Except as provided in paragraph (g), fundamental emissions from intentional radiators operating under this Section shall not be located in the frequency bands 54-72 MHz, 76-88 MHz, 174-216 MHz or 470-806 MHz. However, operation within these frequency bands is permitted under other sections of this Part, e.g., Sections 15.231 and 15.241.

2. In the emission table above, the tighter limit applies at the band edges.

Frequency (MHz)	Field Strength ( $\mu\text{V/m}$ at 3-meter)	Field Strength (dB $\mu\text{V/m}$ at 3-meter)
30-88	100	40
88-216	150	43.5
216-960	200	46
Above 960	500	54



## TEST CONFIGURATION

### Below 1 GHz

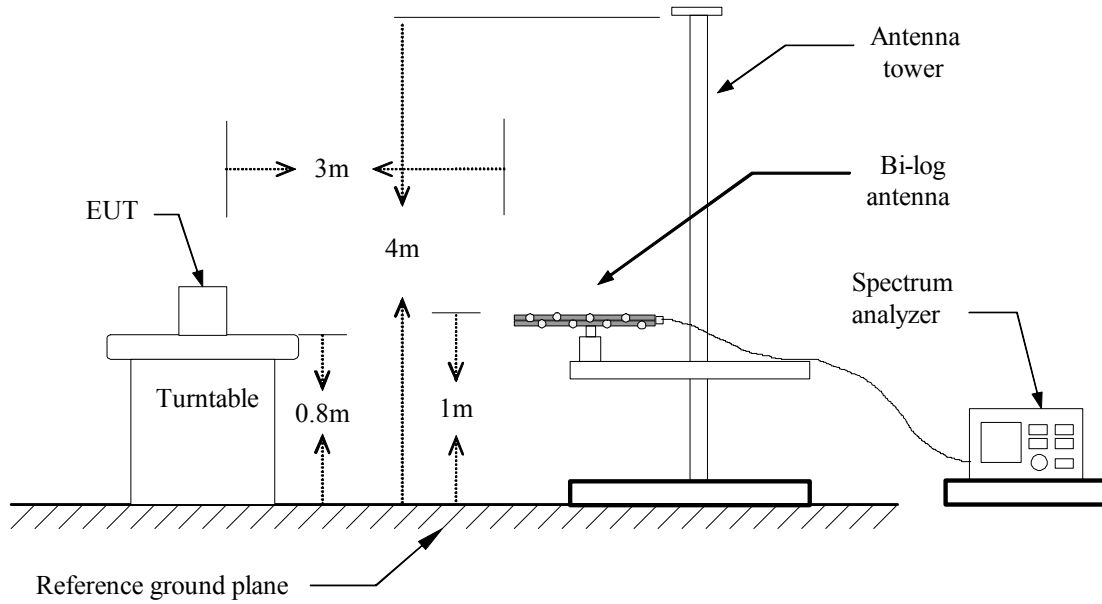

### Above 1 GHz

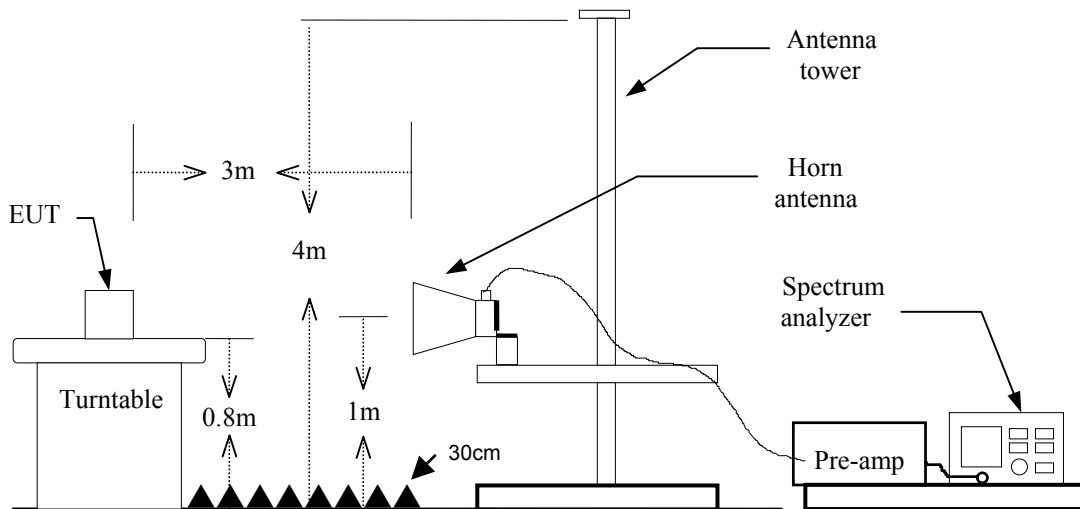



## **TEST PROCEDURE**

1. The EUT is placed on a turntable, which is 0.8m above ground plane.
2. The turntable shall be rotated for 360 degrees to determine the position of maximum emission level.
3. EUT is set 3m away from the receiving antenna, which is varied from 1m to 4m to find out the highest emissions.
4. Maximum procedure was performed on the six highest emissions to ensure EUT compliance.
5. And also, each emission was to be maximized by changing the polarization of receiving antenna both horizontal and vertical.
6. Set the spectrum analyzer in the following setting as:

### **Below 30MHz**

RBW=9kHz / VBW=30kHz / Sweep=AUTO

### **30 ~ 1000MHz (QP):**

RBW=VBW=120kHz / Sweep=AUTO

### **Above 1GHz:**

(a)PEAK: RBW=VBW=1MHz / Sweep=AUTO

(b)AVERAGE: RBW=1MHz / VBW=10Hz / Sweep=AUTO

7. Repeat above procedures until the measurements for all frequencies are complete.

## **TEST RESULTS**

*No non-compliance noted.*



**TEST DATA**

**Below 1GHz**

**Operation Mode:** Transmitting                      **Test Date:** March 7, 2013  
**Temperature:** 26°C                                      **Tested by:** Clark Su  
**Humidity:** 56% RH                                      **Polarity:** Ver. / Hor.

Frequency (MHz)	Reading (dBuV)	Correction Factor (dB/m)	Result (dBuV/m)	Limit (dBuV/m)	Margin (dB)	Ant. Pol. (H/V)	Remark
50.3700	43.87	-11.61	32.26	40.00	-7.74	V	QP
92.0800	30.12	1.61	31.73	43.50	-11.77	V	QP
134.7600	27.97	0.26	28.23	43.50	-15.27	V	QP
369.5000	27.20	-7.72	19.48	46.00	-26.52	V	QP
579.0200	27.63	-6.50	21.13	46.00	-24.87	V	QP
945.6800	27.84	-4.42	23.42	46.00	-22.58	V	QP
50.3700	35.00	1.53	36.53	40.00	-3.47	H	QP
134.7600	30.36	-2.10	28.26	43.50	-15.24	H	QP
159.0100	27.61	2.91	30.52	43.50	-12.98	H	QP
569.3200	27.86	-6.26	21.60	46.00	-24.40	H	QP
803.0900	28.34	-9.79	18.55	46.00	-27.45	H	QP
927.2500	28.87	-8.26	20.61	46.00	-25.39	H	QP

**Remark:**

1. No emission found between lowest internal used / generated frequency to 30 MHz. (9kHz ~ 30MHz)
2. Measuring frequencies from 9 kHz to the 1GHz.
3. Radiated emissions measured in the measured frequency range were made with an instrument using peak detector or quasi-peak detector mode.
4. Data of measurement within this frequency range shown " --- " in the table above means the reading of emissions are attenuated more than 20dB below the permissible limits or the field strength is too small to be measured.
5. The IF bandwidth of SPA between 30MHz to 1GHz was 100kHz.





**Above 1 GHz**

**Operation Mode:** TX / CH Low

**Test Date:** March 5, 2013

**Temperature:** 26°C

**Tested by:** Francis Lee

**Humidity:** 56 % RH

**Polarity:** Ver. / Hor.

Freq. (MHz)	Reading (dBuV)	Correct Factor (dB/m)	Result (dBuV/m)	Limit (dBuV/m)	Margin (dB)	Ant. Pol H/V	Remark
1618.000	54.37	-4.94	49.43	74.00	-24.57	V	peak
1966.000	53.41	-1.84	51.57	74.00	-22.43	V	peak
2690.000	53.31	-1.54	51.77	74.00	-22.23	V	peak
4810.000	42.37	2.35	44.72	74.00	-29.28	V	peak
5395.000	38.76	6.33	45.09	74.00	-28.91	V	peak
6335.000	39.33	6.83	46.16	74.00	-27.84	V	peak
1418.000	53.90	-7.28	46.62	74.00	-27.38	H	peak
2238.000	54.37	-4.62	49.75	74.00	-24.25	H	peak
2588.000	53.92	-3.41	50.51	74.00	-23.49	H	peak
4375.000	40.50	7.11	47.61	74.00	-26.39	H	peak
5540.000	38.94	9.00	47.94	74.00	-26.06	H	peak
5915.000	39.30	9.16	48.46	74.00	-25.54	H	peak

**Remark:**

1. Measuring frequencies from 1 GHz to the 10th harmonic of highest fundamental frequency.
2. Radiated emissions measured in frequency above 1000MHz were made with an instrument using peak/average detector mode.
3. Average test would be performed if the peak result were greater than the average limit or as required by the applicant.
4. Data of measurement within this frequency range shown " --- " in the table above means the reading of emissions are attenuated more than 20dB below the permissible limits or the field strength is too small to be measured.
5. Measurements above show only up to 6 maximum emissions noted, or would be lesser, with " N/A " remark, if no specific emissions from the EUT are recorded (ie: margin>20dB from the applicable limit) and considered that's already beyond the background noise floor.



**Operation Mode:** TX / CH Mid

**Test Date:** March 5, 2013

**Temperature:** 26°C

**Tested by:** Francis Lee

**Humidity:** 56 % RH

**Polarity:** Ver. / Hor.

Freq. (MHz)	Reading (dBuV)	Correct Factor (dB/m)	Result (dBuV/m)	Limit (dBuV/m)	Margin (dB)	Ant. Pol H/V	Remark
1520.000	53.84	-5.17	48.67	74.00	-25.33	V	peak
1982.000	53.14	-1.58	51.56	74.00	-22.44	V	peak
2220.000	53.22	-1.37	51.85	74.00	-22.15	V	peak
2712.000	53.23	-1.55	51.68	74.00	-22.32	V	peak
3800.000	40.69	3.69	44.38	74.00	-29.62	V	peak
4890.000	43.05	4.15	47.20	74.00	-26.80	V	peak
6405.000	39.56	6.60	46.16	74.00	-27.84	V	peak
1404.000	53.34	-6.98	46.36	74.00	-27.64	H	peak
1500.000	54.41	-9.00	45.41	74.00	-28.59	H	peak
2128.000	53.75	-3.72	50.03	74.00	-23.97	H	peak
2634.000	53.20	-3.36	49.84	74.00	-24.16	H	peak
4330.000	39.78	7.44	47.22	74.00	-26.78	H	peak
4890.000	39.89	6.98	46.87	74.00	-27.13	H	peak
5505.000	38.61	8.88	47.49	74.00	-26.51	H	peak

**Remark:**

1. Measuring frequencies from 1 GHz to the 10th harmonic of highest fundamental frequency.
2. Radiated emissions measured in frequency above 1000MHz were made with an instrument using peak/average detector mode.
3. Average test would be performed if the peak result were greater than the average limit or as required by the applicant.
4. Data of measurement within this frequency range shown " --- " in the table above means the reading of emissions are attenuated more than 20dB below the permissible limits or the field strength is too small to be measured.
5. Measurements above show only up to 6 maximum emissions noted, or would be lesser, with " N/A " remark, if no specific emissions from the EUT are recorded (ie: margin>20dB from the applicable limit) and considered that's already beyond the background noise floor.



**Operation Mode:** TX / CH High

**Test Date:** March 5, 2013

**Temperature:** 26°C

**Tested by:** Francis Lee

**Humidity:** 56 % RH

**Polarity:** Ver. / Hor.

Freq. (MHz)	Reading (dBuV)	Correct Factor (dB/m)	Result (dBuV/m)	Limit (dBuV/m)	Margin (dB)	Ant. Pol H/V	Remark
1926.000	52.92	-2.47	50.45	74.00	-23.55	V	peak
2256.000	53.45	-1.45	52.00	74.00	-22.00	V	peak
2668.000	53.06	-1.69	51.37	74.00	-22.63	V	peak
3980.000	40.56	3.08	43.64	74.00	-30.36	V	peak
4960.000	42.03	4.94	46.97	74.00	-27.03	V	peak
5515.000	39.02	6.18	45.20	74.00	-28.80	V	peak
1400.000	53.02	-6.90	46.12	74.00	-27.88	H	peak
1880.000	53.60	-6.00	47.60	74.00	-26.40	H	peak
2200.000	52.87	-3.56	49.31	74.00	-24.69	H	peak
4305.000	40.48	7.62	48.10	74.00	-25.90	H	peak
4960.000	40.44	7.41	47.85	74.00	-26.15	H	peak
6085.000	39.95	8.70	48.65	74.00	-25.35	H	peak

**Remark:**

1. Measuring frequencies from 1 GHz to the 10th harmonic of highest fundamental frequency.
2. Radiated emissions measured in frequency above 1000MHz were made with an instrument using peak/average detector mode.
3. Average test would be performed if the peak result were greater than the average limit or as required by the applicant.
4. Data of measurement within this frequency range shown " --- " in the table above means the reading of emissions are attenuated more than 20dB below the permissible limits or the field strength is too small to be measured.
5. Measurements above show only up to 6 maximum emissions noted, or would be lesser, with " N/A " remark, if no specific emissions from the EUT are recorded (ie: margin>20dB from the applicable limit) and considered that's already beyond the background noise floor.



## 7.7 POWERLINE CONDUCTED EMISSIONS

### LIMIT

According to §15.207(a), except as shown in paragraphs (b) and (c) of this section, for an intentional radiator that is designed to be connected to the public utility (AC) power line, the radio frequency voltage that is conducted back onto the AC power line on any frequency or frequencies within the band 150 kHz to 30 MHz shall not exceed the limits in the following table, as measured using a 50 µH/50 ohms line impedance stabilization network (LISN). Compliance with the provisions of this paragraph shall be based on the measurement of the radio frequency voltage between each power line and ground at the power terminal. The lower limit applies at the boundary between the frequency ranges.

Frequency Range (MHz)	Limits (dBµV)	
	Quasi-peak	Average
0.15 to 0.50	66 to 56*	56 to 46*
0.50 to 5	56	46
5 to 30	60	50

\* Decreases with the logarithm of the frequency.

### TEST CONFIGURATION

See test photographs attached in Appendix II for the actual connections between EUT and support equipment.

### TEST PROCEDURE

1. The EUT was placed on a table, which is 0.8m above ground plane.
2. Maximum procedure was performed on the six highest emissions to ensure EUT compliance.
3. Repeat above procedures until all frequency measured were complete.

### TEST RESULTS

The initial step in collecting conducted data is a spectrum analyzer peak scan of the measurement range. Significant peaks are then marked as shown on the following data page, and these signals are then quasi-peaked.

### TEST DATA

**Not applicable (Since the EUT is powered by battery)**