

FCC ID: P27SZKPD04N  
 Report No.: T180727D04-RP

Page: 1 / 40  
 Rev.: 01

# RADIO TEST REPORT

## FCC 47 CFR PART 15 SUBPART C

<b>Test Standard</b>	<b>FCC Part 15.247</b>
<b>Product name</b>	<b>Zigbee Keypad</b>
<b>Brand Name</b>	<b>Sercomm; Stanley Security; Scout Alarm</b>
<b>Model</b>	<b>SZ-KPD04; SZ-KPD04Nxxxxxxxx (the 1st x should be "blank" or "-"; the rest x could be 0 to 9, A to Z, a to z, "blank" or "-"; for marking purpose)</b>
<b>Test Result</b>	<b>Pass</b>

The test Result was tested by Compliance Certification Services Inc. The test data, data evaluation, test procedures, and equipment configurations shown in this report were given in ANSI C63.10: 2013 and compliance standards.

The test results of this report relate only to the tested sample (EUT) identified in this report.

The test Report of full or partial shall not copy. Without written approval of Compliance Certification Services Inc.(Wugu Laboratory)

*Approved by:*

*Tested by:*

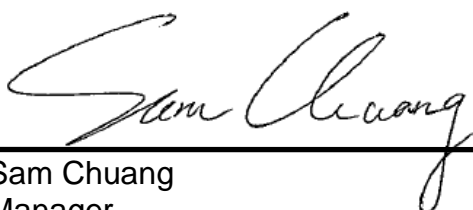

---

Sam Chuang  
 Manager



---

Jerry Chuang  
 Engineer

Unless otherwise stated the results shown in this test report refer only to the sample(s) tested and such sample(s) are retained for 90 days only.  
 除非另有說明，此報告結果僅對測試之樣品負責，同時此樣品僅保留90天。本報告未經本公司書面許可，不可部分複製。

This document is issued by the Company subject to its General Conditions of Service printed overleaf, available on request or accessible at [www.sgs.com/terms\\_and\\_conditions.htm](http://www.sgs.com/terms_and_conditions.htm) and for electronic format documents, subject to Terms and Conditions for Electronic Documents at [www.sgs.com/terms\\_e-document.htm](http://www.sgs.com/terms_e-document.htm). Attention is drawn to the limitation of liability, indemnification and jurisdiction issues defined therein. Any holder of this document is advised that information contained hereon reflects the Company's findings at the time of its intervention only and within the limits of Client's instructions, if any. The Company's sole responsibility is to its Client and this document does not exonerate parties to a transaction from exercising all their rights and obligations under the transaction documents. This document cannot be reproduced except in full, without prior written approval of the Company. Any unauthorized alteration, forgery or falsification of the content or appearance of this document is unlawful and offenders may be prosecuted to the fullest extent of the law.



Report No.: T180727D04-RP

Page: 2 / 40  
Rev.: 01

## Revision History

Rev.	Issue Date	Revisions	Revised By
00	September 25, 2018	Initial Issue	May Lin
01	October 15, 2018	1. Revised the test result in P.18.	May Lin

## Table of contents

<b>1.</b>	<b>GENERAL INFORMATION .....</b>	<b>4</b>
1.1	<b>EUT INFORMATION .....</b>	4
1.2	<b>EUT CHANNEL INFORMATION .....</b>	5
1.3	<b>ANTENNA INFORMATION .....</b>	5
1.4	<b>MEASUREMENT UNCERTAINTY .....</b>	6
1.5	<b>FACILITIES AND TEST LOCATION .....</b>	7
1.6	<b>INSTRUMENT CALIBRATION .....</b>	7
1.7	<b>SUPPORT AND EUT ACCESSORIES EQUIPMENT .....</b>	8
1.9	<b>TABLE OF ACCREDITATIONS AND LISTINGS .....</b>	8
<b>2.</b>	<b>TEST SUMMERY .....</b>	<b>9</b>
<b>3.</b>	<b>DESCRIPTION OF TEST MODES.....</b>	<b>10</b>
3.1	<b>THE WORST MODE OF OPERATING CONDITION .....</b>	10
3.2	<b>THE WORST MODE OF MEASUREMENT .....</b>	11
3.3	<b>EUT DUTY CYCLE.....</b>	12
<b>4.</b>	<b>TEST RESULT .....</b>	<b>13</b>
4.1	<b>AC POWER LINE CONDUCTED EMISSION .....</b>	13
4.2	<b>6dB BANDWIDTH AND OCCUPIED BANDWIDTH(99%).....</b>	14
4.3	<b>OUTPUT POWER MEASUREMENT .....</b>	17
4.4	<b>POWER SPECTRAL DENSITY .....</b>	19
4.5	<b>CONDUCTED BANDEGE AND SPURIOUS EMISSION.....</b>	21
4.6	<b>RADIATION BANDEGE AND SPURIOUS EMISSION .....</b>	25
 <b>APPENDIX 1 - PHOTOGRAPHS OF EUT</b>		

## 1. GENERAL INFORMATION

### 1.1 EUT INFORMATION

Applicant	Sercomm Corporation 8F, No. 3-1, YuanQu St., NanKang, Taipei 115, Taiwan, R.O.C.
Manufacturer	Sercomm Corporation 8F, No. 3-1, YuanQu St., NanKang, Taipei 115, Taiwan, R.O.C.
Equipment	Zigbee Keypad
Model No.	SZ-KPD04; SZ-KPD04Nxxxxxxxx (the 1st x should be "blank" or "-"; the rest x could be 0 to 9, A to Z, a to z, "blank" or "-", for marking purpose)
Model Discrepancy	The suffix of "x" (the 1st x should be "blank" or "-"; the rest x could be 0 to 9, A to Z, a to z, "blank" or "-", for marking purpose)
Trade Name	Sercomm; Stanley Security; Scout Alarm
Received Date	July 27, 2018
Date of Test	August 6 ~ September 5, 2018
Output Power(W)	Zigbee: 0.0071
Power Operation	Power from Battery (DC 3V)

## 1.2 EUT CHANNEL INFORMATION

Frequency Range	Zigbee: 2405~2480MHz
Modulation Type	Zigbee: OQPSK (Offset Quadrature Phase Shift Keyed)
Number of channels	Zigbee: 14 Channels

**Remark:**

Refer as ANSI 63.10:2013 clause 5.6.1 Table 4 for test channels

Number of frequencies to be tested		
Frequency range in which device operates	Number of frequencies	Location in frequency range of operation
<input type="checkbox"/> 1 MHz or less	1	Middle
<input type="checkbox"/> 1 MHz to 10 MHz	2	1 near top and 1 near bottom
<input checked="" type="checkbox"/> More than 10 MHz	3	1 near top, 1 near middle, and 1 near bottom

## 1.3 ANTENNA INFORMATION

Antenna Type	<input checked="" type="checkbox"/> PIFA <input type="checkbox"/> PCB <input type="checkbox"/> Dipole <input type="checkbox"/> Coils
Antenna Gain	1 dBi

## 1.4 MEASUREMENT UNCERTAINTY

PARAMETER	UNCERTAINTY
AC Powerline Conducted Emission	+/- 1.2575
Emission bandwidth, 20dB bandwidth	+/- 1.4003
RF output power, conducted	+/- 1.1372
Power density, conducted	+/- 1.4003
3M Semi Anechoic Chamber / 30M~200M	+/- 4.0138
3M Semi Anechoic Chamber / 200M~1000M	+/- 3.9483
3M Semi Anechoic Chamber / 1G~8G	+/- 2.5975
3M Semi Anechoic Chamber / 8G~18G	+/- 2.6112
3M Semi Anechoic Chamber / 18G~26G	+/- 2.7389
3M Semi Anechoic Chamber / 26G~40G	+/- 2.9683

**Remark:**

1. This uncertainty represents an expanded uncertainty expressed at approximately the 95% confidence level using a coverage factor of  $k=2$
2. ISO/IEC 17025 requires that an estimate of the measurement uncertainties associated with the emissions test results be included in the report.

## 1.5 FACILITIES AND TEST LOCATION

All measurement facilities used to collect the measurement data are located at  
No.11, Wugong 6th Rd., Wugu Dist., New Taipei City 24891, Taiwan. (R.O.C.)

Test site	Test Engineer	Remark
AC Conduction Room	N/A	Not applicable, because EUT not connect to AC Main Source direct.
Radiation	Jerry Chuang	-
RF Conducted	Jerry Chuang	-

**Remark:** The sites are constructed in conformance with the requirements of ANSI C63.7, ANSI C63.4 and CISPR Publication 22.

## 1.6 INSTRUMENT CALIBRATION

RF Conducted Test Site					
Name of Equipment	Manufacturer	Model	Serial Number	Calibration Date	Calibration Due
Cable	HUBER SUHNER	SUCOFLEX 104PEA	25157	06/29/2018	06/28/2019
Power Meter	Anritsu	ML2495A	1149001	09/18/2017	09/17/2018
Power Sensor	Anritsu	MA2411B	30982	02/07/2018	02/05/2019
Signal Analyzer	R&S	FSV 40	101073	10/02/2017	10/01/2018

Wugu 966 Chamber A					
Name of Equipment	Manufacturer	Model	Serial Number	Calibration Date	Calibration Due
Band Reject Filters	MICRO TRONICS	BRM 50702	120	05/14/2018	05/13/2019
Bilog Antenna	Sunol Sciences	JB3	A030105	07/13/2018	07/12/2019
Cable	HUBER SUHNER	SUCOFLEX 104PEA	25157	06/29/2018	06/28/2019
Cable	HUBER SUHNER	SUCOFLEX 104PEA	20995	06/29/2018	06/28/2019
Digital Thermo-Hygro Meter	WISEWIND	1206	D07	02/08/2018	02/07/2019
Horn Antenna	SCHWARZBECK	BBHA 9120D	779	03/14/2018	03/13/2019
Loop Ant	COM-POWER	AL-130	121051	03/21/2018	03/20/2019
Pre-Amplifier	EMEC	EM330	060609	06/29/2018	06/28/2019
Pre-Amplifier	HP	8449B	3008A00965	06/29/2018	06/28/2019
PSA Series Spectrum Analyzer	Agilent	E4446A	MY46180323	05/31/2018	05/30/2019
Antenna Tower	CCS	CC-A-1F	N/A	N.C.R	N.C.R
Controller	CCS	CC-C-1F	N/A	N.C.R	N.C.R
Turn Table	CCS	CC-T-1F	N/A	N.C.R	N.C.R
Software	EZ-EMC (CCS-3A1RE)				

**Remark:** Each piece of equipment is scheduled for calibration once a year.



Report No.: T180727D04-RP

Page: 8 / 40  
Rev.: 01

## 1.7 SUPPORT AND EUT ACCESSORIES EQUIPMENT

EUT Accessories Equipment					
No.	Equipment	Brand	Model	Series No.	FCC ID
	N/A				

Support Equipment					
No.	Equipment	Brand	Model	Series No.	FCC ID
1	NB(J)	Toshiba	PORTEGE R30-A	N/A	PD97260H

## 1.8 TEST METHODOLOGY AND APPLIED STANDARDS

The test methodology, setups and results comply with all requirements in accordance with ANSI C63.10:2013, FCC Part 2, FCC Part 15.247, KDB 558074 D01.



## 2. TEST SUMMERY

FCC Standard Section	Chapter	Test Item	Result
15.203	1.3	Antenna Requirement	Pass
15.207 (a)	4.1	AC Conducted Emission	N/A
15.247(a)(2)	4.2	6 dB Bandwidth	Pass
-	4.2	Occupied Bandwidth (99%)	Pass
15.247(b) (3)	4.3	Output Power Measurement	Pass
15.247(e)	4.4	Power Spectral Density	Pass
15.247(d)	4.5	Conducted Band Edge	Pass
15.247(d)	4.5	Conducted Spurious Emission	Pass
15.247(d)	4.6	Radiation Band Edge	Pass
15.247(d)	4.6	Radiation Spurious Emission	Pass



Report No.: T180727D04-RP

Page: 10 / 40  
Rev.: 01

### 3. DESCRIPTION OF TEST MODES

#### 3.1 THE WORST MODE OF OPERATING CONDITION

Operation mode	Zigbee
Test Channel Frequencies	<b>Zigbee:</b> 1. Lowest Channel : 2405MHz 2. Middle Channel : 2440MHz 3. Highest Channel : 2480MHz

**Remark:**

1. EUT pre-scanned data rate of output power for each mode, the worst data rate were recorded in this report.

### 3.2 THE WORST MODE OF MEASUREMENT

Radiated Emission Measurement Below 1G	
Test Condition	Radiated Emission Below 1G
Power supply Mode	Mode 1: EUT Power by battery (DC 3V)
Worst Mode	<input checked="" type="checkbox"/> Mode 1 <input type="checkbox"/> Mode 2 <input type="checkbox"/> Mode 3 <input type="checkbox"/> Mode 4

Radiated Emission Measurement Above 1G	
Test Condition	Band edge, Emission for Unwanted and Fundamental
Power supply Mode	Mode 1: EUT Power by battery (DC 3V)
Worst Mode	<input checked="" type="checkbox"/> Mode 1 <input type="checkbox"/> Mode 2 <input type="checkbox"/> Mode 3 <input type="checkbox"/> Mode 4
Worst Position	<input type="checkbox"/> Placed in fixed position. <input checked="" type="checkbox"/> Placed in fixed position at X-Plane (E2-Plane) <input type="checkbox"/> Placed in fixed position at Y-Plane (E1-Plane) <input type="checkbox"/> Placed in fixed position at Z-Plane (H-Plane)
Worst Polarity	<input checked="" type="checkbox"/> Horizontal <input type="checkbox"/> Vertical

*Remark:*

- 1. The worst mode was record in this test report.*
- 2. EUT pre-scanned in three axis, X, Y, Z and two polarity, Horizontal and Vertical for radiated measurement. The worst case (X-Plane and Horizontal) were recorded in this report.*

### 3.3 EUT DUTY CYCLE

Duty Cycle			
Configuration	TX ON (ms)	TX ALL (ms)	Duty Cycle (%)
Zigbee	1.0000	1.0000	100.00%

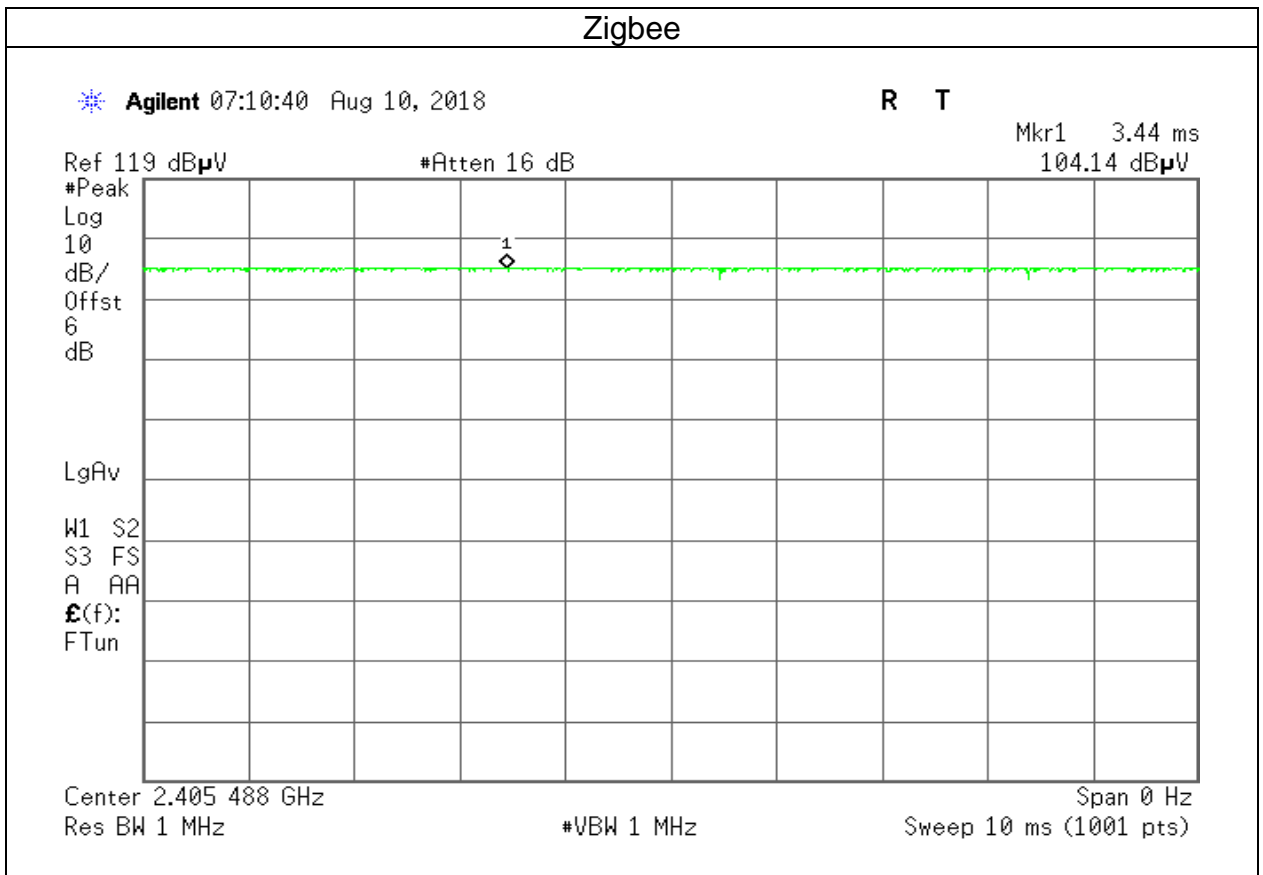

## 4. TEST RESULT

### 4.1 AC POWER LINE CONDUCTED EMISSION

#### 4.1.1 Test Limit

According to §15.207 (2),

Frequency Range (MHz)	Limits(dBµV)	
	Quasi-peak	Average
0.15 to 0.50	66 to 56*	56 to 46*
0.50 to 5	56	46
5 to 30	60	50

\* Decreases with the logarithm of the frequency.

#### 4.1.2 Test Procedure

Test method Refer as ANSI 63.10:2013 clause 6.2,

1. The EUT was placed on a non-conducted table, which is 0.8m above horizontal ground plane and 0.4m above vertical ground plane.
2. EUT connected to the line impedance stabilization network (LISN)
3. Receiver set RBW of 9kHz and Detector Peak, and note as quasi-peak and average.
4. Maximum procedure was performed on the six highest emissions to ensure EUT compliance.
5. Recorded Line for Neutral and Line.

#### 4.1.3 Test Setup

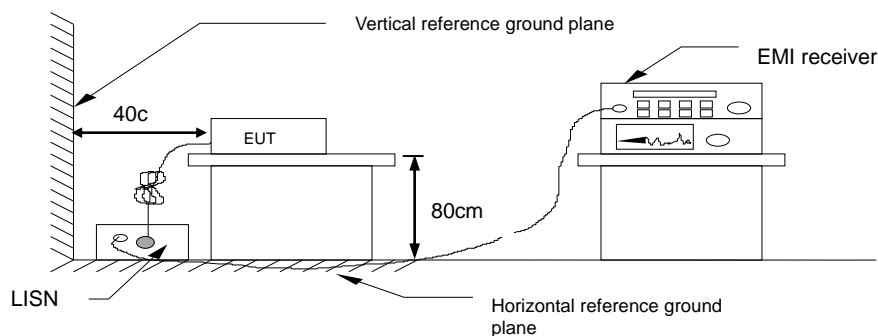

#### 4.1.4 Test Result

***Not applicable, because EUT not connect to AC Main Source direct.***

## 4.2 6dB BANDWIDTH AND OCCUPIED BANDWIDTH (99%)

### 4.2.1 Test Limit

According to §15.247(a)(2)

#### 6 dB Bandwidth :

Limit	Shall be at least 500kHz
-------	--------------------------

Occupied Bandwidth(99%) : For reporting purposes only.

### 4.2.2 Test Procedure

Test method Refer as KDB 558074 D01, Section 8.1 and ANSI 63.10:2013 clause 11.8.1

1. The EUT RF output connected to the spectrum analyzer by RF cable.
2. Setting maximum power transmit of EUT
3. SA set RBW = 100kHz, VBW = 300kHz and Detector = Peak, to measurement 6 dB Bandwidth.
4. SA set RBW = 1% ~ 5% OBW, VBW = three times the RBW and Detector = Peak, to measurement 99% Bandwidth
5. Measure and record the result of 6 dB Bandwidth and 99% Bandwidth in the test report.

### 4.2.3 Test Setup

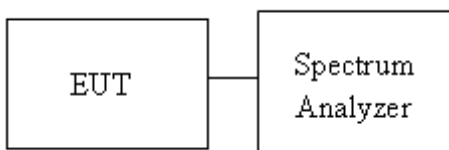

### 4.2.4 Test Result

Test mode: Zigbee / 2405-2480 MHz				
Channel	Frequency (MHz)	OBW (99%) (MHz)	6dB BW (MHz)	6dB limit (kHz)
Low	2405	2.2141	1.679	≥500
Mid	2440	2.2431	1.722	
High	2480	2.2286	1.823	

Report No.: T180727D04-RP

## Test Data 6dB BANDWIDTH

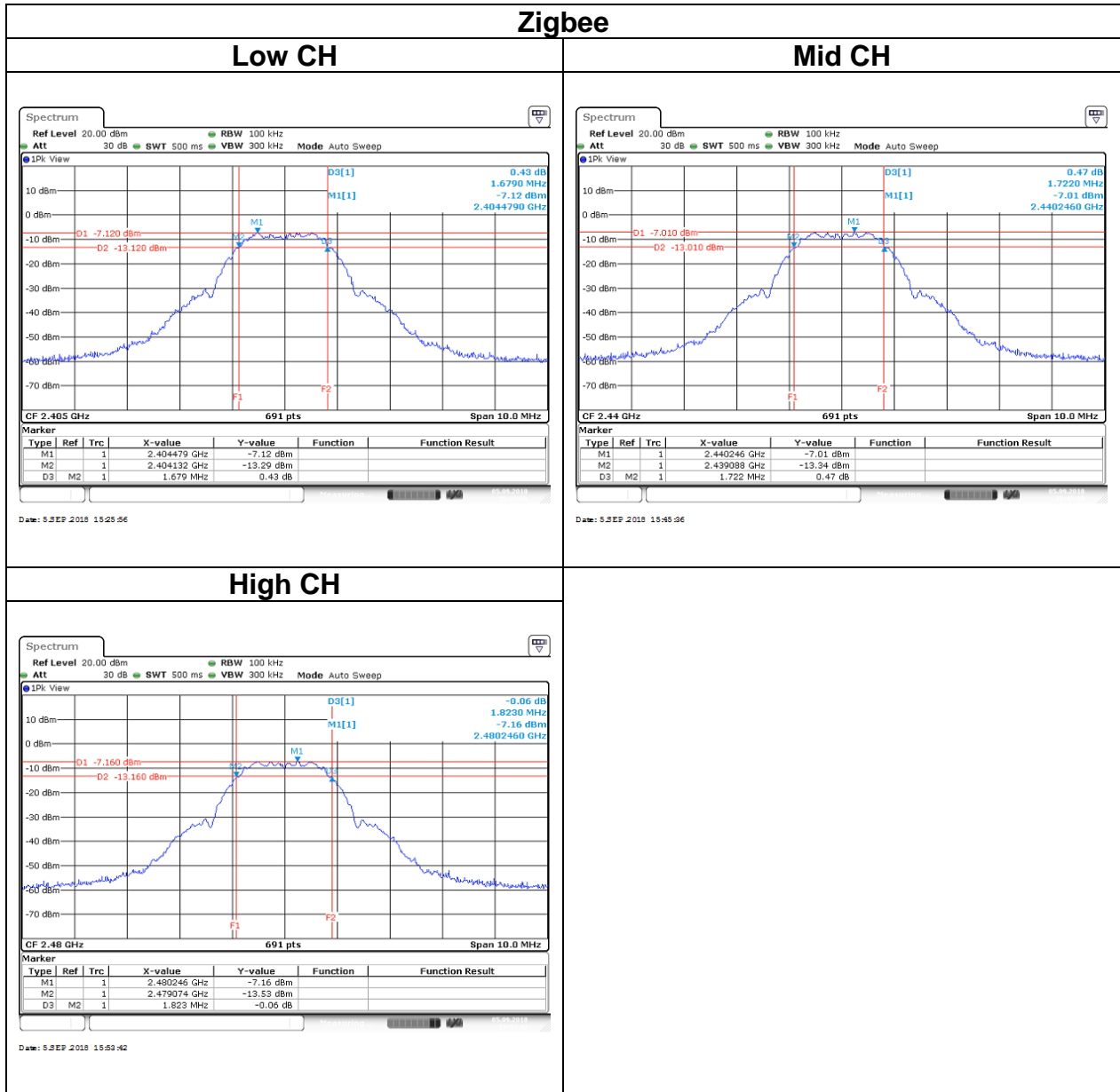

Report No.: T180727D04-RP

## Test Data BANDWIDTH (99%)

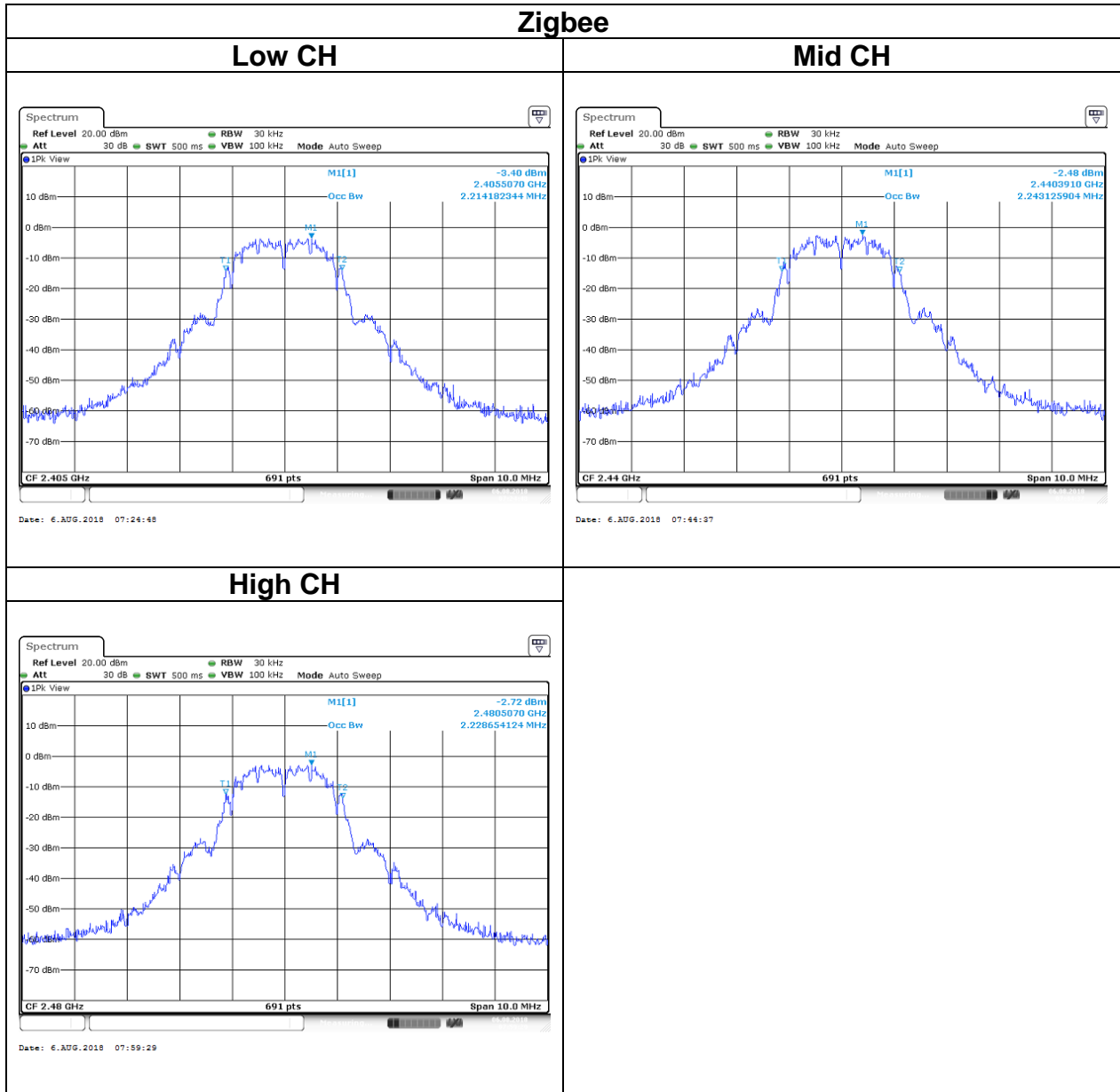



## 4.3 OUTPUT POWER MEASUREMENT

### 4.3.1 Test Limit

According to §15.247(b),

#### Peak output power :

For systems using digital modulation in the 2400-2483.5 MHz, and 5725-5850 MHz bands: 1 Watt(30 dBm), base on the use of antennas with directional gain not exceed 6 dBi If transmitting antennas of directional gain greater than 6dBi are used the peak output power the conducted output power from the intentional radiator shall be reduced by the amount in dB that the directional gain of the antenna exceeds 6 dBi. In case of point-to-point operation, the limit has to be reduced by 1dB for every 3 dB that the directional gain of the antenna exceeds 6 dBi.

Limit	<input checked="" type="checkbox"/> Antenna not exceed 6 dBi : 30dBm <input type="checkbox"/> Antenna with DG greater than 6 dBi : [Limit = 30 – (DG – 6)] <input type="checkbox"/> Point-to-point operation :
-------	---

Average output power : For reporting purposes only.

### 4.3.2 Test Procedure

Test method Refer as KDB 558074 D01, Section 9.1.2.

1. The EUT RF output connected to the power meter by RF cable.
2. Setting maximum power transmit of EUT.
3. The path loss was compensated to the results for each measurement.
4. Measure and record the result of Peak output power and Average output power in the test report.

### 4.3.3 Test Setup

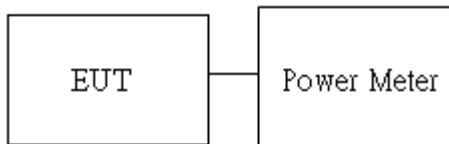

### 4.3.4 Test Result

**Peak output power :**

Zigbee					
Config.	Freq. (MHz)	Power Setting	PK Power (dBm)	PK Power (W)	Limit (dBm)
Zigbee	2405	10	8.45	0.0070	30
	2440	10	8.49	0.0071	
	2480	10	8.25	0.0067	

**Average output power :**

Zigbee		
Config.	Freq. (MHz)	AV Power (dBm)
Zigbee	2405	8.26
	2440	8.19
	2480	8.03

## 4.4 POWER SPECTRAL DENSITY

### 4.4.1 Test Limit

According to §15.247(e),

For digitally modulated systems, the power spectral density conducted from the intentional radiator to the antenna shall not be greater than 8 dBm in any 3 kHz band during any time interval of continuous transmission.

Limit	<input checked="" type="checkbox"/> Antenna not exceed 6 dBi : 8dBm <input type="checkbox"/> Antenna with DG greater than 6 dBi [ Limit = 8 – (DG – 6)] <input type="checkbox"/> Point-to-point operation :
-------	--

### 4.4.2 Test Procedure

Test method Refer as KDB 558074 D01, Section 10.2

1. The EUT RF output connected to the spectrum analyzer by RF cable.
2. Setting maximum power transmit of EUT
3. SA set RBW = 3kHz, VBW = 30kHz, Span = 1.5 times DTS Bandwidth (6 dB BW), Detector = Peak, Sweep Time = Auto and Trace = Max hold.
4. The path loss and Duty Factor were compensated to the results for each measurement by SA.
5. Mark the maximum level.
6. Measure and record the result of power spectral density. in the test report.

### 4.4.3 Test Setup

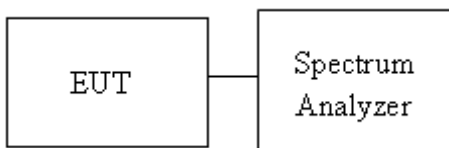

### 4.4.4 Test Result

Test mode: Zigbee / 2405-2480 MHz			
Channel	Frequency (MHz)	PPSD (dBm)	Limit (dBm)
Low	2405	-7.56	8
Mid	2440	-7.64	
High	2480	-7.79	

Report No.: T180727D04-RP

## Test Data

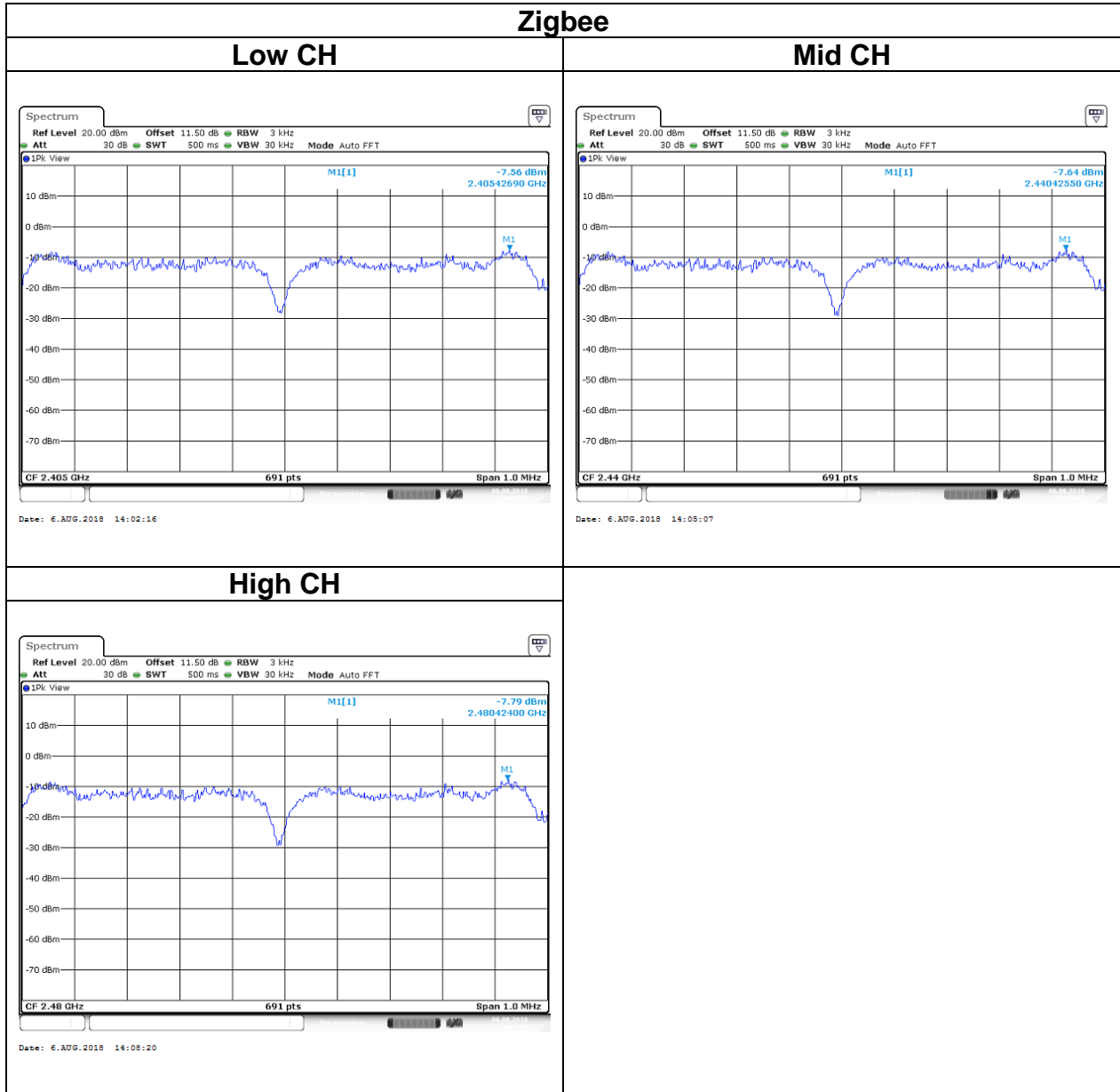

## 4.5 CONDUCTED BANDEDGE AND SPURIOUS EMISSION

### 4.5.1 Test Limit

According to §15.247(d),

In any 100 kHz bandwidth outside the authorized frequency band,

Non-restricted bands shall be attenuated at least 20 dB/30 dB relative to the maximum PSD level in 100 kHz by RF conducted or a radiated measurement which fall in the restricted bands, as defined in §15.205(a), must also comply with the radiated emission limits specified in §15.209(a).

### 4.5.2 Test Procedure

Test method Refer as KDB 558074 D01, Section 11.

1. EUT RF output port connected to the SA by RF cable, and the path loss was compensated to result.
2. SA setting, RBW=100kHz, VBW=300kHz, Detector=Peak, Trace mode = max hold, SWT = Auto.
3. In any 100 kHz bandwidth outside the authorized frequency band, shall be attenuated at least 20 dB relative to the maximum in-band peak PSD level in 100 kHz when conducted power procedure is used. If the transmitter complies with the conducted power limits based on the use of RMS averaging over a time interval, the attenuation required under this paragraph shall be 30 dB instead of 20 dB.

### 4.5.3 Test Setup

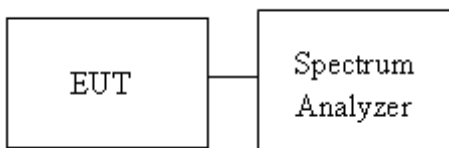

Report No.: T180727D04-RP

### 4.5.4 Test Result

#### Test Data

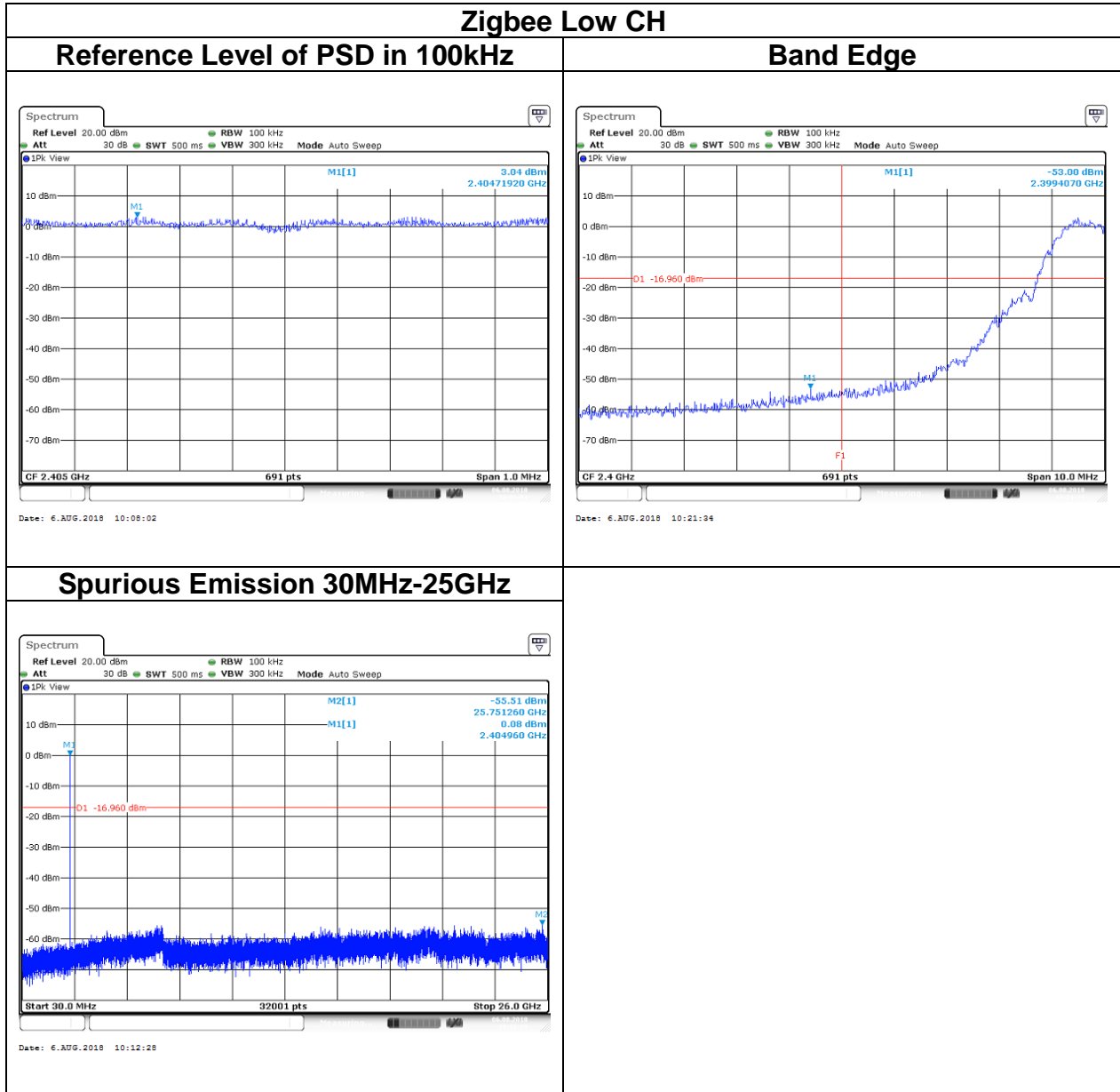

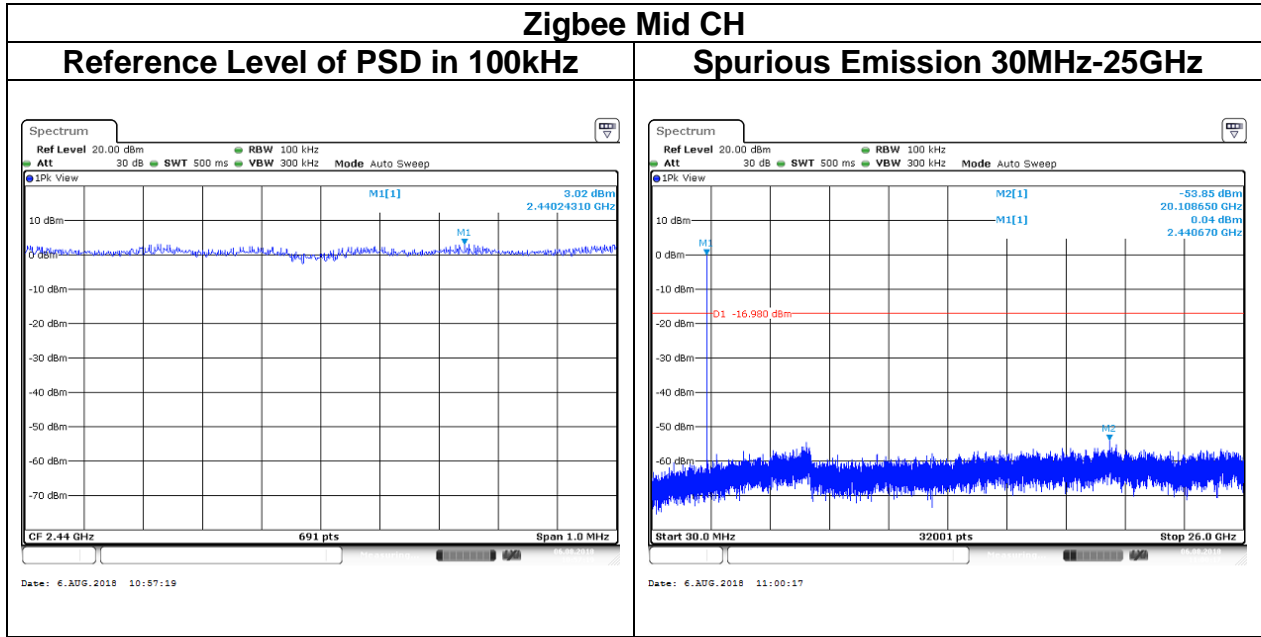

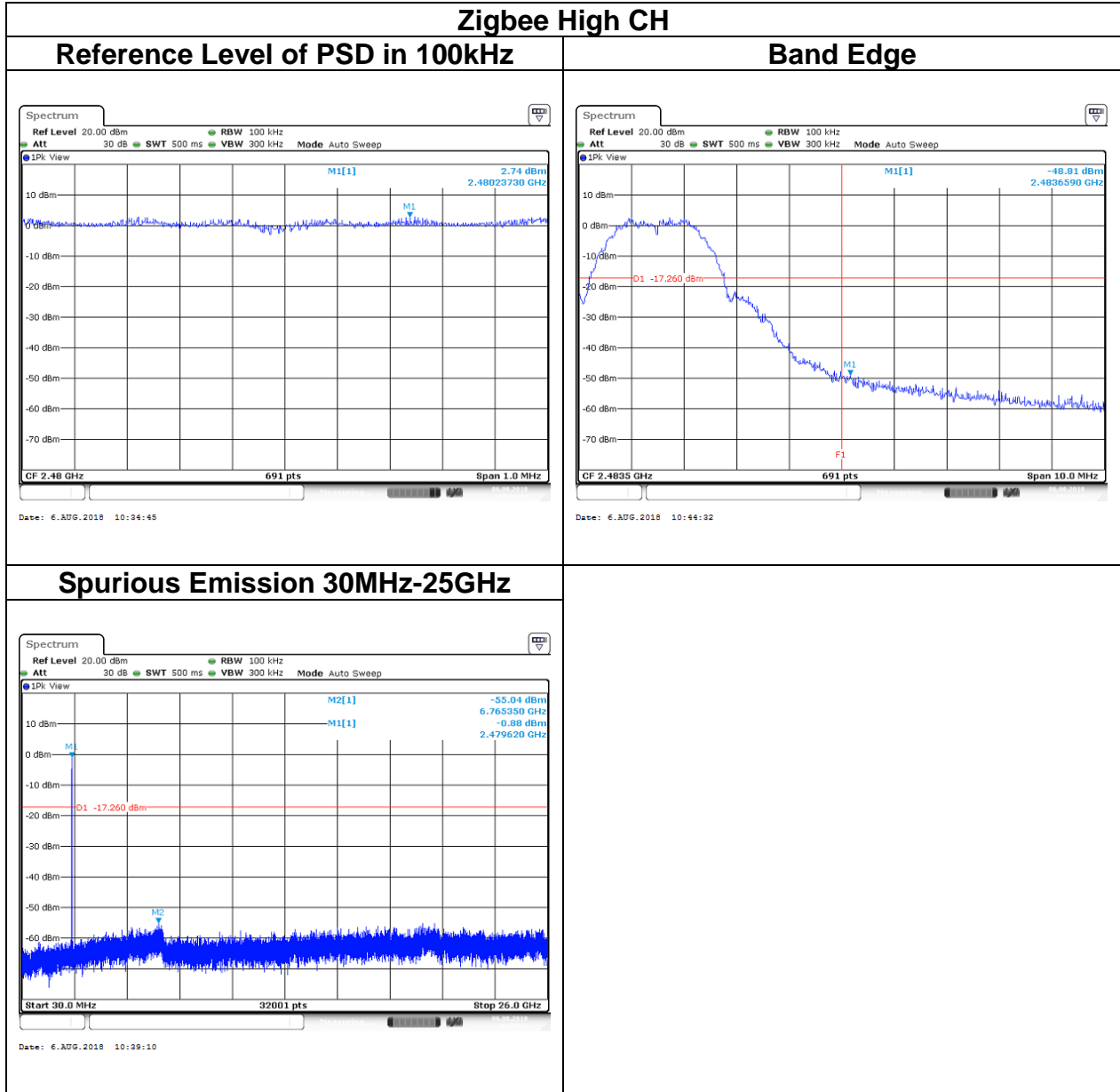



## 4.6 RADIATION BANDEDGE AND SPURIOUS EMISSION

### 4.6.1 Test Limit

FCC according to §15.247(d), §15.209 and §15.205

In any 100 kHz bandwidth outside the authorized frequency band, all harmonic and spurious must be least 20 dB below the highest emission level with the authorized frequency band. Radiation emission which fall in the restricted bands must also follow the FCC section 15.209 as below limit in table.

#### Below 30 MHz

Frequency	Field Strength (microvolts/m)	Magnetic H-Field (microamperes/m)	Measurement Distance (metres)
9-490 kHz	2,400/F (F in kHz)	2,400/F (F in kHz)	300
490-1,705 kHz	24,000/F (F in kHz)	24,000/F (F in kHz)	30
1.705-30 MHz	30	N/A	30

#### Above 30 MHz

Frequency (MHz)	Field Strength microvolts/m at 3 metres (watts, e.i.r.p.)	
	Transmitters	Receivers
30-88	100 (3 nW)	100 (3 nW)
88-216	150 (6.8 nW)	150 (6.8 nW)
216-960	200 (12 nW)	200 (12 nW)
Above 960	500 (75 nW)	500 (75 nW)

Remark:

Although these tests were performed other than open area test site, adequate comparison measurements were confirmed against 30 m open are test site. Therefore sufficient tests were made to demonstrate that the alternative site produces results that correlate with the ones of tests made in an open field based on KDB 414788.

### 4.6.2 Test Procedure

Test method Refer as KDB 558074 D01, Section 12.1.

1. The EUT is placed on a turntable, Above 1 GHz is 1.5m and below 1 GHz is 0.8m above ground plane. The EUT Configured un accordance with ANSI C63.10, and the EUT set in a continuous mode.

2. The turntable shall be rotated for 360 degrees to determine the position of maximum emission level. And EUT is set 3m away from the receiving antenna, which is scanned from 1m to 4m above the ground plane to find out the highest emissions. Measurement are made polarized in both the vertical and the horizontal positions with antenna.

3. Span shall wide enough to full capture the emission measured. The SA from 30MHz to 26.5GHz set to the low, Mid and High channels with the EUT transmit.

Remark:

1. Although these tests were performed other than open area test site, adequate comparison measurements were confirmed against 30 m open are test site. Therefore sufficient tests were made to demonstrate that the alternative site produces results that correlate with the ones of tests made in an open field based on KDB 414788.

2. No emission found between lowest internal used/generated frequency to 30MHz (9kHz~30MHz).

4. The SA setting following :

(1) Below 1G : RBW = 100kHz, VBW  $\geq$  3 RBW, Sweep = Auto, Detector = Peak, Trace = Max hold.

(2) Above 1G :

(2.1) For Peak measurement : RBW = 1MHz, VBW  $\geq$  3 RBW, Sweep = Auto, Detector = Peak, Trace = Max hold.

(2.2) For Average measurement : RBW = 1MHz, VBW

· If Duty Cycle  $\geq$  98%, VBW=10Hz.

· If Duty Cycle < 98%, VBW $\geq$ 1/T.

Configuration	Duty Cycle (%)	T(ms)	1/T (kHz)	VBW Setting
Zigbee	100%	1.0000	-	10Hz

Report No.: T180727D04-RP

## 4.6.3 Test Setup

### 9kHz ~ 30MHz

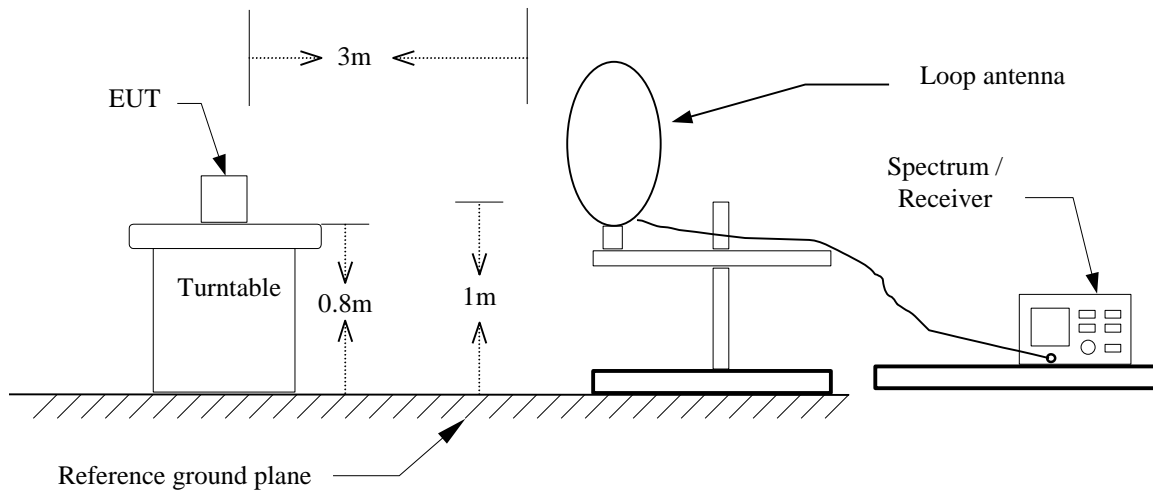

### 30MHz ~ 1GHz

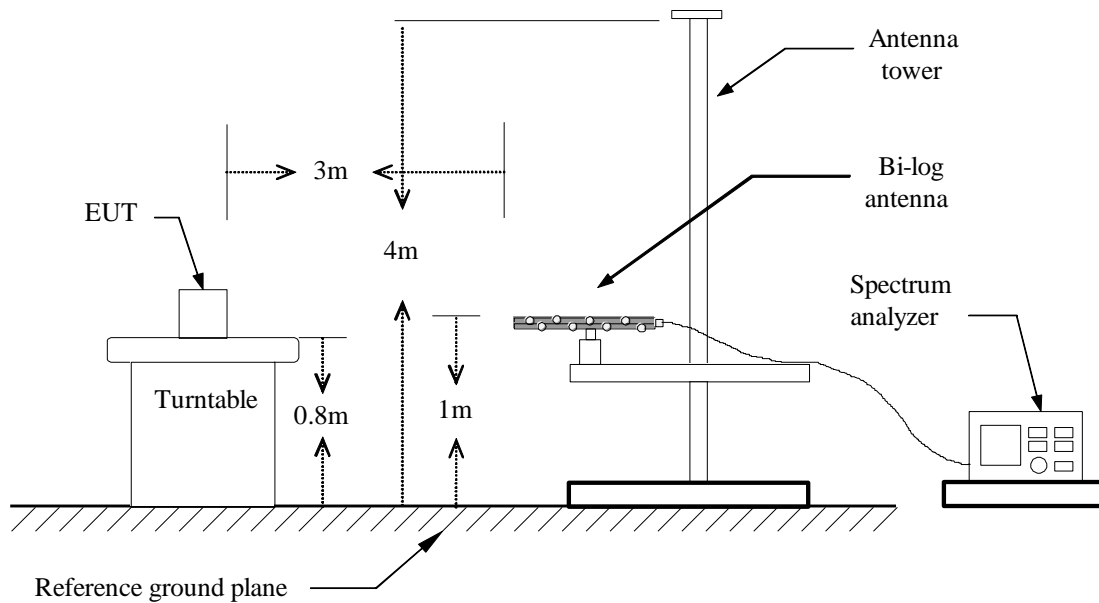

## Above 1 GHz

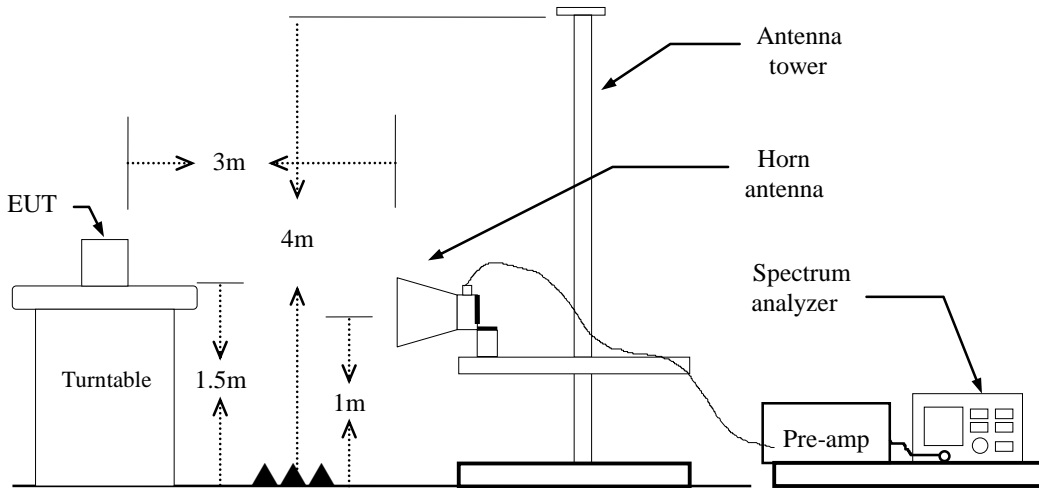

### 4.6.4 Test Result

#### Band Edge Test Data

Test Mode	Zigbee Low CH	Temp/Hum	23.2(°C)/ 40%RH
Test Item	Band Edge	Test Date	August 10, 2018
Polarize	Horizontal	Test Engineer	Jerry Chuang
Detector	Peak		

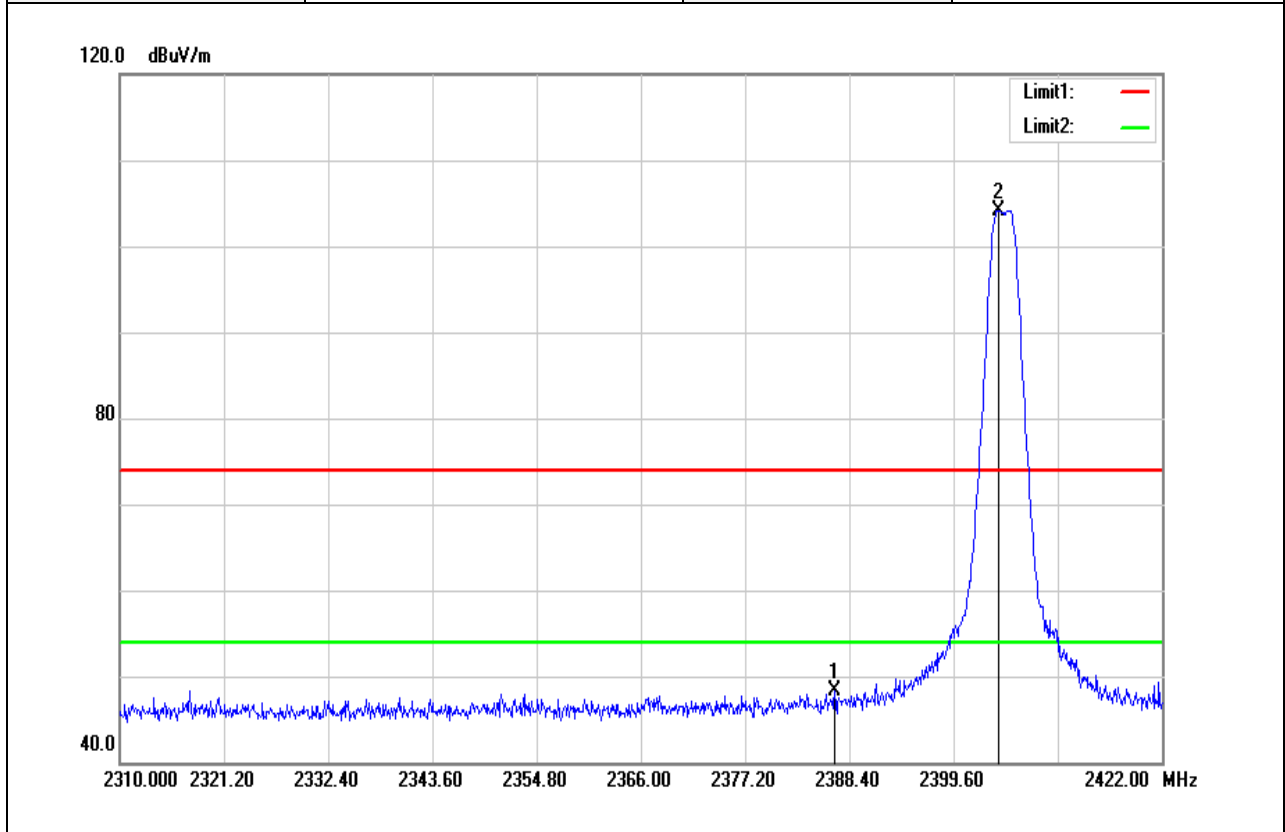

Frequency (MHz)	Reading (dBuV)	Correct Factor(dB/m)	Result (dBuV/m)	Limit (dBuV/m)	Margin (dB)	Remark
2386.832	51.24	-2.99	48.25	74.00	-25.75	peak
2404.416	107.11	-2.93	104.18	-	-	peak

Test Mode	Zigbee Low CH	Temperature:	23.2(°C)/ 40%RH
Test Item	Band Edge	Test Date	August 10, 2018
Polarize	Horizontal	Test Engineer	Jerry Chuang
Detector	Average		

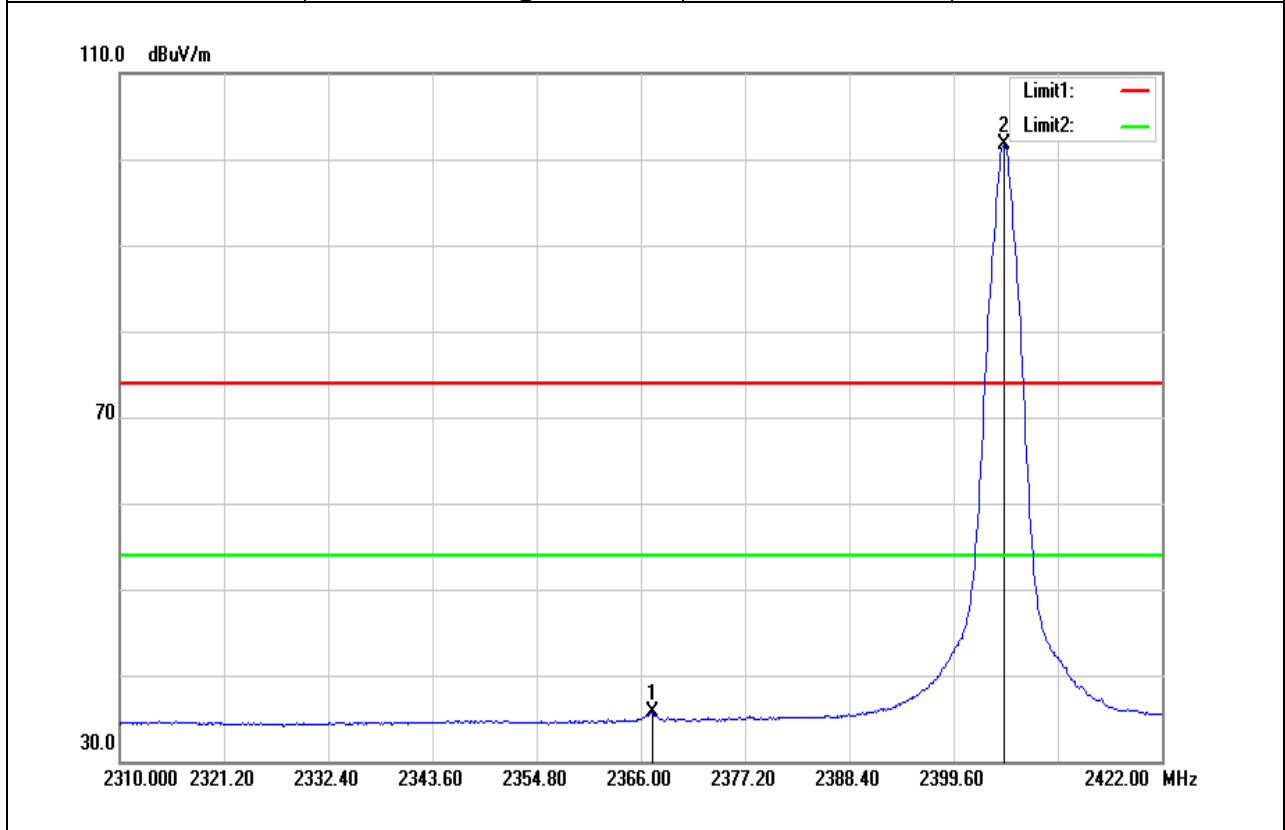

Frequency (MHz)	Reading (dBuV)	Correct Factor(dB/m)	Result (dBuV/m)	Limit (dBuV/m)	Margin (dB)	Remark
2367.232	38.72	-3.06	35.66	54.00	-18.34	AVG
2405.088	104.62	-2.93	101.69	-	-	AVG

Test Mode	Zigbee High CH	Temp/Hum	23.2(°C)/ 40%RH
Test Item	Band Edge	Test Date	August 10, 2018
Polarize	Horizontal	Test Engineer	Jerry Chuang
Detector	Peak		

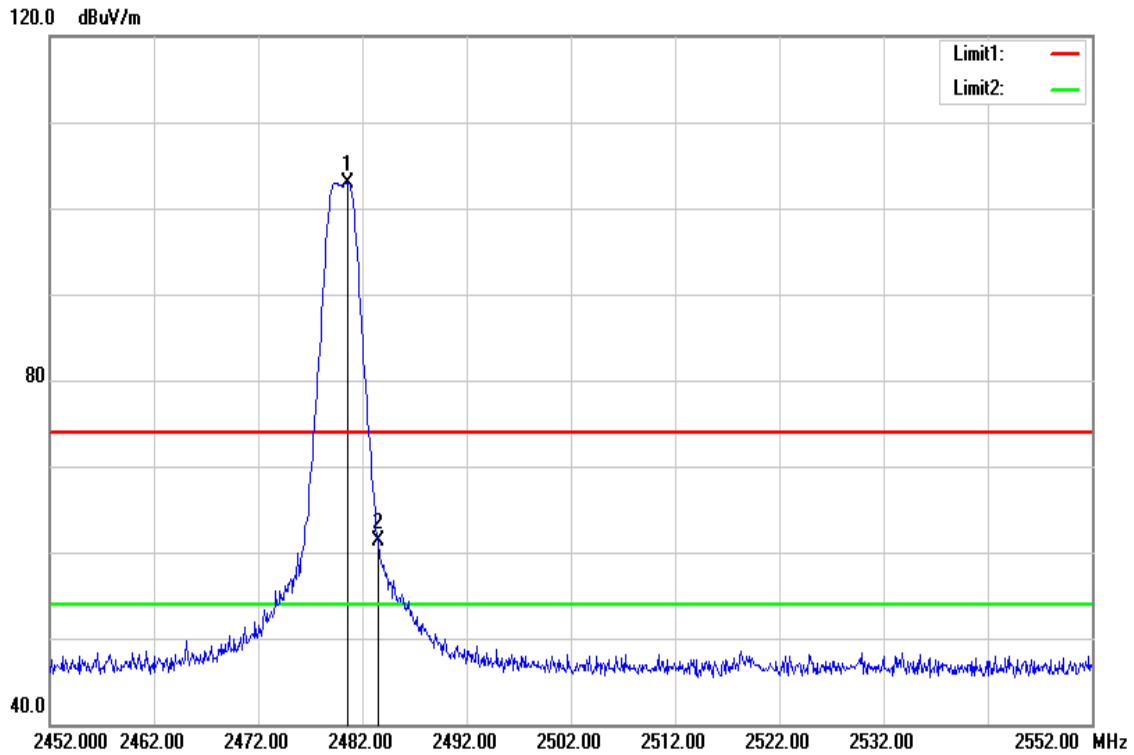

Frequency (MHz)	Reading (dBuV)	Correct Factor(dB/m)	Result (dBuV/m)	Limit (dBuV/m)	Margin (dB)	Remark
2480.600	105.69	-2.70	102.99	-	-	peak
2483.500	64.04	-2.69	61.35	74.00	-12.65	peak

Test Mode	Zigbee High CH	Temperature:	23.2(°C)/ 40%RH
Test Item	Band Edge	Test Date	August 10, 2018
Polarize	Horizontal	Test Engineer	Jerry Chuang
Detector	Average		

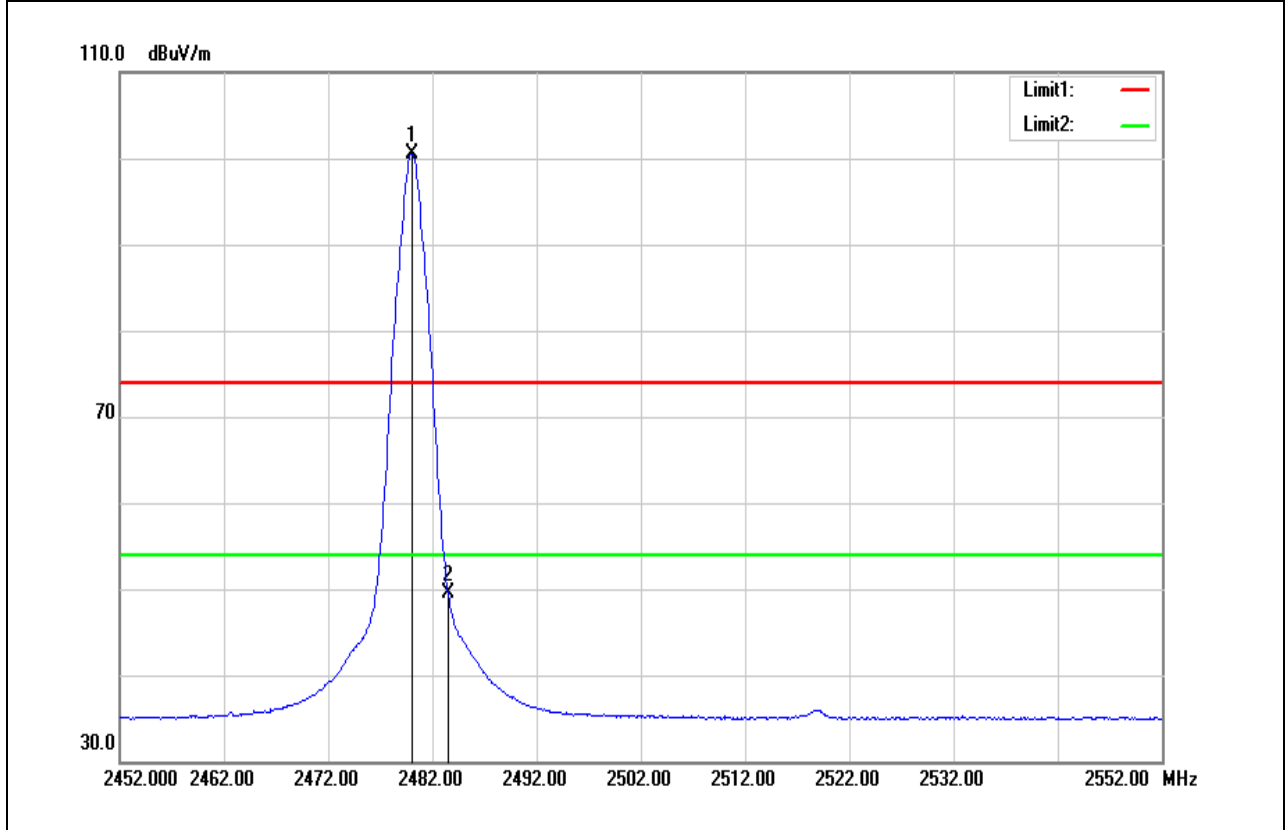

Frequency (MHz)	Reading (dBuV)	Correct Factor(dB/m)	Result (dBuV/m)	Limit (dBuV/m)	Margin (dB)	Remark
2480.000	103.21	-2.70	100.51	-	-	AVG
2483.500	52.12	-2.69	49.43	54.00	-4.57	AVG



**Below 1GHz**

Test Mode	Mode 1	Temp/Hum	23.2(°C)/ 40%RH
Test Item	30MHz-1GHz	Test Date	August 10, 2018
Polarize	Vertical	Test Engineer	Jerry Chuang
Detector	Peak and Qusi-peak		

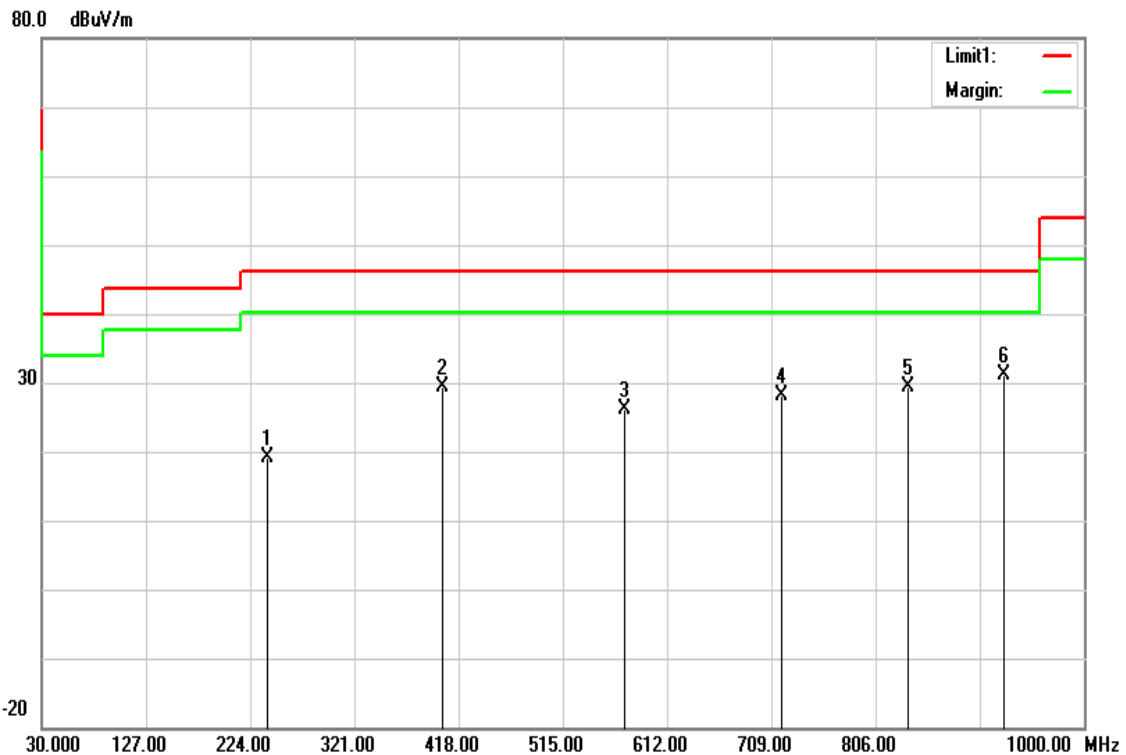

Frequency (MHz)	Reading (dBuV)	Correct Factor(dB/m)	Result (dBuV/m)	Limit (dBuV/m)	Margin (dB)	Remark
240.4900	28.76	-9.67	19.09	46.02	-26.93	peak
403.4500	34.03	-4.65	29.38	46.02	-16.64	peak
572.2300	27.15	-0.97	26.18	46.02	-19.84	peak
718.7000	26.33	1.79	28.12	46.02	-17.90	peak
836.0700	25.55	3.88	29.43	46.02	-16.59	peak
925.3100	26.02	5.10	31.12	46.02	-14.90	peak

Test Mode	Mode 1	Temp/Hum	23.2(°C)/ 40%RH
Test Item	30MHz-1GHz	Test Date	August 10, 2018
Polarize	Horizontal	Test Engineer	Jerry Chuang
Detector	Peak and Qusi-peak		

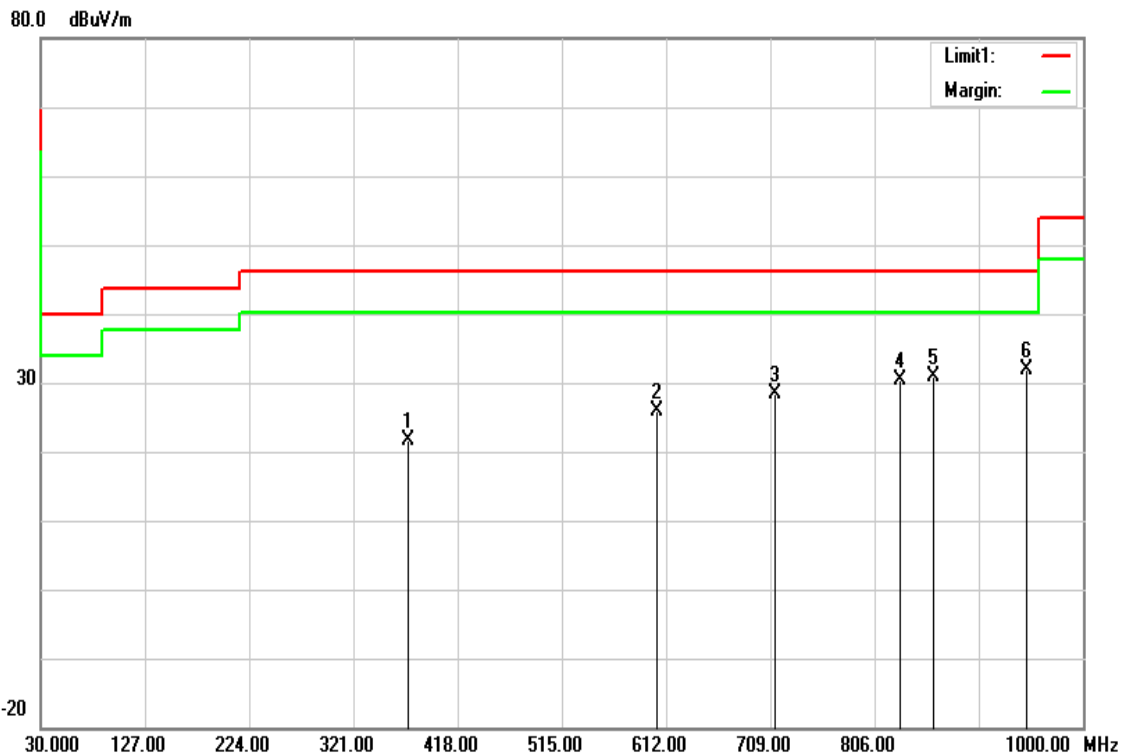

Frequency (MHz)	Reading (dBuV)	Correct Factor(dB/m)	Result (dBuV/m)	Limit (dBuV/m)	Margin (dB)	Remark
371.4400	27.31	-5.61	21.70	46.02	-24.32	peak
603.2700	26.41	-0.60	25.81	46.02	-20.21	peak
713.8500	26.62	1.70	28.32	46.02	-17.70	peak
829.2800	26.59	3.78	30.37	46.02	-15.65	peak
861.2900	26.89	4.05	30.94	46.02	-15.08	peak
947.6200	26.45	5.35	31.80	46.02	-14.22	peak

Report No.: T180727D04-RP

**Above 1 GHz**

Test Mode	Zigbee Low CH	Temp/Hum	23.2(°C)/ 40%RH
Test Item	Harmonic	Test Date	August 10, 2018
Polarize	Horizontal	Test Engineer	Jerry Chuang
Detector	Peak and Average		

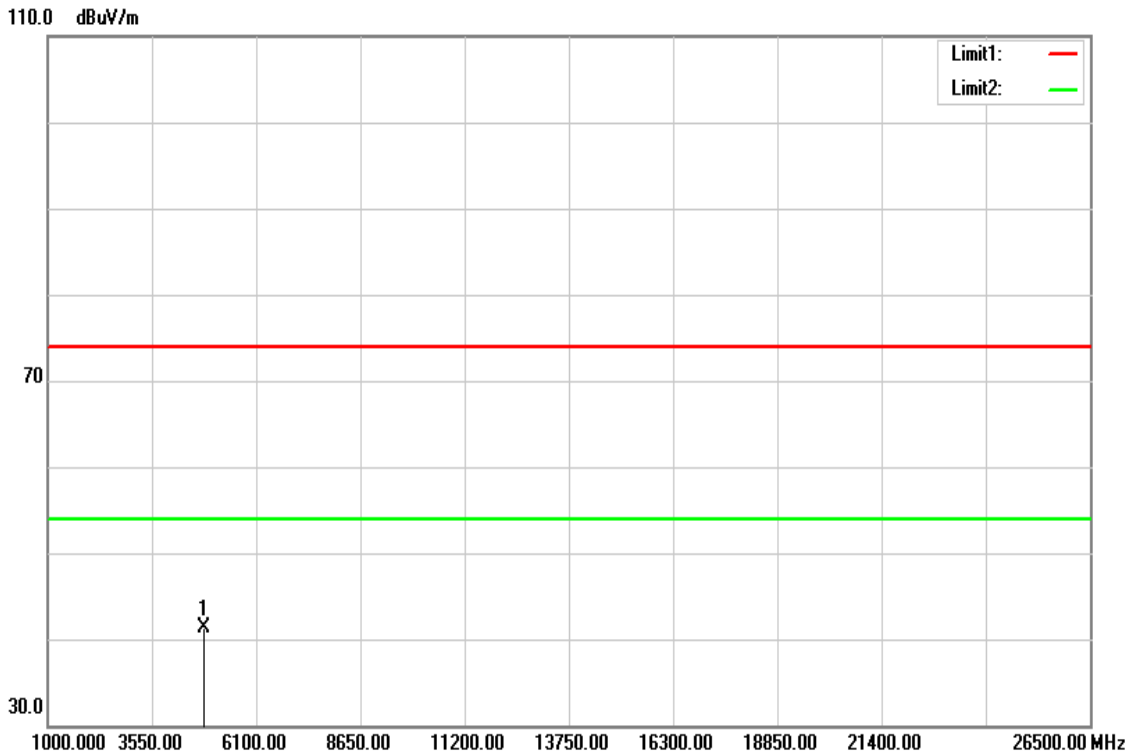

Frequency (MHz)	Reading (dBuV)	Correct Factor(dB/m)	Result (dBuV/m)	Limit (dBuV/m)	Margin (dB)	Remark
4810.000	36.85	4.35	41.20	74.00	-32.80	peak
N/A						

**Remark:**

1. Measuring frequencies from 1 GHz to the 10th harmonic of highest fundamental frequency.
2. For above 1GHz, the EUT peak value was under average limit, therefore the Average value compliance with the average limit

Test Mode	Zigbee Low CH	Temp/Hum	23.2(°C)/ 40%RH
Test Item	Harmonic	Test Date	August 10, 2018
Polarize	Vertical	Test Engineer	Jerry Chuang
Detector	Peak and Average		

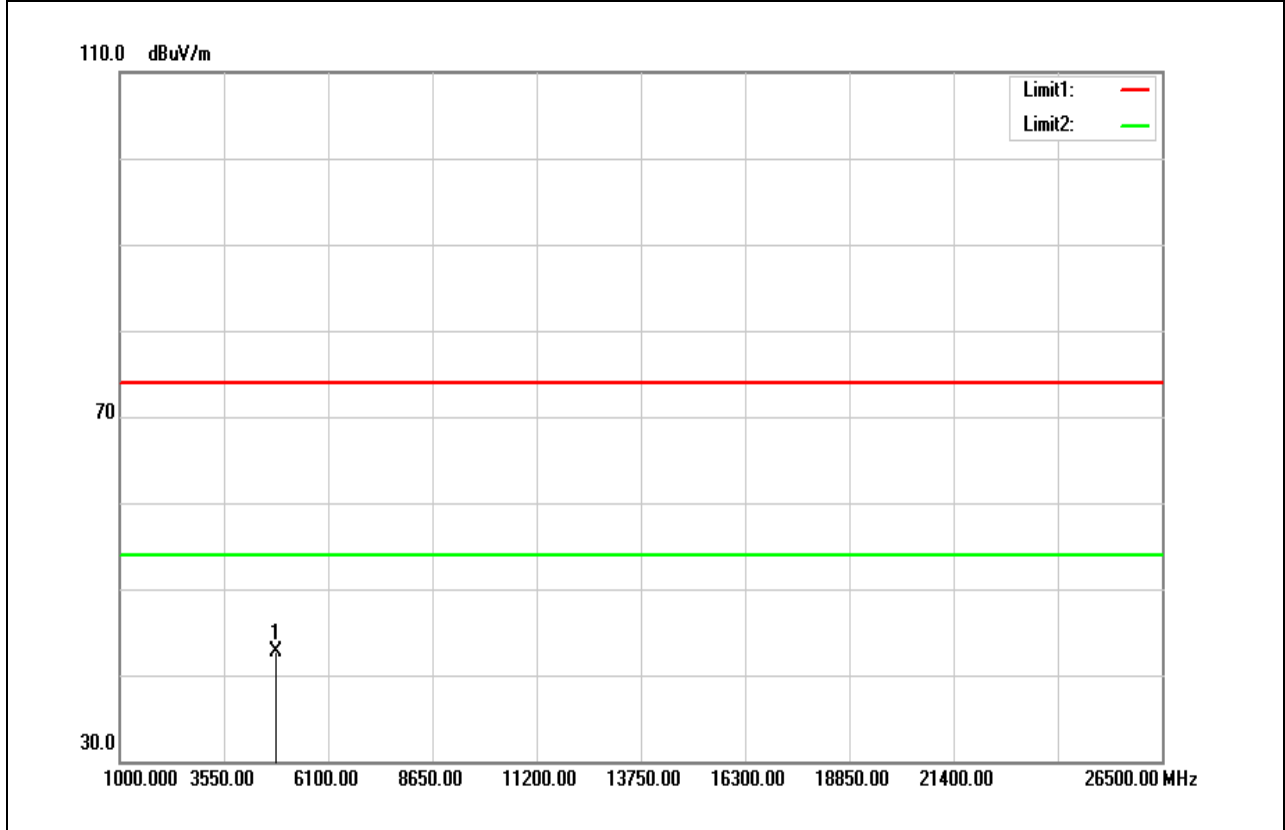

Frequency (MHz)	Reading (dBuV)	Correct Factor(dB/m)	Result (dBuV/m)	Limit (dBuV/m)	Margin (dB)	Remark
4810.000	38.29	4.35	42.64	74.00	-31.36	peak
N/A						

**Remark:**

1. Measuring frequencies from 1 GHz to the 10th harmonic of highest fundamental frequency.
2. For above 1GHz, the EUT peak value was under average limit, therefore the Average value compliance with the average limit

Test Mode	Zigbee Mid CH	Temp/Hum	23.2(°C)/ 40%RH
Test Item	Harmonic	Test Date	August 10, 2018
Polarize	Horizontal	Test Engineer	Jerry Chuang
Detector	Peak and Average		

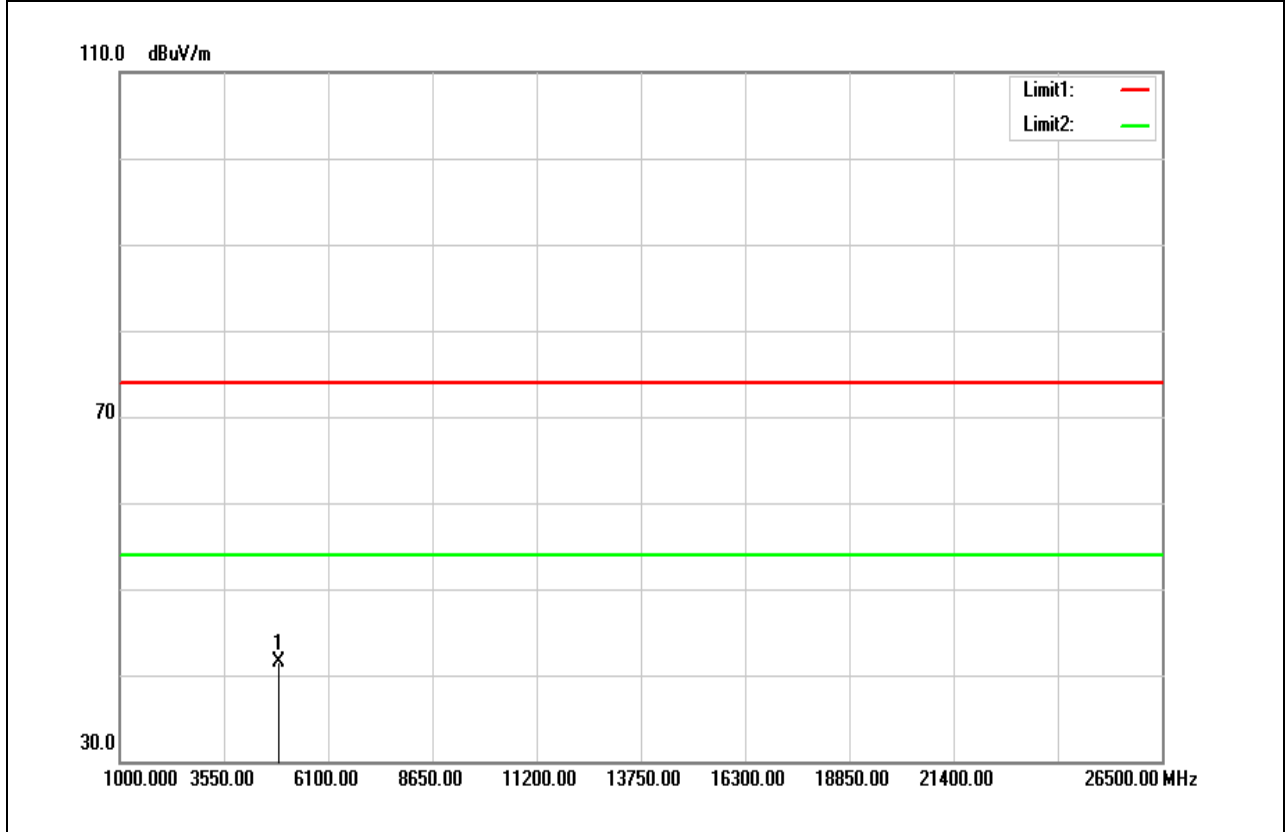

Frequency (MHz)	Reading (dBuV)	Correct Factor(dB/m)	Result (dBuV/m)	Limit (dBuV/m)	Margin (dB)	Remark
4880.000	37.01	4.48	41.49	74.00	-32.51	peak
N/A						

**Remark:**

1. Measuring frequencies from 1 GHz to the 10th harmonic of highest fundamental frequency.
2. For above 1GHz, the EUT peak value was under average limit, therefore the Average value compliance with the average limit

Test Mode	Zigbee Mid CH	Temp/Hum	23.2(°C)/ 40%RH
Test Item	Harmonic	Test Date	August 10, 2018
Polarize	Vertical	Test Engineer	Jerry Chuang
Detector	Peak and Average		

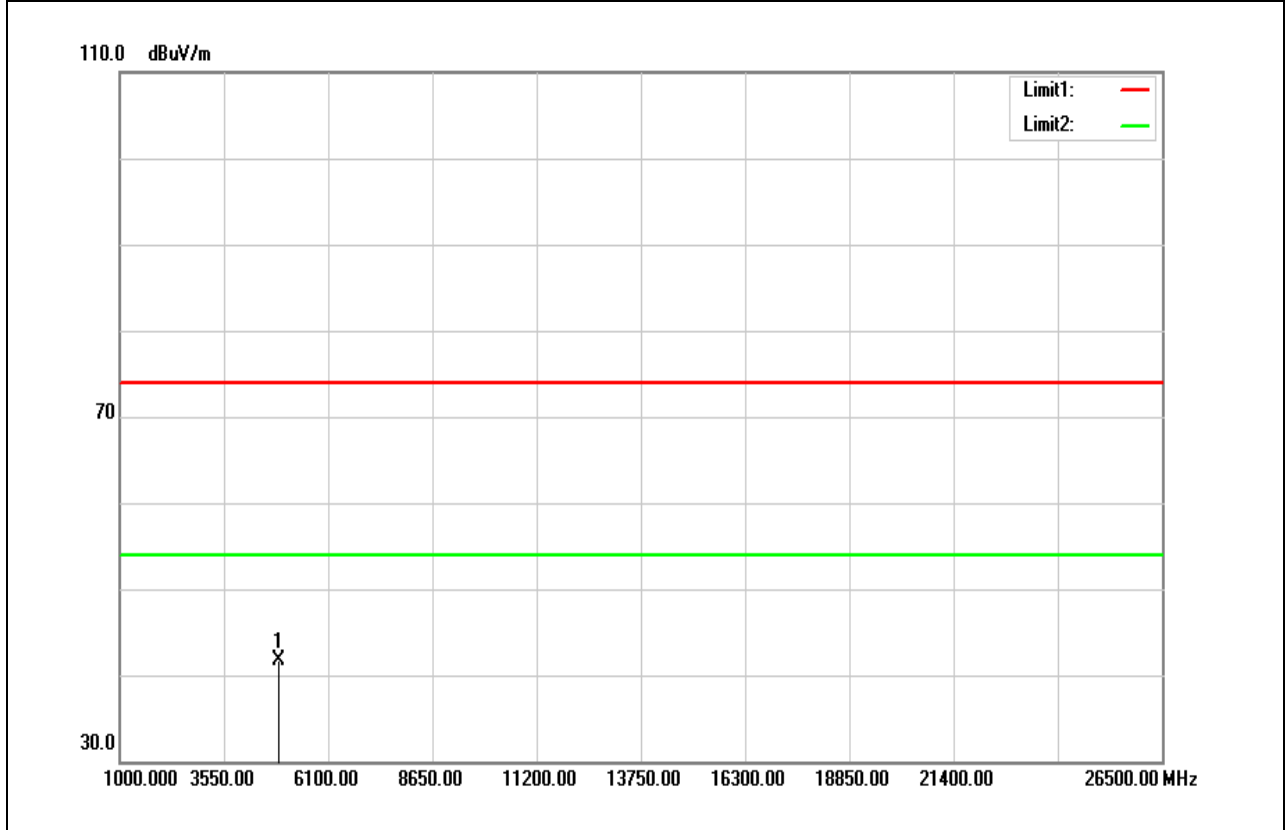

Frequency (MHz)	Reading (dBuV)	Correct Factor(dB/m)	Result (dBuV/m)	Limit (dBuV/m)	Margin (dB)	Remark
4880.000	37.22	4.48	41.70	74.00	-32.30	peak
N/A						

**Remark:**

1. Measuring frequencies from 1 GHz to the 10th harmonic of highest fundamental frequency.
2. For above 1GHz, the EUT peak value was under average limit, therefore the Average value compliance with the average limit

Test Mode	Zigbee High CH	Temp/Hum	23.2(°C)/ 40%RH
Test Item	Harmonic	Test Date	August 10, 2018
Polarize	Horizontal	Test Engineer	Jerry Chuang
Detector	Peak and Average		

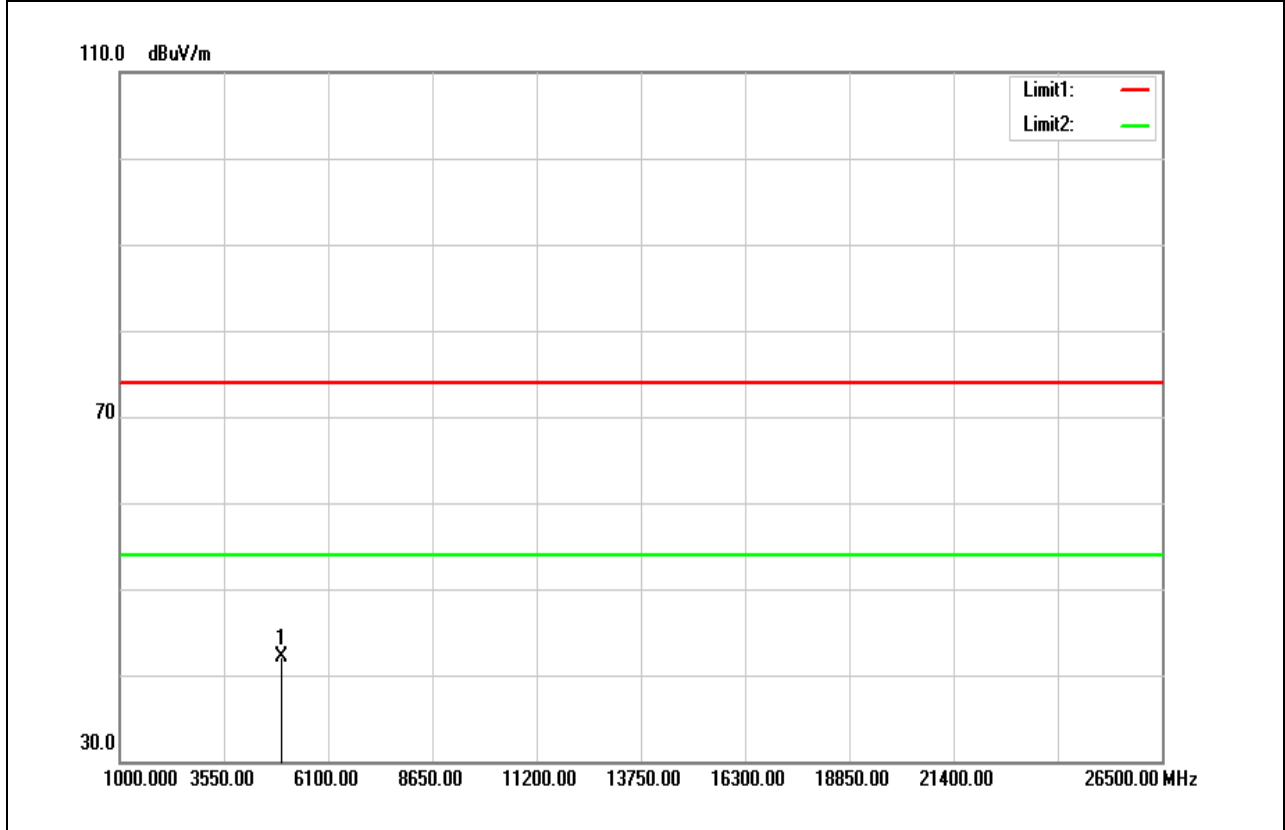

Frequency (MHz)	Reading (dBuV)	Correct Factor(dB/m)	Result (dBuV/m)	Limit (dBuV/m)	Margin (dB)	Remark
4960.000	37.53	4.61	42.14	74.00	-31.86	peak
N/A						

**Remark:**

1. Measuring frequencies from 1 GHz to the 10th harmonic of highest fundamental frequency.
2. For above 1GHz, the EUT peak value was under average limit, therefore the Average value compliance with the average limit

Test Mode	Zigbee High CH	Temp/Hum	23.2(°C)/ 40%RH
Test Item	Harmonic	Test Date	August 10, 2018
Polarize	Vertical	Test Engineer	Jerry Chuang
Detector	Peak and Average		

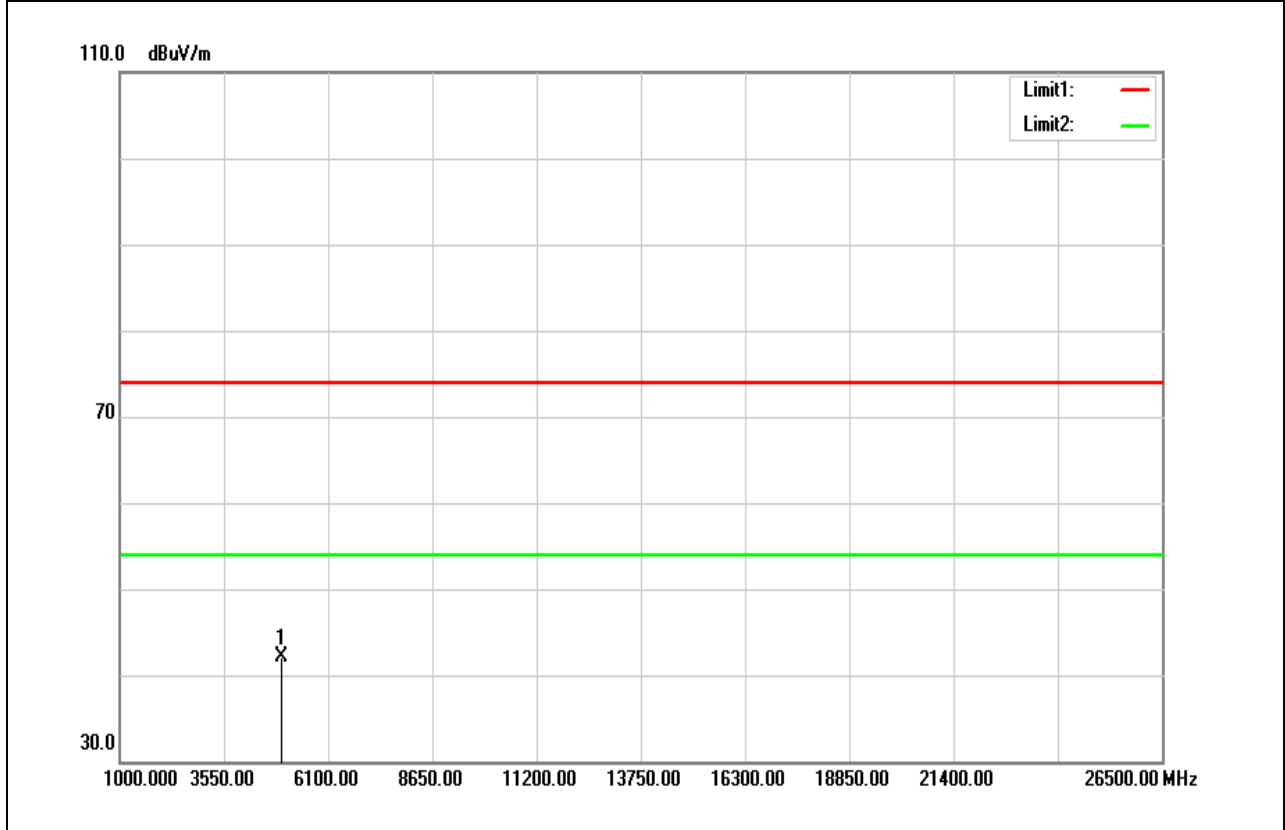

Frequency (MHz)	Reading (dBuV)	Correct Factor(dB/m)	Result (dBuV/m)	Limit (dBuV/m)	Margin (dB)	Remark
4960.000	37.50	4.61	42.11	74.00	-31.89	peak
N/A						

**Remark:**

1. Measuring frequencies from 1 GHz to the 10th harmonic of highest fundamental frequency.
2. For above 1GHz, the EUT peak value was under average limit, therefore the Average value compliance with the average limit

**--End of Report--**