

FCC 47 CFR PART 15 SUBPART C

TEST REPORT

For

Micro Door Window Sensor

Model: SZ-DWS06

Trade Name: Sercomm / Xfinity

Issued to

Sercomm Corporation
8F, No. 3-1, YuanQu St., NanKang, Taipei 115, Taiwan, R.O.C.

Issued by

Compliance Certification Services Inc.
No.11, Wugong 6th Rd., Wugu Dist.,
New Taipei City 24891, Taiwan. (R.O.C.)
<http://www.ccsrf.com>
service@ccsrf.com
Issued Date: July 2, 2015



Note: This report shall not be reproduced except in full, without the written approval of Compliance Certification Services Inc. This document may be altered or revised by Compliance Certification Services Inc. personnel only, and shall be noted in the revision section of the document.

Revision History

| Rev. | Issue Date | Revisions | Effect Page | Revised By |
|------|--------------|---------------|-------------|-------------|
| 00 | July 2, 2015 | Initial Issue | ALL | Angel Cheng |

TABLE OF CONTENTS

| | |
|--|-----------|
| 1. TEST RESULT CERTIFICATION | 4 |
| 2. EUT DESCRIPTION | 5 |
| 3. TEST METHODOLOGY | 6 |
| 3.1 EUT CONFIGURATION..... | 6 |
| 3.2 EUT EXERCISE | 6 |
| 3.3 GENERAL TEST PROCEDURES..... | 6 |
| 3.4 FCC PART 15.205 RESTRICTED BANDS OF OPERATIONS | 7 |
| 3.5 DESCRIPTION OF TEST MODES..... | 8 |
| 4 INSTRUMENT CALIBRATION..... | 9 |
| 4.1 MEASURING INSTRUMENT CALIBRATION | 9 |
| 4.2 MEASUREMENT EQUIPMENT USED..... | 9 |
| 4.3 MEASUREMENT UNCERTAINTY | 10 |
| 5 FACILITIES AND ACCREDITATIONS | 11 |
| 5.1 FACILITIES | 11 |
| 5.2 EQUIPMENT | 11 |
| 5.3 TABLE OF ACCREDITATIONS AND LISTINGS | 12 |
| 6 SETUP OF EQUIPMENT UNDER TEST | 13 |
| 6.1 SETUP CONFIGURATION OF EUT | 13 |
| 6.2 SUPPORT EQUIPMENT..... | 13 |
| 7 FCC PART 15.247 REQUIREMENTS..... | 14 |
| 7.1 6DB BANDWIDTH | 14 |
| 7.2 PEAK POWER | 17 |
| 7.3 AVERAGE POWER..... | 18 |
| 7.4 BAND EDGES MEASUREMENT | 19 |
| 7.5 PEAK POWER SPECTRAL DENSITY | 26 |
| 7.6 SPURIOUS EMISSIONS | 29 |
| 7.7 POWERLINE CONDUCTED EMISSIONS | 40 |
| APPENDIX I PHOTOGRAPHS OF TEST SETUP | 41 |
| APPENDIX 1 - PHOTOGRAPHS OF EUT | |

1. TEST RESULT CERTIFICATION

Applicant: Sercomm Corporation
 8F, No. 3-1, YuanQu St., NanKang, Taipei 115, Taiwan, R.O.C.

Equipment Under Test: Micro Door Window Sensor

Trade Name: Sercomm / Xfinity

Model: SZ-DWS06

Date of Test: June 29, 2015

| APPLICABLE STANDARDS | |
|------------------------------------|-------------------------|
| STANDARD | TEST RESULT |
| FCC 47 CFR Part 15 Subpart C | No non-compliance noted |
| Deviation from Applicable Standard | |
| N/A | |

We hereby certify that:

The above equipment was tested by Compliance Certification Services Inc. The test data, data evaluation, test procedures, and equipment configurations shown in this report were made in accordance with the procedures given in **ANSI C63.4: 2009** and the energy emitted by the sample EUT tested as described in this report is in compliance with the requirements of FCC Rules Part 15.207, 15.209, 15.247.

The test results of this report relate only to the tested sample EUT identified in this report.

Approved by:

Reviewed by:



Miller Lee
 Manager
 Compliance Certification Services Inc.

Angel Cheng
 Section Manager
 Compliance Certification Services Inc.

2. EUT DESCRIPTION

| | |
|------------------------------|---|
| Product | Micro Door Window Sensor |
| Trade Name | Sercomm / Xfinity |
| Model Number | SZ-DWS06 |
| Model Discrepancy | N/A |
| Received Date | June 15, 2015 |
| Power Adapter | Lithium battery: 1. Panasonic / CR2450 / 3V, 600mah 2. Sony / CR2450 / 3V, 600mah |
| Frequency Range | Zigbee: 2405~2480MHz |
| Transmit Power | 6.06 dBm |
| Modulation Technique | Zigbee: OPQSK (Offset Quadrature Phase Shift Keyed) |
| Number of Channels | 14 Channels |
| Antenna Specification | Zigbee: Gain: -0.66 dBi |
| Antenna Designation | Zigbee: Chip Antenna |

Remark:

1. *The sample selected for test was production product and was provided by manufacturer.*
2. *This submittal(s) (test report) is intended for FCC ID: **P27SZDWS06** filing to comply with Section 15.207, 15.209 and 15.247 of the FCC Part 15, Subpart C Rules.*

3. TEST METHODOLOGY

The tests documented in this report were performed in accordance with ANSI C63.4: 2009 and FCC CFR 47 Part 15.207, 15.209, 15.247, KDB558074.

3.1 EUT CONFIGURATION

The EUT configuration for testing is installed on RF field strength measurement to meet the Commissions requirement and operating in a manner that intends to maximize its emission characteristics in a continuous normal application.

3.2 EUT EXERCISE

The EUT was operated in the engineering mode to fix the TX frequency that was for the purpose of the measurements.

According to its specifications, the EUT must comply with the requirements of the Section 15.207, 15.209 and 15.247 under the FCC Rules Part 15 Subpart C.

3.3 GENERAL TEST PROCEDURES

Conducted Emissions

The EUT is placed on the turntable, which is 0.8 m above ground plane. According to the requirements in Section 13.1.4.1 of ANSI C63.4 Conducted emissions from the EUT measured in the frequency range between 0.15 MHz and 30MHz using CISPR Quasi-peak and average detector modes.

Radiated Emissions

The EUT is placed on a turn table, which is 0.8 m above ground plane. The turntable shall rotate 360 degrees to determine the position of maximum emission level. EUT is set 3m away from the receiving antenna, which varied from 1m to 4m to find out the highest emission. And also, each emission was to be maximized by changing the polarization of receiving antenna both horizontal and vertical. In order to find out the maximum emissions, exploratory radiated emission measurements were made according to the requirements in Section 13.1.4.1 of ANSI C63.4.

3.4 FCC PART 15.205 RESTRICTED BANDS OF OPERATIONS

(a) Except as shown in paragraph (d) of this section, only spurious emissions are permitted in any of the frequency bands listed below:

| MHz | MHz | MHz | GHz |
|----------------------------|---------------------|-----------------|------------------|
| 0.090 - 0.110 | 16.42 - 16.423 | 399.9 - 410 | 4.5 - 5.15 |
| ¹ 0.495 - 0.505 | 16.69475 - 16.69525 | 608 - 614 | 5.35 - 5.46 |
| 2.1735 - 2.1905 | 16.80425 - 16.80475 | 960 - 1240 | 7.25 - 7.75 |
| 4.125 - 4.128 | 25.5 - 25.67 | 1300 - 1427 | 8.025 - 8.5 |
| 4.17725 - 4.17775 | 37.5 - 38.25 | 1435 - 1626.5 | 9.0 - 9.2 |
| 4.20725 - 4.20775 | 73 - 74.6 | 1645.5 - 1646.5 | 9.3 - 9.5 |
| 6.215 - 6.218 | 74.8 - 75.2 | 1660 - 1710 | 10.6 - 12.7 |
| 6.26775 - 6.26825 | 108 - 121.94 | 1718.8 - 1722.2 | 13.25 - 13.4 |
| 6.31175 - 6.31225 | 123 - 138 | 2200 - 2300 | 14.47 - 14.5 |
| 8.291 - 8.294 | 149.9 - 150.05 | 2310 - 2390 | 15.35 - 16.2 |
| 8.362 - 8.366 | 156.52475 - | 2483.5 - 2500 | 17.7 - 21.4 |
| 8.37625 - 8.38675 | 156.52525 | 2655 - 2900 | 22.01 - 23.12 |
| 8.41425 - 8.41475 | 156.7 - 156.9 | 3260 - 3267 | 23.6 - 24.0 |
| 12.29 - 12.293 | 162.0125 - 167.17 | 3332 - 3339 | 31.2 - 31.8 |
| 12.51975 - 12.52025 | 167.72 - 173.2 | 3345.8 - 3358 | 36.43 - 36.5 |
| 12.57675 - 12.57725 | 240 - 285 | 3600 - 4400 | (²) |
| 13.36 - 13.41 | 322 - 335.4 | | |

¹ Until February 1, 1999, this restricted band shall be 0.490-0.510 MHz.

² Above 38.6

(b) Except as provided in paragraphs (d) and (e), the field strength of emissions appearing within these frequency bands shall not exceed the limits shown in Section 15.209. At frequencies equal to or less than 1000 MHz, compliance with the limits in Section 15.209 shall be demonstrated using measurement instrumentation employing a CISPR quasi-peak detector. Above 1000 MHz, compliance with the emission limits in Section 15.209 shall be demonstrated based on the average value of the measured emissions. The provisions in Section 15.35 apply to these measurements.

3.5 DESCRIPTION OF TEST MODES

The EUT (model: SZ-DWS06) had been tested under operating condition.

Software used to control the EUT for staying in continuous transmitting mode was programmed.

After verification, all tests were carried out with the worst case test modes as shown below except radiated spurious emission below 1GHz and power line conducted emissions below 30MHz, which worst case was in normal link mode only.

Zigbee:

Channel Low and Channel High were chosen for full testing.

The field strength of spurious emission was measured in the following position: EUT stand-up position (Z axis), lie-down position (X, Y axis). The worst emission was found in lie-down position (X axis) and the worst case was recorded.

4 INSTRUMENT CALIBRATION

4.1 MEASURING INSTRUMENT CALIBRATION

The measuring equipment, which was utilized in performing the tests documented herein, has been calibrated in accordance with the manufacturer's recommendations for utilizing calibration equipment, which is traceable to recognized national standards.

4.2 MEASUREMENT EQUIPMENT USED

Equipment Used for Emissions Measurement

Remark: Each piece of equipment is scheduled for calibration once a year.

| Conducted Emissions Test Site | | | | |
|-------------------------------|---------------|-----------|---------------|-----------------|
| Name of Equipment | Manufacturer | Model | Serial Number | Calibration Due |
| Spectrum Analyzer | Agilent | E4446A | US42510252 | 11/23/2015 |
| Thermostatic/Humidity Chamber | TAICHY | MHG-150LF | 930619 | 10/07/2015 |
| AC Power Source | EXTECH | 6205 | 1140845 | N.C.R |
| DC Power Supply | ABM | 8301HD | D011531 | N.C.R |
| Power Meter | Anritsu | ML2495A | 1012009 | 06/08/2015 |
| Power Sensor | Anritsu | MA2411A | 0917072 | 06/09/2015 |
| Spectrum Analyzer | ROHDE&SCHWARZ | FSV40 | 101073 | 07/09/2015 |

| Wugu 966 Chamber A | | | | |
|--------------------|--------------------|---------------------|---------------|-----------------|
| Name of Equipment | Manufacturer | Model | Serial Number | Calibration Due |
| Spectrum Analyzer | Agilent | E4446A | US42510268 | 09/18/2015 |
| EMI Test Receiver | R&S | ESCI | 100064 | 06/04/2016 |
| Bilog Antenna | Sunol Sciences | JB3 | A030105 | 08/19/2015 |
| Horn Antenna | EMCO | 3117 | 00055165 | 01/26/2016 |
| Horn Antenna | EMCO | 3116 | 26370 | 12/25/2015 |
| Turn Table | CCS | CC-T-1F | N/A | N.C.R |
| Antenna Tower | CCS | CC-A-1F | N/A | N.C.R |
| Controller | CCS | CC-C-1F | N/A | N.C.R |
| Pre-Amplifier | MITEQ | 1652-3000 | 1490939 | 08/09/2016 |
| Pre-Amplifier | EMC | EMC 012635 | 980151 | 06/04/2016 |
| Pre-Amplifier | MITEQ | AMF-6F-260400-40-8P | 985646 | 12/25/2015 |
| Coaxial Cable | Huber+Suhner | 102 | 29212/2 | 12/25/2015 |
| Coaxial Cable | Huber+Suhner | 102 | 29406/2 | 12/25/2015 |
| Test S/W | EZ-EMC (CCS-3A1RE) | | | |

4.3 MEASUREMENT UNCERTAINTY

| PARAMETER | UNCERTAINTY |
|---------------------------------------|-------------|
| Powerline Conducted Emission | N/A |
| 3M Semi Anechoic Chamber / <200M | +/- 4.0138 |
| 3M Semi Anechoic Chamber / 200M~1000M | +/- 3.9483 |
| 3M Semi Anechoic Chamber / 1G~8G | +/- 2.5975 |
| 3M Semi Anechoic Chamber / 8G~18G | +/- 2.6112 |
| 3M Semi Anechoic Chamber / 18G~26G | +/- 2.7389 |
| 3M Semi Anechoic Chamber / 26G~40G | +/- 2.9683 |

Remark: This uncertainty represents an expanded uncertainty expressed at approximately the 95% confidence level using a coverage factor of $k=2$.

5 FACILITIES AND ACCREDITATIONS

5.1 FACILITIES

All measurement facilities used to collect the measurement data are located at

No.199, Chunghsen Road, Hsintien City, Taipei Hsien, Taiwan, R.O.C.

Tel: 886-2-2217-0894 / Fax: 886-2-2217-1029

No.11, Wugong 6th Rd., Wugu Dist., New Taipei City 24891, Taiwan. (R.O.C.)

Tel: 886-2-2299-9720 / Fax: 886-2-2298-4045

No.81-1, Lane 210, Bade 2nd Rd., Lujhu Township, Taoyuan County 33841, TAIWAN, R.O.C.

Tel: 886-3-324-0332 / Fax: 886-3-324-5235

The sites are constructed in conformance with the requirements of ANSI C63.7, ANSI C63.4 and CISPR Publication 22.

5.2 EQUIPMENT



Radiated emissions are measured with one or more of the following types of linearly polarized antennas: tuned dipole, biconical, log periodic, bi-log, and/or ridged waveguide, horn. Spectrum analyzers with pre-selectors and quasi-peak detectors are used to perform radiated measurements.

Conducted emissions are measured with Line Impedance Stabilization Networks and EMI Test Receivers.

Calibrated wideband preamplifiers, coaxial cables, and coaxial attenuators are also used for making measurements.

All receiving equipment conforms to CISPR Publication 16-1, "Radio Interference Measuring Apparatus and Measurement Methods."

5.3 TABLE OF ACCREDITATIONS AND LISTINGS

| Country | Agency | Scope of Accreditation | Logo |
|---------|-----------------|--|---|
| USA | FCC | 3M Semi Anechoic Chamber (FCC MRA: TW1039) to perform FCC Part 15 measurements |  FCC MRA: TW1039 |
| Taiwan | TAF | LP0002, RTTE01, FCC Method-47 CFR Part 15 Subpart C, D, E, RSS-210, RSS-310 IDA TS SRD, AS/NZS 4268, AS/NZS 4771, TS 12.1 & 12.2, ETSI EN 300 440-1, ETSI EN 300 440-2, ETSI EN 300 328, ETSI EN 300 220-1, ETSI EN 300 220-2, ETSI EN 301 893, ETSI EN 301 489-1/3/7/17 FCC OET Bulletin 65 + Supplement C, EN 50360, EN 50361, EN 50371, RSS 102, EN 50383, EN 50385, EN 50392, IEC 62209, CNS 14958-1, CNS 14959 FCC Method -47 CFR Part 15 Subpart B IEC / EN 61000-3-2, IEC / EN 61000-3-3, IEC / EN 61000-4-2/3/4/5/6/8/11 |  |
| Canada | Industry Canada | 3M Semi Anechoic Chamber (IC 2324G-1 / IC 2324G-2) to perform |  IC 2324G-1 IC 2324G-2 |

** No part of this report may be used to claim or imply product endorsement by A2LA or any agency of the US Government.*

6 SETUP OF EQUIPMENT UNDER TEST

6.1 SETUP CONFIGURATION OF EUT

See test photographs attached in Appendix II for the actual connections between EUT and support equipment.

6.2 SUPPORT EQUIPMENT

| No. | Device Type | Brand | Model | Series No. | FCC ID | Data Cable | Power Cord |
|-----|-------------|-------|-------|------------|--------|------------|------------|
| | N/A | | | | | | |

Remark:

1. *All the equipment/cables were placed in the worst-case configuration to maximize the emission during the test.*
2. *Grounding was established in accordance with the manufacturer's requirements and conditions for the intended use.*

7 FCC PART 15.247 REQUIREMENTS

7.1 6DB BANDWIDTH

LIMIT

According to §15.247(a)(2), systems using digital modulation techniques may operate in the 902 - 928 MHz, 2400 - 2483.5 MHz, and 5725 - 5850 MHz bands. The minimum 6 dB bandwidth shall be at least 500 kHz.

Test Configuration

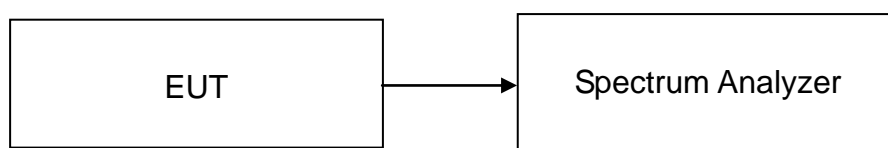

TEST PROCEDURE

The transmitter output is connected to the spectrum analyzer. Set the RBW=100kHz the emission bandwidth, VBW ≥ 3 x RBW, Detector = Peak, Trace mode = max hold, Sweep = auto couple. Measure the maximum width of the emission that is constrained by the frequencies associated with the two amplitude points (upper and lower) that are attenuated by 6dB relative to the maximum level measured in the fundamental emission.

TEST RESULTS

No non-compliance noted

Test Data

| Channel | Frequency (MHz) | 6dB Bandwidth (MHz) | Limit (kHz) | Test Result |
|---------|-----------------|---------------------|-------------|-------------|
| Low | 2405 | 1.63 | >500 | PASS |
| Mid | 2445 | 1.62 | | PASS |
| High | 2470 | 1.73 | | PASS |

Test Plot

6dB Bandwidth (CH Low)

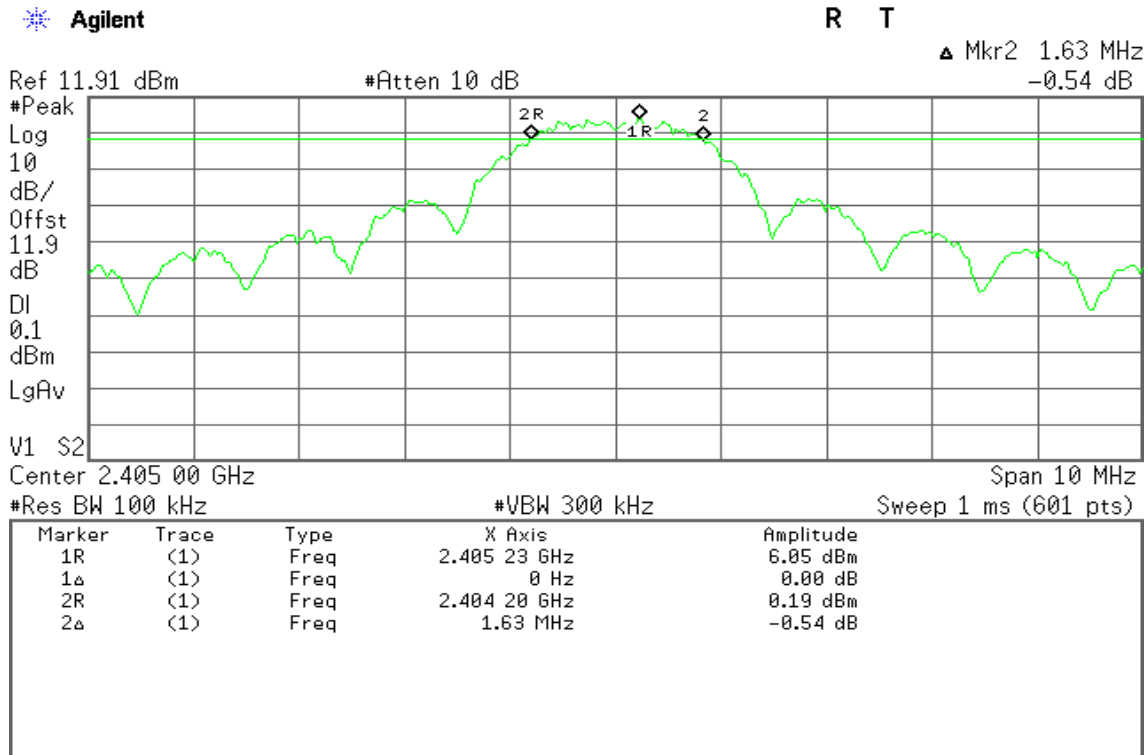

6dB Bandwidth (CH Mid)

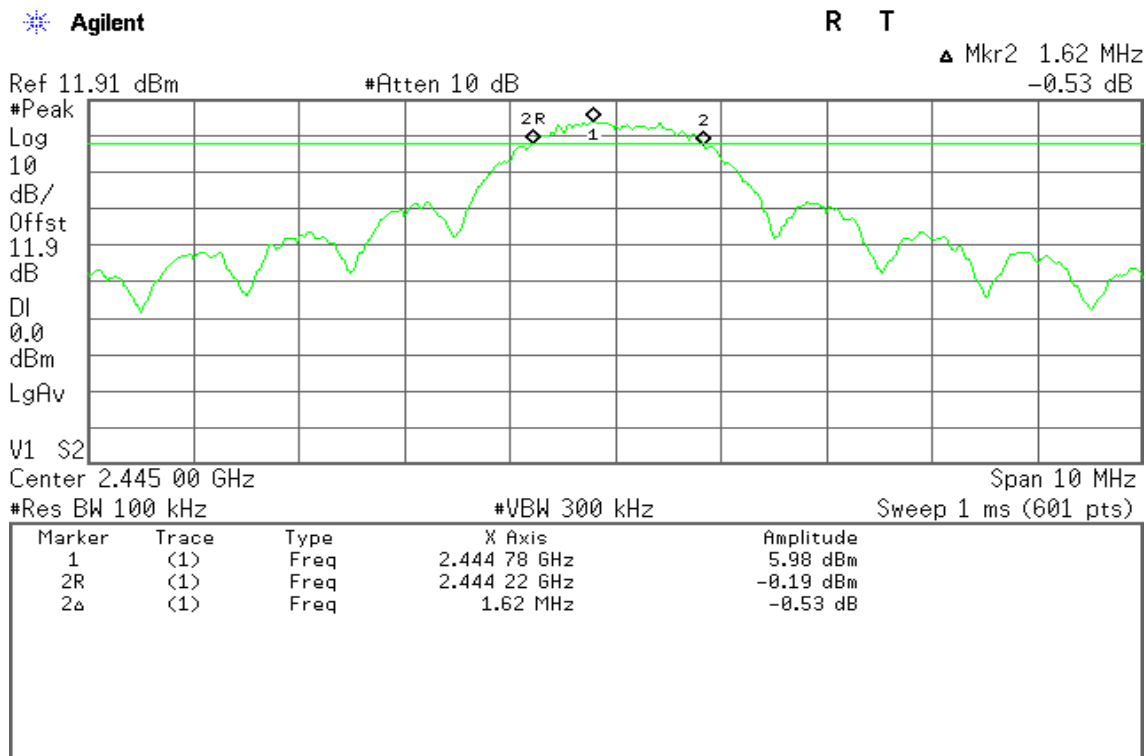

6dB Bandwidth (CH High)

Agilent

R T

▲ Mkr2 1.73 MHz
0.12 dB

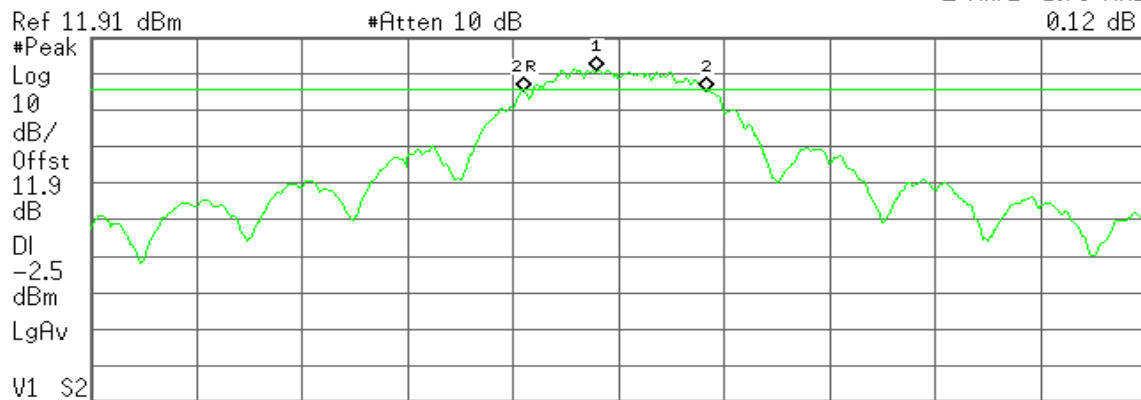

Center 2.480 00 GHz Span 10 MHz
#Res BW 100 kHz #VBW 300 kHz Sweep 1 ms (601 pts)

| Marker | Trace | Type | X Axis | Amplitude |
|--------|-------|------|--------------|-----------|
| 1 | (1) | Freq | 2.479 78 GHz | 2.61 dBm |
| 2R | (1) | Freq | 2.479 10 GHz | -2.88 dBm |
| 2▲ | (1) | Freq | 1.73 MHz | 0.12 dB |

7.2 PEAK POWER

LIMIT

The maximum peak output power of the intentional radiator shall not exceed the following:

1. According to §15.247(b)(3), for systems using digital modulation in the bands of 902-928 MHz, 2400-2483.5 MHz, and 5725-5850 MHz: 1 Watt.
2. According to §15.247(b)(4), the conducted output power limit specified in paragraph (b) of this section is based on the use of antennas with directional gains that do not exceed 6 dBi. Except as shown in paragraph (c) of this section, if transmitting antennas of directional gain greater than 6 dBi are used, the conducted output power from the intentional radiator shall be reduced below the stated values in paragraphs (b)(1), (b)(2), and (b)(3) of this section, as appropriate, by the amount in dB that the directional gain of the antenna exceeds 6 dBi.

Test Configuration

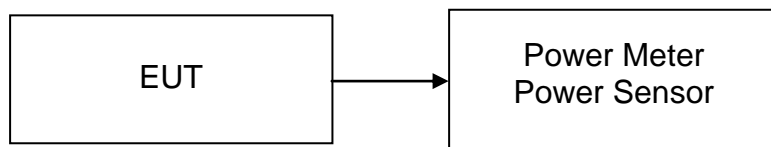

TEST PROCEDURE

The transmitter output is connected to the Power Meter. The Power Meter is set to the peak power detection.

TEST RESULTS

No non-compliance noted

Test Data

| Channel | Frequency (MHz) | Output Power (dBm) | Output Power (W) | Limit (W) | Test Result |
|---------|-----------------|--------------------|------------------|-----------|-------------|
| Low | 2405 | 8.99 | 0.0079 | 1 | PASS |
| Mid | 2445 | 9.28 | 0.0085 | | PASS |
| High | 2480 | -10.53 | 0.0001 | | PASS |

7.3 AVERAGE POWER

LIMIT

None; for reporting purposes only.

Test Configuration

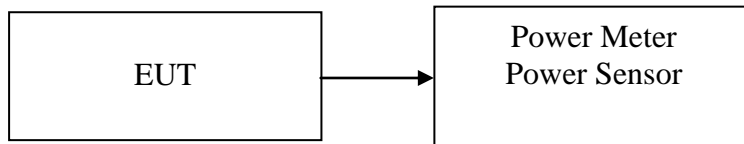

TEST PROCEDURE

The transmitter output is connected to the Power Meter. The Power Meter is set to the avg power detection.

TEST RESULTS

No non-compliance noted.

Test Data

| Channel | Frequency (MHz) | Output Power (dBm) | Output Power (W) |
|---------|-----------------|--------------------|------------------|
| Low | 2405 | 8.92 | 0.0078 |
| Mid | 2445 | 9.21 | 0.0083 |
| High | 2480 | -10.23 | 0.0001 |

7.4 BAND EDGES MEASUREMENT

LIMIT

According to §15.247(d), in any 100 kHz bandwidth outside the frequency bands in which the spread spectrum intentional radiator is operating, the radio frequency power that is produced by the intentional radiator shall be at least 20 dB below that in the 100 kHz bandwidth within the band that contains the highest level of the desired power, based on either an RF conducted or a radiated measurement, provided the transmitter demonstrates compliance with the peak conducted power limits. In addition, radiated emissions which fall in the restricted bands, as defined in §15.205(a), must also comply with the radiated emission limits specified in 15.209(a) (see Section 15.205(c)).

Test Configuration

For Radiated

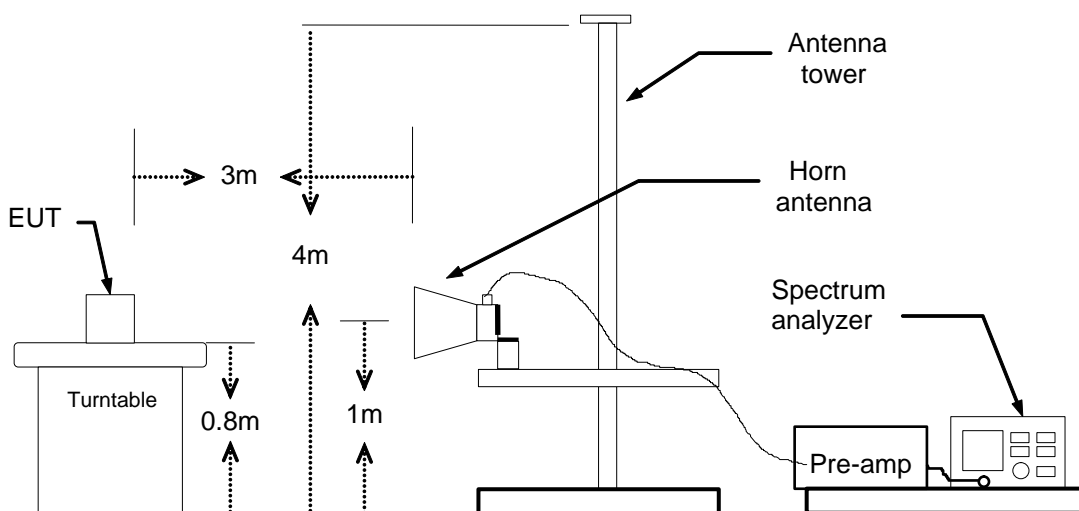

For Conducted

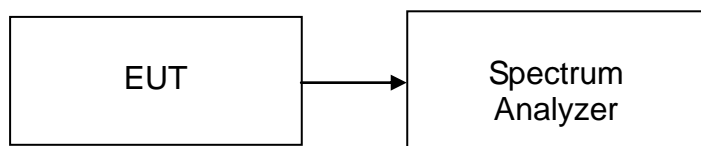

TEST PROCEDURE

For Radiated

1. The EUT is placed on a turntable, which is 0.8m above the ground plane.
2. The turntable shall be rotated for 360 degrees to determine the position of maximum emission level.
3. EUT is set 3m away from the receiving antenna, which is varied from 1m to 4m to find out the highest emission.
4. Set the spectrum analyzer in the following setting in order to capture the lower and upper band-edges of the emission:
 - (a) PEAK: RBW=1MHz / VBW=3MHz / Sweep=AUTO
 - (b) AVERAGE: RBW=1MHz / VBW= 300Hz / Sweep=AUTO
5. Repeat the procedures until all the PEAK and AVERAGE versus POLARIZATION are measured.

For Conducted

Conducted RF measurements of the transmitter output were made to confirm that the EUT antenna port conducted emissions meet the specified limit and to identify any spurious signals that require further investigation or measurements on the radiated emissions site.

The transmitter output is connected to the spectrum analyzer. The resolution bandwidth is set to 100 kHz. The video bandwidth is set to 100 kHz.

TEST RESULTS

Refer to attach spectrum analyzer data chart.

Band Edges (CH Low)

Polarity: Vertical

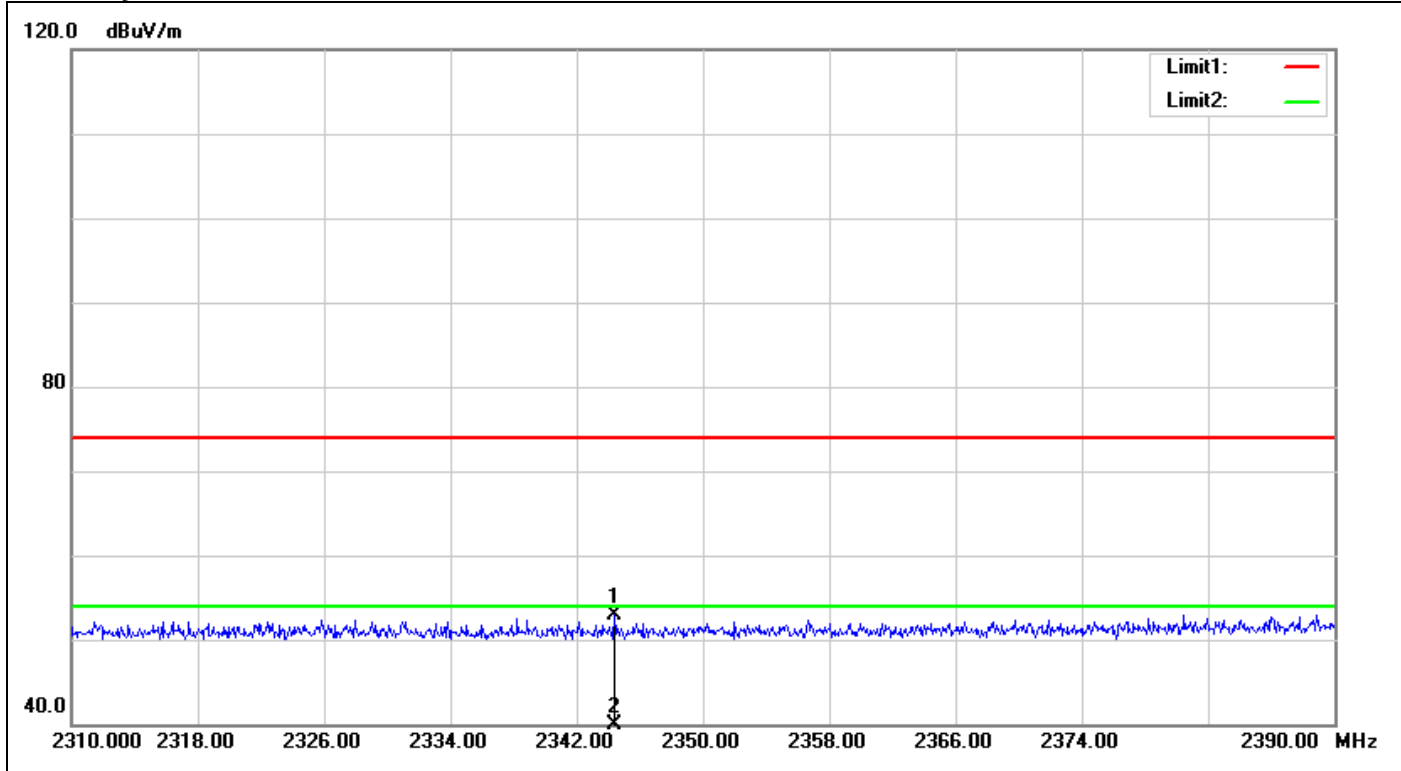

| No. | Frequency (MHz) | Reading (dBuV) | Correct Factor(dB/m) | Result (dBuV/m) | Limit (dBuV/m) | Margin (dB) | Height (cm) | Degree (°) | Remark |
|-----|-----------------|----------------|----------------------|-----------------|----------------|-------------|-------------|------------|--------|
| 1 | 2344.400 | 55.86 | -2.89 | 52.97 | 74.00 | -21.03 | 100 | 336 | peak |
| 2 | 2344.400 | 42.08 | -2.89 | 39.19 | 54.00 | -14.81 | 100 | 336 | AVG |

Polarity: Horizontal

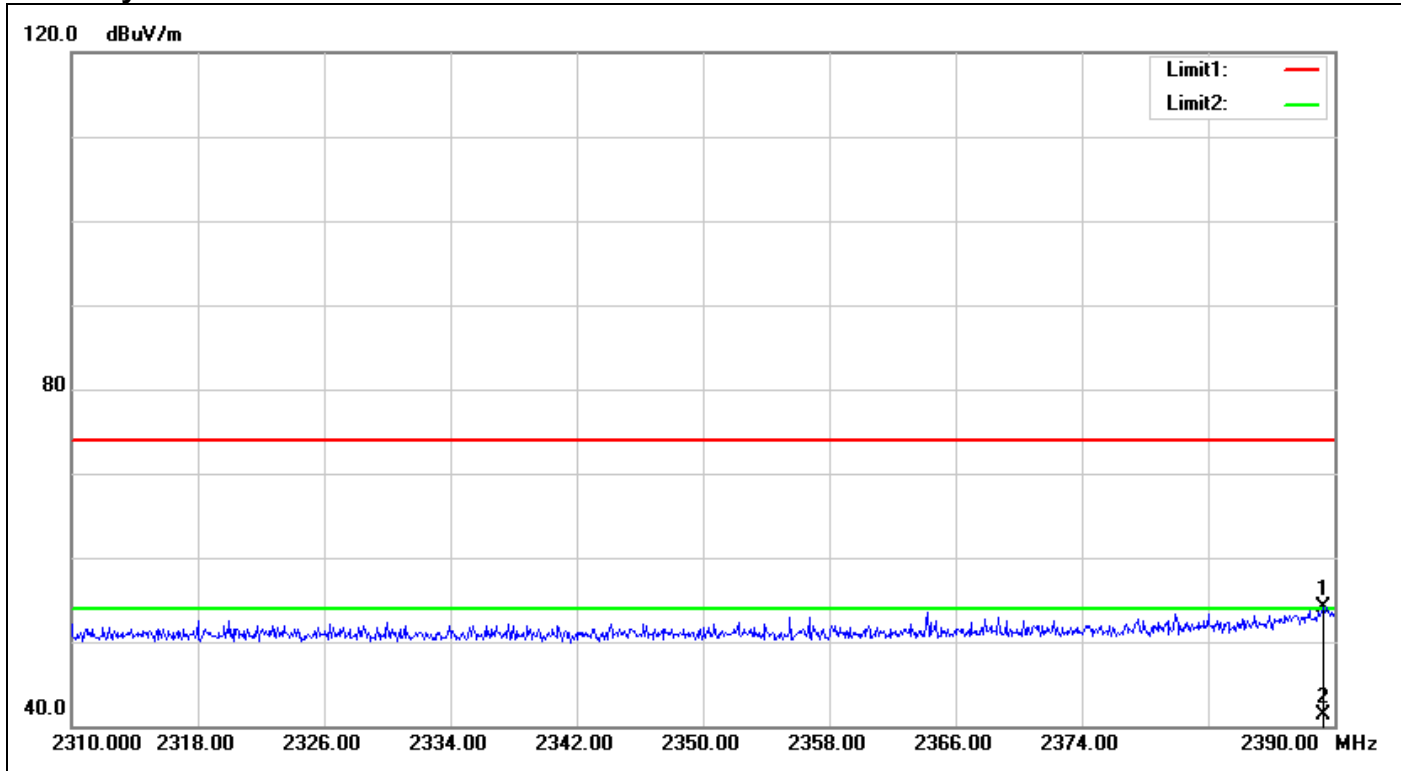

| No. | Frequency (MHz) | Reading (dBuV) | Correct Factor(dB/m) | Result (dBuV/m) | Limit (dBuV/m) | Margin (dB) | Height (cm) | Degree (°) | Remark |
|-----|--------------------|-------------------|-------------------------|--------------------|-------------------|----------------|----------------|-----------------|--------|
| 1 | 2389.280 | 56.67 | -2.50 | 54.17 | 74.00 | -19.83 | 100 | 360 | peak |
| 2 | 2389.280 | 43.85 | -2.50 | 41.35 | 54.00 | -12.65 | 100 | 360 | AVG |

Band Edges (CH High)

Polarity: Vertical

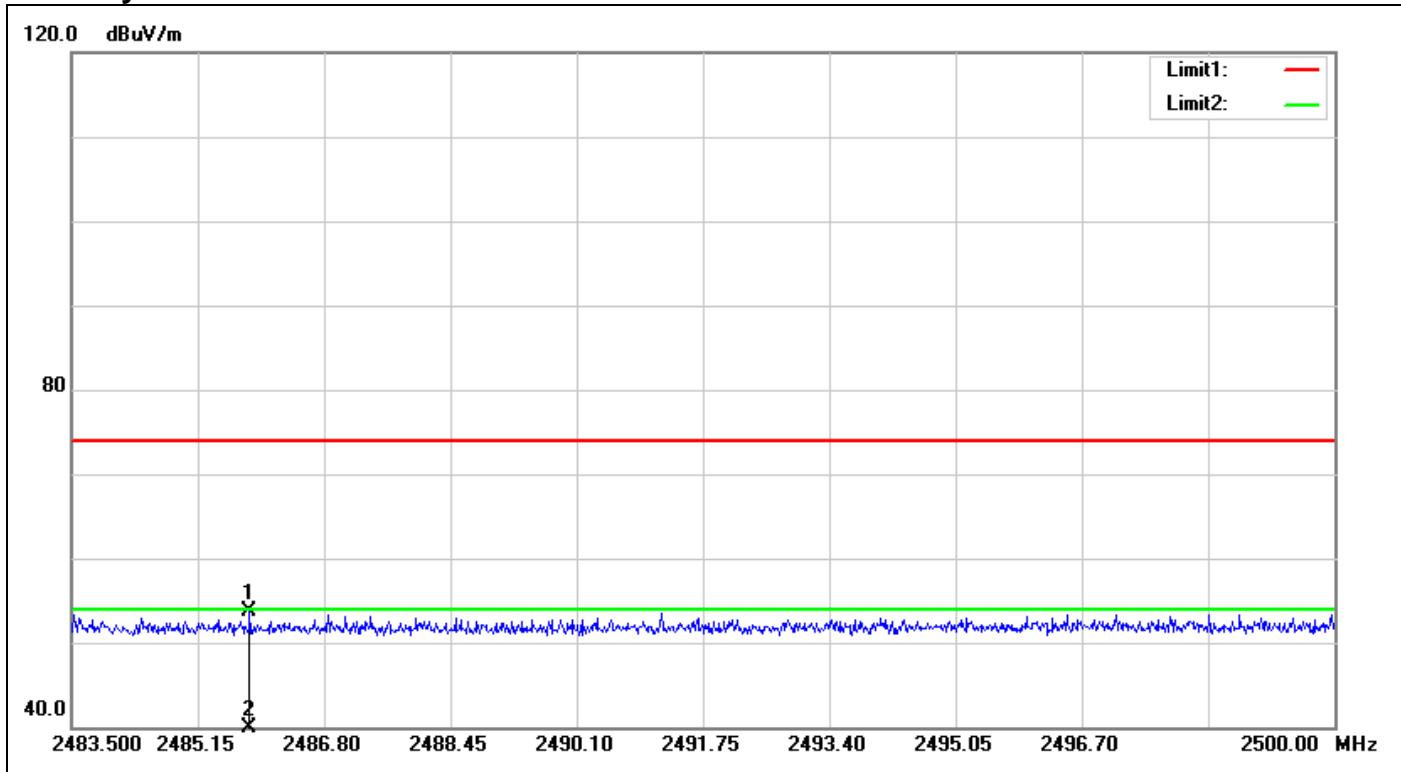

| No. | Frequency (MHz) | Reading (dBuV) | Correct Factor(dB/m) | Result (dBuV/m) | Limit (dBuV/m) | Margin (dB) | Height (cm) | Degree (°) | Remark |
|-----|-----------------|----------------|----------------------|-----------------|----------------|-------------|-------------|------------|--------|
| 1 | 2485.827 | 55.62 | -1.97 | 53.65 | 74.00 | -20.35 | 100 | 177 | peak |
| 2 | 2485.827 | 41.34 | -1.97 | 39.37 | 54.00 | -14.63 | 100 | 177 | AVG |

Polarity: Horizontal

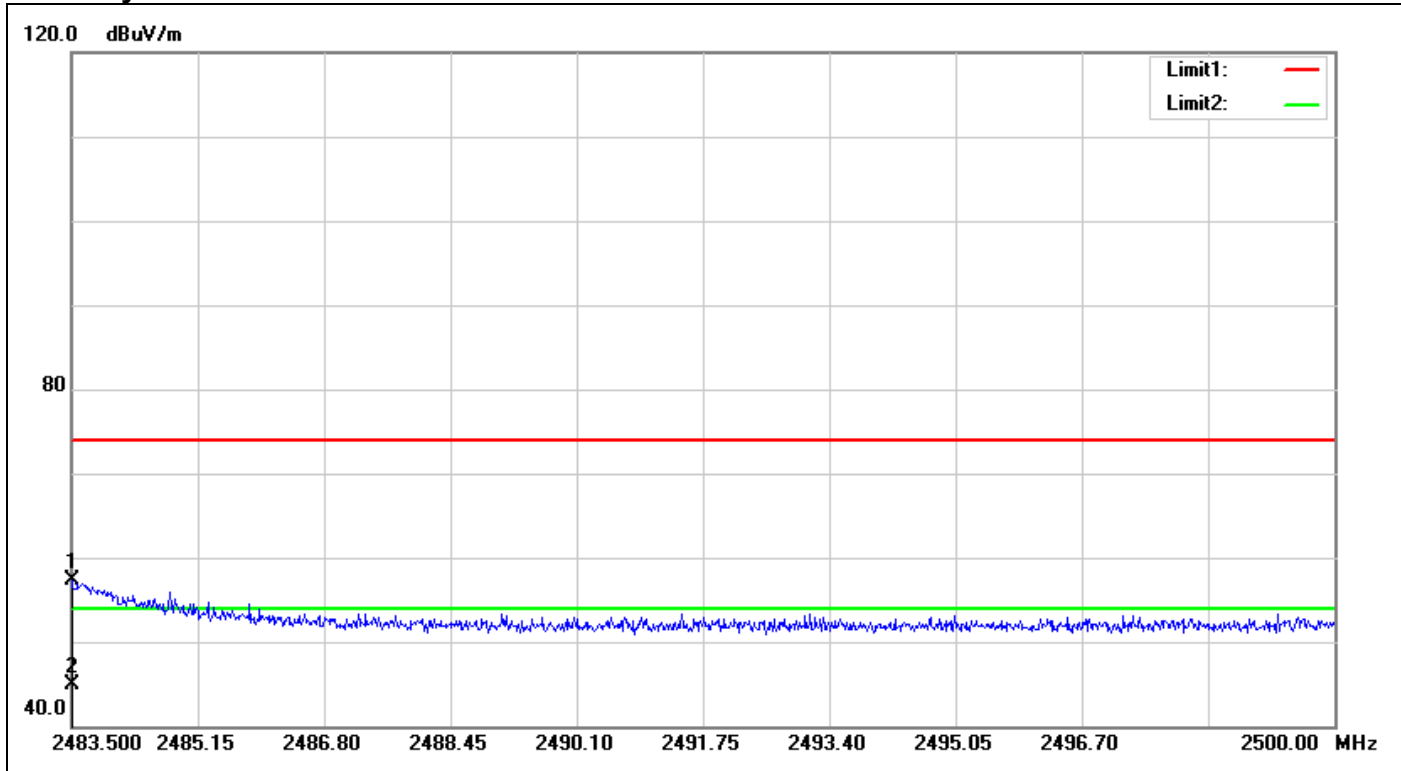

| No. | Frequency (MHz) | Reading (dBuV) | Correct Factor(dB/m) | Result (dBuV/m) | Limit (dBuV/m) | Margin (dB) | Height (cm) | Degree (°) | Remark |
|-----|-----------------|----------------|----------------------|-----------------|----------------|-------------|-------------|------------|--------|
| 1 | 2483.500 | 59.35 | -1.99 | 57.36 | 74.00 | -16.64 | 100 | 24 | peak |
| 2 | 2483.500 | 46.90 | -1.99 | 44.91 | 54.00 | -9.09 | 100 | 24 | AVG |

Conducted Band Edges

CH Low

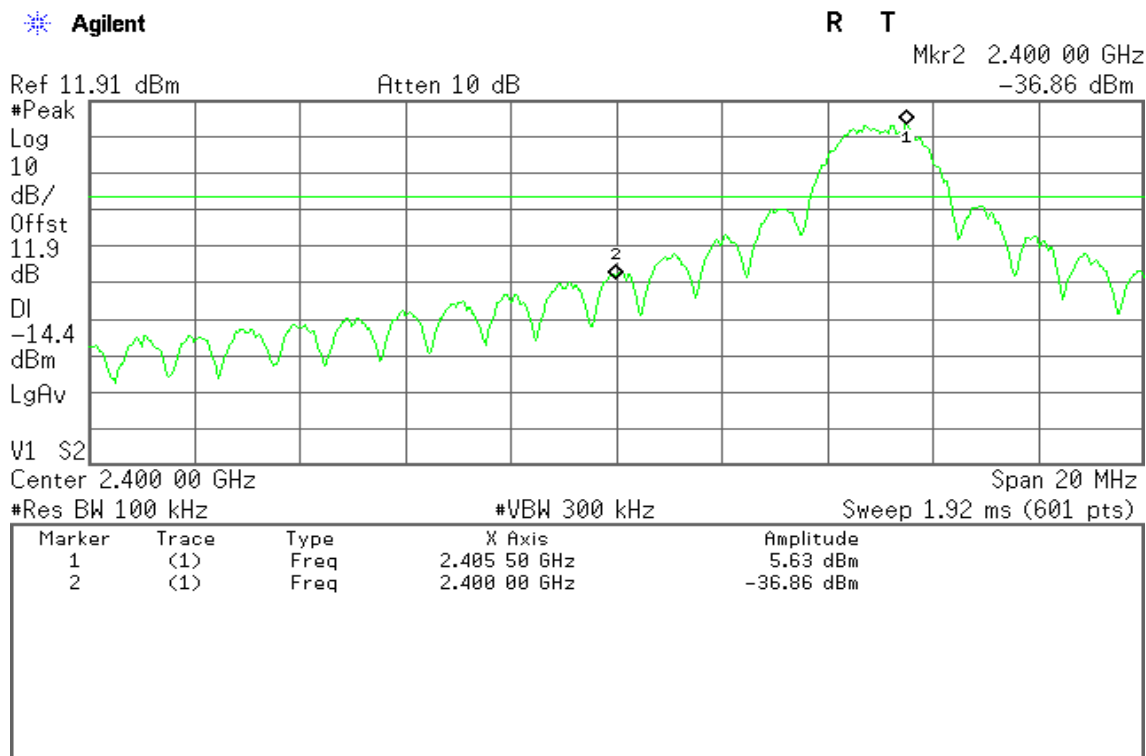

CH High

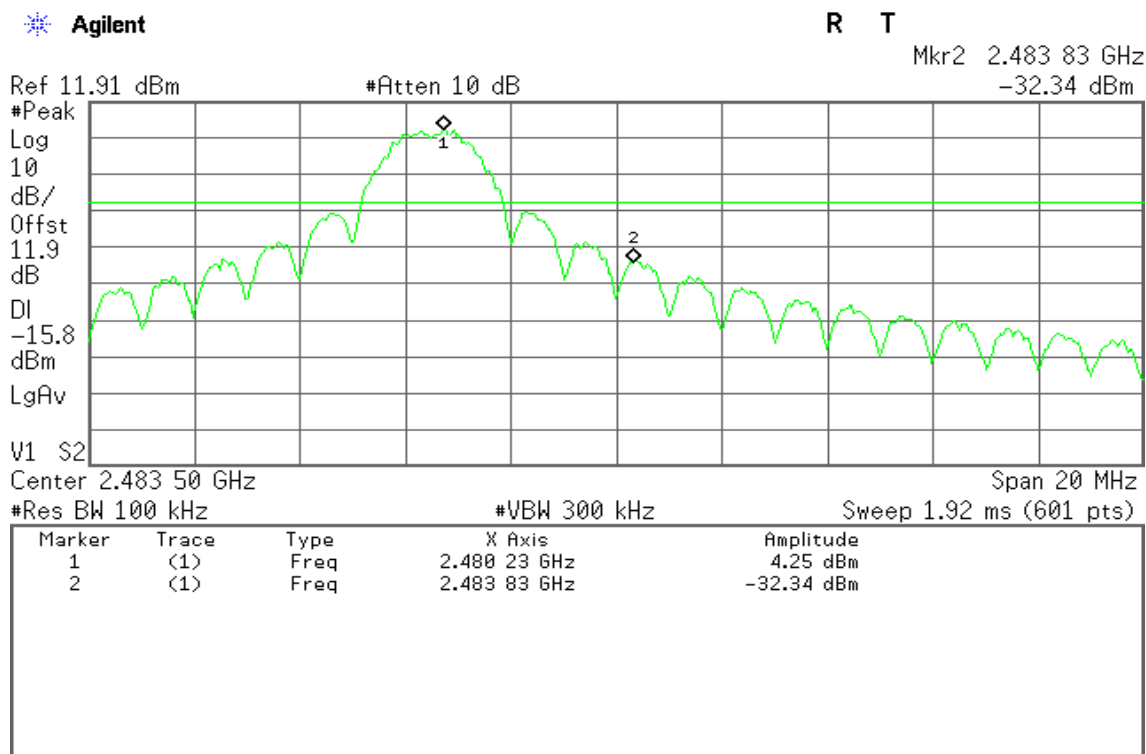

7.5 PEAK POWER SPECTRAL DENSITY

LIMIT

1. According to §15.247(e), for digitally modulated systems, the power spectral density conducted from the intentional radiator to the antenna shall not be greater than 8 dBm in any 3 kHz band during any time interval of continuous transmission.
2. According to §15.247(f), the digital modulation operation of the hybrid system, with the frequency hopping turned off, shall comply with the power density requirements of paragraph (d) of this section.

Test Configuration

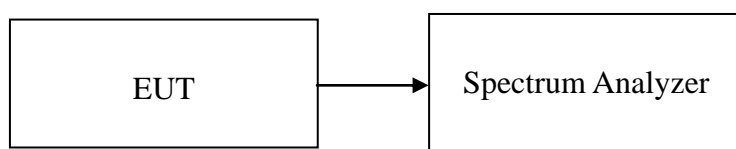

TEST PROCEDURE

The transmitter output is connected to a spectrum analyzer. Set the RBW = 100 kHz, VBW ≥ 300 kHz, span to 1.5 times the DTS bandwidth, Detector = peak, Trace mode = max hold, Sweep = auto couple. Use the peak marker function to determine the maximum amplitude level within the RBW. If measured value exceeds limit, reduce RBW (no less than 3 kHz).

TEST RESULTS

No non-compliance noted

Test Data

| Channel | Frequency (MHz) | PPSD (dBm) | Limit (dBm) | Test Result |
|---------|-----------------|------------|-------------|-------------|
| Low | 2405 | -6.30 | 8.00 | PASS |
| Mid | 2445 | -4.00 | | PASS |
| High | 2480 | -9.40 | | PASS |

Test Plot

PPSD (CH Low)

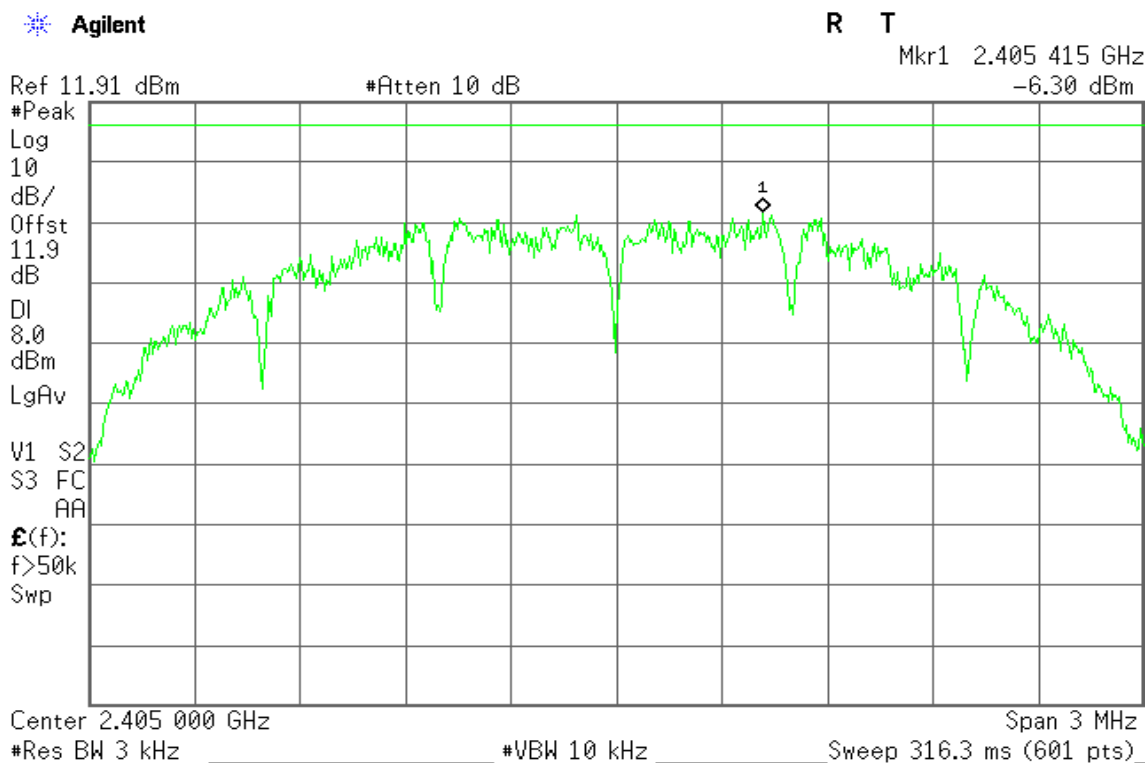

PPSD (CH Mid)

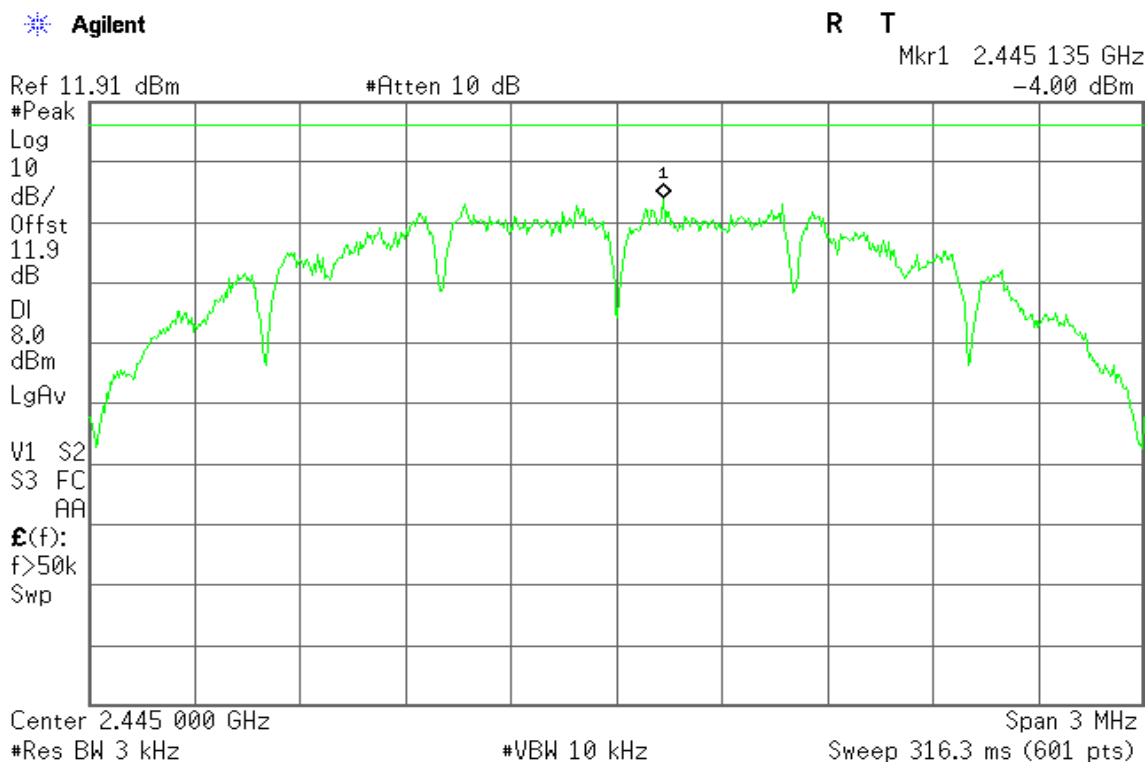

PPSD (CH High)

Agilent

R T

Mkr1 2.479 885 GHz
-9.40 dBm

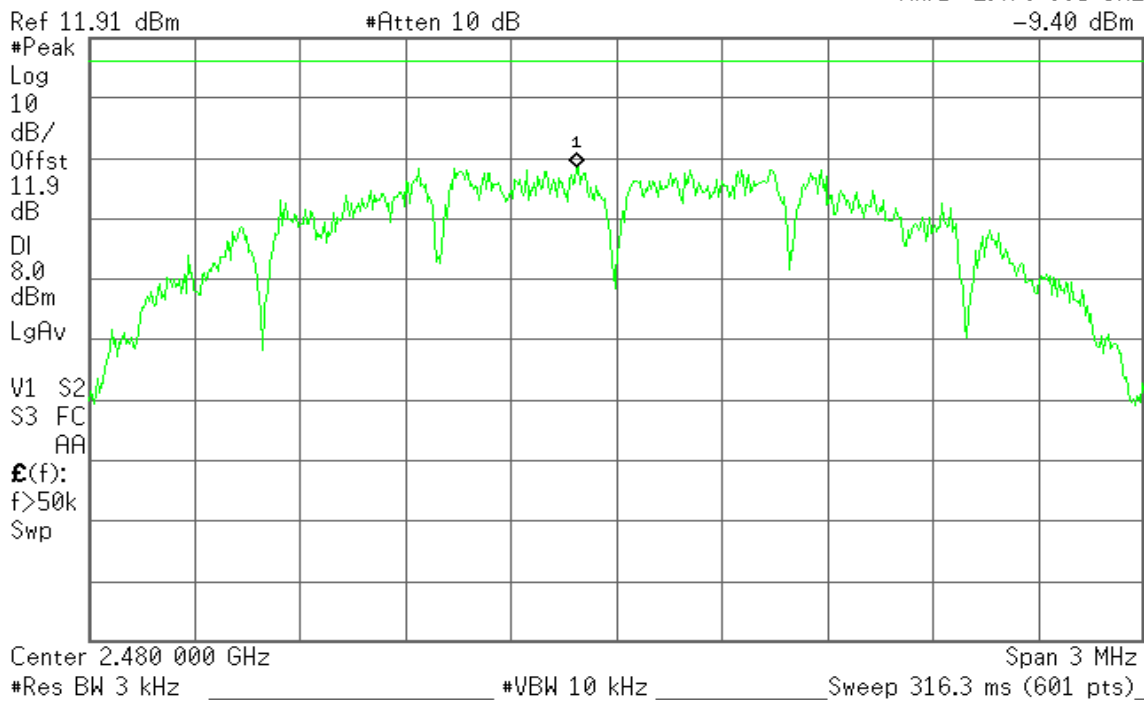

7.6 SPURIOUS EMISSIONS

7.6.1 Conducted Measurement

LIMIT

According to §15.247(d), in any 100 kHz bandwidth outside the frequency bands in which the spread spectrum intentional radiator is operating, the radio frequency power that is produced by the intentional radiator shall be at least 20 dB below that in the 100 kHz bandwidth within the band that contains the highest level of the desired power, based on either an RF conducted or a radiated measurement, provided the transmitter demonstrates compliance with the peak conducted power limits. In addition, radiated emissions which fall in the restricted bands, as defined in §15.205(a), must also comply with the radiated emission limits specified in 15.209(a) (see Section 15.205(c)).

Test Configuration

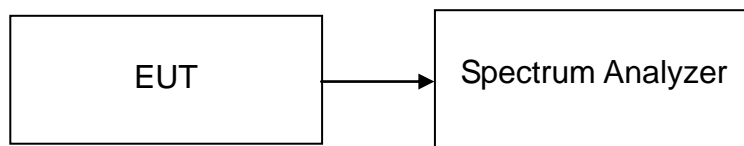

TEST PROCEDURE

Conducted RF measurements of the transmitter output were made to confirm that the EUT antenna port conducted emissions meet the specified limit and to identify any spurious signals that require further investigation or measurements on the radiated emissions site.

The transmitter output is connected to the spectrum analyzer. The resolution bandwidth is set to 100 kHz. The video bandwidth is set to 100 kHz.

Measurements are made over the 30MHz to 26GHz range with the transmitter set to the lowest, middle, and highest channels.

TEST RESULTS

No non-compliance noted

Test Plot

CH Low

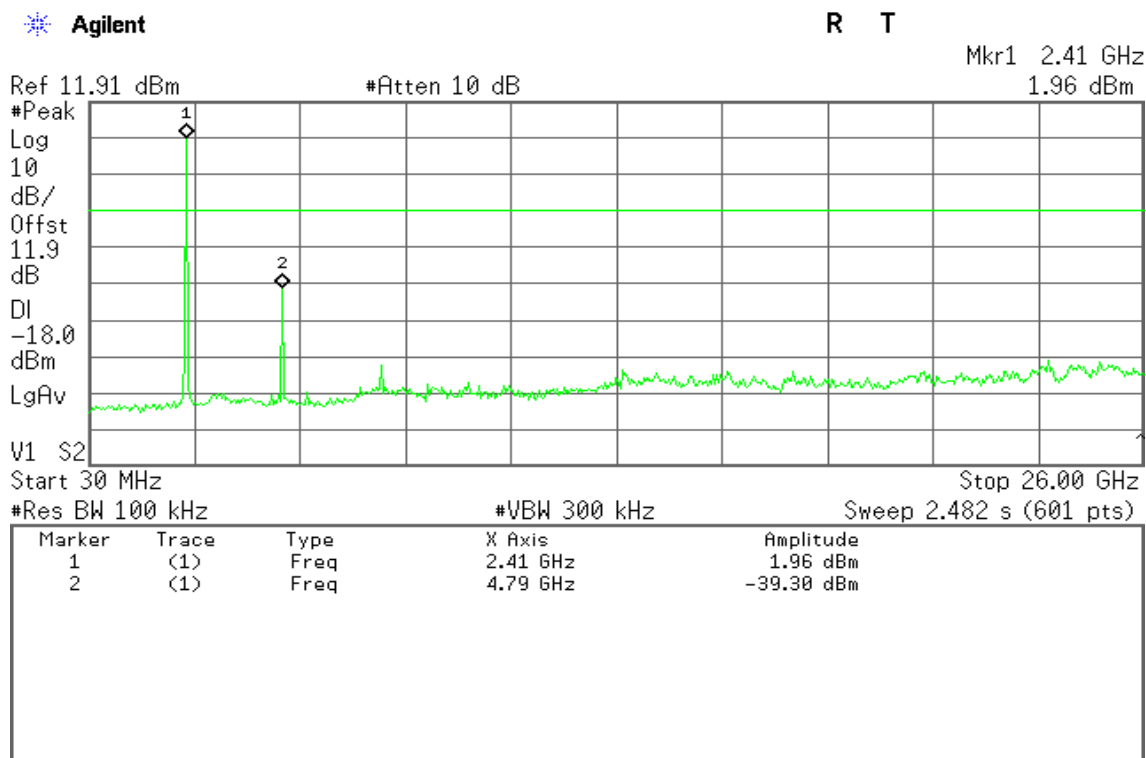

CH Mid

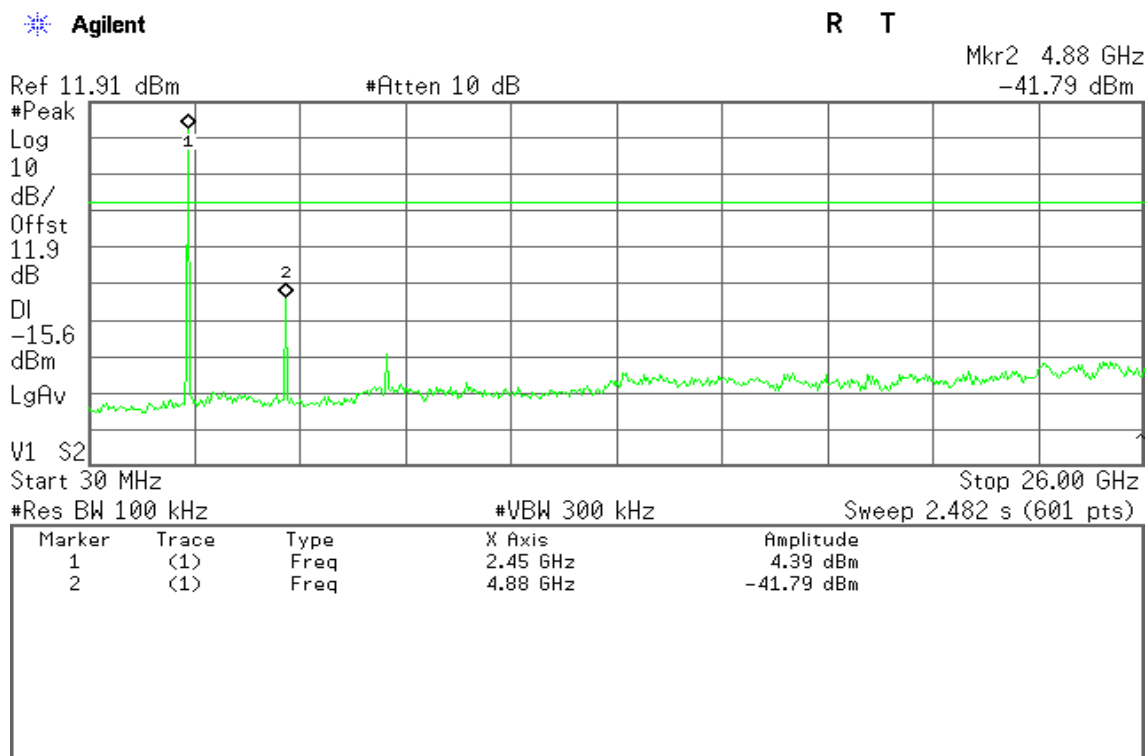

CH High

Agilent

R T

Mkr2 4.96 GHz
 -50.43 dBm

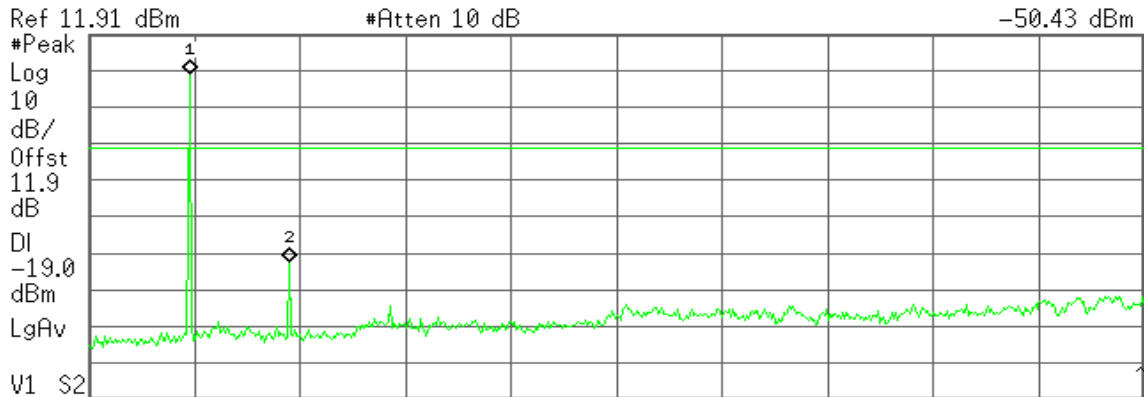

| Marker | Trace | Type | X Axis | Amplitude |
|--------|-------|------|----------|------------|
| 1 | (1) | Freq | 2.50 GHz | 0.95 dBm |
| 2 | (1) | Freq | 4.96 GHz | -50.43 dBm |

7.6.2 Radiated Emissions

LIMIT

1. According to §15.209(a), except as provided elsewhere in this Subpart, the emissions from an intentional radiator shall not exceed the field strength levels specified in the following table:

| Frequency (MHz) | Field Strength (µV/m) | Measurement Distance (m) |
|-----------------|-----------------------|--------------------------|
| 0.009 - 0.490 | 2400/F(kHz) | 300 |
| 0.490 - 1.705 | 24000/F(kHz) | 30 |
| 1.705 – 30.0 | 30 | 30 |
| 30-88 | 100 | 3 |
| 88-216 | 150 | 3 |
| 216-960 | 200 | 3 |
| Above 960 | 500 | 3 |

Remark: Except as provided in paragraph (g), fundamental emissions from intentional radiators operating under this Section shall not be located in the frequency bands 54-72 MHz, 76-88 MHz, 174-216 MHz or 470-806 MHz. However, operation within these frequency bands is permitted under other sections of this Part, e.g., Sections 15.231 and 15.241.

2. In the emission table above, the tighter limit applies at the band edges.

| Frequency (MHz) | Field Strength (µV/m at 3-meter) | Field Strength (dBµV/m at 3-meter) |
|-----------------|----------------------------------|------------------------------------|
| 0.009 - 0.490 | 2400/F(kHz) +80 | 20LOG((2400/F(kHz))+80) |
| 0.490 - 1.705 | 24000/F(kHz) +40 | 20LOG((24000/F(kHz))+40) |
| 1.705 – 30.0 | 30 | 69.54 |
| 30-88 | 100 | 40 |
| 88-216 | 150 | 43.5 |
| 216-960 | 200 | 46 |
| Above 960 | 500 | 54 |

Test Configuration

9kHz ~ 30MHz

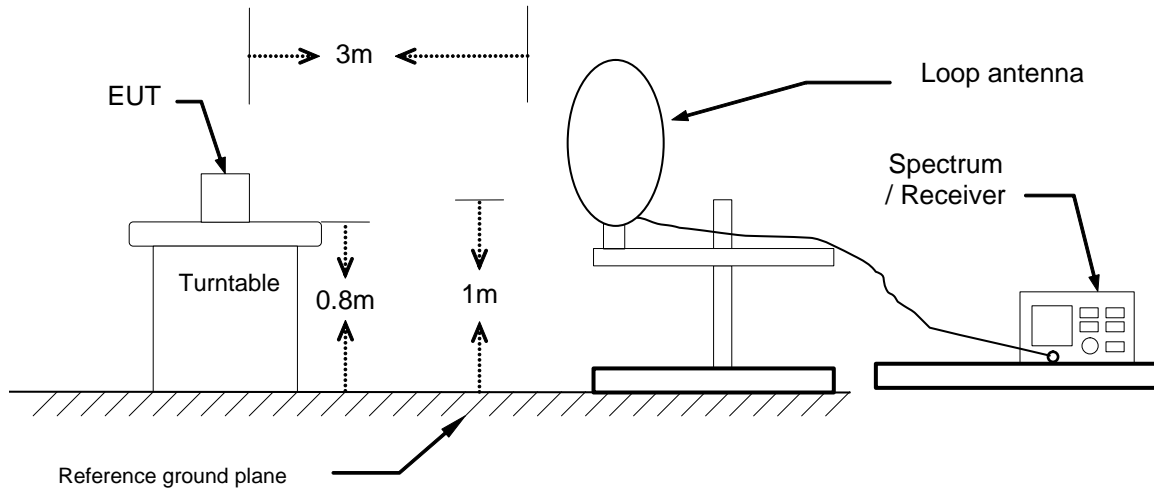

30MHz ~ 1GHz

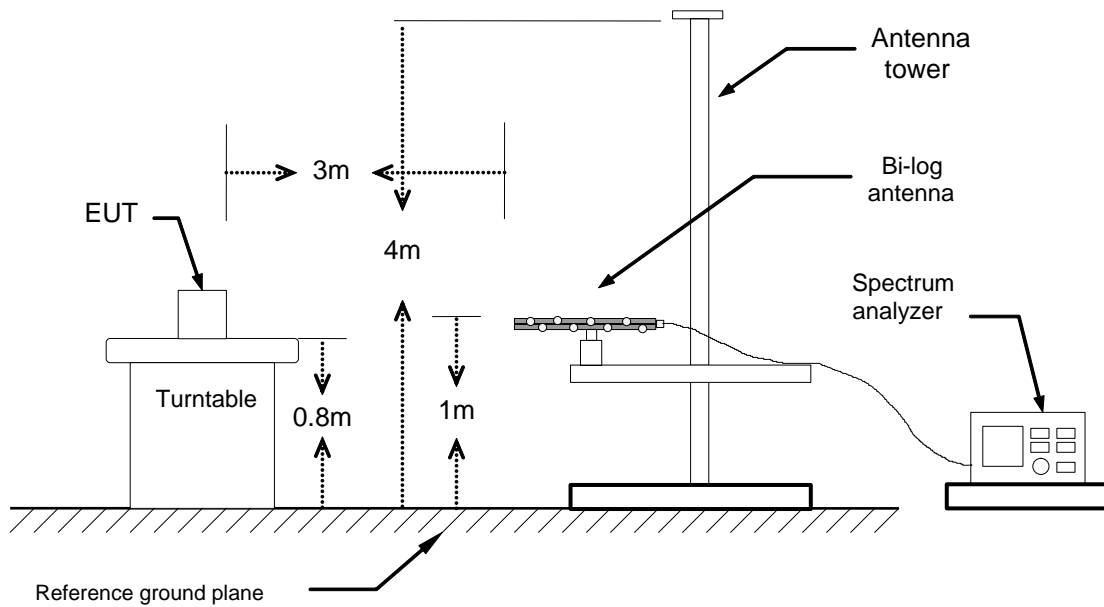

Above 1 GHz

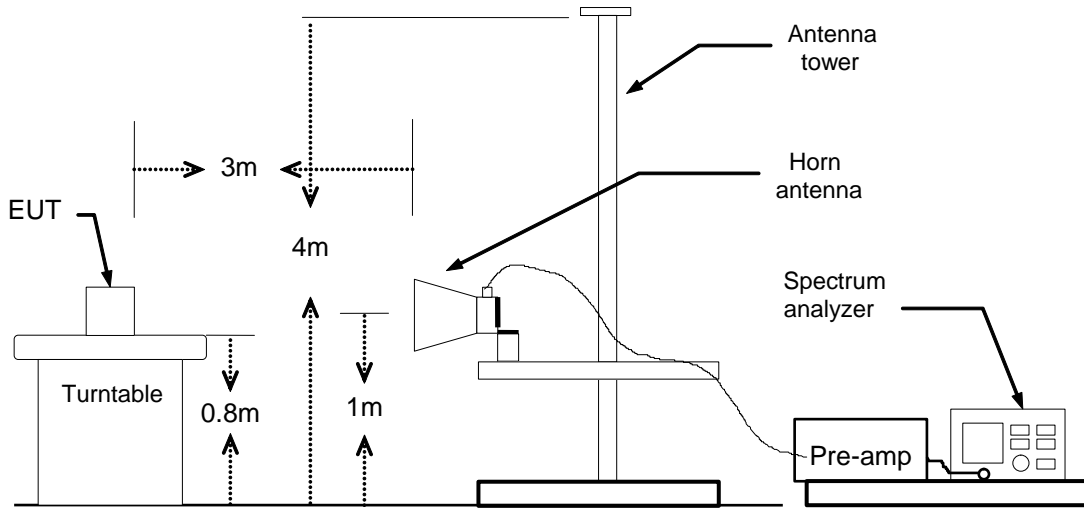

TEST PROCEDURE

1. The EUT is placed on a turntable, which is 0.8m above ground plane.
2. The turntable shall be rotated for 360 degrees to determine the position of maximum emission level.
3. EUT is set 3m away from the receiving antenna, which is varied from 1m to 4m to find out the highest emissions.
4. Maximum procedure was performed on the six highest emissions to ensure EUT compliance.
5. And also, each emission was to be maximized by changing the polarization of receiving antenna both horizontal and vertical.
6. Set the spectrum analyzer in the following setting as:
Below 1GHz:
 RBW=100kHz / VBW=300kHz / Sweep=AUTO
Above 1GHz:
 (a) PEAK: RBW=VBW=1MHz / Sweep=AUTO
 (b) AVERAGE: RBW=1MHz / VBW=300Hz / Sweep=AUTO
7. Repeat above procedures until the measurements for all frequencies are complete.

Below 1 GHz

Operation Mode: Normal Link

Test Date: June 29, 2015

Temperature: 27°C

Tested by: Jason Lu

Humidity: 53 % RH

Polarity: Ver. / Hor.

| Frequency (MHz) | Reading (dBuV) | Correction Factor (dB/m) | Result (dBuV/m) | Limit (dBuV/m) | Margin (dB) | Remark | Ant.Pol. (H/V) |
|-----------------|----------------|--------------------------|-----------------|----------------|-------------|--------|----------------|
| 50.3700 | 51.75 | -22.94 | 28.81 | 40.00 | -11.19 | Peak | V |
| 184.2300 | 47.91 | -18.97 | 28.94 | 43.50 | -14.56 | Peak | V |
| 280.2600 | 48.30 | -16.76 | 31.54 | 46.00 | -14.46 | Peak | V |
| 458.7400 | 39.98 | -12.51 | 27.47 | 46.00 | -18.53 | Peak | V |
| 666.3200 | 44.19 | -9.14 | 35.05 | 46.00 | -10.95 | Peak | V |
| 749.7400 | 36.70 | -7.88 | 28.82 | 46.00 | -17.18 | Peak | V |
| 51.3400 | 43.62 | -23.04 | 20.58 | 40.00 | -19.42 | Peak | H |
| 184.2300 | 40.74 | -18.97 | 21.77 | 43.50 | -21.73 | Peak | H |
| 280.2600 | 53.26 | -16.76 | 36.50 | 46.00 | -9.50 | Peak | H |
| 320.0300 | 49.41 | -15.92 | 33.49 | 46.00 | -12.51 | Peak | H |
| 666.3200 | 44.00 | -9.14 | 34.86 | 46.00 | -11.14 | Peak | H |
| 749.7400 | 41.13 | -7.88 | 33.25 | 46.00 | -12.75 | Peak | H |

Remark:

1. *No emission found between lowest internal used/generated frequency to 30MHz (9kHz~30MHz)*
2. *Radiated emissions measured in frequency range from 30 MHz to 1000MHz were made with an instrument using peak/quasi-peak detector mode.*
3. *Quasi-peak test would be performed if the peak result were greater than the quasi-peak limit or as required by the applicant.*
4. *Measurements above show only up to 6 maximum emissions noted, or would be lesser, with " N/A " remark, if no specific emissions from the EUT are recorded (ie: margin>20dB from the applicable limit) and considered that's already beyond the background noise floor.*
5. *Margin (dB) = Remark result (dBuV/m) – Quasi-peak limit (dBuV/m).*

Above 1 GHz

Operation Mode: Zigbee / TX / CH Low

Test Date: June 29, 2015

Temperature: 27°C

Tested by: Jason Lu

Humidity: 53 % RH

Polarity: Ver. / Hor.

| Frequency (MHz) | Reading (dBuV) | Correction (dB/m) | Result (dBuV/m) | Limit (dBuV/m) | Margin (dB) | Remark | Ant.Pol. (H/V) |
|-----------------|----------------|-------------------|-----------------|----------------|-------------|--------|----------------|
| 2048.000 | 54.41 | -3.65 | 50.76 | 74.00 | -23.24 | peak | V |
| 4810.000 | 52.78 | 5.06 | 57.84 | 74.00 | -16.16 | peak | V |
| 4810.000 | 45.05 | 5.06 | 50.11 | 54.00 | -3.89 | AVG | V |
| N/A | | | | | | | |
| | | | | | | | |
| | | | | | | | |
| 1810.000 | 53.94 | -4.58 | 49.36 | 74.00 | -24.64 | peak | H |
| 4810.000 | 52.05 | 5.06 | 57.11 | 74.00 | -16.89 | peak | H |
| 4810.000 | 44.30 | 5.06 | 49.36 | 54.00 | -4.64 | AVG | H |
| N/A | | | | | | | |
| | | | | | | | |
| | | | | | | | |

Remark:

1. *Measuring frequencies from 1 GHz to the 10th harmonic of highest fundamental frequency.*
2. *Radiated emissions measured in frequency above 1000MHz were made with an instrument using peak/average detector mode.*
3. *Average test would be performed if the peak result were greater than the average limit or as required by the applicant.*
4. *Data of measurement within this frequency range shown " --- " in the table above means the reading of emissions are attenuated more than 20dB below the permissible limits or the field strength is too small to be measured.*
5. *Measurements above show only up to 6 maximum emissions noted, or would be lesser, with " N/A " remark, if no specific emissions from the EUT are recorded (ie: margin>20dB from the applicable limit) and considered that's already beyond the background noise floor.*
6. *Margin (dB) = Remark result (dBuV/m) – Average limit (dBuV/m).*

Operation Mode: Zigbee / TX / CH Mid

Test Date: June 29, 2015

Temperature: 27°C

Tested by: Jason Lu

Humidity: 53 % RH

Polarity: Ver. / Hor.

| Frequency (MHz) | Reading (dBuV) | Correction (dB/m) | Result (dBuV/m) | Limit (dBuV/m) | Margin (dB) | Remark | Ant.Pol. (H/V) |
|-----------------|----------------|-------------------|-----------------|----------------|-------------|--------|----------------|
| 2024.000 | 54.43 | -3.62 | 50.81 | 74.00 | -23.19 | peak | V |
| 4890.000 | 50.34 | 5.28 | 55.62 | 74.00 | -18.38 | peak | V |
| 4890.000 | 42.15 | 5.28 | 47.43 | 54.00 | -6.57 | AVG | V |
| N/A | | | | | | | |
| | | | | | | | |
| | | | | | | | |
| 2018.000 | 53.75 | -3.62 | 50.13 | 74.00 | -23.87 | peak | H |
| 4890.000 | 51.43 | 5.28 | 56.71 | 74.00 | -17.29 | peak | H |
| 4890.000 | 43.36 | 5.28 | 48.64 | 54.00 | -5.36 | AVG | H |
| N/A | | | | | | | |
| | | | | | | | |
| | | | | | | | |

Remark:

1. *Measuring frequencies from 1 GHz to the 10th harmonic of highest fundamental frequency.*
2. *Radiated emissions measured in frequency above 1000MHz were made with an instrument using peak/average detector mode.*
3. *Average test would be performed if the peak result were greater than the average limit or as required by the applicant.*
4. *Data of measurement within this frequency range shown “ --- ” in the table above means the reading of emissions are attenuated more than 20dB below the permissible limits or the field strength is too small to be measured.*
5. *Measurements above show only up to 6 maximum emissions noted, or would be lesser, with “ N/A ” remark, if no specific emissions from the EUT are recorded (ie: margin>20dB from the applicable limit) and considered that's already beyond the background noise floor.*
6. *Margin (dB) = Remark result (dBuV/m) – Average limit (dBuV/m).*

Operation Mode: Zigbee / TX / CH High

Test Date: June 29, 2015

Temperature: 27°C

Tested by: Jason Lu

Humidity: 53 % RH

Polarity: Ver. / Hor.

| Frequency (MHz) | Reading (dBuV) | Correction (dB/m) | Result (dBuV/m) | Limit (dBuV/m) | Margin (dB) | Remark | Ant.Pol. (H/V) |
|-----------------|----------------|-------------------|-----------------|----------------|-------------|--------|----------------|
| 2042.000 | 55.06 | -3.64 | 51.42 | 74.00 | -22.58 | peak | V |
| 4960.000 | 45.27 | 5.46 | 50.73 | 74.00 | -23.27 | peak | V |
| N/A | | | | | | | |
| | | | | | | | |
| | | | | | | | |
| | | | | | | | |
| 1900.000 | 53.49 | -4.12 | 49.37 | 74.00 | -24.63 | peak | H |
| 4960.000 | 48.63 | 5.46 | 54.09 | 74.00 | -19.91 | peak | H |
| 4960.000 | 38.66 | 5.46 | 44.12 | 54.00 | -9.88 | AVG | H |
| N/A | | | | | | | |
| | | | | | | | |
| | | | | | | | |

Remark:

1. *Measuring frequencies from 1 GHz to the 10th harmonic of highest fundamental frequency.*
2. *Radiated emissions measured in frequency above 1000MHz were made with an instrument using peak/average detector mode.*
3. *Average test would be performed if the peak result were greater than the average limit or as required by the applicant.*
4. *Data of measurement within this frequency range shown “ --- ” in the table above means the reading of emissions are attenuated more than 20dB below the permissible limits or the field strength is too small to be measured.*
5. *Measurements above show only up to 6 maximum emissions noted, or would be lesser, with “ N/A ” remark, if no specific emissions from the EUT are recorded (ie: margin>20dB from the applicable limit) and considered that's already beyond the background noise floor.*
6. *Margin (dB) = Remark result (dBuV/m) – Average limit (dBuV/m).*

7.7 POWERLINE CONDUCTED EMISSIONS

LIMIT

According to §15.207(a), except as shown in paragraphs (b) and (c) of this section, for an intentional radiator that is designed to be connected to the public utility (AC) power line, the radio frequency voltage that is conducted back onto the AC power line on any frequency or frequencies within the band 150 kHz to 30 MHz shall not exceed the limits in the following table, as measured using a 50 μ H/50 ohms line impedance stabilization network (LISN). Compliance with the provisions of this paragraph shall be based on the measurement of the radio frequency voltage between each power line and ground at the power terminal. The lower limit applies at the boundary between the frequency ranges.

| Frequency Range (MHz) | Limits (dB μ V) | |
|-----------------------|---------------------|-----------|
| | Quasi-peak | Average |
| 0.15 to 0.50 | 66 to 56* | 56 to 46* |
| 0.50 to 5 | 56 | 46 |
| 5 to 30 | 60 | 50 |

Test Configuration

See test photographs attached in Appendix II for the actual connections between EUT and support equipment.

TEST PROCEDURE

1. The EUT was placed on a table, which is 0.8m above ground plane.
2. Maximum procedure was performed on the six highest emissions to ensure EUT compliance.
3. Repeat above procedures until all frequency measured were complete.

TEST RESULTS

The initial step in collecting conducted data is a spectrum analyzer peak scan of the measurement range. Significant peaks are then marked as shown on the following data page, and these signals are then quasi-peaked.

Test Data

Not applicable, because EUT not connect to AC Main Source direct.