

MEASUREMENT REPORT

FCC PART 15 Subpart D

FCC ID: P27SCH2R0
Applicant: Sercomm Corporation
Application Type: Certification
Product: Indoor Camera
Model No.: SCH2R0-29xxxxx (the 1st x should be "blank" or "-"; the rest x could be 0 to 9, A to Z, a to z, "blank" or "-", for the marketing purpose)
Brand Name: ADT
FCC Classification: Unlicensed PCS Base Station
FCC Rule Part(s): FCC Part 15, Subpart D
Test Procedure(s): ANSI C63.17-2013
Test Date: November 07 ~ 23, 2019

Reviewed By:



(Sunny Sun)

Approved By:

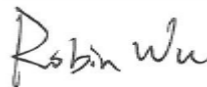

(Robin Wu)



The test results relate only to the samples tested.

This equipment has been shown to be capable of compliance with the applicable technical standards as indicated in the measurement report and was tested in accordance with the measurement procedures specified in ANSI C63.17. Test results reported herein relate only to the item(s) tested.

The test report shall not be reproduced except in full without the written approval of MRT Technology (Suzhou) Co., Ltd.

Revision History

Report No.	Version	Description	Issue Date	Note
1911RSU014-U1	Rev. 01	Initial Report	12-06-2019	Valid

CONTENTS

Description	Page
General Information.....	6
1. INTRODUCTION.....	7
1.1. Scope.....	7
1.2. MRT Test Location.....	7
2. PRODUCT INFORMATION.....	8
2.1. Feature of Equipment under Test.....	8
2.2. Working Frequencies.....	8
2.3. Test Software.....	8
2.4. EMI Suppression Device(s)/Modifications.....	8
2.5. Labeling Requirements.....	9
2.6. Automatic Discontinuation of Transmission.....	9
3. DESCRIPTION of TEST.....	10
3.1. Evaluation Procedure.....	10
3.2. AC Line Conducted Emissions.....	10
4. ANTENNA REQUIREMENTS.....	11
5. TEST EQUIPMENT CALIBRATION DATE.....	12
6. MEASUREMENT UNCERTAINTY.....	14
7. TEST RESULT.....	15
7.1. Summary.....	15
7.2. Power Line Conducted Measurement Emissions.....	16
7.2.1. Test Limit.....	16
7.2.2. Test Setup.....	16
7.2.3. Test Result.....	17
7.3. Emission Bandwidth Measurement.....	19
7.3.1. Test Limit.....	19
7.3.2. Test Procedure used.....	19
7.3.3. Test Setup.....	19
7.3.4. Test Result.....	20
7.4. Peak Power Output.....	22
7.4.1. Test Limit.....	22
7.4.2. Test Procedure Used.....	22
7.4.3. Test Setup.....	22
7.4.4. Test Result.....	23

7.5.	Power Spectral Density	25
7.5.1.	Test Limit	25
7.5.2.	Test Procedure Used	25
7.5.3.	Test Setup	25
7.5.4.	Test Result.....	26
7.6.	In-Band Unwanted Emissions.....	27
7.6.1.	Test Limit	27
7.6.2.	Test Procedure Used	27
7.6.3.	Test Setup	27
7.6.4.	Test Result.....	28
7.7.	Out-of-Band Emissions, Conducted.....	29
7.7.1.	Test Limit	29
7.7.2.	Test Procedure Used	29
7.7.3.	Test Setup	29
7.7.4.	Test Result.....	30
7.8.	Radiated Spurious Emission Measurement	33
7.8.1.	Test Limit	33
7.8.2.	Test Procedure Used	33
7.8.3.	Test Setting.....	34
7.8.4.	Test Setup	35
7.8.5.	Test Result.....	36
7.9.	Carrier Frequency Stability	39
7.9.1.	Test Limit	39
7.9.2.	Test Procedure Used	39
7.9.3.	Test Setup	39
7.9.4.	Test Result.....	40
7.10.	Specific Requirements for UPCS Device.....	42
7.10.1.	Monitoring Time Requirements.....	42
7.10.2.	Test Procedure Used	42
7.10.3.	Test Setup	42
7.10.4.	Test Reslut.....	42
7.10.5.	Lowest Monitoring Threshold Requirements.....	43
7.10.6.	Test Procedure Used	43
7.10.7.	Test Reslut.....	43
7.10.8.	Acknowledgements and Transmission Duration Requirements.....	44
7.10.8.1.	Test Procedure Used	44
7.10.8.2.	Test Reslut.....	44
7.10.9.	Least Interfered Channel (LIC) Selection Requirements.....	45
7.10.9.1.	Test Procedure Used	45

7.10.9.2.	Test Reslut.....	46
7.10.10.	Random waiting Requirements.....	47
7.10.10.1.	Test Procedure Used	47
7.10.10.2.	Test Reslut.....	47
7.10.11.	Monitoring Bandwidth Requirements	48
7.10.11.1.	Test Procedure Used	48
7.10.11.2.	Test Reslut.....	48
7.10.12.	Monitoring Antenna Requirements.....	49
7.10.12.1.	Test Procedure Used	49
7.10.12.2.	Test Reslut.....	49
7.10.13.	Monitoring Antenna Requirements.....	50
7.10.13.1.	Test Procedure Used	50
7.10.13.2.	Test Reslut.....	50
7.10.14.	Dual Access Criteria Check Requirements	51
7.10.14.1.	Test Procedure Used	51
7.10.14.2.	Test Reslut.....	51
7.10.15.	Alternative monitoring interval for co-located devices Requirements	52
7.10.15.1.	Test Procedure Used	52
7.10.15.2.	Test Reslut.....	52
7.10.16.	Frame Repetition Stability and Period and Jitter	53
7.10.16.1.	Test Limit	53
7.10.16.2.	Test Procedure Used	53
7.10.16.3.	Test Setup	53
7.10.16.4.	Test Result.....	53
8.	CONCLUSION	54
	Appendix A - Test Setup Photograph.....	55
	Appendix B - EUT Photograph.....	56

General Information

Applicant:	Sercomm Corporation
Applicant Address:	8F, No. 3-1, YuanQu St., NanKang, Taipei 115, Taiwan, R.O.C.
Manufacturer:	Sercomm Corporation
Manufacturer Address:	8F, No. 3-1, YuanQu St., NanKang, Taipei 115, Taiwan, R.O.C.
Test Site:	MRT Technology (Suzhou) Co., Ltd
Test Site Address:	D8 Building, No.2 Tian'edang Rd., Wuzhong Economic Development Zone, Suzhou, China
Test Device Serial No.:	N/A <input type="checkbox"/> Production <input checked="" type="checkbox"/> Pre-Production <input type="checkbox"/> Engineering

Test Facility / Accreditations

Measurements were performed at MRT Laboratory located in Tian'edang Rd., Suzhou, China.

- MRT facility is a FCC registered (MRT Reg. No. 893164) test facility with the site description report on file and has met all the requirements specified in ANSI C63.4-2014.
- MRT facility is an IC registered (MRT Reg. No. 11384A-1) test laboratory with the site description on file at Industry Canada.
- MRT facility is a VCCI registered (R-20025, G-20034, C-20020, T-20020) test laboratory with the site description on file at VCCI Council.
- MRT Lab is accredited to ISO 17025 by the American Association for Laboratory Accreditation (A2LA) under the American Association for Laboratory Accreditation Program (A2LA Cert. No. 3628.01) in EMC, Telecommunications, Radio and SAR testing.



1. INTRODUCTION

1.1. Scope

Measurement and determination of electromagnetic emissions (EMC) of radio frequency devices including intentional and/or unintentional radiators for compliance with the technical rules and regulations of the Federal Communications Commission and the Innovation, Science and Economic Development Canada.

1.2. MRT Test Location

The map below shows the location of the MRT LABORATORY, its proximity to the Taihu Lake. These measurement tests were conducted at the MRT Technology (Suzhou) Co., Ltd. Facility located at D8 Building, No.2 Tian'edang Rd., Wuzhong Economic Development Zone, Suzhou, China. The measurement facility compliant with the test site requirements specified in ANSI C63.4-2014.



2. PRODUCT INFORMATION

2.1. Feature of Equipment under Test

Product Name:	Indoor Camera
Model No.:	SCH2R0-29xxxxx (the 1st x should be “blank” or “-”; the rest x could be 0 to 9, A to Z, a to z, “blank” or “-”, for the marketing purpose)
Brand Name:	ADT
DECT Specification:	
Frequency Range:	1921.536 ~ 1928.448MHz
Number of Channels:	5
Maximum Output Power:	20.48dBm
Type of Modulation:	Digital (Gaussian Frequency Shift Keying)
Antenna Gain:	0dBi
Antenna Type:	PCB Antenna

2.2. Working Frequencies

UPCS Channel	Frequency (MHz)
Highest Band Edge	1930.000
0 (Highest)	1928.448
1	1926.720
2	1924.992
3	1923.264
4 (Lowest)	1921.536
Lowest Band Edge	1920.000

Requirement: FCC 15.303

Within 1920 -1930 MHz band for isochronous devices

2.3. Test Software

The test utility software used during testing was the commands provided by the customer.

2.4. EMI Suppression Device(s)/Modifications

No EMI suppression device(s) were added and/or no modifications were made during testing.

2.5. Labeling Requirements

Per 2.1074 & 15.19; Docket 95-19

The label shall be permanently affixed at a conspicuous location on the device; instruction manual or pamphlet supplied to the user and be readily visible to the purchaser at the time of purchase. However, when the device is so small wherein placement of the label with specified statement is not practical, only the FCC ID must be displayed on the device per Section 15.19(a)(5). Please see attachment for FCC ID label and label location.

2.6. Automatic Discontinuation of Transmission

Does the EUT transmit Control and Signaling Information?	<input checked="" type="checkbox"/> Yes	<input type="checkbox"/> No
Type of EUT:	<input type="checkbox"/> Initiating Device	<input checked="" type="checkbox"/> Responding Device

The following tests simulate the reaction of the EUT in case of either absence of information to transmit or operational failure after a connection with the companion device is established.

Number	Test	EUT Reaction	Verdict
1	Power removed from EUT	A	Pass
2	Switch Off EUT	N/A	Pass
3	Hook-On by EUT	N/A	Pass
4	Power Removed from Companion Device	B	Pass
5	Switch Off Companion Device	B	Pass
6	Hook-On by Companion Device	B	Pass

A - Connection breakdown, Cease of all transmissions

B - Connection breakdown, EUT transmits control and signaling information

C - Connection breakdown, Companion Device transmits control and signaling information

N/A - Not Applicable (EUT does not have On/Off switch and cannot perform Hook-On)

Requirements, FCC 15.319(f)

The device shall automatically discontinue transmission in case of either absence of information to transmit or operational failure. These provisions are not intended to preclude transmission of control and signaling information or use of repetitive codes used by certain digital technologies to complete frame or burst intervals.

3. DESCRIPTION of TEST

3.1. Evaluation Procedure

All measurements are traceable to national standards.

The tests were conducted on a sample of the equipment for the purpose of demonstrating compliance with FCC CFR47 Part 15D for Isochronous UPCS Devices

All tests were conducted in accordance with ANSI C63.4-2014 and ANSI C63.17-2013. Antenna Gain tests were made in a 3m fully-anechoic chamber.

3.2. AC Line Conducted Emissions

The line-conducted facility is located inside an 8'x4'x4' shielded enclosure. A 1m x 2m wooden table 80cm high is placed 40cm away from the vertical wall and 80cm away from the sidewall of the shielded room. Two 10kHz-30MHz, 50Ω/50uH Line-Impedance Stabilization Networks (LISNs) are bonded to the shielded room floor. Power to the LISNs is filtered by external high-current high-insertion loss power line filters. These filters attenuate ambient signal noise from entering the measurement lines. These filters are also bonded to the shielded enclosure.

The EUT is powered from one LISN and the support equipment is powered from the second LISN. All interconnecting cables more than 1 meter were shortened to a 1 meter length by non-inductive bundling (serpentine fashion) and draped over the back edge of the test table. All cables were at least 40cm above the horizontal reference ground-plane. Power cables for support equipment were routed down to the second LISN while ensuring that that cables were not draped over the second LISN.

Sufficient time for the EUT, support equipment, and test equipment was allowed in order for them to warm up to their normal operating condition. The RF output of the LISN was connected to the receiver and exploratory measurements were made to determine the frequencies producing the maximum emission from the EUT. The receiver was scanned from 150kHz to 30MHz. The detector function was set to peak mode for exploratory measurements while the bandwidth of the analyzer was set to 9kHz. The EUT, support equipment, and interconnecting cables were arranged and manipulated to maximize each emission. Each emission was also maximized by varying: power lines, the mode of operation or data exchange speed, or support equipment whichever determined the worst-case emission. Once the worst case emissions have been identified, the one EUT cable configuration/arrangement and mode of operation that produced these emissions are used for final measurements on the same test site. The analyzer is set to CISPR quasi-peak and average detectors with a 9kHz resolution bandwidth for final measurements.

An extension cord was used to connect to a single LISN which powered by EUT. The extension cord was calibrated with LISN, the impedance and insertion loss are compliance with the requirements as stated in ANSI C63.10-2013.

4. ANTENNA REQUIREMENTS

Excerpt from §15.203 of the FCC Rules/Regulations:

“An intentional radiator antenna shall be designed to ensure that no antenna other than that furnished by the responsible party can be used with the device. The use of a permanently attached antenna or of an antenna that uses a unique coupling to the intentional radiator shall be considered sufficient to comply with the provisions of this section.”

- The antenna of the unit is **permanently attached**.
- There are no provisions for connection to an external antenna.

Conclusion:

The unit complies with the requirement of §15.203.

5. TEST EQUIPMENT CALIBRATION DATE

Conducted Emissions - SR2

Instrument	Manufacturer	Type No.	Asset No.	Cali. Interval	Cali. Due Date
EMI Test Receiver	R&S	ESR3	MRTSUE06185	1 year	2020/04/15
Two-Line V-Network	R&S	ENV 216	MRTSUE06002	1 year	2020/06/13
Two-Line V-Network	R&S	ENV 216	MRTSUE06003	1 year	2020/06/13
Thermohygrometer	Testo	608-H1	MRTSUE06404	1 year	2020/08/08
Shielding Room	MIX-BEP	Chamber-SR2	MRTSUE06215	N/A	N/A

Radiated Emissions - AC1

Instrument	Manufacturer	Type No.	Asset No.	Cali. Interval	Cali. Due Date
EMI Test Receiver	R&S	ESR7	MRTSUE06001	1 year	2020/08/01
PXA Signal Analyzer	Keysight	9030B	MRTSUE06395	1 year	2020/09/03
Loop Antenna	Schwarzbeck	FMZB 1519	MRTSUE06025	1 year	2019/11/10
				1 year	2020/11/10
Bilog Period Antenna	Schwarzbeck	VULB 9168	MRTSUE06172	1 year	2020/03/31
Broad Band Horn Antenna	Schwarzbeck	BBHA 9120D	MRTSUE06023	1 year	2020/10/13
Broad Band Horn Antenna	Schwarzbeck	BBHA 9170	MRTSUE06024	1 year	2019/12/17
Microwave System Amplifier	Agilent	83017A	MRTSUE06076	1 year	2019/11/15
				1 year	2020/11/15
Preamplifier	Schwarzbeck	BBV 9721	MRTSUE06121	1 year	2020/06/11
Thermohygrometer	Testo	608-H1	MRTSUE06403	1 year	2020/08/08
Anechoic Chamber	TDK	Chamber-AC1	MRTSUE06212	1 year	2020/04/30

Radiated Emission - AC2

Instrument	Manufacturer	Type No.	Asset No.	Cali. Interval	Cali. Due Date
Spectrum Analyzer	Keysight	N9038A	MRTSUE06125	1 year	2020/08/01
Loop Antenna	Schwarzbeck	FMZB 1519	MRTSUE06025	1 year	2019/11/10
				1 year	2020/11/10
Bilog Period Antenna	Schwarzbeck	VULB 9162	MRTSUE06022	1 year	2020/10/13
Horn Antenna	Schwarzbeck	BBHA9120D	MRTSUE06171	1 year	2019/10/27
				1 year	2020/10/27
Broad Band Horn Antenna	Schwarzbeck	BBHA 9170	MRTSUE06024	1 year	2019/12/17
Broadband Coaxial Preamplifier	Schwarzbeck	BBV 9718	MRTSUE06176	1 year	2019/11/15
				1 year	2020/11/15
Preamplifier	Schwarzbeck	BBV 9721	MRTSUE06121	1 year	2020/06/11
Temperature/Humidity Meter	Minggao	ETH529	MRTSUE06170	1 year	2019/12/13
Anechoic Chamber	RIKEN	Chamber-AC2	MRTSUE06213	1 year	2020/04/30

Conducted Test Equipment - TR3

Instrument	Manufacturer	Type No.	Asset No.	Cali. Interval	Cali. Due Date
EXA Signal Analyzer	Agilent	N9020A	MRTSUE06106	1 year	2020/04/15
EXA Signal Analyzer	Keysight	N9010B	MRTSUE06452	1 year	2020/07/11
Signal Analyzer	R&S	FSV40	MRTSUE06218	1 year	2020/04/15
Power Meter	Agilent	U2021XA	MRTSUE06030	1 year	2019/11/18
				1 year	2020/11/18
USB wideband power sensor	Keysight	U2021XA	MRTSUE06446	1 year	2020/06/30
USB wideband power sensor	Keysight	U2021XA	MRTSUE06447	1 year	2020/06/30
Bluetooth Test Set	Anritsu	MT8852B-042	MRTSUE06389	1 year	2020/06/13
Audio Analyzer	Agilent	U8903B	MRTSUE06143	1 year	2020/06/13
Modulation Analyzer	HP	8901A	MRTSUE06098	1 year	2020/10/10
Wideband Radio Communication Tester	R&S	CMW 500	MRTSUE06243	1 year	2019/11/07
				1 year	2020/11/07
DC Power Supply	GWINSTEK	DPS-3303C	MRTSUE06064	N/A	N/A
Temperature & Humidity Chamber	BAOYT	BYH-150CL	MRTSUE06051	1 year	2019/11/07
				1 year	2020/11/07
Thermohyrometer	testo	608-H1	MRTSUE06401	1 year	2020/08/08

Software	Version	Function
EMI Software	V3	EMI Test Software

6. MEASUREMENT UNCERTAINTY

Where relevant, the following test uncertainty levels have been estimated for tests performed on the EUT as specified in CISPR 16-4-2. This uncertainty represents an expanded uncertainty expressed at approximately the 95% confidence level using a coverage factor of $k = 2$.

AC Conducted Emission Measurement - SR2
Measuring Uncertainty for a Level of Confidence of 95% ($U=2Uc(y)$): 150kHz~30MHz: $\pm 3.46\text{dB}$
Radiated Emission Measurement - AC1
The maximum measurement uncertainty is evaluated as: Horizontal: 30MHz~300MHz: 4.07dB 300MHz~1GHz: 3.63dB 1GHz~18GHz: 4.16dB Vertical: 30MHz~300MHz: 4.18dB 300MHz~1GHz: 3.60dB 1GHz~18GHz: 4.76dB
Radiated Emission Measurement - AC2
The maximum measurement uncertainty is evaluated as: Horizontal: 30MHz~300MHz: 3.75dB 300MHz~1GHz: 3.53dB 1GHz~18GHz: 4.28dB Vertical: 30MHz~300MHz: 3.86dB 300MHz~1GHz: 3.53dB 1GHz~18GHz: 4.33dB

7. TEST RESULT

7.1. Summary

Test Item	FCC CFR 47 Paragraph	Verdict
Power Line Conducted Emission	15.207(a)	Complies
Digital Modulation Techniques	15.319(b)	Complies
Labeling requirements	15.19(a)(3)	Complies
Antenna Requirement	15.317, 15.203	Complies
Channel Frequencies	15.303	Complies
Automatic discontinuation of transmission	15.319(f)	Complies
Emission Bandwidth	15.323(a) 5.5	Complies
In-band emissions	15.323(d)	Complies
Out-of-band emissions	15.323(d)	Complies
Peak Transmit Power and Antenna Gain	15.319(c)(e), 15.31(e)	Complies
Power Spectral Density	15.319(d)	Complies
Carrier frequency stability	15.323(f)	Complies
Spurious Emissions (Radiated)	15.319(g), 15.109(a), 15.209(a)	Complies
Specific Requirements for UPCS	15.323(c)(e)	Complies
Note: The two adapters have been assessed in the FCC 15B report, and selected the worst one in this test report.		

7.2. Power Line Conducted Measurement Emissions

7.2.1. Test Limit

FCC Part 15.107 Limits		
Frequency (MHz)	QP (dB μ V)	AV (dB μ V)
0.15 - 0.50	66 - 56	56 - 46
0.50 - 5.0	56	46
5.0 - 30	60	50

Note 1: The lower limit shall apply at the transition frequencies.

Note 2: The limit decreases linearly with the logarithm of the frequency in the range 0.15MHz to 0.5MHz.

7.2.2. Test Setup

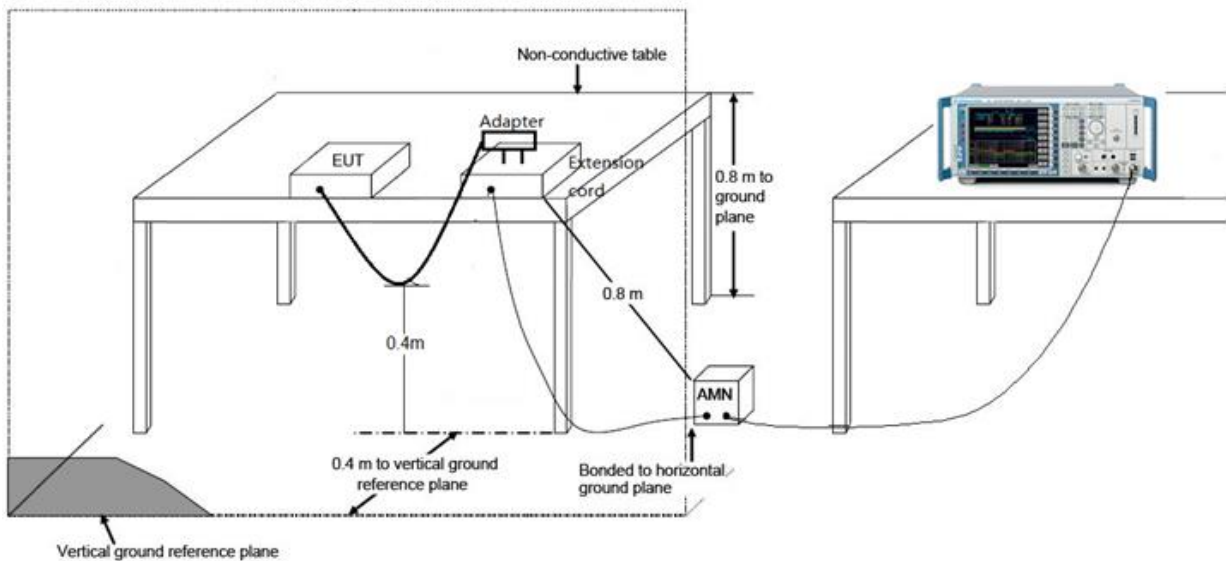

7.2.3. Test Result

Site: SR2	Time: 2019/11/23 - 11:15
Limit: FCC_Part15.207_CE_Class B	Engineer: Andy Zhu
Probe: ENV216_101683_Filter On	Polarity: Line
EUT: Indoor Camera	Power: AC 120V/60Hz
Test Mode 1	

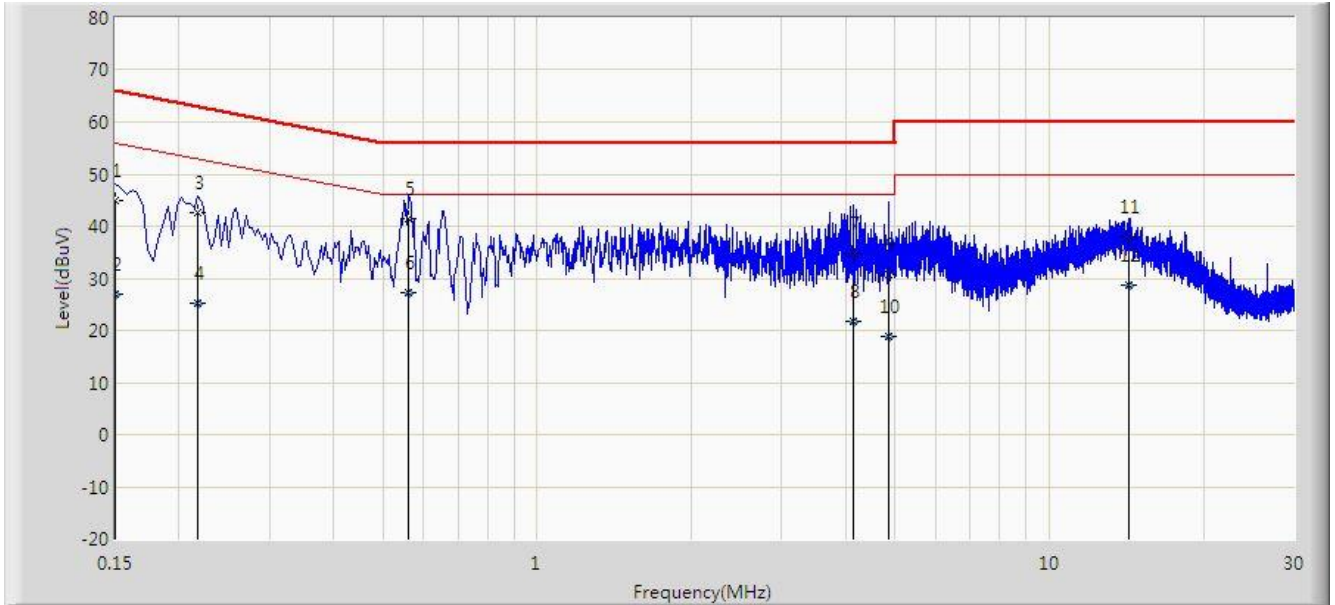

No	Flag	Mark	Frequency (MHz)	Measure Level (dBuV)	Reading Level (dBuV)	Margin (dB)	Limit (dBuV)	Factor (dB)	Type
1			0.150	45.060	33.892	-20.940	66.000	11.168	QP
2			0.150	27.053	15.884	-28.947	56.000	11.168	AV
3			0.218	42.579	32.634	-20.316	62.895	9.945	QP
4			0.218	25.285	15.340	-27.610	52.895	9.945	AV
5		*	0.562	41.409	31.275	-14.591	56.000	10.135	QP
6			0.562	27.229	17.094	-18.771	46.000	10.135	AV
7			4.146	34.666	24.694	-21.334	56.000	9.973	QP
8			4.146	21.776	11.803	-24.224	46.000	9.973	AV
9			4.850	30.620	20.594	-25.380	56.000	10.026	QP
10			4.850	18.972	8.946	-27.028	46.000	10.026	AV
11			14.334	38.061	28.004	-21.939	60.000	10.057	QP
12			14.334	28.753	18.696	-21.247	50.000	10.057	AV

Note: Measure Level (dBμV) = Reading Level (dBμV) + Factor (dB)

Factor (dB) = Cable Loss (dB) + LISN Factor (dB)

Site: SR2	Time: 2019/11/23 - 11:21
Limit: FCC_Part15.207_CE_Class B	Engineer: Andy Zhu
Probe: ENV216_101683_Filter On	Polarity: Neutral
EUT: Indoor Camera	Power: AC 120V/60Hz
Test Mode 1	

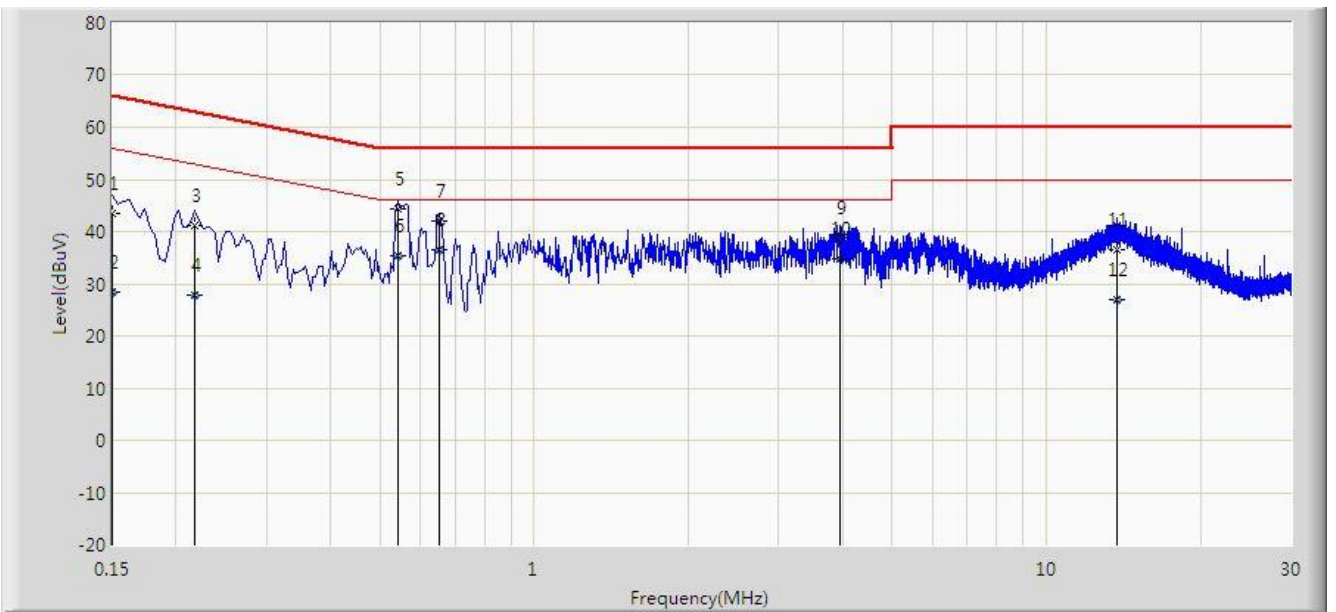

No	Flag	Mark	Frequency (MHz)	Measure Level (dBuV)	Reading Level (dBuV)	Margin (dB)	Limit (dBuV)	Factor (dB)	Type
1			0.150	43.603	32.461	-22.397	66.000	11.142	QP
2			0.150	28.274	17.132	-27.726	56.000	11.142	AV
3			0.218	41.141	31.160	-21.754	62.895	9.981	QP
4			0.218	27.945	17.963	-24.950	52.895	9.981	AV
5			0.542	44.321	34.158	-11.679	56.000	10.163	QP
6			0.542	35.408	25.245	-10.592	46.000	10.163	AV
7			0.654	42.001	31.900	-13.999	56.000	10.101	QP
8		*	0.654	36.456	26.355	-9.544	46.000	10.101	AV
9			3.954	38.781	28.813	-17.219	56.000	9.968	QP
10			3.954	34.807	24.839	-11.193	46.000	9.968	AV
11			13.718	36.410	26.312	-23.590	60.000	10.097	QP
12			13.718	26.940	16.843	-23.060	50.000	10.097	AV

Note: Measure Level (dBμV) = Reading Level (dBμV) + Factor (dB)

Factor (dB) = Cable Loss (dB) + LISN Factor (dB)

7.3. Emission Bandwidth Measurement

7.3.1. Test Limit

The 26 dB Bandwidth B shall be larger than 50 kHz and less than 2.5MHz.

No requirement for 6 dB and 12 dB Bandwidth. These values are only used for testing Monitoring Bandwidth if the Simple Compliance test fails (ANSI C63.17, clause 7.4).

7.3.2. Test Procedure used

ANSI C63.17, Clause 6.1.3

7.3.3. Test Setup

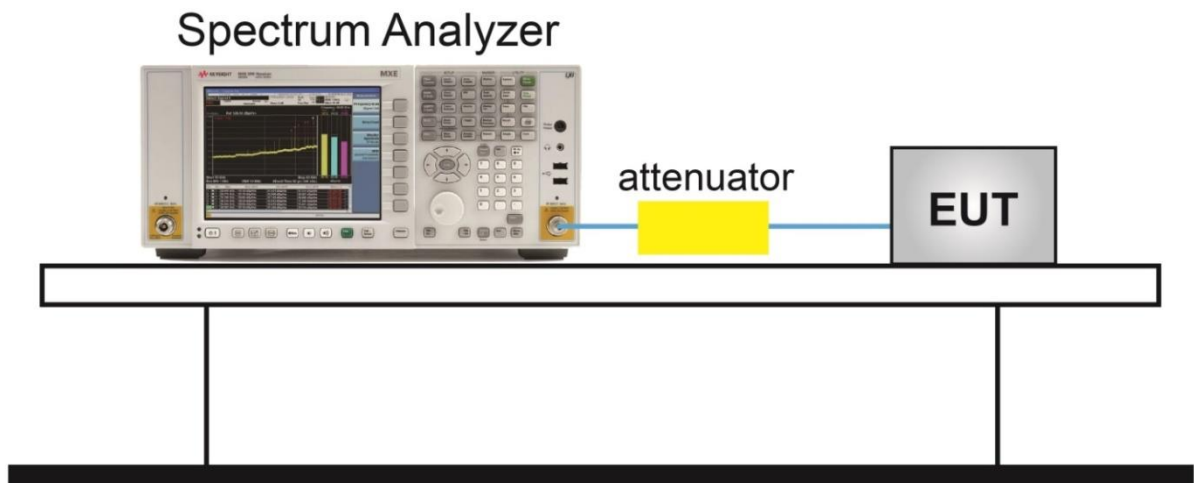

7.3.4. Test Result

Product	Indoor Camera	Temperature	24°C
Test Engineer	Bruce Dong	Relative Humidity	51%
Test Site	TR3	Test Date	2019/11/23
Test Mode	Mode 1		

Channel No.	Frequency (MHz)	Emission Bandwidth (MHz)	Result
26dB Bandwidth			
4	1921.536	1.422	Pass
2	1924.992	1.422	Pass
0	1928.448	1.432	Pass
99% Bandwidth			
4	1921.536	1.219	Pass
2	1924.992	1.221	Pass
0	1928.448	1.230	Pass

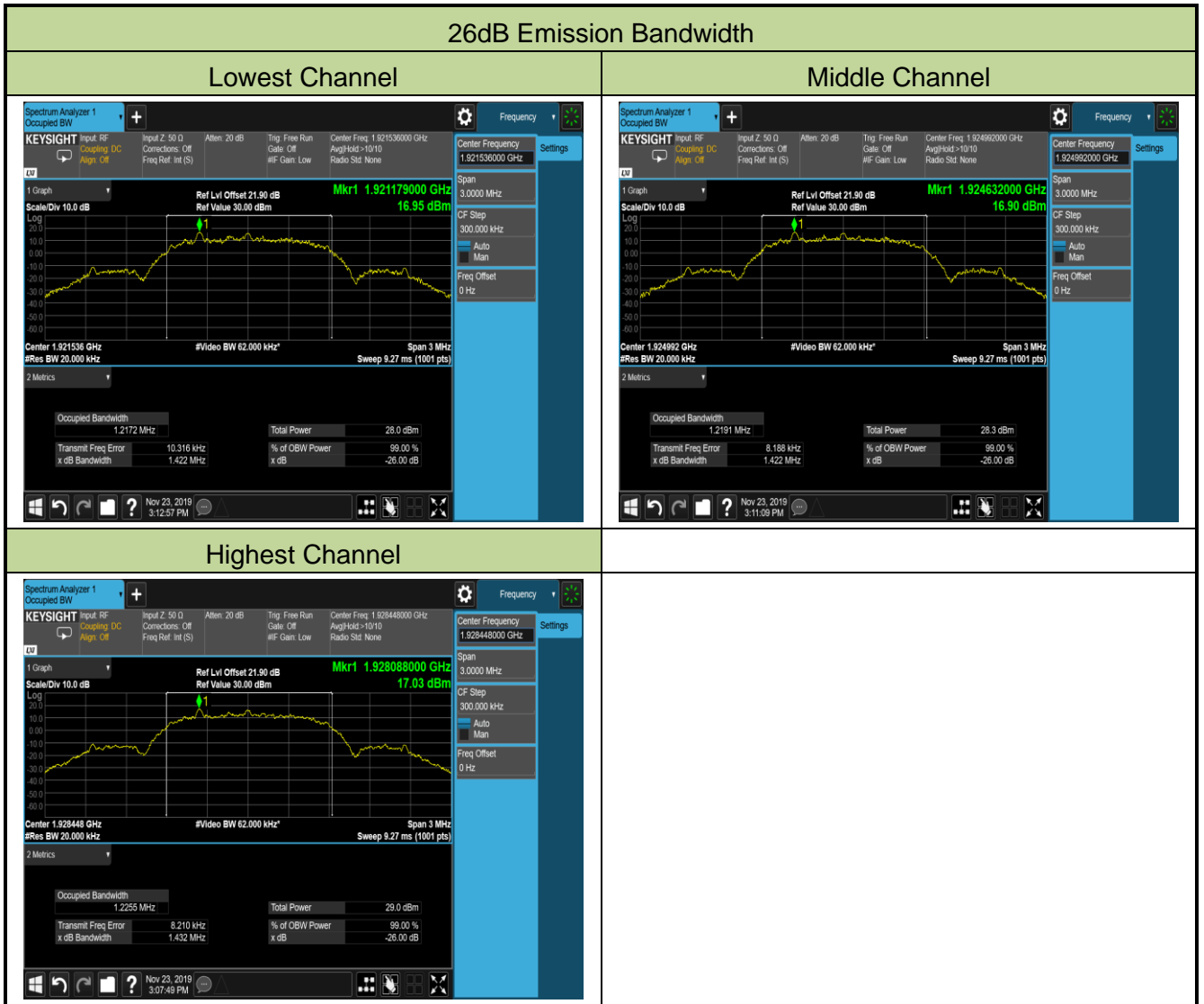

7.4. Peak Power Output

7.4.1. Test Limit

Peak transmit power shall not exceed 100 microwatts multiplied by the square root of the emission bandwidth in Hertz.

The peak transmit power shall be reduced by the amount in decibels that the maximum directional gain of the antenna exceeds 3dBi.

7.4.2. Test Procedure Used

ANSI C63.17, Clause 6.1.2

7.4.3. Test Setup

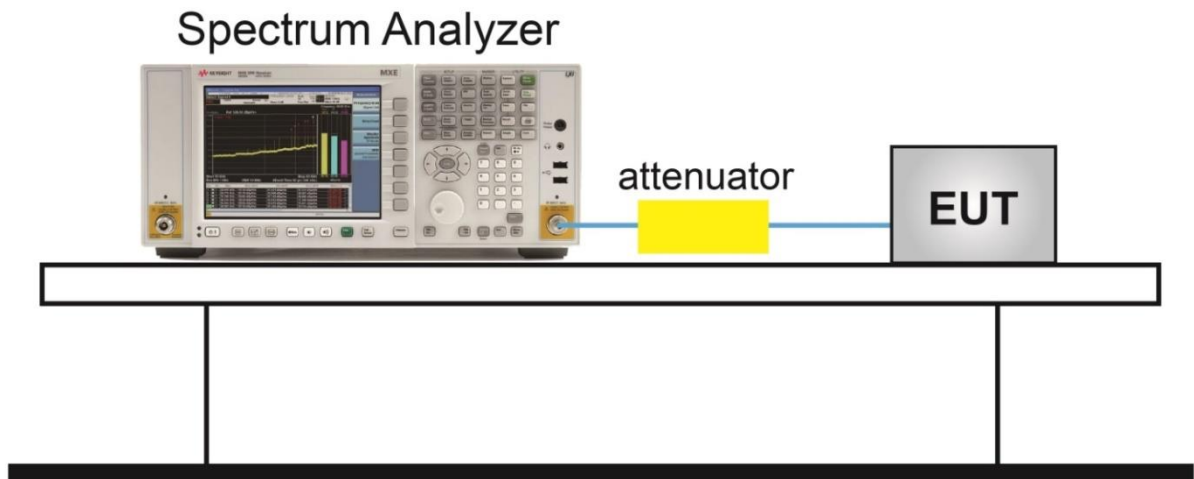

7.4.4. Test Result

Product	Indoor Camera	Temperature	24°C
Test Engineer	Bruce Dong	Relative Humidity	51%
Test Site	TR3	Test Date	2019/11/14
Test Mode	Mode 1		

Channel No.	Frequency (MHz)	Maximum Conducted Output Power (dBm)	Maximum Antenna Gain (dBi)	Maximum Radiated Output Power (dBm)	Limit (dBm)
4	1921.536	20.12	0	20.12	≤ 20.76
2	1924.992	20.42	0	20.42	≤ 20.76
0	1928.448	20.48	0	20.48	≤ 20.76

Note: The min EBW = 1422000Hz

Peak Transmit Power Limit = $10 \cdot \log(100\mu\text{W} \times (\text{EBW})^{1/2} \div 1000) = 20.76\text{dBm}$

Peak Output Power

Lowest Channel

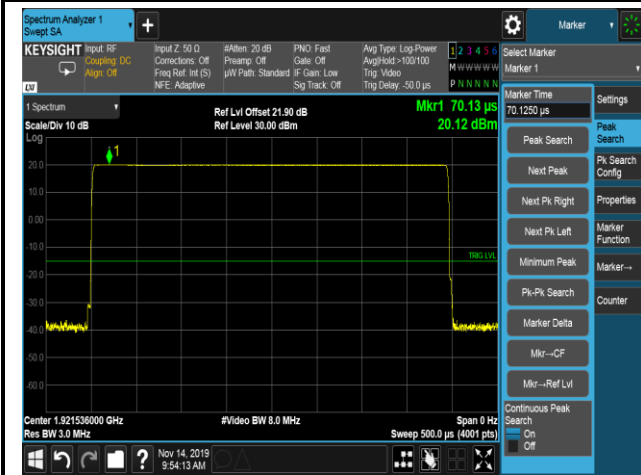

Middle Channel

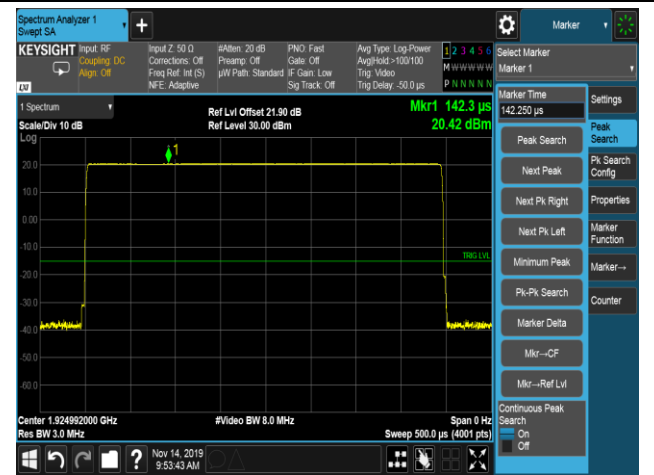

Highest Channel

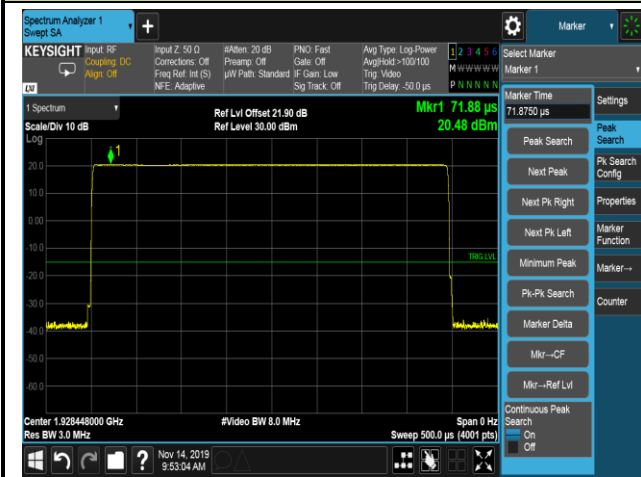

7.5. Power Spectral Density

7.5.1. Test Limit

Power spectral density shall not exceed 3 milliwatts in any 3 kHz bandwidth as measured with a spectrum analyzer having a resolution bandwidth of 3 kHz.

7.5.2. Test Procedure Used

ANSI C63.17, Clause 6.1.5

7.5.3. Test Setup

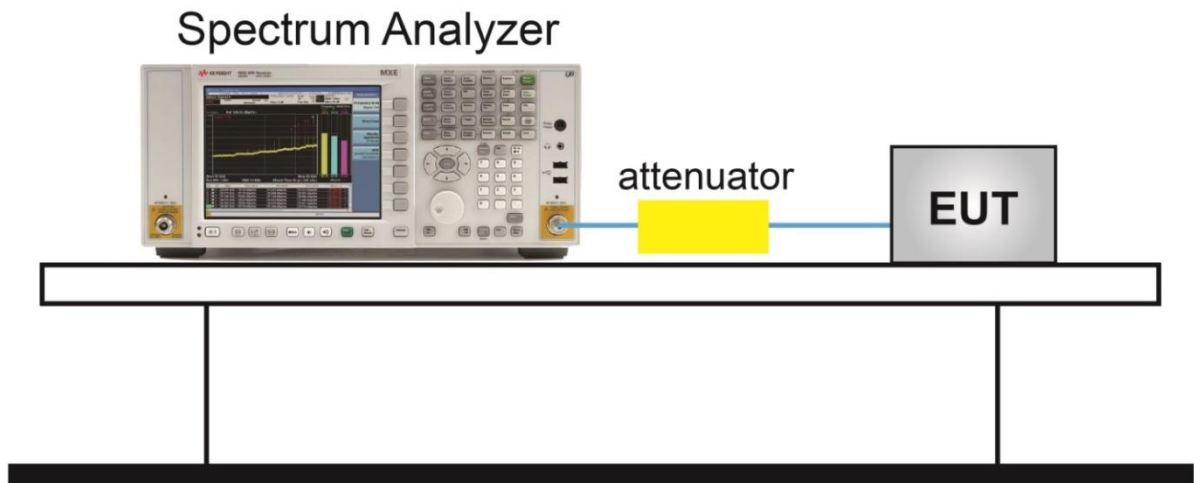

7.5.4. Test Result

Product	Indoor Camera	Temperature	24°C
Test Engineer	Bruce Dong	Relative Humidity	51%
Test Site	TR3	Test Date	2019/11/23
Test Mode	Mode 1		

Channel No.	Frequency (MHz)	Measured PSD (dBm / 3kHz)	Limit (mW / 3kHz)	Result
4	1921.536	-3.10	≤ 3.00	Pass
2	1924.992	-2.41	≤ 3.00	Pass
0	1928.448	-2.56	≤ 3.00	Pass

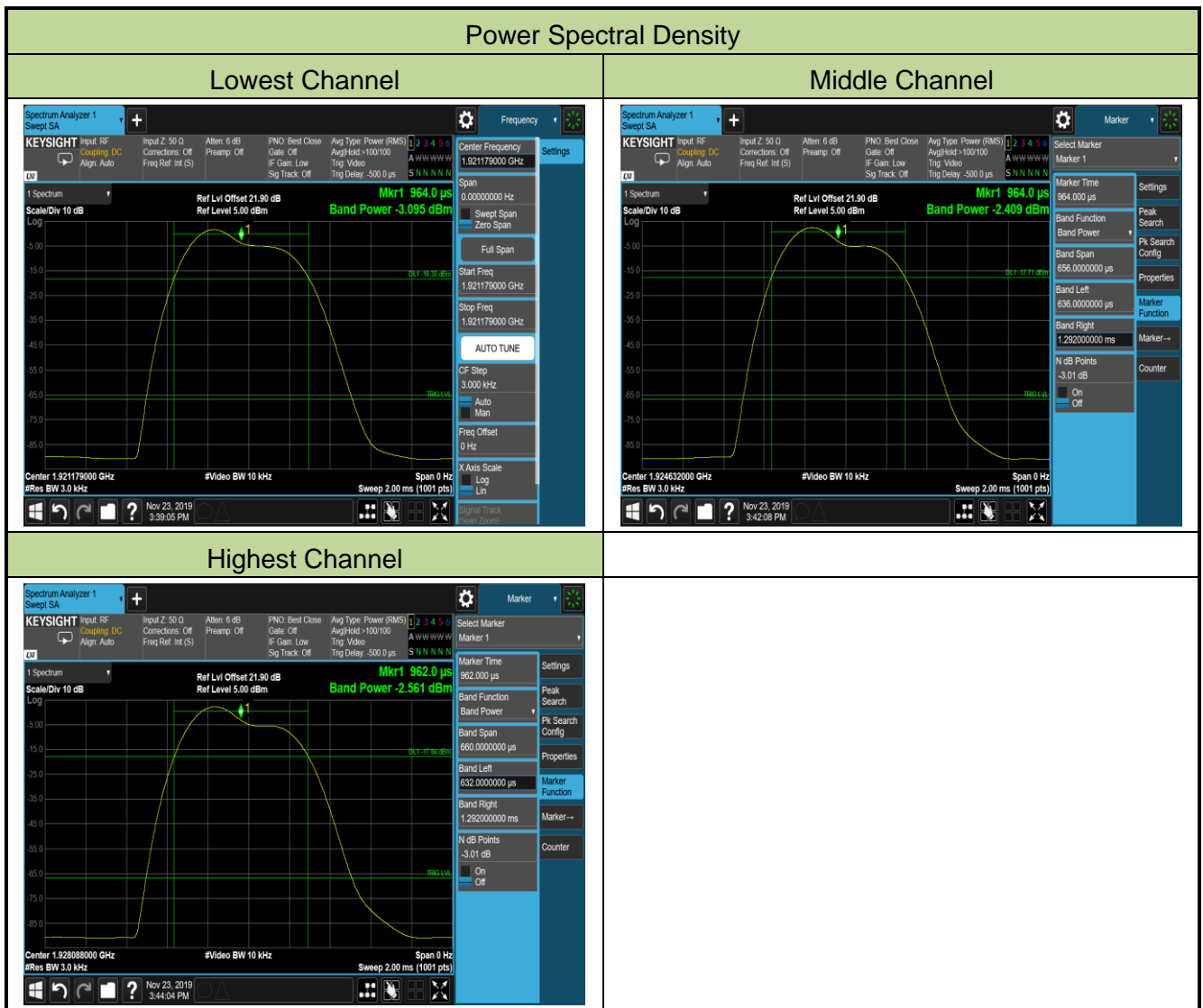

7.6. In-Band Unwanted Emissions

7.6.1. Test Limit

B < f2 _2B: less than or equal to 30 dB below maximum permitted peak power level

2B < f2 _3B: less than or equal to 50 dB below maximum permitted peak power level

3B < f2 _UPCS Band Edge: less than or equal to 60 dB below maximum permitted peak power level.

7.6.2. Test Procedure Used

ANSI C63.17, Clause 6.1.6.1

7.6.3. Test Setup

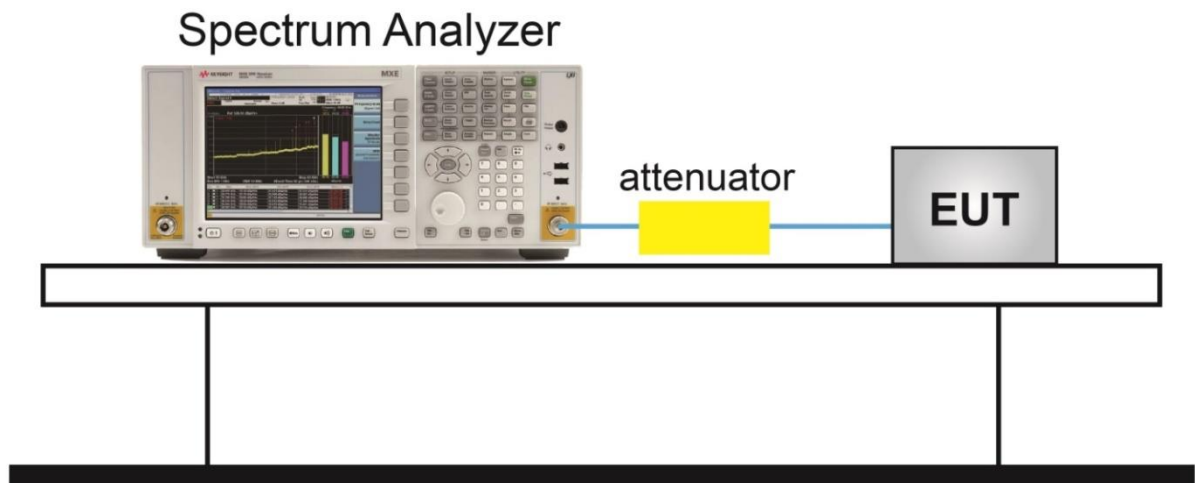

7.6.4. Test Result

Product	Indoor Camera	Temperature	24°C
Test Engineer	Bruce Dong	Relative Humidity	51%
Test Site	TR3	Test Date	2019/11/14
Test Mode	Mode 1		

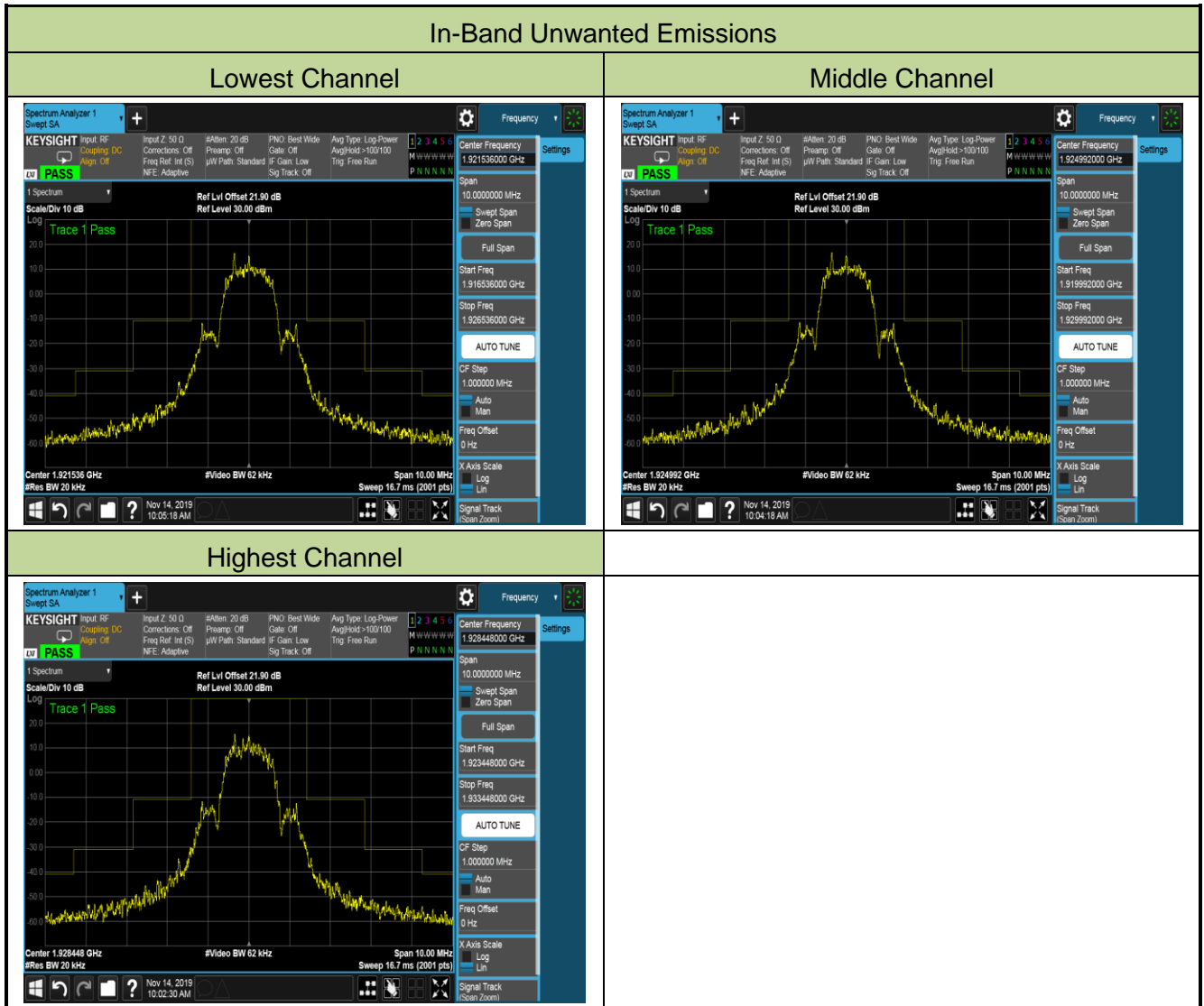

Note: The BS spurious in-band of Middle Channel transmission level is below the indicated limit.

7.7. Out-of-Band Emissions, Conducted

7.7.1. Test Limit

$f \leq 1.25$ MHz outside UPCS band: ≤ -9.5 dBm

1.25 MHz $\leq f \leq 2.5$ MHz outside UPCS band: ≤ -29.5 dBm

$f \leq 2.5$ MHz outside UPCS band: ≤ -39.5 dBm

7.7.2. Test Procedure Used

ANSI C63.17, Clause 6.1.6.2

7.7.3. Test Setup

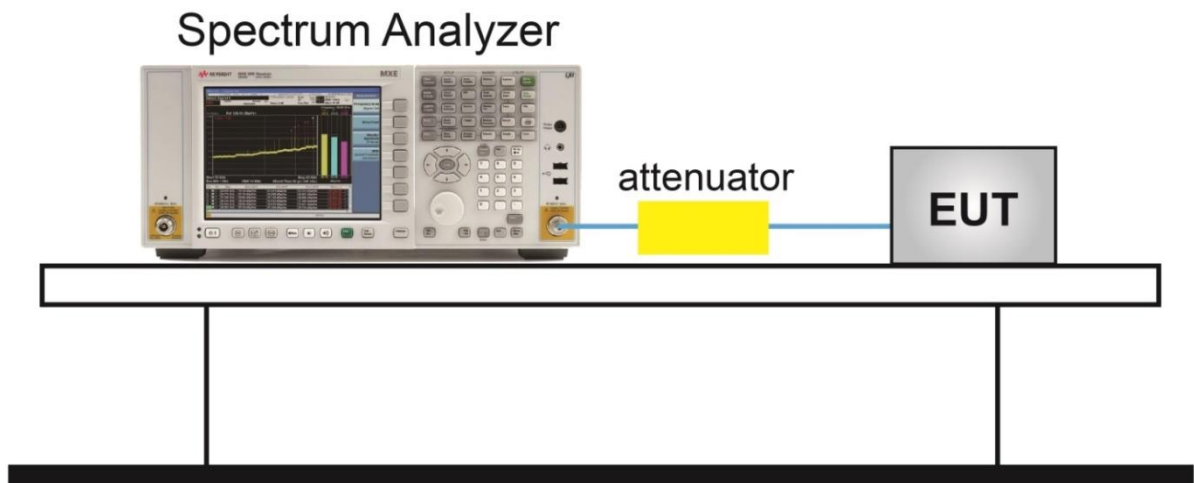

7.7.4. Test Result

Product	Indoor Camera	Temperature	24°C
Test Engineer	Bruce Dong	Relative Humidity	51%
Test Site	TR3	Test Date	2019/11/14
Test Mode	Mode 1		

Out-Band Unwanted Emissions – Low Channel

30MHz ~ 1.915GHz

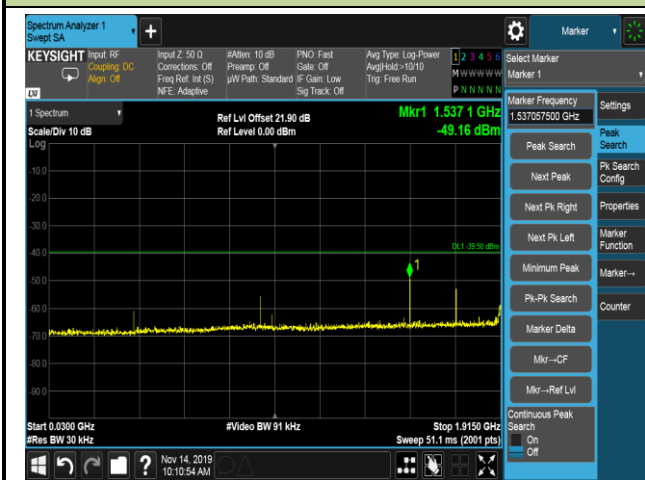

1.915GHz ~ 1.92GHz



1.93GHz ~ 1.935GHz



1.935GHz ~ 20GHz

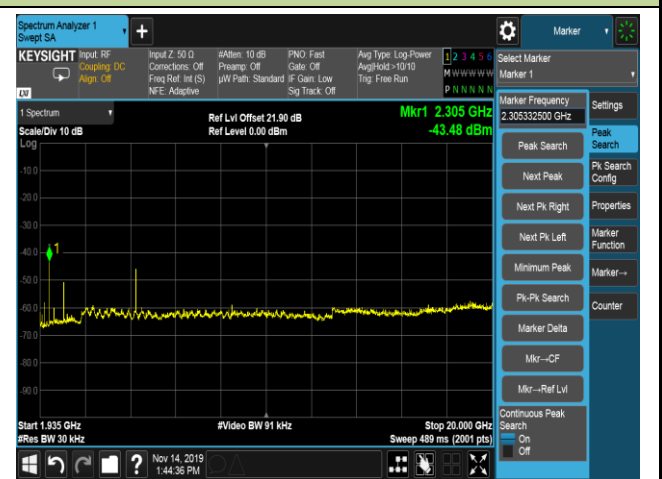

Out-Band Unwanted Emissions –Middle Channel

30MHz ~ 1.915GHz

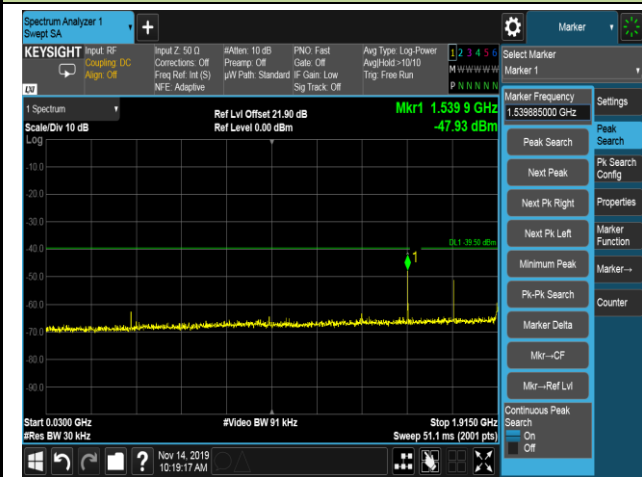

1.915GHz ~ 1.92GHz

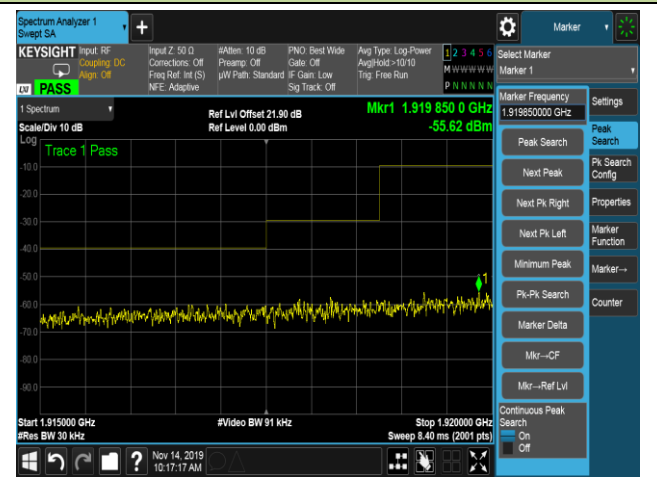

1.93GHz ~ 1.935GHz



1.935GHz ~ 20GHz

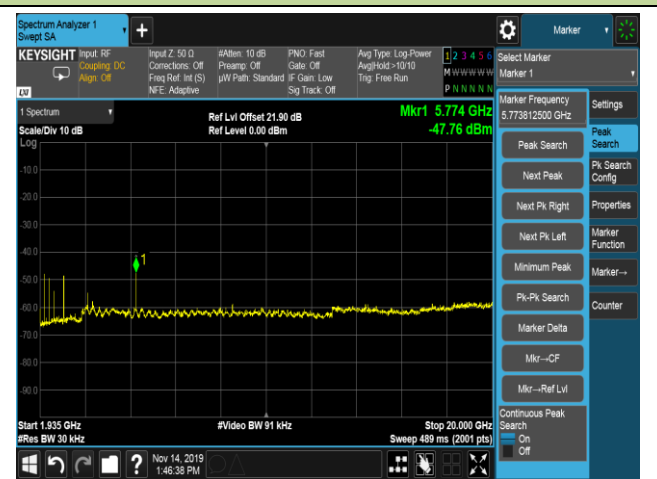

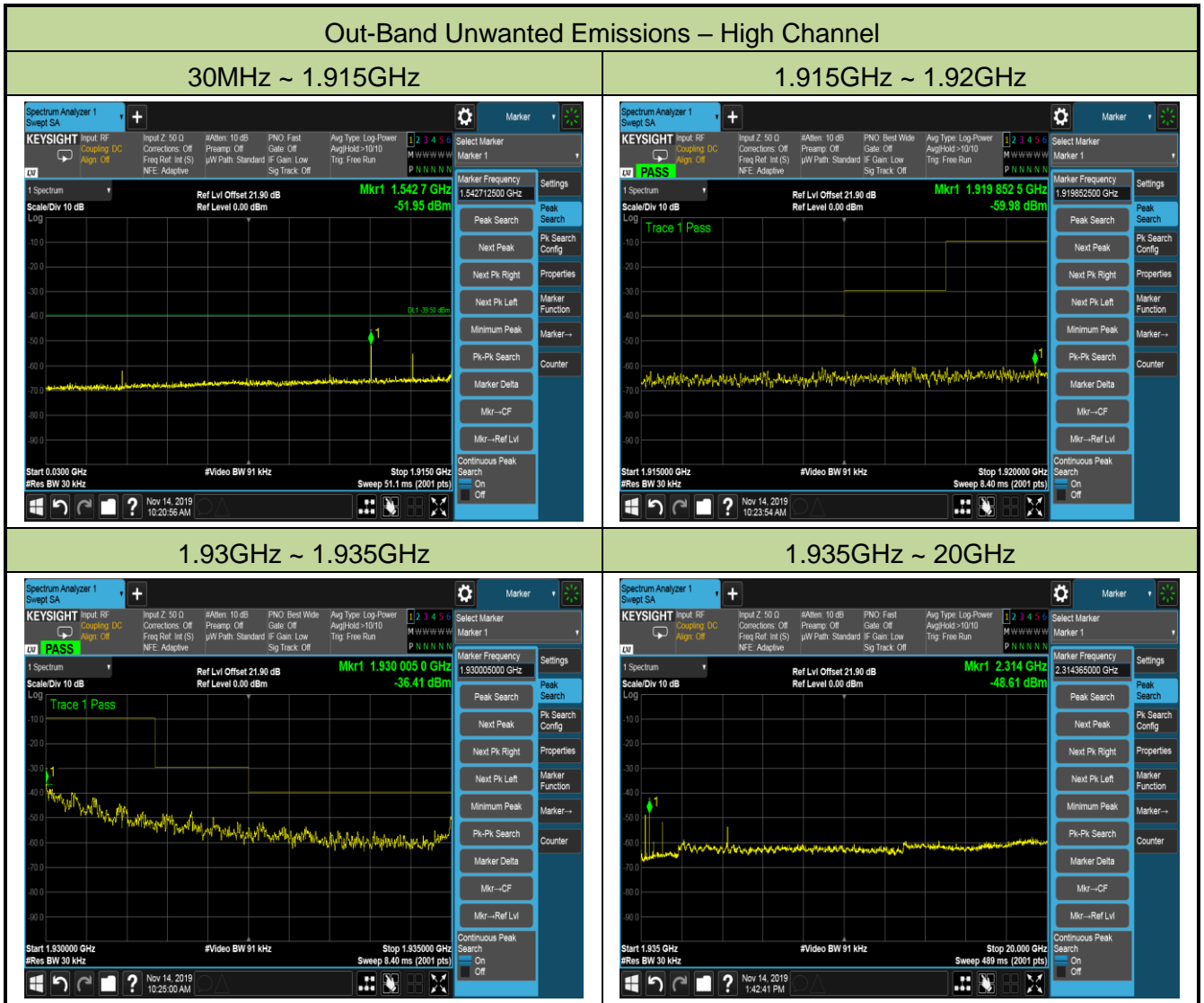

Note 1: The BS spurious out-of-band transmission level is below the indicated limit.

Note 2: During the test RTX’s modulation type was PSBR.

Note 3: According to FCC Part15 Subpart D & ANSI C63.17, The frequency 1.935 ~ 20GHz can be assessed by radiated method, the detail data was showed in clause 7.8.

7.8. Radiated Spurious Emission Measurement

7.8.1. Test Limit

Transmitter Spurious Emission Limits

All out of band emissions appearing in a restricted band as specified in Section 15.205 of the Title 47CFR must not exceed the limits shown in Table per Section 15.209.

FCC Part 15 Subpart C Paragraph 15.209		
Frequency [MHz]	Field Strength [uV/m]	Measured Distance [Meters]
0.009 - 0.490	2400/F (kHz)	300
0.490 - 1.705	24000/F (kHz)	30
1.705 - 30	30	30
30 - 88	100	3
88 - 216	150	3
216 - 960	200	3
Above 960	500	3

Receiver Spurious Emission Limits

Spurious emissions from receivers shall not exceed the radiated emissions limits shown in below table.

FCC Part 15 Subpart B Paragraph 15.109	
Frequency [MHz]	Field Strength [uV/m at 3 meters]
30 - 88	100
88 - 216	150
216 - 960	200
Above 960	500

7.8.2. Test Procedure Used

ANSI C63.10 Section 6.3 (General Requirements)

ANSI C63.10 Section 6.4 (Standard test method below 30MHz)

ANSI C63.10 Section 6.5 (Standard test method above 30MHz to 1GHz)

ANSI C63.10 Section 6.6 (Standard test method above 1GHz)

7.8.3. Test Setting

Table 1 - RBW as a function of frequency

Frequency	RBW
9 ~ 150 kHz	200 ~ 300 Hz
0.15 ~ 30 MHz	9 ~ 10 kHz
30 ~ 1000 MHz	100 ~ 120 kHz
> 1000 MHz	1 MHz

Quasi-Peak Measurements below 1GHz

1. Analyzer center frequency was set to the frequency of the radiated spurious emission of interest
2. Span was set greater than 1MHz
3. RBW = as specified in Table 1
4. Detector = CISPR quasi-peak
5. Sweep time = auto couple
6. Trace was allowed to stabilize

Peak Measurements above 1GHz

1. Analyzer center frequency was set to the frequency of the radiated spurious emission of interest
2. RBW = 1MHz
3. VBW = 3MHz
4. Detector = peak
5. Sweep time = auto couple
6. Trace mode = max hold
7. Trace was allowed to stabilize

Average Measurements above 1GHz (Method VB)

1. Analyzer center frequency was set to the frequency of the radiated spurious emission of interest
2. RBW = 1MHz
3. VBW; If the EUT is configured to transmit with duty cycle $\geq 98\%$, set VBW = 10 Hz.
If the EUT duty cycle is $< 98\%$, set VBW $\geq 1/T$. T is the minimum transmission duration.
4. Detector = Peak
5. Sweep time = auto
6. Trace mode = max hold
7. Trace was allowed to stabilize

7.8.4. Test Setup

Above 1GHz Test Setup:

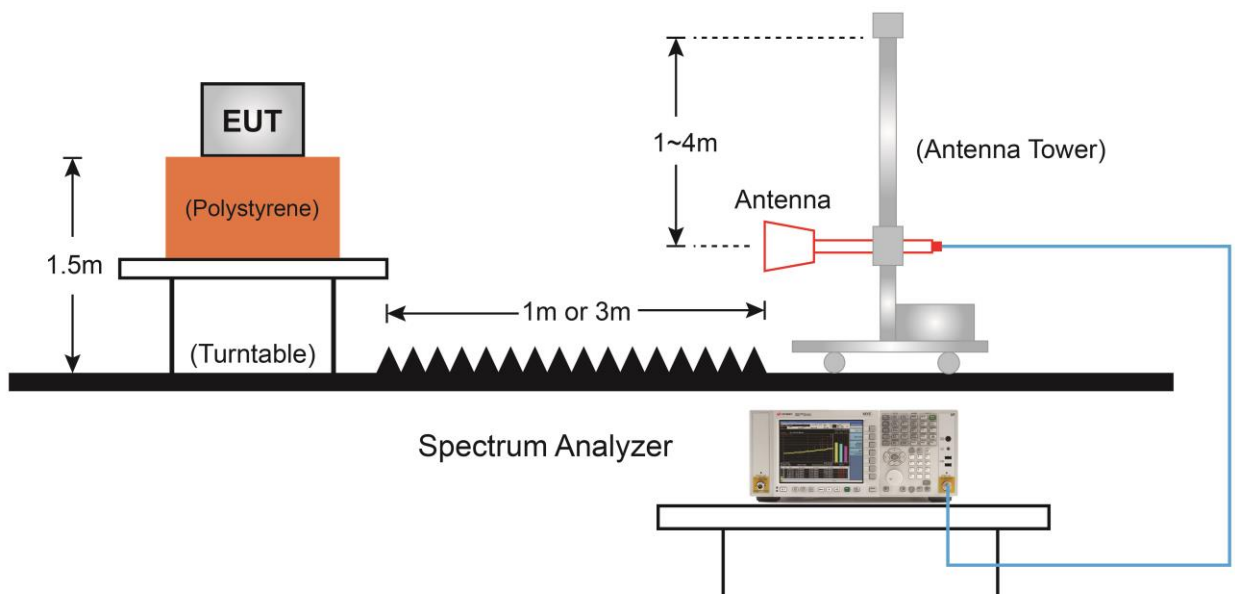

7.8.5. Test Result

Product	Indoor Camera	Temperature	25°C
Test Engineer	Andy Zhu	Relative Humidity	52%
Test Site	AC1	Test Date	2019/11/11
Test Mode	Mode 1	Test Channel	0
Note	1. Average measurement was not performed if peak level lower than average limit. 2. Other frequency was 20dB below limit line within 1-18GHz, there is not show in the report.		

Mark	Frequency (MHz)	Reading Level (dBμV)	Factor (dB)	Measure Level (dBμV/m)	Limit (dBμV/m)	Margin (dB)	Detector	Polarization
	3856.0	49.8	0.0	49.7	74.0	-24.3	Peak	Horizontal
	5394.5	38.5	4.0	42.6	74.0	-31.4	Peak	Horizontal
	6941.5	33.5	10.0	43.6	74.0	-30.4	Peak	Horizontal
	9755.0	33.4	14.0	47.4	74.0	-26.6	Peak	Horizontal
*	3856.0	52.4	0.0	52.4	74.0	-21.6	Peak	Vertical
	5377.5	36.6	3.9	40.5	74.0	-33.5	Peak	Vertical
	8684.0	32.9	12.4	45.3	74.0	-28.7	Peak	Vertical
	10163.0	32.7	15.0	47.6	74.0	-26.4	Peak	Vertical

Note: Measure Level (dBμV/m) = Reading Level (dBμV) + Factor (dB)

Factor (dB) = Cable Loss (dB) + Antenna Factor (dB/m) - Pre_Amplifier Gain (dB)

Product	Indoor Camera	Temperature	25°C
Test Engineer	Kevin Ker	Relative Humidity	52%
Test Site	AC1	Test Date	2019/11/11
Test Mode	Mode 1	Test Channel	02
Note	1. Average measurement was not performed if peak level lower than average limit. 2. Other frequency was 20dB below limit line within 1-18GHz, there is not show in the report.		

Mark	Frequency (MHz)	Reading Level (dBμV)	Factor (dB)	Measure Level (dBμV/m)	Limit (dBμV/m)	Margin (dB)	Detector	Polarization
*	3847.5	51.9	0.0	51.9	74.0	-22.1	Peak	Horizontal
	5386.0	40.1	4.0	44.1	74.0	-29.9	Peak	Horizontal
	6431.5	33.8	7.5	41.4	74.0	-32.6	Peak	Horizontal
	10520.0	32.4	16.7	49.2	74.0	-24.8	Peak	Horizontal
	3847.5	50.9	0.0	50.9	74.0	-23.1	Peak	Vertical
	5377.5	37.1	3.9	41.0	74.0	-33.0	Peak	Vertical
	6525.0	33.6	8.5	42.1	74.0	-31.9	Peak	Vertical
	9738.0	33.5	13.8	47.3	74.0	-26.7	Peak	Vertical

Note: Measure Level (dBμV/m) = Reading Level (dBμV) + Factor (dB)

Factor (dB) = Cable Loss (dB) + Antenna Factor (dB/m) - Pre_Amplifier Gain (dB)

Product	Indoor Camera	Temperature	25°C
Test Engineer	Kevin Ker	Relative Humidity	52%
Test Site	AC1	Test Date	2019/11/11
Test Mode	Mode 1	Test Channel	04
Note	1. Average measurement was not performed if peak level lower than average limit. 2. Other frequency was 20dB below limit line within 1-18GHz, there is not show in the report.		

Mark	Frequency (MHz)	Reading Level (dBμV)	Factor (dB)	Measure Level (dBμV/m)	Limit (dBμV/m)	Margin (dB)	Detector	Polarization
*	3839.0	51.4	0.0	51.4	74.0	-22.6	Peak	Horizontal
	5377.5	42.2	3.9	46.1	74.0	-27.9	Peak	Horizontal
	6176.5	34.8	6.7	41.5	74.0	-32.5	Peak	Horizontal
	8582.0	33.3	12.0	45.3	74.0	-28.7	Peak	Horizontal
	3839.0	51.6	0.0	51.6	74.0	-22.4	Peak	Vertical
	5377.5	38.6	3.9	42.5	74.0	-31.5	Peak	Vertical
	7026.5	33.2	10.6	43.7	74.0	-30.3	Peak	Vertical
	9755.0	34.0	14.0	48.0	74.0	-26.0	Peak	Vertical

Note: Measure Level (dBμV/m) = Reading Level (dBμV) + Factor (dB)

Factor (dB) = Cable Loss (dB) + Antenna Factor (dB/m) - Pre_Amplifier Gain (dB)

7.9. Carrier Frequency Stability

7.9.1. Test Limit

Per §15.323(f), the frequency stability of the carrier frequency of the intentional radiator shall be maintained within ± 10 ppm over 1 hour or the interval between channel access monitoring, whichever is shorter. The frequency stability shall be maintained over a temperature variation of -20°C to $+50^{\circ}\text{C}$ at normal supply voltage, and over a variation in the primary supply voltage of 85 percent to 115 percent of the rated supply voltage at a temperature of 20°C . For equipment that is capable only of operating from a battery, the frequency stability tests shall be performed using a new battery without any further requirement to vary supply voltage.

7.9.2. Test Procedure Used

ANSI C63.17, Clause 6.2.1

7.9.3. Test Setup

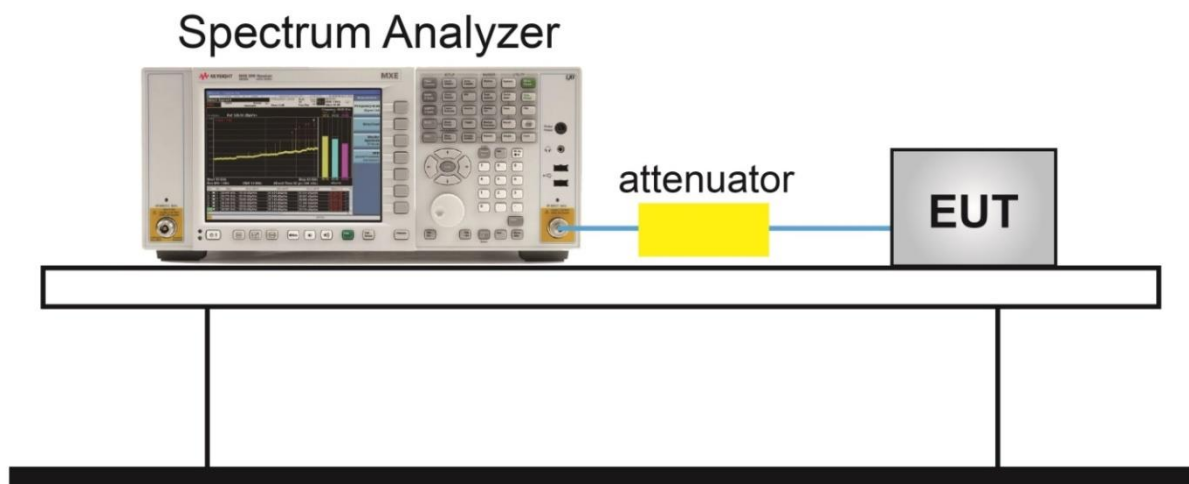

7.9.4. Test Result

The Frequency Stability is measured with the RTX. The RTX was logged by a computer programmed to get the new readings as fast as possible (about 3 readings per second) over the noted time period or number of readings. The peak-to-peak difference was recorded and the mean value and deviation in ppm was calculated.

The Carrier Frequency Stability over power Supply Voltage and over Temperature is measured also with the RTX.

Carrier Frequency Stability over Time at Nominal Temperature

Average Mean Carrier Frequency (MHz)	Max. Diff. (kHz)	Min. Diff. (kHz)	Max Dev. (ppm)	Limit (ppm)
Mode 1				
1924.998436	10.4	3.1	3.8	±10

Deviation ppm = ((Max. Diff. - Mean. Diff.) / Mean Carrier Freq.) x 10⁶

Deviation (ppm) is calculated from 3000 readings with the RTX.

Carrier Frequency Stability over Time at Nominal Temperature

Voltage	Measured Carrier Frequency (MHz)	Difference (kHz)	Deviation (ppm)	Limit (ppm)
Mode 1				
V _{NOM}	1924.9985	7.6	3.9	±10
85% of V _{NOM}	1924.9959	7.8	4.1	
115% of V _{NOM}	1924.9936	8.4	4.4	

Deviation ppm = ((Mean - Measured frequency) / Mean) x 10⁶

Carrier Frequency Stability over Temperature

Voltage	Measured Carrier Frequency (MHz)	Difference (kHz)	Deviation (ppm)	Limit (ppm)
Mode 1				
T = +20°C	1924.997	Ref	Ref	±10
T = -20°C	1924.995	7.2	3.7	
T = +50°C	1924.997	7.5	3.9	

$$\text{Deviation ppm} = ((\text{Mean} - \text{Measured frequency}) / \text{Mean}) \times 10^6$$

7.10. Specific Requirements for UPCS Device

7.10.1. Monitoring Time Requirements

Immediately prior to initiating transmission, devices must monitor the combined time and spectrum window in which they intend to transmit. For a period of at least 10 milliseconds for systems designed to use a 10 milliseconds or shorter frame period or at least 20 milliseconds for systems designed to use a 20 milliseconds frame period

7.10.2. Test Procedure Used

ANSI C63.17, Clause 7.5

7.10.3. Test Setup

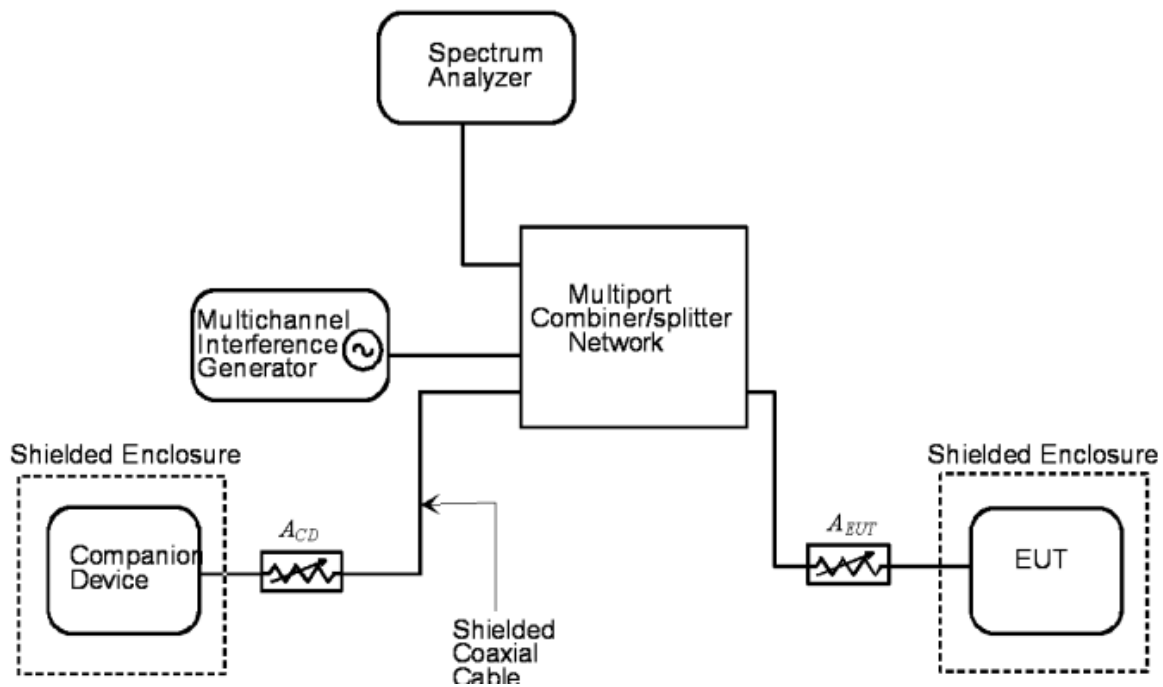

7.10.4. Test Result

Interference (Refer to ANSIC63.17 clause 7.3.4)	Reaction of EUT	Results
Apply the interference on f1 at level TU+UM, and no interference on f2. Initiate transmission and verify the transmission on f2.	EUT transmits on f2	Pass
Apply the interference on f2 at level TU+UM, at the same time, no interference on f1. After about 20ms, initiate transmission and verify the transmission on f1.	EUT transmits on f1	Pass

7.10.5. Lowest Monitoring Threshold Requirements

The monitoring threshold must not be more than 30 dB above the thermal noise power for a bandwidth equivalent to the emission bandwidth used by the device.

7.10.6. Test Procedure Used

ANSI C63.17, Clause 7.3.1

7.10.7. Test Result

Not Apply

7.10.8. Acknowledgements and Transmission Duration Requirements

Occupation of the same combined time and spectrum windows by a device or group of cooperating devices continuously over a period of time longer than 8 hours is not permitted without repeating the access criteria.

Once access to specific combined time and spectrum windows is obtained an acknowledgement from a system participant must be received by the initiating transmitter within one second or transmission must cease.

Periodic acknowledgements must be received at least every 30 seconds or transmission must cease. Channels used exclusively for control and signaling information may transmit continuously for 30 seconds without receiving an acknowledgement, at which time the access criteria must be repeated.

7.10.8.1. Test Procedure Used

ANSI C63.17, Clause 8.2.1 & 8.2.2

7.10.8.2. Test Result

Test ref. to ANSI C63.17 clause 8.2.1	Observation	Verdict
Initial transmission without acknowledgements	Not applicable for EUT that transmits control and signaling information	N/A
Transmission time after loss of acknowledgements	10.0	Pass

Test ref. to ANSI C63.17 clause 8.2.2	Observation	Verdict
Transmission duration on same time and frequency window	Only for initiating device that controls which time slot is used	N/A

7.10.9. Least Interfered Channel (LIC) Selection Requirements

If access to spectrum is not available as determined by the above, and a minimum of 40 duplex system access channels are defined for the system, the time and spectrum windows with the lowest power level below a monitoring threshold of 50 dB above the thermal noise power determined for the emission bandwidth may be accessed.

Calculation of monitoring threshold limits for isochroous devices:

$$\text{Lowest threshold: } TL = -174 + 10 \log_{10} B + M_u + P_{MAX} - P_{EUT} (\text{dBm})$$

$$\text{Upper threshold: } TU = -174 + 10 \log_{10} B + M_u + P_{MAX} - P_{EUT} (\text{dBm})$$

Where: B=Emission bandwidth (Hz)

M_u =dB the threshold may exceed thermal noise (30 for T_L & 50 for T_U)

$$P_{MAX} = 5 * \log_{10} B - 10 (\text{dBm})$$

P_{EUT} =Transmitted power (dBm)

Monitor Threshold	B (MHz)	M_u (dB)	P_{MAX} (dBm)	P_{EUT} (dBm)	Threshold (dBm)
Mode 1					
TL	1.422	30	20.76	20.48	-82.19
TU	1.422	50	20.76	20.48	-62.19

The EUT must not transmit until the interference level is less than or equal to:

Measured Threshold Level \leq TU

Where: TU=Upper threshold level

7.10.9.1. Test Procedure Used

ANSI C63.17, Clause 7.3.2 & 7.3.3 & 7.3.4

7.10.9.2. Test Result

Monitor threshold	Measured Threshold Level	Limit (dBm)
Mode 1		
Lowest Threshold (dBm)	N/A	-82.19
Upper Threshold (dBm)	N/A	-62.19

Note: N/A Not applicable- EUT which supports at least of 40 duplex system access channels and implements Least Interfered Channel (LIC) algorithm is permitted to use an upper monitoring threshold.

7.10.10. Random waiting Requirements

If the selected combined time and spectrum windows are unavailable, the device may either monitor and select different windows or seek to use the same window after waiting an amount of time, randomly chosen from a uniform random distribution between 10 and 150 milliseconds, commencing when the channel becomes available.

7.10.10.1. Test Procedure Used

ANSI C63.17, Clause 8.1.3

7.10.10.2. Test Result

The manufacturer declares that this provision is not utilized by the EUT

7.10.11. Monitoring Bandwidth Requirements

The monitoring system bandwidth must be equal to or greater than the emission bandwidth of the intended transmission and have a maximum reaction time less than $50 \times \text{SQRT}(1.25/\text{emission bandwidth in MHz})$ microseconds for signals at the applicable threshold level but shall not be required to be less than 50 microseconds

7.10.11.1. Test Procedure Used

ANSI C63.17, Clause 7.5

7.10.11.2. Test Result

Test Equation (μs)	B (MHz)	Pulse width(μs)	Limit (us)	Result
Mode 1				
$50 (1.25/B)^{1/2}$	1.422	46.88	50	Pass
$25 (1.25/B)^{1/2}$	1.422	23.44	35	Pass

7.10.12. Monitoring Antenna Requirements

The monitoring system shall use the same antenna used for transmission, or an antenna that yields equivalent reception at that location.

7.10.12.1. Test Procedure Used

ANSI C63.17 paragraph 4

7.10.12.2. Test Result

The antenna of the EUT used for transmission is the same interior antenna that used for monitoring.

7.10.13. Monitoring Antenna Requirements

Devices that have a power output Lowest than the maximum permitted under the rules can increase their monitoring detection threshold by one decibel for each one decibel that the transmitter power is below the maximum permitted

7.10.13.1. Test Procedure Used

ANSI C63.17 paragraph 4

7.10.13.2. Test Reslut

Not apply

7.10.14. Dual Access Criteria Check Requirements

An initiating device may attempt to establish a duplex connection by monitors both its intended transmit and receive time and spectrum windows. If both the intended transmit and receive time and spectrum windows meet the access criteria, then the initiating device can initiate a transmission in the intended transmit time and spectrum window. If the power detected by the responding device can be decoded as a duplex connection signal from the initiating device, then the responding device may immediately begin transmitting on the receive time and spectrum window monitored by the initiating device.

7.10.14.1. Test Procedure Used

ANSI C63.17, Clause 8.3.1 & 8.3.2

7.10.14.2. Test Result

EUT that do NOT implements the LIC procedure:

Test ref. to ANSI C63.17 clause 8.3.1	Observation	Verdict
b) EUT is restricted to a single carrier $f1$ for TDMA systems. The Test is Pass if EUT can transmit	EUT can transmit	Pass
c) d) Interference at level $T_L + U_M$ on all timeslots except one receive slot where interference is at least 10 dB below T_L	No connection possible	N/A
e) f) Interference at level $T_L + U_M$ on all timeslots except one transmit slot where interference is at least 10 dB below T_L	No connection possible	N/A

EUTs that implements the LIC procedure:

Test ref. to ANSI C63.17 clause 8.3.1	Observation	Verdict
b) EUT is restricted to a single carrier $f1$ for TDMA systems. The Test is Pass if EUT can transmit	EUT can transmit	Pass
c) d) Transmission on interference-free receive time/spectrum window	Connected on the target Rx window and its duplex mate.	Pass
e) f) Transmission on interference-free transmit time/spectrum window	Connected on the target Tx window and its duplex mate.	Pass

7.10.15. Alternative monitoring interval for co-located devices Requirements

An initiating device that is prevented from monitoring during its intended transmit window due to monitoring system blocking from the transmissions of a co-located (within one meter) transmitter of the same system, may monitor the portions of the time and spectrum windows in which they intend to receive over a period of at least 10 milliseconds. The monitored time and spectrum window must total at least 50 percent of the 10 millisecond frame interval and the monitored spectrum must be within 1.25 MHz of the center frequency of channel(s) already occupied by that device or co-located co-operating devices. If the access criteria is met for the intended receive time and spectrum window under the above conditions, then transmission in the intended transmit window by the initiating device may commence.

7.10.15.1. Test Procedure Used

ANSI C63.17, Clause 8.4

7.10.15.2. Test Result

The manufacturer declares that this provision is not utilized by the EUT.

7.10.16. Frame Repetition Stability and Period and Jitter

7.10.16.1. Test Limit

The frame period (a set of consecutive time slots in which the position of each time slot can be identified by reference to a synchronizing source) of an intentional radiator operating in this band shall be 20 milliseconds or 10 milliseconds/X where X is a positive whole number. Each device that implements time division for the purposes of maintaining a duplex connection on a given frequency carrier shall maintain a frame repetition rate with a frequency stability of at least 50 parts per million (ppm). Each device which further divides access in time in order to support multiple communication links on a given frequency carrier shall maintain a frame repetition rate with a frequency stability of at least 10 ppm. The jitter (time-related, abrupt, spurious variations in the duration of the frame interval) introduced at the two ends of such a communication link shall not exceed 25 microseconds for any two consecutive transmissions. Transmissions shall be continuous in every time and spectrum window during the frame period defined for the device.

7.10.16.2. Test Procedure Used

ANSI C63.17, Clause 6.2.2 & 6.2.3

7.10.16.3. Test Setup

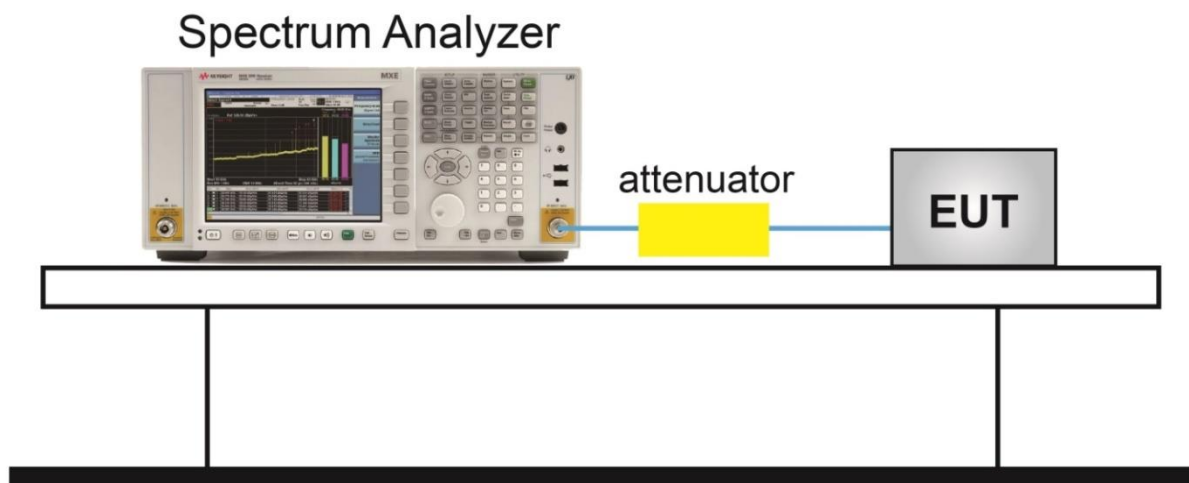

7.10.16.4. Test Result

Carrier Frequency (MHz)	Frame Jitter (us)					Limit of Δ
	min	mean	max	Δ min	Δ max	
1924.992	-0.74	0	0.99	-0.74	0.99	± 25

8. CONCLUSION

The data collected relate only the item(s) tested and show that the unit is compliance with Part 15D of the FCC Rule.

_____ The End _____

Appendix A - Test Setup Photograph

Refer to "1911RSU014-UT" file.

Appendix B - EUT Photograph

Refer to "1911RSU014-UE" file.