



MEASUREMENT REPORT

FCC PART 15.247 WLAN 802.11b/g/n

FCC ID: P27SCH2R0

APPLICANT: Sercomm Corporation

Application Type: Certification

Product: Indoor Camera

Model No.: SCH2R0-29xxxxx
(the 1st x should be "blank" or "-"; the rest x could be 0 to 9, A to Z, a to z, "blank" or "-", for the marketing purpose)

Brand Name: ADT

FCC Classification: (DTS) Digital Transmission System

FCC Rule Part(s): Part 15.247

Test Procedure(s): ANSI C63.10-2013, KDB 558074 D01v05r02

Received Date: November 12, 2019

Test Date: November 20 ~ 25, 2019

Tested By : *Peter Syu*
(Peter Syu)

Reviewed By : *Paddy Chen*
(Paddy Chen)

Approved By : *Chenz Ker*
(Chenz Ker)



The test results only relate to the samples tested.

This equipment has been shown to be capable of compliance with the applicable technical standards as indicated in the measurement report and was tested in accordance with the measurement procedures specified in ANSI 63.10-2013. Test results reported herein relate only to the item(s) tested.

The test report shall not be reproduced except in full without the written approval of MRT Technology (Taiwan) Co., Ltd.

Revision History

Report No.	Version	Description	Issue Date	Note
1911TW0101-U2	1.0	Original Report	2019-12-03	

CONTENTS

Description	Page
§2.1033 General Information	5
1. INTRODUCTION	6
1.1. Scope.....	6
1.2. MRT Test Location.....	6
2. PRODUCT INFORMATION	7
2.1. Equipment Description	7
2.2. Working Frequencies for this Report	8
2.3. Test Mode.....	8
2.4. Test Software	8
2.5. Test Configuration.....	9
2.6. EMI Suppression Device(s)/Modifications	9
2.7. Labeling Requirements	9
3. DESCRIPTION of TEST	10
3.1. Evaluation Procedure.....	10
3.2. AC Line Conducted Emissions	10
3.3. Radiated Emissions	11
4. ANTENNA REQUIREMENTS.....	12
5. TEST EQUIPMENT CALIBRATION DATE.....	13
6. MEASUREMENT UNCERTAINTY.....	14
7. TEST RESULT	15
7.1. Summary.....	15
7.2. 6dB Bandwidth Measurement	16
7.2.1. Test Limit.....	16
7.2.2. Test Procedure used	16
7.2.3. Test Setting	16
7.2.4. Test Setup.....	16
7.2.5. Test Result	17
7.3. Output Power Measurement.....	20
7.3.1. Test Limit.....	20
7.3.2. Test Procedure Used.....	20
7.3.3. Test Setting	20
7.3.4. Test Setup.....	20
7.3.5. Test Result of Output Power.....	21
7.4. Power Spectral Density Measurement	22
7.4.1. Test Limit.....	22
7.4.2. Test Procedure Used.....	22
7.4.3. Test Setting	22
7.4.4. Test Setup.....	22
7.4.5. Test Result	23
7.5. Out-of-Band Spurious Emissions Emissions Measurement.....	26

7.5.1.	Test Limit	26
7.5.2.	Test Procedure Used	26
7.5.3.	Test Settintg	26
7.5.4.	Test Setup	26
7.5.5.	Test Result	27
7.6.	Radiated Spurious Emission Measurement.....	34
7.6.1.	Test Limit	34
7.6.2.	Test Procedure Used	34
7.6.3.	Test Setting	34
7.6.4.	Test Setup	36
7.6.5.	Test Result	38
7.7.	Radiated Restricted Band Edge Measurement.....	60
7.7.1.	Test Limit	60
7.7.2.	Test Procedure Used	60
7.7.3.	Test Setting	60
7.7.4.	Test Setup	62
7.7.5.	Test Result	63
7.8.	AC Conducted Emissions Measurement	87
7.8.1.	Test Limit	87
7.8.2.	Test Setup	87
7.8.3.	Test Result	88
8.	CONCLUSION	92
	Appendix A - Test Photograph	93
	Appendix B - External Photograph	94

§2.1033 General Information

Applicant	Sercomm Corporation
Applicant Address	8F, No. 3-1, YuanQu St., NanKang, Taipei 115, Taiwan, R.O.C.
Manufacturer	Sercomm Corporation
Manufacturer Address	8F, No. 3-1, YuanQu St., NanKang, Taipei 115, Taiwan, R.O.C.
Test Site	MRT Technology (Taiwan) Co., Ltd
Test Site Address	No. 38, Fuxing Second Rd., Guishan Dist., Taoyuan City 333, Taiwan (R.O.C)
MRT FCC Registration No.	291082
FCC Rule Part(s)	Part 15.247
Test Device Serial No.	N/A <input type="checkbox"/> Production <input checked="" type="checkbox"/> Pre-Production <input type="checkbox"/> Engineering

Test Facility / Accreditations

1. MRT facility is a FCC registered (Reg. No. 291082) test facility with the site description report on file and is designated by the FCC as an Accredited Test Firm.
2. MRT facility is an IC registered (MRT Reg. No. 21723) test laboratory with the site description on file at Industry Canada.
3. MRT Lab is accredited to ISO 17025 by the Taiwan Accreditation Foundation (TAF Cert. No. 3261) in EMC, Telecommunications and Radio testing for FCC (Designation Number: TW3261), Industry Taiwan, EU and TELEC Rules.

1. INTRODUCTION

1.1. Scope

Measurement and determination of electromagnetic emissions (EMC) of radio frequency devices including intentional and/or unintentional radiators for compliance with the technical rules and regulations of the Federal Communications Commission and the Industry Canada Certification and Engineering Bureau.

1.2. MRT Test Location

The map below shows the location of the MRT LABORATORY, its proximity to the Taoyuan City. These measurement tests were conducted at the MRT Technology (Taiwan) Co., Ltd. Facility located at No.38, Fuxing 2nd Rd., Guishan Dist., Taoyuan City 33377, Taiwan (R.O.C).

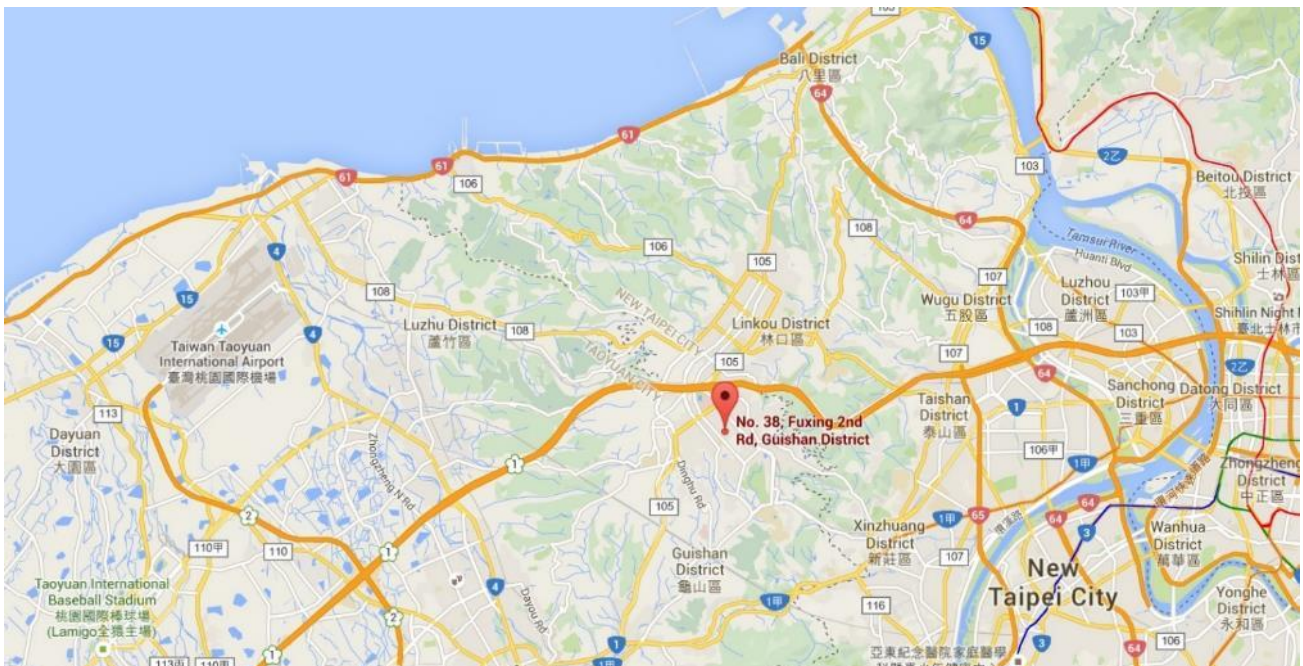

2. PRODUCT INFORMATION

2.1. Equipment Description

Product Name	Indoor Camera
Model Number	SCH2R0-29xxxxx (the 1st x should be "blank" or "-"; the rest x could be 0 to 9, A to Z, a to z, "blank" or "-", for the marketing purpose)
Brand Name	ADT
Supports Radios Spec.	WLAN: 2.4G: 802.11b/g/n-20
Wi-Fi Specification	802.11b/g/n
Frequency Range	2.4GHz: For 802.11b/g/n-HT20: 2412 ~ 2462 MHz
2.4GHz Maximum Output Power	802.11b: 20.37dBm 802.11g: 26.51dBm 802.11n-HT20: 26.43dBm
Type of Modulation	802.11b: DSSS, DBPSK, DQPSK, CCK 802.11g/n-20M: OFDM, BPSK, QPSK, 16QAM, 64QAM
Power Adapter(1)	Brand Name: PHIHONG Model: PSAF10A-050Q Input: AC 100-240V~0.28A, 50-60Hz Output: DC 5V-2.0A
Power Adapter(2)	Brand Name: LUCENT TRANS Model: 1A52-UB52A Input: AC 100-240V~0.3A, 50-60Hz Output: DC 5V-2.0A

2.2. Working Frequencies for this Report

802.11b/g/n-20M

Channel	Frequency	Channel	Frequency	Channel	Frequency
01	2412 MHz	02	2417 MHz	03	2422 MHz
04	2427 MHz	05	2432 MHz	06	2437 MHz
07	2442 MHz	08	2447 MHz	09	2452 MHz
10	2457 MHz	11	2462 MHz	--	--

Duty Cycle

Test Mode	Duty Cycle
802.11b	99%
802.11g	94%
802.11 n-HT20	95%

2.3. Test Mode

Test Mode	Mode 1: Transmit by 802.11b
	Mode 2: Transmit by 802.11g
	Mode 3: Transmit by 802.11n-20M

Note:

- Regarding to the operation frequency, the lowest, middle and highest frequency are selected to perform the test.
- According to the result of Radiated Spurious Emission Measurement (below 1G), the Radiated Spurious Emission Measurement (above 1G) will choose the worst adapter (Model: PSAF10A-050Q) for the test.

2.4. Test Software

The test utility software used during testing was “wl”.

2.5. Test Configuration

This device was tested per the guidance of ANSI C63.10-2013. ANSI C63.10-2013 was used to reference the appropriate EUT setup for radiated spurious emissions testing and AC line conducted testing.

2.6. EMI Suppression Device(s)/Modifications

No EMI suppression device(s) were added and/or no modifications were made during testing.

2.7. Labeling Requirements

Per 2.1074 & 15.19; Docket 95-19

The label shall be permanently affixed at a conspicuous location on the device; instruction manual or pamphlet supplied to the user and be readily visible to the purchaser at the time of purchase. However, when the device is so small wherein placement of the label with specified statement is not practical, only the FCC ID must be displayed on the device per Section 15.19(a)(5). Please see attachment for FCC ID label and label location.

3. DESCRIPTION of TEST

3.1. Evaluation Procedure

The measurement procedures described in the American National Standard for Testing Unlicensed Wireless Devices (ANSI C63.10-2013), and the guidance provided in KDB 558074 D01v05r02 were used in the measurement of the device.

Deviation from measurement procedure.....None

3.2. AC Line Conducted Emissions

The line-conducted facility is located inside an 9'x4'x3' shielded enclosure. A 1m x 2m wooden table 80cm high is placed 40cm away from the vertical wall and 80cm away from the sidewall of the shielded room. Two 10kHz-30MHz, 50Ω/50uH Line-Impedance Stabilization Networks (LISNs) are bonded to the shielded room floor. Power to the LISNs is filtered by external high-current high-insertion loss power line filters. These filters attenuate ambient signal noise from entering the measurement lines. These filters are also bonded to the shielded enclosure.

The EUT is powered from one LISN and the support equipment is powered from the second LISN. All interconnecting cables more than 1 meter were shortened to a 1 meter length by non-inductive bundling (serpentine fashion) and draped over the back edge of the test table. All cables were at least 40cm above the horizontal reference ground-plane. Power cables for support equipment were routed down to the second LISN while ensuring that that cables were not draped over the second LISN.

Sufficient time for the EUT, support equipment, and test equipment was allowed in order for them to warm up to their normal operating condition. The RF output of the LISN was connected to the receiver and exploratory measurements were made to determine the frequencies producing the maximum emission from the EUT. The receiver was scanned from 150kHz to 30MHz. The detector function was set to peak mode for exploratory measurements while the bandwidth of the analyzer was set to 9kHz. The EUT, support equipment, and interconnecting cables were arranged and manipulated to maximize each emission. Each emission was also maximized by varying: power lines, the mode of operation or data exchange speed, or support equipment which determined the worst-case emission. Once the worst case emissions have been identified, the one EUT cable configuration/arrangement and mode of operation that produced these emissions are used for final measurements on the same test site. The analyzer is set to CISPR quasi-peak and average detectors with a 9kHz resolution bandwidth for final measurements.

An extension cord was used to connect to a single LISN which powered by EUT. The extension cord was calibrated with LISN, the impedance and insertion loss are compliance with the requirements as stated in ANSI C63.10-2013.

Line conducted emissions test results are shown in Section 7.8.

3.3. Radiated Emissions

The radiated test facilities consisted of an indoor 3 meter semi-anechoic chamber used for final measurements and exploratory measurements, when necessary. The measurement area is contained within the semi-anechoic chamber which is shielded from any ambient interference. For measurements above 1GHz absorbers are arranged on the floor between the turn table and the antenna mast in such a way so as to maximize the reduction of reflections. For measurements below 1GHz, the absorbers are removed. A MF Model 210SS turntable is used for radiated measurement. It is a continuously rotatable, remote controlled, metallic turntable and 2 meters (6.56 ft.) in diameter. The turn table is flush with the raised floor of the chamber in order to maintain its function as a ground plane. An 80cm high PVC support structure is placed on top of the turntable. For all measurements, the spectrum was scanned through all EUT azimuths and from 1 to 4 meter receive antenna height using a broadband antenna from 30MHz up to the upper frequency shown in 15.33(b)(1) depending on the highest frequency generated or used in the device or on which the device operates or tunes. For frequencies above 1GHz, linearly polarized double ridge horn antennas were used. For frequencies below 30MHz, a calibrated loop antenna was used. When exploratory measurements were necessary, they were performed at 1 meter test distance inside the semi-anechoic chamber using broadband antennas, broadband amplifiers, and spectrum analyzers to determine the frequencies and modes producing the maximum emissions. Sufficient time for the EUT, support equipment, and test equipment was allowed in order for them to warm up to their normal operating condition. The test set-up for frequencies below 1GHz was placed on top of the 0.8 meter high, 1 x 1.5 meter table; and test set-up for frequencies 1-40GHz was placed on top of the 1.5 meter high, 1 x 1.5 meter table. The EUT, support equipment, and interconnecting cables were arranged and manipulated to maximize each emission. Appropriate precaution was taken to ensure that all emissions from the EUT were maximized and investigated. The system configuration, clock speed, mode of operation or video resolution, if applicable, turntable azimuth, and receive antenna height was noted for each frequency found.

Final measurements were made in the semi-anechoic chamber using calibrated, linearly polarized broadband and horn antennas. The test setup was configured to the setup that produced the worst case emissions. The spectrum analyzer was set to investigate all frequencies required for testing to compare the highest radiated disturbances with respect to the specified limits. The turntable containing the EUT was rotated through 360 degrees and the height of the receive antenna was varied 1 to 4 meters and stopped at the azimuth and height producing the maximum emission. Each emission was maximized by changing the orientation of the EUT through three orthogonal planes and changing the polarity of the receive antenna, which produced the worst-case emissions.

According to 3dB Beam-Width of horn antenna, the horn antenna should be always directed to the EUT when rising height.

Radiated emissions test results are shown in Section 7.6 & 7.7 .

4. ANTENNA REQUIREMENTS

Excerpt from §15.203 of the FCC Rules/Regulations:

“An intentional radiator antenna shall be designed to ensure that no antenna other than that furnished by the responsible party can be used with the device. The use of a permanently attached antenna or of an antenna that uses a unique coupling to the intentional radiator shall be considered sufficient to comply with the provisions of this section.”

- The antenna of the **Indoor Camera**, is permanently attached.
- There are no provisions for connection to an external antenna.

Conclusion:

The EUT unit complies with the requirement of §15.203.

Antenna List

No.	Manufacturer	Part No.	Antenna Type	Peak Gain
1	SerComm Corporation	WiFi_2.4G	FPCB	2.71dBi

5. TEST EQUIPMENT CALIBRATION DATE

Conducted Emissions – SR2

Instrument	Manufacturer	Type No.	Asset No.	Cali. Interval	Cali. Due Date
Two-Line V-Network	R&S	ENV216	MRTTWA00019	1 year	2020/3/25
Cable	Rosnol	N1C50-RG400- B1C50-500CM	MRTTWE00013	1 year	2020/6/18
EMI Test Receiver	R&S	ESR3	MRTTWA00009	1 year	2020/3/25

Radiated Emissions – AC1

Instrument	Manufacturer	Type No.	Asset No.	Cali. Interval	Cali. Due Date
Broadband TRILOG Antenna	SCHWARZBECK	VULB 9162	MRTTWA00001	1 year	2020/6/4
EMI Test Receiver	R&S	ESR3	MRTTWA00009	1 year	2020/3/25
Active Loop Antenna	Schwarzbeck	FMZB 1519B	MRTTWA00002	1 year	2020/4/29
Broadband Horn antenna	SCHWARZBECK	BBHA 9120D	MRTTWA00003	1 year	2020/4/22
Breitband Hornantenna	Schwarzbeck	BBHA 9170	MRTTWA00004	1 year	2020/4/23
Broadband Amplifier	Schwarzbeck	BBV 9721	MRTTWA00006	1 year	2020/4/24
Broadband Preamplifier	SCHWARZBECK	BBV 9718	MRTTWA00005	1 year	2020/4/24
Cable	HUBERSUHNER	SF106	MRTTWE00010	1 year	2020/4/22
Cable	Rosnol	K1K50-UP0264- K1K50-4M	MRTTWE00012	1 year	2020/6/18

Conducted Test Equipment – SR2

Instrument	Manufacturer	Type No.	Asset No.	Cali. Interval	Cali. Due Date
EXA Signal Analyzer	KEYSIGHT	N9010A	MRTTWA00012	1 year	2020/10/2
EXA Signal Analyzer	KEYSIGHT	N9010B	MRTTWA00074	1 year	2020/7/11
USB Wideband Power Sensor	KEYSIGHT	U2021XA	MRTTWA00015	1 year	2020/3/26

Test Software

Software	Version	Function
e3	9.160520a	EMI Test Software
EMI	V3	EMI Test Software

6. MEASUREMENT UNCERTAINTY

Where relevant, the following test uncertainty levels have been estimated for tests performed on the EUT as specified in CISPR 16-4-2. This uncertainty represents an expanded uncertainty expressed at approximately the 95% confidence level using a coverage factor of $k = 2$.

Conducted Emission- Power Line
Measuring Uncertainty for a Level of Confidence of 95% ($U=2Uc(y)$): 2.53dB
Conducted Emission- Impedance Stabilization Network Measurement
Measuring Uncertainty for a Level of Confidence of 95% ($U=2Uc(y)$): 3.96dB
Radiated Spurious Emission
Measuring Uncertainty for a Level of Confidence of 95% ($U=2Uc(y)$): 3.92dB (Below 30M)
Measuring Uncertainty for a Level of Confidence of 95% ($U=2Uc(y)$): 4.25dB (30M~1G)
Measuring Uncertainty for a Level of Confidence of 95% ($U=2Uc(y)$): 4.40dB (1G~18G)
Measuring Uncertainty for a Level of Confidence of 95% ($U=2Uc(y)$): 4.45dB (18G~40G)
Frequency Error
Measuring Uncertainty for a Level of Confidence of 95% ($U=2Uc(y)$): $\pm 78.4\text{Hz}$
Conducted Power
Measuring Uncertainty for a Level of Confidence of 95% ($U=2Uc(y)$): $\pm 0.84\text{dB}$
Conducted Spurious Emission
Measuring Uncertainty for a Level of Confidence of 95% ($U=2Uc(y)$): $\pm 2.65\text{ dB}$
Occupied Bandwidth
Measuring Uncertainty for a Level of Confidence of 95% ($U=2Uc(y)$): 3.3%
Temp. / Humidity
Measuring Uncertainty for a Level of Confidence of 95% ($U=2Uc(y)$): $\pm 0.82^\circ\text{C} / \pm 3\%$
DC Voltage
Measuring Uncertainty for a Level of Confidence of 95% ($U=2Uc(y)$): $\pm 0.3\%$

7. TEST RESULT

7.1. Summary

Product Name: Indoor Camera
FCC Classification: (DTS) Digital Transmission System
Data Rate(s) Tested: 1Mbps ~ 11Mbps (b); 6Mbps ~ 54Mbps (g);
6.5/7.2Mbps ~ 65/72.2Mbps (n-20M);

FCC Part Section(s)	Test Description	Test Limit	Test Condition	Test Result	Reference
15.247(a)(2)	6dB Bandwidth	$\geq 500\text{kHz}$	Conducted	Pass	Section 7.2
15.247(b)(3)	Output Power	$\leq 30.00\text{dBm}$		Pass	Section 7.3
15.247(e)	Power Spectral Density	$\leq 8.00\text{dBm}/3\text{kHz}$		Pass	Section 7.4
15.247(d)	Out-of-Band Emissions	Conducted $\geq 20\text{dBc}$		Pass	Section 7.5
15.205 15.209	Spurious Emission	< FCC 15.209 limits	Radiated	Pass	Section 7.6
15.205 15.209	Band Edge Measurement	$\cong 74\text{dBuV/m(Peak)}$ $\cong 54\text{dBuV/m(Average)}$		Pass	Section 7.7
15.207	AC Conducted Emissions 150kHz - 30MHz	< FCC 15.207 limits	Line Conducted	Pass	Section 7.8

Notes:

- 1) Determining compliance is based on the test results met the regulation limits or requirements declared by clients, and the test results don't take into account the value of measurement uncertainty.
- 2) All modes of operation and data rates were investigated. For radiated emission test, every axis (X, Y, Z) was also verified. The test results shown in the following sections represent the worst case emissions.
- 3) The analyzer plots shown in this section were all taken with a correction table loaded into the analyzer. The correction table was used to account for the losses of the cables and attenuators used as part of the system to connect the EUT to the analyzer at all frequencies of interest.
- 4) All antenna port conducted emissions testing was performed on a test bench with the antenna port of the EUT connected to the spectrum analyzer through calibrated cables and attenuators.

7.2. 6dB Bandwidth Measurement

7.2.1. Test Limit

The minimum 6dB bandwidth shall be at least 500 kHz.

7.2.2. Test Procedure used

KDB 558074 D01v05r02- Section 8.2 Option 2

7.2.3. Test Setting

1. The Spectrum's automatic bandwidth measurement capability was used to perform the 6dB bandwidth measurement. The "X" dB bandwidth parameter was set to $X = 6$. The bandwidth measurement was not influenced by any intermediate power nulls in the fundamental emission.
2. Set RBW = 100 kHz
3. VBW $\geq 3 \times$ RBW
4. Detector = Peak
5. Trace mode = max hold
6. Sweep = auto couple
7. Allow the trace was allowed to stabilize

7.2.4. Test Setup

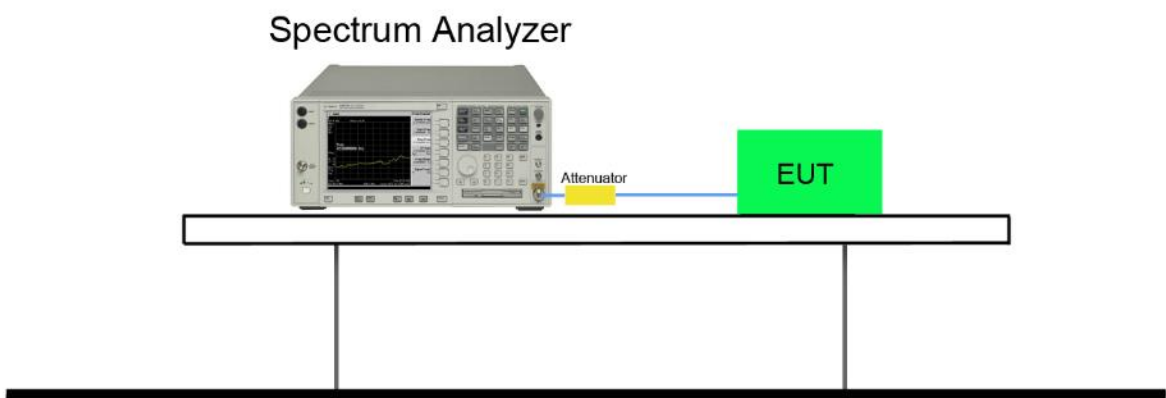

7.2.5. Test Result

Test Mode	Channel No.	Frequency (MHz)	6dB Bandwidth (MHz)	Limit (MHz)	Result
802.11b	01	2412	9.052	≥ 0.5	Pass
802.11b	06	2437	8.114	≥ 0.5	Pass
802.11b	11	2462	8.584	≥ 0.5	Pass
802.11g	01	2412	15.150	≥ 0.5	Pass
802.11g	06	2437	15.150	≥ 0.5	Pass
802.11g	11	2462	15.150	≥ 0.5	Pass
802.11n-20M	01	2412	15.120	≥ 0.5	Pass
802.11n-20M	06	2437	15.150	≥ 0.5	Pass
802.11n-20M	11	2462	15.060	≥ 0.5	Pass

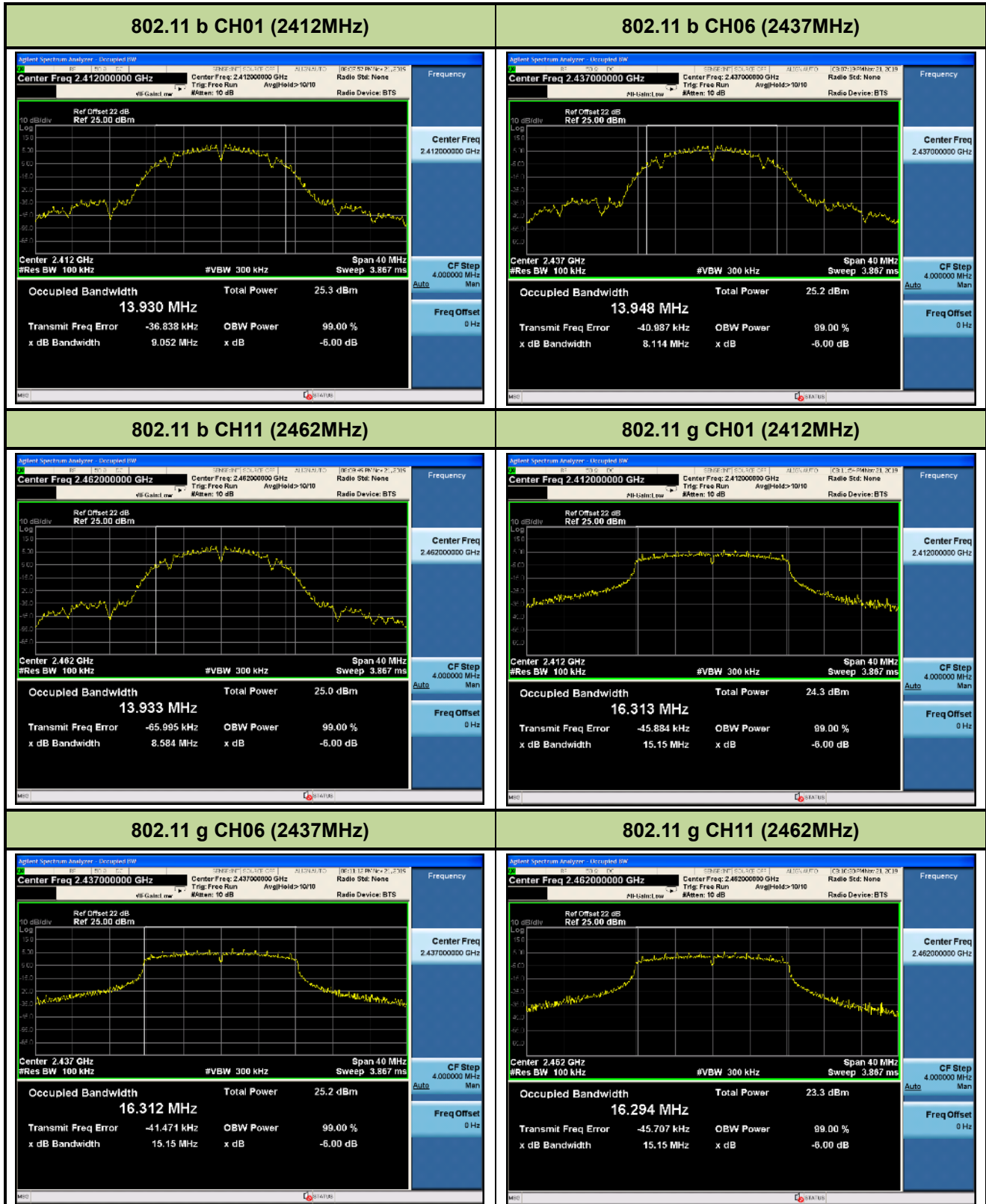

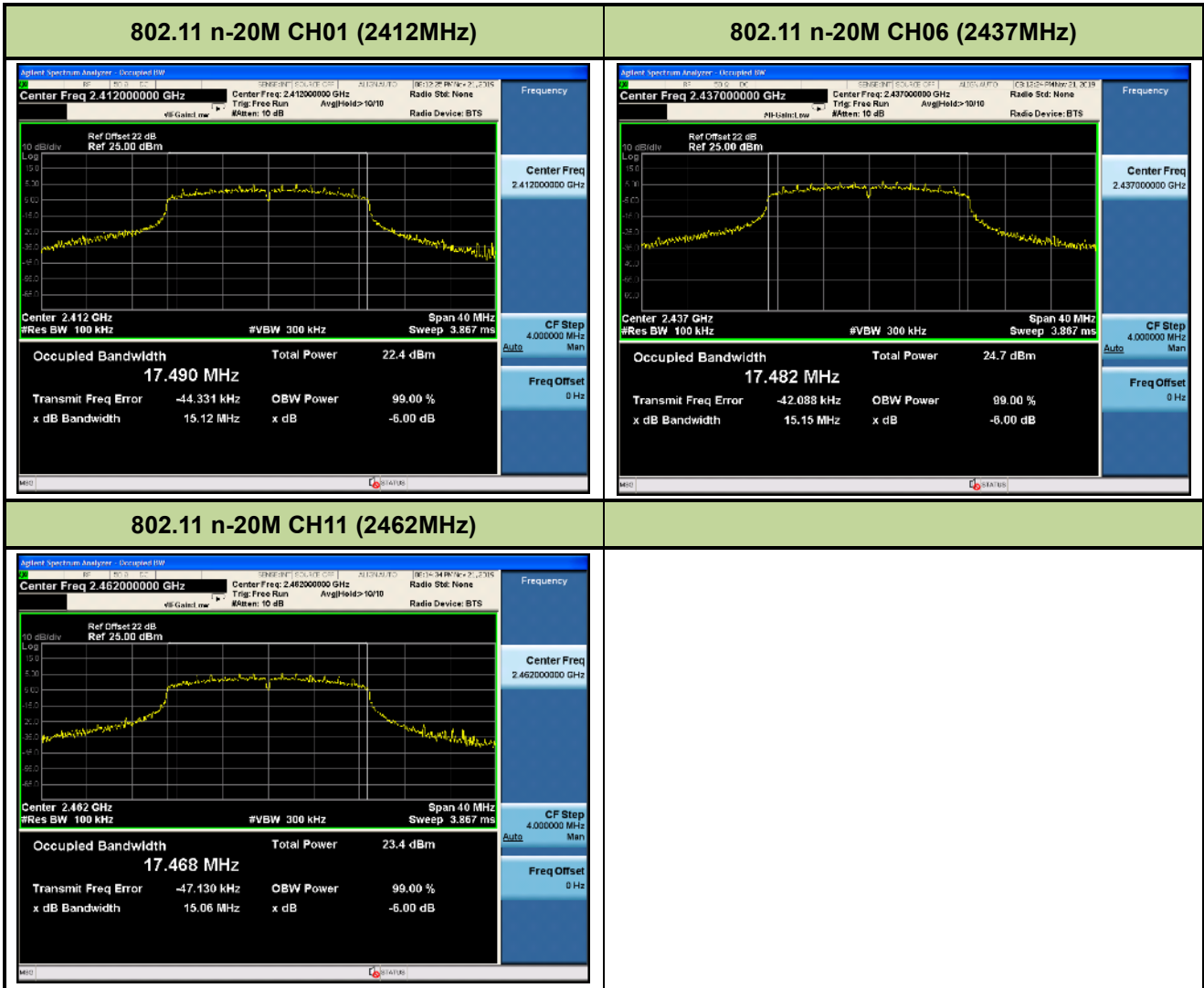

7.3. Output Power Measurement

7.3.1. Test Limit

The maximum out power shall be less 1 Watt (30dBm).

7.3.2. Test Procedure Used

KDB 558074 D01v05r02 - Section 8.3.1.2 & 8.3.2.3

7.3.3. Test Setting

Peak Power Measurement

The maximum peak conducted output power may be measured using a broadband peak RF power meter. The power meter shall have a video bandwidth that is greater than or equal to the DTS bandwidth and shall utilize a fast-responding diode detector.

Average Power Measurement

Average power measurements were performed only when the EUT was transmitting at its maximum power control level using a broadband power meter with a pulse sensor. The power meter implemented triggering and gating capabilities which were set up such that power measurements were recorded only during the ON time of the transmitter. The trace was averaged over 100 traces to obtain the final measured average power.

7.3.4. Test Setup

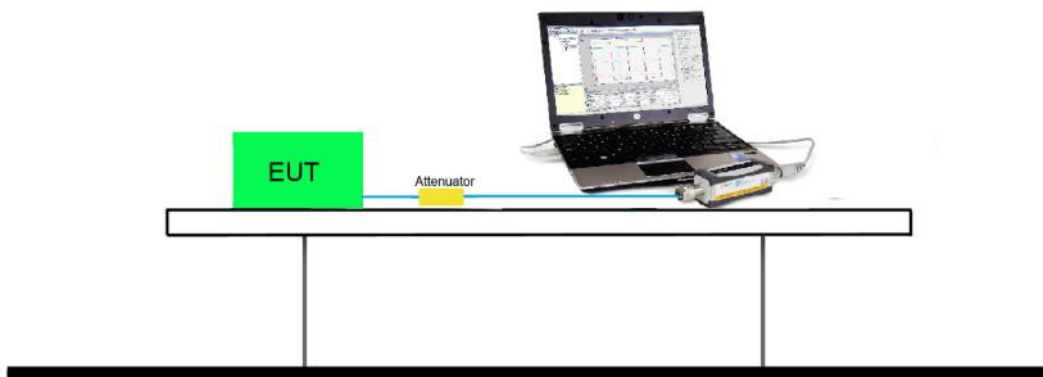

7.3.5. Test Result of Output Power

2.4GHz 802.11b RF Output Power (dBm)											
Channel No.	Frequency (MHz)	Average Power For different Data Rate (Mbps)				Peak Power	Required Limit				
		1	2	6	11						
01	2412	17.97	--	--	--	20.37	1Watt= 30 dBm				
06	2437	17.99	17.96	17.94	17.91	20.28	1Watt= 30 dBm				
11	2462	17.91	--	--	--	20.30	1Watt= 30 dBm				
2.4GHz 802.11g RF Output Power (dBm)											
Channel No.	Frequency (MHz)	Average Power For different Data Rate (Mbps)								Peak Power	Required Limit
		6	9	12	18	24	36	48	54		
01	2412	17.56	--	--	--	--	--	--	--	26.40	1Watt= 30 dBm
06	2437	18.56	18.48	18.44	18.40	18.34	17.67	17.13	16.61	26.51	1Watt= 30 dBm
11	2462	16.47	--	--	--	--	--	--	--	26.15	1Watt= 30 dBm
2.4GHz 802.11n-20M RF Output Power (dBm)											
Channel No.	Frequency (MHz)	Average Power For different Data Rate (Mbps)								Peak Power	Required Limit
		MCS0	MCS1	MCS2	MCS3	MCS4	MCS5	MCS6	MCS7		
01	2412	15.45	--	--	--	--	--	--	--	25.89	1Watt= 30 dBm
06	2437	17.28	17.09	16.78	16.59	16.46	16.07	15.54	15.22	26.43	1Watt= 30 dBm
11	2462	16.28	--	--	--	--	--	--	--	25.75	1Watt= 30 dBm

Note: Output power = Reading value on power meter + duty cycle factor + cable loss °

7.4. Power Spectral Density Measurement

7.4.1. Test Limit

The maximum permissible power spectral density is 8dBm in any 3 kHz band.

7.4.2. Test Procedure Used

KDB 558074 D01v05r02 - Section 8.4 Method PKPSD

7.4.3. Test Setting

This procedure shall be used if maximum peak conducted output power was used to demonstrate compliance, and is optional if the maximum conducted (average) output power was used to demonstrate compliance.

- a) Set analyzer center frequency to DTS channel center frequency.
- b) Set the span to 1.5 times the DTS bandwidth.
- c) Set the RBW to: 3 kHz.
- d) Set the VBW $\geq 3 \times$ RBW.
- e) Detector = peak.
- f) Sweep time = auto couple.
- g) Trace mode = max hold.
- h) Allow trace to fully stabilize.
- i) Use the peak marker function to determine the maximum amplitude level within the RBW.

7.4.4. Test Setup

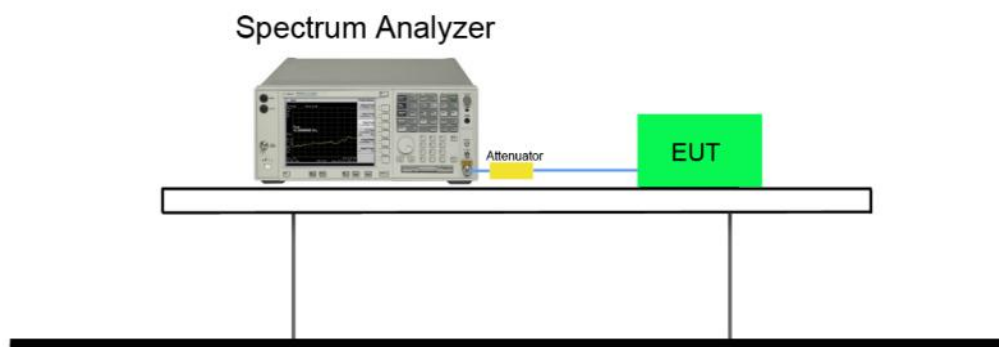

7.4.5. Test Result

Test Mode	Channel No.	Freq. (MHz)	PSD (dBm)	Limit (dBm)	Result
11b	1	2412	-3.498	≤ 8	Pass
11b	6	2437	-4.386	≤ 8	Pass
11b	11	2462	-4.548	≤ 8	Pass
11g	1	2412	-6.346	≤ 8	Pass
11g	6	2437	-5.629	≤ 8	Pass
11g	11	2462	-8.344	≤ 8	Pass
11n-20M	1	2412	-9.265	≤ 8	Pass
11n-20M	6	2437	-7.617	≤ 8	Pass
11n-20M	11	2462	-8.220	≤ 8	Pass

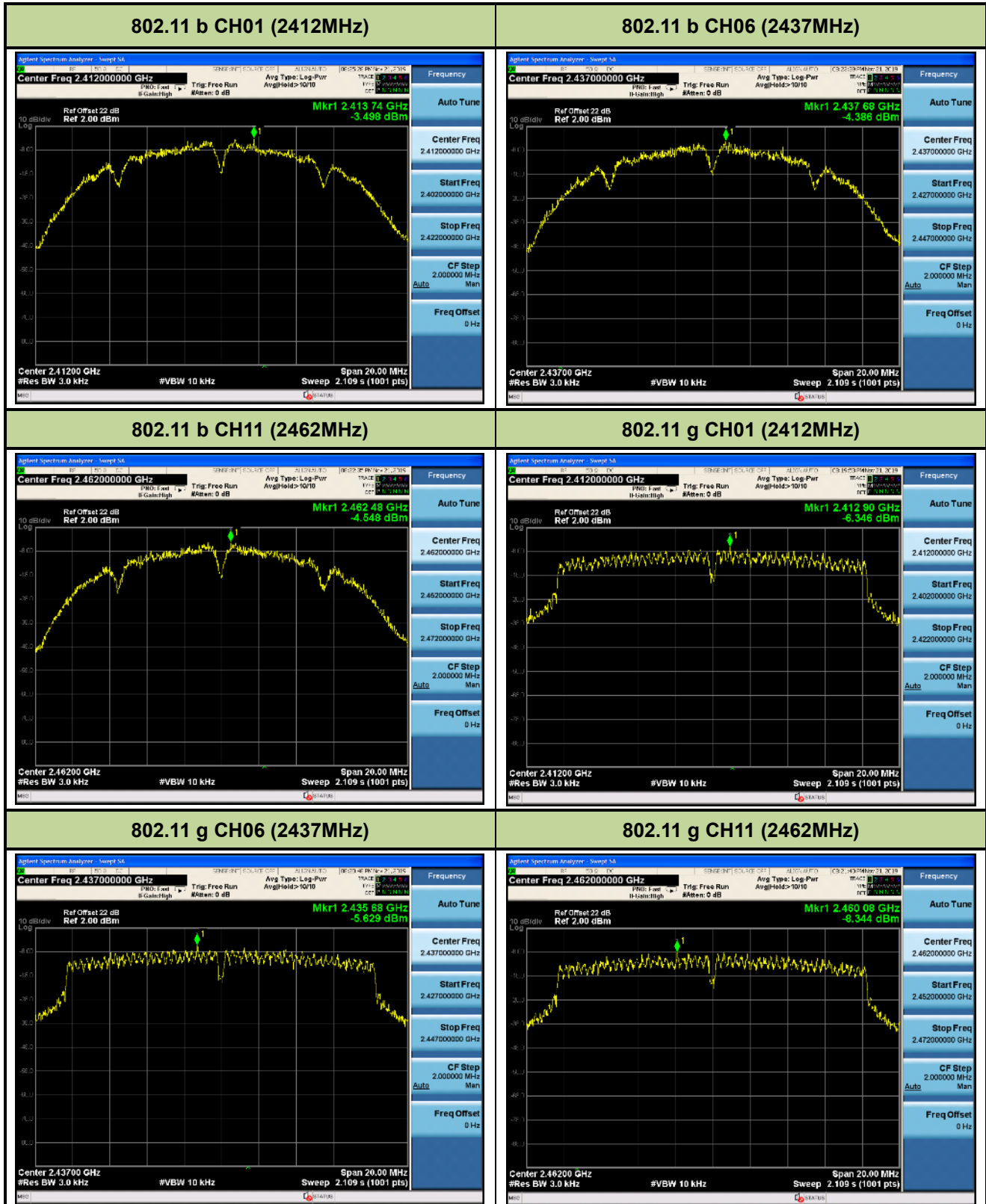

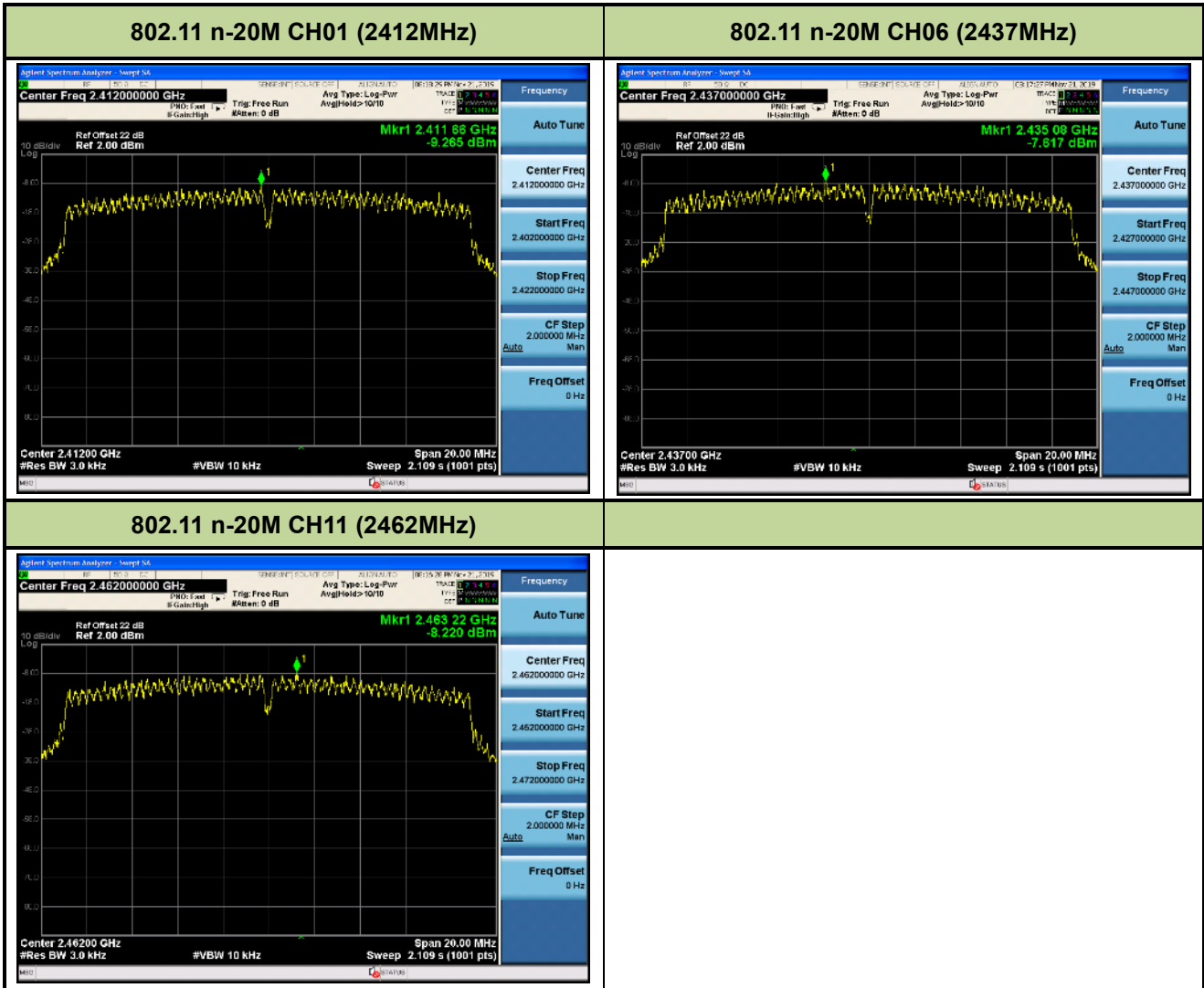

7.5. Out-of-Band Spurious Emissions Emissions Measurement

7.5.1. Test Limit

In any 100 kHz bandwidth outside the frequency band in which the spread spectrum or digitally modulated intentional radiator is operating, the radio frequency power that is produced by the intentional radiator shall be at least 20 dB below that in the 100 kHz bandwidth within the band that contains the highest level of the desired power, based on RF conducted measurement, provided the transmitter demonstrates compliance with the peak conducted power limits.

7.5.2. Test Procedure Used

KDB 558074 D01v05r02- Section 11.1 & 11.2

7.5.3. Test Setting

- (a) Set instrument center frequency to DTS channel center frequency
- (b) Set the span to ≥ 1.5 times the DTS bandwidth
- (c) Set the RBW = 100 kHz
- (d) Set the VBW $\geq 3 \times$ RBW
- (e) Detector = peak
- (f) Sweep time = auto couple
- (g) Trace mode = max hold
- (h) Allow trace to fully stabilize

7.5.4. Test Setup

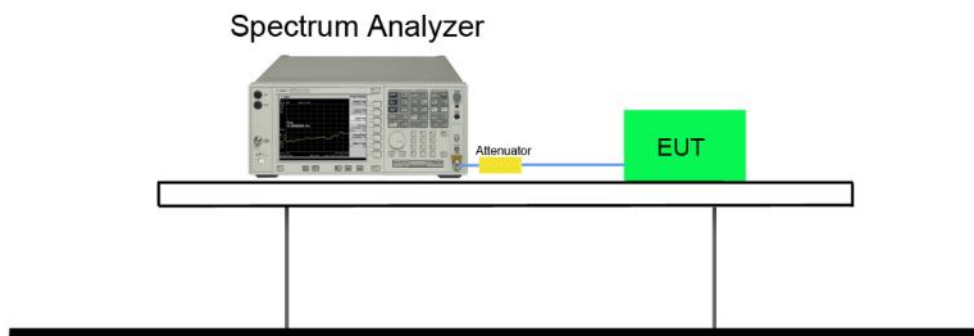

7.5.5. Test Result

Test Mode	Channel No.	Frequency (MHz)	Limit	Result
802.11b	01	2412	20dBc	Pass
802.11b	06	2437	20dBc	Pass
802.11b	11	2462	20dBc	Pass
802.11g	01	2412	20dBc	Pass
802.11g	06	2437	20dBc	Pass
802.11g	11	2462	20dBc	Pass
802.11n-20M	01	2412	20dBc	Pass
802.11n-20M	06	2437	20dBc	Pass
802.11n-20M	11	2462	20dBc	Pass

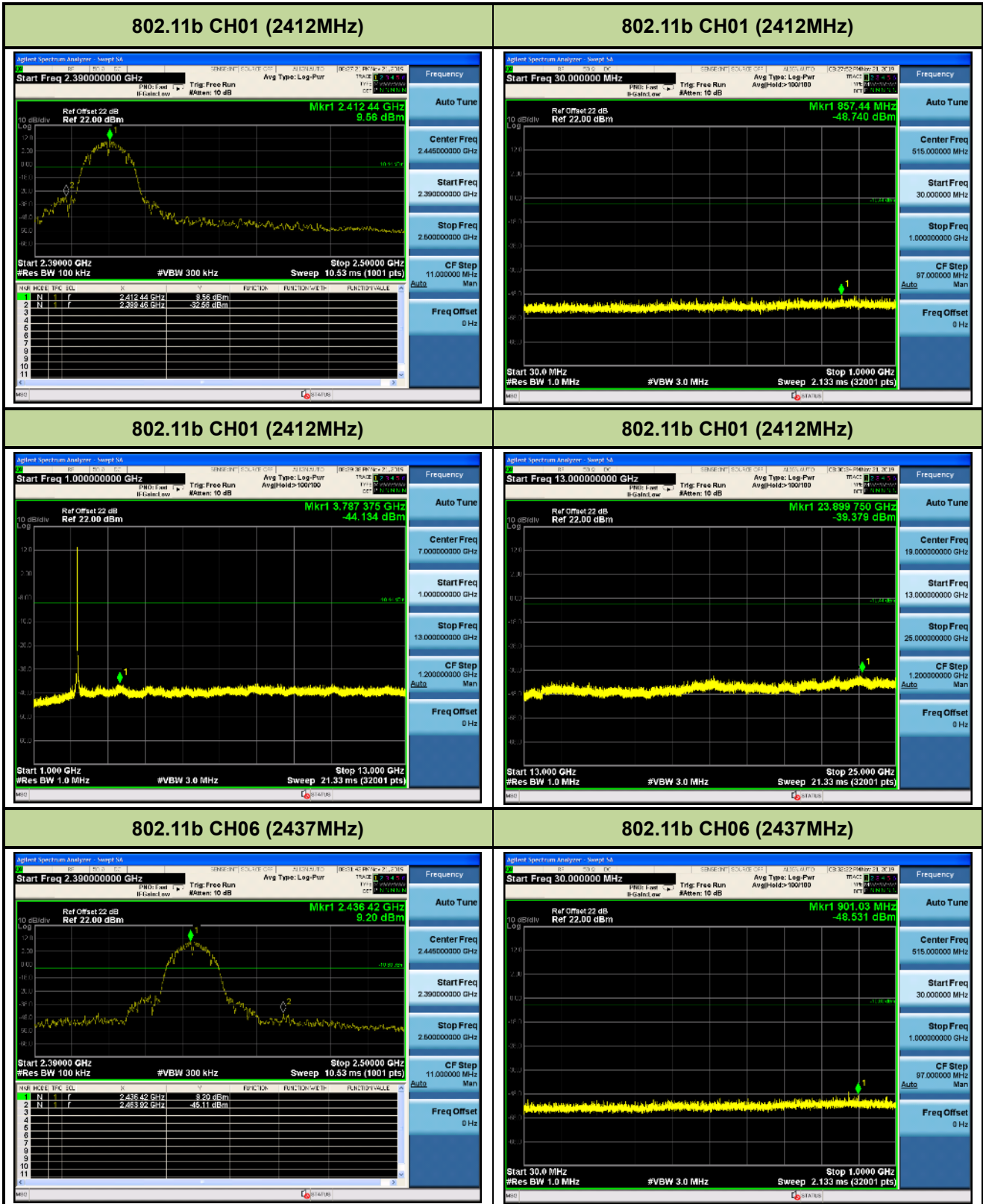

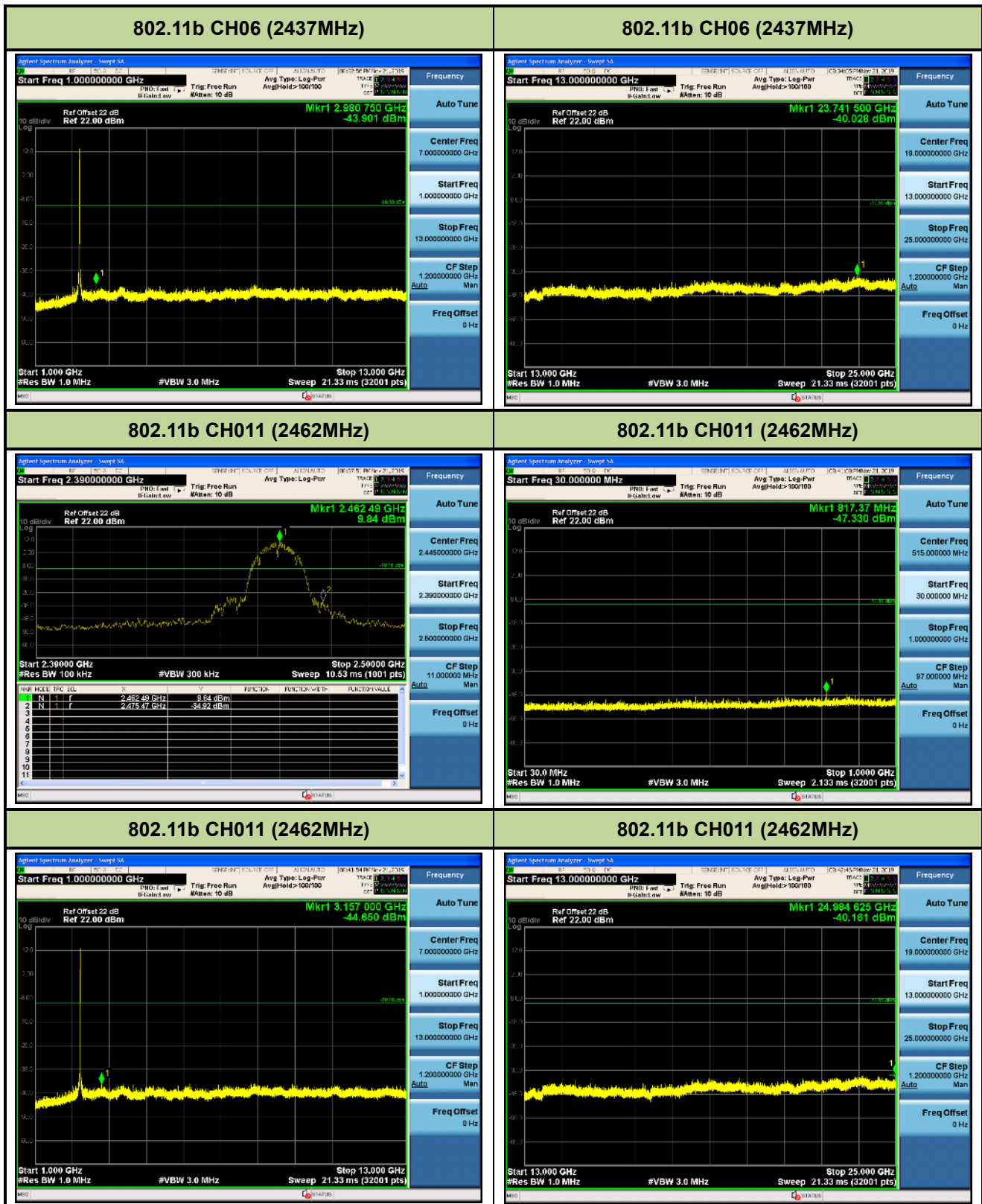

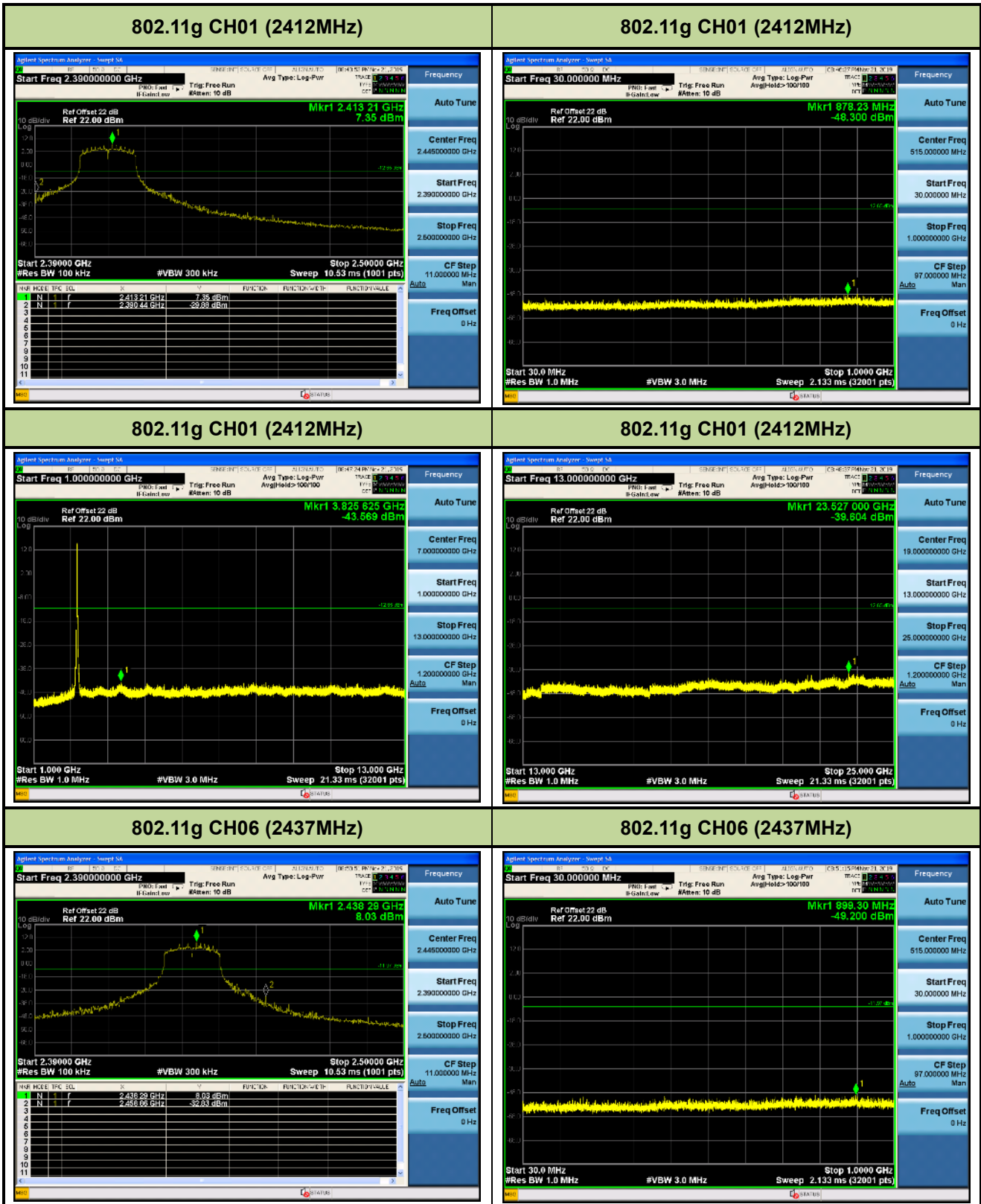

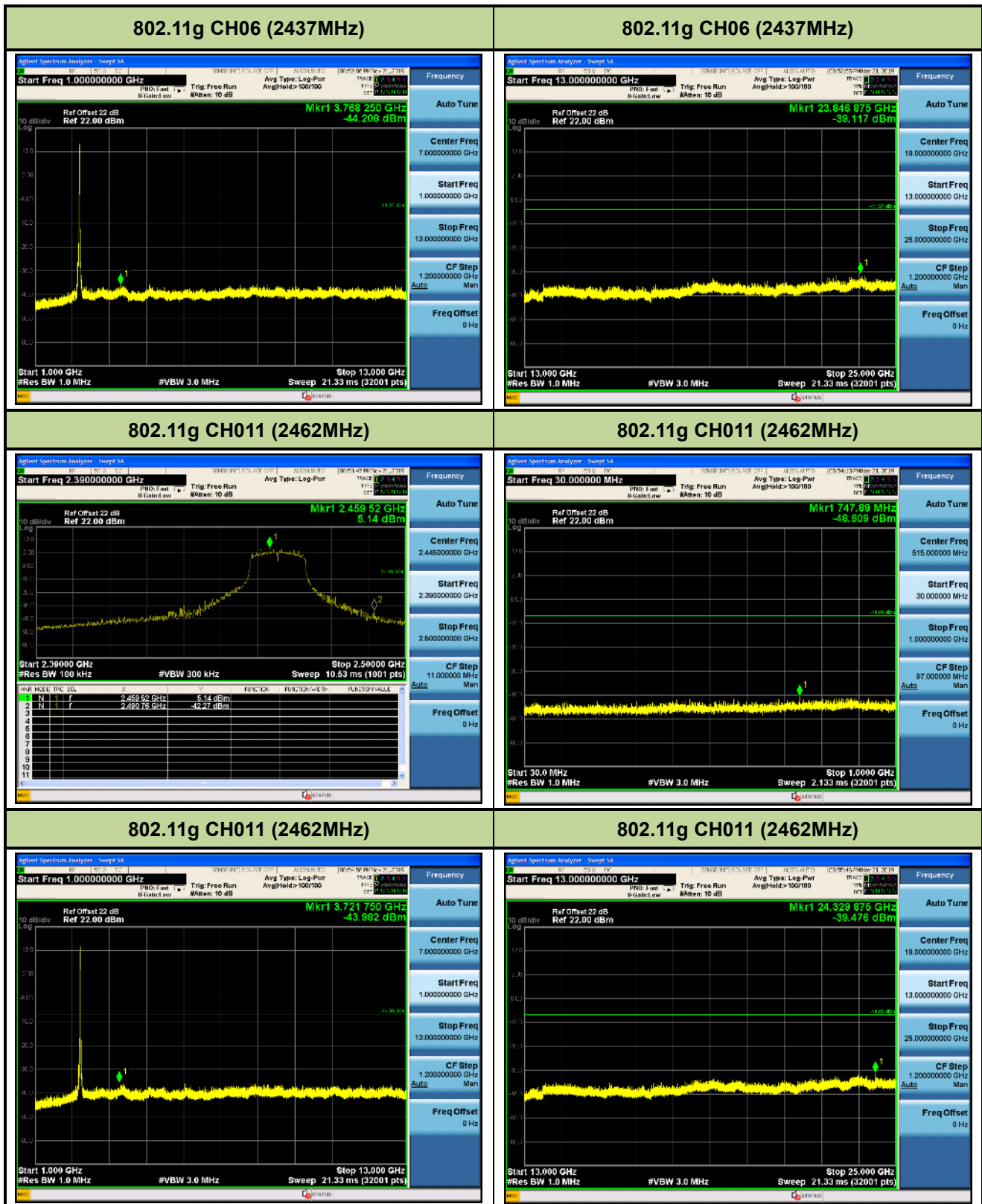

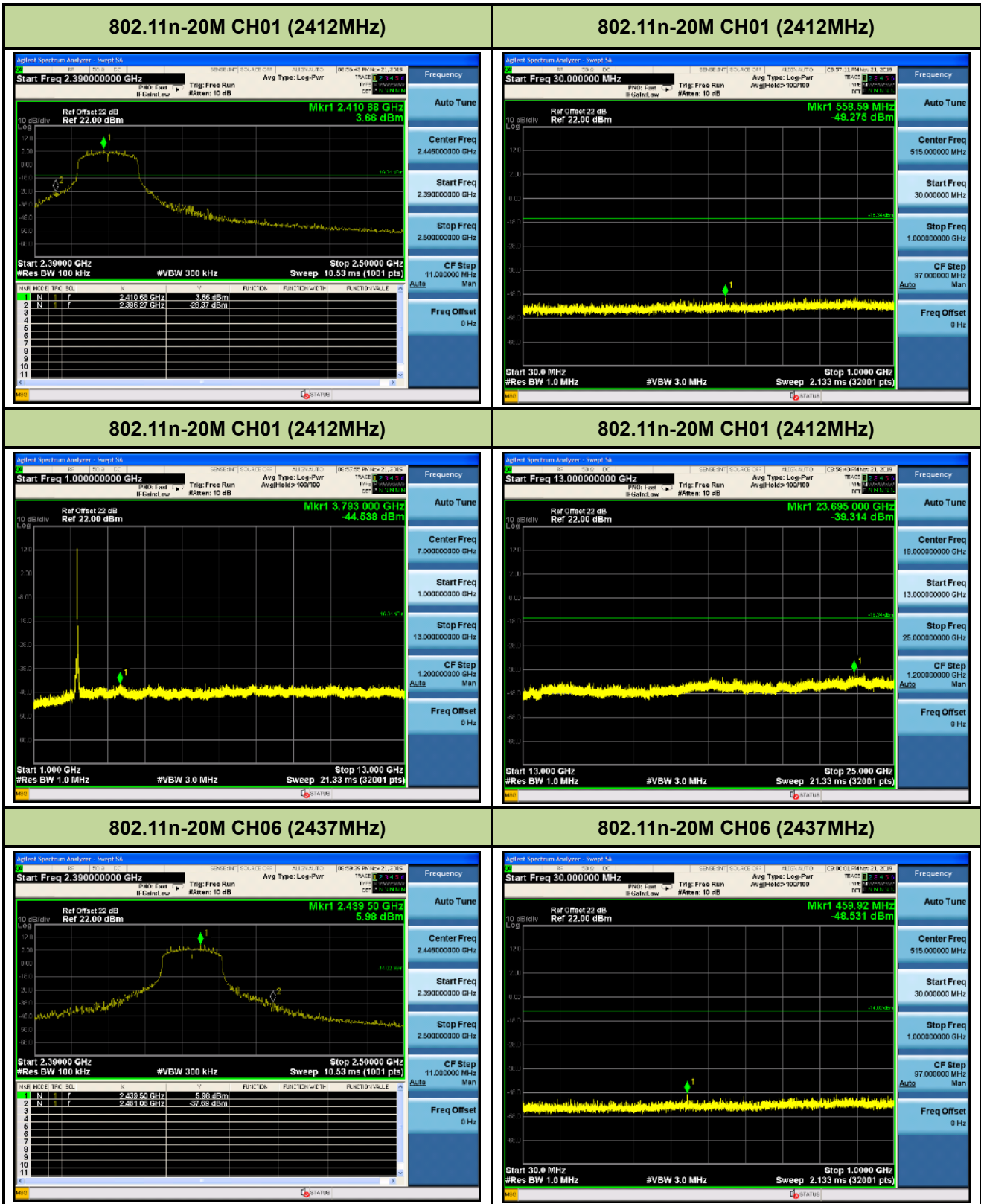

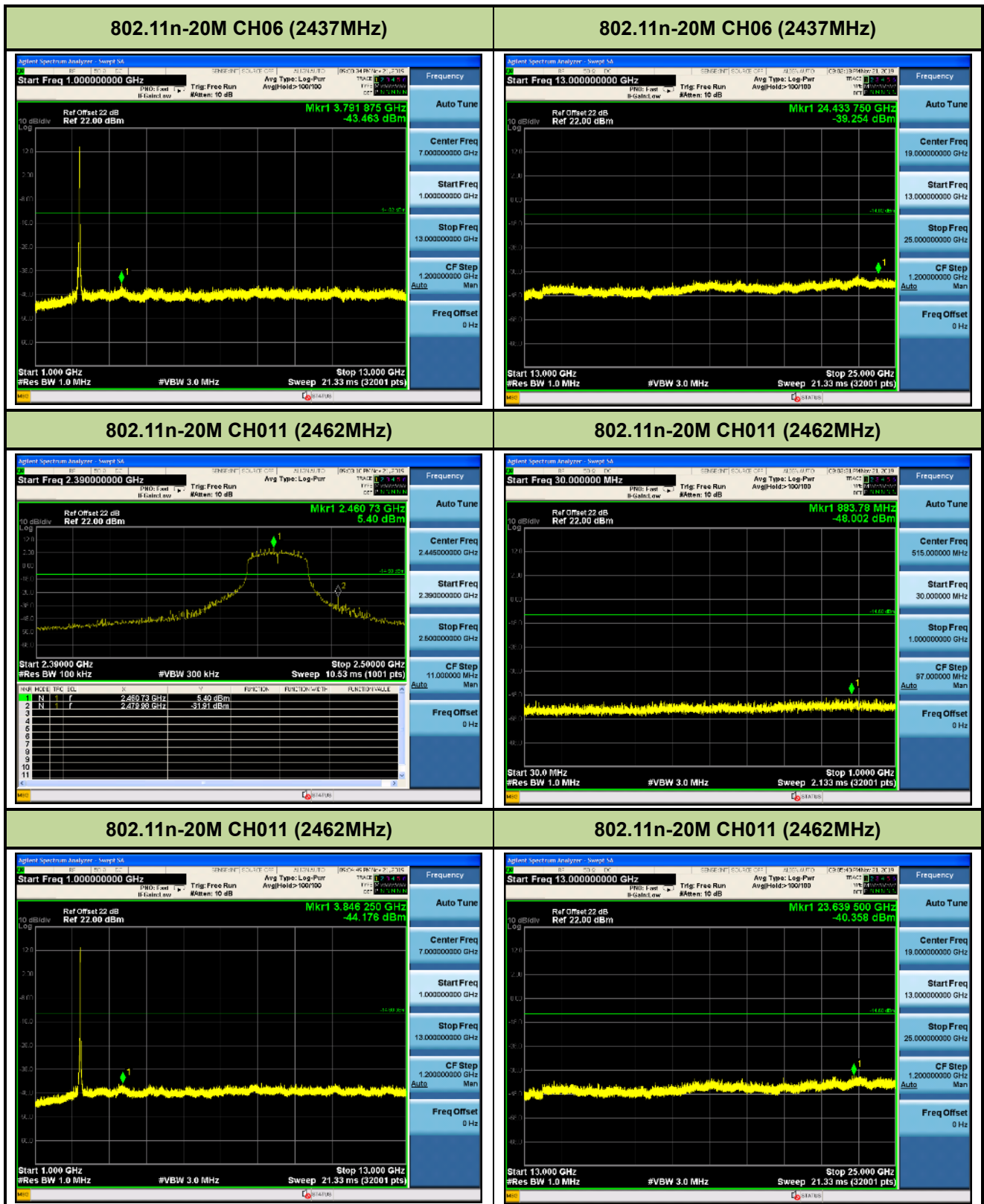

7.6. Radiated Spurious Emission Measurement

7.6.1. Test Limit

All out of band emissions appearing in a restricted band as specified in Section 15.205 of the Title 47 CFR must not exceed the limits shown in Table per Section 15.209.

FCC Part 15 Subpart C Paragraph 15.209		
Frequency [MHz]	Field Strength [V/m]	Measured Distance [Meters]
0.009 - 0.490	2400/F (kHz)	300
0.490 - 1.705	24000/F (kHz)	30
1.705 - 30	30	30
30 - 88	100	3
88 - 216	150	3
216 - 960	200	3
Above 960	500	3

7.6.2. Test Procedure Used

ANSI C63.10 Section 11.12.2.3 (quasi-peak measurements)

ANSI C63.10 Section 11.12.2.4 (peak power measurements)

ANSI C63.10 Section 11.12.2.5 (average power measurements)

7.6.3. Test Setting

Peak Field Strength Measurements

1. Analyzer center frequency was set to the frequency of the radiated spurious emission of interest
2. RBW = as specified in Table 1
3. VBW = 3MHz
4. Detector = peak
5. Sweep time = auto couple

6. Trace mode = max hold

7. Trace was allowed to stabilize

Table 1 - RBW as a function of frequency

Frequency	RBW
9 ~ 150 kHz	200 ~ 300 Hz
0.15 ~ 30 MHz	9 ~ 10 kHz
30 ~ 1000 MHz	100 ~ 120 kHz
> 1000 MHz	1 MHz

Average Field Strength Measurements

1. Analyzer center frequency was set to the frequency of the radiated spurious emission of interest

2. RBW = 1MHz

3. VBW \geq 1/T

4. De As an alternative, the instrument may be set to linear detector mode. Ensure that video filtering is applied in linear voltage domain (rather than in a log or dB domain). Some instruments require linear display mode in order to accomplish this. Others have a setting for Average-VBW Type, which can be set to “Voltage” regardless of the display mode

5. Detector = Peak

6. Sweep time = auto

7. Trace mode = max hold

8. Allow max hold to run for at least 50 times (1/duty cycle) traces

7.6.4. Test Setup

9kHz ~ 30MHz Test Setup:

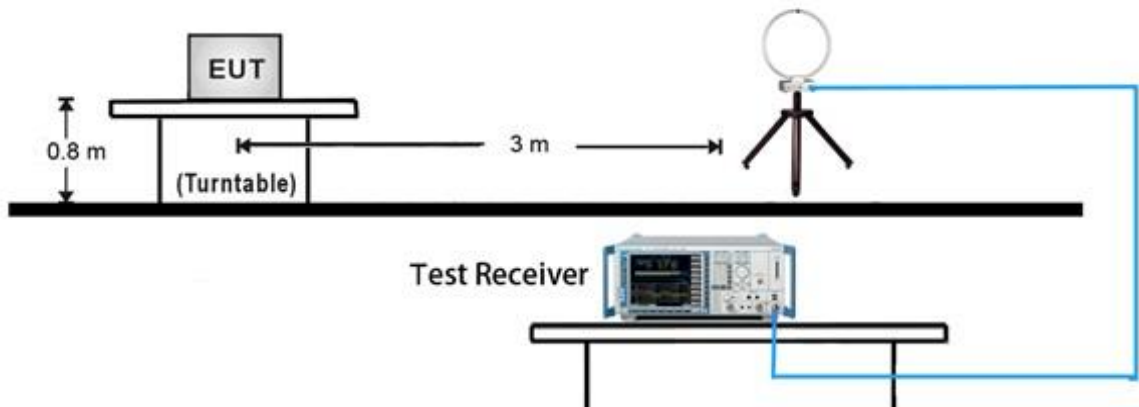

30MHz ~ 1GHz Test Setup:

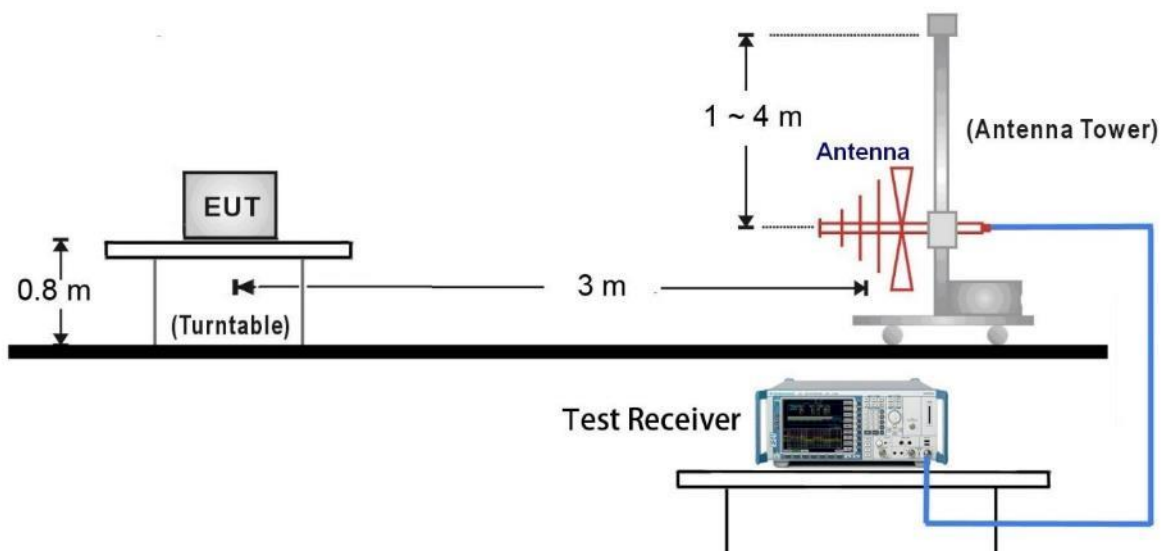

1GHz ~ 18GHz Test Setup:

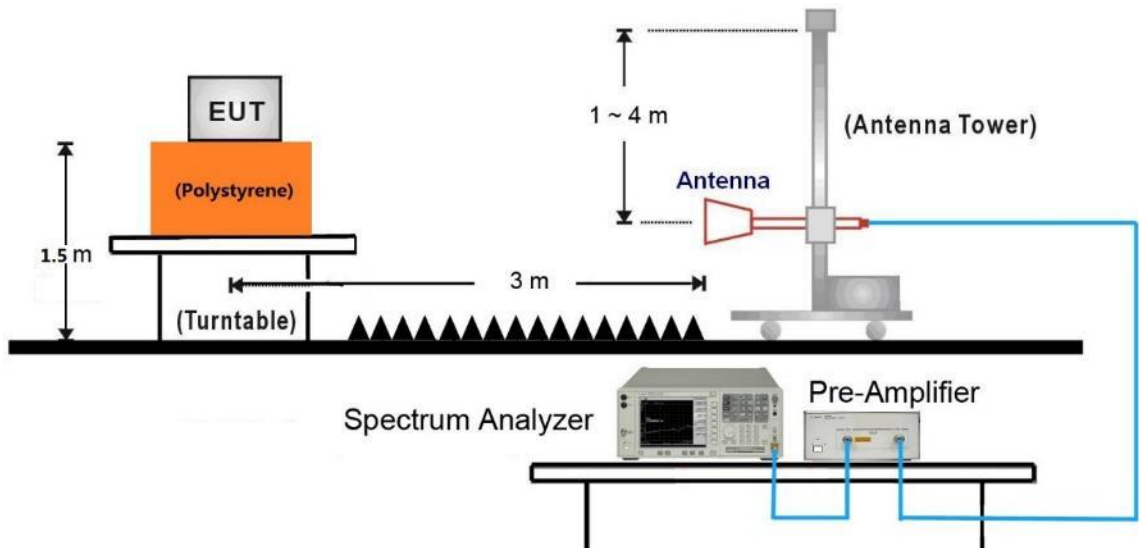

18GHz ~25GHz Test Setup:

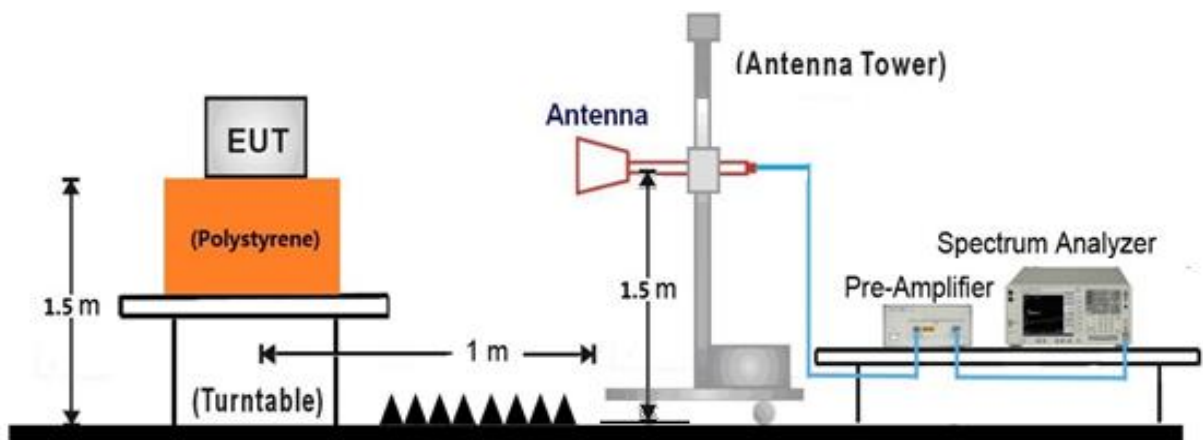

7.6.5. Test Result

EUT	Indoor Camera	Date of Test	2019-11-25
Factor	VULB 9162	Temp. / Humidity	24°C /56%
Polarity	Horizontal	Site / Test Engineer	AC1 / Jay
Test Mode	802.11n20_TX_CH6_ANT 0_1A52_UB52A	Test Voltage	AC 120V/60Hz

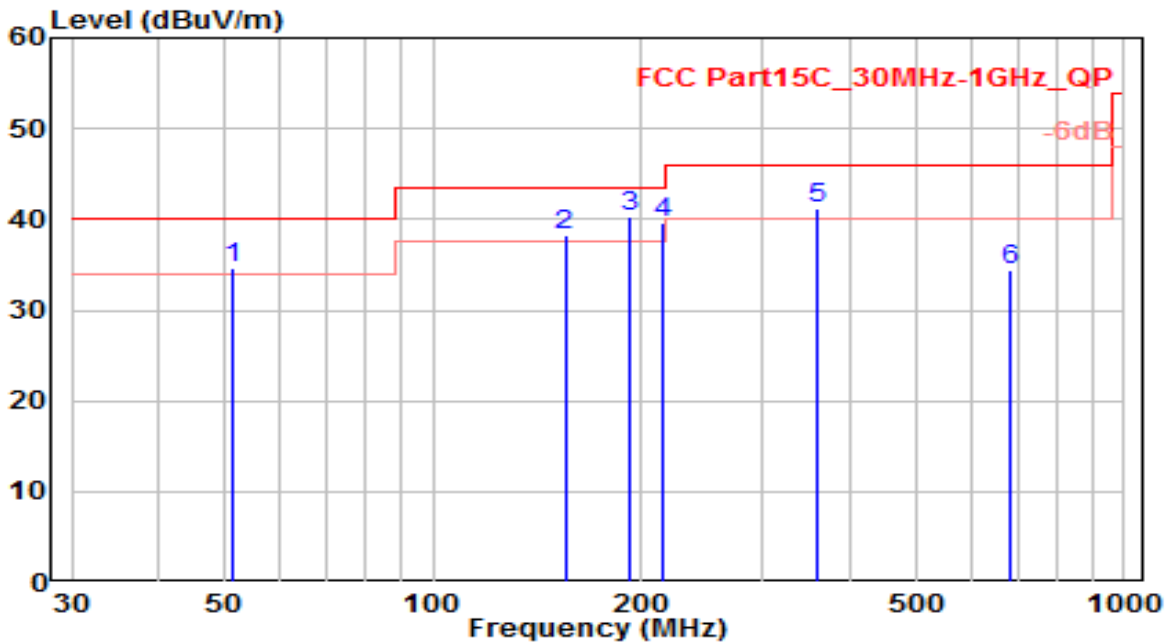

No	Frequency (MHz)	Reading (dBUV)	C.F (dB)	Measurement (dBUV/m)	Margin (dB)	Limit (dBUV/m)	Height (cm)	Angle (deg)	Remark (QP/PK/AV)
1	51.340	13.30	21.44	34.74	-5.26	40.00	100	250	QP
2	155.130	22.30	15.95	38.25	-5.25	43.50	100	380	QP
3	* 191.990	21.60	18.76	40.36	-3.14	43.50	100	225	QP
4	215.270	20.90	18.82	39.72	-3.78	43.50	100	185	QP
5	359.800	17.60	23.57	41.17	-4.83	46.00	100	350	QP
6	683.780	5.60	28.92	34.52	-11.48	46.00	100	50	QP

Note:

1. " *", means this data is the worst emission level.
2. C.F (Correction Factor) = Antenna Factor (dB)+ Cable Loss (dB).
3. Measurement (dBUV/m) = Reading(dBUV) + C.F (Correction Factor).
4. The emission levels of other frequencies are very lower than the limit and not show in test report.

EUT	Indoor Camera	Date of Test	2019-11-25
Factor	VULB 9162	Temp. / Humidity	24°C /56%
Polarity	Vertical	Site / Test Engineer	AC1 / Jay
Test Mode	802.11n20_TX_CH6_ANT 0_1A52_UB52A	Test Voltage	AC 120V/60Hz

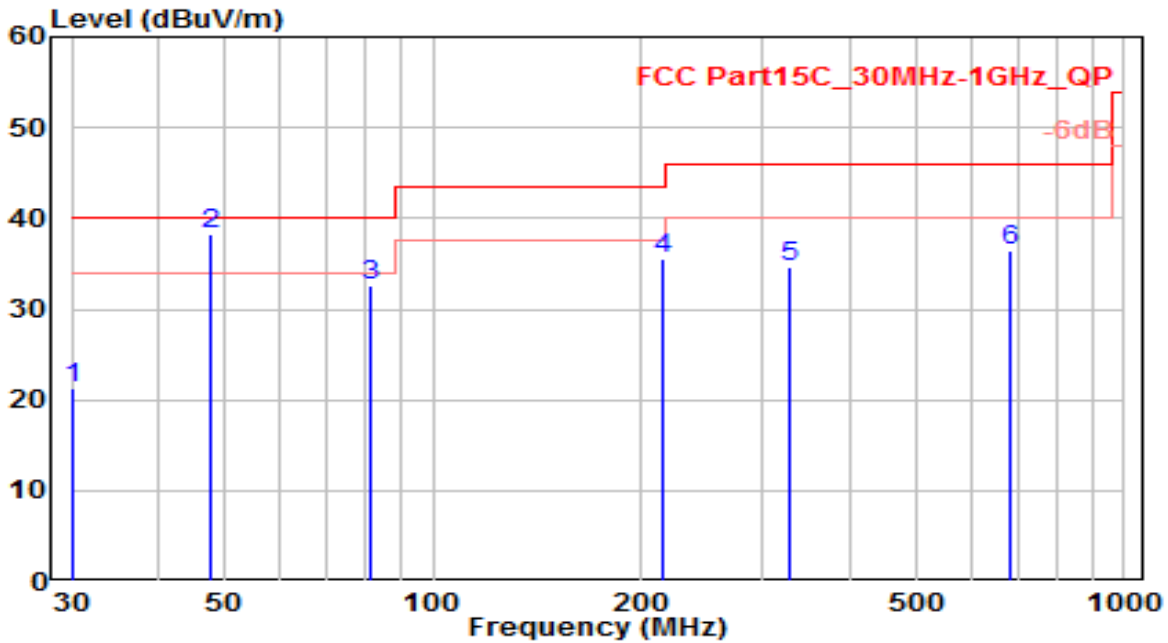

No	Frequency (MHz)	Reading (dBuV)	C.F (dB)	Measurement (dBuV/m)	Margin (dB)	Limit (dBuV/m)	Height (cm)	Angle (deg)	Remark (QP/PK/AV)
1	30.000	3.30	18.00	21.30	-18.70	40.00	100	395	QP
2	* 47.460	16.80	21.53	38.33	-1.67	40.00	100	375	QP
3	81.410	18.20	14.46	32.66	-7.34	40.00	110	50	QP
4	215.270	16.80	18.82	35.62	-7.88	43.50	100	150	QP
5	328.760	12.10	22.57	34.67	-11.33	46.00	100	280	QP
6	683.780	7.60	28.92	36.52	-9.48	46.00	100	250	QP

Note:

- "*" means this data is the worst emission level.
- C.F (Correction Factor) = Antenna Factor (dB)+ Cable Loss (dB).
- Measurement (dBuV/m) = Reading(dBuV) + C.F (Correction Factor).
- The emission levels of other frequencies are very lower than the limit and not show in test report.

EUT	Indoor Camera	Date of Test	2019-11-25
Factor	VULB 9162	Temp. / Humidity	24°C /56%
Polarity	Horizontal	Site / Test Engineer	AC1 / Jay
Test Mode	802.11n20_TX_CH6_ANT 0_PSAF10A-050Q	Test Voltage	AC 120V/60Hz

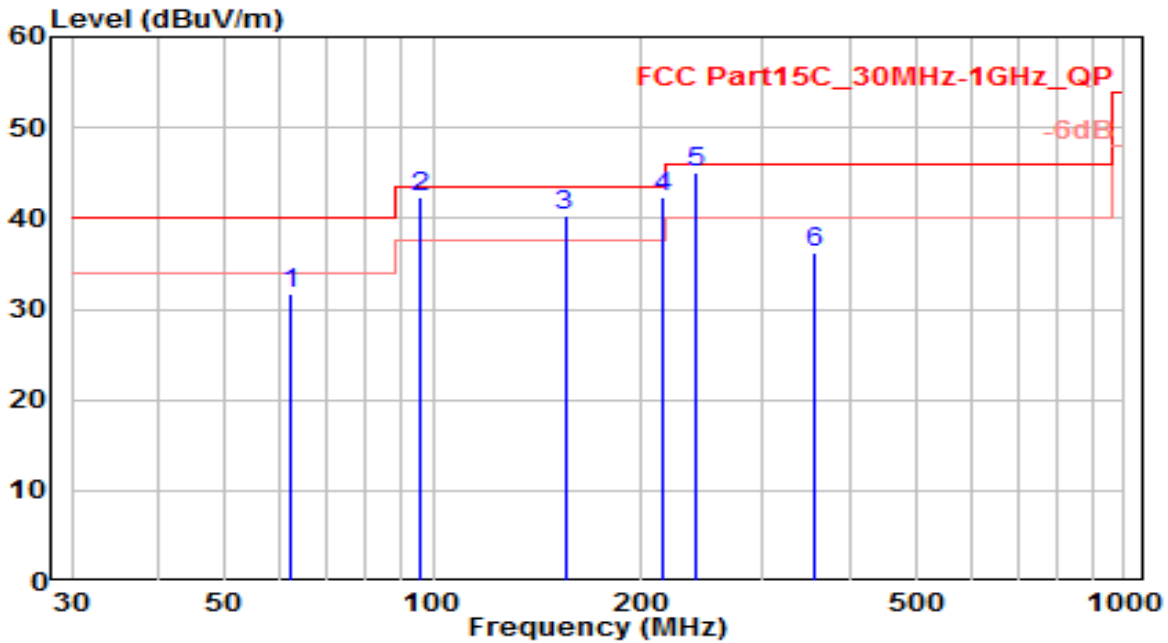

No	Frequency (MHz)	Reading (dBUV)	C.F (dB)	Measurement (dBUV/m)	Margin (dB)	Limit (dBUV/m)	Height (cm)	Angle (deg)	Remark (QP/PK/AV)
1	62.010	12.30	19.38	31.68	-8.32	40.00	100	320	QP
2	95.960	23.70	18.59	42.29	-1.21	43.50	160	350	QP
3	155.130	24.30	15.95	40.25	-3.25	43.50	150	40	QP
4	215.270	23.60	18.82	42.42	-1.08	43.50	150	165	QP
5	* 239.520	24.80	20.19	44.99	-1.01	46.00	100	-15	QP
6	356.890	12.70	23.53	36.23	-9.77	46.00	100	65	QP

Note:

- "*" means this data is the worst emission level.
- C.F (Correction Factor) = Antenna Factor (dB)+ Cable Loss (dB).
- Measurement (dBUV/m) = Reading(dBUV) + C.F (Correction Factor).
- The emission levels of other frequencies are very lower than the limit and not show in test report.

EUT	Indoor Camera	Date of Test	2019-11-25
Factor	VULB 9162	Temp. / Humidity	24°C /56%
Polarity	Vertical	Site / Test Engineer	AC1 / Jay
Test Mode	802.11n20_TX_CH6_ANT 0_PSAF10A-050Q	Test Voltage	AC 120V/60Hz

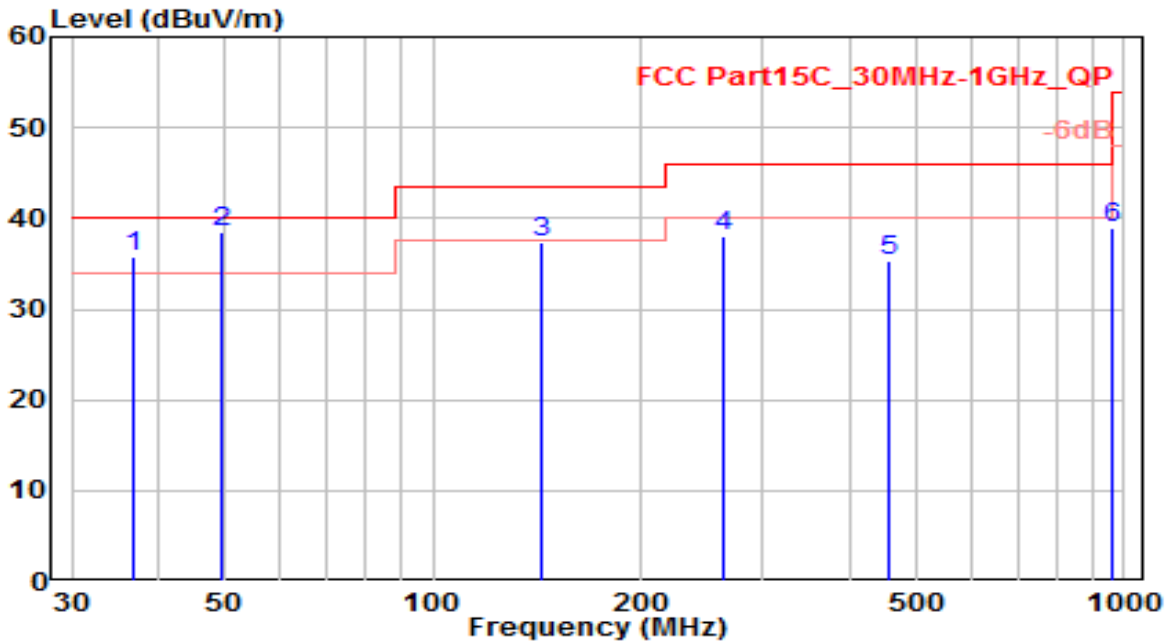

No	Frequency (MHz)	Reading (dBuV)	C.F (dB)	Measurement (dBuV/m)	Margin (dB)	Limit (dBuV/m)	Height (cm)	Angle (deg)	Remark (QP/PK/AV)
1	36.790	16.10	19.61	35.71	-4.29	40.00	100	25	QP
2	* 49.400	16.80	21.62	38.42	-1.58	40.00	100	65	QP
3	143.490	21.90	15.55	37.45	-6.05	43.50	100	50	QP
4	263.770	17.50	20.62	38.12	-7.88	46.00	100	20	QP
5	455.830	10.40	25.00	35.40	-10.60	46.00	100	150	QP
6	960.230	7.10	31.92	39.02	-14.98	54.00	100	110	QP

Note:

- "*" means this data is the worst emission level.
- C.F (Correction Factor) = Antenna Factor (dB)+ Cable Loss (dB).
- Measurement (dBuV/m) = Reading(dBuV) + C.F (Correction Factor).
- The emission levels of other frequencies are very lower than the limit and not show in test report.

EUT	Indoor Camera	Date of Test	2019-11-20
Factor	BBHA 9120D & BBHA 9170	Temp. / Humidity	24°C /56%
Polarity	Horizontal	Site / Test Engineer	AC1 / Jay
Test Mode	802.11b_TX_CH 1_ANT 0	Test Voltage	AC 120V/60Hz

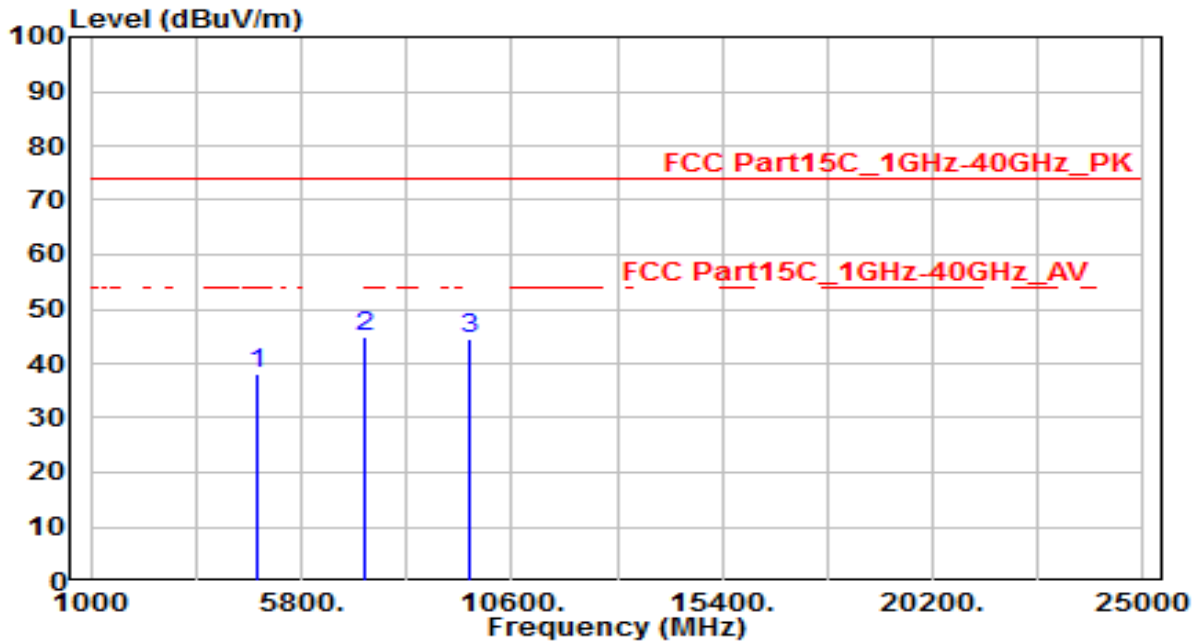

No	Frequency (MHz)	Reading (dBuV)	C.F (dB)	Measurement (dBuV/m)	Margin (dB)	Limit (dBuV/m)	Height (cm)	Angle (deg)	Remark (QP/PK/AV)
1	4824.000	35.10	3.20	38.30	-35.70	74.00	150	400	Peak
2	* 7236.000	33.76	11.13	44.88	-29.12	74.00	150	400	Peak
3	9648.000	30.46	14.11	44.56	-29.44	74.00	150	400	Peak

Note:

- "*", means this data is the worst emission level.
- C.F (Correction Factor) = Antenna Factor (dB)+ Cable Loss (dB) – Pre-amplifier(dB).
- Measurement (dBuV/m) = Reading(dBuV) + C.F (Correction Factor).
- The emission levels of other frequencies are very lower than the limit and not show in test report.

EUT	Indoor Camera	Date of Test	2019-11-20
Factor	BBHA 9120D & BBHA 9170	Temp. / Humidity	24°C /56%
Polarity	Vertical	Site / Test Engineer	AC1 / Jay
Test Mode	802.11b_TX_CH 1_ANT 0	Test Voltage	AC 120V/60Hz

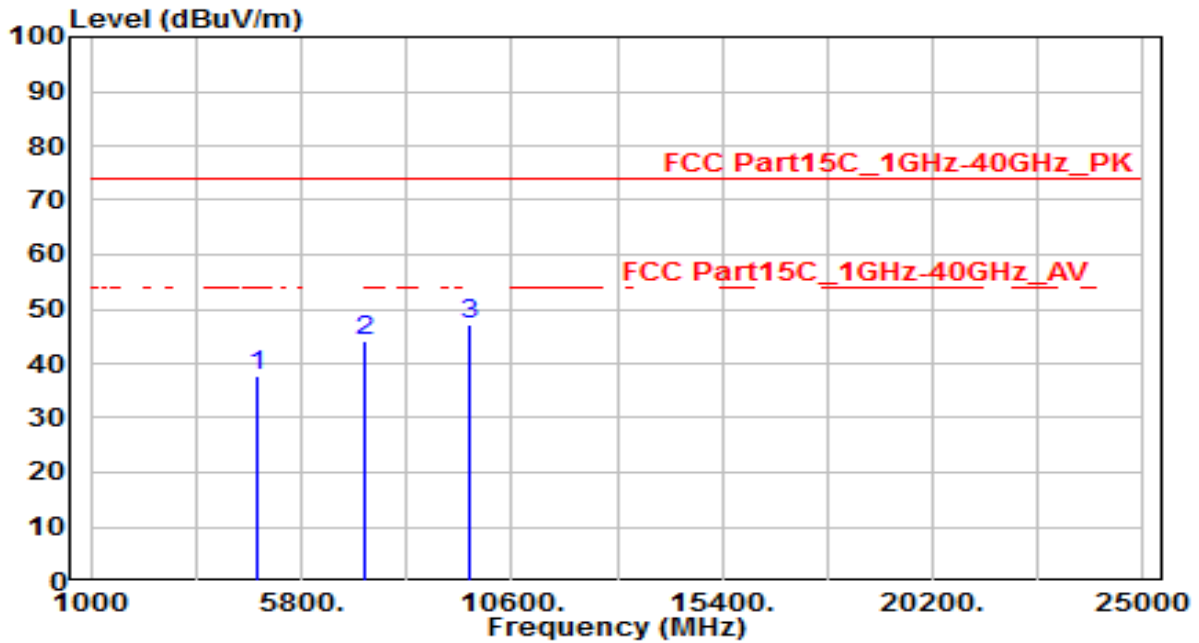

No	Frequency (MHz)	Reading (dBUV)	C.F (dB)	Measurement (dBUV/m)	Margin (dB)	Limit (dBUV/m)	Height (cm)	Angle (deg)	Remark (QP/PK/AV)
1	4824.000	34.65	3.20	37.85	-36.15	74.00	150	400	Peak
2	7236.000	33.10	11.13	44.23	-29.77	74.00	150	400	Peak
3	* 9648.000	32.90	14.11	47.00	-27.00	74.00	150	400	Peak

Note:

- "*", means this data is the worst emission level.
- C.F (Correction Factor) = Antenna Factor (dB)+ Cable Loss (dB) – Pre-amplifier(dB).
- Measurement (dBUV/m) = Reading(dBUV) + C.F (Correction Factor).
- The emission levels of other frequencies are very lower than the limit and not show in test report.

EUT	Indoor Camera	Date of Test	2019-11-20
Factor	BBHA 9120D & BBHA 9170	Temp. / Humidity	24°C /56%
Polarity	Horizontal	Site / Test Engineer	AC1 / Jay
Test Mode	802.11b_TX_CH 6_ANT 0	Test Voltage	AC 120V/60Hz

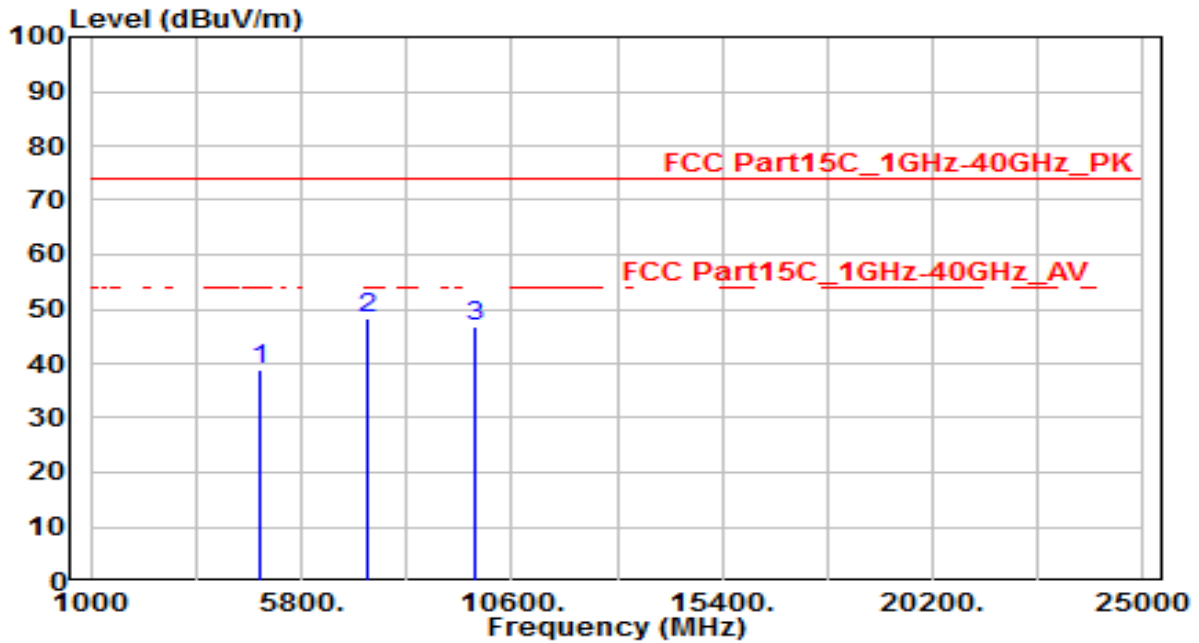

No	Frequency (MHz)	Reading (dBuV)	C.F (dB)	Measurement (dBuV/m)	Margin (dB)	Limit (dBuV/m)	Height (cm)	Angle (deg)	Remark (QP/PK/AV)
1	4874.000	35.44	3.30	38.74	-35.26	74.00	150	400	Peak
2	* 7311.000	37.06	11.29	48.35	-25.65	74.00	150	400	Peak
3	9748.000	32.29	14.43	46.72	-27.28	74.00	150	400	Peak

Note:

- "*", means this data is the worst emission level.
- C.F (Correction Factor) = Antenna Factor (dB)+ Cable Loss (dB) – Preamplifier(dB).
- Measurement (dBuV/m) = Reading(dBuV) + C.F (Correction Factor).
- The emission levels of other frequencies are very lower than the limit and not show in test report.

EUT	Indoor Camera	Date of Test	2019-11-20
Factor	BBHA 9120D & BBHA 9170	Temp. / Humidity	24°C /56%
Polarity	Vertical	Site / Test Engineer	AC1 / Jay
Test Mode	802.11b_TX_CH 6_ANT 0	Test Voltage	AC 120V/60Hz

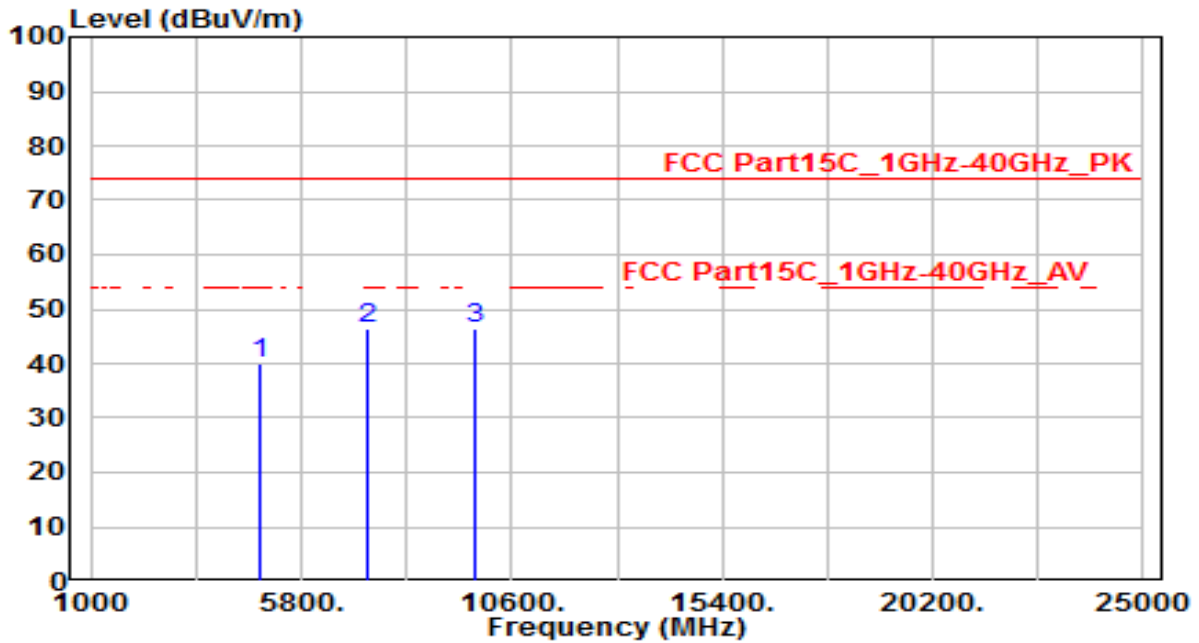

No	Frequency (MHz)	Reading (dBuV)	C.F (dB)	Measurement (dBuV/m)	Margin (dB)	Limit (dBuV/m)	Height (cm)	Angle (deg)	Remark (QP/PK/AV)
1	4874.000	36.62	3.30	39.92	-34.08	74.00	150	400	Peak
2	7311.000	35.26	11.29	46.55	-27.45	74.00	150	400	Peak
3	* 9748.000	32.15	14.43	46.58	-27.42	74.00	150	400	Peak

Note:

- "*", means this data is the worst emission level.
- C.F (Correction Factor) = Antenna Factor (dB)+ Cable Loss (dB) – Preamplifier(dB).
- Measurement (dBuV/m) = Reading(dBuV) + C.F (Correction Factor).
- The emission levels of other frequencies are very lower than the limit and not show in test report.

EUT	Indoor Camera	Date of Test	2019-11-20
Factor	BBHA 9120D & BBHA 9170	Temp. / Humidity	24°C /56%
Polarity	Horizontal	Site / Test Engineer	AC1 / Jay
Test Mode	802.11b_TX_CH 11_ANT 0	Test Voltage	AC 120V/60Hz

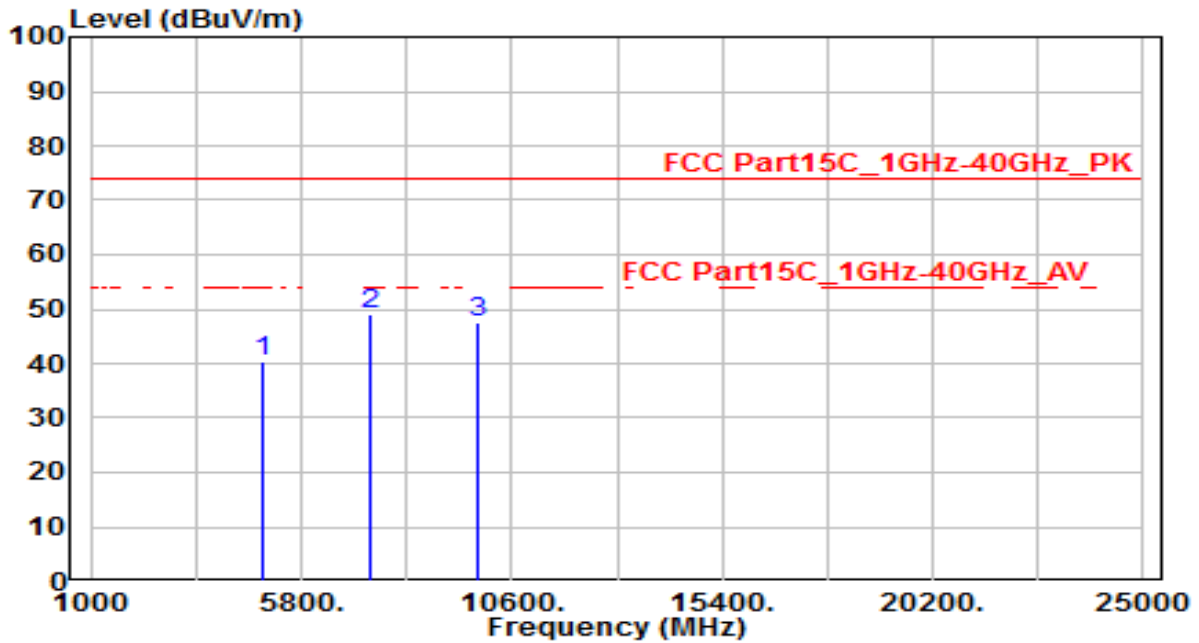

No	Frequency (MHz)	Reading (dBuV)	C.F (dB)	Measurement (dBuV/m)	Margin (dB)	Limit (dBuV/m)	Height (cm)	Angle (deg)	Remark (QP/PK/AV)
1	4924.000	37.16	3.40	40.56	-33.44	74.00	150	400	Peak
2	* 7386.000	37.75	11.46	49.21	-24.79	74.00	150	400	Peak
3	9848.000	32.69	14.76	47.45	-26.55	74.00	150	400	Peak

Note:

- "*", means this data is the worst emission level.
- C.F (Correction Factor) = Antenna Factor (dB)+ Cable Loss (dB) – Preamplifier(dB).
- Measurement (dBuV/m) = Reading(dBuV) + C.F (Correction Factor).
- The emission levels of other frequencies are very lower than the limit and not show in test report.

EUT	Indoor Camera	Date of Test	2019-11-20
Factor	BBHA 9120D & BBHA 9170	Temp. / Humidity	24°C /56%
Polarity	Vertical	Site / Test Engineer	AC1 / Jay
Test Mode	802.11b_TX_CH 11_ANT 0	Test Voltage	AC 120V/60Hz

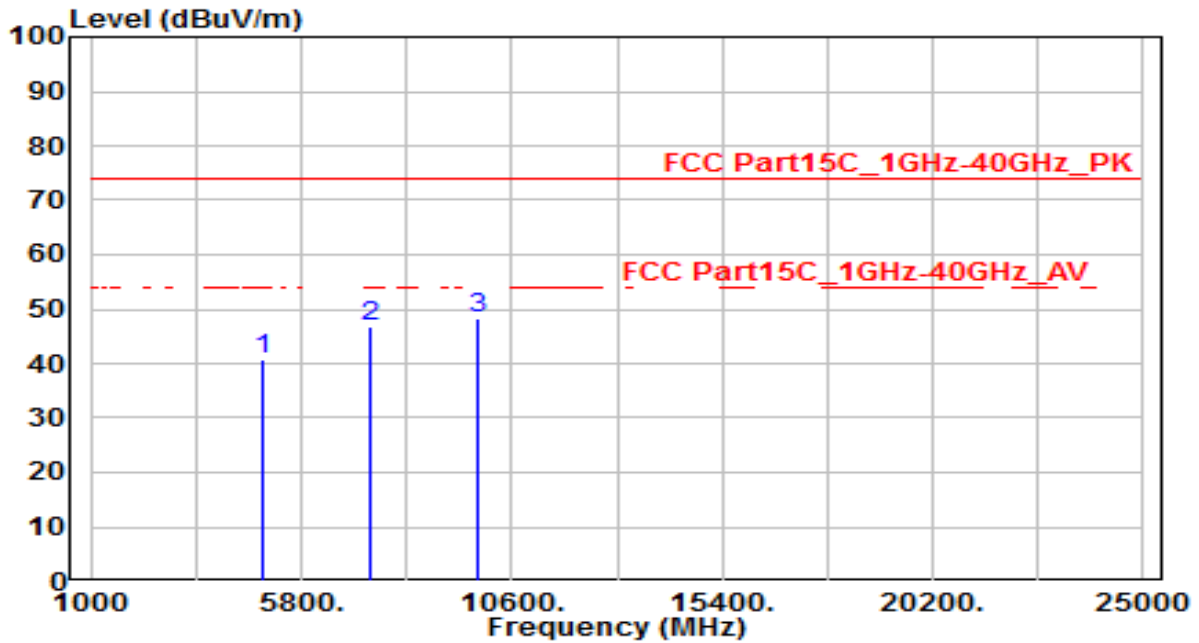

No	Frequency (MHz)	Reading (dBuV)	C.F (dB)	Measurement (dBuV/m)	Margin (dB)	Limit (dBuV/m)	Height (cm)	Angle (deg)	Remark (QP/PK/AV)
1	4924.000	37.23	3.40	40.63	-33.37	74.00	150	400	Peak
2	7386.000	35.15	11.46	46.61	-27.39	74.00	150	400	Peak
3	* 9848.000	33.38	14.76	48.14	-25.86	74.00	150	400	Peak

Note:

- "*", means this data is the worst emission level.
- C.F (Correction Factor) = Antenna Factor (dB)+ Cable Loss (dB) – Pre-amplifier(dB).
- Measurement (dBuV/m) = Reading(dBuV) + C.F (Correction Factor).
- The emission levels of other frequencies are very lower than the limit and not show in test report.

EUT	Indoor Camera	Date of Test	2019-11-20
Factor	BBHA 9120D & BBHA 9170	Temp. / Humidity	24°C /56%
Polarity	Horizontal	Site / Test Engineer	AC1 / Jay
Test Mode	802.11g_TX_CH 1_ANT 0	Test Voltage	AC 120V/60Hz

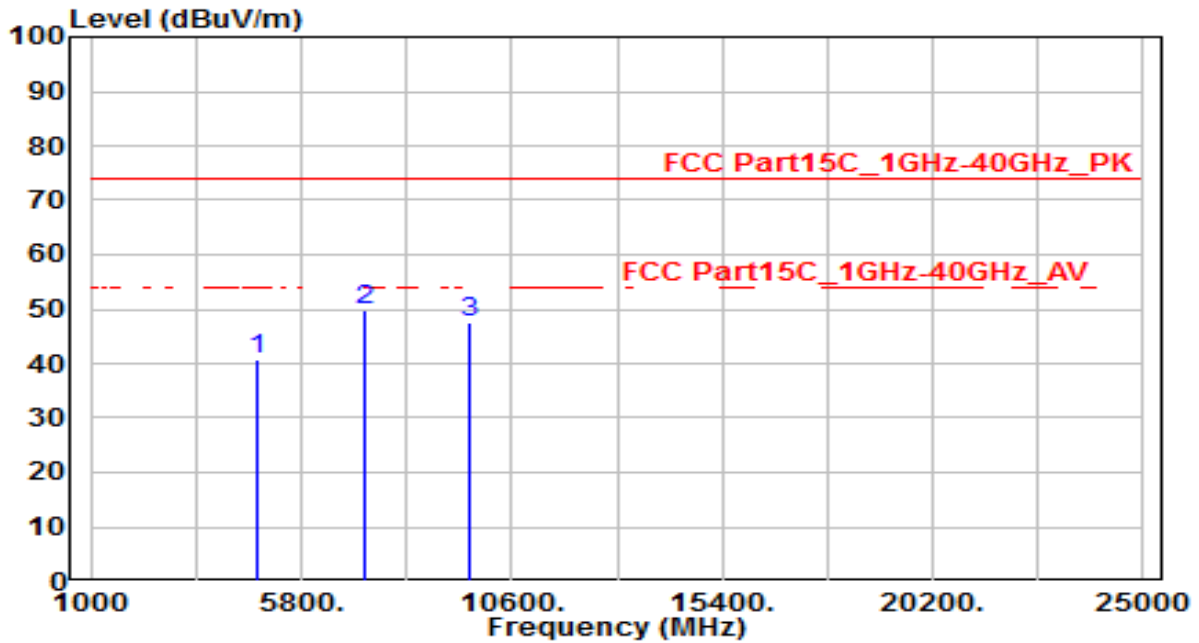

No	Frequency (MHz)	Reading (dBuV)	C.F (dB)	Measurement (dBuV/m)	Margin (dB)	Limit (dBuV/m)	Height (cm)	Angle (deg)	Remark (QP/PK/AV)
1	4824.000	37.45	3.20	40.65	-33.35	74.00	150	400	Peak
2	* 7236.000	38.68	11.13	49.81	-24.19	74.00	150	400	Peak
3	9648.000	33.46	14.11	47.57	-26.43	74.00	150	400	Peak

Note:

- "*", means this data is the worst emission level.
- C.F (Correction Factor) = Antenna Factor (dB)+ Cable Loss (dB) – Preamplifier(dB).
- Measurement (dBuV/m) = Reading(dBuV) + C.F (Correction Factor).
- The emission levels of other frequencies are very lower than the limit and not show in test report.

EUT	Indoor Camera	Date of Test	2019-11-20
Factor	BBHA 9120D & BBHA 9170	Temp. / Humidity	24°C /56%
Polarity	Vertical	Site / Test Engineer	AC1 / Jay
Test Mode	802.11g_TX_CH 1_ANT 0	Test Voltage	AC 120V/60Hz

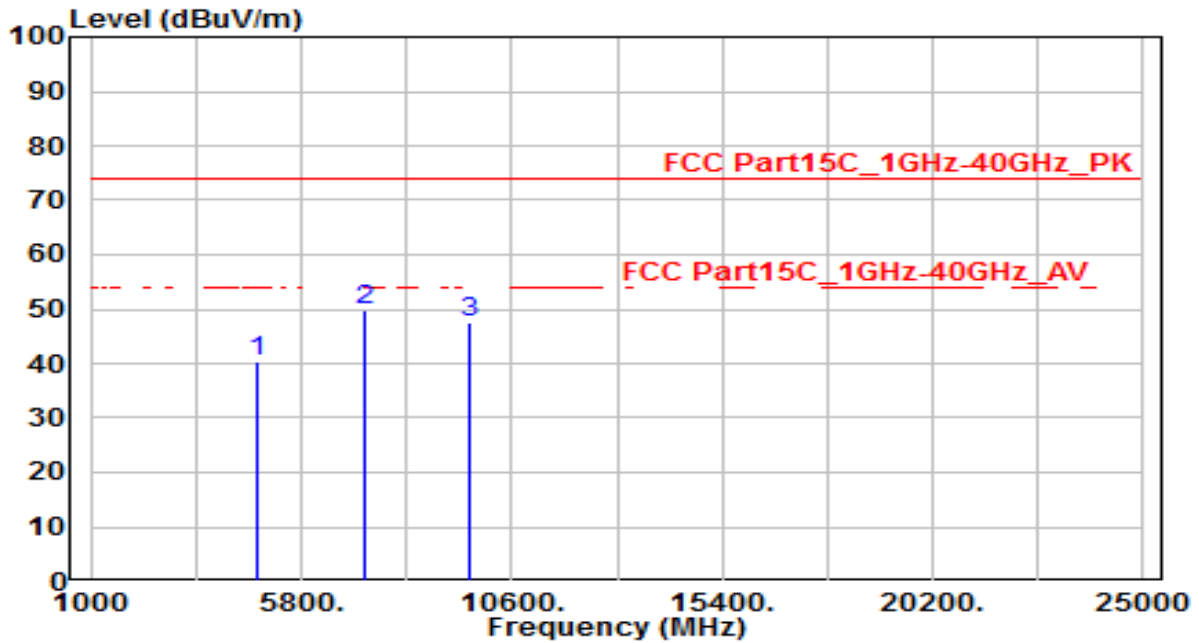

No	Frequency (MHz)	Reading (dBuV)	C.F (dB)	Measurement (dBuV/m)	Margin (dB)	Limit (dBuV/m)	Height (cm)	Angle (deg)	Remark (QP/PK/AV)
1	4824.000	37.11	3.20	40.31	-33.69	74.00	150	400	Peak
2	* 7236.000	38.62	11.13	49.75	-24.25	74.00	150	400	Peak
3	9648.000	33.26	14.11	47.37	-26.63	74.00	150	400	Peak

Note:

- "*", means this data is the worst emission level.
- C.F (Correction Factor) = Antenna Factor (dB)+ Cable Loss (dB) – Pre-amplifier(dB).
- Measurement (dBuV/m) = Reading(dBuV) + C.F (Correction Factor).
- The emission levels of other frequencies are very lower than the limit and not show in test report.

EUT	Indoor Camera	Date of Test	2019-11-20
Factor	BBHA 9120D & BBHA 9170	Temp. / Humidity	24°C /56%
Polarity	Horizontal	Site / Test Engineer	AC1 / Jay
Test Mode	802.11g_TX_CH 6_ANT 0	Test Voltage	AC 120V/60Hz

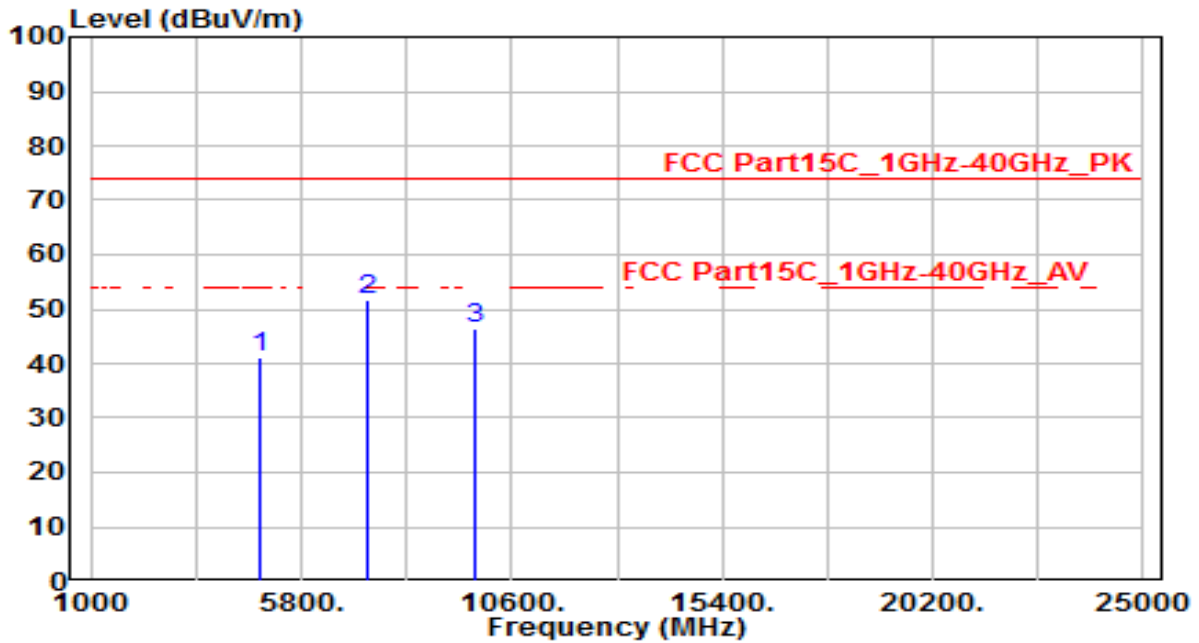

No	Frequency (MHz)	Reading (dBuV)	C.F (dB)	Measurement (dBuV/m)	Margin (dB)	Limit (dBuV/m)	Height (cm)	Angle (deg)	Remark (QP/PK/AV)
1	4874.000	37.69	3.30	40.99	-33.01	74.00	150	400	Peak
2	* 7311.000	40.59	11.29	51.88	-22.12	74.00	150	400	Peak
3	9748.000	32.15	14.43	46.58	-27.42	74.00	150	400	Peak

Note:

- "*", means this data is the worst emission level.
- C.F (Correction Factor) = Antenna Factor (dB)+ Cable Loss (dB) – Preamplifier(dB).
- Measurement (dBuV/m) = Reading(dBuV) + C.F (Correction Factor).
- The emission levels of other frequencies are very lower than the limit and not show in test report.

EUT	Indoor Camera	Date of Test	2019-11-20
Factor	BBHA 9120D & BBHA 9170	Temp. / Humidity	24°C /56%
Polarity	Vertical	Site / Test Engineer	AC1 / Jay
Test Mode	802.11g_TX_CH 6_ANT 0	Test Voltage	AC 120V/60Hz

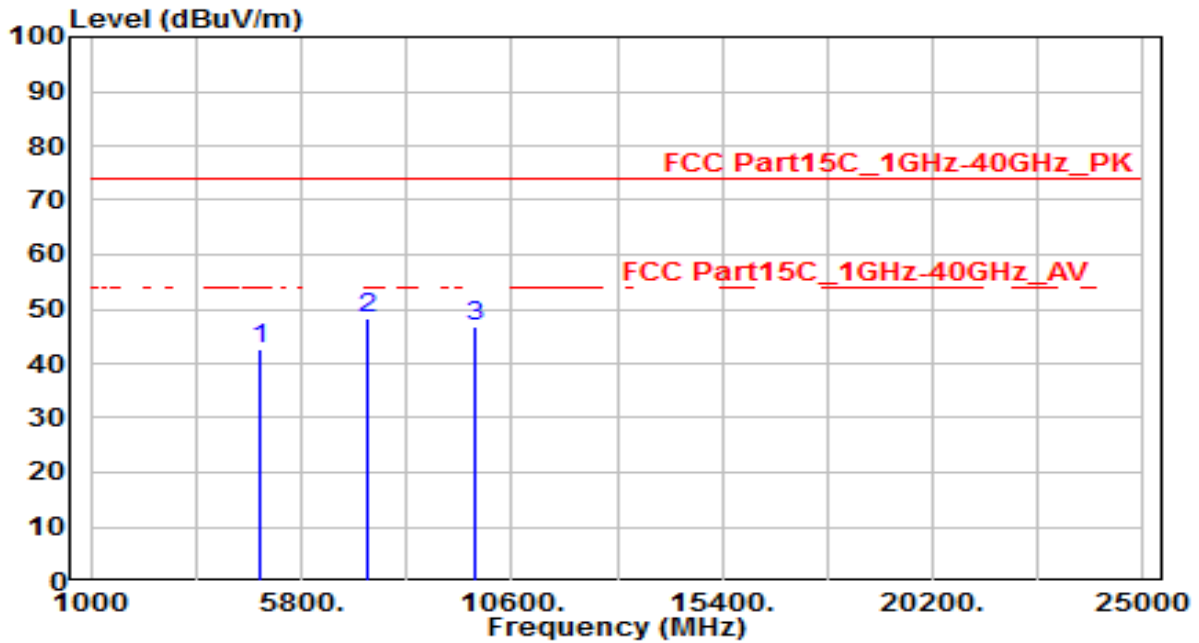

No	Frequency (MHz)	Reading (dBuV)	C.F (dB)	Measurement (dBuV/m)	Margin (dB)	Limit (dBuV/m)	Height (cm)	Angle (deg)	Remark (QP/PK/AV)
1	4874.000	39.37	3.30	42.67	-31.33	74.00	150	400	Peak
2	* 7311.000	37.12	11.29	48.41	-25.59	74.00	150	400	Peak
3	9748.000	32.33	14.43	46.76	-27.24	74.00	150	400	Peak

Note:

- "*", means this data is the worst emission level.
- C.F (Correction Factor) = Antenna Factor (dB)+ Cable Loss (dB) – Preamplifier(dB).
- Measurement (dBuV/m) = Reading(dBuV) + C.F (Correction Factor).
- The emission levels of other frequencies are very lower than the limit and not show in test report.

EUT	Indoor Camera	Date of Test	2019-11-20
Factor	BBHA 9120D & BBHA 9170	Temp. / Humidity	24°C /56%
Polarity	Horizontal	Site / Test Engineer	AC1 / Jay
Test Mode	802.11g_TX_CH 11_ANT 0	Test Voltage	AC 120V/60Hz

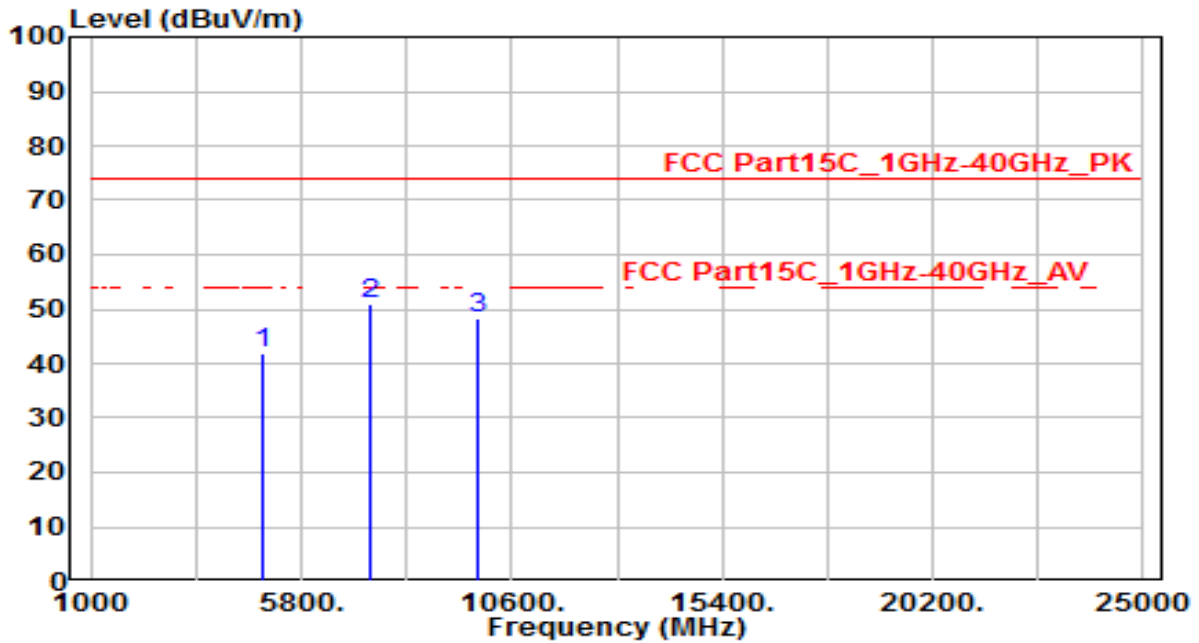

No	Frequency (MHz)	Reading (dBUV)	C.F (dB)	Measurement (dBUV/m)	Margin (dB)	Limit (dBUV/m)	Height (cm)	Angle (deg)	Remark (QP/PK/AV)
1	4924.000	38.50	3.40	41.90	-32.10	74.00	150	400	Peak
2	* 7386.000	39.65	11.46	51.11	-22.89	74.00	150	400	Peak
3	9848.000	33.55	14.76	48.31	-25.69	74.00	150	400	Peak

Note:

- "*", means this data is the worst emission level.
- C.F (Correction Factor) = Antenna Factor (dB)+ Cable Loss (dB) – Preamplifier(dB).
- Measurement (dBUV/m) = Reading(dBUV) + C.F (Correction Factor).
- The emission levels of other frequencies are very lower than the limit and not show in test report.

EUT	Indoor Camera	Date of Test	2019-11-20
Factor	BBHA 9120D & BBHA 9170	Temp. / Humidity	24°C /56%
Polarity	Vertical	Site / Test Engineer	AC1 / Jay
Test Mode	802.11g_TX_CH 11_ANT 0	Test Voltage	AC 120V/60Hz

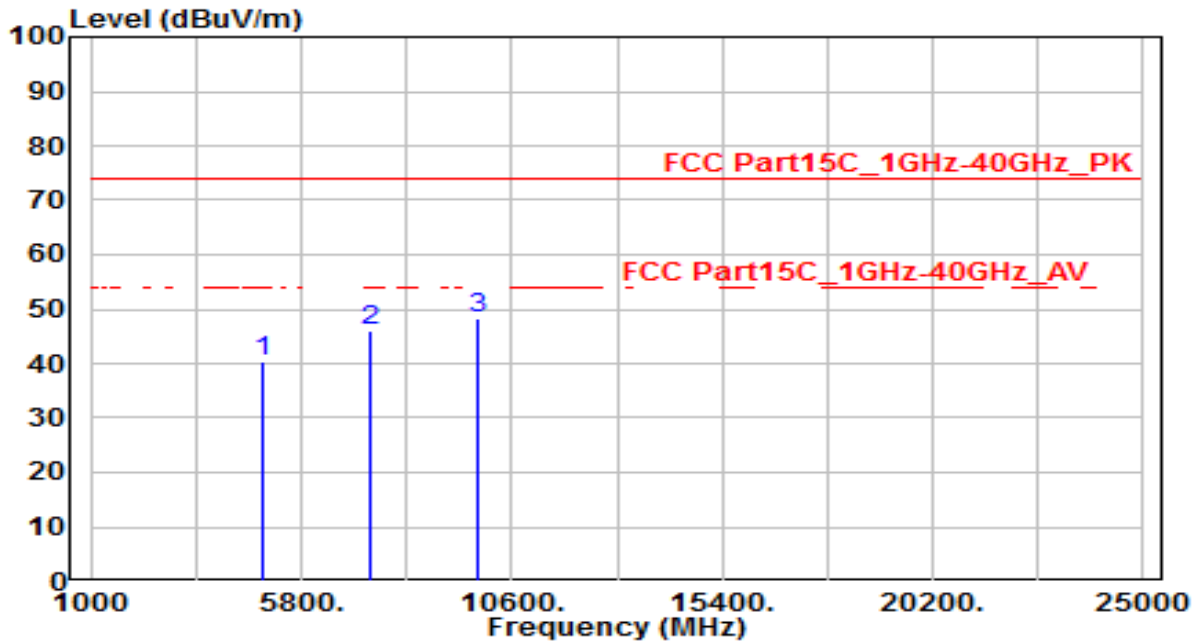

No	Frequency (MHz)	Reading (dBUV)	C.F (dB)	Measurement (dBUV/m)	Margin (dB)	Limit (dBUV/m)	Height (cm)	Angle (deg)	Remark (QP/PK/AV)
1	4924.000	36.86	3.40	40.26	-33.74	74.00	150	400	Peak
2	7386.000	34.61	11.46	46.07	-27.93	74.00	150	400	Peak
3	* 9848.000	33.42	14.76	48.18	-25.82	74.00	150	400	Peak

Note:

- "*", means this data is the worst emission level.
- C.F (Correction Factor) = Antenna Factor (dB)+ Cable Loss (dB) – Preamplifier(dB).
- Measurement (dBUV/m) = Reading(dBUV) + C.F (Correction Factor).
- The emission levels of other frequencies are very lower than the limit and not show in test report.

EUT	Indoor Camera	Date of Test	2019-11-20
Factor	BBHA 9120D & BBHA 9170	Temp. / Humidity	24°C /56%
Polarity	Horizontal	Site / Test Engineer	AC1 / Jay
Test Mode	802.11n20_TX_CH 1_ANT 0	Test Voltage	AC 120V/60Hz

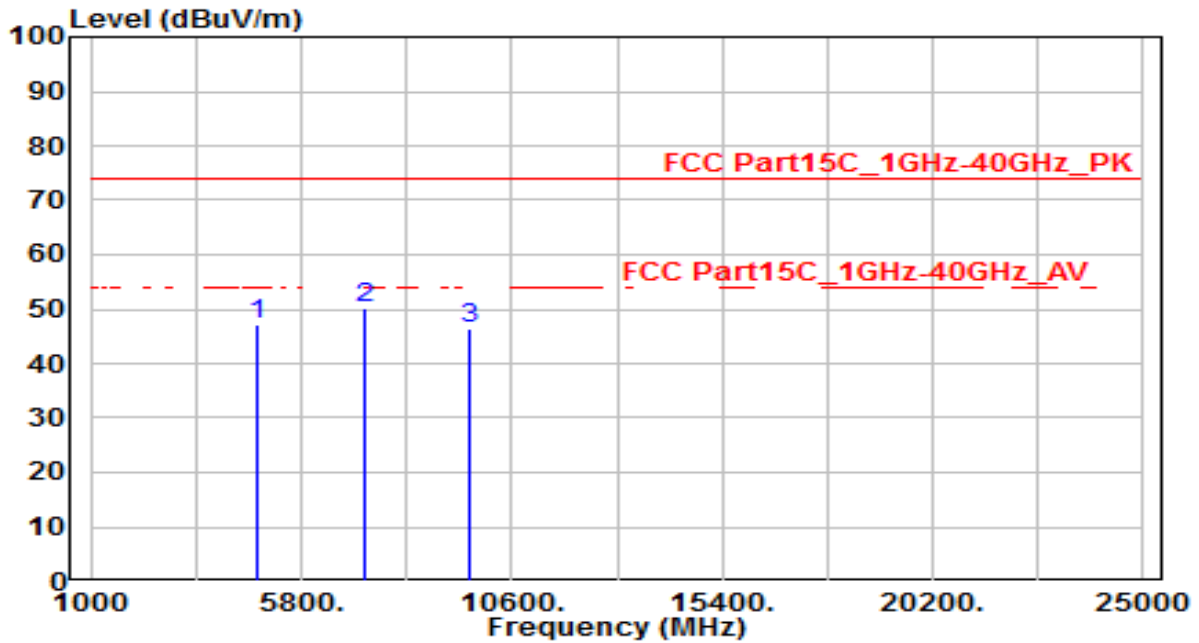

No	Frequency (MHz)	Reading (dBuV)	C.F (dB)	Measurement (dBuV/m)	Margin (dB)	Limit (dBuV/m)	Height (cm)	Angle (deg)	Remark (QP/PK/AV)
1	4824.000	43.82	3.20	47.02	-26.98	74.00	150	400	Peak
2	* 7236.000	39.23	11.13	50.36	-23.64	74.00	150	400	Peak
3	9648.000	32.15	14.11	46.26	-27.74	74.00	150	400	Peak

Note:

- "*", means this data is the worst emission level.
- C.F (Correction Factor) = Antenna Factor (dB)+ Cable Loss (dB) – Preamplifier(dB).
- Measurement (dBuV/m) = Reading(dBuV) + C.F (Correction Factor).
- The emission levels of other frequencies are very lower than the limit and not show in test report.

EUT	Indoor Camera	Date of Test	2019-11-20
Factor	BBHA 9120D & BBHA 9170	Temp. / Humidity	24°C /56%
Polarity	Vertical	Site / Test Engineer	AC1 / Jay
Test Mode	802.11n20_TX_CH 1_ANT 0	Test Voltage	AC 120V/60Hz

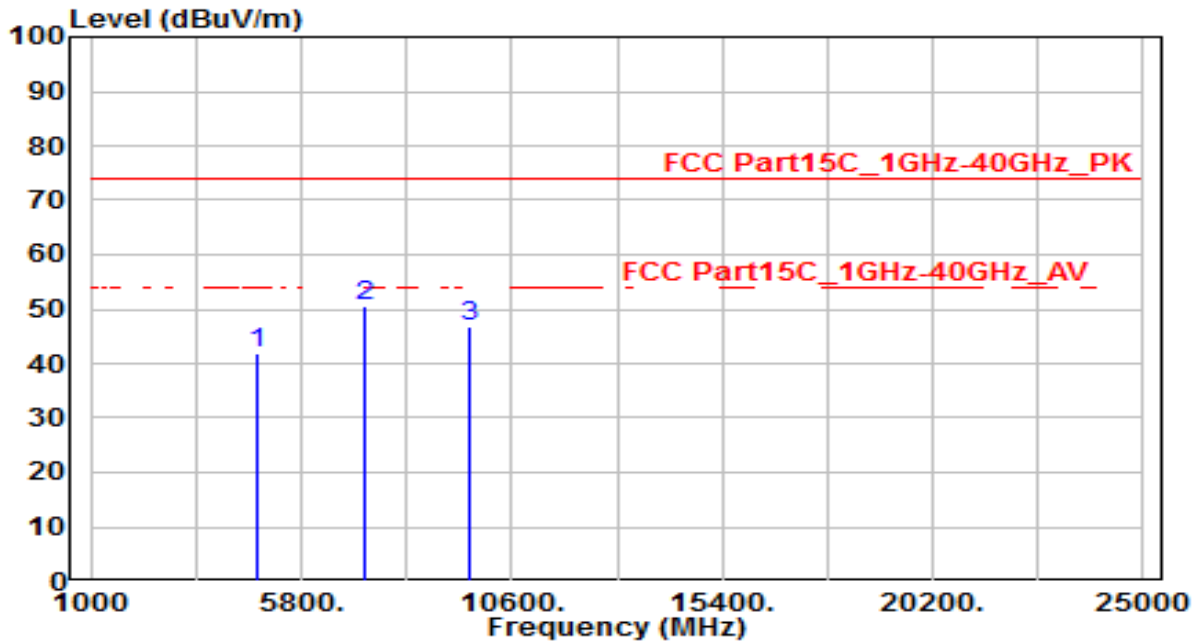

No	Frequency (MHz)	Reading (dBuV)	C.F (dB)	Measurement (dBuV/m)	Margin (dB)	Limit (dBuV/m)	Height (cm)	Angle (deg)	Remark (QP/PK/AV)
1	4824.000	38.85	3.20	42.05	-31.95	74.00	150	400	Peak
2	* 7236.000	39.35	11.13	50.48	-23.52	74.00	150	400	Peak
3	9648.000	32.51	14.11	46.62	-27.38	74.00	150	400	Peak

Note:

- "*", means this data is the worst emission level.
- C.F (Correction Factor) = Antenna Factor (dB)+ Cable Loss (dB) – Preamplifier(dB).
- Measurement (dBuV/m) = Reading(dBuV) + C.F (Correction Factor).
- The emission levels of other frequencies are very lower than the limit and not show in test report.

EUT	Indoor Camera	Date of Test	2019-11-20
Factor	BBHA 9120D & BBHA 9170	Temp. / Humidity	24°C /56%
Polarity	Horizontal	Site / Test Engineer	AC1 / Jay
Test Mode	802.11n20_TX_CH 6_ANT 0	Test Voltage	AC 120V/60Hz

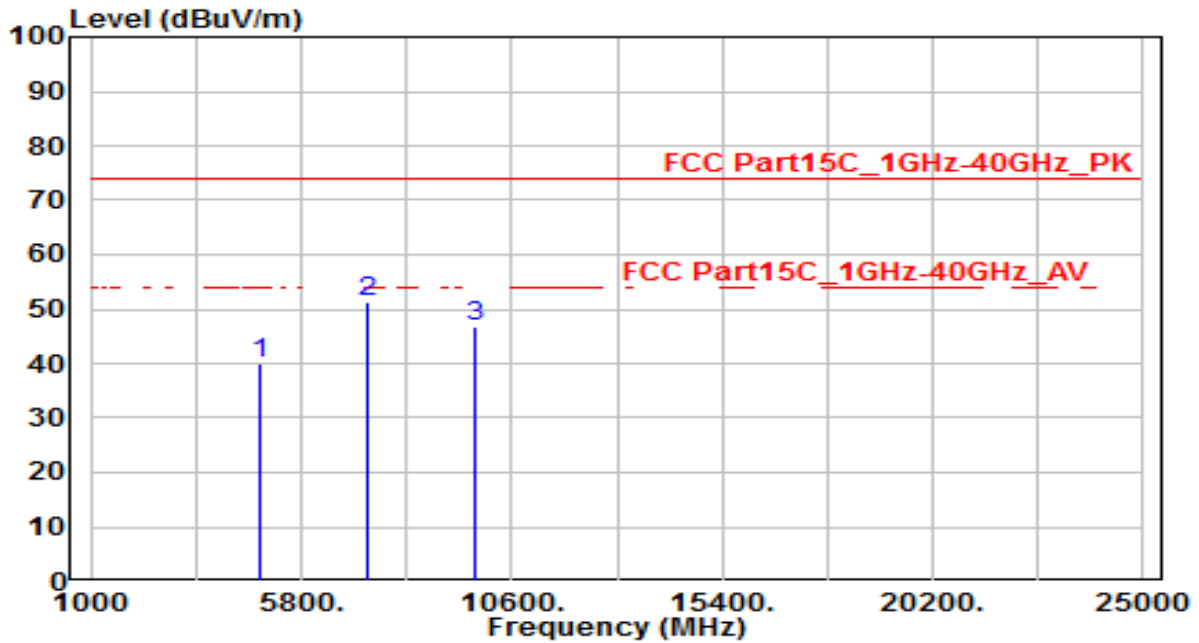

No	Frequency (MHz)	Reading (dBuV)	C.F (dB)	Measurement (dBuV/m)	Margin (dB)	Limit (dBuV/m)	Height (cm)	Angle (deg)	Remark (QP/PK/AV)
1	4874.000	36.57	3.30	39.87	-34.13	74.00	150	400	Peak
2	* 7311.000	39.96	11.29	51.25	-22.75	74.00	150	400	Peak
3	9748.000	32.20	14.43	46.63	-27.37	74.00	150	400	Peak

Note:

- "*", means this data is the worst emission level.
- C.F (Correction Factor) = Antenna Factor (dB)+ Cable Loss (dB) – Preamplifier(dB).
- Measurement (dBuV/m) = Reading(dBuV) + C.F (Correction Factor).
- The emission levels of other frequencies are very lower than the limit and not show in test report.

EUT	Indoor Camera	Date of Test	2019-11-20
Factor	BBHA 9120D & BBHA 9170	Temp. / Humidity	24°C /56%
Polarity	Vertical	Site / Test Engineer	AC1 / Jay
Test Mode	802.11n20_TX_CH 6_ANT 0	Test Voltage	AC 120V/60Hz

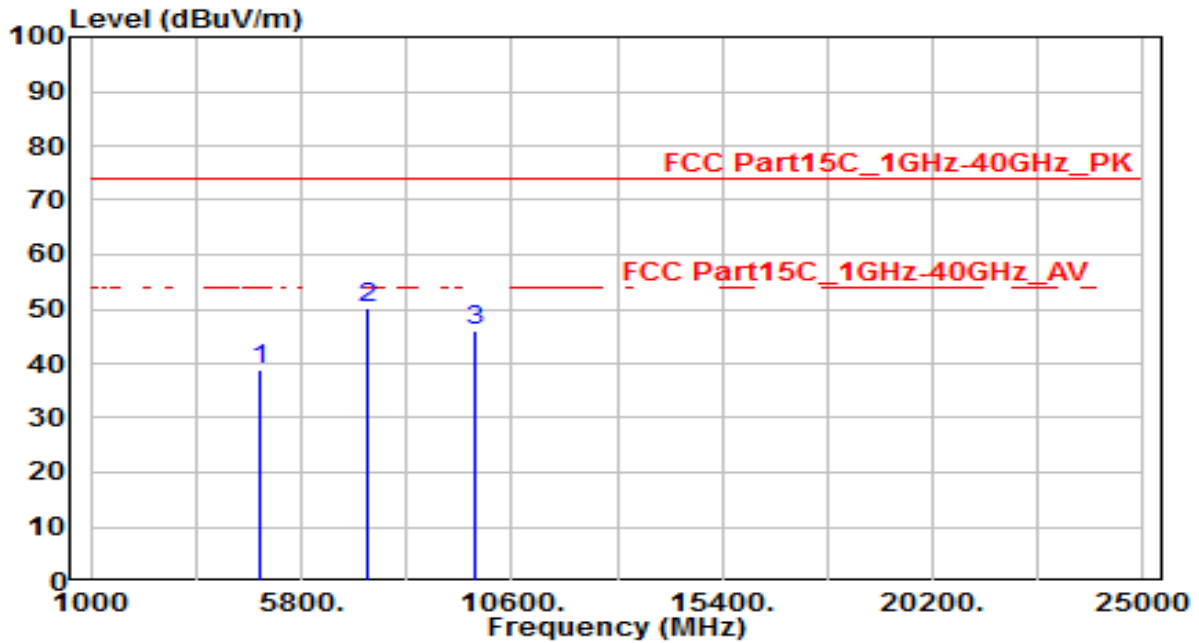

No	Frequency (MHz)	Reading (dBuV)	C.F (dB)	Measurement (dBuV/m)	Margin (dB)	Limit (dBuV/m)	Height (cm)	Angle (deg)	Remark (QP/PK/AV)
1	4874.000	35.47	3.30	38.77	-35.23	74.00	150	400	Peak
2	* 7311.000	38.73	11.29	50.02	-23.98	74.00	150	400	Peak
3	9748.000	31.63	14.43	46.06	-27.94	74.00	150	400	Peak

Note:

- "*", means this data is the worst emission level.
- C.F (Correction Factor) = Antenna Factor (dB)+ Cable Loss (dB) – Preamplifier(dB).
- Measurement (dBuV/m) = Reading(dBuV) + C.F (Correction Factor).
- The emission levels of other frequencies are very lower than the limit and not show in test report.

EUT	Indoor Camera	Date of Test	2019-11-20
Factor	BBHA 9120D & BBHA 9170	Temp. / Humidity	24°C /56%
Polarity	Horizontal	Site / Test Engineer	AC1 / Jay
Test Mode	802.11n20_TX_CH 11_ANT 0	Test Voltage	AC 120V/60Hz

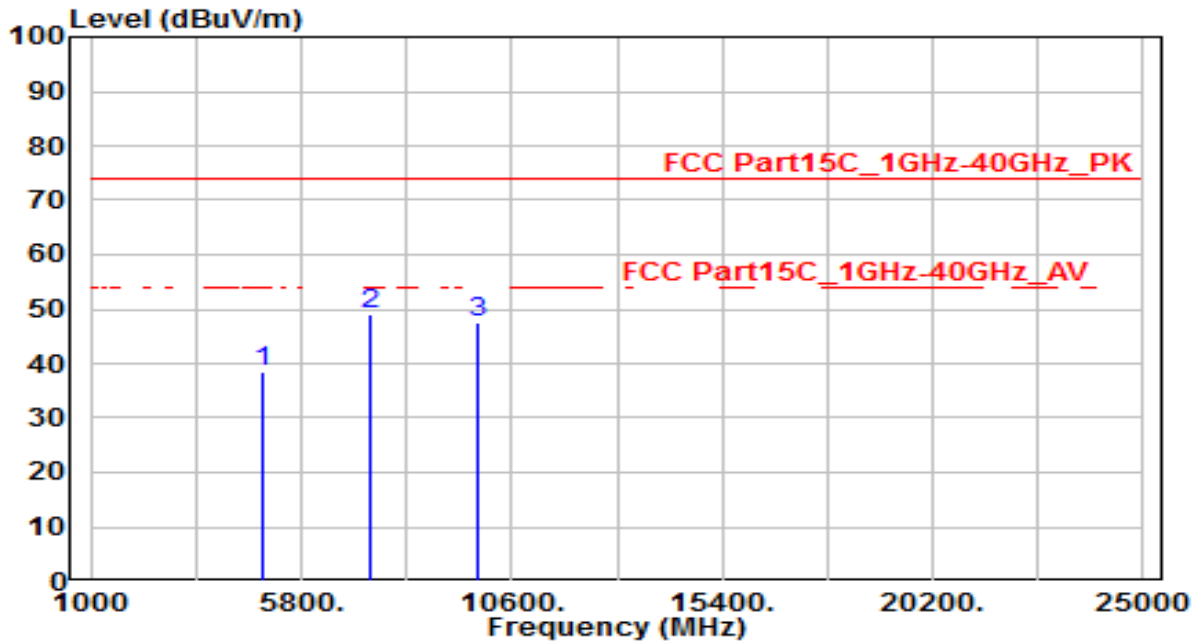

No	Frequency (MHz)	Reading (dBuV)	C.F (dB)	Measurement (dBuV/m)	Margin (dB)	Limit (dBuV/m)	Height (cm)	Angle (deg)	Remark (QP/PK/AV)
1	4924.000	35.12	3.40	38.52	-35.48	74.00	150	400	Peak
2	* 7386.000	37.69	11.46	49.15	-24.85	74.00	150	400	Peak
3	9848.000	32.88	14.76	47.64	-26.36	74.00	150	400	Peak

Note:

- "*", means this data is the worst emission level.
- C.F (Correction Factor) = Antenna Factor (dB)+ Cable Loss (dB) – Preamplifier(dB).
- Measurement (dBuV/m) = Reading(dBuV) + C.F (Correction Factor).
- The emission levels of other frequencies are very lower than the limit and not show in test report.

EUT	Indoor Camera	Date of Test	2019-11-20
Factor	BBHA 9120D & BBHA 9170	Temp. / Humidity	24°C /56%
Polarity	Vertical	Site / Test Engineer	AC1 / Jay
Test Mode	802.11n20_TX_CH 11_ANT 0	Test Voltage	AC 120V/60Hz

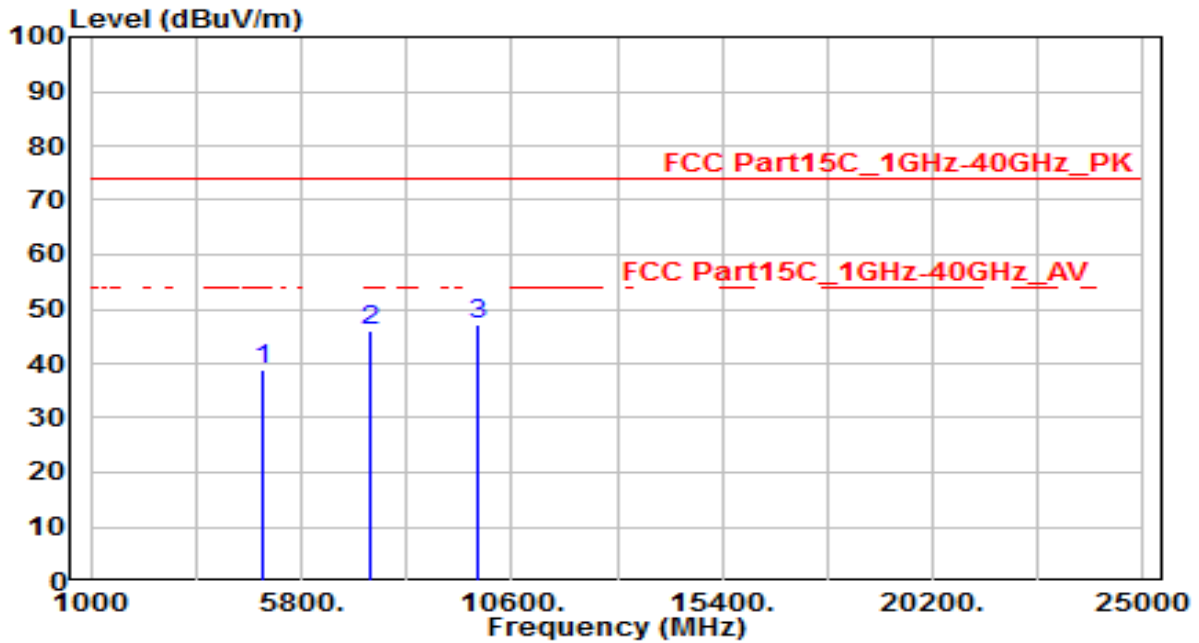

No	Frequency (MHz)	Reading (dBUV)	C.F (dB)	Measurement (dBUV/m)	Margin (dB)	Limit (dBUV/m)	Height (cm)	Angle (deg)	Remark (QP/PK/AV)
1	4924.000	35.62	3.40	39.02	-34.98	74.00	150	400	Peak
2	7386.000	34.68	11.46	46.14	-27.86	74.00	150	400	Peak
3	* 9848.000	32.36	14.76	47.12	-26.88	74.00	150	400	Peak

Note:

- "*", means this data is the worst emission level.
- C.F (Correction Factor) = Antenna Factor (dB)+ Cable Loss (dB) – Pre-amplifier(dB).
- Measurement (dBUV/m) = Reading(dBUV) + C.F (Correction Factor).
- The emission levels of other frequencies are very lower than the limit and not show in test report.

7.7. Radiated Restricted Band Edge Measurement

7.7.1. Test Limit

All out of band emissions appearing in a restricted band as specified in Section 15.205 of the Title 47 CFR must not exceed the limits shown in Table per Section 15.209.

FCC Part 15 Subpart C Paragraph 15.209		
Frequency [MHz]	Field Strength [V/m]	Measured Distance [Meters]
0.009 - 0.490	2400/F (kHz)	300
0.490 - 1.705	24000/F (kHz)	30
1.705 – 30	30	30
30 – 88	100	3
88 – 216	150	3
216 – 960	200	3
Above 960	500	3

7.7.2. Test Procedure Used

ANSI C63.10-2013 - Section 11.12.2

7.7.3. Test Setting

Peak Field Strength Measurements

1. Analyzer center frequency was set to the frequency of the radiated spurious emission of interest
2. RBW = as specified in Table 1
3. VBW = 3 * RBW
4. Detector = peak
5. Sweep time = auto couple
6. Trace mode = max hold

7. Trace was allowed to stabilize

Table 1 - RBW as a function of frequency

Frequency	RBW
9 ~ 150 kHz	200 ~ 300 Hz
0.15 ~ 30 MHz	9 ~ 10 kHz
30 ~ 1000 MHz	100 ~ 120 kHz
> 1000 MHz	1 MHz

Average Field Strength Measurements

1. Analyzer center frequency was set to the frequency of the radiated spurious emission of interest
2. RBW = 1MHz
3. VBW \geq 1/T
4. De As an alternative, the instrument may be set to linear detector mode. Ensure that video filtering is applied in linear voltage domain (rather than in a log or dB domain). Some instruments require linear display mode in order to accomplish this. Others have a setting for Average-VBW Type, which can be set to "Voltage" regardless of the display mode
5. Detector = Peak
6. Sweep time = auto
7. Trace mode = max hold
8. Allow max hold to run for at least 50 times (1/duty cycle) traces

7.7.4. Test Setup

1GHz ~ 18GHz Test Setup:

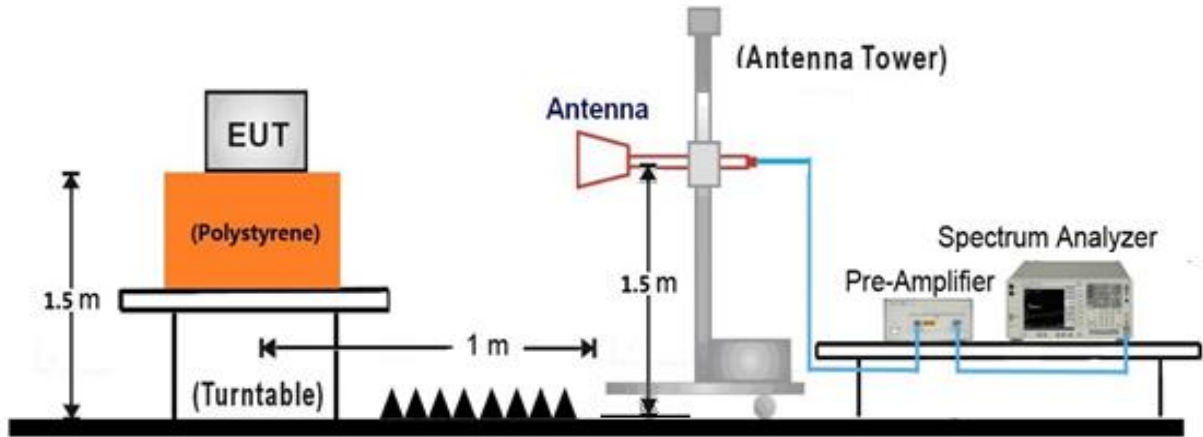

7.7.5. Test Result

EUT	Indoor Camera	Date of Test	2019-11-20
Factor	BBHA 9120D	Temp. / Humidity	24°C /56%
Polarity	Horizontal	Site / Test Engineer	AC1 / Jay
Test Mode	802.11b_TX_CH 1_ANT 0	Test Voltage	AC 120V/60Hz

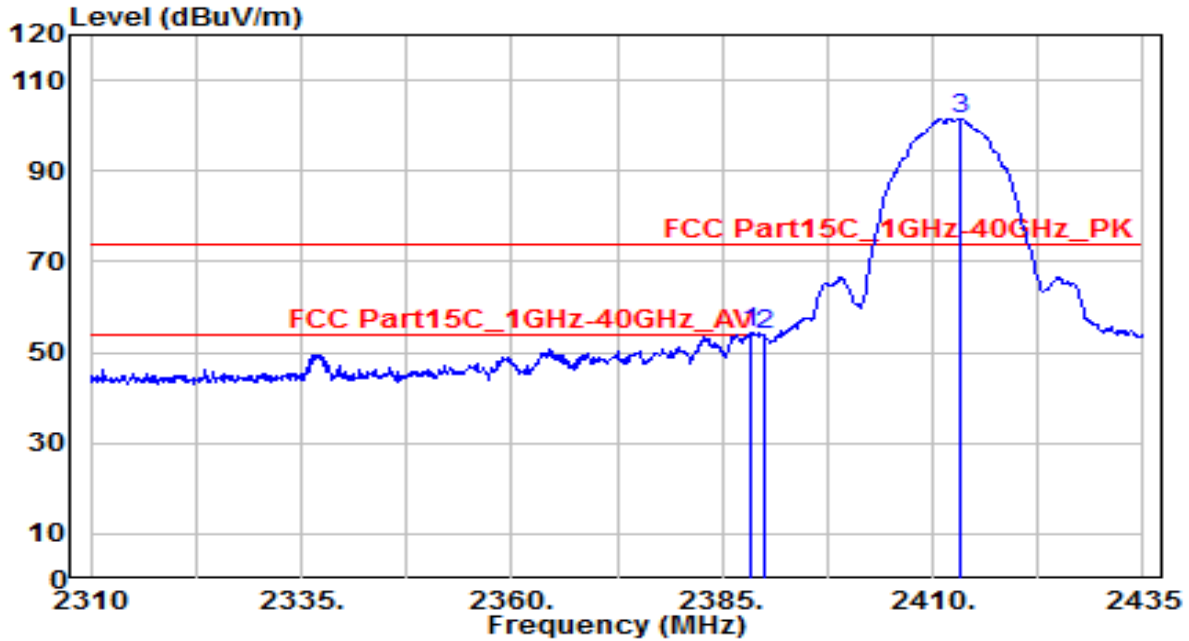

No	Frequency (MHz)	Reading (dBuV)	C.F (dB)	Measurement (dBuV/m)	Margin (dB)	Limit (dBuV/m)	Height (cm)	Angle (deg)	Remark (QP/PK/AV)
1	* 2388.250	57.14	-2.73	54.41	-19.59	74.00	150	190	Peak
2	2390.000	56.51	-2.73	53.78	-20.22	74.00	150	190	Peak
3	2413.125	104.27	-2.62	101.65	N/A	N/A	150	190	Peak

Note:

1. " *", means this data is the worst emission level.
2. C.F (Correction Factor) = Antenna Factor (dB)+ Cable Loss (dB) – Preamplifier(dB).
3. Measurement (dBuV/m) = Reading(dBuV) + C.F (Correction Factor).
4. The emission levels of other frequencies are very lower than the limit and not show in test report.

EUT	Indoor Camera	Date of Test	2019-11-20
Factor	BBHA 9120D	Temp. / Humidity	24°C /56%
Polarity	Horizontal	Site / Test Engineer	AC1 / Jay
Test Mode	802.11b_TX_CH 1_ANT 0	Test Voltage	AC 120V/60Hz

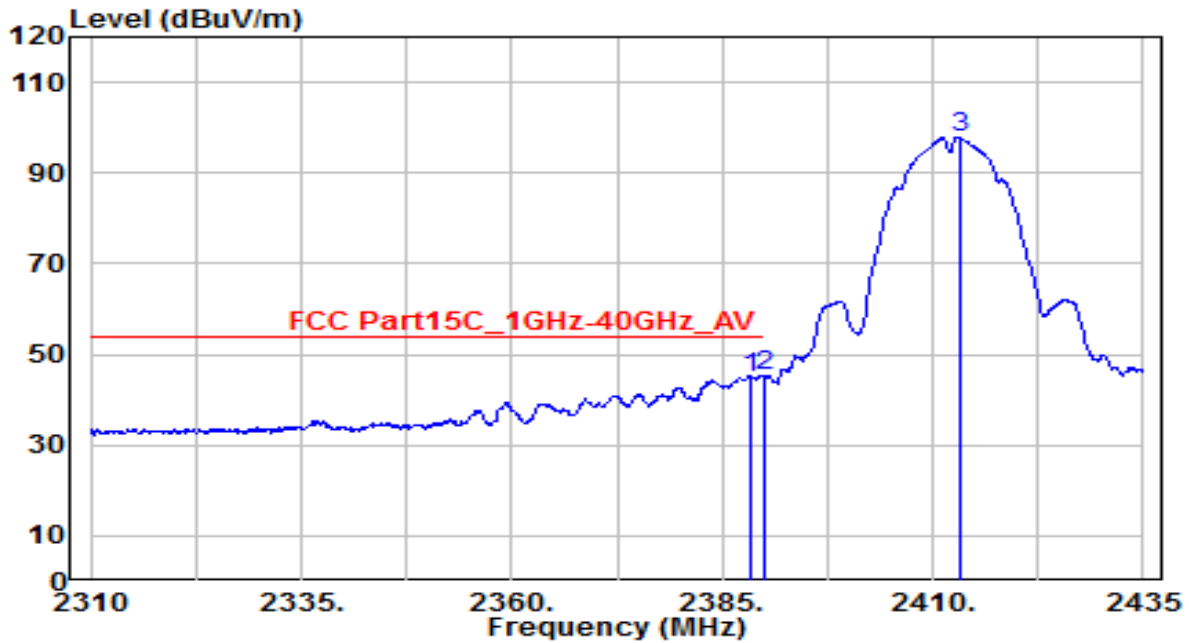

No	Frequency (MHz)	Reading (dBuV)	C.F (dB)	Measurement (dBuV/m)	Margin (dB)	Limit (dBuV/m)	Height (cm)	Angle (deg)	Remark (QP/PK/AV)
1	2388.250	47.69	-2.73	44.96	-9.04	54.00	150	190	Average
2	* 2390.000	47.79	-2.73	45.06	-8.94	54.00	150	190	Average
3	2413.125	100.43	-2.62	97.81	N/A	N/A	150	190	Average

Note:

- "*", means this data is the worst emission level.
- C.F (Correction Factor) = Antenna Factor (dB)+ Cable Loss (dB) – Preamplifier(dB).
- Measurement (dBuV/m) = Reading(dBuV) + C.F (Correction Factor).
- The emission levels of other frequencies are very lower than the limit and not show in test report.

EUT	Indoor Camera	Date of Test	2019-11-20
Factor	BBHA 9120D	Temp. / Humidity	24°C /56%
Polarity	Vertical	Site / Test Engineer	AC1 / Jay
Test Mode	802.11b_TX_CH 1_ANT 0	Test Voltage	AC 120V/60Hz

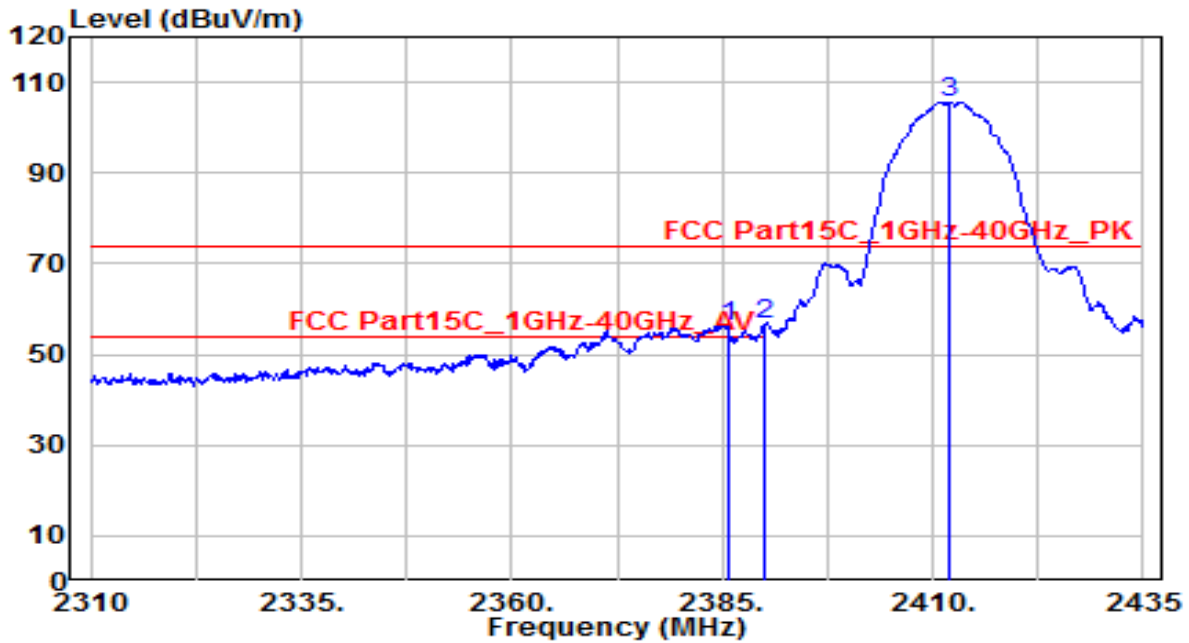

No	Frequency (MHz)	Reading (dBUV)	C.F (dB)	Measurement (dBUV/m)	Margin (dB)	Limit (dBUV/m)	Height (cm)	Angle (deg)	Remark (QP/PK/AV)
1	2385.625	59.11	-2.75	56.36	-17.64	74.00	150	235	Peak
2	* 2390.000	59.13	-2.73	56.41	-17.59	74.00	150	235	Peak
3	2412.000	108.36	-2.62	105.73	N/A	N/A	150	235	Peak

Note:

- "*", means this data is the worst emission level.
- C.F (Correction Factor) = Antenna Factor (dB)+ Cable Loss (dB) – Preamplifier(dB).
- Measurement (dBUV/m) = Reading(dBUV) + C.F (Correction Factor).
- The emission levels of other frequencies are very lower than the limit and not show in test report.

EUT	Indoor Camera	Date of Test	2019-11-20
Factor	BBHA 9120D	Temp. / Humidity	24°C /56%
Polarity	Vertical	Site / Test Engineer	AC1 / Jay
Test Mode	802.11b_TX_CH 1_ANT 0	Test Voltage	AC 120V/60Hz

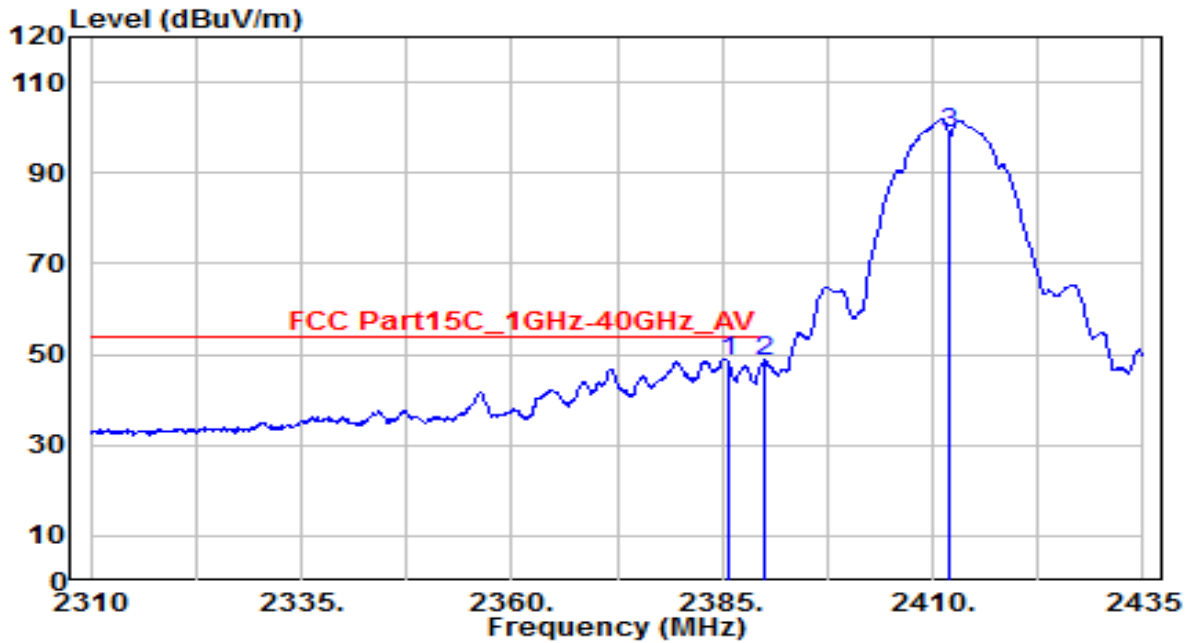

No	Frequency (MHz)	Reading (dBUV)	C.F (dB)	Measurement (dBUV/m)	Margin (dB)	Limit (dBUV/m)	Height (cm)	Angle (deg)	Remark (QP/PK/AV)
1	*	51.07	-2.75	48.32	-5.68	54.00	150	235	Average
2		51.02	-2.73	48.29	-5.71	54.00	150	235	Average
3		101.53	-2.62	98.91	N/A	N/A	150	235	Average

Note:

- "*", means this data is the worst emission level.
- C.F (Correction Factor) = Antenna Factor (dB)+ Cable Loss (dB) – Preamplifier(dB).
- Measurement (dBUV/m) = Reading(dBUV) + C.F (Correction Factor).
- The emission levels of other frequencies are very lower than the limit and not show in test report.

EUT	Indoor Camera	Date of Test	2019-11-20
Factor	BBHA 9120D	Temp. / Humidity	24°C /56%
Polarity	Horizontal	Site / Test Engineer	AC1 / Jay
Test Mode	802.11b_TX_CH 11_ANT 0	Test Voltage	AC 120V/60Hz

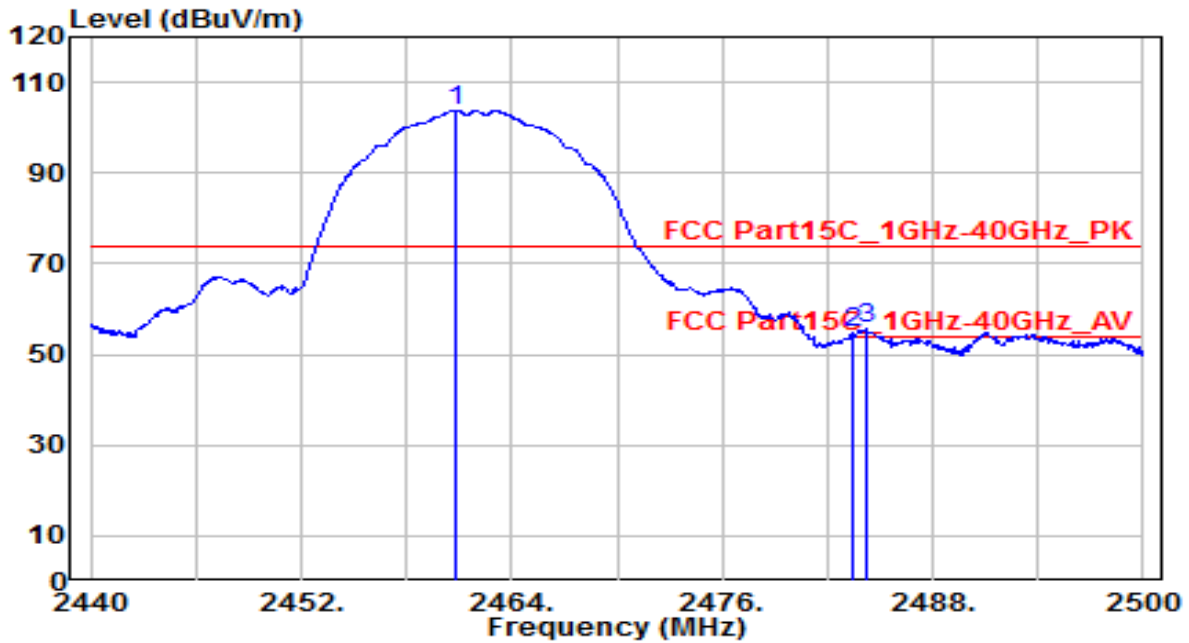

No	Frequency (MHz)	Reading (dBUV)	C.F (dB)	Measurement (dBUV/m)	Margin (dB)	Limit (dBUV/m)	Height (cm)	Angle (deg)	Remark (QP/PK/AV)
1	2460.820	106.16	-2.40	103.76	N/A	N/A	150	125	Peak
2	2483.500	57.14	-2.30	54.84	-19.16	74.00	150	125	Peak
3	* 2484.160	57.95	-2.29	55.66	-18.34	74.00	150	125	Peak

Note:

- " *", means this data is the worst emission level.
- C.F (Correction Factor) = Antenna Factor (dB)+ Cable Loss (dB) – Pre-amplifier(dB).
- Measurement (dBUV/m) = Reading(dBUV) + C.F (Correction Factor).
- The emission levels of other frequencies are very lower than the limit and not show in test report.

EUT	Indoor Camera	Date of Test	2019-11-20
Factor	BBHA 9120D	Temp. / Humidity	24°C /56%
Polarity	Horizontal	Site / Test Engineer	AC1 / Jay
Test Mode	802.11b_TX_CH 11_ANT 0	Test Voltage	AC 120V/60Hz

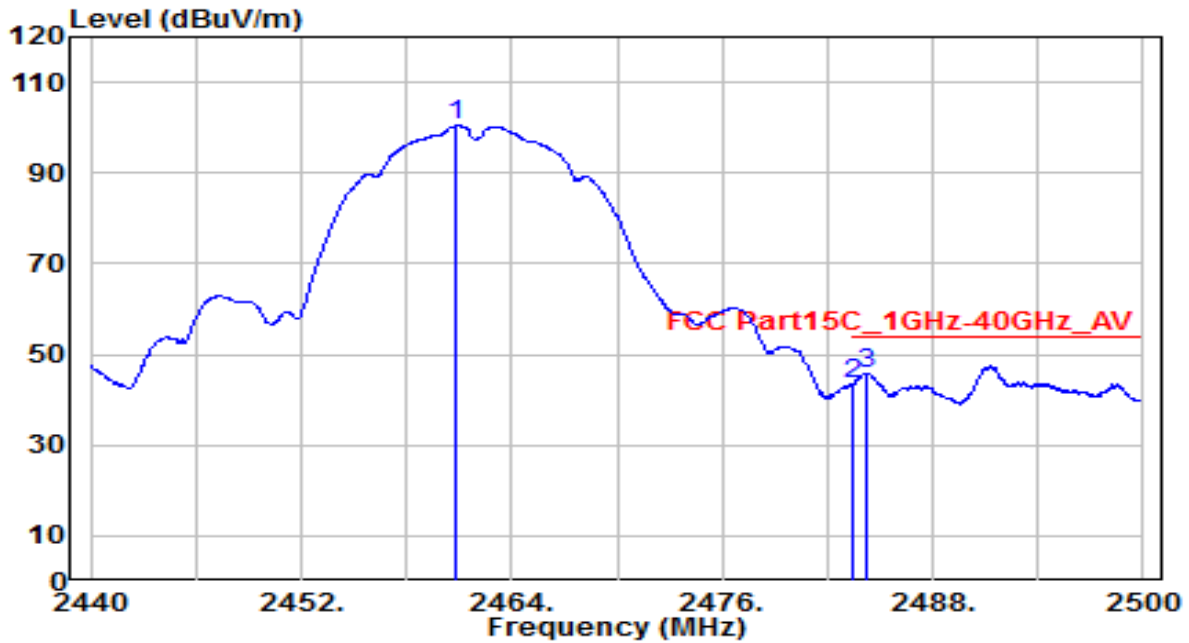

No	Frequency (MHz)	Reading (dBuV)	C.F (dB)	Measurement (dBuV/m)	Margin (dB)	Limit (dBuV/m)	Height (cm)	Angle (deg)	Remark (QP/PK/AV)
1	2460.820	102.74	-2.40	100.34	N/A	N/A	150	125	Average
2	2483.500	45.69	-2.30	43.39	-10.61	54.00	150	125	Average
3	* 2484.160	48.03	-2.29	45.73	-8.27	54.00	150	125	Average

Note:

- " *", means this data is the worst emission level.
- C.F (Correction Factor) = Antenna Factor (dB)+ Cable Loss (dB) – Pre-amplifier(dB).
- Measurement (dBuV/m) = Reading(dBuV) + C.F (Correction Factor).
- The emission levels of other frequencies are very lower than the limit and not show in test report.

EUT	Indoor Camera	Date of Test	2019-11-20
Factor	BBHA 9120D	Temp. / Humidity	24°C /56%
Polarity	Vertical	Site / Test Engineer	AC1 / Jay
Test Mode	802.11b_TX_CH 11_ANT 0	Test Voltage	AC 120V/60Hz

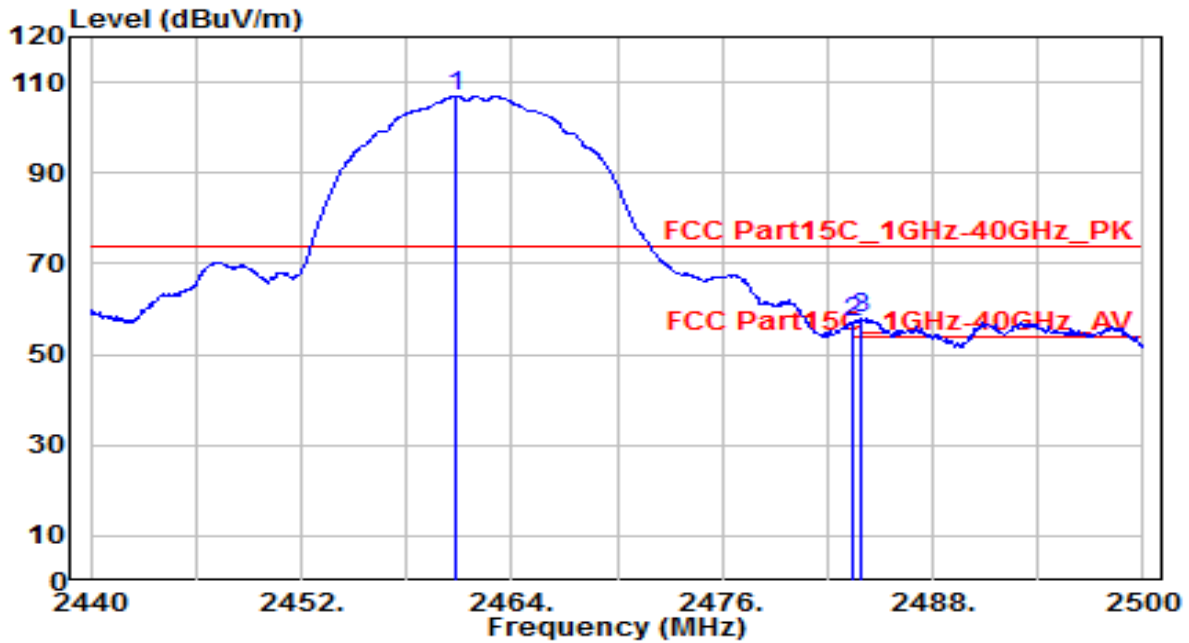

No	Frequency (MHz)	Reading (dBuV)	C.F (dB)	Measurement (dBuV/m)	Margin (dB)	Limit (dBuV/m)	Height (cm)	Angle (deg)	Remark (QP/PK/AV)
1	2460.820	109.24	-2.40	106.84	N/A	N/A	150	240	Peak
2	2483.500	59.14	-2.30	56.85	-17.15	74.00	150	240	Peak
3	* 2483.980	60.19	-2.29	57.89	-16.11	74.00	150	240	Peak

Note:

- " *", means this data is the worst emission level.
- C.F (Correction Factor) = Antenna Factor (dB)+ Cable Loss (dB) – Preamplifier(dB).
- Measurement (dBuV/m) = Reading(dBuV) + C.F (Correction Factor).
- The emission levels of other frequencies are very lower than the limit and not show in test report.

EUT	Indoor Camera	Date of Test	2019-11-20
Factor	BBHA 9120D	Temp. / Humidity	24°C /56%
Polarity	Vertical	Site / Test Engineer	AC1 / Jay
Test Mode	802.11b_TX_CH 11_ANT 0	Test Voltage	AC 120V/60Hz

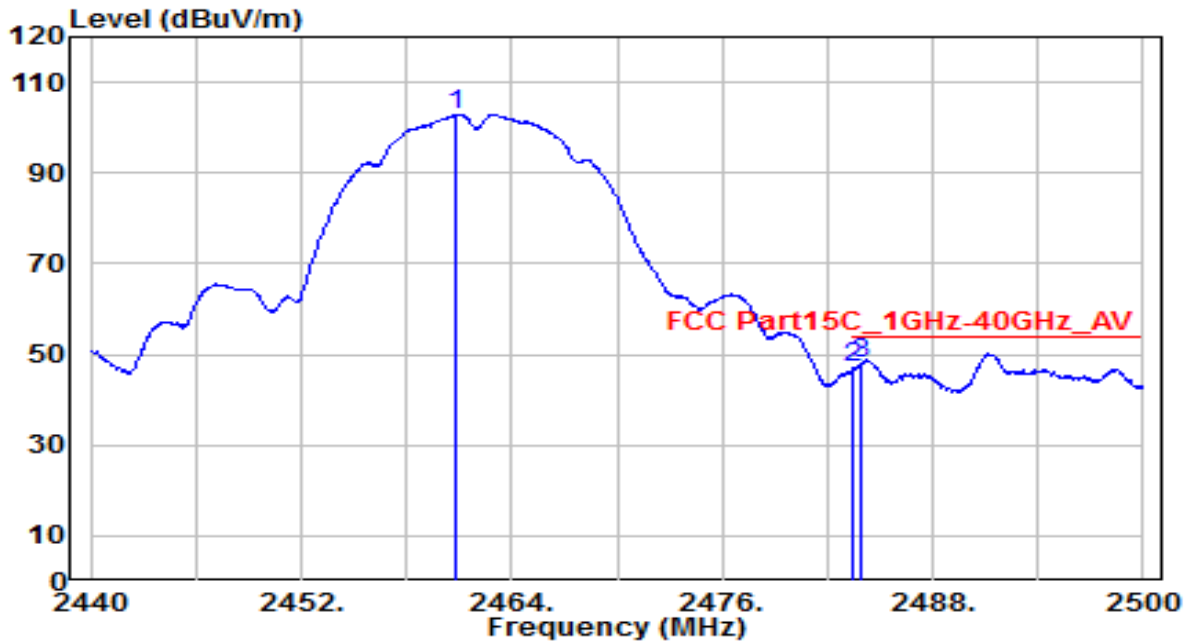

No	Frequency (MHz)	Reading (dBuV)	C.F (dB)	Measurement (dBuV/m)	Margin (dB)	Limit (dBuV/m)	Height (cm)	Angle (deg)	Remark (QP/PK/AV)
1	2460.820	105.24	-2.40	102.84	N/A	N/A	150	240	Average
2	2483.500	49.27	-2.30	46.97	-7.03	54.00	150	240	Average
3	* 2483.980	50.38	-2.29	48.09	-5.91	54.00	150	240	Average

Note:

- " *", means this data is the worst emission level.
- C.F (Correction Factor) = Antenna Factor (dB)+ Cable Loss (dB) – Preamplifier(dB).
- Measurement (dBuV/m) = Reading(dBuV) + C.F (Correction Factor).
- The emission levels of other frequencies are very lower than the limit and not show in test report.

EUT	Indoor Camera	Date of Test	2019-11-20
Factor	BBHA 9120D	Temp. / Humidity	24°C /56%
Polarity	Horizontal	Site / Test Engineer	AC1 / Jay
Test Mode	802.11g_TX_CH 1_ANT 0	Test Voltage	AC 120V/60Hz

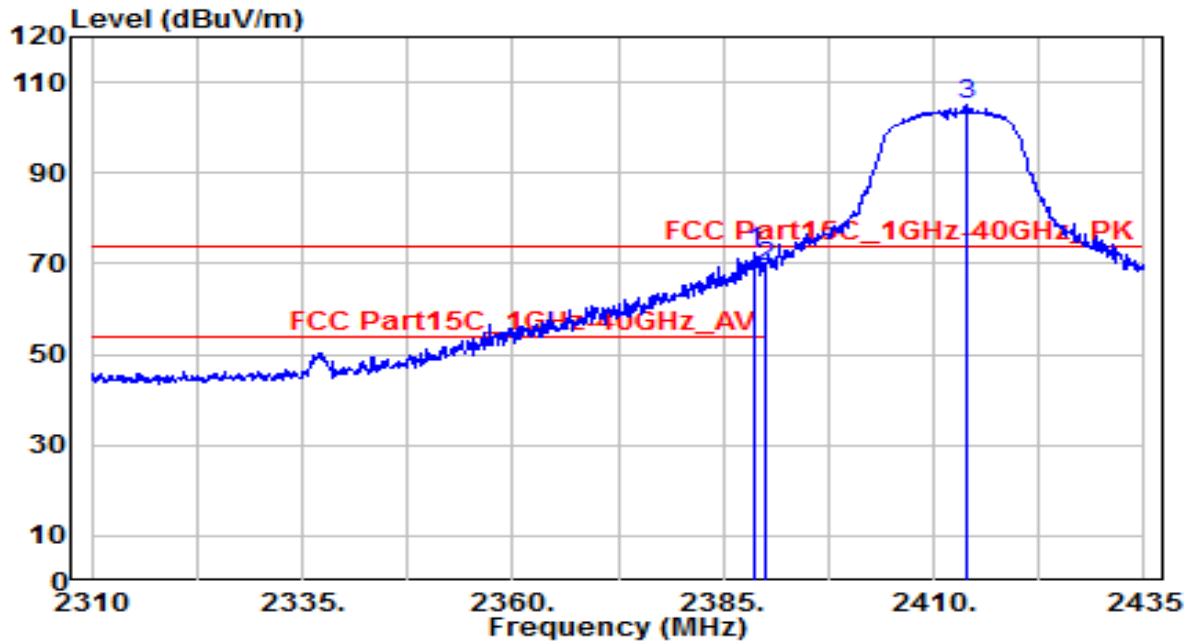

No	Frequency (MHz)	Reading (dBUV)	C.F (dB)	Measurement (dBUV/m)	Margin (dB)	Limit (dBUV/m)	Height (cm)	Angle (deg)	Remark (QP/PK/AV)
1	* 2388.750	75.27	-2.73	72.53	-1.47	74.00	150	185	Peak
2	2390.000	71.90	-2.73	69.17	-4.83	74.00	150	185	Peak
3	2414.000	107.59	-2.62	104.97	N/A	N/A	150	185	Peak

Note:

- "*", means this data is the worst emission level.
- C.F (Correction Factor) = Antenna Factor (dB)+ Cable Loss (dB) – Preamplifier(dB).
- Measurement (dBUV/m) = Reading(dBUV) + C.F (Correction Factor).
- The emission levels of other frequencies are very lower than the limit and not show in test report.

EUT	Indoor Camera	Date of Test	2019-11-20
Factor	BBHA 9120D	Temp. / Humidity	24°C /56%
Polarity	Horizontal	Site / Test Engineer	AC1 / Jay
Test Mode	802.11g_TX_CH 1_ANT 0	Test Voltage	AC 120V/60Hz

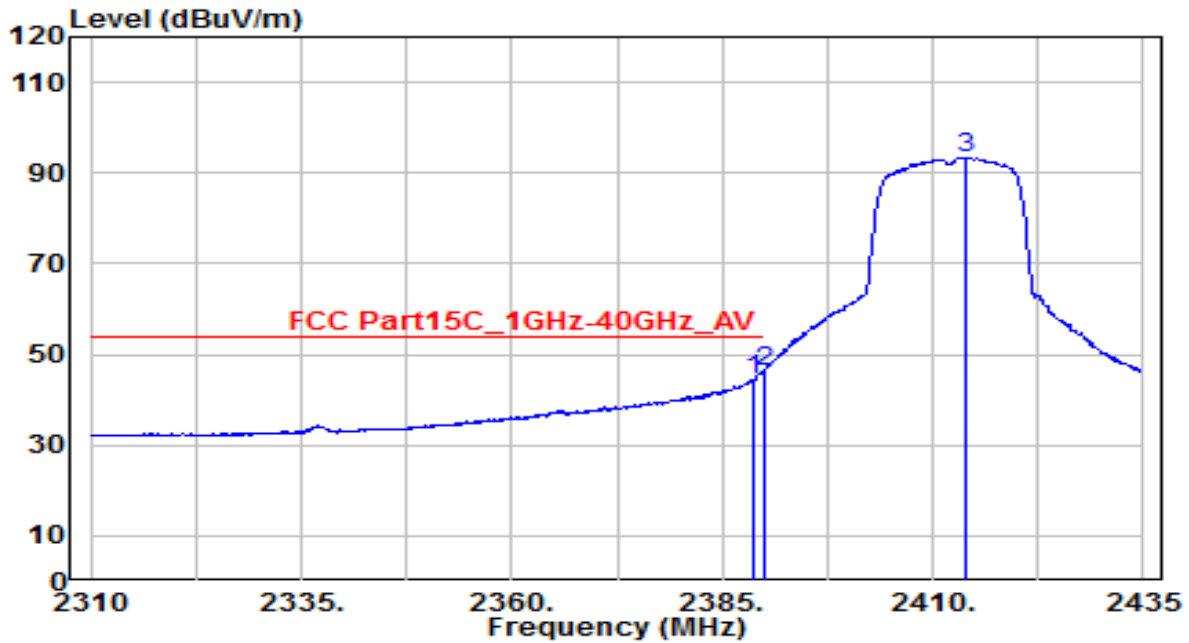

No	Frequency (MHz)	Reading (dBuV)	C.F (dB)	Measurement (dBuV/m)	Margin (dB)	Limit (dBuV/m)	Height (cm)	Angle (deg)	Remark (QP/PK/AV)
1	2388.750	47.08	-2.73	44.35	-9.65	54.00	150	185	Average
2	* 2390.000	49.06	-2.73	46.33	-7.67	54.00	150	185	Average
3	2414.000	96.08	-2.62	93.47	N/A	N/A	150	185	Average

Note:

- "*", means this data is the worst emission level.
- C.F (Correction Factor) = Antenna Factor (dB)+ Cable Loss (dB) – Preamplifier(dB).
- Measurement (dBuV/m) = Reading(dBuV) + C.F (Correction Factor).
- The emission levels of other frequencies are very lower than the limit and not show in test report.

EUT	Indoor Camera	Date of Test	2019-11-20
Factor	BBHA 9120D	Temp. / Humidity	24°C /56%
Polarity	Vertical	Site / Test Engineer	AC1 / Jay
Test Mode	802.11g_TX_CH 1_ANT 0	Test Voltage	AC 120V/60Hz

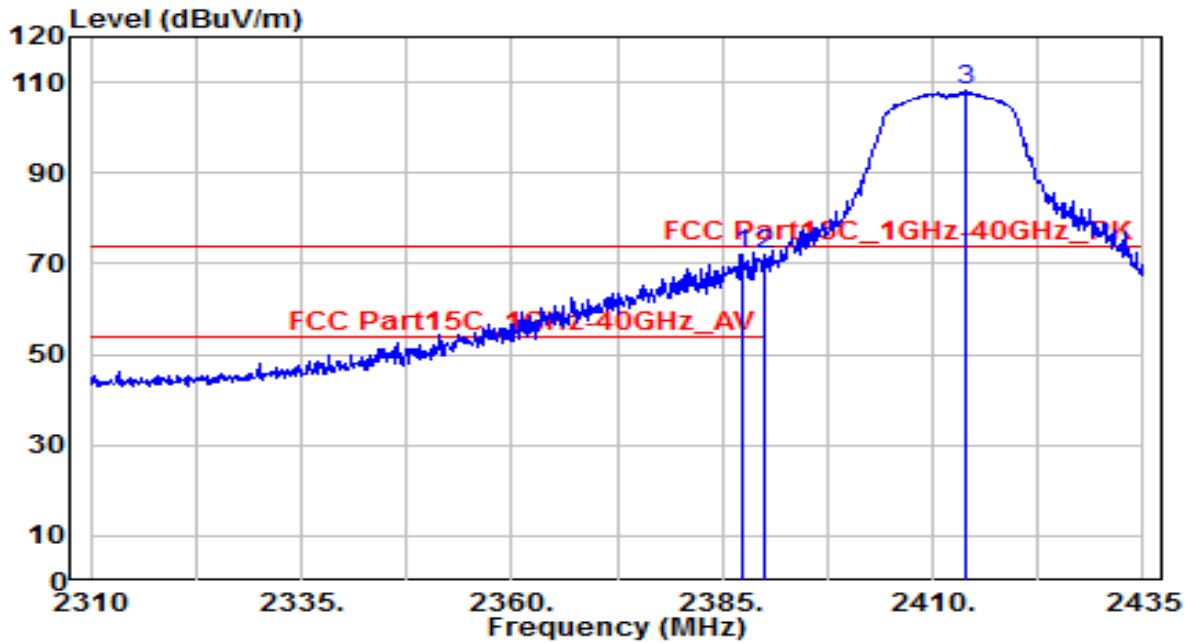

No	Frequency (MHz)	Reading (dBuV)	C.F (dB)	Measurement (dBuV/m)	Margin (dB)	Limit (dBuV/m)	Height (cm)	Angle (deg)	Remark (QP/PK/AV)
1	2387.500	74.88	-2.74	72.15	-1.85	74.00	150	285	Peak
2	* 2390.000	74.92	-2.73	72.20	-1.80	74.00	150	285	Peak
3	2414.000	110.86	-2.62	108.25	N/A	N/A	150	285	Peak

Note:

- "*", means this data is the worst emission level.
- C.F (Correction Factor) = Antenna Factor (dB)+ Cable Loss (dB) – Preamplifier(dB).
- Measurement (dBuV/m) = Reading(dBuV) + C.F (Correction Factor).
- The emission levels of other frequencies are very lower than the limit and not show in test report.

EUT	Indoor Camera	Date of Test	2019-11-20
Factor	BBHA 9120D	Temp. / Humidity	24°C /56%
Polarity	Vertical	Site / Test Engineer	AC1 / Jay
Test Mode	802.11g_TX_CH 1_ANT 0	Test Voltage	AC 120V/60Hz

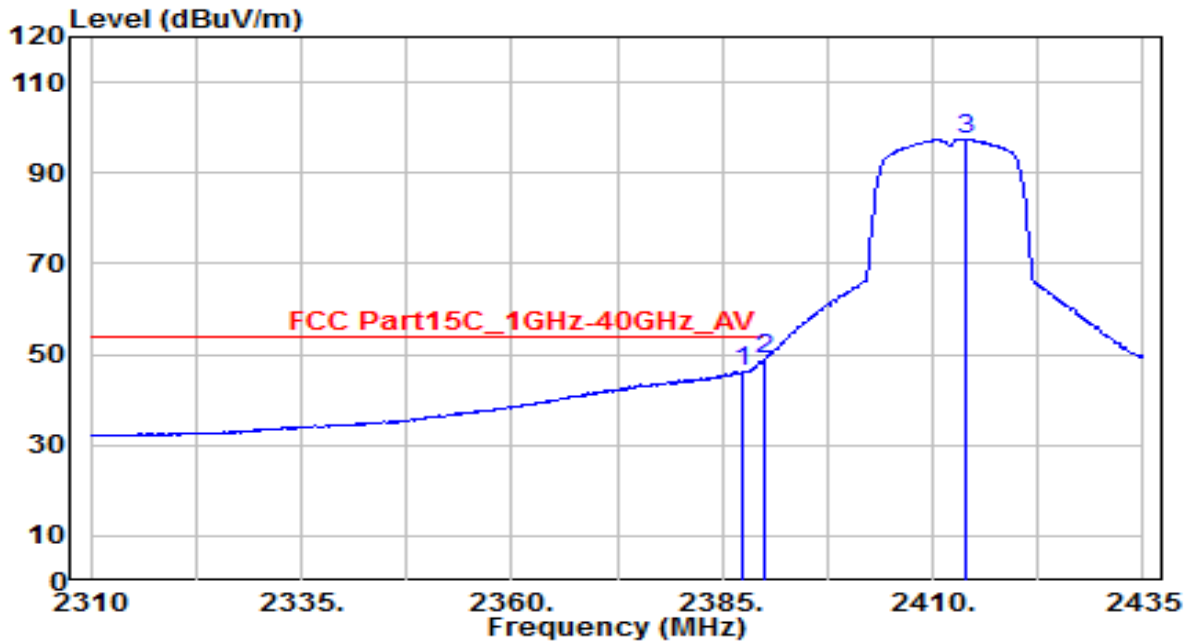

No	Frequency (MHz)	Reading (dBUV)	C.F (dB)	Measurement (dBUV/m)	Margin (dB)	Limit (dBUV/m)	Height (cm)	Angle (deg)	Remark (QP/PK/AV)
1	2387.500	48.71	-2.74	45.97	-8.03	54.00	150	285	Average
2	* 2390.000	51.48	-2.73	48.76	-5.24	54.00	150	285	Average
3	2414.000	99.81	-2.62	97.20	N/A	N/A	150	285	Average

Note:

- "*", means this data is the worst emission level.
- C.F (Correction Factor) = Antenna Factor (dB)+ Cable Loss (dB) – Preamplifier(dB).
- Measurement (dBUV/m) = Reading(dBUV) + C.F (Correction Factor).
- The emission levels of other frequencies are very lower than the limit and not show in test report.

EUT	Indoor Camera	Date of Test	2019-11-20
Factor	BBHA 9120D	Temp. / Humidity	24°C /56%
Polarity	Horizontal	Site / Test Engineer	AC1 / Jay
Test Mode	802.11g_TX_CH 11_ANT 0	Test Voltage	AC 120V/60Hz

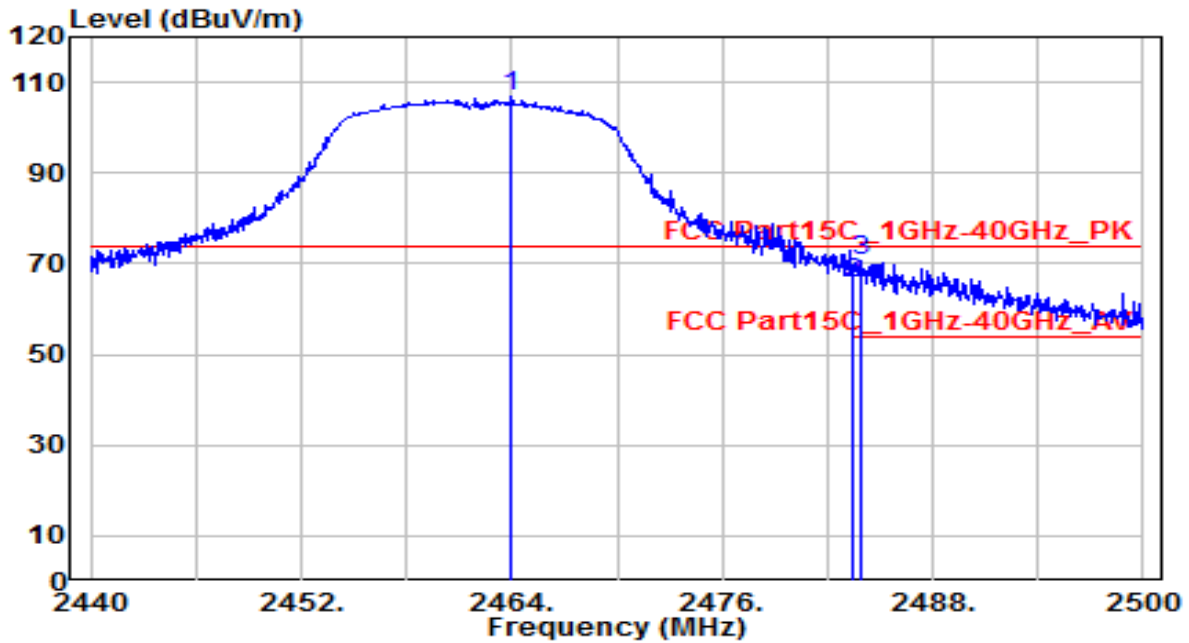

No	Frequency (MHz)	Reading (dBuV)	C.F (dB)	Measurement (dBuV/m)	Margin (dB)	Limit (dBuV/m)	Height (cm)	Angle (deg)	Remark (QP/PK/AV)
1	2463.940	109.12	-2.39	106.73	N/A	N/A	150	125	Peak
2	2483.500	68.13	-2.30	65.83	-8.17	74.00	150	125	Peak
3	* 2483.980	72.72	-2.29	70.43	-3.57	74.00	150	125	Peak

Note:

- "*", means this data is the worst emission level.
- C.F (Correction Factor) = Antenna Factor (dB)+ Cable Loss (dB) – Preamplifier(dB).
- Measurement (dBuV/m) = Reading(dBuV) + C.F (Correction Factor).
- The emission levels of other frequencies are very lower than the limit and not show in test report.

EUT	Indoor Camera	Date of Test	2019-11-20
Factor	BBHA 9120D	Temp. / Humidity	24°C /56%
Polarity	Horizontal	Site / Test Engineer	AC1 / Jay
Test Mode	802.11g_TX_CH 11_ANT 0	Test Voltage	AC 120V/60Hz

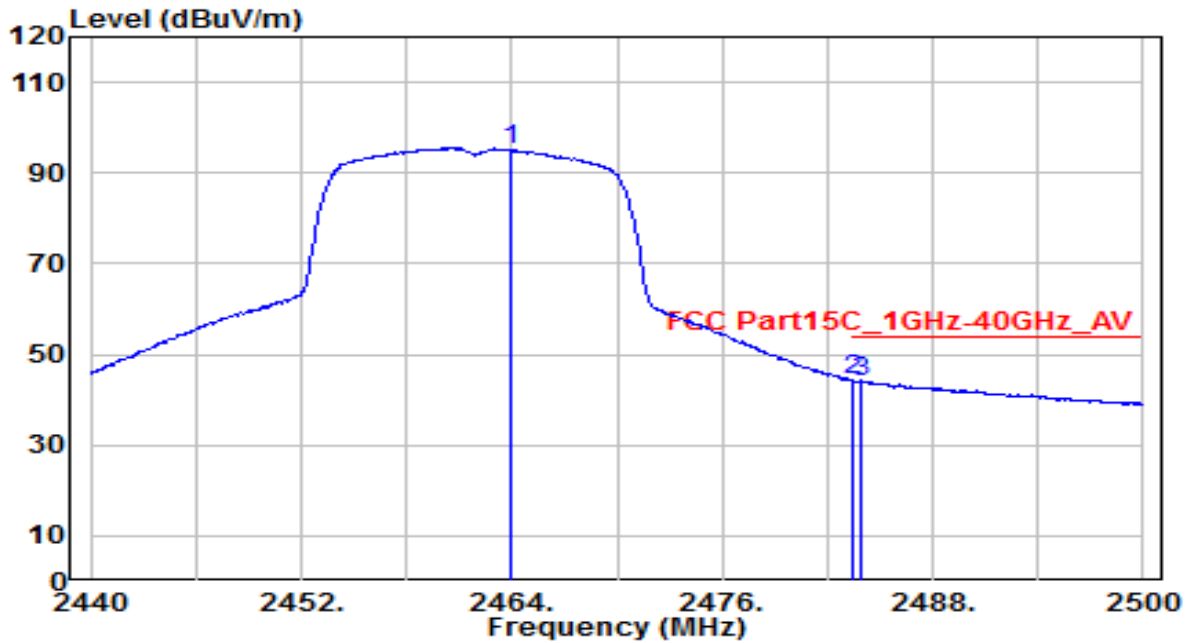

No	Frequency (MHz)	Reading (dBuV)	C.F (dB)	Measurement (dBuV/m)	Margin (dB)	Limit (dBuV/m)	Height (cm)	Angle (deg)	Remark (QP/PK/AV)
1	2463.940	97.49	-2.39	95.10	N/A	N/A	150	125	Average
2	* 2483.500	46.47	-2.30	44.18	-9.82	54.00	150	125	Average
3	2483.980	46.33	-2.29	44.03	-9.97	54.00	150	125	Average

Note:

- "*" means this data is the worst emission level.
- C.F (Correction Factor) = Antenna Factor (dB)+ Cable Loss (dB) – Pre-amplifier(dB).
- Measurement (dBuV/m) = Reading(dBuV) + C.F (Correction Factor).
- The emission levels of other frequencies are very lower than the limit and not show in test report.

EUT	Indoor Camera	Date of Test	2019-11-20
Factor	BBHA 9120D	Temp. / Humidity	24°C /56%
Polarity	Vertical	Site / Test Engineer	AC1 / Jay
Test Mode	802.11g_TX_CH 11_ANT 0	Test Voltage	AC 120V/60Hz

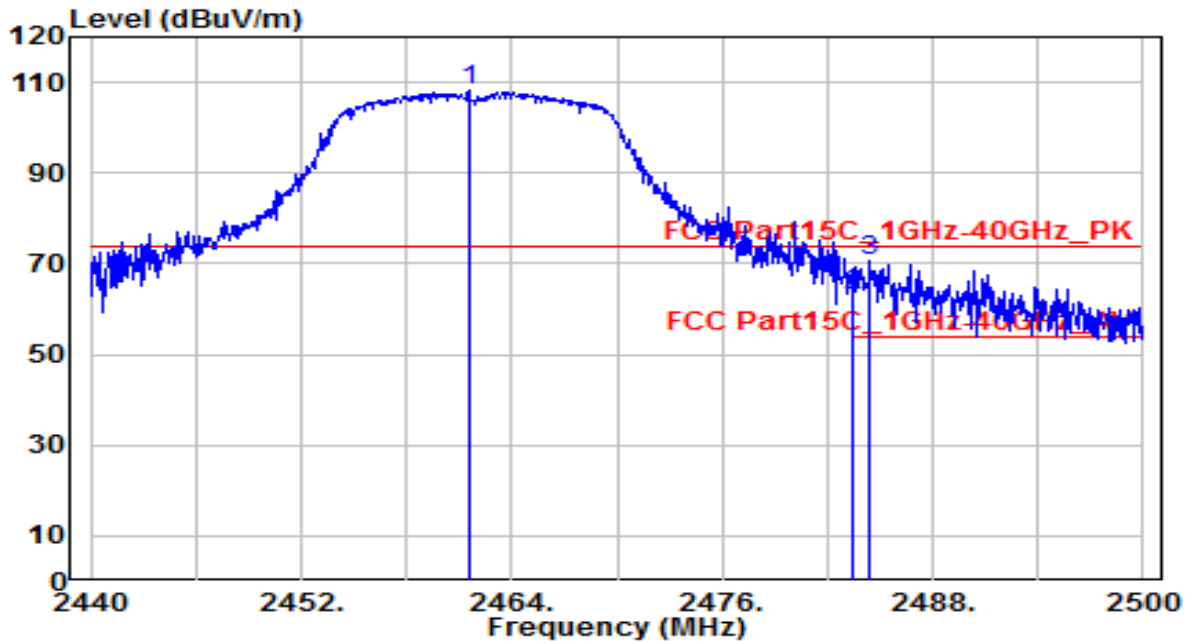

No	Frequency (MHz)	Reading (dBUV)	C.F (dB)	Measurement (dBUV/m)	Margin (dB)	Limit (dBUV/m)	Height (cm)	Angle (deg)	Remark (QP/PK/AV)
1	2461.600	110.81	-2.40	108.42	N/A	N/A	150	220	Peak
2	2483.500	65.06	-2.30	62.76	-11.24	74.00	150	220	Peak
3	* 2484.460	72.80	-2.29	70.51	-3.49	74.00	150	220	Peak

Note:

- "*", means this data is the worst emission level.
- C.F (Correction Factor) = Antenna Factor (dB)+ Cable Loss (dB) – Pre-amplifier(dB).
- Measurement (dBUV/m) = Reading(dBUV) + C.F (Correction Factor).
- The emission levels of other frequencies are very lower than the limit and not show in test report.

EUT	Indoor Camera	Date of Test	2019-11-20
Factor	BBHA 9120D	Temp. / Humidity	24°C /56%
Polarity	Vertical	Site / Test Engineer	AC1 / Jay
Test Mode	802.11g_TX_CH 11_ANT 0	Test Voltage	AC 120V/60Hz

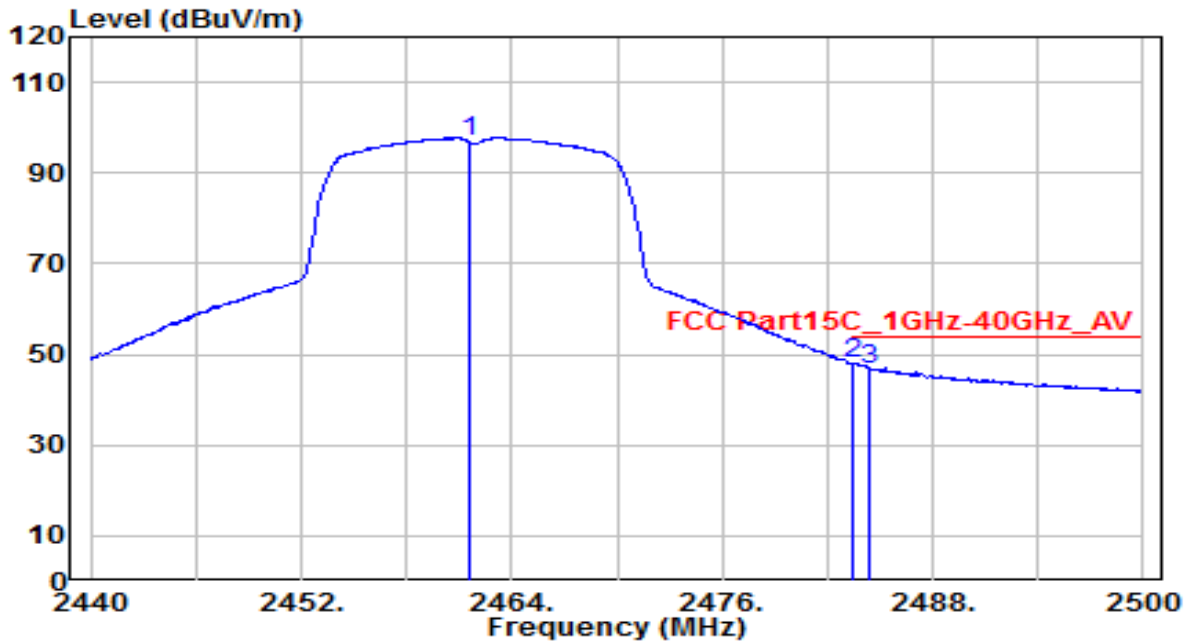

No	Frequency (MHz)	Reading (dBuV)	C.F (dB)	Measurement (dBuV/m)	Margin (dB)	Limit (dBuV/m)	Height (cm)	Angle (deg)	Remark (QP/PK/AV)
1	2461.600	99.31	-2.40	96.91	N/A	N/A	150	220	Average
2	* 2483.500	50.39	-2.30	48.09	-5.91	54.00	150	220	Average
3	2484.460	49.16	-2.29	46.87	-7.13	54.00	150	220	Average

Note:

- "*", means this data is the worst emission level.
- C.F (Correction Factor) = Antenna Factor (dB)+ Cable Loss (dB) – Preamplifier(dB).
- Measurement (dBuV/m) = Reading(dBuV) + C.F (Correction Factor).
- The emission levels of other frequencies are very lower than the limit and not show in test report.

EUT	Indoor Camera	Date of Test	2019-11-20
Factor	BBHA 9120D	Temp. / Humidity	24°C /56%
Polarity	Horizontal	Site / Test Engineer	AC1 / Jay
Test Mode	802.11n20_TX_CH 1_ANT 0	Test Voltage	AC 110V/60Hz

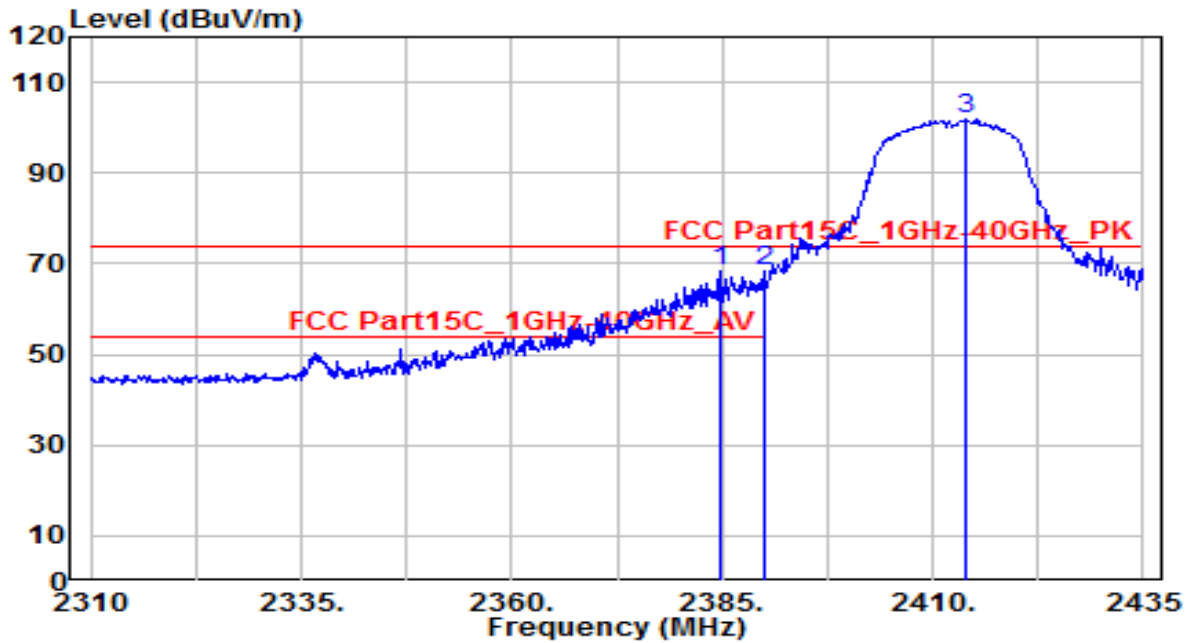

No	Frequency (MHz)	Reading (dBuV)	C.F (dB)	Measurement (dBuV/m)	Margin (dB)	Limit (dBuV/m)	Height (cm)	Angle (deg)	Remark (QP/PK/AV)
1	2384.900	70.96	-2.75	68.21	-5.79	74.00	150	120	Peak
2	* 2390.000	70.97	-2.73	68.24	-5.76	74.00	150	120	Peak
3	2413.880	104.37	-2.62	101.75	N/A	N/A	150	120	Peak

Note:

- "*", means this data is the worst emission level.
- C.F (Correction Factor) = Antenna Factor (dB)+ Cable Loss (dB) – Preamplifier(dB).
- Measurement (dBuV/m) = Reading(dBuV) + C.F (Correction Factor).
- The emission levels of other frequencies are very lower than the limit and not show in test report.

EUT	Indoor Camera	Date of Test	2019-11-20
Factor	BBHA 9120D	Temp. / Humidity	24°C /56%
Polarity	Horizontal	Site / Test Engineer	AC1 / Jay
Test Mode	802.11n20_TX_CH 1_ANT 0	Test Voltage	AC 110V/60Hz

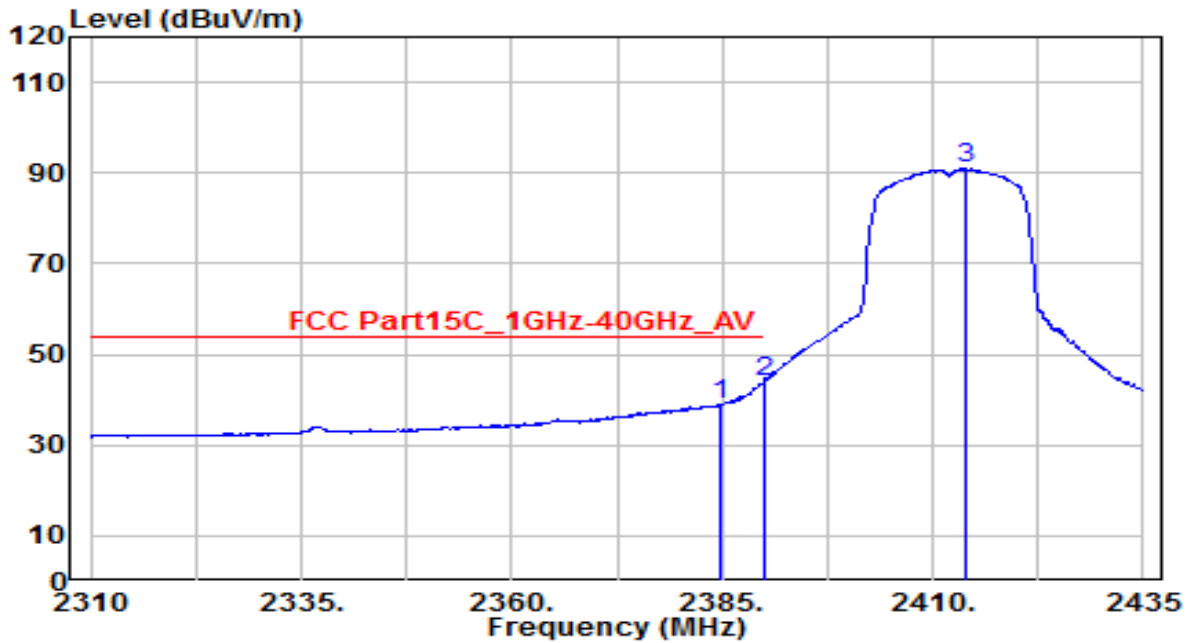

No	Frequency (MHz)	Reading (dBUV)	C.F (dB)	Measurement (dBUV/m)	Margin (dB)	Limit (dBUV/m)	Height (cm)	Angle (deg)	Remark (QP/PK/AV)
1	2384.900	41.71	-2.75	38.96	-15.04	54.00	150	120	Average
2	* 2390.000	46.63	-2.73	43.91	-10.09	54.00	150	120	Average
3	2413.880	93.48	-2.62	90.87	N/A	N/A	150	120	Average

Note:

- "*", means this data is the worst emission level.
- C.F (Correction Factor) = Antenna Factor (dB)+ Cable Loss (dB) – Preamplifier(dB).
- Measurement (dBUV/m) = Reading(dBUV) + C.F (Correction Factor).
- The emission levels of other frequencies are very lower than the limit and not show in test report.

EUT	Indoor Camera	Date of Test	2019-11-20
Factor	BBHA 9120D	Temp. / Humidity	24°C /56%
Polarity	Vertical	Site / Test Engineer	AC1 / Jay
Test Mode	802.11n20_TX_CH 1_ANT 0	Test Voltage	AC 110V/60Hz

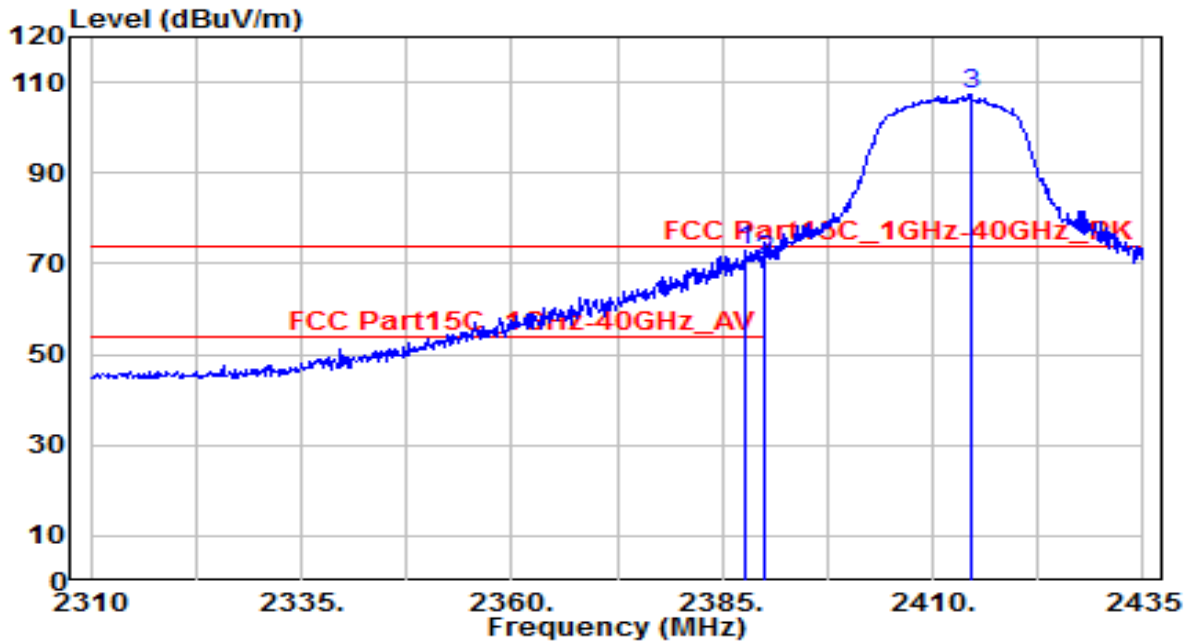

No	Frequency (MHz)	Reading (dBuV)	C.F (dB)	Measurement (dBuV/m)	Margin (dB)	Limit (dBuV/m)	Height (cm)	Angle (deg)	Remark (QP/PK/AV)
1	* 2387.840	75.60	-2.74	72.86	-1.14	74.00	150	240	Peak
2	2390.000	73.21	-2.73	70.48	-3.52	74.00	150	240	Peak
3	2414.580	109.98	-2.61	107.37	N/A	N/A	150	240	Peak

Note:

- "*", means this data is the worst emission level.
- C.F (Correction Factor) = Antenna Factor (dB)+ Cable Loss (dB) – Preamplifier(dB).
- Measurement (dBuV/m) = Reading(dBuV) + C.F (Correction Factor).
- The emission levels of other frequencies are very lower than the limit and not show in test report.

EUT	Indoor Camera	Date of Test	2019-11-20
Factor	BBHA 9120D	Temp. / Humidity	24°C /56%
Polarity	Vertical	Site / Test Engineer	AC1 / Jay
Test Mode	802.11n20_TX_CH 1_ANT 0	Test Voltage	AC 110V/60Hz

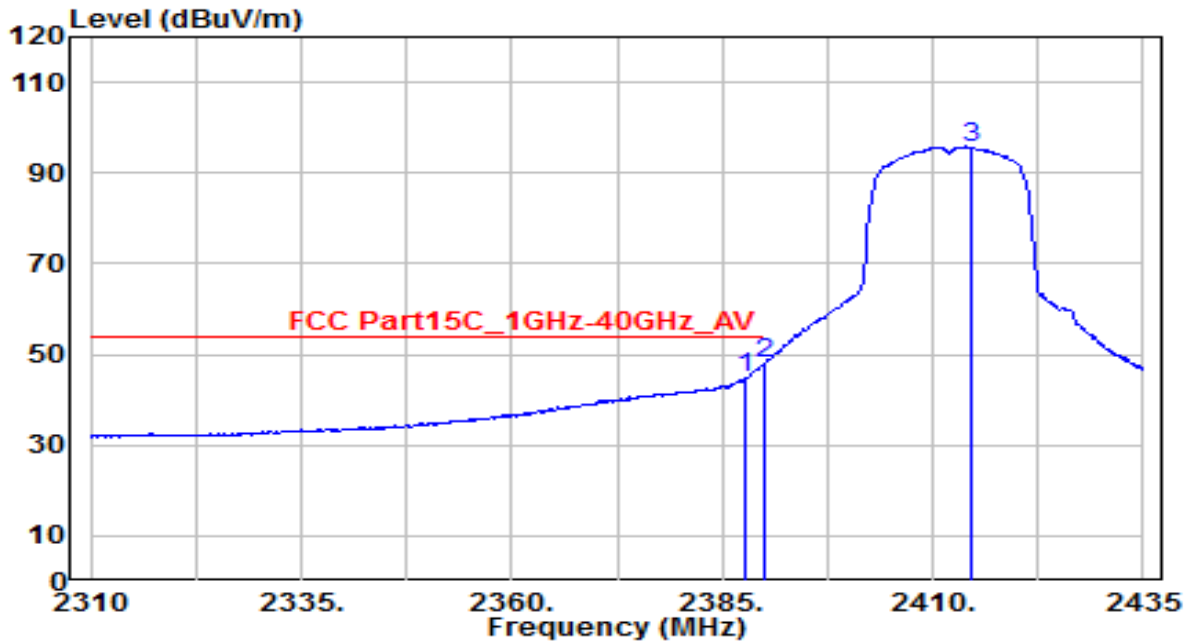

No	Frequency (MHz)	Reading (dBUV)	C.F (dB)	Measurement (dBUV/m)	Margin (dB)	Limit (dBUV/m)	Height (cm)	Angle (deg)	Remark (QP/PK/AV)
1	2387.840	47.40	-2.74	44.67	-9.33	54.00	150	240	Average
2	* 2390.000	50.74	-2.73	48.02	-5.98	54.00	150	240	Average
3	2414.580	98.14	-2.61	95.53	N/A	N/A	150	240	Average

Note:

- "*", means this data is the worst emission level.
- C.F (Correction Factor) = Antenna Factor (dB)+ Cable Loss (dB) – Pre-amplifier(dB).
- Measurement (dBUV/m) = Reading(dBUV) + C.F (Correction Factor).
- The emission levels of other frequencies are very lower than the limit and not show in test report.

EUT	Indoor Camera	Date of Test	2019-11-20
Factor	BBHA 9120D	Temp. / Humidity	24°C /56%
Polarity	Horizontal	Site / Test Engineer	AC1 / Jay
Test Mode	802.11n20_TX_CH 11_ANT 0	Test Voltage	AC 110V/60Hz

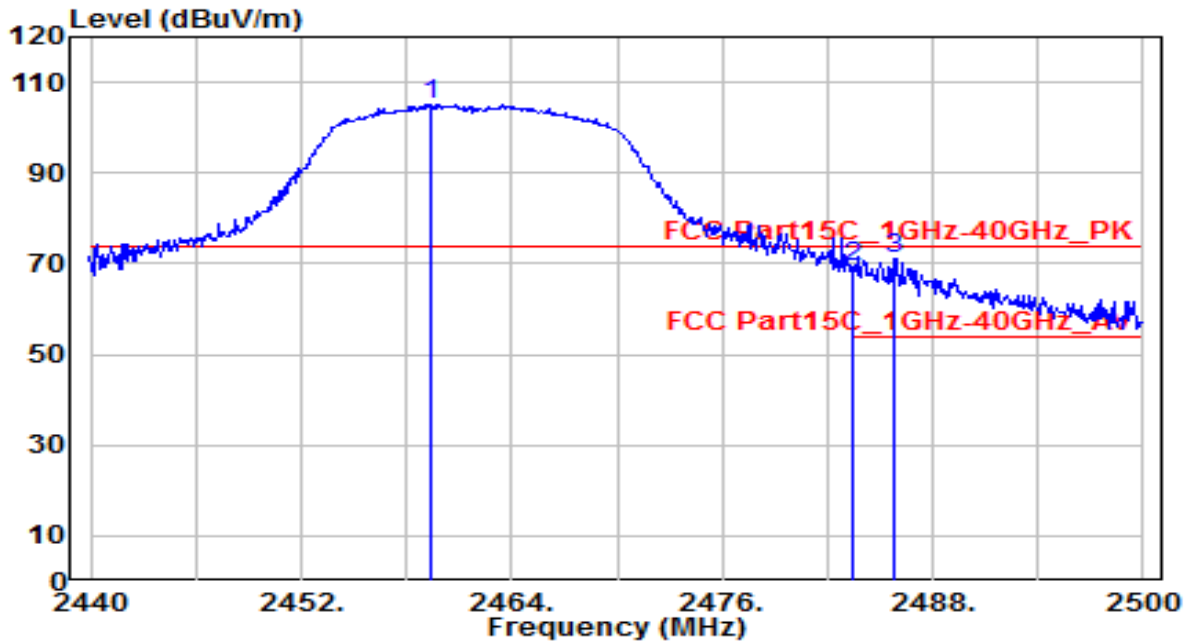

No	Frequency (MHz)	Reading (dBuV)	C.F (dB)	Measurement (dBuV/m)	Margin (dB)	Limit (dBuV/m)	Height (cm)	Angle (deg)	Remark (QP/PK/AV)
1	2459.360	107.49	-2.41	105.08	N/A	N/A	150	120	Peak
2	2483.500	71.44	-2.30	69.15	-4.85	74.00	150	120	Peak
3	* 2485.840	73.58	-2.29	71.30	-2.70	74.00	150	120	Peak

Note:

- "*", means this data is the worst emission level.
- C.F (Correction Factor) = Antenna Factor (dB)+ Cable Loss (dB) – Preamplifier(dB).
- Measurement (dBuV/m) = Reading(dBuV) + C.F (Correction Factor).
- The emission levels of other frequencies are very lower than the limit and not show in test report.

EUT	Indoor Camera	Date of Test	2019-11-20
Factor	BBHA 9120D	Temp. / Humidity	24°C /56%
Polarity	Horizontal	Site / Test Engineer	AC1 / Jay
Test Mode	802.11n20_TX_CH 11_ANT 0	Test Voltage	AC 110V/60Hz

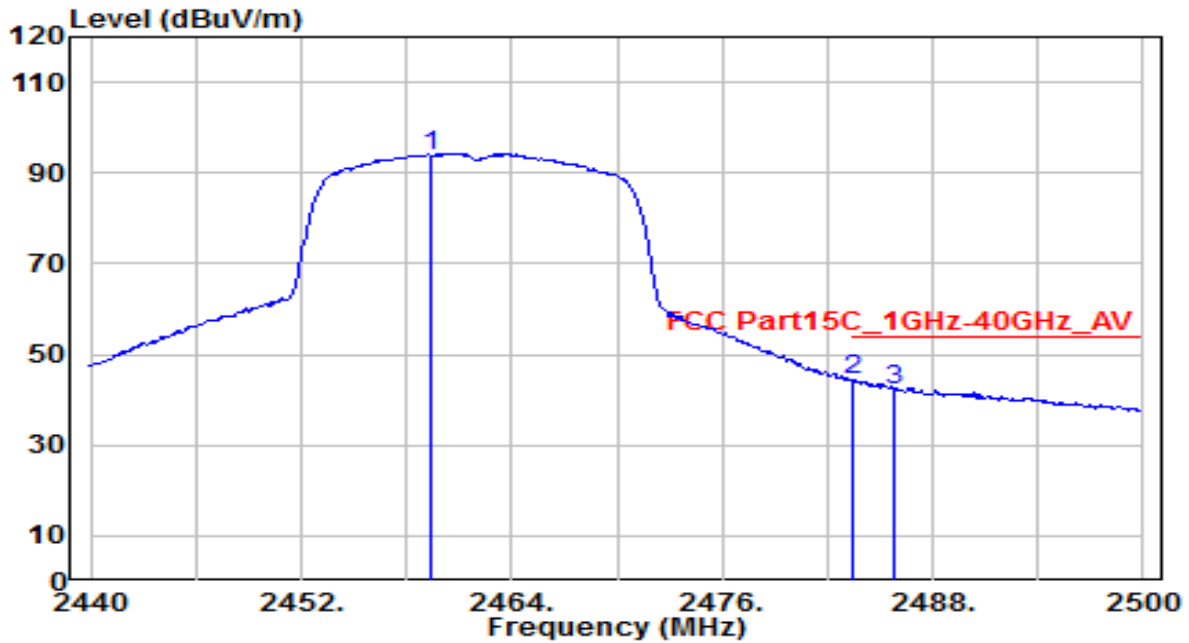

No	Frequency (MHz)	Reading (dBuV)	C.F (dB)	Measurement (dBuV/m)	Margin (dB)	Limit (dBuV/m)	Height (cm)	Angle (deg)	Remark (QP/PK/AV)
1	2459.360	96.32	-2.41	93.92	N/A	N/A	150	120	Average
2	* 2483.500	46.58	-2.30	44.29	-9.71	54.00	150	120	Average
3	2485.840	44.49	-2.29	42.20	-11.80	54.00	150	120	Average

Note:

- "*", means this data is the worst emission level.
- C.F (Correction Factor) = Antenna Factor (dB)+ Cable Loss (dB) – Pre-amplifier(dB).
- Measurement (dBuV/m) = Reading(dBuV) + C.F (Correction Factor).
- The emission levels of other frequencies are very lower than the limit and not show in test report.

EUT	Indoor Camera	Date of Test	2019-11-20
Factor	BBHA 9120D	Temp. / Humidity	24°C /56%
Polarity	Vertical	Site / Test Engineer	AC1 / Jay
Test Mode	802.11n20_TX_CH 11_ANT 0	Test Voltage	AC 110V/60Hz

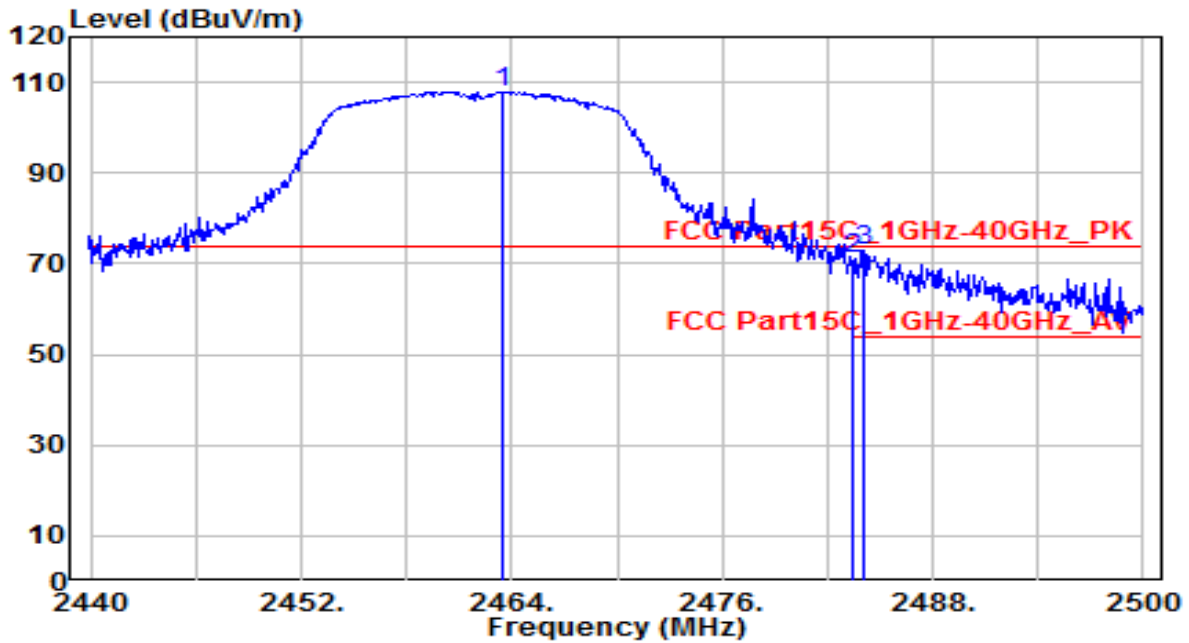

No	Frequency (MHz)	Reading (dBuV)	C.F (dB)	Measurement (dBuV/m)	Margin (dB)	Limit (dBuV/m)	Height (cm)	Angle (deg)	Remark (QP/PK/AV)
1	2463.520	110.32	-2.39	107.93	N/A	N/A	150	240	Peak
2	2483.500	73.50	-2.30	71.21	-2.79	74.00	150	240	Peak
3	* 2484.080	75.24	-2.29	72.95	-1.05	74.00	150	240	Peak

Note:

- "*", means this data is the worst emission level.
- C.F (Correction Factor) = Antenna Factor (dB)+ Cable Loss (dB) – Preamplifier(dB).
- Measurement (dBuV/m) = Reading(dBuV) + C.F (Correction Factor).
- The emission levels of other frequencies are very lower than the limit and not show in test report.

EUT	Indoor Camera	Date of Test	2019-11-20
Factor	BBHA 9120D	Temp. / Humidity	24°C /56%
Polarity	Vertical	Site / Test Engineer	AC1 / Jay
Test Mode	802.11n20_TX_CH 11_ANT 0	Test Voltage	AC 110V/60Hz

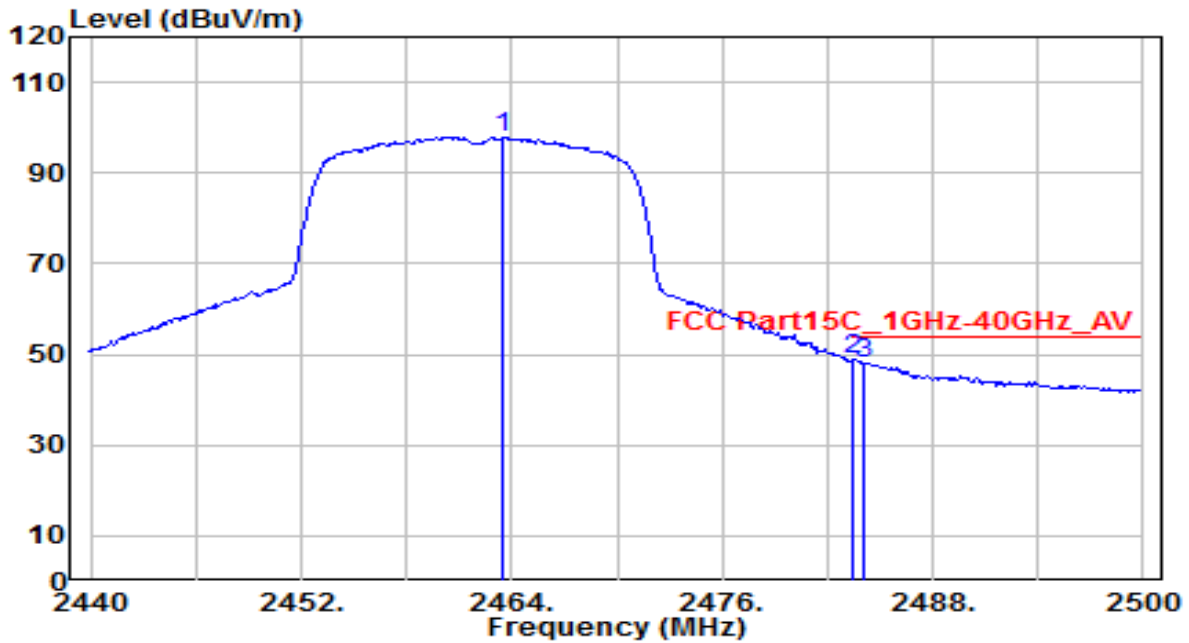

No	Frequency (MHz)	Reading (dBuV)	C.F (dB)	Measurement (dBuV/m)	Margin (dB)	Limit (dBuV/m)	Height (cm)	Angle (deg)	Remark (QP/PK/AV)
1	2463.520	100.13	-2.39	97.74	N/A	N/A	150	240	Average
2	* 2483.500	51.07	-2.30	48.77	-5.23	54.00	150	240	Average
3	2484.080	50.13	-2.29	47.83	-6.17	54.00	150	240	Average

Note:

- "*", means this data is the worst emission level.
- C.F (Correction Factor) = Antenna Factor (dB)+ Cable Loss (dB) – Preamplifier(dB).
- Measurement (dBuV/m) = Reading(dBuV) + C.F (Correction Factor).
- The emission levels of other frequencies are very lower than the limit and not show in test report.

7.8. AC Conducted Emissions Measurement

7.8.1. Test Limit

FCC Part 15 Subpart C Paragraph 15.207 / RSS-Gen Limits		
Frequency (MHz)	QP (dB μ V)	Average (dB μ V)
0.15 - 0.50	66 - 56	56 - 46
0.50 - 5.0	56	46
5.0 - 30	60	50

Note 1: The lower limit shall apply at the transition frequencies.

Note 2: The limit decreases linearly with the logarithm of the frequency in the range 0.15MHz to 0.5MHz.

7.8.2. Test Setup

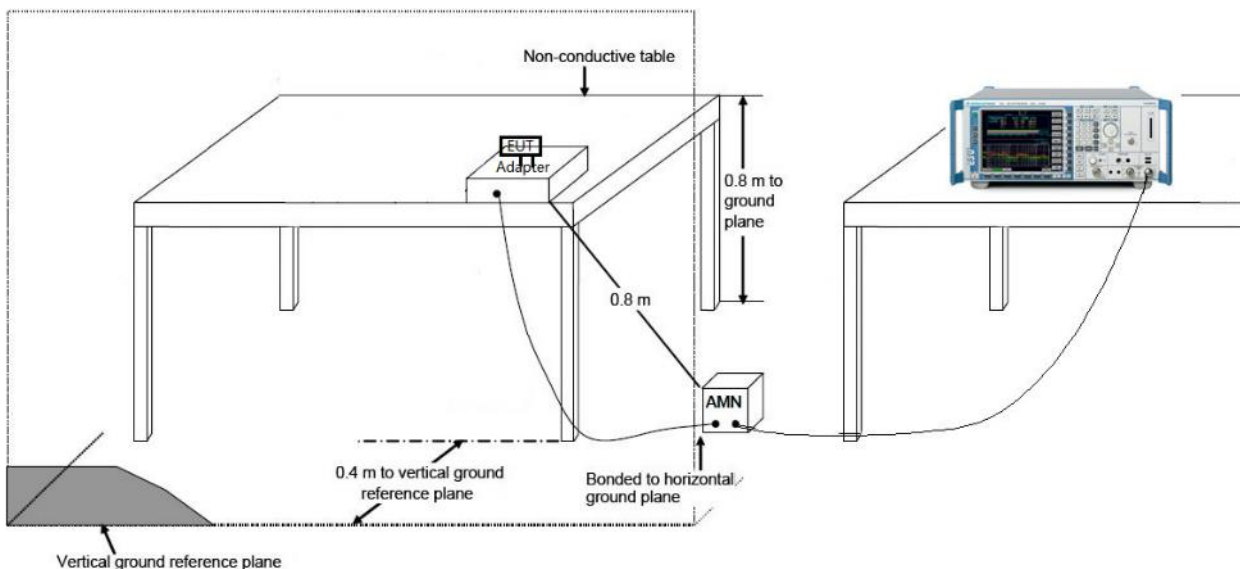

7.8.3. Test Result

EUT	Indoor Camera	Date of Test	2019-11-25
Factor	CE_ENV216-L1 (Filter ON)	Temp. / Humidity	24°C /56%
Polarity	Line1	Site / Test Engineer	SR2 / Fran
Test Mode	802.11n20_TX_CH6_Ant 0_1A52_UB52A	Test Voltage	AC 120V/60Hz

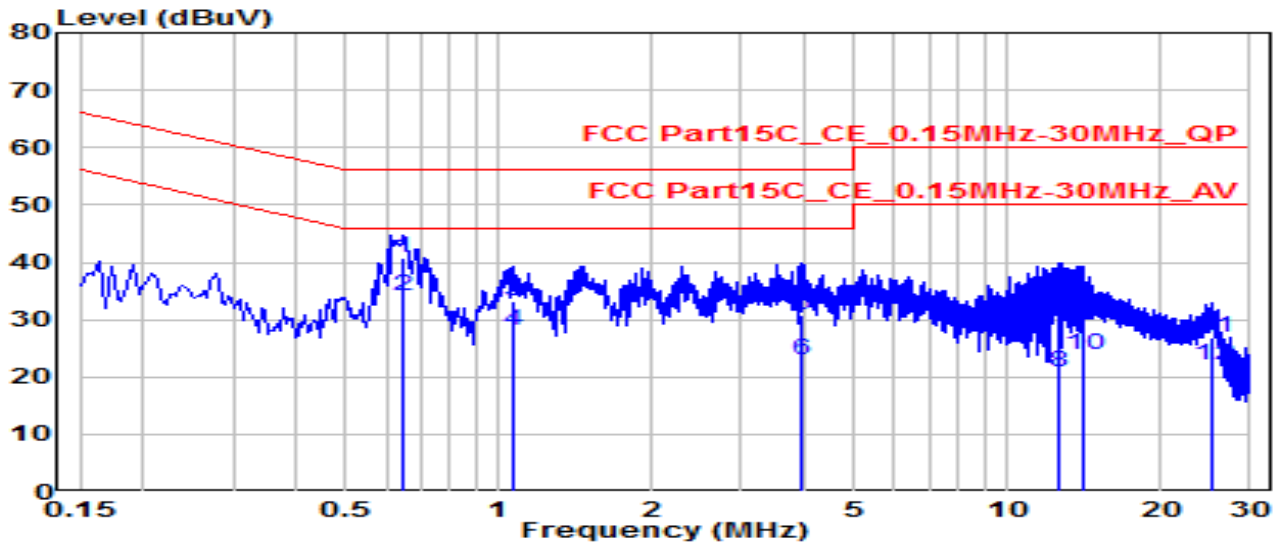

No		Frequency (MHz)	Reading (dBuV)	C.F (dB)	Measurement (dBuV/m)	Margin (dB)	Limit (dBuV/m)	Remark (QP/PK/AV)
1	*	0.649	31.26	9.62	40.88	-15.12	56.00	QP
2	*	0.649	24.42	9.62	34.04	-11.96	46.00	Average
3		1.072	23.57	9.66	33.23	-22.77	56.00	QP
4		1.072	18.49	9.66	28.15	-17.85	46.00	Average
5		3.939	21.02	9.72	30.74	-25.26	56.00	QP
6		3.939	13.22	9.72	22.94	-23.06	46.00	Average
7		12.668	23.12	9.91	33.03	-26.97	60.00	QP
8		12.668	10.91	9.91	20.82	-29.18	50.00	Average
9		14.085	20.62	9.93	30.54	-29.46	60.00	QP
10		14.085	13.90	9.93	23.83	-26.17	50.00	Average
11		25.325	16.78	9.98	26.77	-33.23	60.00	QP
12		25.325	11.91	9.98	21.90	-28.10	50.00	Average

Note:

- "*", means this data is the worst emission level.
- C.F (Correction Factor) = Antenna Factor (dB)+ Cable Loss (dB).
- Measurement (dBuV/m) = Reading(dBuV) + C.F (Correction Factor).

EUT	Indoor Camera	Date of Test	2019-11-25
Factor	CE_ENV216-N (Filter ON)	Temp. / Humidity	24°C /56%
Polarity	Neutral	Site / Test Engineer	SR2 / Fran
Test Mode	802.11n20_TX_CH6_Ant 0_1A52_UB52A	Test Voltage	AC 120V/60Hz

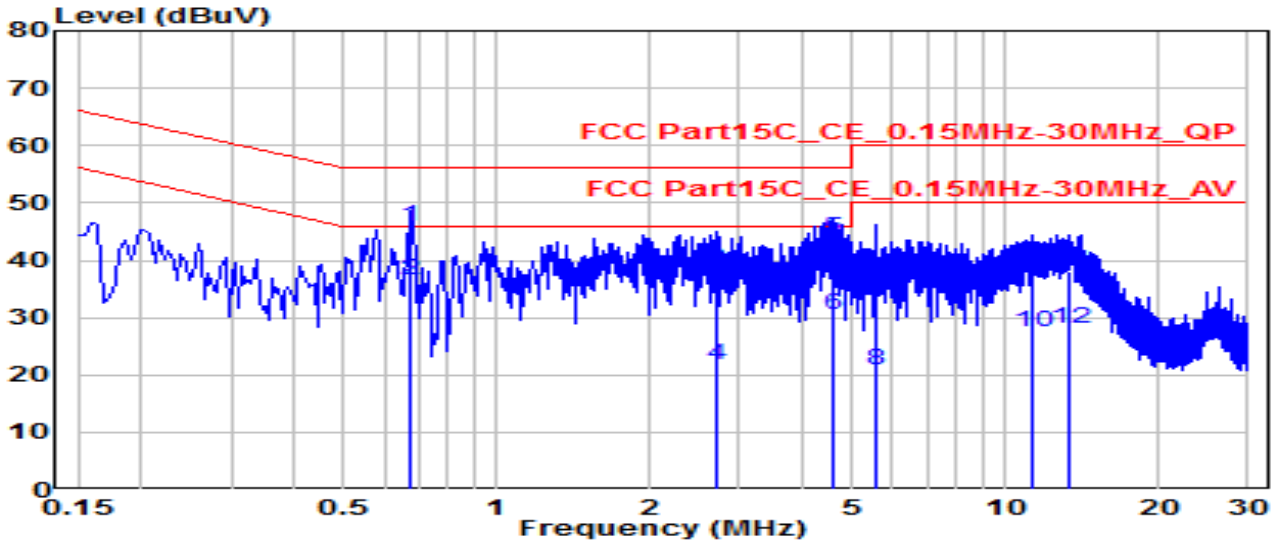

No	Frequency (MHz)	Reading (dBuV)	C.F (dB)	Measurement (dBuV/m)	Margin (dB)	Limit (dBuV/m)	Remark (QP/PK/AV)	
1	*	0.676	36.23	9.63	45.86	-10.14	56.00	QP
2	*	0.676	26.99	9.63	36.62	-9.38	46.00	Average
3		2.706	28.51	9.70	38.20	-17.80	56.00	QP
4		2.706	12.12	9.70	21.81	-24.19	46.00	Average
5		4.614	33.94	9.72	43.67	-12.33	56.00	QP
6		4.614	20.80	9.72	30.52	-15.48	46.00	Average
7		5.567	23.01	9.75	32.76	-27.24	60.00	QP
8		5.567	11.22	9.75	20.97	-29.03	50.00	Average
9		11.327	29.56	9.91	39.47	-20.53	60.00	QP
10		11.327	17.59	9.91	27.50	-22.50	50.00	Average
11		13.388	27.98	9.94	37.92	-22.08	60.00	QP
12		13.388	18.04	9.94	27.99	-22.01	50.00	Average

Note:

- " *", means this data is the worst emission level.
- C.F (Correction Factor) = Antenna Factor (dB)+ Cable Loss (dB).
- Measurement (dBuV/m) = Reading(dBuV) + C.F (Correction Factor).

EUT	Indoor Camera	Date of Test	2019-11-25
Factor	CE_ENV216-L1 (Filter ON)	Temp. / Humidity	24°C /56%
Polarity	Line1	Site / Test Engineer	SR2 / Fran
Test Mode	802.11n20_TX_CH6_Ant 0_PSAF10A-050Q	Test Voltage	AC 120V/60Hz

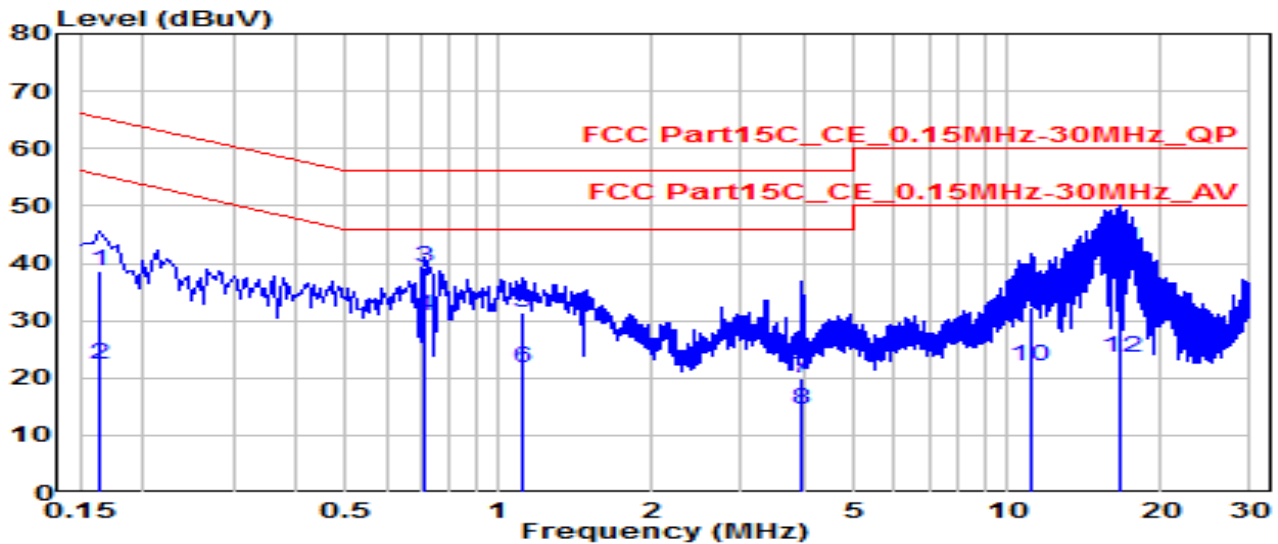

No	Frequency (MHz)	Reading (dBuV)	C.F (dB)	Measurement (dBuV/m)	Margin (dB)	Limit (dBuV/m)	Remark (QP/PK/AV)
1	0.163	29.10	9.59	38.69	-26.60	65.28	QP
2	0.163	12.90	9.59	22.49	-32.80	55.28	Average
3	* 0.712	29.70	9.63	39.33	-16.67	56.00	QP
4	* 0.712	21.30	9.63	30.93	-15.07	46.00	Average
5	1.113	21.66	9.66	31.32	-24.68	56.00	QP
6	1.113	12.07	9.66	21.73	-24.27	46.00	Average
7	3.952	10.17	9.72	19.90	-36.10	56.00	QP
8	3.952	4.79	9.72	14.51	-31.49	46.00	Average
9	11.070	22.33	9.88	32.21	-27.79	60.00	QP
10	11.070	12.25	9.88	22.13	-27.87	50.00	Average
11	16.731	32.71	9.95	42.66	-17.34	60.00	QP
12	16.731	13.50	9.95	23.45	-26.55	50.00	Average

Note:

- " *", means this data is the worst emission level.
- C.F (Correction Factor) = Antenna Factor (dB)+ Cable Loss (dB).
- Measurement (dBuV/m) = Reading(dBuV) + C.F (Correction Factor).

EUT	Indoor Camera	Date of Test	2019-11-25
Factor	CE_ENV216-N (Filter ON)	Temp. / Humidity	24°C /56%
Polarity	Neutral	Site / Test Engineer	SR2 / Fran
Test Mode	802.11n20_TX_CH6_Ant 0_PSAF10A-050Q	Test Voltage	AC 120V/60Hz

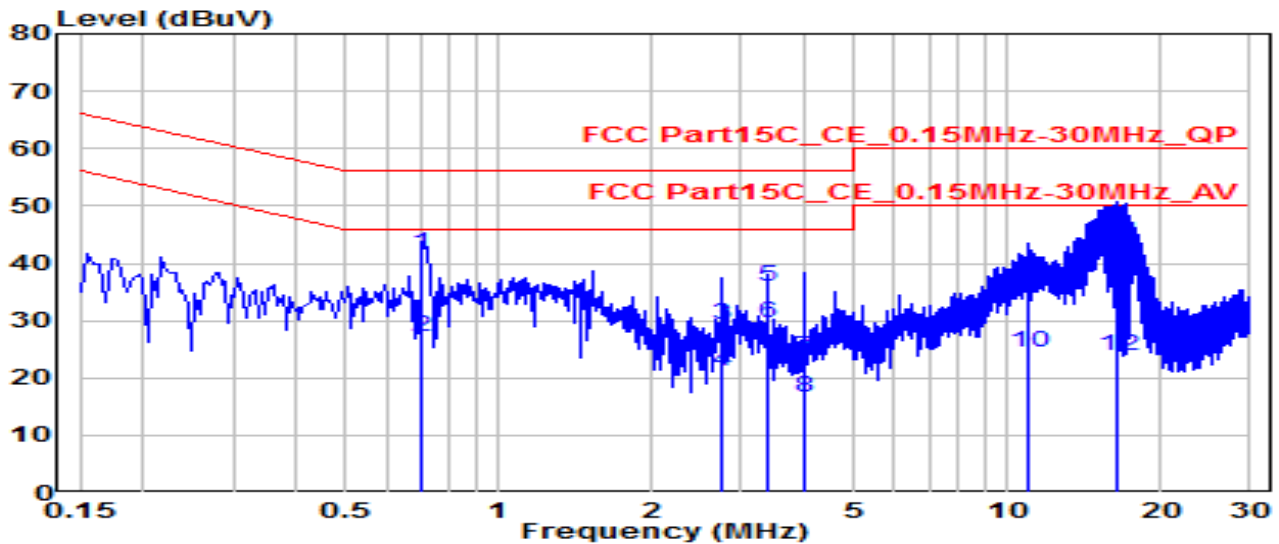

No	Frequency (MHz)	Reading (dBuV)	C.F (dB)	Measurement (dBuV/m)	Margin (dB)	Limit (dBuV/m)	Remark (QP/PK/AV)	
1	*	0.708	31.98	9.63	41.61	-14.39	56.00	QP
2		0.708	17.40	9.63	27.03	-18.97	46.00	Average
3		2.755	19.69	9.70	29.38	-26.62	56.00	QP
4		2.755	11.31	9.70	21.00	-25.00	46.00	Average
5		3.372	26.13	9.71	35.84	-20.16	56.00	QP
6	*	3.372	19.83	9.71	29.54	-16.46	46.00	Average
7		3.979	13.86	9.71	23.58	-32.42	56.00	QP
8		3.979	6.90	9.71	16.61	-29.39	46.00	Average
9		10.962	26.11	9.91	36.01	-23.99	60.00	QP
10		10.962	14.48	9.91	24.39	-25.61	50.00	Average
11		16.488	33.57	9.99	43.56	-16.44	60.00	QP
12		16.488	13.76	9.99	23.76	-26.24	50.00	Average

Note:

- "*", means this data is the worst emission level.
- C.F (Correction Factor) = Antenna Factor (dB)+ Cable Loss (dB).
- Measurement (dBuV/m) = Reading(dBuV) + C.F (Correction Factor).

8. CONCLUSION

The data collected relate only the item(s) tested and show that the **Indoor Camera** is compliance with Part 15C of the FCC Rules.

Appendix A - Test Photograph

Refer to "1911RSU014-UT" file.

Appendix B - External Photograph

Refer to “1911RSU014-UE” file.