

FCC Test Report

FCC ID : P27RP582B
Equipment : WiFi 6 Tri-Band Router
Model No. : RP582B
Brand Name : Sercomm
Applicant : Sercomm Corporation
Address : 8F, No. 3-1, YuanQu St., NanKang, Taipei 115,
Taiwan, R.O.C.
Standard : 47 CFR FCC Part 15.247
Received Date : Jan. 11, 2022
Tested Date : Jan. 25 ~ Feb. 11, 2022

We, International Certification Corporation, would like to declare that the tested sample has been evaluated and in compliance with the requirement of the above standards. The test results contained in this report refer exclusively to the product. It shall not be reproduced except in full without the written approval of our laboratory.

Reviewed by:

Approved by:



Along Chen / Assistant Manager



Gary Chang / Manager

Table of Contents

1	GENERAL DESCRIPTION	5
1.1	Information.....	5
1.2	Local Support Equipment List	7
1.3	Test Setup Chart	7
1.4	Test Equipment List and Calibration Data.....	8
1.5	Test Standards	9
1.6	Reference Guidance	9
1.7	Deviation from Test Standard and Measurement Procedure.....	9
1.8	Measurement Uncertainty	9
2	TEST CONFIGURATION.....	10
2.1	Testing Facility	10
2.2	The Worst Test Modes and Channel Details	10
3	TRANSMITTER TEST RESULTS	11
3.1	Conducted Emissions.....	11
3.2	6dB and Occupied Bandwidth.....	14
3.3	RF Output Power.....	22
3.4	Power Spectral Density	25
3.5	Emissions in Restricted Frequency Bands.....	33
3.6	Emissions in non-restricted Frequency Bands.....	49
4	TEST LABORATORY INFORMATION	56

Release Record

Report No.	Version	Description	Issued Date
FR211102AE	Rev. 01	Initial issue	Mar. 11, 2022

Summary of Test Results

FCC Rules	Test Items	Measured	Result
15.207	AC Power Line Conducted Emissions	[dBuV]: 0.348MHz 43.24 (Margin -5.76dB) - AV	Pass
15.247(d) 15.209	Radiated Emissions	[dBuV/m at 3m]: 2483.50MHz 50.78 (Margin -3.22dB) - AV	Pass
15.247(b)(3)	Maximum Output Power	Power [dBm]: 12.40	Pass
15.247(a)(2)	6dB Bandwidth	Meet the requirement of limit	Pass
15.247(e)	Power Spectral Density	Meet the requirement of limit	Pass
15.203	Antenna Requirement	Meet the requirement of limit	Pass

Declaration of Conformity:

The test results with all measurement uncertainty excluded are presented in accordance with the regulation limits or requirements declared by manufacturers.

Comments and Explanations:

The declared of product specification for EUT presented in the report are provided by the manufacturer, and the manufacturer takes all the responsibilities for the accuracy of product specification.

1 General Description

1.1 Information

1.1.1 Specification of the Equipment under Test (EUT)

RF General Information				
Frequency Range (MHz)	Bluetooth Mode	Ch. Freq. (MHz)	Channel Number	Data Rate
2400-2483.5	V5.1 LE	2402-2480	0-39 [40]	125 kbps
				500 kbps
				1 Mbps
				2 Mbps

Note: Bluetooth LE (Low energy) uses GFSK modulation.

1.1.2 Antenna Details

Ant. No.	Type	Connector	Gain (dBi)	Remarks
1	Dipole	UFL	4.2	---

1.1.3 Power Supply Type of Equipment under Test (EUT)

Power Supply Type	12Vdc from adapter
--------------------------	--------------------

1.1.4 Accessories

Accessories		
No.	Equipment	Description
1	AC adapter	Brand: Leader Model: MU24D1120200-A1 Power Rating: I/P: 100-240Vac, 50/60Hz, 0.7A O/P: 12Vdc, 2.0A Line: 1.45m non-shielded w/o core.
2	AC adapter	Brand: Acbel Model: WAM003 ID:GMAG Power Rating: I/P: 100-240Vac, 50/60Hz, 0.7A. O/P: 12Vdc, 2.0A, 24W Line: 1.45m non-shielded w/o core.

1.1.5 Channel List

Frequency band (MHz)				2400~2483.5			
Channel	Frequency (MHz)	Channel	Frequency (MHz)	Channel	Frequency (MHz)	Channel	Frequency (MHz)
37	2402	9	2422	18	2442	28	2462
0	2404	10	2424	19	2444	29	2464
1	2406	38	2426	20	2446	30	2466
2	2408	11	2428	21	2448	31	2468
3	2410	12	2430	22	2450	32	2470
4	2412	13	2432	23	2452	33	2472
5	2414	14	2434	24	2454	34	2474
6	2416	15	2436	25	2456	35	2476
7	2418	16	2438	26	2458	36	2478
8	2420	17	2440	27	2460	39	2480

1.1.6 Test Tool and Duty Cycle

Test Tool	Putty, Version: V0.60	
Modulation Mode	Duty Cycle Of Test Signal (%)	Duty Factor (dB)
BT-LE(125kbps)	98.63%	0.06
BT-LE(500kbps)	92.63%	0.33
BT-LE(1Mbps)	87.45%	0.58
BT-LE(2Mbps)	59.46%	2.26

1.1.7 Power Index of Test Tool

Modulation Mode	Test Frequency (MHz)		
	2402	2440	2480
BT-LE(125kbps)	100	100	100
BT-LE(500kbps)	100	100	100
BT-LE(1Mbps)	100	100	100
BT-LE(2Mbps)	100	100	100

1.2 Local Support Equipment List

Support Equipment List					
No.	Equipment	Brand	Model	FCC ID	Remarks
1	Notebook	DELL	Latitude 5400	---	---
2	Notebook	DELL	Latitude E6440	---	---

1.3 Test Setup Chart

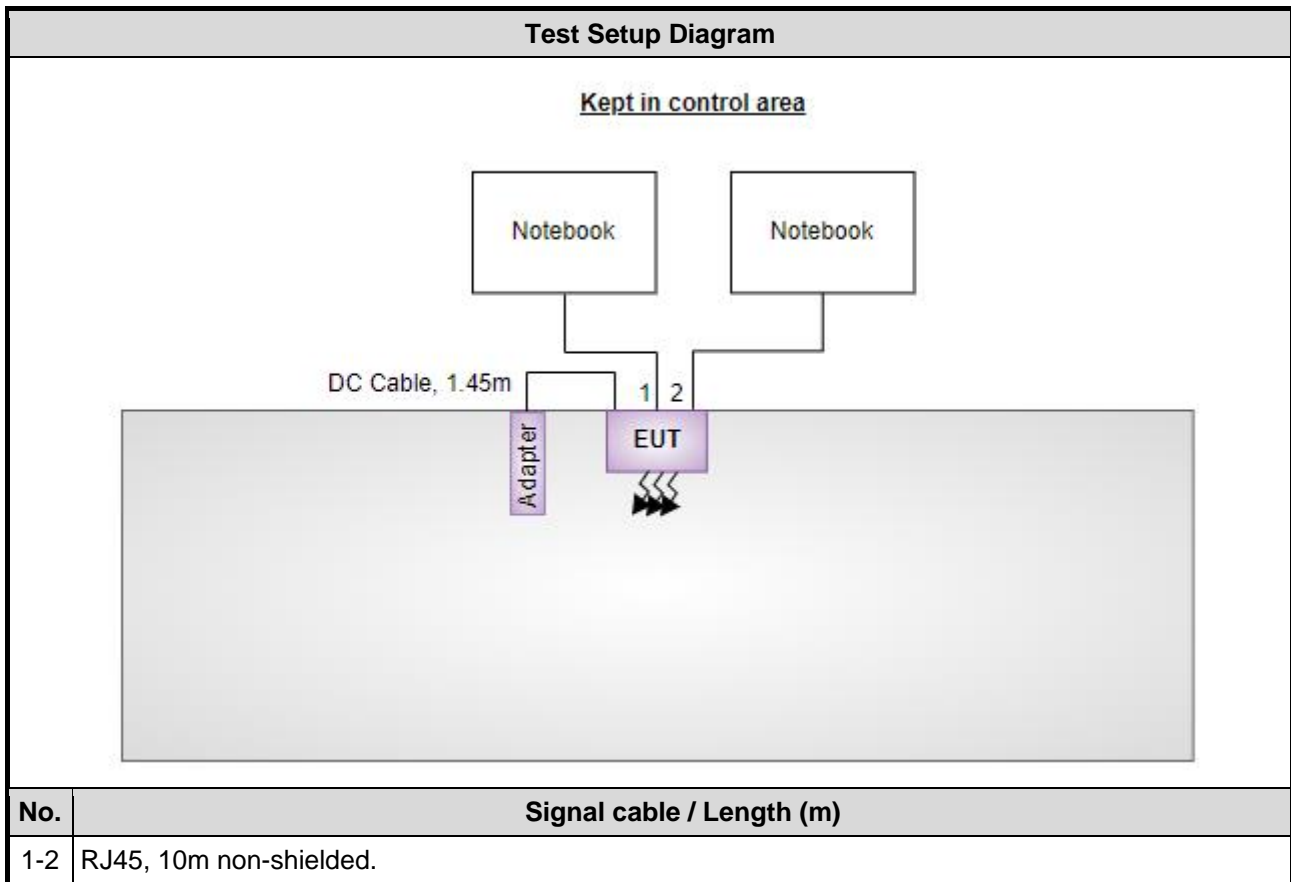

1.4 Test Equipment List and Calibration Data

Test Item	Conducted Emission				
Test Site	Conduction room 1 / (CO01-WS)				
Tested Date	Feb. 07, 2022				
Instrument	Brand	Model No.	Serial No.	Calibration Date	Calibration Until
Receiver	R&S	ESR3	101657	Mar. 12, 2021	Mar. 11, 2022
LISN	R&S	ENV216	101579	Mar. 17, 2021	Mar. 16, 2022
LISN (Support Unit)	SCHWARZBECK MESS-ELEKTRONIK	NSLK 8127	8127477	Feb. 25, 2021	Feb. 24, 2022
RF Cable-CON	Woken	CFD200-NL	CFD200-NL-001	Oct. 19, 2021	Oct. 18, 2022
50 ohm terminal (Support Unit)	NA	50	04	May 25, 2021	May 24, 2022
Measurement Software	AUDIX	e3	6.120210k	NA	NA

Note: Calibration Interval of instruments listed above is one year.

Test Item	Radiated Emission				
Test Site	966 chamber1 / (03CH01-WS)				
Tested Date	Jan. 25 ~ Feb. 08, 2022				
Instrument	Brand	Model No.	Serial No.	Calibration Date	Calibration Until
Receiver	R&S	ESR3	101657	Mar. 12, 2021	Mar. 11, 2022
Spectrum Analyzer	R&S	FSV40	101498	Nov. 29, 2021	Nov. 28, 2022
Loop Antenna	R&S	HFH2-Z2	100330	Nov. 08, 2021	Nov. 07, 2022
Bilog Antenna	SCHWARZBECK	VULB9168	VULB9168-522	Jun. 30, 2021	Jun. 29, 2022
Horn Antenna 1G-18G	SCHWARZBECK	BBHA 9120 D	BBHA 9120 D 1096	Dec. 03, 2021	Dec. 02, 2022
Horn Antenna 18G-40G	SCHWARZBECK	BBHA 9170	BBHA 9170508	Jan. 11, 2022	Jan. 10, 2023
Preamplifier	EMC	EMC02325	980225	Jun. 29, 2021	Jun. 28, 2022
Preamplifier	Agilent	83017A	MY39501308	Sep. 28, 2021	Sep. 27, 2022
Preamplifier	EMC	EMC184045B	980192	Jul. 14, 2021	Jul. 13, 2022
Loop Antenna Cable	KOAX KABEL	101354-BW	101354-BW	Oct. 05, 2021	Oct. 04, 2022
LF cable 3M	Woken	CFD400NL-LW	CFD400NL-001	Oct. 05, 2021	Oct. 04, 2022
LF cable 11M	EMC	EMCCFD400-NW-N W-11000	200801	Oct. 05, 2021	Oct. 04, 2022
LF cable 1M	EMC	EMCCFD400-NM-N M-1000	160502	Oct. 05, 2021	Oct. 04, 2022
RF Cable	EMC	EMC104-35M-35M- 8000	210920	Oct. 05, 2021	Oct. 04, 2022
RF Cable	HUBER+SUHNER	SUCOFLEX104	MY16019/4	Oct. 05, 2021	Oct. 04, 2022
Measurement Software	AUDIX	e3	6.120210g	NA	NA

Note: Calibration Interval of instruments listed above is one year.

Test Item	RF Conducted				
Test Site	(TH01-WS)				
Tested Date	Feb. 11, 2022				
Instrument	Brand	Model No.	Serial No.	Calibration Date	Calibration Until
Spectrum Analyzer	R&S	FSV40	101498	Nov. 29, 2021	Nov. 28, 2022
Power Meter	Anritsu	ML2495A	1241002	Nov. 07, 2021	Nov. 06, 2022
Power Sensor	Anritsu	MA2411B	1207366	Nov. 07, 2021	Nov. 06, 2022
Measurement Software	Sporton	SENSE-15247_DTS	V5.10	NA	NA
Note: Calibration Interval of instruments listed above is one year.					

1.5 Test Standards

47 CFR FCC Part 15.247
ANSI C63.10-2013

1.6 Reference Guidance

FCC KDB 558074 D01 15.247 Meas Guidance v05r02

1.7 Deviation from Test Standard and Measurement Procedure

None

1.8 Measurement Uncertainty

The measurement uncertainties given below are based on a 95% confidence level (based on a coverage factor ($k=2$)).

Measurement Uncertainty	
Parameters	Uncertainty
Bandwidth	± 34.130 Hz
Conducted power	± 0.808 dB
Power density	± 0.583 dB
Conducted emission	± 2.715 dB
AC conducted emission	± 2.92 dB
Radiated emission ≤ 1 GHz	± 3.41 dB
Radiated emission > 1 GHz	± 4.59 dB

2 Test Configuration

2.1 Testing Facility

Test Laboratory	International Certification Corporation
Test Site	CO01-WS, 03CH01-WS, TH01-WS
Address of Test Site	No.3-1, Lane 6, Wen San 3rd St., Kwei Shan Dist., Tao Yuan City 33381, Taiwan (R.O.C.)

- FCC Designation No.: TW2732
- FCC site registration No.: 181692
- ISED#: 10807A
- CAB identifier: TW2732

2.2 The Worst Test Modes and Channel Details

Test item	Mode	Test Frequency (MHz)	Test Configuration
AC Power Line Conducted Emissions Radiated Emissions \leq 1GHz	BT-LE(1Mbps)	2480	---
Maximum Output Power 6dB bandwidth Power spectral density	BT-LE(125kbps) BT-LE(500kbps) BT-LE(1Mbps) BT-LE(2Mbps)	2402, 2440, 2480	---
Radiated Emissions > 1GHz	BT-LE(1Mbps) BT-LE(2Mbps)	2402, 2440, 2480 2402, 2440, 2480	---

Note: Two adapters (Leader and Acbel) had been covered during the pretest, and found that Leader was the worst case and was selected for final test.

3 Transmitter Test Results

3.1 Conducted Emissions

3.1.1 Limit of Conducted Emissions

Conducted Emissions Limit		
Frequency Emission (MHz)	Quasi-Peak	Average
0.15-0.5	66 - 56 *	56 - 46 *
0.5-5	56	46
5-30	60	50

Note 1: * Decreases with the logarithm of the frequency.

3.1.2 Test Procedures

1. The device is placed on a test table, raised 80 cm above the reference ground plane. The vertical conducting plane is located 40 cm to the rear of the device.
2. The device is connected to line impedance stabilization network (LISN) and other accessories are connected to other LISN. Measured levels of AC power line conducted emission are across the 50 Ω LISN port.
3. AC conducted emission measurements is made over frequency range from 150 kHz to 30 MHz.
4. This measurement was performed with AC 120V/60Hz

3.1.3 Test Setup



- Note: 1. Support units were connected to second LISN.
 2. Both of LISNs (AMN) are 80 cm from EUT and at least 80 cm from other units and other metal planes

3.1.4 Test Result of Conducted Emissions

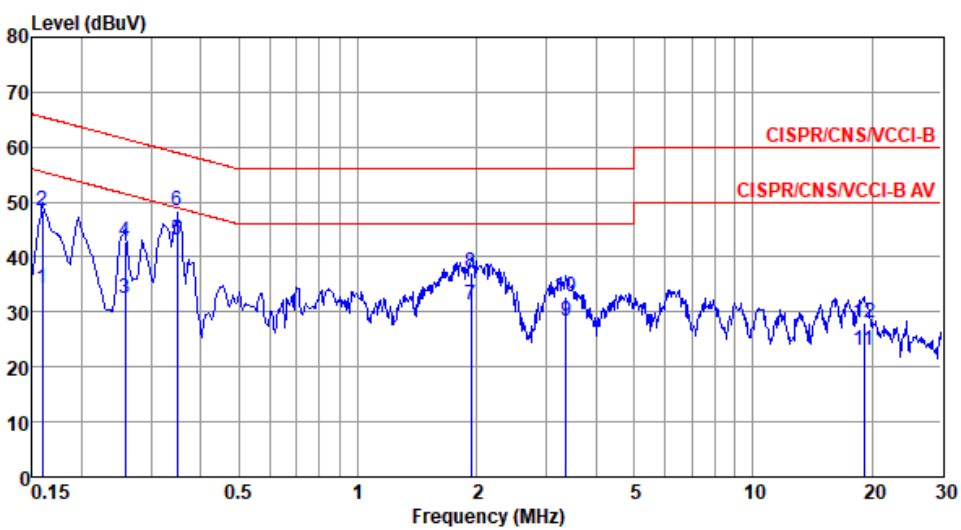
Modulation	BT-LE(1Mbps)	Test Freq. (MHz)	2480																																																																																																																																		
Power Phase	Line																																																																																																																																				
<p>Test by : Joe Liao Temperature: 18°C Humidity: 60%</p>																																																																																																																																					
																																																																																																																																					
<table border="1"> <thead> <tr> <th></th> <th>Freq MHz</th> <th>Level dBuA</th> <th>Limit Line dBuA</th> <th>Over Limit dB</th> <th>Read Level dBuA</th> <th>Factor dB</th> <th>Cable loss dB</th> <th>Aux dB</th> <th>Remark</th> </tr> </thead> <tbody> <tr><td>1</td><td>0.159</td><td>34.29</td><td>55.52</td><td>-21.23</td><td>24.35</td><td>9.66</td><td>0.08</td><td>0.20</td><td>Average</td></tr> <tr><td>2</td><td>0.159</td><td>48.53</td><td>65.52</td><td>-16.99</td><td>38.59</td><td>9.66</td><td>0.08</td><td>0.20</td><td>QP</td></tr> <tr><td>3</td><td>0.258</td><td>32.48</td><td>51.51</td><td>-19.03</td><td>22.48</td><td>9.65</td><td>0.08</td><td>0.27</td><td>Average</td></tr> <tr><td>4</td><td>0.258</td><td>42.85</td><td>61.51</td><td>-18.66</td><td>32.85</td><td>9.65</td><td>0.08</td><td>0.27</td><td>QP</td></tr> <tr><td>5*</td><td>0.348</td><td>43.24</td><td>49.00</td><td>-5.76</td><td>33.19</td><td>9.64</td><td>0.08</td><td>0.33</td><td>Average</td></tr> <tr><td>6</td><td>0.348</td><td>48.28</td><td>59.00</td><td>-10.72</td><td>38.23</td><td>9.64</td><td>0.08</td><td>0.33</td><td>QP</td></tr> <tr><td>7</td><td>1.939</td><td>31.26</td><td>46.00</td><td>-14.74</td><td>21.01</td><td>9.66</td><td>0.20</td><td>0.39</td><td>Average</td></tr> <tr><td>8</td><td>1.939</td><td>37.25</td><td>56.00</td><td>-18.75</td><td>27.00</td><td>9.66</td><td>0.20</td><td>0.39</td><td>QP</td></tr> <tr><td>9</td><td>3.364</td><td>28.35</td><td>46.00</td><td>-17.65</td><td>18.06</td><td>9.67</td><td>0.21</td><td>0.41</td><td>Average</td></tr> <tr><td>10</td><td>3.364</td><td>32.89</td><td>56.00</td><td>-23.11</td><td>22.60</td><td>9.67</td><td>0.21</td><td>0.41</td><td>QP</td></tr> <tr><td>11</td><td>19.122</td><td>22.97</td><td>50.00</td><td>-27.03</td><td>12.02</td><td>9.68</td><td>0.64</td><td>0.63</td><td>Average</td></tr> <tr><td>12</td><td>19.122</td><td>28.19</td><td>60.00</td><td>-31.81</td><td>17.24</td><td>9.68</td><td>0.64</td><td>0.63</td><td>QP</td></tr> </tbody> </table>					Freq MHz	Level dBuA	Limit Line dBuA	Over Limit dB	Read Level dBuA	Factor dB	Cable loss dB	Aux dB	Remark	1	0.159	34.29	55.52	-21.23	24.35	9.66	0.08	0.20	Average	2	0.159	48.53	65.52	-16.99	38.59	9.66	0.08	0.20	QP	3	0.258	32.48	51.51	-19.03	22.48	9.65	0.08	0.27	Average	4	0.258	42.85	61.51	-18.66	32.85	9.65	0.08	0.27	QP	5*	0.348	43.24	49.00	-5.76	33.19	9.64	0.08	0.33	Average	6	0.348	48.28	59.00	-10.72	38.23	9.64	0.08	0.33	QP	7	1.939	31.26	46.00	-14.74	21.01	9.66	0.20	0.39	Average	8	1.939	37.25	56.00	-18.75	27.00	9.66	0.20	0.39	QP	9	3.364	28.35	46.00	-17.65	18.06	9.67	0.21	0.41	Average	10	3.364	32.89	56.00	-23.11	22.60	9.67	0.21	0.41	QP	11	19.122	22.97	50.00	-27.03	12.02	9.68	0.64	0.63	Average	12	19.122	28.19	60.00	-31.81	17.24	9.68	0.64	0.63	QP
	Freq MHz	Level dBuA	Limit Line dBuA	Over Limit dB	Read Level dBuA	Factor dB	Cable loss dB	Aux dB	Remark																																																																																																																												
1	0.159	34.29	55.52	-21.23	24.35	9.66	0.08	0.20	Average																																																																																																																												
2	0.159	48.53	65.52	-16.99	38.59	9.66	0.08	0.20	QP																																																																																																																												
3	0.258	32.48	51.51	-19.03	22.48	9.65	0.08	0.27	Average																																																																																																																												
4	0.258	42.85	61.51	-18.66	32.85	9.65	0.08	0.27	QP																																																																																																																												
5*	0.348	43.24	49.00	-5.76	33.19	9.64	0.08	0.33	Average																																																																																																																												
6	0.348	48.28	59.00	-10.72	38.23	9.64	0.08	0.33	QP																																																																																																																												
7	1.939	31.26	46.00	-14.74	21.01	9.66	0.20	0.39	Average																																																																																																																												
8	1.939	37.25	56.00	-18.75	27.00	9.66	0.20	0.39	QP																																																																																																																												
9	3.364	28.35	46.00	-17.65	18.06	9.67	0.21	0.41	Average																																																																																																																												
10	3.364	32.89	56.00	-23.11	22.60	9.67	0.21	0.41	QP																																																																																																																												
11	19.122	22.97	50.00	-27.03	12.02	9.68	0.64	0.63	Average																																																																																																																												
12	19.122	28.19	60.00	-31.81	17.24	9.68	0.64	0.63	QP																																																																																																																												
<p>Note 1: Level (dBuV) = Read Level (dBuV) + LISN Factor (dB) + Cable Loss (dB) + Aux (dB). 2: Over Limit (dB) = Level (dBuV) – Limit Line (dBuV).</p>																																																																																																																																					

Modulation	BT-LE(1Mbps)	Test Freq. (MHz)	2480
Power Phase	Neutral		

Test by : Joe Liao Temperature: 18°C Humidity: 60%

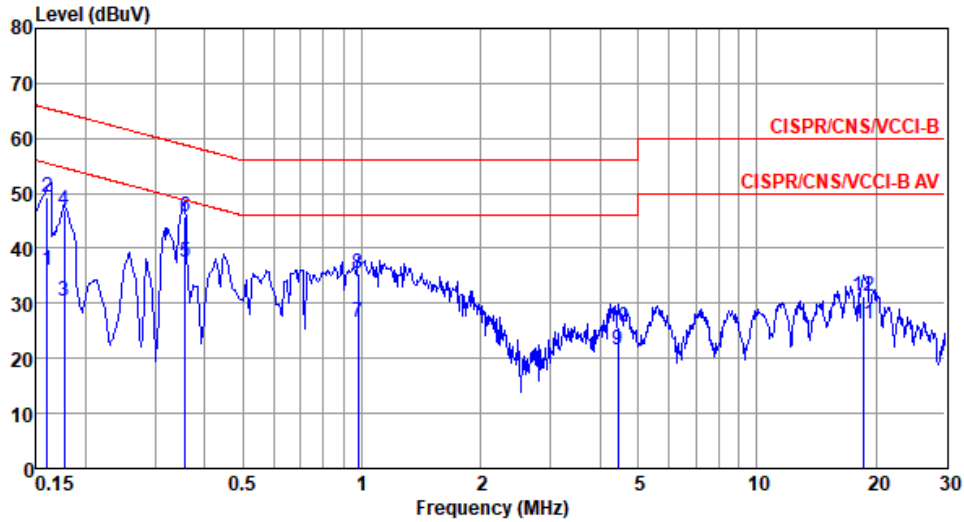

	Freq MHz	Level dBuA	Limit Line dBuA	Over Limit dB	Read Level dBuA	Factor dB	Cable loss dB	Aux dB	Remark
1	0.160	36.05	55.47	-19.42	26.12	9.69	0.08	0.16	Average
2	0.160	49.33	65.47	-16.14	39.40	9.69	0.08	0.16	QP
3	0.177	30.44	54.64	-24.20	20.51	9.68	0.08	0.17	Average
4	0.177	46.94	64.64	-17.70	37.01	9.68	0.08	0.17	QP
5*	0.358	37.61	48.78	-11.17	27.67	9.67	0.08	0.19	Average
6	0.358	45.75	58.78	-13.03	35.81	9.67	0.08	0.19	QP
7	0.979	26.53	46.00	-19.47	16.41	9.68	0.16	0.28	Average
8	0.979	35.49	56.00	-20.51	25.37	9.68	0.16	0.28	QP
9	4.454	21.55	46.00	-24.45	11.27	9.71	0.24	0.33	Average
10	4.454	25.64	56.00	-30.36	15.36	9.71	0.24	0.33	QP
11	18.622	26.23	50.00	-23.77	15.31	9.83	0.63	0.46	Average
12	18.622	31.44	60.00	-28.56	20.52	9.83	0.63	0.46	QP

Note 1: Level (dBuV) = Read Level (dBuV) + LISN Factor (dB) + Cable Loss (dB) + Aux (dB).
 2: Over Limit (dB) = Level (dBuV) – Limit Line (dBuV).

3.2 6dB and Occupied Bandwidth

3.2.1 Limit of 6dB Bandwidth

The minimum 6dB bandwidth shall be at least 500 kHz.

3.2.2 Test Procedures

6dB Bandwidth

1. Set resolution bandwidth (RBW) = 100 kHz, Video bandwidth = 300 kHz.
2. Detector = Peak, Trace mode = max hold.
3. Sweep = auto couple, Allow the trace to stabilize.
4. Measure the maximum width of the emission that is constrained by the frequencies associated with the two outermost amplitude points (upper and lower) that are attenuated by 6dB relative to the maximum level measured in the fundamental emission.

Occupied Bandwidth

1. Set resolution bandwidth (RBW) = 1% ~ 5 % of OBW, Video bandwidth = 3 x RBW.
2. Detector = Sample, Trace mode = max hold.
3. Sweep = auto couple, Allow the trace to stabilize.
4. Use the OBW measurement function of spectrum analyzer to measure the occupied bandwidth.

3.2.3 Test Setup

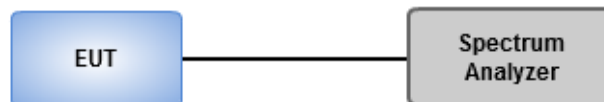

3.2.4 Test Result of 6dB and Occupied Bandwidth

Ambient Condition	20°C / 65%	Tested By	Aska Huang
--------------------------	------------	------------------	------------

Summary

Mode	Max-N dB (Hz)	Max-OBW (Hz)	ITU-Code	Min-N dB (Hz)	Min-OBW (Hz)
2.4-2.4835GHz	-	-	-	-	-
BT-LE(125kbps)	652.174k	1.06M	1M06F1D	612.319k	1.056M
BT-LE(500kbps)	663.043k	1.027M	1M03F1D	652.174k	1.02M
BT-LE(1Mbps)	663.043k	1.031M	1M03F1D	652.174k	1.027M
BT-LE(2Mbps)	1.145M	2.062M	2M06F1D	1.138M	2.055M

Max-N dB = Maximum 6dB down bandwidth; Max-OBW = Maximum 99% occupied bandwidth;
Min-N dB = Minimum 6dB down bandwidth; Min-OBW = Minimum 99% occupied bandwidth

Result

Mode	Result	Limit (Hz)	Port 1-N dB (Hz)	Port 1-OBW (Hz)
BT-LE(125kbps)	-	-	-	-
2402MHz	Pass	500k	652.174k	1.06M
2440MHz	Pass	500k	612.319k	1.056M
2480MHz	Pass	500k	612.319k	1.06M
BT-LE(500kbps)	-	-	-	-
2402MHz	Pass	500k	663.043k	1.027M
2440MHz	Pass	500k	655.797k	1.02M
2480MHz	Pass	500k	652.174k	1.024M
BT-LE(1Mbps)	-	-	-	-
2402MHz	Pass	500k	652.174k	1.031M
2440MHz	Pass	500k	655.797k	1.027M
2480MHz	Pass	500k	663.043k	1.027M
BT-LE(2Mbps)	-	-	-	-
2402MHz	Pass	500k	1.145M	2.055M
2440MHz	Pass	500k	1.145M	2.062M
2480MHz	Pass	500k	1.138M	2.055M

Port X-N dB = Port X 6dB down bandwidth;
Port X-OBW = Port X 99% occupied bandwidth

BT-LE(125kbps)

EBW-DTS

2402MHz

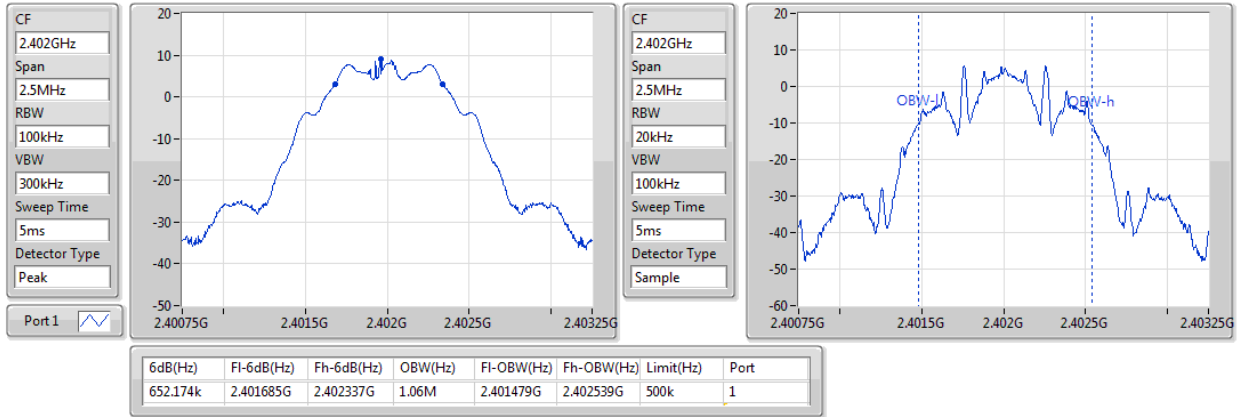

BT-LE(125kbps)

EBW-DTS

2440MHz

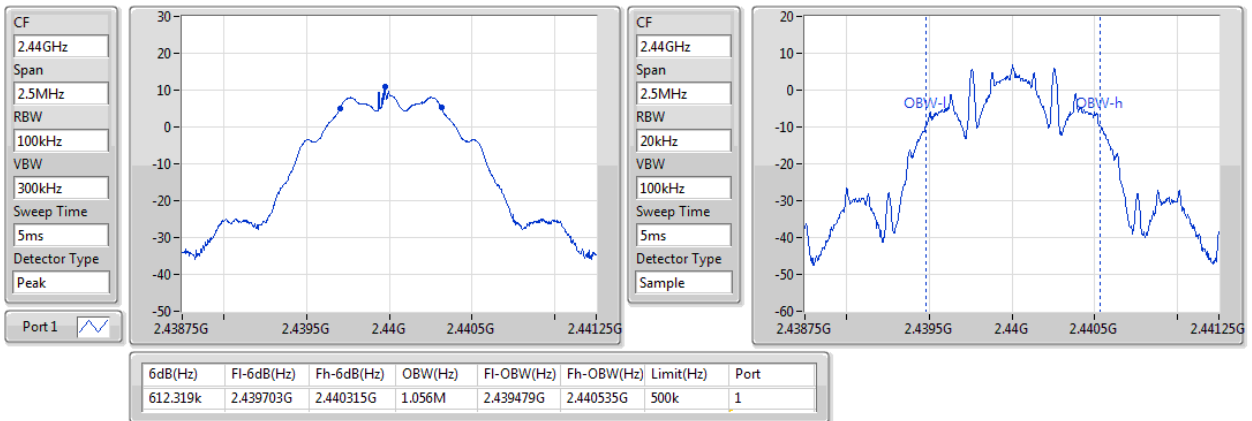

BT-LE(125kbps)

EBW-DTS

2480MHz

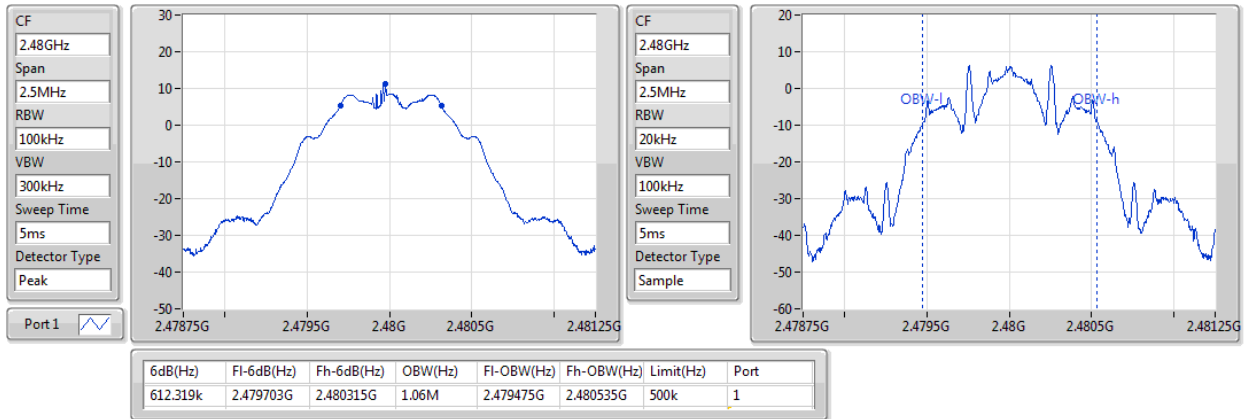

BT-LE(500kbps)

EBW-DTS

2402MHz

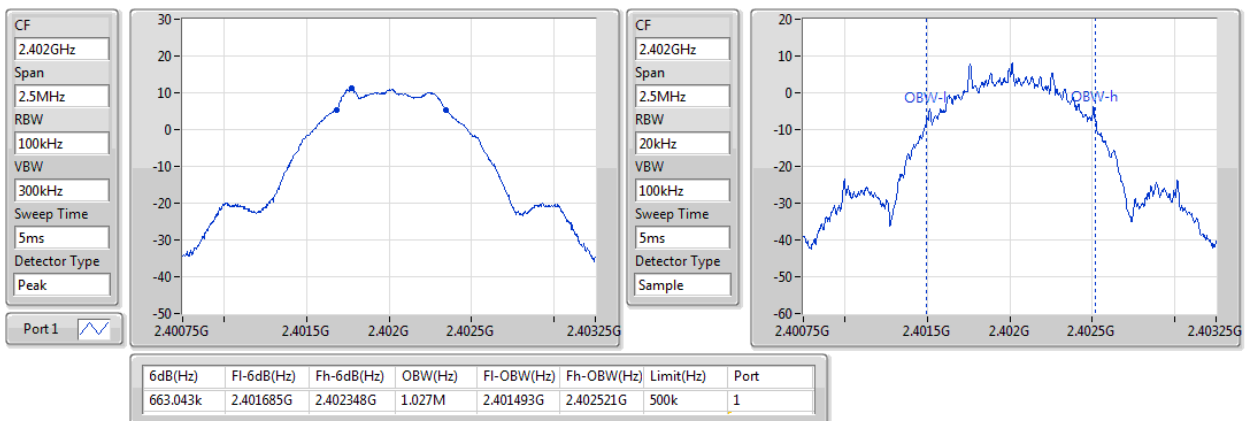

BT-LE(500kbps)

EBW-DTS

2440MHz

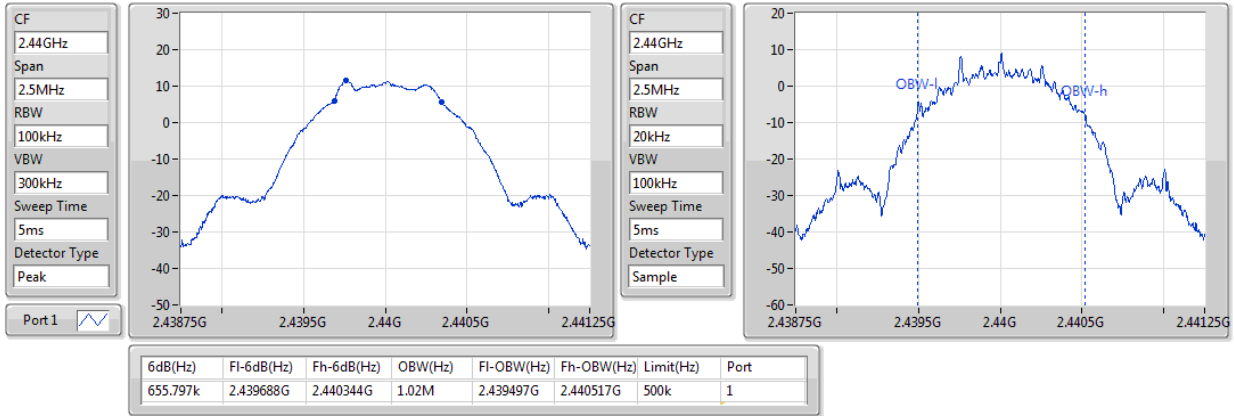

BT-LE(500kbps)

EBW-DTS

2480MHz

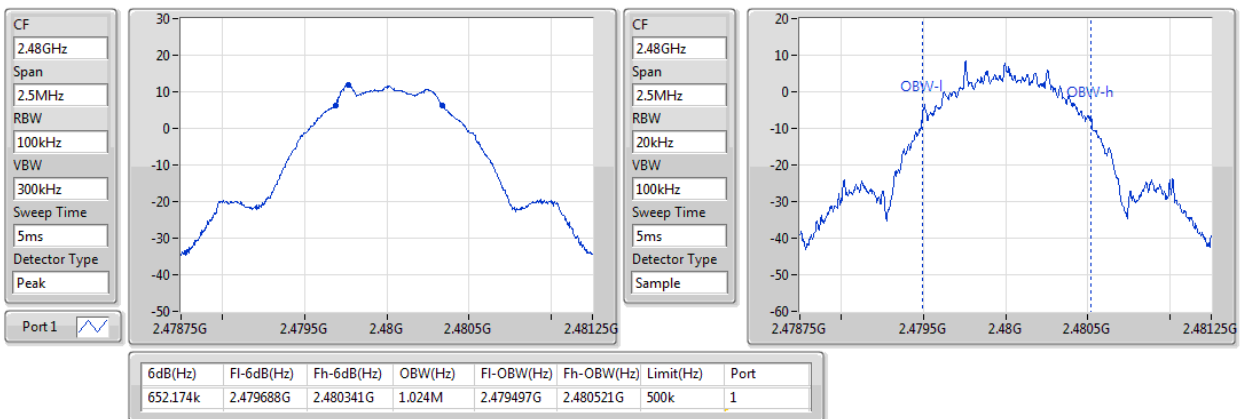

BT-LE(1Mbps)

EBW-DTS

2402MHz

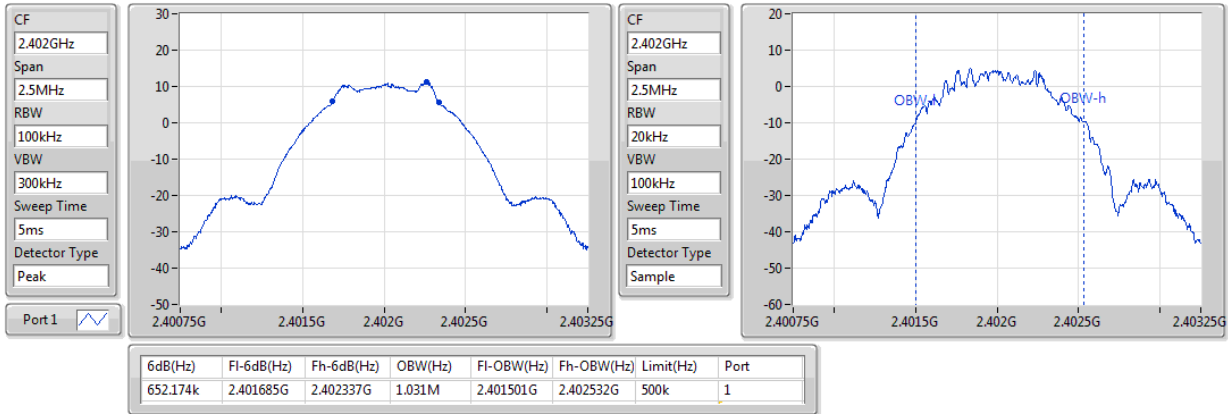

BT-LE(1Mbps)

EBW-DTS

2440MHz

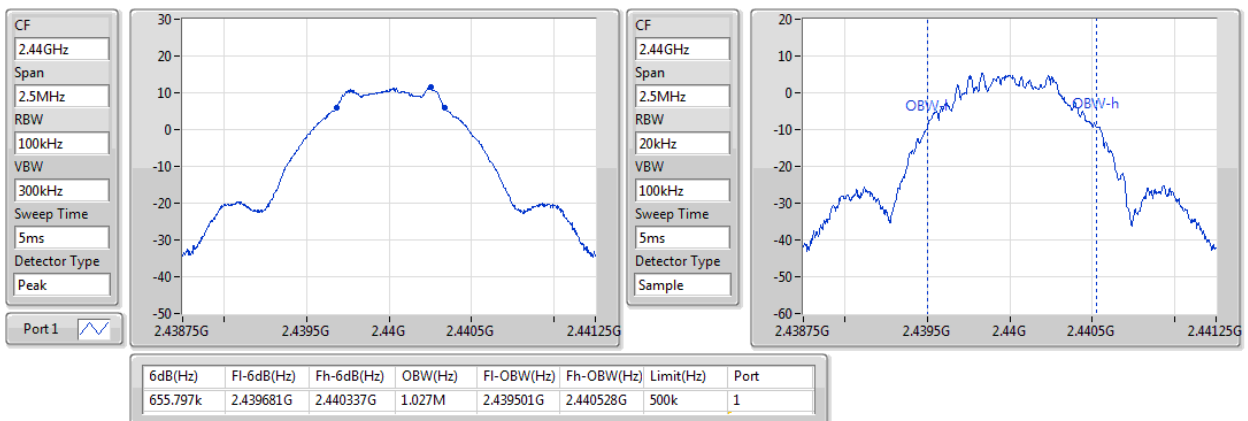

BT-LE(1Mbps)

EBW-DTS

2480MHz

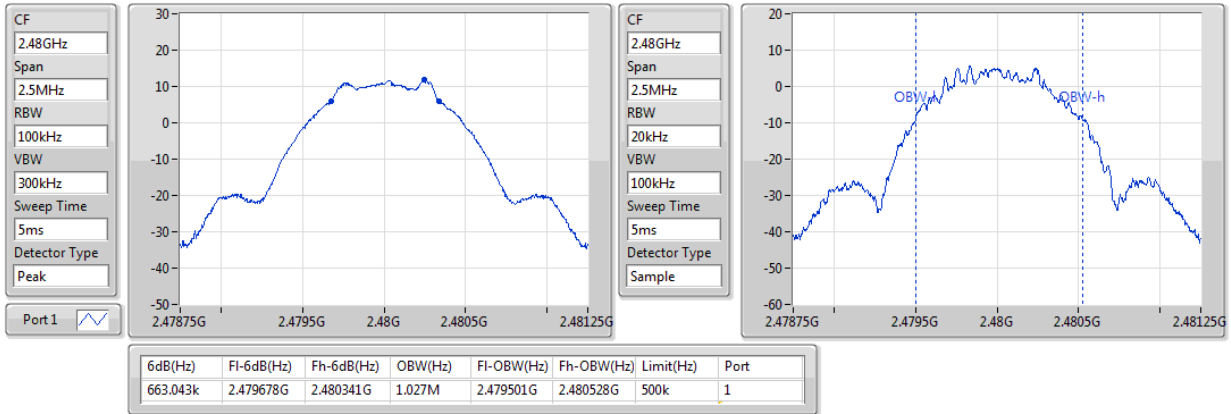

BT-LE(2Mbps)

EBW-DTS

2402MHz

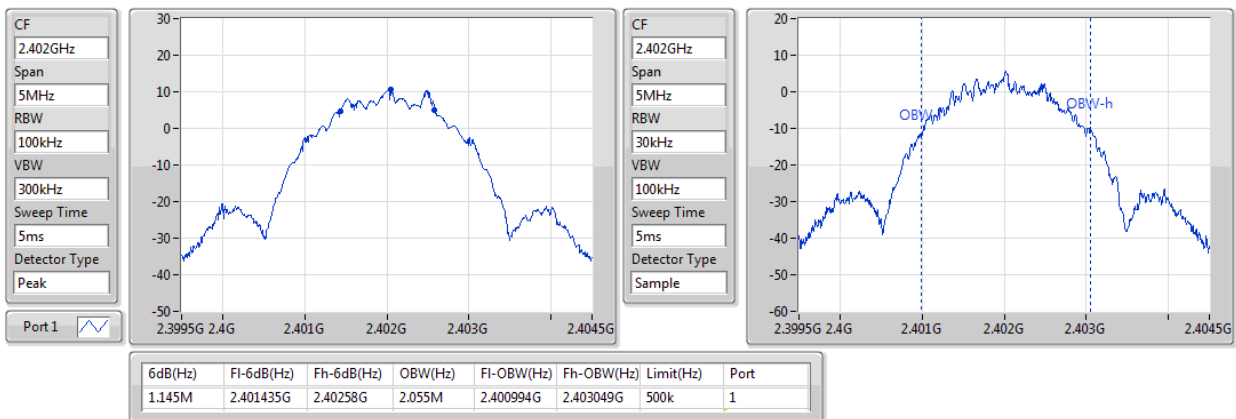

BT-LE(2Mbps)

EBW-DTS

2440MHz

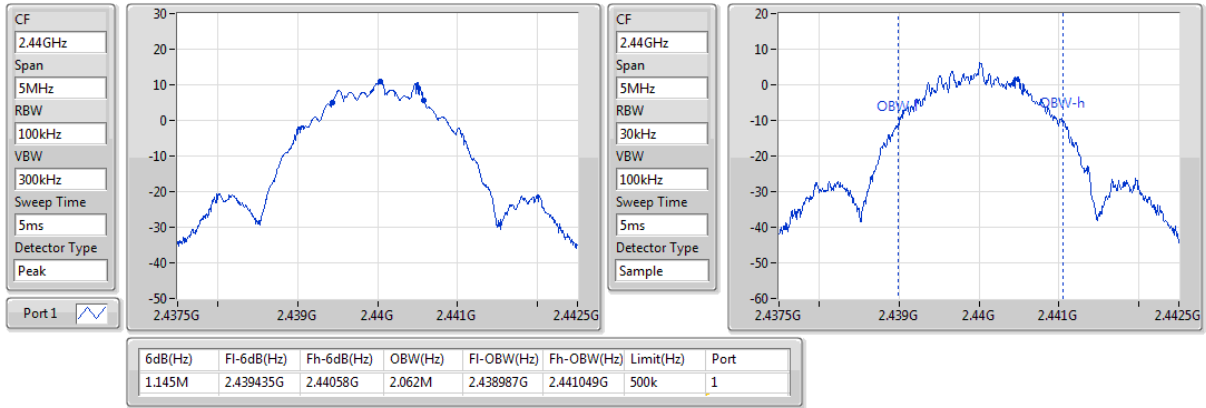

BT-LE(2Mbps)

EBW-DTS

2480MHz

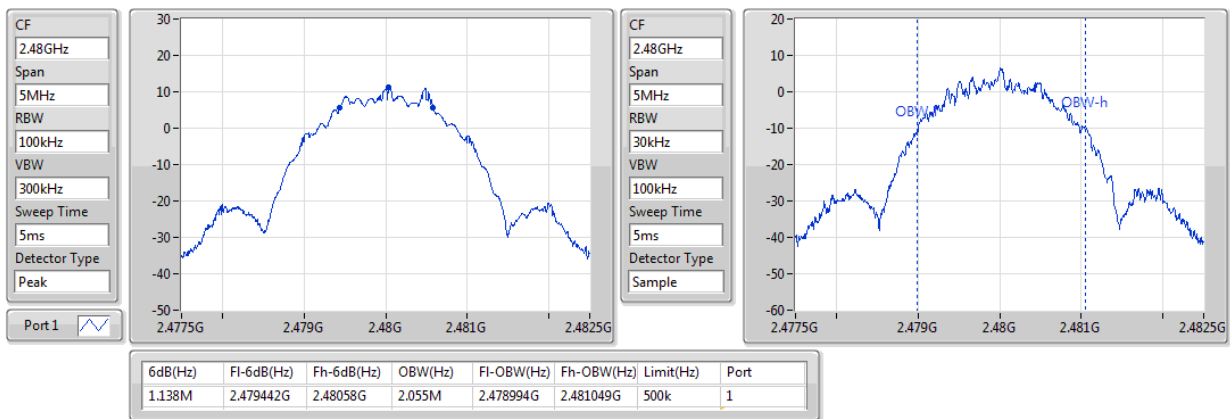

3.3 RF Output Power

3.3.1 Limit of RF Output Power

Conducted power shall not exceed 1 Watt.

Antenna gain $\leq 6\text{dBi}$, no any corresponding reduction is in output power limit.

3.3.2 Test Procedures

A broadband RF power meter is used for output power measurement. The video bandwidth of power meter is greater than DTS bandwidth of EUT. If duty cycle of test signal is not 100 %, trigger and gating function of power meter will be enabled to capture transmission burst for measuring output power.

3.3.3 Test Setup

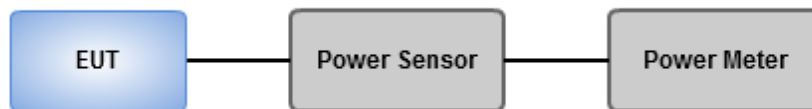

3.3.4 Test Result of Maximum Output Power

Ambient Condition	20°C / 65%	Tested By	Aska Huang
--------------------------	------------	------------------	------------

Summary of Peak Conducted Output Power

Mode	Power (dBm)	Power (W)
2.4-2.4835GHz	-	-
BT-LE(125kbps)	12.34	0.01714
BT-LE(500kbps)	12.35	0.01718
BT-LE(1Mbps)	12.40	0.01738
BT-LE(2Mbps)	12.36	0.01722

Result

Mode	Result	Antenna Gain (dBi)	Power (dBm)	Power Limit (dBm)
BT-LE(125kbps)	-	-	-	-
2402MHz	Pass	4.20	11.75	30.00
2440MHz	Pass	4.20	12.11	30.00
2480MHz	Pass	4.20	12.34	30.00
BT-LE(500kbps)	-	-	-	-
2402MHz	Pass	4.20	11.76	30.00
2440MHz	Pass	4.20	12.12	30.00
2480MHz	Pass	4.20	12.35	30.00
BT-LE(1Mbps)	-	-	-	-
2402MHz	Pass	4.20	11.82	30.00
2440MHz	Pass	4.20	12.16	30.00
2480MHz	Pass	4.20	12.40	30.00
BT-LE(2Mbps)	-	-	-	-
2402MHz	Pass	4.20	11.80	30.00
2440MHz	Pass	4.20	12.14	30.00
2480MHz	Pass	4.20	12.36	30.00

Summary of Conducted (Average) Output Power

Mode	Power (dBm)	Power (W)
2.4-2.4835GHz	-	-
BT-LE(125kbps)	12.30	0.01698
BT-LE(500kbps)	12.31	0.01702
BT-LE(1Mbps)	12.37	0.01726
BT-LE(2Mbps)	12.32	0.01706

Result

Mode	Result	Antenna Gain (dBi)	Power (dBm)	Power Limit (dBm)
BT-LE(125kbps)	-	-	-	-
2402MHz	Pass	4.20	11.71	-
2440MHz	Pass	4.20	12.06	-
2480MHz	Pass	4.20	12.30	-
BT-LE(500kbps)	-	-	-	-
2402MHz	Pass	4.20	11.70	-
2440MHz	Pass	4.20	12.05	-
2480MHz	Pass	4.20	12.31	-
BT-LE(1Mbps)	-	-	-	-
2402MHz	Pass	4.20	11.78	-
2440MHz	Pass	4.20	12.12	-
2480MHz	Pass	4.20	12.37	-
BT-LE(2Mbps)	-	-	-	-
2402MHz	Pass	4.20	11.75	-
2440MHz	Pass	4.20	12.10	-
2480MHz	Pass	4.20	12.32	-

Note: Average power is for reference only.

3.4 Power Spectral Density

3.4.1 Limit of Power Spectral Density

Power spectral density shall not be greater than 8 dBm in any 3 kHz band.

3.4.2 Test Procedures

Peak PSD

1. Set the RBW = 3 kHz, VBW = 10 kHz.
2. Detector = Peak, Sweep time = auto couple.
3. Trace mode = max hold, allow trace to fully stabilize.
4. Use the peak marker function to determine the maximum amplitude level.

Average PSD, duty cycle $\geq 98\%$

1. Set the RBW = 30 kHz, VBW = 100 kHz.
2. Detector = RMS, Sweep time = auto couple.
3. Sweep time = auto couple.
4. Employ trace averaging (RMS) mode over a minimum of 100 traces.
5. Use the peak marker function to determine the maximum amplitude level.

Average PSD, duty cycle $< 98\%$

1. Set the RBW = 30 kHz, VBW = 100 kHz. Detector = RMS.
2. Set the sweep time to: ≥ 10 (number of measurement points in sweep) x (total on/off period of the transmitted signal).
3. Perform the measurement over a single sweep.
4. Use the peak marker function to determine the maximum amplitude level.
5. Add $10 \log (1/x)$, where x is the duty cycle.

3.4.3 Test Setup

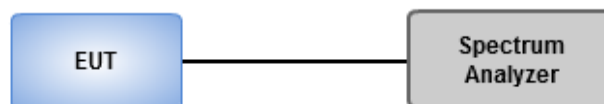

3.4.4 Test Result of Power Spectral Density

Ambient Condition	20°C / 65%	Tested By	Aska Huang
--------------------------	------------	------------------	------------

Summary

Mode	PD (dBm/3kHz)
2.4-2.4835GHz	-
BT-LE(125kbps)	5.95
BT-LE(500kbps)	5.69
BT-LE(1Mbps)	-4.16
BT-LE(2Mbps)	-7.06

Result

Mode	Result	Antenna Gain (dBi)	Power Density (dBm/3kHz)	Power Density Limit (dBm/3kHz)
BT-LE(125kbps)	-	-	-	-
2402MHz	Pass	4.20	5.32	8.00
2440MHz	Pass	4.20	5.63	8.00
2480MHz	Pass	4.20	5.95	8.00
BT-LE(500kbps)	-	-	-	-
2402MHz	Pass	4.20	5.11	8.00
2440MHz	Pass	4.20	5.30	8.00
2480MHz	Pass	4.20	5.69	8.00
BT-LE(1Mbps)	-	-	-	-
2402MHz	Pass	4.20	-4.69	8.00
2440MHz	Pass	4.20	-4.42	8.00
2480MHz	Pass	4.20	-4.16	8.00
BT-LE(2Mbps)	-	-	-	-
2402MHz	Pass	4.20	-7.67	8.00
2440MHz	Pass	4.20	-7.27	8.00
2480MHz	Pass	4.20	-7.06	8.00

BT-LE(125kbps)

PSD

2402MHz

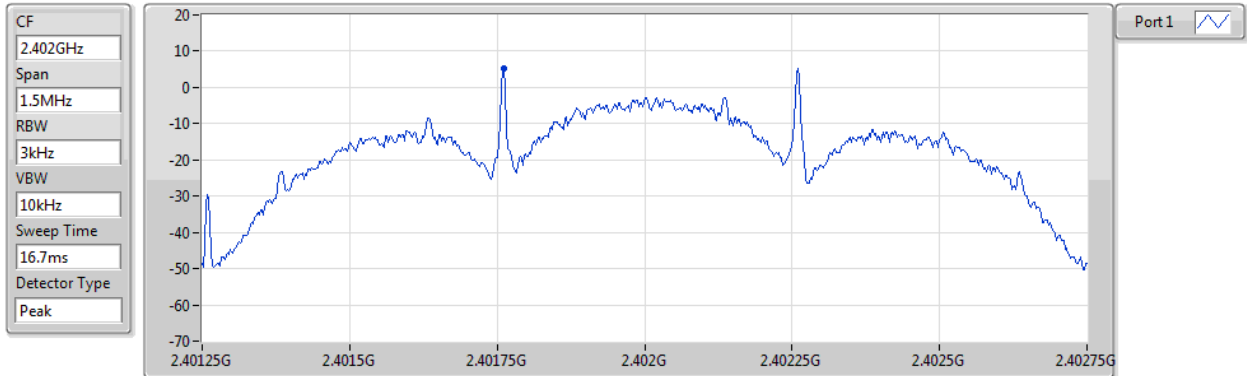

Sum	PD	Port 1
(dBm/RBW)	(dBm/RBW)	(dBm/RBW)
5.32	5.32	5.32

BT-LE(125kbps)

PSD

2440MHz

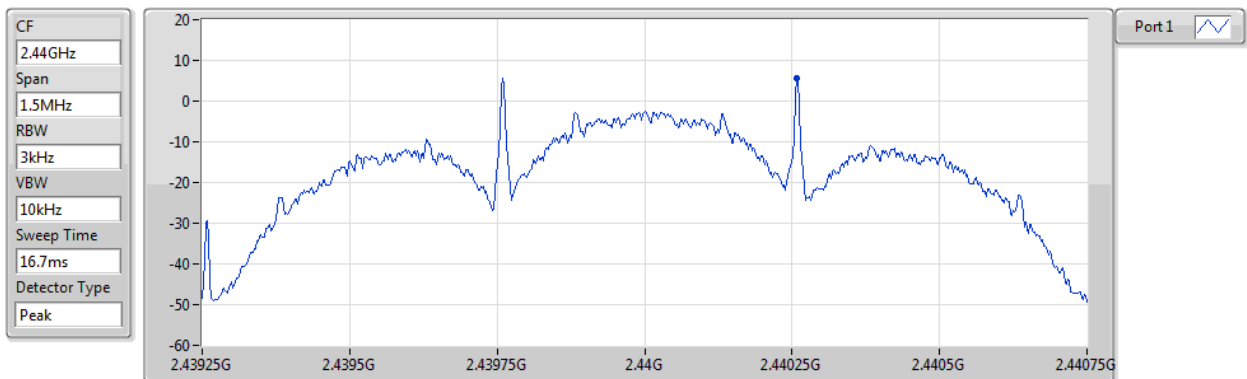

Sum	PD	Port 1
(dBm/RBW)	(dBm/RBW)	(dBm/RBW)
5.63	5.63	5.63

BT-LE(125kbps)

PSD

2480MHz

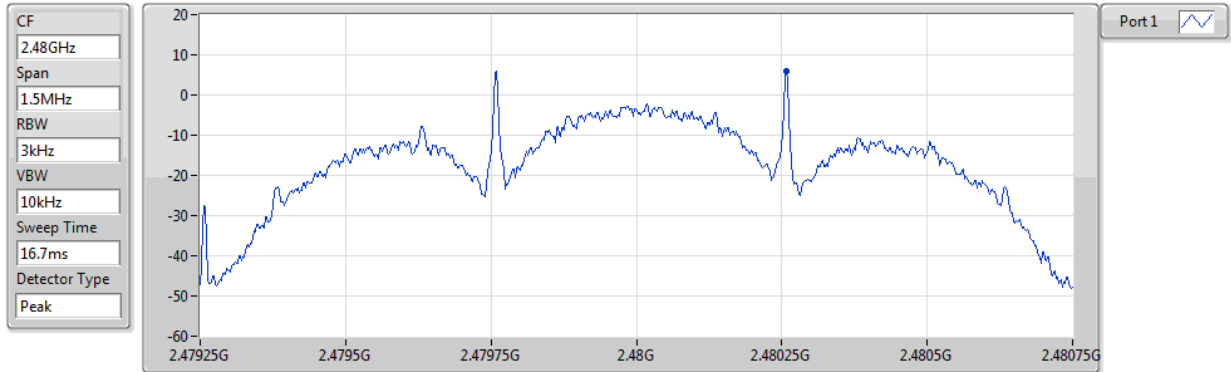

Sum	PD	Port 1
(dBm/RBW)	(dBm/RBW)	(dBm/RBW)
5.95	5.95	5.95

BT-LE(500kbps)

PSD

2402MHz

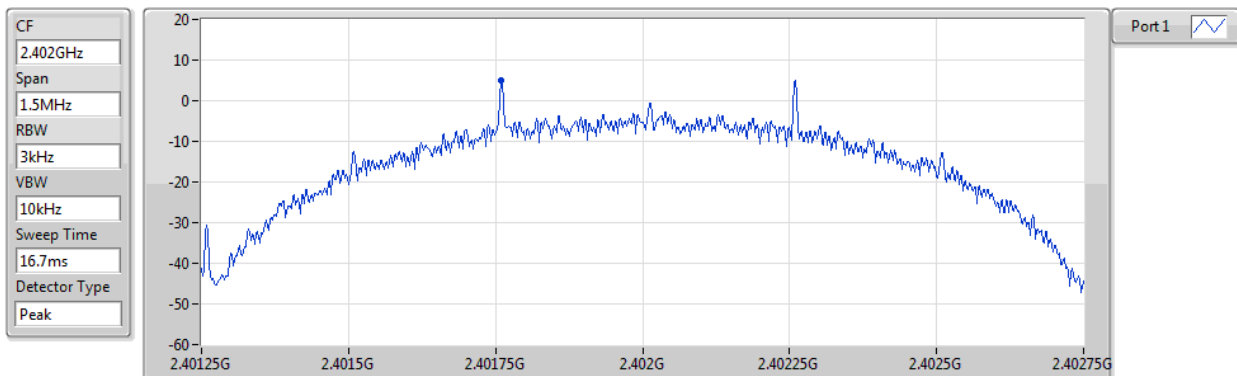

Sum	PD	Port 1
(dBm/RBW)	(dBm/RBW)	(dBm/RBW)
5.11	5.11	5.11

BT-LE(500kbps)

PSD

2440MHz

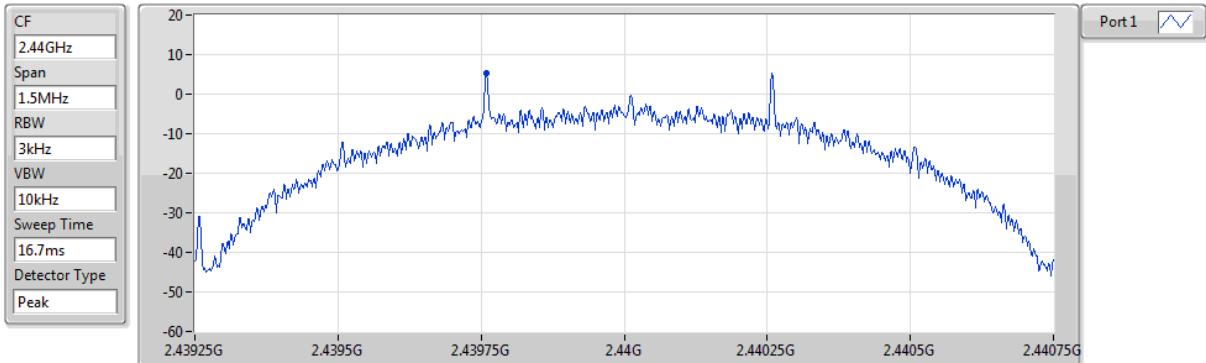

Sum	PD	Port 1
(dBm/RBW)	(dBm/RBW)	(dBm/RBW)
5.30	5.30	5.30

BT-LE(500kbps)

PSD

2480MHz

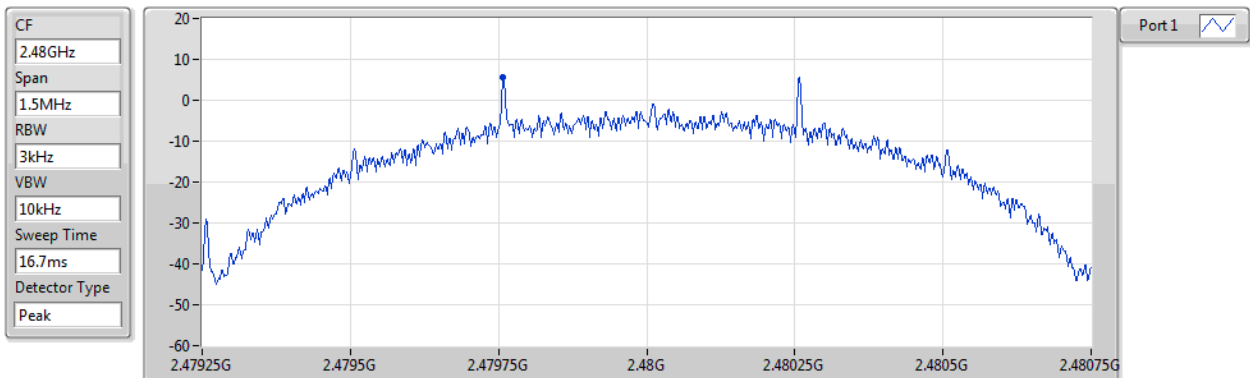

Sum	PD	Port 1
(dBm/RBW)	(dBm/RBW)	(dBm/RBW)
5.69	5.69	5.69

BT-LE(1Mbps)

PSD

2402MHz

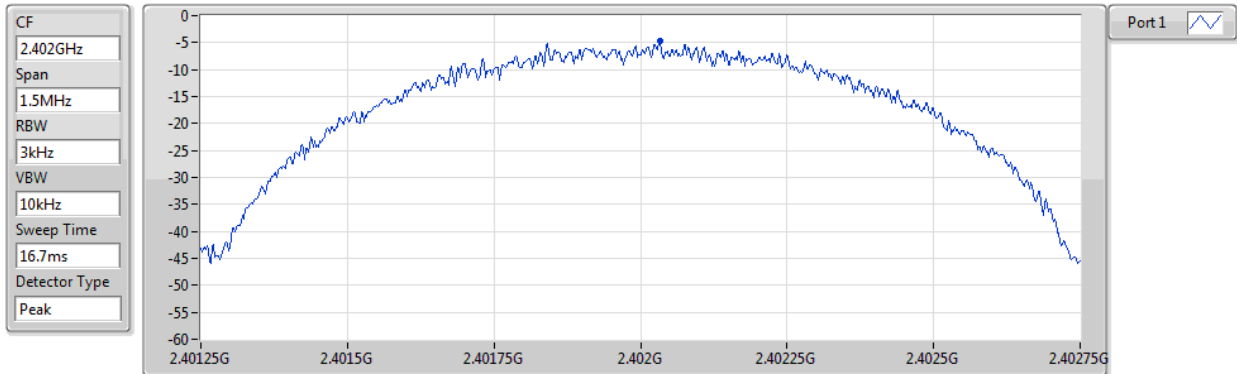

Sum	PD	Port 1
(dBm/RBW)	(dBm/RBW)	(dBm/RBW)
-4.69	-4.69	-4.69

BT-LE(1Mbps)

PSD

2440MHz

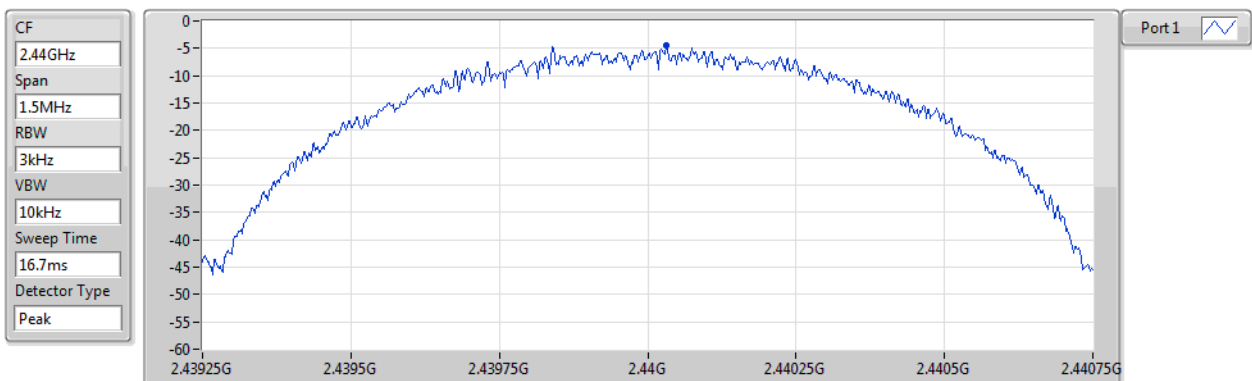

Sum	PD	Port 1
(dBm/RBW)	(dBm/RBW)	(dBm/RBW)
-4.42	-4.42	-4.42

BT-LE(1Mbps)

PSD

2480MHz

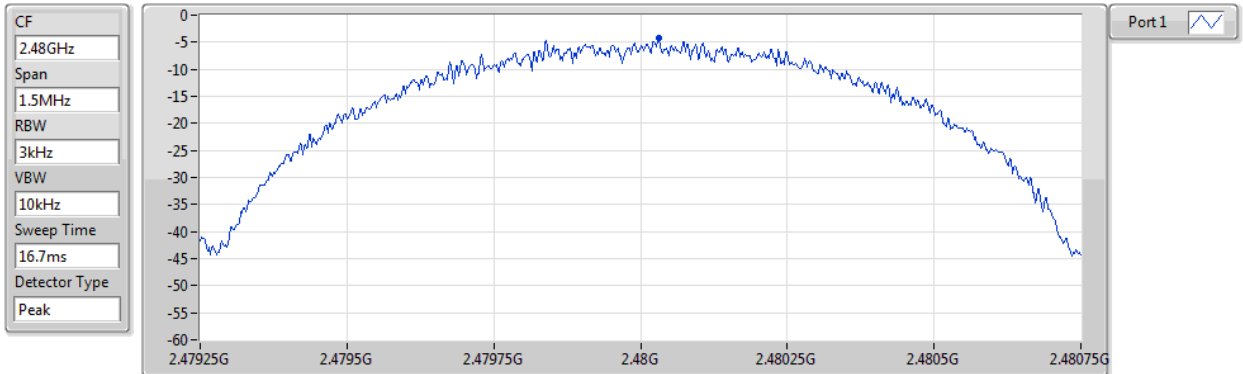

Sum	PD	Port 1
(dBm/RBW)	(dBm/RBW)	(dBm/RBW)
-4.16	-4.16	-4.16

BT-LE(2Mbps)

PSD

2402MHz

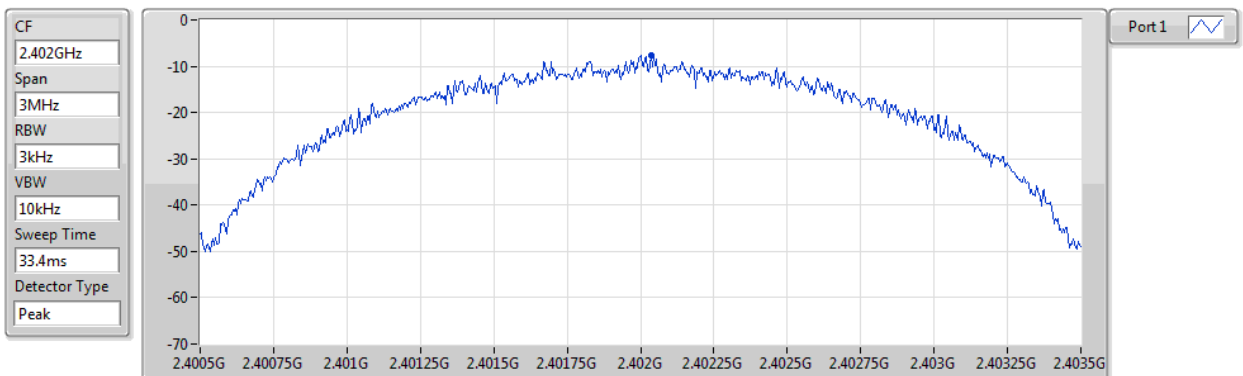

Sum	PD	Port 1
(dBm/RBW)	(dBm/RBW)	(dBm/RBW)
-7.67	-7.67	-7.67

BT-LE(2Mbps)

PSD

2440MHz

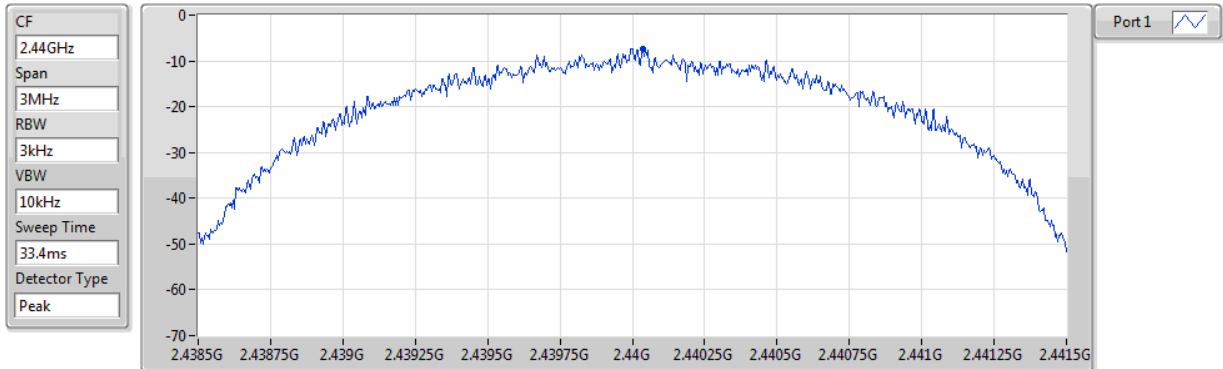

Sum	PD	Port 1
(dBm/RBW)	(dBm/RBW)	(dBm/RBW)
-7.27	-7.27	-7.27

BT-LE(2Mbps)

PSD

2480MHz

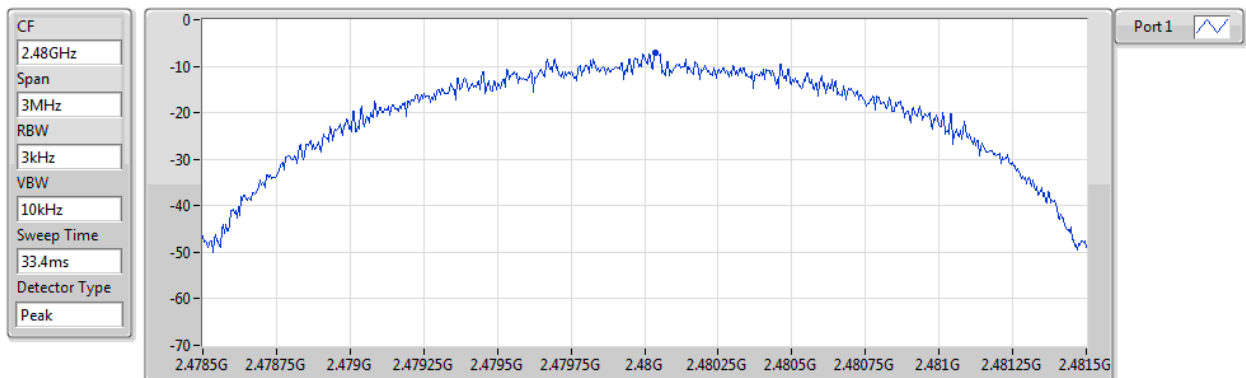

Sum	PD	Port 1
(dBm/RBW)	(dBm/RBW)	(dBm/RBW)
-7.06	-7.06	-7.06

3.5 Emissions in Restricted Frequency Bands

3.5.1 Limit of Emissions in Restricted Frequency Bands

Restricted Band Emissions Limit			
Frequency Range (MHz)	Field Strength (uV/m)	Field Strength (dBuV/m)	Measure Distance (m)
0.009~0.490	2400/F(kHz)	48.5 - 13.8	300
0.490~1.705	24000/F(kHz)	33.8 - 23	30
1.705~30.0	30	29	30
30~88	100	40	3
88~216	150	43.5	3
216~960	200	46	3
Above 960	500	54	3

Note 1:
Quasi-Peak value is measured for frequency below 1GHz except for 9–90 kHz, 110–490 kHz frequency band. Peak and average value are measured for frequency above 1GHz. The limit on average radio frequency emission is as above table. The limit on peak radio frequency emissions is 20 dB above the maximum permitted average emission limit

Note 2:
Measurements may be performed at a distance other than what is specified provided. When performing measurements at a distance other than that specified, the results shall be extrapolated to the specified distance using an extrapolation factor as below, Frequency at or above 30 MHz: 20 dB/decade Frequency below 30 MHz: 40 dB/decade.

3.5.2 Test Procedures

1. Measurement is made at a semi-anechoic chamber that incorporates a turntable allowing a EUT rotation of 360°. A continuously-rotating, remotely-controlled turntable is installed at the test site to support the EUT and facilitate determination of the direction of maximum radiation for each EUT emission frequency. The EUT is placed at test table. For emissions testing at or below 1 GHz, the table height is 80 cm above the reference ground plane. For emission measurements above 1 GHz, the table height is 1.5 m
2. Measurement is made with the antenna positioned in both the horizontal and vertical planes of polarization. The measurement antenna is varied in height (1m ~ 4m) above the reference ground plane to obtain the maximum signal strength. Distance between EUT and antenna is 3 m.
3. This investigation is performed with the EUT rotated 360°, the antenna height scanned between 1 m and 4 m, and the antenna rotated to repeat the measurements for both the horizontal and vertical antenna polarizations.

Note:

1. 120kHz measurement bandwidth of test receiver and Quasi-peak detector is for radiated emission below 1GHz.
2. RBW=1MHz, VBW=3MHz and Peak detector is for peak measured value of radiated emission above 1GHz.
3. RBW=1MHz, VBW=1/T and Peak detector is for average measured value of radiated emission above 1GHz.

3.5.3 Test Setup

Radiated Emissions below 1 GHz

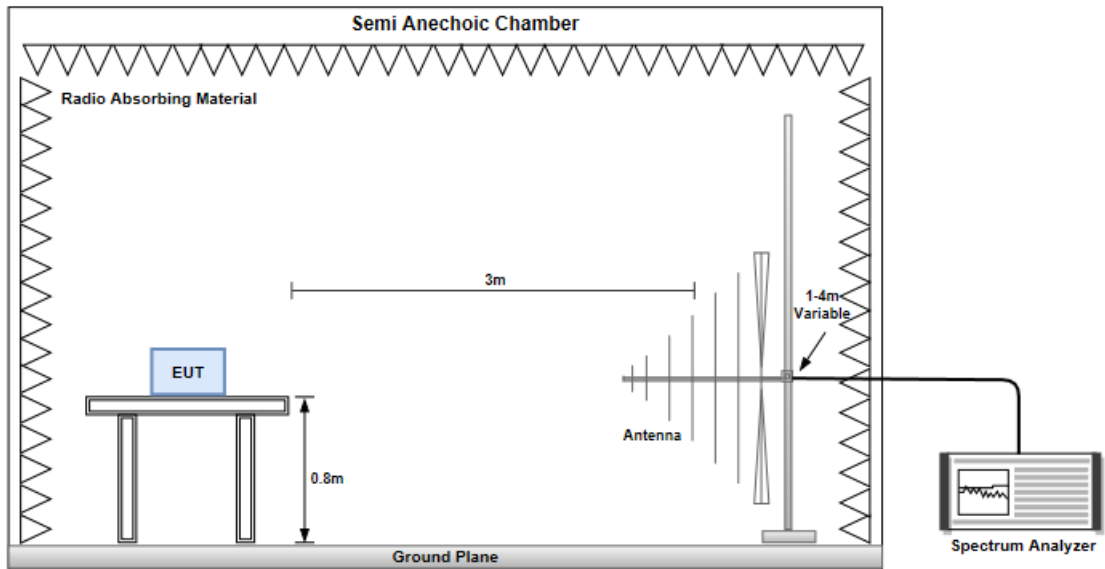

Radiated Emissions above 1 GHz

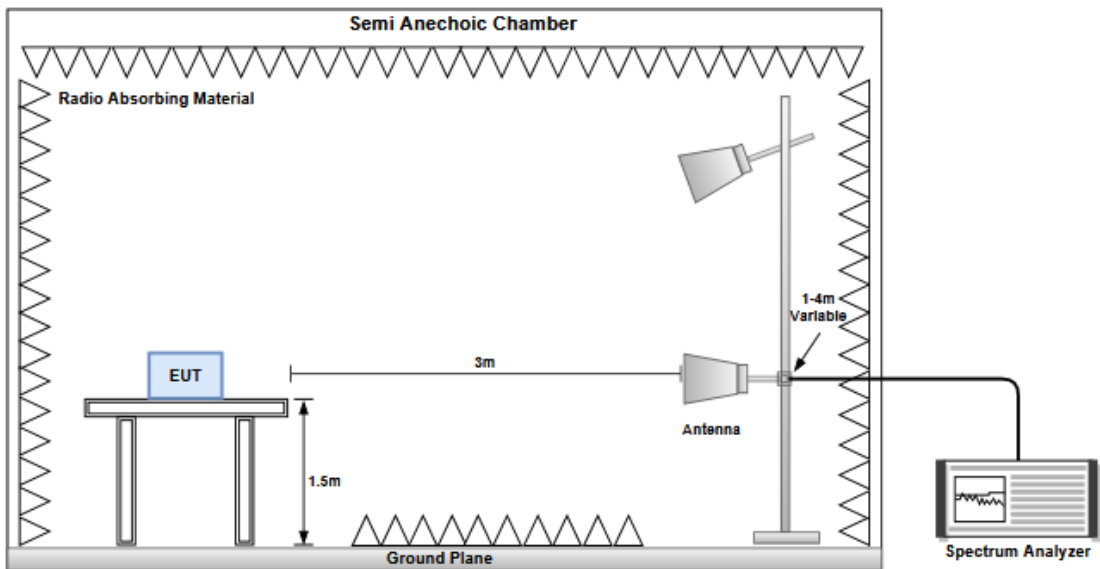

3.5.4 Transmitter Radiated Unwanted Emissions (Below 1GHz)

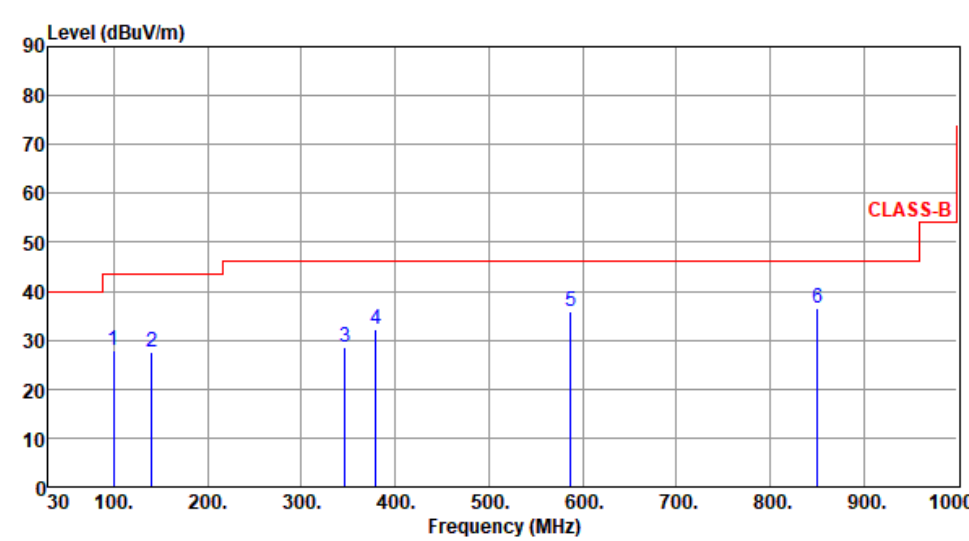
Modulation	BT-LE (2Mbps)	Test Freq. (MHz)	2402						
Polarization	Horizontal								
Test By : Akun Chung Temperature(°C): 22 Humidity(%): 65									
									
	Freq. MHz	Emission level dBuV/m	Limit dBuV/m	Margin dB	SA reading dBuV	Factor dB/m	Remark	ANT High cm	Turn Table deg
1	99.84	28.01	43.50	-15.49	41.40	-13.39	Peak	---	---
2	140.26	27.59	43.50	-15.91	36.83	-9.24	Peak	---	---
3	346.22	28.72	46.00	-17.28	35.90	-7.18	Peak	---	---
4	379.20	32.31	46.00	-13.69	38.55	-6.24	Peak	---	---
5	587.75	35.98	46.00	-10.02	37.37	-1.39	Peak	---	---
6	850.62	36.54	46.00	-9.46	33.92	2.62	Peak	---	---

Note 1: Emission Level (dBuV/m) = SA Reading (dBuV) + Factor* (dB/m)
*Factor includes antenna factor , cable loss and amplifier gain
Note 2: Margin (dB) = Emission level (dBuV/m) – Limit (dBuV/m).
Note 3: All spurious emissions below 30MHz are more than 20 dB below the limit.

Modulation	BT-LE (2Mbps)	Test Freq. (MHz)	2402
Polarization	Vertical		

Test By : Akun Chung Temperature(°C): 22 Humidity(%): 65

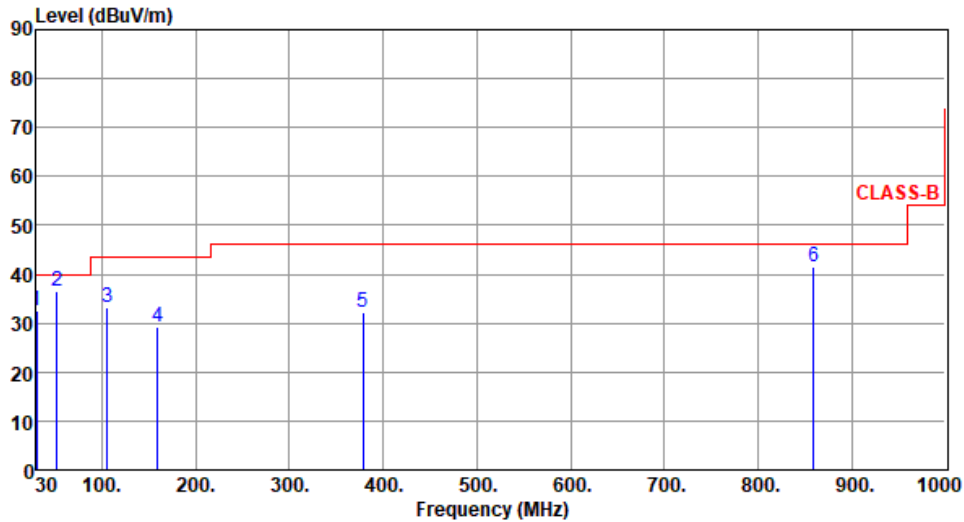

	Freq. MHz	Emission level dBuV/m	Limit dBuV/m	Margin dB	SA reading dBuV	Factor dB/m	Remark	ANT High cm	Turn Table deg
1	30.26	32.45	40.00	-7.55	42.39	-9.94	Peak	---	---
2	51.56	36.57	40.00	-3.43	45.35	-8.78	Peak	---	---
3	105.66	33.37	43.50	-10.13	45.64	-12.27	Peak	---	---
4	159.01	29.17	43.50	-14.33	37.86	-8.69	Peak	---	---
5	378.16	32.15	46.00	-13.85	38.41	-6.26	Peak	---	---
6	859.35	41.50	46.00	-4.50	38.65	2.85	Peak	---	---

Note 1: Emission Level (dBuV/m) = SA Reading (dBuV) + Factor* (dB/m)

*Factor includes antenna factor , cable loss and amplifier gain

Note 2: Margin (dB) = Emission level (dBuV/m) – Limit (dBuV/m).

Note 3: All spurious emissions below 30MHz are more than 20 dB below the limit.

3.5.5 Transmitter Radiated Unwanted Emissions (Above 1GHz)

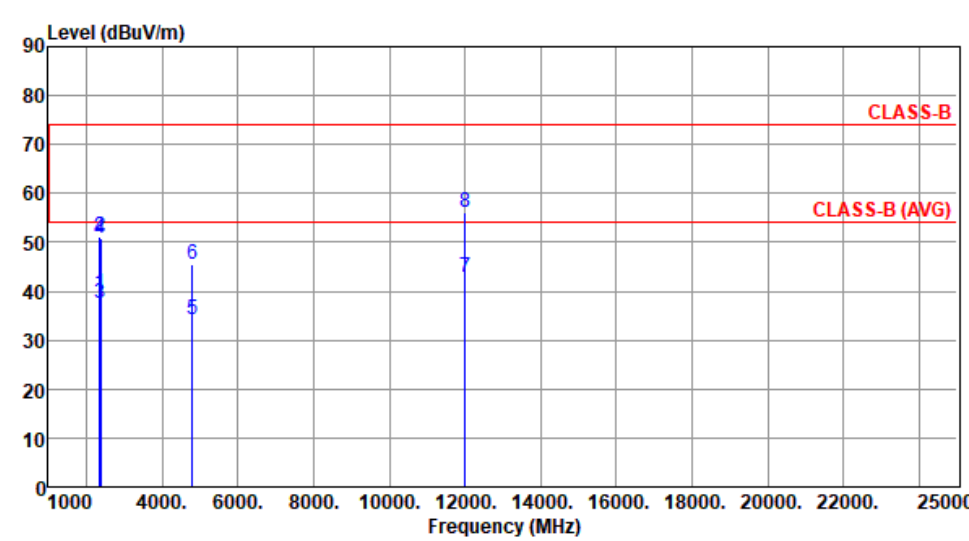
Modulation	BT-LE (1Mbps)	Test Freq. (MHz)	2402						
Polarization	Horizontal								
Test By : Roger Lu Temperature(°C):22 Humidity(%):65									
									
	Freq.	Emission level	Limit	Margin	SA reading	Factor	Remark	ANT High	Turn Table
	MHz	dBuV/m	dBuV/m	dB	dBuV	dB/m		cm	deg
1	2363.60	39.52	54.00	-14.48	42.19	-2.67	Average	192	270
2	2363.60	51.22	74.00	-22.78	53.89	-2.67	Peak	192	270
3	2390.00	37.52	54.00	-16.48	40.27	-2.75	Average	192	270
4	2390.00	50.81	74.00	-23.19	53.56	-2.75	Peak	192	270
5	4804.00	34.25	54.00	-19.75	30.12	4.13	Average	100	239
6	4804.00	45.39	74.00	-28.61	41.26	4.13	Peak	100	239
7	12010.00	42.87	54.00	-11.13	29.25	13.62	Average	100	50
8	12010.00	55.96	74.00	-18.04	42.34	13.62	Peak	100	50

Note 1: Emission Level (dBuV/m) = SA Reading (dBuV) + Factor* (dB/m)
*Factor includes antenna factor , cable loss and amplifier gain
Note 2: Margin (dB) = Emission level (dBuV/m) – Limit (dBuV/m).

Modulation	BT-LE (1Mbps)	Test Freq. (MHz)	2402
Polarization	Vertical		

Test By :Roger Lu Temperature(°C):22 Humidity(%):65

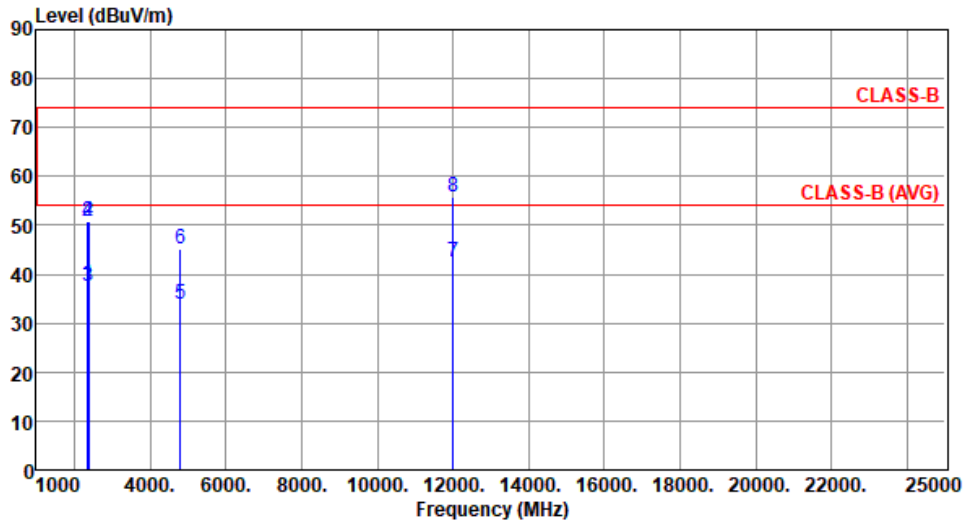

	Freq. MHz	Emission level dBuV/m	Limit dBuV/m	Margin dB	SA reading dBuV	Factor dB/m	Remark	ANT High cm	Turn Table deg
1	2363.60	37.91	54.00	-16.09	40.58	-2.67	Average	100	295
2	2363.60	50.85	74.00	-23.15	53.52	-2.67	Peak	100	295
3	2390.00	37.40	54.00	-16.60	40.15	-2.75	Average	100	295
4	2390.00	50.67	74.00	-23.33	53.42	-2.75	Peak	100	295
5	4804.00	33.89	54.00	-20.11	29.76	4.13	Average	100	286
6	4804.00	45.15	74.00	-28.85	41.02	4.13	Peak	100	286
7	12010.00	42.64	54.00	-11.36	29.02	13.62	Average	100	30
8	12010.00	55.73	74.00	-18.27	42.11	13.62	Peak	100	30

Note 1: Emission Level (dBuV/m) = SA Reading (dBuV) + Factor* (dB/m)

*Factor includes antenna factor , cable loss and amplifier gain

Note 2: Margin (dB) = Emission level (dBuV/m) – Limit (dBuV/m).

Modulation	BT-LE (1Mbps)	Test Freq. (MHz)	2440
Polarization	Horizontal		

Test By :Roger Lu Temperature(°C):22 Humidity(%):65

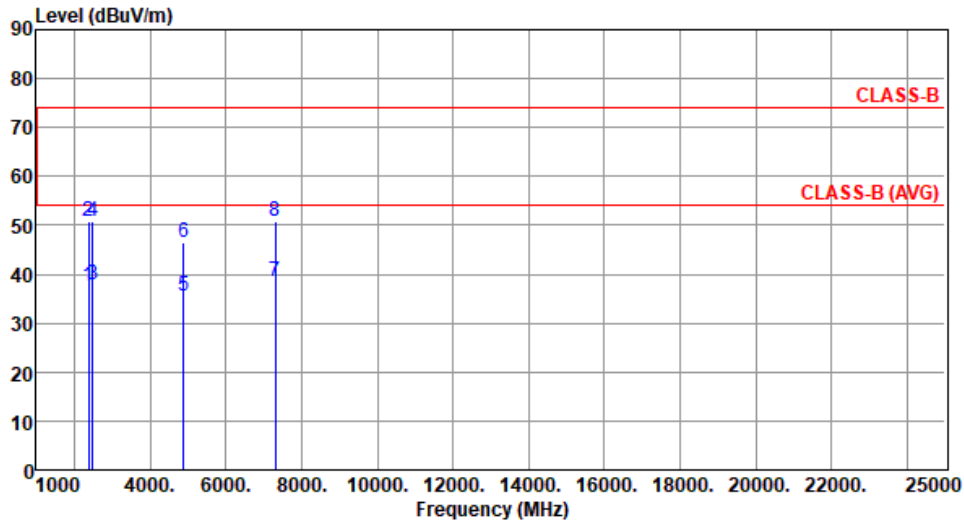

	Freq. MHz	Emission level dBuV/m	Limit dBuV/m	Margin dB	SA reading dBuV	Factor dB/m	Remark	ANT High cm	Turn Table deg
1	2390.00	37.53	54.00	-16.47	40.28	-2.75	Average	195	285
2	2390.00	50.71	74.00	-23.29	53.46	-2.75	Peak	195	285
3	2483.50	37.75	54.00	-16.25	40.45	-2.70	Average	195	285
4	2483.50	50.89	74.00	-23.11	53.59	-2.70	Peak	195	285
5	4880.00	35.51	54.00	-18.49	31.39	4.12	Average	100	222
6	4880.00	46.39	74.00	-27.61	42.27	4.12	Peak	100	222
7	7320.00	38.47	54.00	-15.53	29.19	9.28	Average	100	270
8	7320.00	50.96	74.00	-23.04	41.68	9.28	Peak	100	270

Note 1: Emission Level (dBuV/m) = SA Reading (dBuV) + Factor* (dB/m)

*Factor includes antenna factor , cable loss and amplifier gain

Note 2: Margin (dB) = Emission level (dBuV/m) – Limit (dBuV/m).

Modulation	BT-LE (1Mbps)	Test Freq. (MHz)	2440
Polarization	Vertical		

Test By :Roger Lu Temperature(°C):22 Humidity(%):65

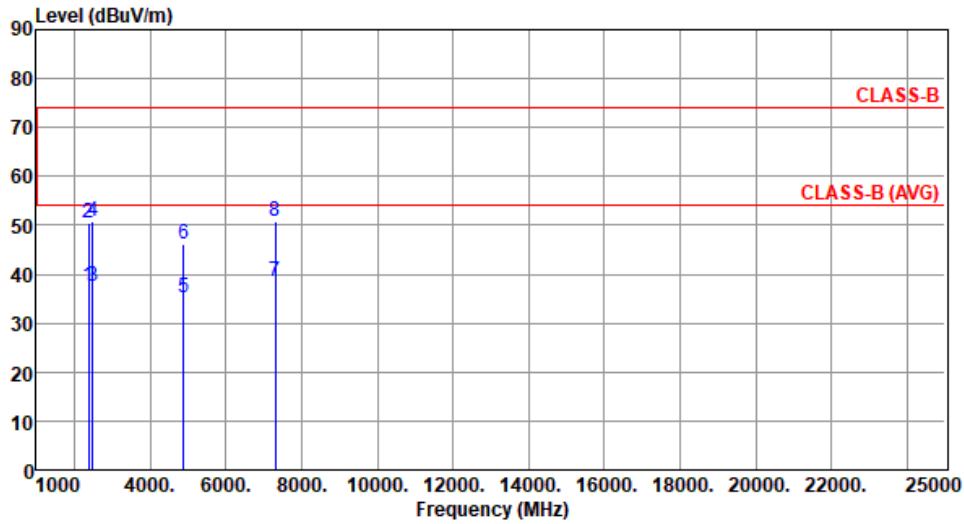

	Freq. MHz	Emission level dBuV/m	Limit dBuV/m	Margin dB	SA reading dBuV	Factor dB/m	Remark	ANT High cm	Turn Table deg
1	2390.00	37.40	54.00	-16.60	40.15	-2.75	Average	100	293
2	2390.00	50.50	74.00	-23.50	53.25	-2.75	Peak	100	293
3	2483.50	37.64	54.00	-16.36	40.34	-2.70	Average	100	293
4	2483.50	50.73	74.00	-23.27	53.43	-2.70	Peak	100	293
5	4880.00	35.20	54.00	-18.80	31.08	4.12	Average	100	284
6	4880.00	46.23	74.00	-27.77	42.11	4.12	Peak	100	284
7	7320.00	38.42	54.00	-15.58	29.14	9.28	Average	100	60
8	7320.00	50.83	74.00	-23.17	41.55	9.28	Peak	100	60

Note 1: Emission Level (dBuV/m) = SA Reading (dBuV) + Factor* (dB/m)

*Factor includes antenna factor , cable loss and amplifier gain

Note 2: Margin (dB) = Emission level (dBuV/m) – Limit (dBuV/m).

Modulation	BT-LE (1Mbps)	Test Freq. (MHz)	2480
Polarization	Horizontal		

Test By :Roger Lu Temperature(°C):22 Humidity(%):65

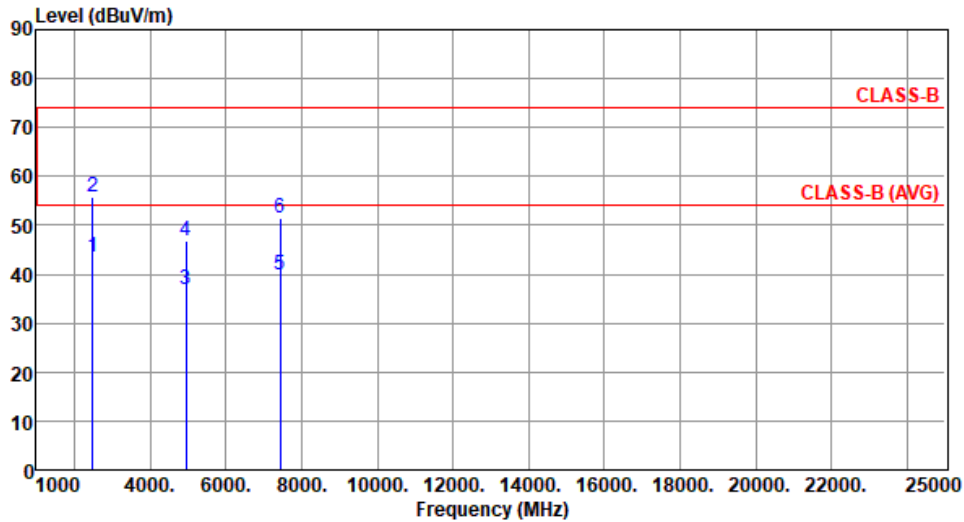

	Freq. MHz	Emission level dBuV/m	Limit dBuV/m	Margin dB	SA reading dBuV	Factor dB/m	Remark	ANT High cm	Turn Table deg
1	2483.50	43.63	54.00	-10.37	46.33	-2.70	Average	234	279
2	2483.50	55.84	74.00	-18.16	58.54	-2.70	Peak	234	279
3	4960.00	36.75	54.00	-17.25	32.72	4.03	Average	100	254
4	4960.00	46.81	74.00	-27.19	42.78	4.03	Peak	100	254
5	7440.00	39.94	54.00	-14.06	30.57	9.37	Average	100	269
6	7440.00	51.50	74.00	-22.50	42.13	9.37	Peak	100	269

Note 1: Emission Level (dBuV/m) = SA Reading (dBuV) + Factor* (dB/m)

*Factor includes antenna factor , cable loss and amplifier gain

Note 2: Margin (dB) = Emission level (dBuV/m) – Limit (dBuV/m).

Modulation	BT-LE (1Mbps)	Test Freq. (MHz)	2480
Polarization	Vertical		

Test By :Roger Lu Temperature(°C):22 Humidity(%):65

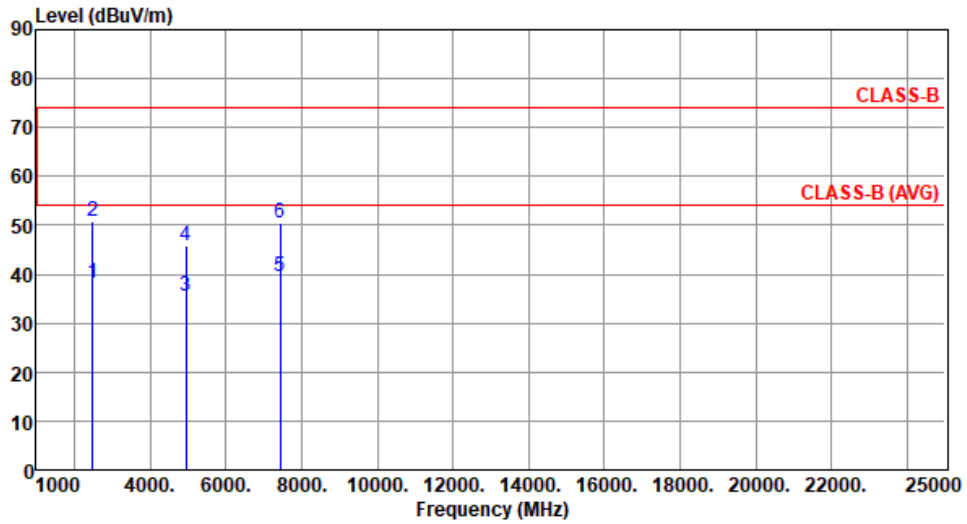

	Freq. MHz	Emission level dBuV/m	Limit dBuV/m	Margin dB	SA reading dBuV	Factor dB/m	Remark	ANT High cm	Turn Table deg
1	2483.50	38.26	54.00	-15.74	40.96	-2.70	Average	100	297
2	2483.50	50.75	74.00	-23.25	53.45	-2.70	Peak	100	297
3	4960.00	35.62	54.00	-18.38	31.59	4.03	Average	100	283
4	4960.00	45.67	74.00	-28.33	41.64	4.03	Peak	100	283
5	7440.00	39.50	54.00	-14.50	30.13	9.37	Average	100	50
6	7440.00	50.62	74.00	-23.38	41.25	9.37	Peak	100	50

Note 1: Emission Level (dBuV/m) = SA Reading (dBuV) + Factor* (dB/m)

*Factor includes antenna factor , cable loss and amplifier gain

Note 2: Margin (dB) = Emission level (dBuV/m) – Limit (dBuV/m).

Modulation	BT-LE (2Mbps)	Test Freq. (MHz)	2402
Polarization	Horizontal		

Test By :Roger Lu Temperature(°C):22 Humidity(%):65

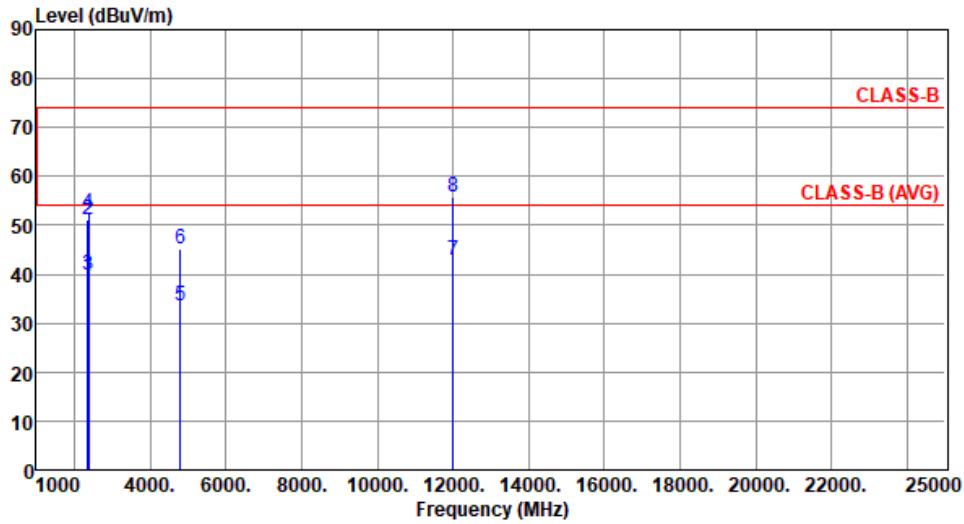

	Freq. MHz	Emission level dBuV/m	Limit dBuV/m	Margin dB	SA reading dBuV	Factor dB/m	Remark	ANT High cm	Turn Table deg
1	2363.60	39.44	54.00	-14.56	42.11	-2.67	Average	188	266
2	2363.60	51.28	74.00	-22.72	53.95	-2.67	Peak	188	266
3	2390.00	39.73	54.00	-14.27	42.48	-2.75	Average	188	266
4	2390.00	52.37	74.00	-21.63	55.12	-2.75	Peak	188	266
5	4804.00	33.38	54.00	-20.62	29.25	4.13	Average	100	233
6	4804.00	45.14	74.00	-28.86	41.01	4.13	Peak	100	233
7	12010.00	42.80	54.00	-11.20	29.18	13.62	Average	100	40
8	12010.00	55.73	74.00	-18.27	42.11	13.62	Peak	100	40

Note 1: Emission Level (dBuV/m) = SA Reading (dBuV) + Factor* (dB/m)

*Factor includes antenna factor , cable loss and amplifier gain

Note 2: Margin (dB) = Emission level (dBuV/m) – Limit (dBuV/m).

Modulation	BT-LE (2Mbps)	Test Freq. (MHz)	2402
Polarization	Vertical		

Test By :Roger Lu Temperature(°C):22 Humidity(%):65

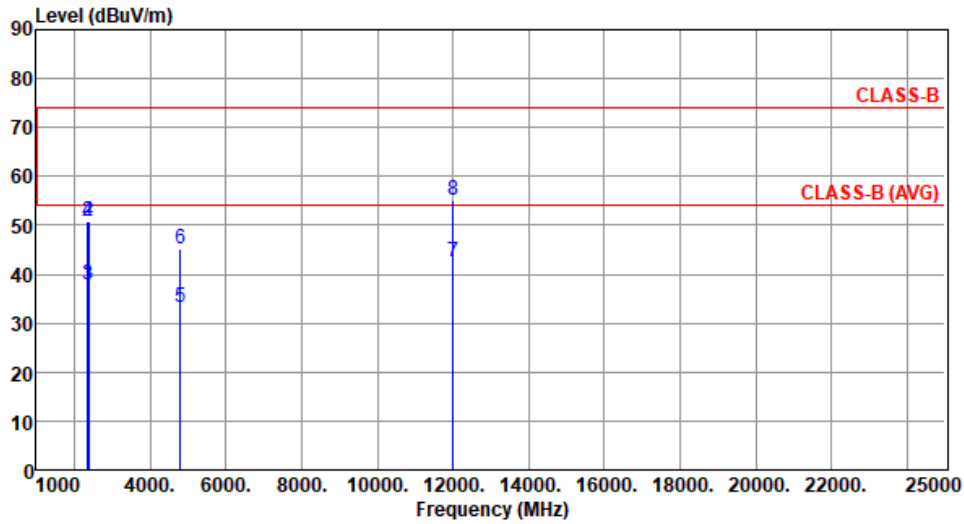

	Freq. MHz	Emission level dBuV/m	Limit dBuV/m	Margin dB	SA reading dBuV	Factor dB/m	Remark	ANT High cm	Turn Table deg
1	2363.60	37.91	54.00	-16.09	40.58	-2.67	Average	100	295
2	2363.60	50.75	74.00	-23.25	53.42	-2.67	Peak	100	295
3	2390.00	37.84	54.00	-16.16	40.59	-2.75	Average	100	295
4	2390.00	50.94	74.00	-23.06	53.69	-2.75	Peak	100	295
5	4804.00	33.14	54.00	-20.86	29.01	4.13	Average	100	288
6	4804.00	45.11	74.00	-28.89	40.98	4.13	Peak	100	288
7	12010.00	42.67	54.00	-11.33	29.05	13.62	Average	100	50
8	12010.00	55.21	74.00	-18.79	41.59	13.62	Peak	100	50

Note 1: Emission Level (dBuV/m) = SA Reading (dBuV) + Factor* (dB/m)

*Factor includes antenna factor , cable loss and amplifier gain

Note 2: Margin (dB) = Emission level (dBuV/m) – Limit (dBuV/m).

Modulation	BT-LE (2Mbps)	Test Freq. (MHz)	2440
Polarization	Horizontal		

Test By :Roger Lu Temperature(°C):22 Humidity(%):65

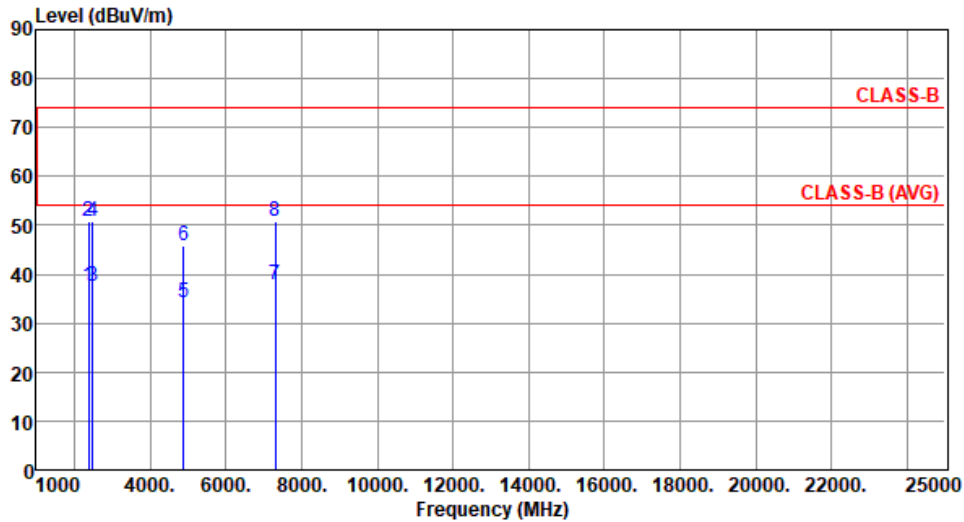

	Freq. MHz	Emission level dBuV/m	Limit dBuV/m	Margin dB	SA reading dBuV	Factor dB/m	Remark	ANT High cm	Turn Table deg
1	2390.00	37.50	54.00	-16.50	40.25	-2.75	Average	191	282
2	2390.00	50.70	74.00	-23.30	53.45	-2.75	Peak	191	282
3	2483.50	37.42	54.00	-16.58	40.12	-2.70	Average	191	282
4	2483.50	50.89	74.00	-23.11	53.59	-2.70	Peak	191	282
5	4880.00	34.27	54.00	-19.73	30.15	4.12	Average	100	225
6	4880.00	45.71	74.00	-28.29	41.59	4.12	Peak	100	225
7	7320.00	37.96	54.00	-16.04	28.68	9.28	Average	100	265
8	7320.00	50.73	74.00	-23.27	41.45	9.28	Peak	100	265

Note 1: Emission Level (dBuV/m) = SA Reading (dBuV) + Factor* (dB/m)

*Factor includes antenna factor , cable loss and amplifier gain

Note 2: Margin (dB) = Emission level (dBuV/m) – Limit (dBuV/m).

Modulation	BT-LE (2Mbps)	Test Freq. (MHz)	2440
Polarization	Vertical		

Test By :Roger Lu Temperature(°C):22 Humidity(%):65

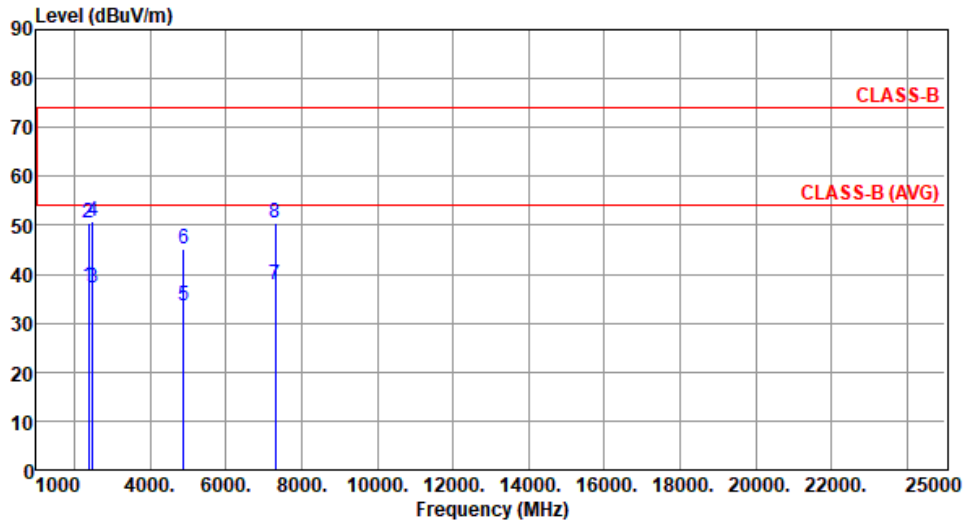

	Freq. MHz	Emission level dBuV/m	Limit dBuV/m	Margin dB	SA reading dBuV	Factor dB/m	Remark	ANT High cm	Turn Table deg
1	2390.00	37.40	54.00	-16.60	40.15	-2.75	Average	105	298
2	2390.00	50.58	74.00	-23.42	53.33	-2.75	Peak	105	298
3	2483.50	37.35	54.00	-16.65	40.05	-2.70	Average	105	298
4	2483.50	50.73	74.00	-23.27	53.43	-2.70	Peak	105	298
5	4880.00	33.68	54.00	-20.32	29.56	4.12	Average	100	285
6	4880.00	45.28	74.00	-28.72	41.16	4.12	Peak	100	285
7	7320.00	37.73	54.00	-16.27	28.45	9.28	Average	100	50
8	7320.00	50.40	74.00	-23.60	41.12	9.28	Peak	100	50

Note 1: Emission Level (dBuV/m) = SA Reading (dBuV) + Factor* (dB/m)

*Factor includes antenna factor , cable loss and amplifier gain

Note 2: Margin (dB) = Emission level (dBuV/m) – Limit (dBuV/m).

Modulation	BT-LE (2Mbps)	Test Freq. (MHz)	2480
Polarization	Horizontal		

Test By :Roger Lu Temperature(°C):22 Humidity(%):65

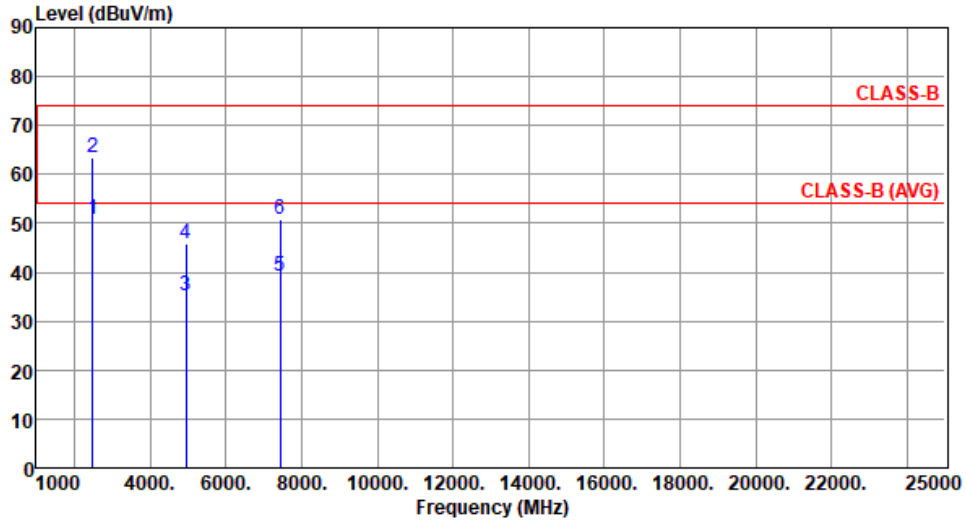

	Freq. MHz	Emission level dBuV/m	Limit dBuV/m	Margin dB	SA reading dBuV	Factor dB/m	Remark	ANT High cm	Turn Table deg
1	2483.50	50.78	54.00	-3.22	53.48	-2.70	Average	235	280
2	2483.50	63.37	74.00	-10.63	66.07	-2.70	Peak	235	280
3	4960.00	35.28	54.00	-18.72	31.25	4.03	Average	100	255
4	4960.00	45.71	74.00	-28.29	41.68	4.03	Peak	100	255
5	7440.00	39.16	54.00	-14.84	29.79	9.37	Average	100	265
6	7440.00	50.93	74.00	-23.07	41.56	9.37	Peak	100	265

Note 1: Emission Level (dBuV/m) = SA Reading (dBuV) + Factor* (dB/m)
 *Factor includes antenna factor , cable loss and amplifier gain
 Note 2: Margin (dB) = Emission level (dBuV/m) – Limit (dBuV/m).

Modulation	BT-LE (2Mbps)	Test Freq. (MHz)	2480
Polarization	Vertical		

Test By :Roger Lu Temperature(°C):22 Humidity(%):65

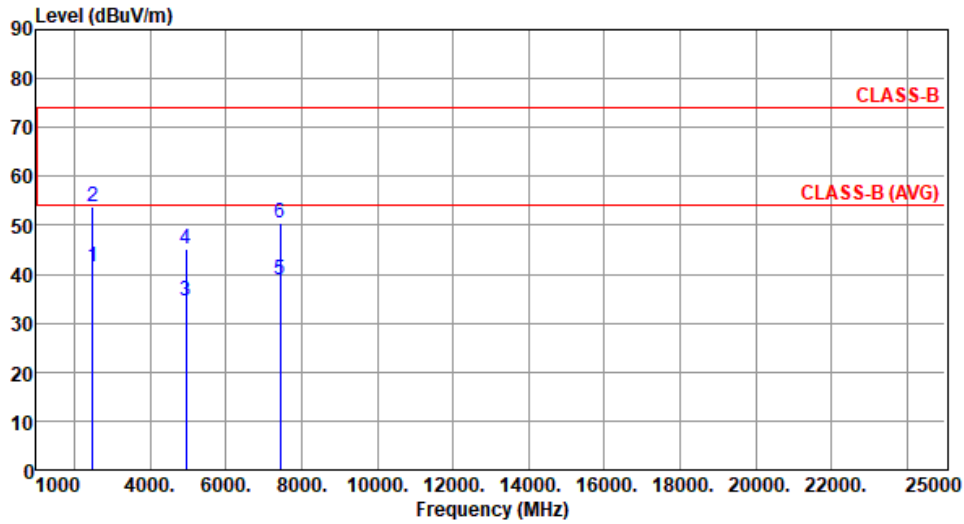

	Freq. MHz	Emission level dBuV/m	Limit dBuV/m	Margin dB	SA reading dBuV	Factor dB/m	Remark	ANT High cm	Turn Table deg
1	2483.50	41.56	54.00	-12.44	44.26	-2.70	Average	100	298
2	2483.50	53.89	74.00	-20.11	56.59	-2.70	Peak	100	298
3	4960.00	34.48	54.00	-19.52	30.45	4.03	Average	100	282
4	4960.00	45.16	74.00	-28.84	41.13	4.03	Peak	100	282
5	7440.00	38.93	54.00	-15.07	29.56	9.37	Average	100	50
6	7440.00	50.59	74.00	-23.41	41.22	9.37	Peak	100	50

Note 1: Emission Level (dBuV/m) = SA Reading (dBuV) + Factor* (dB/m)

*Factor includes antenna factor , cable loss and amplifier gain

Note 2: Margin (dB) = Emission level (dBuV/m) – Limit (dBuV/m).

3.6 Emissions in non-restricted Frequency Bands

3.6.1 Emissions in non-restricted frequency bands limit

Peak power in any 100 kHz bandwidth outside of the authorized frequency band shall be attenuated by at least 20 dB relative to the maximum in-band peak PSD level in 100 kHz

3.6.2 Test Procedures

Reference level measurement

1. Set RBW=100kHz, VBW = 300kHz , Detector = Peak, Sweep time = Auto
2. Trace = max hold , Allow Trace to fully stabilize
3. Use the peak marker function to determine the maximum PSD level

Emission level measurement

1. Set RBW=100kHz, VBW = 300kHz , Detector = Peak, Sweep time = Auto
2. Trace = max hold , Allow Trace to fully stabilize
3. Scan Frequency range is up to 25GHz
4. Use the peak marker function to determine the maximum amplitude level

3.6.3 Test Setup

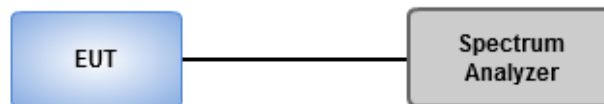

3.6.4 Test Result of Emissions in non-restricted Frequency Bands

Ambient Condition	20°C / 65%	Tested By	Aska Huang
-------------------	------------	-----------	------------

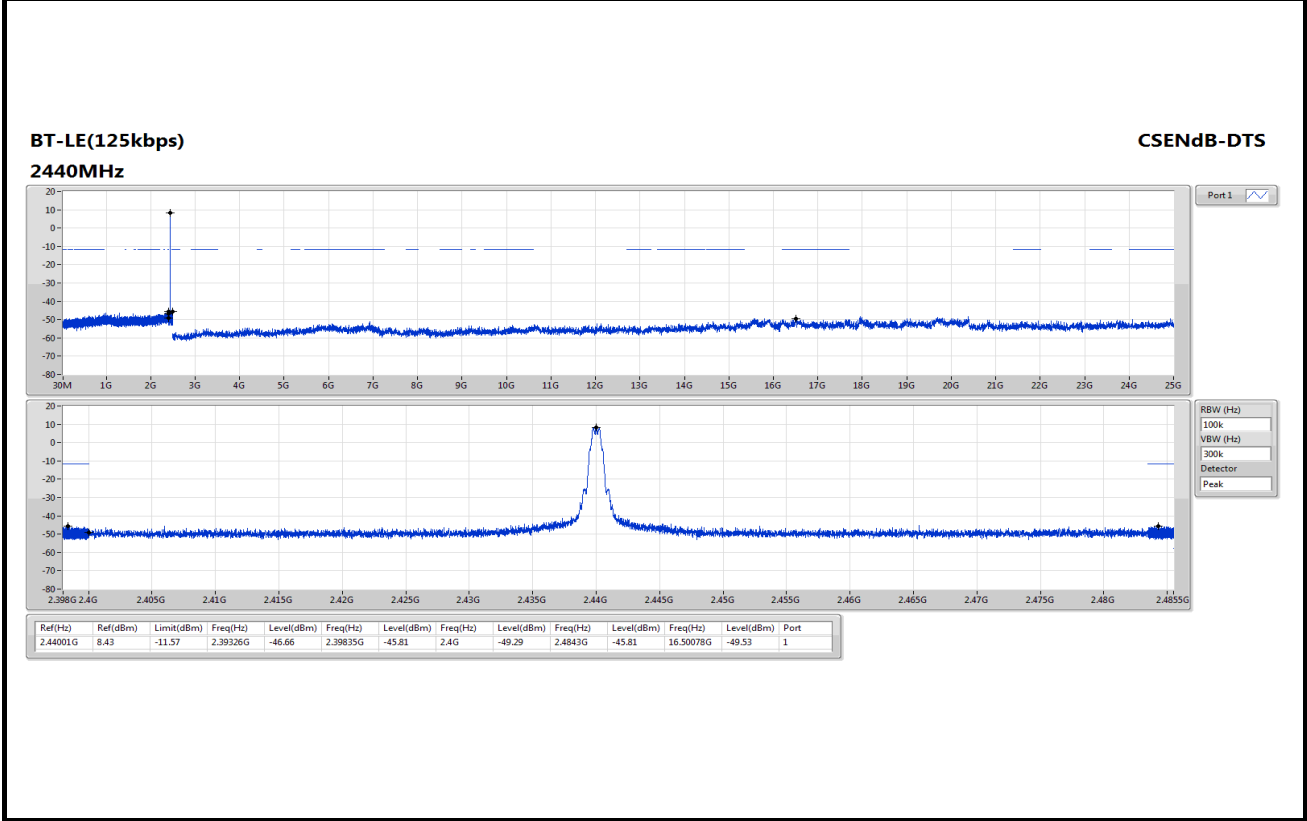
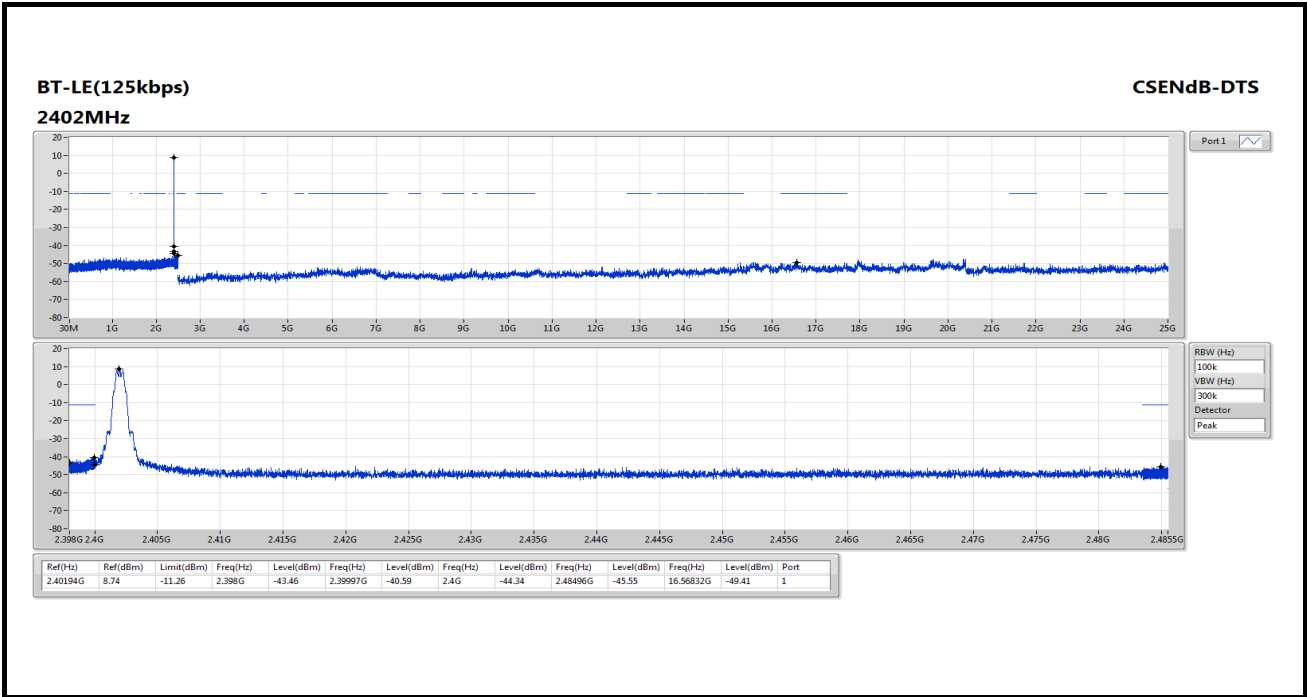

BT-LE(125kbps)
2480MHz

CSEndB-DTS

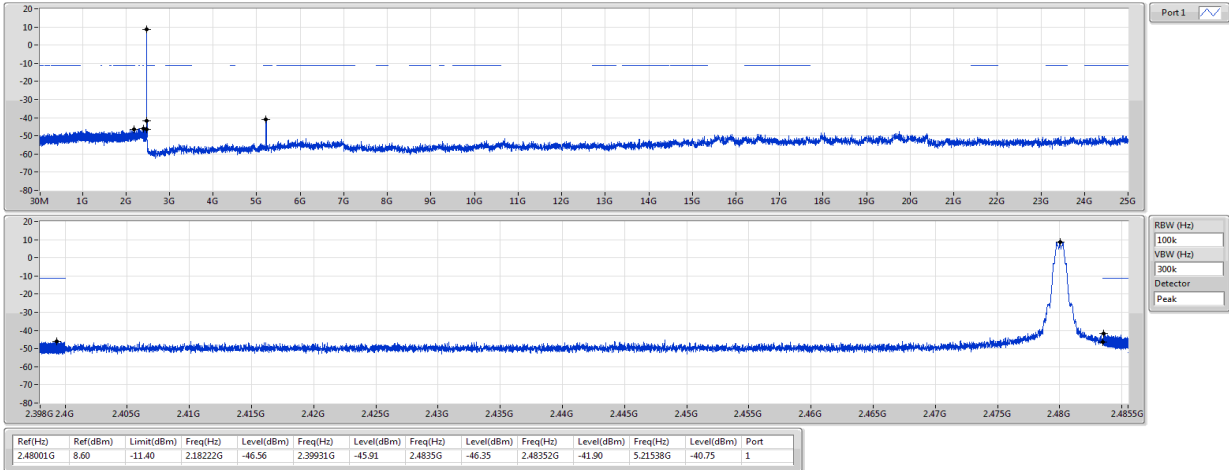

BT-LE(500kbps)
2402MHz

CSEndB-DTS

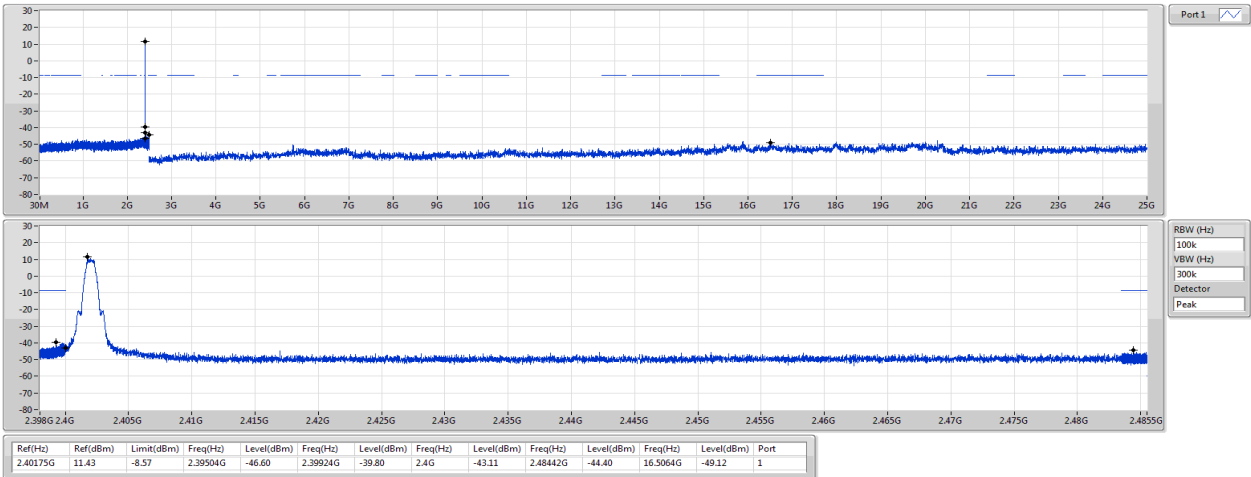

BT-LE(500kbps)
2440MHz

CSEndB-DTS

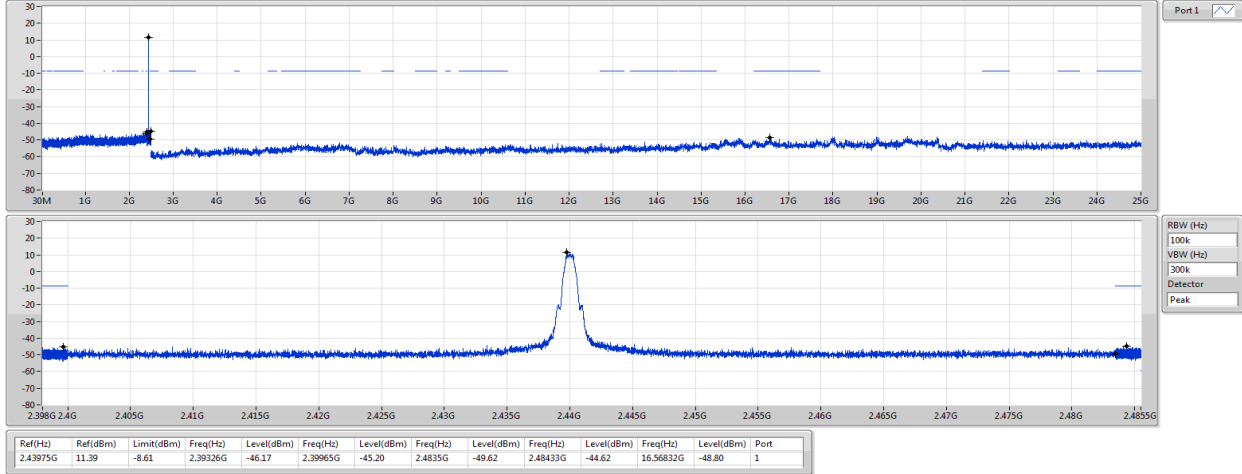

BT-LE(500kbps)
2480MHz

CSEndB-DTS

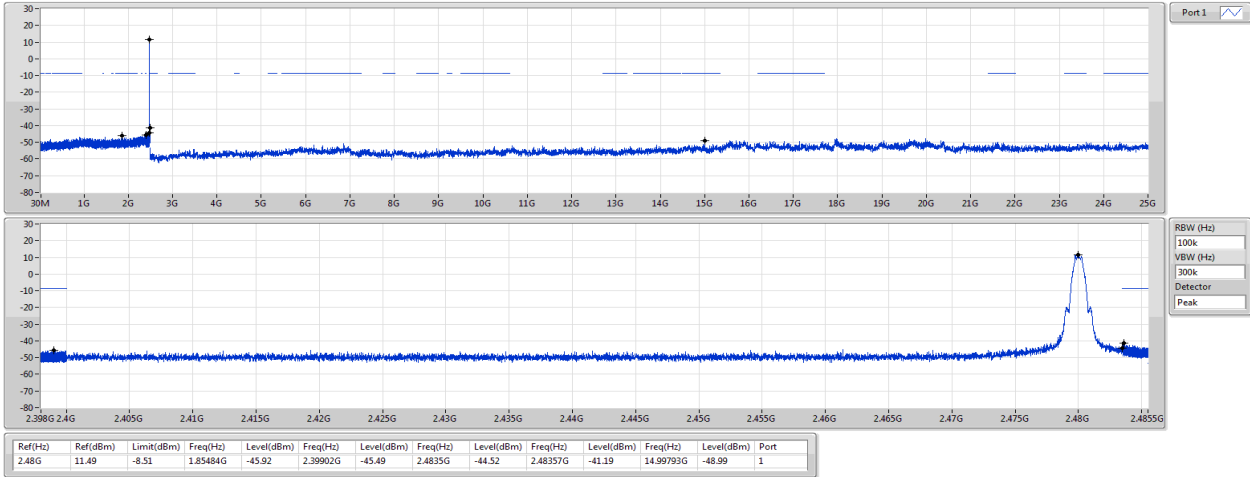

BT-LE(1Mbps)
2402MHz

CSEndB-DTS

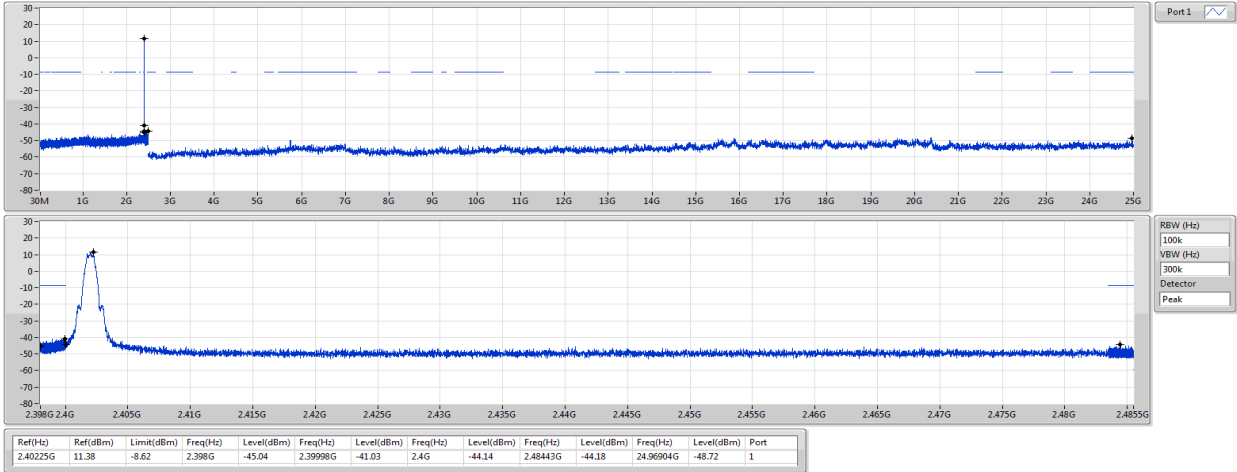

BT-LE(1Mbps)
2440MHz

CSEndB-DTS

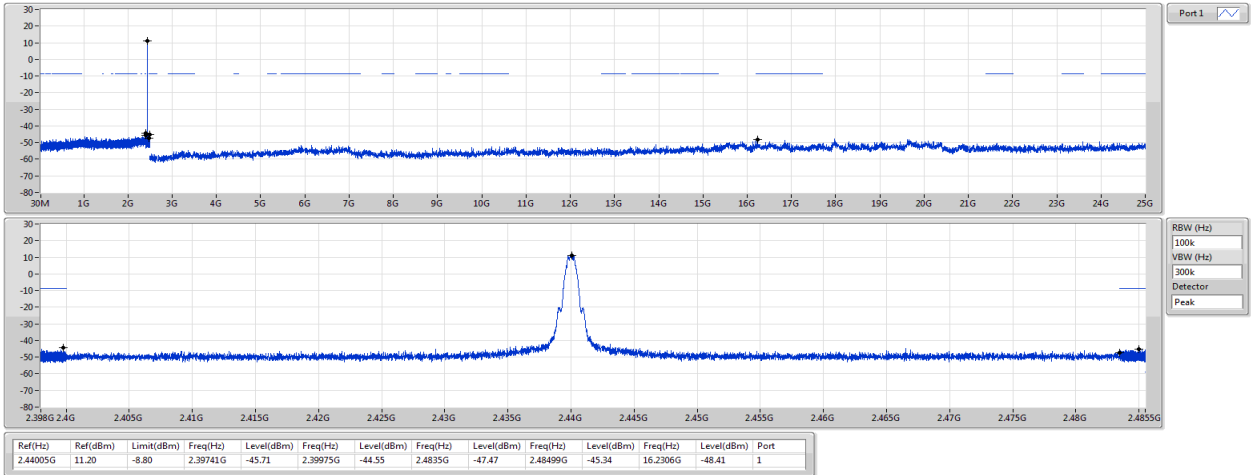

BT-LE(1Mbps)
2480MHz

CSEndB-DTS

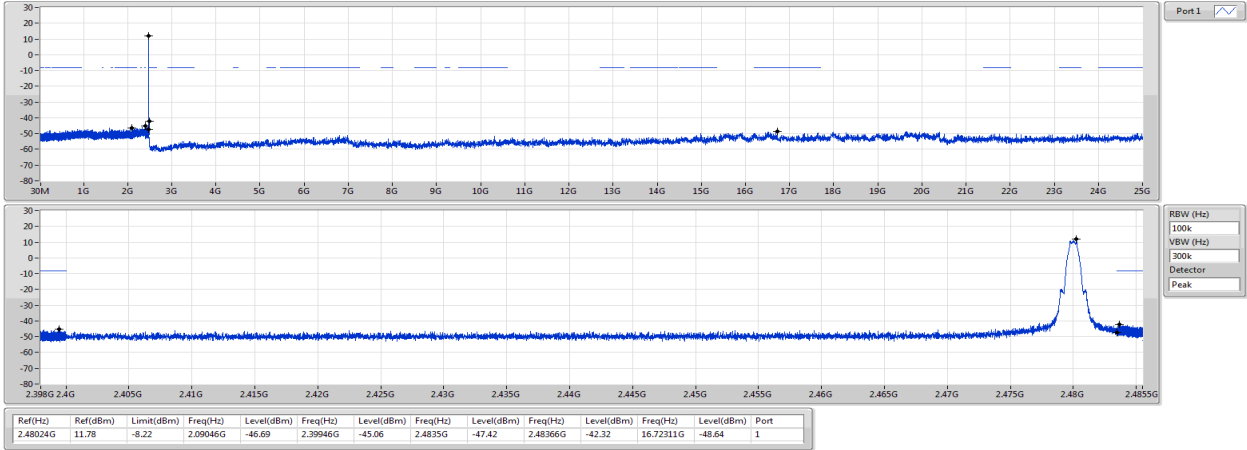

BT-LE(2Mbps)
2402MHz

CSEndB-DTS

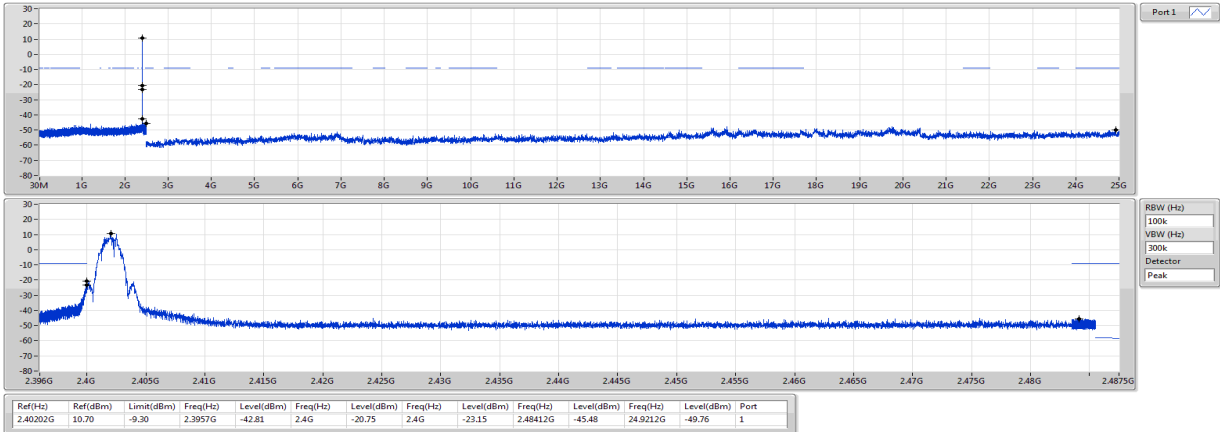

BT-LE(2Mbps)
2440MHz

CSEndB-DTS

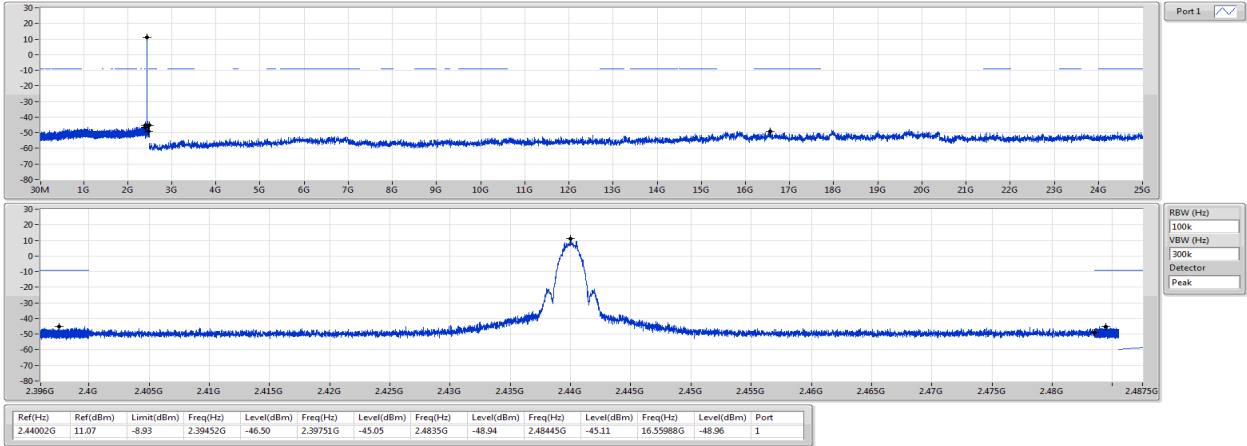

BT-LE(2Mbps)
2480MHz

CSEndB-DTS

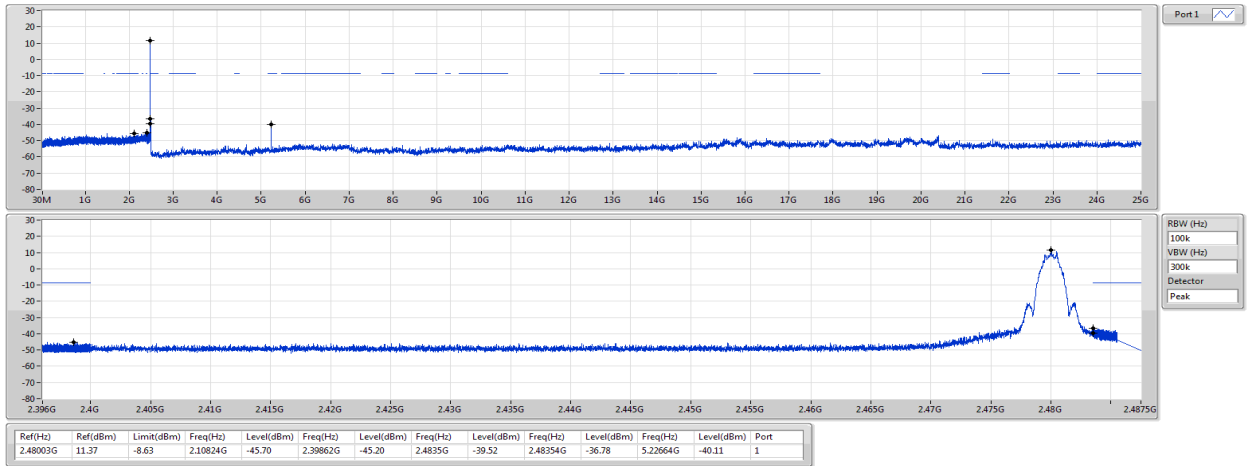

4 Test laboratory information

Established in 2012, ICC provides foremost EMC & RF Testing and advisory consultation services by our skilled engineers and technicians. Our services employ a wide variety of advanced edge test equipment and one of the widest certification extents in the business.

International Certification Corporation (EMC and Wireless Communication Laboratory), it is our definitive objective is to institute long term, trust-based associations with our clients. The expectation we set up with our clients is based on outstanding service, practical expertise and devotion to a certified value structure. Our passion is to grant our clients with best EMC / RF services by oriented knowledgeable and accommodating staff.

Our Test sites are located at Linkou District and Kwei Shan District. Location map can be found on our website <http://www.icertifi.com.tw>.

Linkou

Tel: 886-2-2601-1640

No.30-2, Ding Fwu Tsuen, Lin Kou
District, New Taipei City, Taiwan
(R.O.C.)

Kwei Shan

Tel: 886-3-271-8666

No.3-1, Lane 6, Wen San 3rd
St., Kwei Shan Dist., Tao Yuan
City 33381, Taiwan (R.O.C.)
No.2-1, Lane 6, Wen San 3rd
St., Kwei Shan Dist., Tao Yuan
City 33381, Taiwan (R.O.C.)

Kwei Shan Site II

Tel: 886-3-271-8640

No.14-1, Lane 19, Wen San 3rd
St., Kwei Shan Dist., Tao Yuan
City 333, Taiwan (R.O.C.)

If you have any suggestion, please feel free to contact us as below information.

Tel: 886-3-271-8666

Fax: 886-3-318-0345

Email: ICC_Service@icertifi.com.tw

==END==