

## FCC Test Report

**Report No.:** RF190225D05

**FCC ID:** P27RC8335PRO

**Test Model:** RC8335PRO

**Received Date:** Feb. 25, 2019

**Test Date:** Mar. 6 to 18, 2019

**Issued Date:** Mar. 22, 2019

**Applicant:** Sercomm Corp.

**Address:** 8F, No. 3-1, YuanQu St., NanKang, Taipei 115, Taiwan, R.O.C. (NanKang Software Park)

**Issued By:** Bureau Veritas Consumer Products Services (H.K.) Ltd., Taoyuan Branch

**Lab Address:** No. 47-2, 14th Ling, Chia Pau Vil., Lin Kou Dist., New Taipei City, Taiwan (R.O.C.)

**FCC Registration /  
Designation Number:** 198487 / TW2021



This report is for your exclusive use. Any copying or replication of this report to or for any other person or entity, or use of our name or trademark, is permitted only with our prior written permission. This report sets forth our findings solely with respect to the test samples identified herein. The results set forth in this report are not indicative or representative of the quality or characteristics of the lot from which a test sample was taken or any similar or identical product unless specifically and expressly noted. Our report includes all of the tests requested by you and the results thereof based upon the information that you provided to us. You have 60 days from date of issuance of this report to notify us of any material error or omission caused by our negligence, provided, however, that such notice shall be in writing and shall specifically address the issue you wish to raise. A failure to raise such issue within the prescribed time shall constitute your unqualified acceptance of the completeness of this report, the tests conducted and the correctness of the report contents. Unless specific mention, the uncertainty of measurement has been explicitly taken into account to declare the compliance or non-compliance to the specification. The report must not be used by the client to claim product certification, approval, or endorsement by TAF or any government agencies.

## Table of Contents

<b>Release Control Record</b> .....	<b>4</b>
<b>1 Certificate of Conformity</b> .....	<b>5</b>
<b>2 Summary of Test Results</b> .....	<b>6</b>
2.1 Measurement Uncertainty.....	6
2.2 Modification Record.....	6
<b>3 General Information</b> .....	<b>7</b>
3.1 General Description of EUT.....	7
3.2 Description of Test Modes.....	8
3.2.1 Test Mode Applicability and Tested Channel Detail.....	9
3.3 Duty Cycle of Test Signal.....	11
3.4 Description of Support Units.....	12
3.4.1 Configuration of System under Test.....	12
3.5 General Description of Applied Standards.....	12
<b>4 Test Types and Results</b> .....	<b>13</b>
4.1 Radiated Emission and Bandedge Measurement.....	13
4.1.1 Limits of Radiated Emission and Bandedge Measurement.....	13
4.1.2 Test Instruments.....	14
4.1.3 Test Procedures.....	15
4.1.4 Deviation from Test Standard.....	15
4.1.5 Test Setup.....	16
4.1.6 EUT Operating Conditions.....	17
4.1.7 Test Results.....	18
4.2 Conducted Emission Measurement.....	32
4.2.1 Limits of Conducted Emission Measurement.....	32
4.2.2 Test Instruments.....	32
4.2.3 Test Procedures.....	33
4.2.4 Deviation from Test Standard.....	33
4.2.5 Test Setup.....	33
4.2.6 EUT Operating Conditions.....	33
4.2.7 Test Results.....	34
4.3 6dB Bandwidth Measurement.....	36
4.3.1 Limits of 6dB Bandwidth Measurement.....	36
4.3.2 Test Setup.....	36
4.3.3 Test Instruments.....	36
4.3.4 Test Procedure.....	36
4.3.5 Deviation from Test Standard.....	36
4.3.6 EUT Operating Conditions.....	36
4.3.7 Test Result.....	37
4.4 Conducted Output Power Measurement.....	39
4.4.1 Limits of Conducted Output Power Measurement.....	39
4.4.2 Test Setup.....	39
4.4.3 Test Instruments.....	39
4.4.4 Test Procedures.....	39
4.4.5 Deviation from Test Standard.....	39
4.4.6 EUT Operating Conditions.....	39
4.4.7 Test Results.....	40
4.5 Power Spectral Density Measurement.....	42
4.5.1 Limits of Power Spectral Density Measurement.....	42
4.5.2 Test Setup.....	42
4.5.3 Test Instruments.....	42
4.5.4 Test Procedure.....	42
4.5.5 Deviation from Test Standard.....	42

4.5.6 EUT Operating Condition .....	42
4.5.7 Test Results .....	43
4.6 Conducted Out of Band Emission Measurement.....	45
4.6.1 Limits of Conducted Out of Band Emission Measurement .....	45
4.6.2 Test Setup.....	45
4.6.3 Test Instruments .....	45
4.6.4 Test Procedure .....	45
4.6.5 Deviation from Test Standard .....	45
4.6.6 EUT Operating Condition .....	45
4.6.7 Test Results .....	45
<b>5 Pictures of Test Arrangements.....</b>	<b>52</b>
<b>Appendix – Information of the Testing Laboratories .....</b>	<b>53</b>

### Release Control Record

Issue No.	Description	Date Issued
RF190225D05	Original release.	Mar. 22, 2019

## 1 Certificate of Conformity

**Product:** SmartThings Smart Camera, SmartThings Cam  
**Brand:** SmartThings, Sercomm  
**Test Model:** RC8335PRO  
**Sample Status:** Engineering sample  
**Applicant:** Sercomm Corp.  
**Test Date:** Mar. 6 to 18, 2019  
**Standards:** 47 CFR FCC Part 15, Subpart C (Section 15.247)  
ANSI C63.10: 2013

The above equipment has been tested by **Bureau Veritas Consumer Products Services (H.K.) Ltd., Taoyuan Branch**, and found compliance with the requirement of the above standards. The test record, data evaluation & Equipment Under Test (EUT) configurations represented herein are true and accurate accounts of the measurements of the sample's RF characteristics under the conditions specified in this report.

**Prepared by :** Annie Chang, **Date:** Mar. 22, 2019  
Annie Chang / Senior Specialist

**Approved by :** Rex Lai, **Date:** Mar. 22, 2019  
Rex Lai / Associate Technical Manager

## 2 Summary of Test Results

47 CFR FCC Part 15, Subpart C (Section 15.247)			
FCC Clause	Test Item	Result	Remarks
15.207	AC Power Conducted Emission	PASS	Meet the requirement of limit. Minimum passing margin is -10.66dB at 0.16172MHz.
15.205 / 15.209 / 15.247(d)	Radiated Emissions and Band Edge Measurement	PASS	Meet the requirement of limit. Minimum passing margin is -1.02dB at 2483.50MHz.
15.247(d)	Antenna Port Emission	PASS	Meet the requirement of limit.
15.247(a)(2)	6dB bandwidth	PASS	Meet the requirement of limit.
15.247(b)	Conducted power	PASS	Meet the requirement of limit.
15.247(e)	Power Spectral Density	PASS	Meet the requirement of limit.
15.203	Antenna Requirement	PASS	Antenna connector is I-PEX not a standard connector.

**Note:**

Determining compliance based on the results of the compliance measurement, not taking into account measurement instrumentation uncertainty.

### 2.1 Measurement Uncertainty

Where relevant, the following measurement uncertainty levels have been estimated for tests performed on the EUT as specified in CISPR 16-4-2:

Measurement	Frequency	Expanded Uncertainty (k=2) (±)
Conducted Emissions at mains ports	150kHz ~ 30MHz	2.77 dB
Radiated Emissions up to 1 GHz	9kHz ~ 30MHz	2.38 dB
	30MHz ~ 1000MHz	5.54 dB
Radiated Emissions above 1 GHz	Above 1GHz	5.48 dB

### 2.2 Modification Record

There were no modifications required for compliance.

### 3 General Information

#### 3.1 General Description of EUT

Product	SmartThings Smart Camera, SmartThings Cam
Brand	SmartThings, Sercomm
Test Model	RC8335PRO
Status of EUT	Engineering sample
Power Supply Rating	DC 12V from Adapter
Modulation Type	CCK, DQPSK, DBPSK for DSSS 64QAM, 16QAM, QPSK, BPSK for OFDM
Modulation Technology	DSSS, OFDM
Transfer Rate	802.11b: up to 11Mbps 802.11g: up to 54Mbps 802.11n: up to 300Mbps
Operating Frequency	2.412 ~ 2.462GHz
Number of Channel	11 for 802.11b, 802.11g, 802.11n (20MHz) 7 for 802.11n (40MHz)
Output Power	732.906mW
Antenna Type	Ant.1: PCB dipole antenna with 2.60dBi gain Ant.2: PCB dipole antenna with 2.64dBi gain
Antenna Connector	I-PEX
Accessory Device	Adapter
Data Cable Supplied	N/A

Note:

1. The EUT provides 2 completed transmitters and 2 receivers.

Modulation Mode	TX Function
802.11b	1TX
802.11g	1TX
802.11n (20MHz)	2TX
802.11n (40MHz)	2TX

2. The EUT uses following adapter.

Brand	APD
Model	WB-12G12FU
Input Power	100-240V, 50-60Hz, 0.3A
Output Power	12V, 1A
Power Line	AC 2 Pin, Non-shielded DC cable (3.0m)

3. 2.4GHz & 5GHz technologies cannot transmit at same time.

4. The above EUT information is declared by manufacturer and for more detailed features description, please refer to the manufacturer's specifications or user's manual.

### 3.2 Description of Test Modes

11 channels are provided for 802.11b, 802.11g and 802.11n (20MHz):

Channel	Frequency	Channel	Frequency
1	2412MHz	7	2442MHz
2	2417MHz	8	2447MHz
3	2422MHz	9	2452MHz
4	2427MHz	10	2457MHz
5	2432MHz	11	2462MHz
6	2437MHz		

7 channels are provided for 802.11n (40MHz):

Channel	Frequency	Channel	Frequency
3	2422MHz	7	2442MHz
4	2427MHz	8	2447MHz
5	2432MHz	9	2452MHz
6	2437MHz		



### 3.2.1 Test Mode Applicability and Tested Channel Detail

EUT CONFIGURE MODE	APPLICABLE TO				DESCRIPTION
	RE $\geq$ 1G	RE $<$ 1G	PLC	APCM	
-	√	√	√	√	-

Where RE $\geq$ 1G: Radiated Emission above 1GHz & Bandedge Measurement  
 RE $<$ 1G: Radiated Emission below 1GHz  
 PLC: Power Line Conducted Emission  
 APCM: Antenna Port Conducted Measurement

**NOTE:** The EUT had been pre-tested on the positioned of each 2 axis. The worst case was found when positioned on **X-plane**.

#### **Radiated Emission Test (Above 1GHz):**

- Pre-Scan has been conducted to determine the worst-case mode from all possible combinations between available modulations, data rates and antenna ports (if EUT with antenna diversity architecture).
- Following channel(s) was (were) selected for the final test as listed below.

EUT Configure Mode	Mode	Available Channel	Tested Channel	Modulation Technology	Modulation Type	Data Rate (Mbps)
-	802.11b	1 to 11	1, 6, 11	DSSS	DBPSK	1
-	802.11g	1 to 11	1, 6, 11	OFDM	BPSK	6
-	802.11n (20MHz)	1 to 11	1, 6, 11	OFDM	BPSK	6.5
-	802.11n (40MHz)	3 to 9	3, 6, 9	OFDM	BPSK	13.5

#### **Radiated Emission Test (Below 1GHz):**

- Pre-Scan has been conducted to determine the worst-case mode from all possible combinations between available modulations, data rates and antenna ports (if EUT with antenna diversity architecture).
- Following channel(s) was (were) selected for the final test as listed below.

EUT Configure Mode	Mode	Available Channel	Tested Channel	Modulation Technology	Modulation Type	Data Rate (Mbps)
-	802.11b	1 to 11	6	DSSS	DBPSK	1

#### **Power Line Conducted Emission Test:**

- Pre-Scan has been conducted to determine the worst-case mode from all possible combinations between available modulations, data rates and antenna ports (if EUT with antenna diversity architecture).
- Following channel(s) was (were) selected for the final test as listed below.

EUT Configure Mode	Mode	Available Channel	Tested Channel	Modulation Technology	Modulation Type	Data Rate (Mbps)
-	802.11b	1 to 11	6	DSSS	DBPSK	1

**Antenna Port Conducted Measurement:**

- This item includes all test value of each mode, but only includes spectrum plot of worst value of each mode.
- Pre-Scan has been conducted to determine the worst-case mode from all possible combinations between available modulations, data rates and antenna ports (if EUT with antenna diversity architecture).
- Following channel(s) was (were) selected for the final test as listed below.

EUT Configure Mode	Mode	Available Channel	Tested Channel	Modulation Technology	Modulation Type	Data Rate (Mbps)
-	802.11b	1 to 11	1, 6, 11	DSSS	DBPSK	1
-	802.11g	1 to 11	1, 6, 11	OFDM	BPSK	6
-	802.11n (20MHz)	1 to 11	1, 6, 11	OFDM	BPSK	6.5
-	802.11n (40MHz)	3 to 9	3, 6, 9	OFDM	BPSK	13.5

**Test Condition:**

Applicable To	Environmental Conditions	Input Power	Tested By
<b>RE<math>\geq</math>1G</b>	24deg. C, 71%RH	120Vac, 60Hz	Ian Chang
<b>RE<math>&lt;</math>1G</b>	24deg. C, 71%RH	120Vac, 60Hz	Ian Chang
<b>PLC</b>	25deg. C, 75%RH	120Vac, 60Hz	Dalen Dai
<b>APCM</b>	25deg. C, 76%RH	120Vac, 60Hz	Saxon Lee

### 3.3 Duty Cycle of Test Signal

If duty cycle of test signal is  $\geq 98\%$ , duty factor is not required.  
 If duty cycle of test signal is  $< 98\%$ , duty factor shall be considered.

**802.11b:** Duty cycle =  $12.55/12.60 = 0.996$

**802.11g:** Duty cycle =  $2.087/2.222 = 0.939$ , Duty factor =  $10 * \log(1/0.939) = 0.27$

**802.11n (20MHz):** Duty cycle =  $1.936/2.034 = 0.952$ , Duty factor =  $10 * \log(1/0.952) = 0.21$

**802.11n (40MHz):** Duty cycle =  $0.957/1.029 = 0.930$ , Duty factor =  $10 * \log(1/0.930) = 0.32$

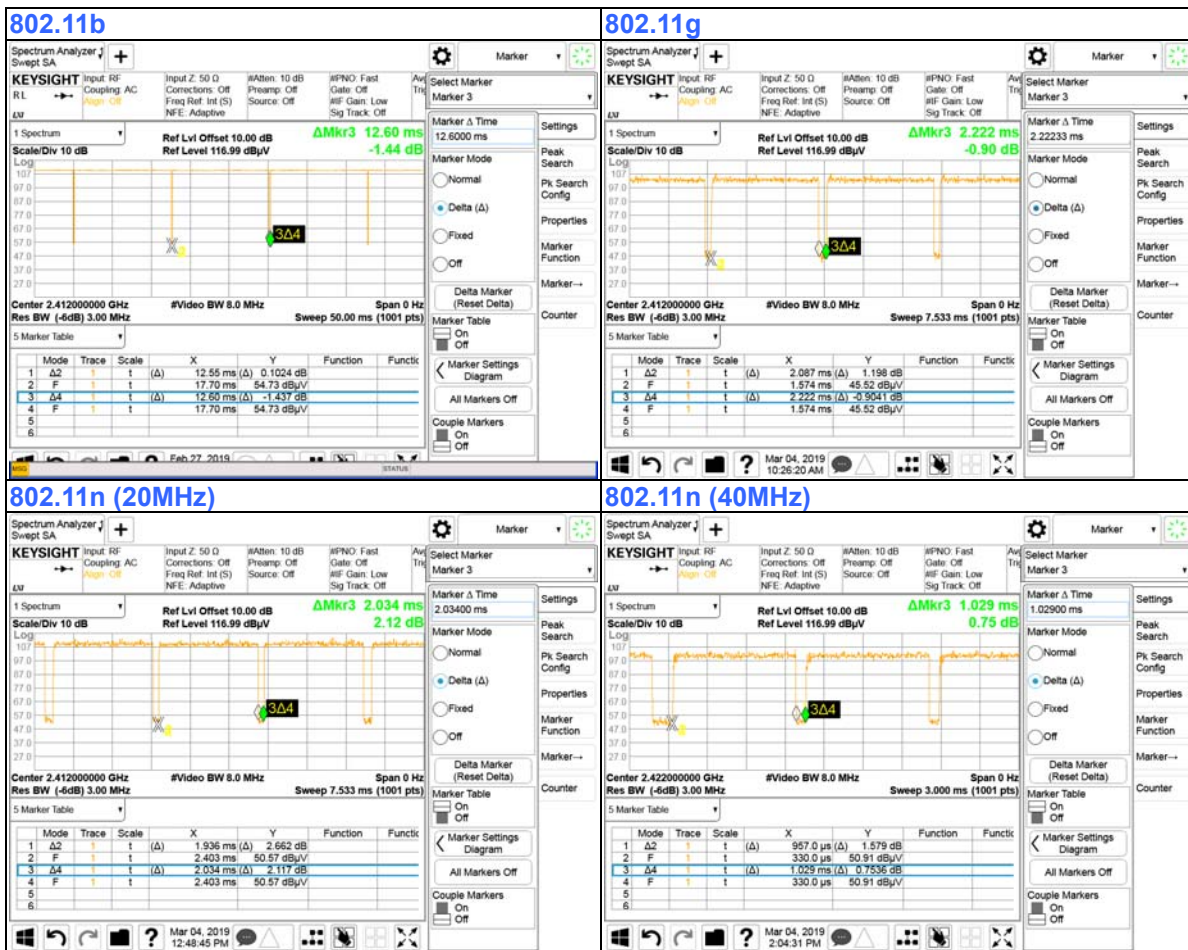

### 3.4 Description of Support Units

The EUT has been tested as an independent unit together with other necessary accessories or support units. The following support units or accessories were used to form a representative test configuration during the tests.

ID	Descriptions	Qty.	Length (m)	Shielding (Yes/No)	Cores (Qty.)	Remarks
1.	DC cable	1	3	N	0	Supplied by client

Note: The core(s) is(are) originally attached to the cable(s).

#### 3.4.1 Configuration of System under Test

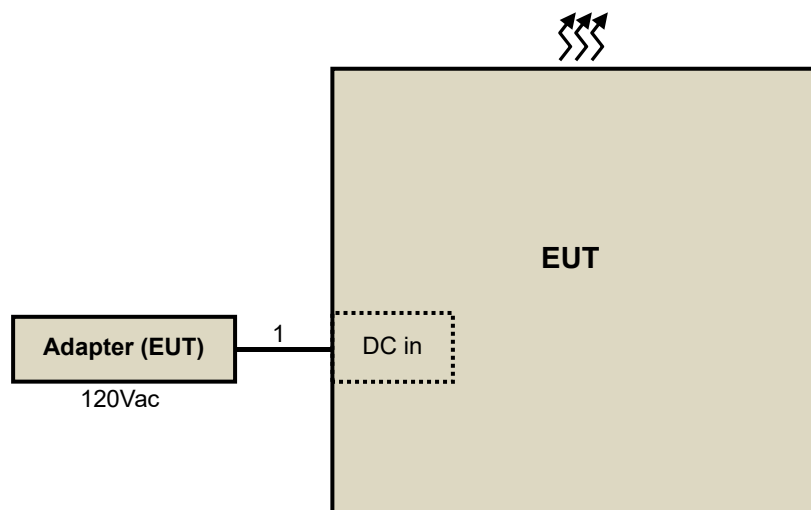

### 3.5 General Description of Applied Standards

The EUT is a RF Product. According to the specifications of the manufacturer, it must comply with the requirements of the following standards:

**FCC Part 15, Subpart C (15.247)**  
**KDB 558074 D01 15.247 Meas Guidance v05r01**  
**KDB 662911 D01 Multiple Transmitter Output v02r01**  
**ANSI C63.10-2013**

All test items have been performed and recorded as per the above standards.

## 4 Test Types and Results

### 4.1 Radiated Emission and Bandedge Measurement

#### 4.1.1 Limits of Radiated Emission and Bandedge Measurement

Radiated emissions which fall in the restricted bands must comply with the radiated emission limits specified as below table. Other emissions shall be at least 20dB below the highest level of the desired power:

Frequencies (MHz)	Field Strength (microvolts/meter)	Measurement Distance (meters)
0.009 ~ 0.490	2400/F(kHz)	300
0.490 ~ 1.705	24000/F(kHz)	30
1.705 ~ 30.0	30	30
30 ~ 88	100	3
88 ~ 216	150	3
216 ~ 960	200	3
Above 960	500	3

**NOTE:**

1. The lower limit shall apply at the transition frequencies.
2. Emission level (dBuV/m) = 20 log Emission level (uV/m).
3. For frequencies above 1000MHz, the field strength limits are based on average detector, however, the peak field strength of any emission shall not exceed the maximum permitted average limits, specified above by more than 20dB under any condition of modulation.

#### 4.1.2 Test Instruments

DESCRIPTION & MANUFACTURER	MODEL NO.	SERIAL NO.	CALIBRATED DATE	CALIBRATED UNTIL
HP Preamplifier	8447D	2432A03504	Feb. 20, 2019	Feb. 19, 2020
HP Preamplifier	8449B	3008A01201	Feb. 21, 2019	Feb. 20, 2020
MITEQ Preamplifier	AMF-6F-260400-33-8P	892164	Feb. 20, 2019	Feb. 19, 2020
Agilent TEST RECEIVER	N9038A	MY51210129	Mar. 05, 2019	Mar. 04, 2020
Schwarzbeck Antenna	VULB 9168	139	Nov. 26, 2018	Nov. 25, 2019
Schwarzbeck Antenna	VHBA 9123	480	May 19, 2017	May 18, 2019
Schwarzbeck Horn Antenna	BBHA-9170	212	Nov. 25, 2018	Nov. 24, 2019
Schwarzbeck Horn Antenna	BBHA 9120-D1	D130	Nov. 25, 2018	Nov. 24, 2019
ADT. Turn Table	TT100	0306	NA	NA
ADT. Tower	AT100	0306	NA	NA
Software	Radiated_V7.6.15.9.5	NA	NA	NA
SUHNER RF cable With 4dB PAD	SF102	Cable-CH6-01	Aug. 13, 2018	Aug. 12, 2019
SUHNER RF cable With 3/4dB PAD	SF102	Cable-CH8-3.6m	Aug. 13, 2018	Aug. 12, 2019
KEYSIGHT MIMO Powermeasurement Test set	U2021XA	U2021XA-001	Jun. 4, 2018	Jun. 3, 2019
KEYSIGHT Spectrum Analyzer	N9030A	MY54490260	Aug. 3, 2018	Aug. 2, 2019
Loop Antenna EMCI	LPA600	270	Aug. 11, 2017	Aug. 10, 2019
EMCO Horn Antenna	3115	00028257	Nov. 25, 2018	Nov. 24, 2019
Highpass filter Wainwright Instruments	WHK 3.1/18G-10SS	SN 8	NA	NA
ROHDE & SCHWARZ Spectrum Analyzer	FSV40	101042	Sep. 27, 2018	Sep. 26, 2019
Anritsu Power Sensor	MA2411B	0738404	Apr. 26, 2018	Apr. 25, 2019
Anritsu Power Meter	ML2495A	0842014	Apr. 26, 2018	Apr. 25, 2019

- NOTE:**
1. The calibration interval of the above test instruments is 12/24 months. And the calibrations are traceable to NML/ROC and NIST/USA.
  2. The horn antenna and HP preamplifier (model: 8449B) are used only for the measurement of emission frequency above 1GHz if tested.
  3. The test was performed in Chamber No. 6.
  4. The Industry Canada Reference No. IC 7450E-6.

#### 4.1.3 Test Procedures

##### **For Radiated emission below 30MHz**

- a. The EUT was placed on the top of a rotating table 0.8 meters above the ground at a 3 meter chamber room. The table was rotated 360 degrees to determine the position of the highest radiation.
- b. The EUT was set 3 meters away from the interference-receiving antenna, which was mounted on the top of a variable-height antenna tower.
- c. Parallel, perpendicular, and ground-parallel orientations of the antenna are set to make the measurement.
- d. For each suspected emission, the EUT was arranged to its worst case and the rotatable table was turned from 0 degrees to 360 degrees to find the maximum reading.
- e. The test-receiver system was set to Quasi-Peak Detect Function and Specified Bandwidth with Maximum Hold Mode.

##### **NOTE:**

1. The resolution bandwidth and video bandwidth of test receiver/spectrum analyzer is 9kHz at frequency below 30MHz.

##### **For Radiated emission above 30MHz**

- a. The EUT was placed on the top of a rotating table 0.8 meters (for 30MHz ~ 1GHz) / 1.5 meters (for above 1GHz) above the ground at 3 meter chamber room for test. The table was rotated 360 degrees to determine the position of the highest radiation.
- b. The EUT was set 3 meters away from the interference-receiving antenna, which was mounted on the top of a variable-height antenna tower.
- c. The height of antenna is varied from one meter to four meters above the ground to determine the maximum value of the field strength. Both horizontal and vertical polarizations of the antenna are set to make the measurement.
- d. For each suspected emission, the EUT was arranged to its worst case and then the antenna was tuned to heights from 1 meter to 4 meters and the rotatable table was turned from 0 degrees to 360 degrees to find the maximum reading.
- e. The test-receiver system was set to quasi-peak detect function and specified bandwidth with maximum hold mode when the test frequency is below 1 GHz.
- f. The test-receiver system was set to peak and average detects function and specified bandwidth with maximum hold mode when the test frequency is above 1 GHz. If the peak reading value also meets average limit, measurement with the average detector is unnecessary.

##### **Note:**

1. The resolution bandwidth and video bandwidth of test receiver/spectrum analyzer is 120kHz for Quasi-peak detection (QP) at frequency below 1GHz.
2. The resolution bandwidth of test receiver/spectrum analyzer is 1 MHz and the video bandwidth is 3 MHz for Peak detection (PK) at frequency above 1GHz.
3. The resolution bandwidth of test receiver/spectrum analyzer is 1MHz and the video bandwidth is  $\geq 1/T$  (Duty cycle < 98%) or 10Hz (Duty cycle  $\geq 98\%$ ) for Average detection (AV) at frequency above 1GHz.
4. All modes of operation were investigated and the worst-case emissions are reported.

#### 4.1.4 Deviation from Test Standard

No deviation.

#### 4.1.5 Test Setup

##### For Radiated emission below 30MHz

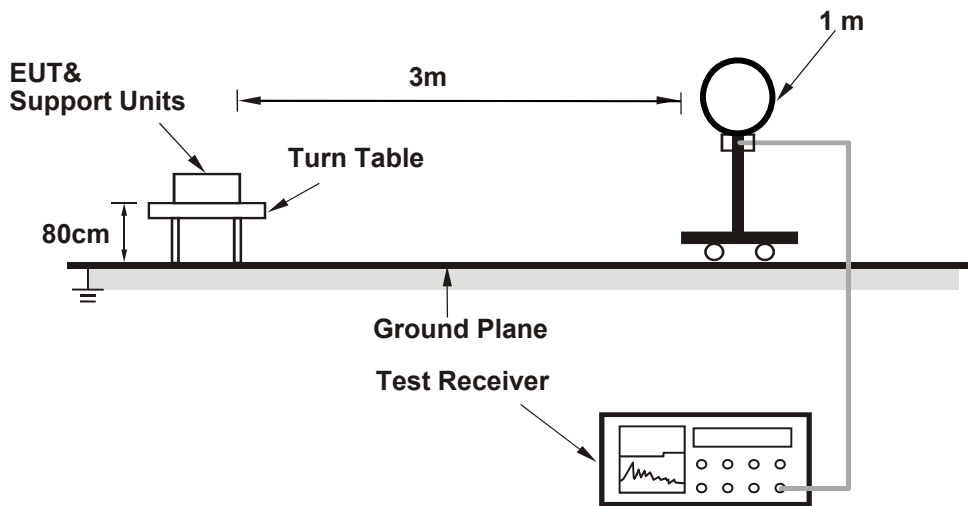

##### For Radiated emission 30MHz to 1GHz

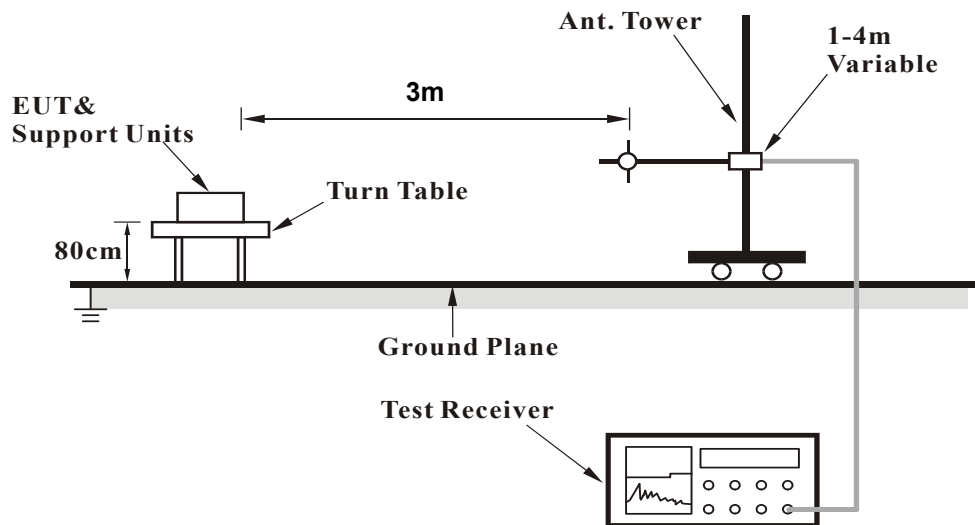



**For Radiated emission above 1GHz**

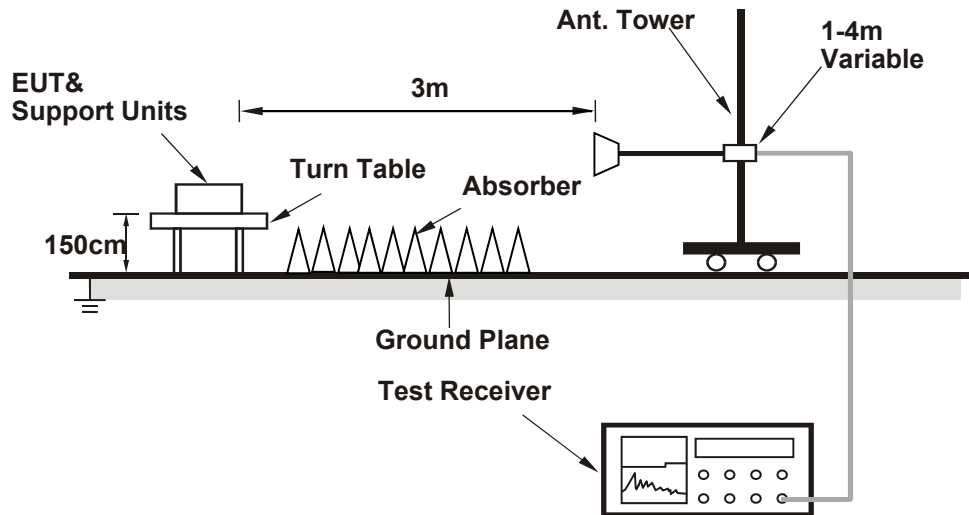

For the actual test configuration, please refer to the attached file (Test Setup Photo).

**4.1.6 EUT Operating Conditions**

Set the EUT under transmission condition continuously at specific channel frequency.

4.1.7 Test Results

Above 1GHz Data :

802.11b

<b>CHANNEL</b>	TX Channel 1	<b>DETECTOR FUNCTION</b>	Peak (PK)
<b>FREQUENCY RANGE</b>	1GHz ~ 25GHz		Average (AV)

ANTENNA POLARITY & TEST DISTANCE: HORIZONTAL AT 3 M								
NO.	FREQ. (MHz)	EMISSION LEVEL (dBuV/m)	LIMIT (dBuV/m)	MARGIN (dB)	ANTENNA HEIGHT (m)	TABLE ANGLE (Degree)	RAW VALUE (dBuV)	CORRECTION FACTOR (dB/m)
1	2390.00	62.35 PK	74.00	-11.65	2.86 H	83	62.57	-0.22
2	2390.00	52.92 AV	54.00	-1.08	2.86 H	83	53.14	-0.22
3	*2412.00	112.18 PK			2.86 H	83	112.39	-0.21
4	*2412.00	108.49 AV			2.86 H	83	108.70	-0.21
5	4824.00	54.50 PK	74.00	-19.50	3.36 H	212	48.12	6.38
6	4824.00	50.65 AV	54.00	-3.35	3.36 H	212	44.27	6.38

ANTENNA POLARITY & TEST DISTANCE: VERTICAL AT 3 M								
NO.	FREQ. (MHz)	EMISSION LEVEL (dBuV/m)	LIMIT (dBuV/m)	MARGIN (dB)	ANTENNA HEIGHT (m)	TABLE ANGLE (Degree)	RAW VALUE (dBuV)	CORRECTION FACTOR (dB/m)
1	2390.00	61.16 PK	74.00	-12.84	1.00 V	35	61.38	-0.22
2	2390.00	52.54 AV	54.00	-1.46	1.00 V	35	52.76	-0.22
3	*2412.00	105.50 PK			1.00 V	35	105.71	-0.21
4	*2412.00	102.56 AV			1.00 V	35	102.77	-0.21
5	4824.00	53.70 PK	74.00	-20.30	1.96 V	101	47.32	6.38
6	4824.00	49.42 AV	54.00	-4.58	1.96 V	101	43.04	6.38

**REMARKS:**

1. Emission Level(dBuV/m) = Raw Value(dBuV) + Correction Factor(dB/m)
2. Correction Factor(dB/m) = Antenna Factor(dB/m) + Cable Factor(dB) – Pre-Amplifier Factor(dB)
3. Margin value = Emission Level – Limit value
4. The other emission levels were very low against the limit.
5. " \* ": Fundamental frequency.

<b>CHANNEL</b>	TX Channel 6	<b>DETECTOR FUNCTION</b>	Peak (PK)
<b>FREQUENCY RANGE</b>	1GHz ~ 25GHz		Average (AV)

**ANTENNA POLARITY & TEST DISTANCE: HORIZONTAL AT 3 M**

NO.	FREQ. (MHz)	EMISSION LEVEL (dBuV/m)	LIMIT (dBuV/m)	MARGIN (dB)	ANTENNA HEIGHT (m)	TABLE ANGLE (Degree)	RAW VALUE (dBuV)	CORRECTION FACTOR (dB/m)
1	*2437.00	113.38 PK			2.77 H	92	113.58	-0.20
2	*2437.00	109.22 AV			2.77 H	92	109.42	-0.20
3	4874.00	55.54 PK	74.00	-18.46	2.81 H	241	49.36	6.18
4	4874.00	52.92 AV	54.00	-1.08	2.81 H	241	46.74	6.18

**ANTENNA POLARITY & TEST DISTANCE: VERTICAL AT 3 M**

NO.	FREQ. (MHz)	EMISSION LEVEL (dBuV/m)	LIMIT (dBuV/m)	MARGIN (dB)	ANTENNA HEIGHT (m)	TABLE ANGLE (Degree)	RAW VALUE (dBuV)	CORRECTION FACTOR (dB/m)
1	*2437.00	106.67 PK			1.03 V	42	106.87	-0.20
2	*2437.00	103.52 AV			1.03 V	42	103.72	-0.20
3	4874.00	54.13 PK	74.00	-19.87	1.88 V	116	47.95	6.18
4	4874.00	50.36 AV	54.00	-3.64	1.88 V	116	44.18	6.18

**REMARKS:**

1. Emission Level(dBuV/m) = Raw Value(dBuV) + Correction Factor(dB/m)
2. Correction Factor(dB/m) = Antenna Factor(dB/m) + Cable Factor(dB) – Pre-Amplifier Factor(dB)
3. Margin value = Emission Level – Limit value
4. The other emission levels were very low against the limit.
5. " \* ": Fundamental frequency.

<b>CHANNEL</b>	TX Channel 11	<b>DETECTOR FUNCTION</b>	Peak (PK)
<b>FREQUENCY RANGE</b>	1GHz ~ 25GHz		Average (AV)

**ANTENNA POLARITY & TEST DISTANCE: HORIZONTAL AT 3 M**

NO.	FREQ. (MHz)	EMISSION LEVEL (dBuV/m)	LIMIT (dBuV/m)	MARGIN (dB)	ANTENNA HEIGHT (m)	TABLE ANGLE (Degree)	RAW VALUE (dBuV)	CORRECTION FACTOR (dB/m)
1	*2462.00	112.51 PK			2.76 H	74	112.69	-0.18
2	*2462.00	108.79 AV			2.76 H	74	108.97	-0.18
3	2483.50	62.34 PK	74.00	-11.66	2.76 H	74	62.50	-0.16
4	2483.50	49.91 AV	54.00	-4.09	2.76 H	74	50.07	-0.16
5	4924.00	54.78 PK	74.00	-19.22	2.93 H	227	48.67	6.11
6	4924.00	52.42 AV	54.00	-1.58	2.93 H	227	46.31	6.11

**ANTENNA POLARITY & TEST DISTANCE: VERTICAL AT 3 M**

NO.	FREQ. (MHz)	EMISSION LEVEL (dBuV/m)	LIMIT (dBuV/m)	MARGIN (dB)	ANTENNA HEIGHT (m)	TABLE ANGLE (Degree)	RAW VALUE (dBuV)	CORRECTION FACTOR (dB/m)
1	*2462.00	105.95 PK			1.12 V	51	106.13	-0.18
2	*2462.00	104.02 AV			1.12 V	51	104.20	-0.18
3	2483.50	61.17 PK	74.00	-12.83	1.12 V	51	61.33	-0.16
4	2483.50	48.76 AV	54.00	-5.24	1.12 V	51	48.92	-0.16
5	4924.00	53.07 PK	74.00	-20.93	1.85 V	107	46.96	6.11
6	4924.00	49.29 AV	54.00	-4.71	1.85 V	107	43.18	6.11

**REMARKS:**

1. Emission Level(dBuV/m) = Raw Value(dBuV) + Correction Factor(dB/m)
2. Correction Factor(dB/m) = Antenna Factor(dB/m) + Cable Factor(dB) – Pre-Amplifier Factor(dB)
3. Margin value = Emission Level – Limit value
4. The other emission levels were very low against the limit.
5. " \* ": Fundamental frequency.

802.11g

<b>CHANNEL</b>	TX Channel 1	<b>DETECTOR FUNCTION</b>	Peak (PK)
<b>FREQUENCY RANGE</b>	1GHz ~ 25GHz		Average (AV)

**ANTENNA POLARITY & TEST DISTANCE: HORIZONTAL AT 3 M**

NO.	FREQ. (MHz)	EMISSION LEVEL (dBuV/m)	LIMIT (dBuV/m)	MARGIN (dB)	ANTENNA HEIGHT (m)	TABLE ANGLE (Degree)	RAW VALUE (dBuV)	CORRECTION FACTOR (dB/m)
1	2390.00	72.34 PK	74.00	-1.66	2.86 H	80	72.56	-0.22
2	2390.00	51.96 AV	54.00	-2.04	2.86 H	80	52.18	-0.22
3	*2412.00	110.52 PK			2.86 H	80	110.73	-0.21
4	*2412.00	100.21 AV			2.86 H	80	100.42	-0.21
5	4824.00	48.00 PK	74.00	-26.00	3.14 H	223	41.62	6.38
6	4824.00	34.51 AV	54.00	-19.49	3.14 H	223	28.13	6.38

**ANTENNA POLARITY & TEST DISTANCE: VERTICAL AT 3 M**

NO.	FREQ. (MHz)	EMISSION LEVEL (dBuV/m)	LIMIT (dBuV/m)	MARGIN (dB)	ANTENNA HEIGHT (m)	TABLE ANGLE (Degree)	RAW VALUE (dBuV)	CORRECTION FACTOR (dB/m)
1	2390.00	64.36 PK	74.00	-9.64	1.00 V	34	64.58	-0.22
2	2390.00	44.75 AV	54.00	-9.25	1.00 V	34	44.97	-0.22
3	*2412.00	102.60 PK			1.00 V	34	102.81	-0.21
4	*2412.00	92.32 AV			1.00 V	34	92.53	-0.21
5	4824.00	47.30 PK	74.00	-26.70	1.67 V	155	40.92	6.38
6	4824.00	34.06 AV	54.00	-19.94	1.67 V	155	27.68	6.38

**REMARKS:**

1. Emission Level(dBuV/m) = Raw Value(dBuV) + Correction Factor(dB/m)
2. Correction Factor(dB/m) = Antenna Factor(dB/m) + Cable Factor(dB) – Pre-Amplifier Factor(dB)
3. Margin value = Emission Level – Limit value
4. The other emission levels were very low against the limit.
5. " \* ": Fundamental frequency.

<b>CHANNEL</b>	TX Channel 6	<b>DETECTOR FUNCTION</b>	Peak (PK)
<b>FREQUENCY RANGE</b>	1GHz ~ 25GHz		Average (AV)

**ANTENNA POLARITY & TEST DISTANCE: HORIZONTAL AT 3 M**

NO.	FREQ. (MHz)	EMISSION LEVEL (dBuV/m)	LIMIT (dBuV/m)	MARGIN (dB)	ANTENNA HEIGHT (m)	TABLE ANGLE (Degree)	RAW VALUE (dBuV)	CORRECTION FACTOR (dB/m)
1	2390.00	63.28 PK	74.00	-10.72	2.10 H	97	63.50	-0.22
2	2390.00	46.34 AV	54.00	-7.66	2.10 H	97	46.56	-0.22
3	*2437.00	113.35 PK			2.10 H	97	113.55	-0.20
4	*2437.00	103.98 AV			2.10 H	97	104.18	-0.20
5	2483.50	71.34 PK	74.00	-2.66	2.10 H	97	71.50	-0.16
6	2483.50	52.90 AV	54.00	-1.10	2.10 H	97	53.06	-0.16
7	4874.00	54.46 PK	74.00	-19.54	2.70 H	245	48.28	6.18
8	4874.00	41.35 AV	54.00	-12.65	2.70 H	245	35.17	6.18

**ANTENNA POLARITY & TEST DISTANCE: VERTICAL AT 3 M**

NO.	FREQ. (MHz)	EMISSION LEVEL (dBuV/m)	LIMIT (dBuV/m)	MARGIN (dB)	ANTENNA HEIGHT (m)	TABLE ANGLE (Degree)	RAW VALUE (dBuV)	CORRECTION FACTOR (dB/m)
1	2390.00	58.42 PK	74.00	-15.58	1.06 V	43	58.64	-0.22
2	2390.00	44.90 AV	54.00	-9.10	1.06 V	43	45.12	-0.22
3	*2437.00	104.98 PK			1.06 V	43	105.18	-0.20
4	*2437.00	95.69 AV			1.06 V	43	95.89	-0.20
5	2483.50	65.32 PK	74.00	-8.68	1.06 V	43	65.48	-0.16
6	2483.50	47.95 AV	54.00	-6.05	1.06 V	43	48.11	-0.16
7	4874.00	53.52 PK	74.00	-20.48	1.75 V	136	47.34	6.18
8	4874.00	40.09 AV	54.00	-13.91	1.75 V	136	33.91	6.18

**REMARKS:**

1. Emission Level(dBuV/m) = Raw Value(dBuV) + Correction Factor(dB/m)
2. Correction Factor(dB/m) = Antenna Factor(dB/m) + Cable Factor(dB) – Pre-Amplifier Factor(dB)
3. Margin value = Emission Level – Limit value
4. The other emission levels were very low against the limit.
5. " \* ": Fundamental frequency.

<b>CHANNEL</b>	TX Channel 11	<b>DETECTOR FUNCTION</b>	Peak (PK)
<b>FREQUENCY RANGE</b>	1GHz ~ 25GHz		Average (AV)

**ANTENNA POLARITY & TEST DISTANCE: HORIZONTAL AT 3 M**

NO.	FREQ. (MHz)	EMISSION LEVEL (dBuV/m)	LIMIT (dBuV/m)	MARGIN (dB)	ANTENNA HEIGHT (m)	TABLE ANGLE (Degree)	RAW VALUE (dBuV)	CORRECTION FACTOR (dB/m)
1	*2462.00	109.46 PK			2.77 H	81	109.64	-0.18
2	*2462.00	99.32 AV			2.77 H	81	99.50	-0.18
<b>3</b>	<b>2483.50</b>	<b>72.98 PK</b>	<b>74.00</b>	<b>-1.02</b>	<b>2.77 H</b>	<b>81</b>	<b>73.14</b>	<b>-0.16</b>
4	2483.50	51.58 AV	54.00	-2.42	2.77 H	81	51.74	-0.16
5	4924.00	47.54 PK	74.00	-26.46	3.02 H	235	41.43	6.11
6	4924.00	34.17 AV	54.00	-19.83	3.02 H	235	28.06	6.11

**ANTENNA POLARITY & TEST DISTANCE: VERTICAL AT 3 M**

NO.	FREQ. (MHz)	EMISSION LEVEL (dBuV/m)	LIMIT (dBuV/m)	MARGIN (dB)	ANTENNA HEIGHT (m)	TABLE ANGLE (Degree)	RAW VALUE (dBuV)	CORRECTION FACTOR (dB/m)
1	*2462.00	102.09 PK			1.01 V	55	102.27	-0.18
2	*2462.00	91.97 AV			1.01 V	55	92.15	-0.18
3	2483.50	67.97 PK	74.00	-6.03	1.01 V	55	68.13	-0.16
4	2483.50	47.76 AV	54.00	-6.24	1.01 V	55	47.92	-0.16
5	4924.00	46.89 PK	74.00	-27.11	1.84 V	122	40.78	6.11
6	4924.00	33.64 AV	54.00	-20.36	1.84 V	122	27.53	6.11

**REMARKS:**

1. Emission Level(dBuV/m) = Raw Value(dBuV) + Correction Factor(dB/m)
2. Correction Factor(dB/m) = Antenna Factor(dB/m) + Cable Factor(dB) – Pre-Amplifier Factor(dB)
3. Margin value = Emission Level – Limit value
4. The other emission levels were very low against the limit.
5. " \* ": Fundamental frequency.

802.11n (20MHz)

<b>CHANNEL</b>	TX Channel 1	<b>DETECTOR FUNCTION</b>	Peak (PK)
<b>FREQUENCY RANGE</b>	1GHz ~ 25GHz		Average (AV)

ANTENNA POLARITY & TEST DISTANCE: HORIZONTAL AT 3 M								
NO.	FREQ. (MHz)	EMISSION LEVEL (dBuV/m)	LIMIT (dBuV/m)	MARGIN (dB)	ANTENNA HEIGHT (m)	TABLE ANGLE (Degree)	RAW VALUE (dBuV)	CORRECTION FACTOR (dB/m)
1	2390.00	71.91 PK	74.00	-2.09	2.85 H	84	72.13	-0.22
2	2390.00	52.43 AV	54.00	-1.57	2.85 H	84	52.65	-0.22
3	*2412.00	109.28 PK			2.85 H	84	109.49	-0.21
4	*2412.00	99.06 AV			2.85 H	84	99.27	-0.21
5	4824.00	47.88 PK	74.00	-26.12	3.27 H	220	41.50	6.38
6	4824.00	34.63 AV	54.00	-19.37	3.27 H	220	28.25	6.38

ANTENNA POLARITY & TEST DISTANCE: VERTICAL AT 3 M								
NO.	FREQ. (MHz)	EMISSION LEVEL (dBuV/m)	LIMIT (dBuV/m)	MARGIN (dB)	ANTENNA HEIGHT (m)	TABLE ANGLE (Degree)	RAW VALUE (dBuV)	CORRECTION FACTOR (dB/m)
1	2390.00	64.11 PK	74.00	-9.89	1.03 V	41	64.33	-0.22
2	2390.00	44.32 AV	54.00	-9.68	1.03 V	41	44.54	-0.22
3	*2412.00	101.56 PK			1.03 V	41	101.77	-0.21
4	*2412.00	91.42 AV			1.03 V	41	91.63	-0.21
5	4824.00	47.20 PK	74.00	-26.80	1.71 V	142	40.82	6.38
6	4824.00	33.89 AV	54.00	-20.11	1.71 V	142	27.51	6.38

**REMARKS:**

1. Emission Level(dBuV/m) = Raw Value(dBuV) + Correction Factor(dB/m)
2. Correction Factor(dB/m) = Antenna Factor(dB/m) + Cable Factor(dB) – Pre-Amplifier Factor(dB)
3. Margin value = Emission Level – Limit value
4. The other emission levels were very low against the limit.
5. " \* ": Fundamental frequency.



<b>CHANNEL</b>	TX Channel 6	<b>DETECTOR FUNCTION</b>	Peak (PK)
<b>FREQUENCY RANGE</b>	1GHz ~ 25GHz		Average (AV)

**ANTENNA POLARITY & TEST DISTANCE: HORIZONTAL AT 3 M**

NO.	FREQ. (MHz)	EMISSION LEVEL (dBuV/m)	LIMIT (dBuV/m)	MARGIN (dB)	ANTENNA HEIGHT (m)	TABLE ANGLE (Degree)	RAW VALUE (dBuV)	CORRECTION FACTOR (dB/m)
1	*2437.00	112.56 PK			2.80 H	79	112.76	-0.20
2	*2437.00	103.21 AV			2.80 H	79	103.41	-0.20
3	4874.00	53.85 PK	74.00	-20.15	3.09 H	227	47.67	6.18
4	4874.00	41.03 AV	54.00	-12.97	3.09 H	227	34.85	6.18

**ANTENNA POLARITY & TEST DISTANCE: VERTICAL AT 3 M**

NO.	FREQ. (MHz)	EMISSION LEVEL (dBuV/m)	LIMIT (dBuV/m)	MARGIN (dB)	ANTENNA HEIGHT (m)	TABLE ANGLE (Degree)	RAW VALUE (dBuV)	CORRECTION FACTOR (dB/m)
1	*2437.00	104.68 PK			1.10 V	46	104.88	-0.20
2	*2437.00	94.76 AV			1.10 V	46	94.96	-0.20
3	4874.00	52.10 PK	74.00	-21.90	1.90 V	134	45.92	6.18
4	4874.00	39.34 AV	54.00	-14.66	1.90 V	134	33.16	6.18

**REMARKS:**

1. Emission Level(dBuV/m) = Raw Value(dBuV) + Correction Factor(dB/m)
2. Correction Factor(dB/m) = Antenna Factor(dB/m) + Cable Factor(dB) – Pre-Amplifier Factor(dB)
3. Margin value = Emission Level – Limit value
4. The other emission levels were very low against the limit.
5. " \* ": Fundamental frequency.

<b>CHANNEL</b>	TX Channel 11	<b>DETECTOR FUNCTION</b>	Peak (PK)
<b>FREQUENCY RANGE</b>	1GHz ~ 25GHz		Average (AV)

**ANTENNA POLARITY & TEST DISTANCE: HORIZONTAL AT 3 M**

NO.	FREQ. (MHz)	EMISSION LEVEL (dBuV/m)	LIMIT (dBuV/m)	MARGIN (dB)	ANTENNA HEIGHT (m)	TABLE ANGLE (Degree)	RAW VALUE (dBuV)	CORRECTION FACTOR (dB/m)
1	*2462.00	108.14 PK			2.88 H	83	108.32	-0.18
2	*2462.00	98.30 AV			2.88 H	83	98.48	-0.18
3	2483.50	70.67 PK	74.00	-3.33	2.88 H	83	70.83	-0.16
4	2483.50	52.91 AV	54.00	-1.09	2.88 H	83	53.07	-0.16
5	4924.00	47.01 PK	74.00	-26.99	3.16 H	217	40.90	6.11
6	4924.00	34.15 AV	54.00	-19.85	3.16 H	217	28.04	6.11

**ANTENNA POLARITY & TEST DISTANCE: VERTICAL AT 3 M**

NO.	FREQ. (MHz)	EMISSION LEVEL (dBuV/m)	LIMIT (dBuV/m)	MARGIN (dB)	ANTENNA HEIGHT (m)	TABLE ANGLE (Degree)	RAW VALUE (dBuV)	CORRECTION FACTOR (dB/m)
1	*2462.00	103.35 PK			2.76 V	217	103.53	-0.18
2	*2462.00	93.58 AV			2.76 V	217	93.76	-0.18
3	2483.50	66.94 PK	74.00	-7.06	2.76 V	217	67.10	-0.16
4	2483.50	48.46 AV	54.00	-5.54	2.76 V	217	48.62	-0.16
5	4924.00	46.40 PK	74.00	-27.60	1.82 V	131	40.29	6.11
6	4924.00	33.67 AV	54.00	-20.33	1.82 V	131	27.56	6.11

**REMARKS:**

1. Emission Level(dBuV/m) = Raw Value(dBuV) + Correction Factor(dB/m)
2. Correction Factor(dB/m) = Antenna Factor(dB/m) + Cable Factor(dB) – Pre-Amplifier Factor(dB)
3. Margin value = Emission Level – Limit value
4. The other emission levels were very low against the limit.
5. " \* ": Fundamental frequency.

802.11n (40MHz)

<b>CHANNEL</b>	TX Channel 3	<b>DETECTOR FUNCTION</b>	Peak (PK)
<b>FREQUENCY RANGE</b>	1GHz ~ 25GHz		Average (AV)

**ANTENNA POLARITY & TEST DISTANCE: HORIZONTAL AT 3 M**

NO.	FREQ. (MHz)	EMISSION LEVEL (dBuV/m)	LIMIT (dBuV/m)	MARGIN (dB)	ANTENNA HEIGHT (m)	TABLE ANGLE (Degree)	RAW VALUE (dBuV)	CORRECTION FACTOR (dB/m)
1	2390.00	68.22 PK	74.00	-5.78	2.24 H	86	68.44	-0.22
2	2390.00	52.83 AV	54.00	-1.17	2.24 H	86	53.05	-0.22
3	*2422.00	106.79 PK			2.24 H	86	106.99	-0.20
4	*2422.00	96.56 AV			2.24 H	86	96.76	-0.20
5	4844.00	47.38 PK	74.00	-26.62	1.58 H	234	41.09	6.29
6	4844.00	34.82 AV	54.00	-19.18	1.58 H	234	28.53	6.29

**ANTENNA POLARITY & TEST DISTANCE: VERTICAL AT 3 M**

NO.	FREQ. (MHz)	EMISSION LEVEL (dBuV/m)	LIMIT (dBuV/m)	MARGIN (dB)	ANTENNA HEIGHT (m)	TABLE ANGLE (Degree)	RAW VALUE (dBuV)	CORRECTION FACTOR (dB/m)
1	2390.00	65.87 PK	74.00	-8.13	1.00 V	41	66.09	-0.22
2	2390.00	49.72 AV	54.00	-4.28	1.00 V	41	49.94	-0.22
3	*2422.00	103.40 PK			1.00 V	41	103.60	-0.20
4	*2422.00	93.19 AV			1.00 V	41	93.39	-0.20
5	4844.00	46.84 PK	74.00	-27.16	1.88 V	21	40.55	6.29
6	4844.00	33.92 AV	54.00	-20.08	1.88 V	21	27.63	6.29

**REMARKS:**

1. Emission Level(dBuV/m) = Raw Value(dBuV) + Correction Factor(dB/m)
2. Correction Factor(dB/m) = Antenna Factor(dB/m) + Cable Factor(dB) – Pre-Amplifier Factor(dB)
3. Margin value = Emission Level – Limit value
4. The other emission levels were very low against the limit.
5. " \* ": Fundamental frequency.

<b>CHANNEL</b>	TX Channel 6	<b>DETECTOR FUNCTION</b>	Peak (PK)
<b>FREQUENCY RANGE</b>	1GHz ~ 25GHz		Average (AV)

**ANTENNA POLARITY & TEST DISTANCE: HORIZONTAL AT 3 M**

NO.	FREQ. (MHz)	EMISSION LEVEL (dBuV/m)	LIMIT (dBuV/m)	MARGIN (dB)	ANTENNA HEIGHT (m)	TABLE ANGLE (Degree)	RAW VALUE (dBuV)	CORRECTION FACTOR (dB/m)
1	2390.00	66.21 PK	74.00	-7.79	1.53 H	247	66.43	-0.22
2	2390.00	49.94 AV	54.00	-4.06	1.53 H	247	50.16	-0.22
3	*2437.00	108.73 PK			1.53 H	247	108.93	-0.20
4	*2437.00	98.49 AV			1.53 H	247	98.69	-0.20
5	2483.50	70.34 PK	74.00	-3.66	1.53 H	247	70.50	-0.16
6	2483.50	52.96 AV	54.00	-1.04	1.53 H	247	53.12	-0.16
7	4874.00	47.35 PK	74.00	-26.65	1.96 H	223	41.17	6.18
8	4874.00	34.79 AV	54.00	-19.21	1.96 H	223	28.61	6.18

**ANTENNA POLARITY & TEST DISTANCE: VERTICAL AT 3 M**

NO.	FREQ. (MHz)	EMISSION LEVEL (dBuV/m)	LIMIT (dBuV/m)	MARGIN (dB)	ANTENNA HEIGHT (m)	TABLE ANGLE (Degree)	RAW VALUE (dBuV)	CORRECTION FACTOR (dB/m)
1	2390.00	62.32 PK	74.00	-11.68	1.02 V	56	62.54	-0.22
2	2390.00	46.11 AV	54.00	-7.89	1.02 V	56	46.33	-0.22
3	*2437.00	105.06 PK			1.02 V	56	105.26	-0.20
4	*2437.00	94.89 AV			1.02 V	56	95.09	-0.20
5	2483.50	66.53 PK	74.00	-7.47	1.02 V	56	66.69	-0.16
6	2483.50	50.17 AV	54.00	-3.83	1.02 V	56	50.33	-0.16
7	4874.00	46.73 PK	74.00	-27.27	1.28 V	129	40.55	6.18
8	4874.00	33.80 AV	54.00	-20.20	1.28 V	129	27.62	6.18

**REMARKS:**

1. Emission Level(dBuV/m) = Raw Value(dBuV) + Correction Factor(dB/m)
2. Correction Factor(dB/m) = Antenna Factor(dB/m) + Cable Factor(dB) – Pre-Amplifier Factor(dB)
3. Margin value = Emission Level – Limit value
4. The other emission levels were very low against the limit.
5. " \* ": Fundamental frequency.

<b>CHANNEL</b>	TX Channel 9	<b>DETECTOR FUNCTION</b>	Peak (PK)
<b>FREQUENCY RANGE</b>	1GHz ~ 25GHz		Average (AV)

**ANTENNA POLARITY & TEST DISTANCE: HORIZONTAL AT 3 M**

NO.	FREQ. (MHz)	EMISSION LEVEL (dBuV/m)	LIMIT (dBuV/m)	MARGIN (dB)	ANTENNA HEIGHT (m)	TABLE ANGLE (Degree)	RAW VALUE (dBuV)	CORRECTION FACTOR (dB/m)
1	*2452.00	106.11 PK			1.51 H	246	106.29	-0.18
2	*2452.00	95.98 AV			1.51 H	246	96.16	-0.18
3	2483.50	66.81 PK	74.00	-7.19	1.51 H	246	66.97	-0.16
4	2483.50	52.58 AV	54.00	-1.42	1.51 H	246	52.74	-0.16
5	4904.00	47.85 PK	74.00	-26.15	1.69 H	184	41.75	6.10
6	4904.00	34.16 AV	54.00	-19.84	1.69 H	184	28.06	6.10

**ANTENNA POLARITY & TEST DISTANCE: VERTICAL AT 3 M**

NO.	FREQ. (MHz)	EMISSION LEVEL (dBuV/m)	LIMIT (dBuV/m)	MARGIN (dB)	ANTENNA HEIGHT (m)	TABLE ANGLE (Degree)	RAW VALUE (dBuV)	CORRECTION FACTOR (dB/m)
1	*2452.00	102.48 PK			1.03 V	38	102.66	-0.18
2	*2452.00	92.30 AV			1.03 V	38	92.48	-0.18
3	2483.50	62.86 PK	74.00	-11.14	1.03 V	38	63.02	-0.16
4	2483.50	49.52 AV	54.00	-4.48	1.03 V	38	49.68	-0.16
5	4904.00	46.16 PK	74.00	-27.84	1.77 V	291	40.06	6.10
6	4904.00	33.33 AV	54.00	-20.67	1.77 V	291	27.23	6.10

**REMARKS:**

1. Emission Level(dBuV/m) = Raw Value(dBuV) + Correction Factor(dB/m)
2. Correction Factor(dB/m) = Antenna Factor(dB/m) + Cable Factor(dB) – Pre-Amplifier Factor(dB)
3. Margin value = Emission Level – Limit value
4. The other emission levels were very low against the limit.
5. " \* ": Fundamental frequency.

**Below 1GHz Data:**

**802.11b**

<b>CHANNEL</b>	TX Channel 6	<b>DETECTOR FUNCTION</b>	Quasi-Peak (QP)
<b>FREQUENCY RANGE</b>	9kHz ~ 1GHz		

ANTENNA POLARITY & TEST DISTANCE: HORIZONTAL AT 3 M								
NO.	FREQ. (MHz)	EMISSION LEVEL (dBuV/m)	LIMIT (dBuV/m)	MARGIN (dB)	ANTENNA HEIGHT (m)	TABLE ANGLE (Degree)	RAW VALUE (dBuV)	CORRECTION FACTOR (dB/m)
1	102.31	26.62 QP	43.50	-16.88	1.87 H	301	37.62	-11.00
2	159.01	25.71 QP	43.50	-17.79	1.92 H	290	32.39	-6.68
3	264.01	34.55 QP	46.00	-11.45	1.55 H	99	40.89	-6.34
4	294.91	32.83 QP	46.00	-13.17	1.49 H	97	38.03	-5.20
5	319.50	33.70 QP	46.00	-12.30	1.08 H	271	38.21	-4.51
6	455.98	34.26 QP	46.00	-11.74	1.15 H	257	36.18	-1.92

**REMARKS:**

1. Emission Level(dBuV/m) = Raw Value(dBuV) + Correction Factor(dB/m)
2. Correction Factor(dB/m) = Antenna Factor(dB/m) + Cable Factor(dB) – Pre-Amplifier Factor(dB)
3. Margin value = Emission Level – Limit value
4. The other emission levels were very low against the limit of frequency range 30MHz~1000MHz.
5. The emission levels were very low against the limit of frequency range 9kHz~30MHz: the amplitude of spurious emissions attenuated more than 20 dB below the permissible value to be report.

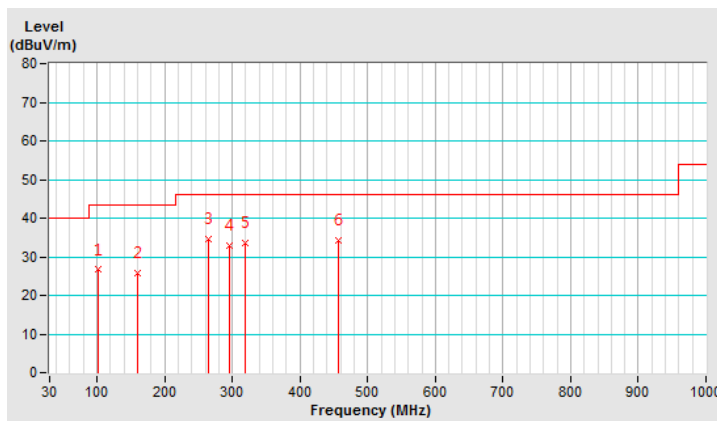

<b>CHANNEL</b>	TX Channel 6	<b>DETECTOR FUNCTION</b>	Quasi-Peak (QP)
<b>FREQUENCY RANGE</b>	9kHz ~ 1GHz		

**ANTENNA POLARITY & TEST DISTANCE: VERTICAL AT 3 M**

NO.	FREQ. (MHz)	EMISSION LEVEL (dBuV/m)	LIMIT (dBuV/m)	MARGIN (dB)	ANTENNA HEIGHT (m)	TABLE ANGLE (Degree)	RAW VALUE (dBuV)	CORRECTION FACTOR (dB/m)
1	47.80	31.78 QP	40.00	-8.22	1.15 V	158	38.90	-7.12
2	78.16	29.75 QP	40.00	-10.25	1.64 V	296	40.94	-11.19
3	140.73	23.70 QP	43.50	-19.80	1.52 V	160	31.00	-7.30
4	294.91	33.88 QP	46.00	-12.12	1.24 V	58	39.08	-5.20
5	408.01	37.30 QP	46.00	-8.70	1.10 V	142	40.51	-3.21
6	480.03	31.67 QP	46.00	-14.33	1.08 V	91	33.24	-1.57

**REMARKS:**

1. Emission Level(dBuV/m) = Raw Value(dBuV) + Correction Factor(dB/m)
2. Correction Factor(dB/m) = Antenna Factor(dB/m) + Cable Factor(dB) – Pre-Amplifier Factor(dB)
3. Margin value = Emission Level – Limit value
4. The other emission levels were very low against the limit of frequency range 30MHz~1000MHz.
5. The emission levels were very low against the limit of frequency range 9kHz~30MHz: the amplitude of spurious emissions attenuated more than 20 dB below the permissible value to be report.

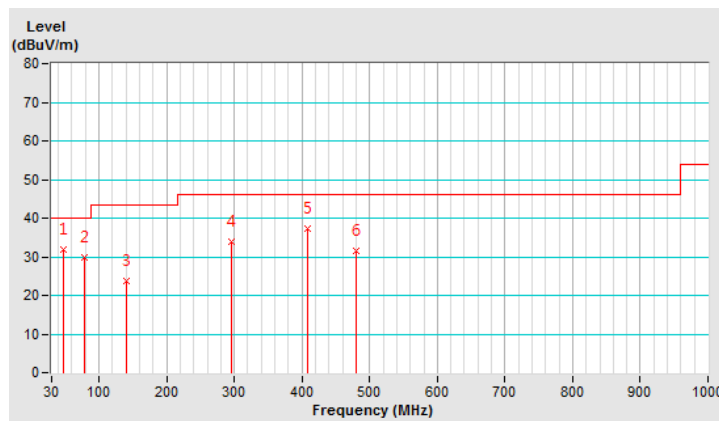

## 4.2 Conducted Emission Measurement

### 4.2.1 Limits of Conducted Emission Measurement

Frequency (MHz)	Conducted Limit (dBuV)	
	Quasi-peak	Average
0.15 - 0.5	66 - 56	56 - 46
0.50 - 5.0	56	46
5.0 - 30.0	60	50

Note: 1. The lower limit shall apply at the transition frequencies.

2. The limit decreases in line with the logarithm of the frequency in the range of 0.15 to 0.50MHz.

### 4.2.2 Test Instruments

Description & Manufacturer	Model No.	Serial No.	Cal. Date	Cal. Due
ROHDE & SCHWARZ TEST RECEIVER	ESCS 30	838251/021	Nov. 1, 2018	Oct. 31, 2019
ROHDE & SCHWARZ Artificial Mains Network (For EUT)	ENV216	101195	May 2, 2018	May 1, 2019
LISN With Adapter (for EUT)	AD10	C03Ada-002	May 2, 2018	May 1, 2019
EMCO L.I.S.N. (For peripherals)	3825/2	9504-2359	Jul. 26, 2018	Jul. 25, 2019
SCHWARZBECK Artificial Mains Network (For EUT)	NNLK8129	8129229	May 3, 2018	May 2, 2019
Software	Cond_V7.3.7.4	NA	NA	NA
RF cable (JYEBAO) With 10dB PAD	5D-FB	Cable-C03.01	Sep. 18, 2018	Sep. 17, 2019
LYNICS Terminator (For EMCO LISN)	0900510	E1-01-300	Jan. 25, 2019	Jan. 24, 2020
LYNICS Terminator (For EMCO LISN)	0900510	E1-01-301	Jan. 25, 2019	Jan. 24, 2020
ROHDE & SCHWARZ Artificial Mains Network (For TV EUT)	ESH3-Z5	100220	Nov. 21, 2018	Nov. 20, 2019
LISN With Adapter (for TV EUT)	100220	N/A	Nov. 21, 2018	Nov. 20, 2019

Note: 1. The calibration interval of the above test instruments is 12 months and the calibrations are traceable to NML/ROC and NIST/USA.

2. The test was performed in Shielded Room No. 3.



#### 4.2.3 Test Procedures

- The EUT was placed 0.4 meters from the conducting wall of the shielded room with EUT being connected to the power mains through a line impedance stabilization network (LISN). Other support units were connected to the power mains through another LISN. The two LISNs provide 50 ohm/ 50uH of coupling impedance for the measuring instrument.
- Both lines of the power mains connected to the EUT were checked for maximum conducted interference.
- The frequency range from 150kHz to 30MHz was searched. Emission levels under (Limit - 20dB) was not recorded.

**NOTE:** The resolution bandwidth and video bandwidth of test receiver is 9kHz for quasi-peak detection (QP) and average detection (AV) at frequency 0.15MHz-30MHz.

#### 4.2.4 Deviation from Test Standard

No deviation.

#### 4.2.5 Test Setup

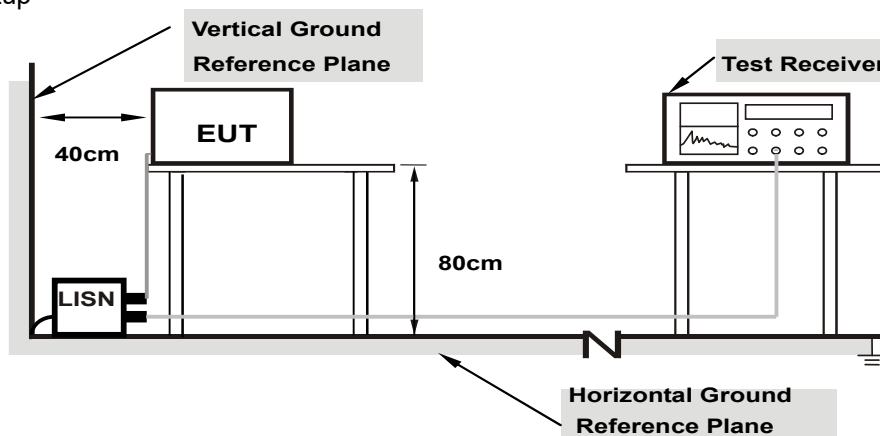

**Note:** 1.Support units were connected to second LISN.

For the actual test configuration, please refer to the attached file (Test Setup Photo).

#### 4.2.6 EUT Operating Conditions

Same as 4.1.6.

#### 4.2.7 Test Results

Phase	Line (L)	Detector Function	Quasi-Peak (QP) / Average (AV)
-------	----------	-------------------	--------------------------------

No	Freq. [MHz]	Corr.	Reading Value		Emission Level		Limit		Margin	
		Factor (dB)	[dB (uV)]		[dB (uV)]		[dB (uV)]		(dB)	
			Q.P.	AV.	Q.P.	AV.	Q.P.	AV.	Q.P.	AV.
1	0.16172	9.71	43.86	29.04	53.57	38.75	65.38	55.38	-11.81	-16.63
2	0.22422	9.71	36.28	21.72	45.99	31.43	62.66	52.66	-16.67	-21.23
3	0.52109	9.77	26.16	14.46	35.93	24.23	56.00	46.00	-20.07	-21.77
4	1.69141	9.90	18.36	3.28	28.26	13.18	56.00	46.00	-27.74	-32.82
5	3.29297	9.99	18.40	6.02	28.39	16.01	56.00	46.00	-27.61	-29.99
6	6.09766	10.08	14.62	4.74	24.70	14.82	60.00	50.00	-35.30	-35.18

#### REMARKS:

1. Q.P. and AV. are abbreviations of quasi-peak and average individually.
2. The emission levels of other frequencies were very low against the limit.
3. Margin value = Emission level - Limit value
4. Correction factor = Insertion loss + Cable loss
5. Emission Level = Correction Factor + Reading Value.

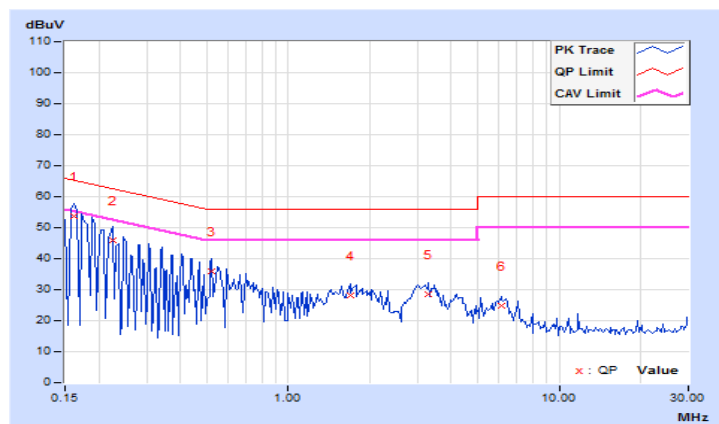

Phase	Neutral (N)	Detector Function	Quasi-Peak (QP) / Average (AV)
-------	-------------	-------------------	--------------------------------

No	Freq. [MHz]	Corr.	Reading Value		Emission Level		Limit		Margin	
		Factor	[dB (uV)]		[dB (uV)]		[dB (uV)]		(dB)	
		(dB)	Q.P.	AV.	Q.P.	AV.	Q.P.	AV.	Q.P.	AV.
1	0.16172	9.72	45.00	29.86	54.72	39.58	65.38	55.38	-10.66	-15.80
2	0.22422	9.73	37.78	22.42	47.51	32.15	62.66	52.66	-15.15	-20.51
3	0.28281	9.74	32.80	19.66	42.54	29.40	60.73	50.73	-18.19	-21.33
4	0.53672	9.79	27.28	20.14	37.07	29.93	56.00	46.00	-18.93	-16.07
5	3.28516	9.98	19.68	12.26	29.66	22.24	56.00	46.00	-26.34	-23.76
6	6.10156	10.07	15.28	9.14	25.35	19.21	60.00	50.00	-34.65	-30.79

**REMARKS:**

1. Q.P. and AV. are abbreviations of quasi-peak and average individually.
2. The emission levels of other frequencies were very low against the limit.
3. Margin value = Emission level - Limit value
4. Correction factor = Insertion loss + Cable loss
5. Emission Level = Correction Factor + Reading Value.

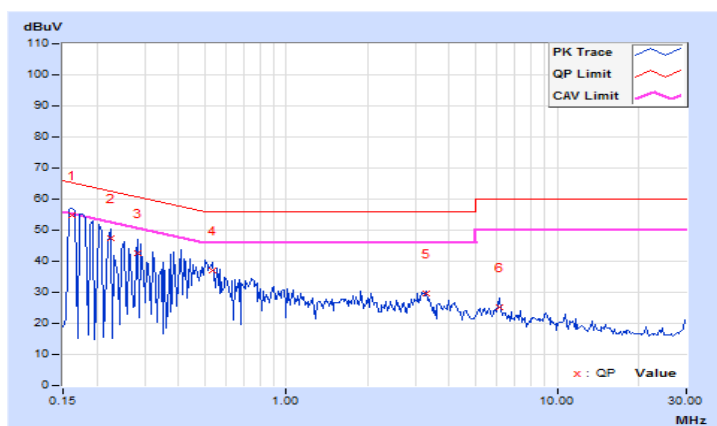

### 4.3 6dB Bandwidth Measurement

#### 4.3.1 Limits of 6dB Bandwidth Measurement

The minimum of 6dB Bandwidth Measurement is 0.5 MHz.

#### 4.3.2 Test Setup

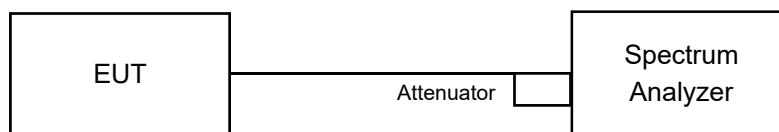

#### 4.3.3 Test Instruments

Refer to section 4.1.2 to get information of above instrument.

#### 4.3.4 Test Procedure

- a. Set resolution bandwidth (RBW) = 100kHz
- b. Set the video bandwidth (VBW)  $\geq 3 \times$  RBW, Detector = Peak.
- c. Trace mode = max hold.
- d. Sweep = auto couple.
- e. Measure the maximum width of the emission that is constrained by the frequencies associated with the two amplitude points (upper and lower) that are attenuated by 6 dB relative to the maximum level measured in the fundamental emission

#### 4.3.5 Deviation from Test Standard

No deviation.

#### 4.3.6 EUT Operating Conditions

The software provided by client to enable the EUT under transmission condition continuously at lowest, middle and highest channel frequencies individually.

#### 4.3.7 Test Result

##### 802.11b

Channel	Frequency (MHz)	6dB Bandwidth (MHz)	Minimum Limit (MHz)	Pass / Fail
1	2412	10.11	0.5	PASS
6	2437	10.11	0.5	PASS
11	2462	10.12	0.5	PASS

##### 802.11g

Channel	Frequency (MHz)	6dB Bandwidth (MHz)	Minimum Limit (MHz)	Pass / Fail
1	2412	16.40	0.5	PASS
6	2437	16.39	0.5	PASS
11	2462	16.38	0.5	PASS

##### 802.11n (20MHz)

Channel	Frequency (MHz)	6dB Bandwidth (MHz)		Minimum Limit (MHz)	Pass / Fail
		Chain 0	Chain 1		
1	2412	17.36	17.36	0.5	PASS
6	2437	17.59	17.57	0.5	PASS
11	2462	17.57	17.57	0.5	PASS

##### 802.11n (40MHz)

Channel	Frequency (MHz)	6dB Bandwidth (MHz)		Minimum Limit (MHz)	Pass / Fail
		Chain 0	Chain 1		
3	2422	35.81	35.83	0.5	PASS
6	2437	36.15	36.14	0.5	PASS
9	2452	35.77	35.76	0.5	PASS

Spectrum Plot of Worst Value

802.11b : CH1

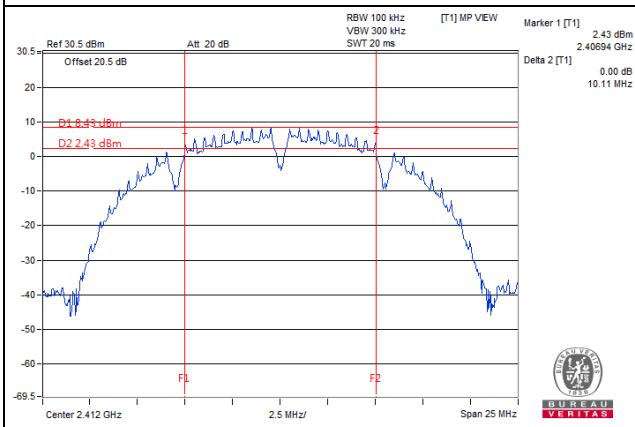

802.11g : CH11

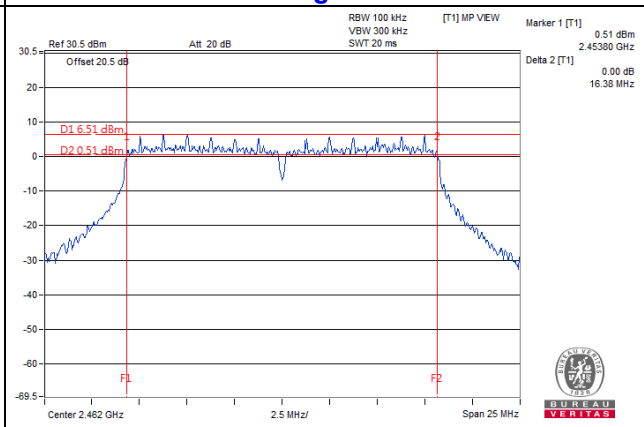

802.11n (20MHz) / Chain 0 : CH1

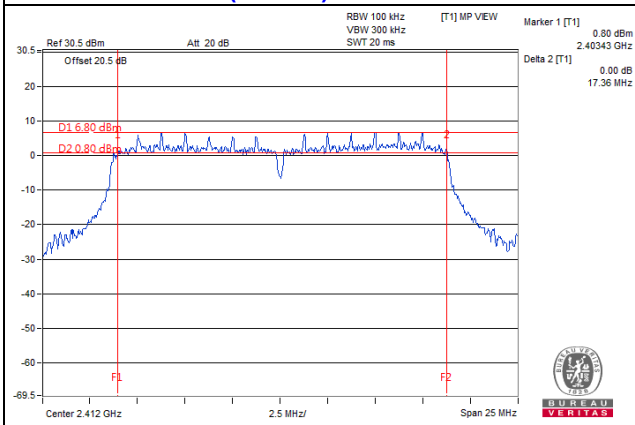

802.11n (40MHz) / Chain 1 : CH9

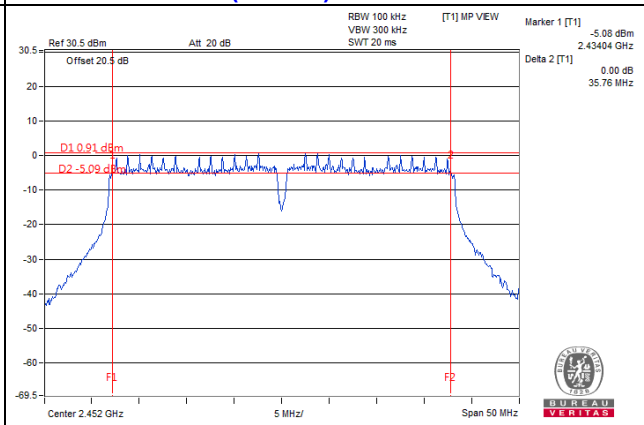

## 4.4 Conducted Output Power Measurement

### 4.4.1 Limits of Conducted Output Power Measurement

For systems using digital modulation in the 2400–2483.5 MHz bands: 1 Watt (30dBm)

Per KDB 662911 D01 Multiple Transmitter Output Method of conducted output power measurement on IEEE 802.11 devices,

Array Gain = 0 dB (i.e., no array gain) for  $N_{ANT} \leq 4$ ;

Array Gain = 0 dB (i.e., no array gain) for channel widths  $\geq 40$  MHz for any  $N_{ANT}$ ;

Array Gain =  $5 \log(N_{ANT}/N_{SS})$  dB or 3 dB, whichever is less for 20-MHz channel widths with  $N_{ANT} \geq 5$ .

For power measurements on all other devices: Array Gain =  $10 \log(N_{ANT}/N_{SS})$  dB.

### 4.4.2 Test Setup

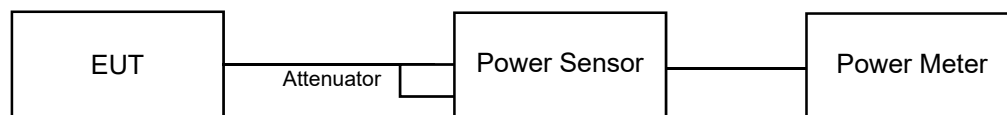

### 4.4.3 Test Instruments

Refer to section 4.1.2 to get information of above instrument.

### 4.4.4 Test Procedures

A peak power sensor was used on the output port of the EUT. A power meter was used to read the response of the peak power sensor. Record the power level.

Average power sensor was used to perform output power measurement, trigger and gating function of wide band power meter is enabled to measure max output power of TX on burst. Duty factor is not added to measured value.

### 4.4.5 Deviation from Test Standard

No deviation.

### 4.4.6 EUT Operating Conditions

Same as Item 4.3.6.

#### 4.4.7 Test Results

#### FOR PEAK POWER

##### 802.11b

Chan.	Freq. (MHz)	Peak Power (mW)	Peak Power (dBm)	Limit (dBm)	Pass / Fail
1	2412	111.686	20.48	30	Pass
6	2437	113.240	20.54	30	Pass
11	2462	114.815	20.60	30	Pass

##### 802.11g

Chan.	Freq. (MHz)	Peak Power (mW)	Peak Power (dBm)	Limit (dBm)	Pass / Fail
1	2412	352.371	25.47	30	Pass
6	2437	366.438	25.64	30	Pass
11	2462	356.451	25.52	30	Pass

##### 802.11n (20MHz)

Chan.	Freq. (MHz)	Peak Power (dBm)		Total Power (mW)	Total Power (dBm)	Limit (dBm)	Pass / Fail
		Chain 0	Chain 1				
1	2412	25.57	25.45	711.331	28.52	30	Pass
6	2437	25.65	25.58	728.692	28.63	30	Pass
11	2462	25.68	25.60	<b>732.906</b>	28.65	30	Pass

##### 802.11n (40MHz)

Chan.	Freq. (MHz)	Peak Power (dBm)		Total Power (mW)	Total Power (dBm)	Limit (dBm)	Pass / Fail
		Chain 0	Chain 1				
3	2422	25.27	15.24	369.932	25.68	30	Pass
6	2437	25.15	25.07	648.707	28.12	30	Pass
9	2452	24.34	24.31	541.418	27.34	30	Pass



**FOR AVERAGE POWER**

**802.11b**

Channel	Frequency (MHz)	Average Power (mW)	Average Power (dBm)
1	2412	63.241	18.01
6	2437	63.973	18.06
11	2462	64.863	18.12

**802.11g**

Channel	Frequency (MHz)	Average Power (mW)	Average Power (dBm)
1	2412	58.210	17.65
6	2437	64.417	18.09
11	2462	59.704	17.76

**802.11n (20MHz)**

Chan.	Frequency (MHz)	Avg. Power (dBm)		Total Power (mW)	Total Power (dBm)
		Chain 0	Chain 1		
1	2412	18.38	18.21	135.087	21.31
6	2437	18.44	18.37	138.530	21.42
11	2462	18.49	18.43	140.295	21.47

**802.11n (40MHz)**

Chan.	Frequency (MHz)	Avg. Power (dBm)		Total Power (mW)	Total Power (dBm)
		Chain 0	Chain 1		
3	2422	17.57	17.56	114.164	20.58
6	2437	17.32	17.29	107.531	20.32
9	2452	15.44	15.38	69.509	18.42

## 4.5 Power Spectral Density Measurement

### 4.5.1 Limits of Power Spectral Density Measurement

The Maximum of Power Spectral Density Measurement is 8dBm in any 3 kHz.

### 4.5.2 Test Setup

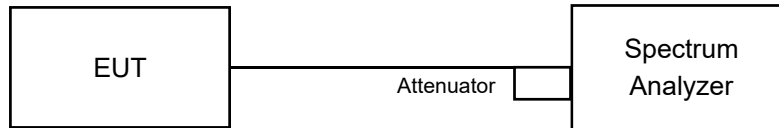

### 4.5.3 Test Instruments

Refer to section 4.1.2 to get information of above instrument.

### 4.5.4 Test Procedure

- a. Set analyzer center frequency to DTS channel center frequency.
- b. Set the span to 1.5 times the DTS bandwidth.
- c. Set the RBW to:  $3 \text{ kHz} \leq \text{RBW} \leq 100 \text{ kHz}$ .
- d. Set the VBW  $\geq 3 \times \text{RBW}$ .
- e. Detector = peak.
- f. Sweep time = auto couple.
- g. Trace mode = max hold.
- h. Allow trace to fully stabilize.
- i. Use the peak marker function to determine the maximum amplitude level within the RBW.

### 4.5.5 Deviation from Test Standard

No deviation.

### 4.5.6 EUT Operating Condition

Same as Item 4.3.6

#### 4.5.7 Test Results

##### 802.11b

Channel	Freq. (MHz)	PSD (dBm/3kHz)	Limit (dBm/3kHz)	Pass /Fail
1	2412	-5.99	8	Pass
6	2437	-5.61	8	Pass
11	2462	-4.92	8	Pass

##### 802.11g

Channel	Freq. (MHz)	PSD (dBm/3kHz)	Limit (dBm/3kHz)	Pass /Fail
1	2412	-7.45	8	Pass
6	2437	-7.90	8	Pass
11	2462	-6.80	8	Pass

##### 802.11n (20MHz)

TX chain	Channel	Freq. (MHz)	PSD (dBm/3kHz)	10 log (N=2) dB	Total PSD (dBm/3kHz)	Limit (dBm/3kHz)	Pass /Fail
0	1	2412	-7.68	3.01	-4.67	8	Pass
	6	2437	-8.03	3.01	-5.02	8	Pass
	11	2462	-7.31	3.01	-4.30	8	Pass
1	1	2412	-7.36	3.01	-4.35	8	Pass
	6	2437	-7.08	3.01	-4.07	8	Pass
	11	2462	-7.43	3.01	-4.42	8	Pass

**NOTE:** Directional gain =  $10 \log[(10^{G1/20} + 10^{G2/20})^2 / 2] = 5.63\text{dBi} < 6\text{dBi}$  , so the power density limit is not reduced.

##### 802.11n (40MHz)

TX chain	Channel	Freq. (MHz)	PSD (dBm/3kHz)	10 log (N=2) dB	Total PSD (dBm/3kHz)	Limit (dBm/3kHz)	Pass /Fail
0	3	2422	-11.42	3.01	-8.41	8	Pass
	6	2437	-11.80	3.01	-8.79	8	Pass
	9	2452	-14.47	3.01	-11.46	8	Pass
1	3	2422	-12.30	3.01	-9.29	8	Pass
	6	2437	-11.85	3.01	-8.84	8	Pass
	9	2452	-14.18	3.01	-11.17	8	Pass

**NOTE:** Directional gain =  $10 \log[(10^{G1/20} + 10^{G2/20})^2 / 2] = 5.63\text{dBi} < 6\text{dBi}$  , so the power density limit is not reduced.

### Spectrum Plot of Worst Value

**802.11b : CH11**

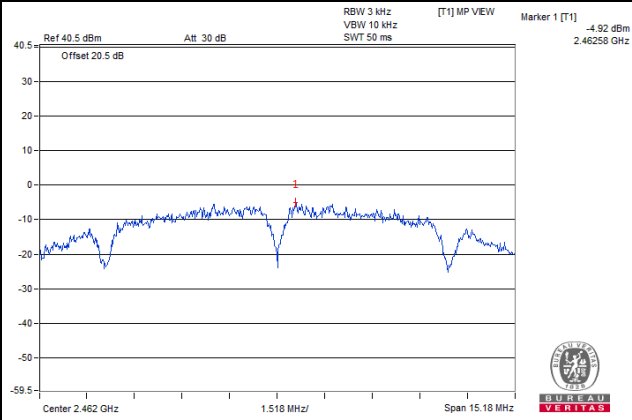

**802.11g : CH11**

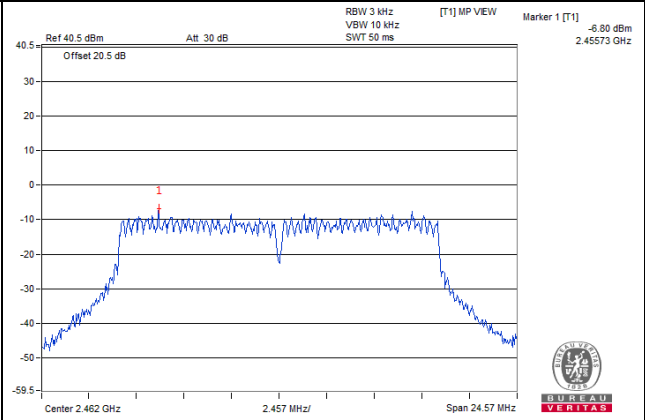

**802.11n (20MHz) / Chain 1 : CH6**

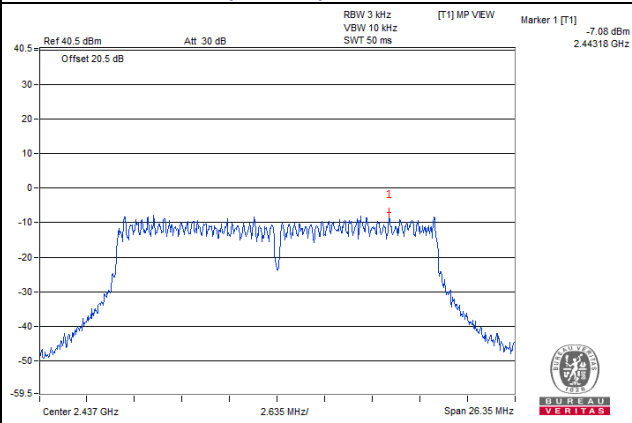

**802.11n (40MHz) / Chain 0 : CH3**

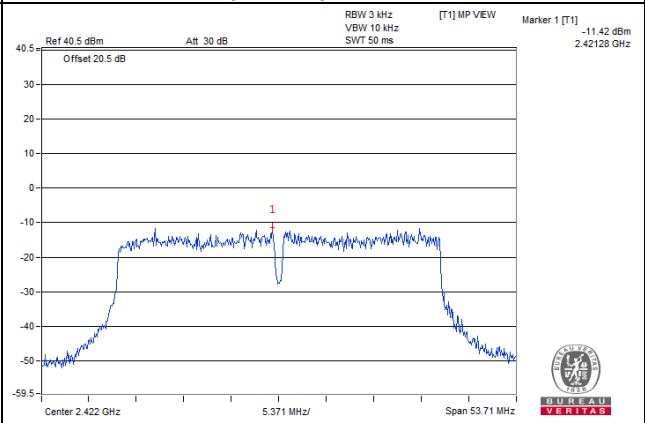

## 4.6 Conducted Out of Band Emission Measurement

### 4.6.1 Limits of Conducted Out of Band Emission Measurement

Below -20dB of the highest emission level of operating band (in 100kHz Resolution Bandwidth).

### 4.6.2 Test Setup

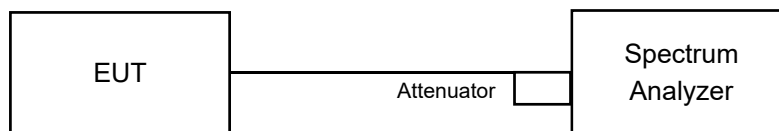

### 4.6.3 Test Instruments

Refer to section 4.1.2 to get information of above instrument.

### 4.6.4 Test Procedure

#### MEASUREMENT PROCEDURE REF

1. Set the RBW = 100 kHz.
2. Set the VBW  $\geq$  300 kHz.
3. Detector = peak.
4. Sweep time = auto couple.
5. Trace mode = max hold.
6. Allow trace to fully stabilize.
7. Use the peak marker function to determine the maximum power level in any 100 kHz band segment within the fundamental EBW.

#### MEASUREMENT PROCEDURE OOBE

1. Set RBW = 100 kHz.
2. Set VBW  $\geq$  300 kHz.
3. Detector = peak.
4. Sweep = auto couple.
5. Trace Mode = max hold.
6. Allow trace to fully stabilize.
7. Use the peak marker function to determine the maximum amplitude level.

### 4.6.5 Deviation from Test Standard

No deviation.

### 4.6.6 EUT Operating Condition

Same as Item 4.3.6

### 4.6.7 Test Results

The spectrum plots are attached on the following pages. D1 line indicates the highest level, and D2 line indicates the 20dB offset below D1. It shows compliance with the requirement.

802.11b:

CH 1

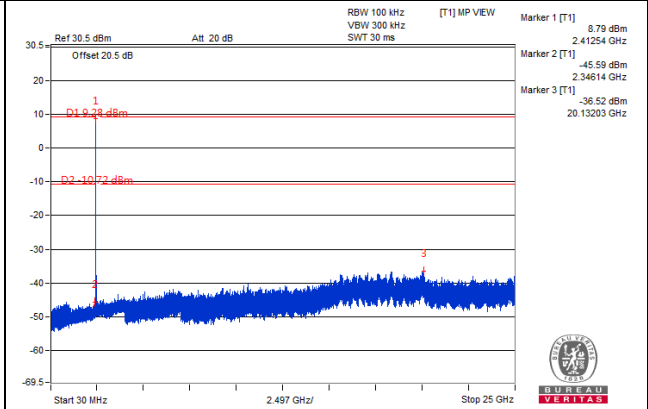
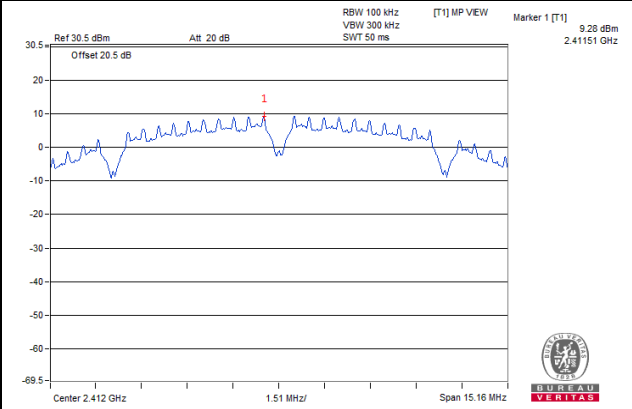

CH 6

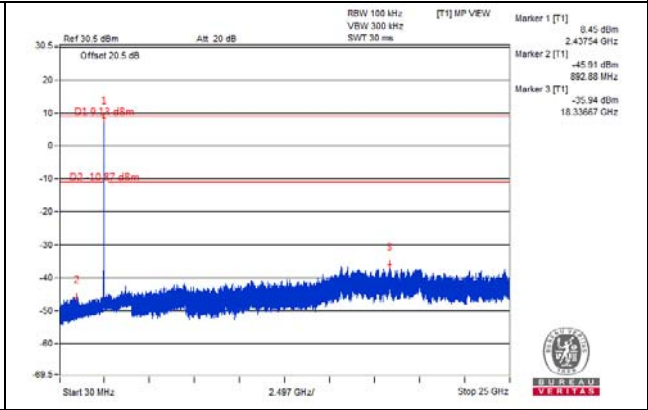
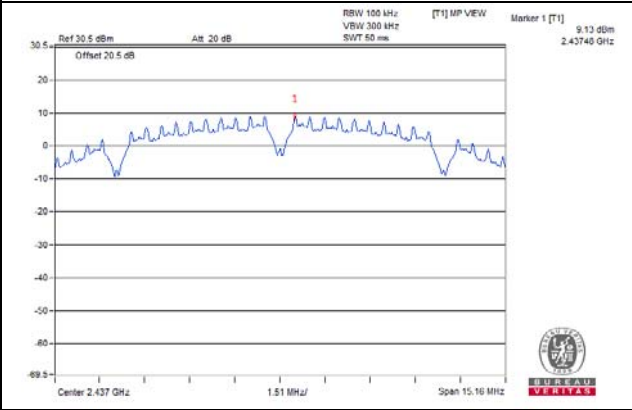

CH 11

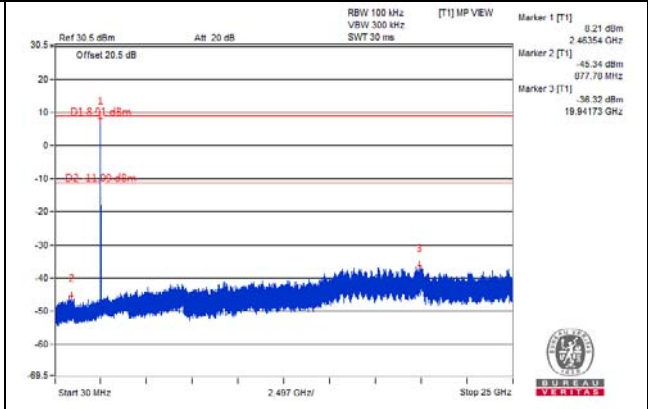
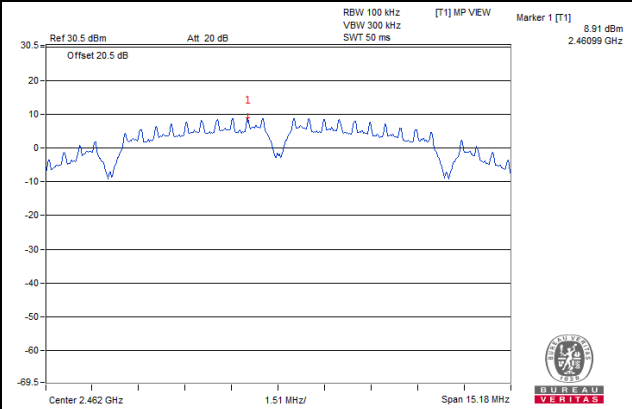

CH 1 Band edge

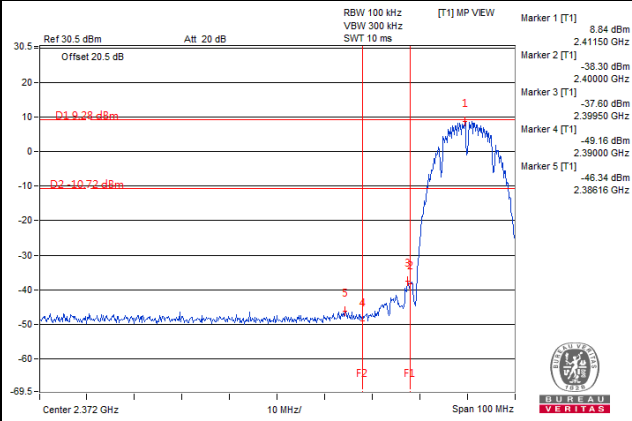

CH 11 Band edge

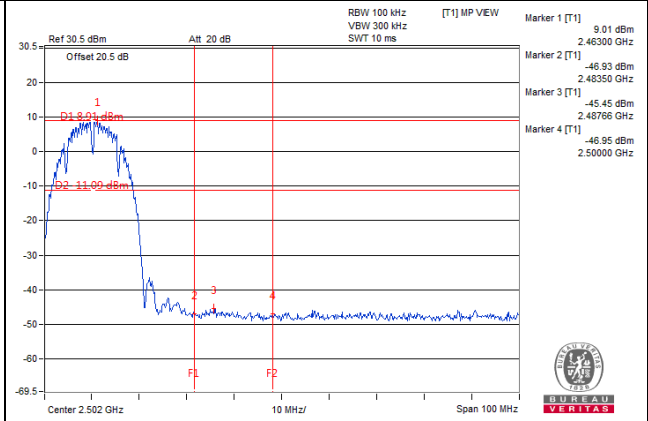

802.11g:

CH 1

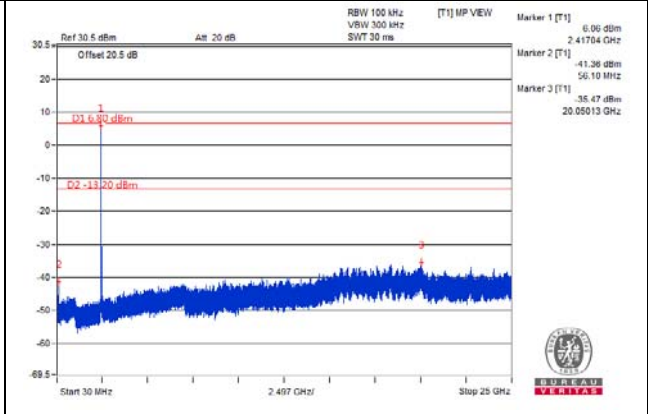
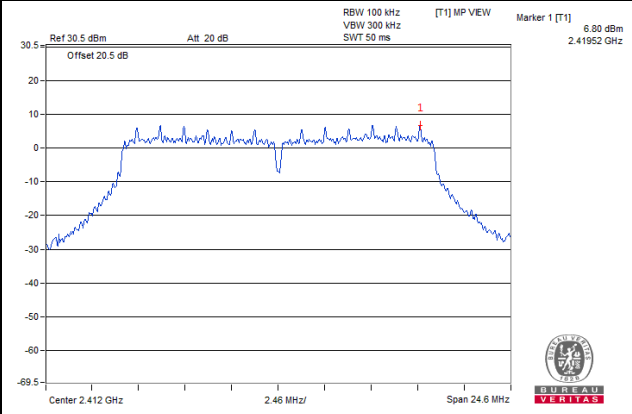

CH 6

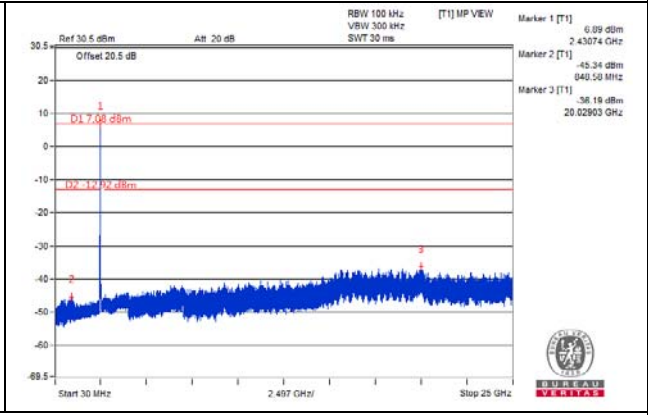
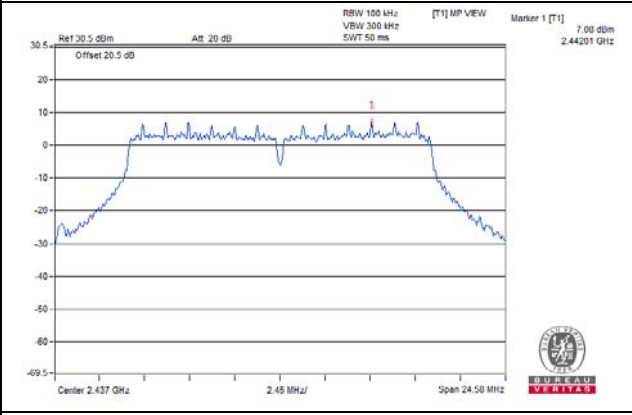

CH 11

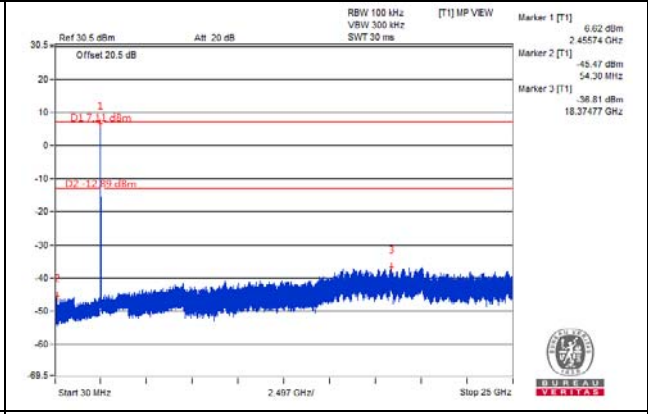
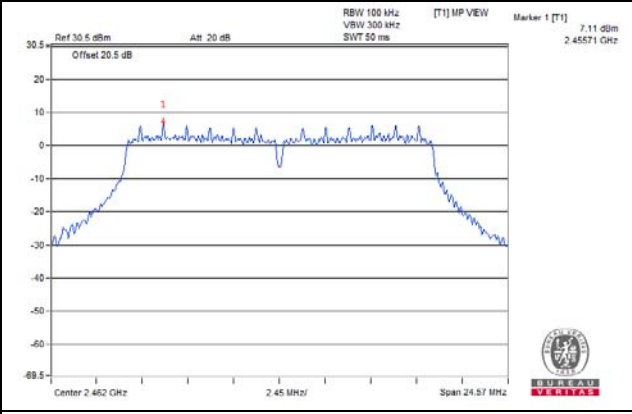

CH 1 Band edge

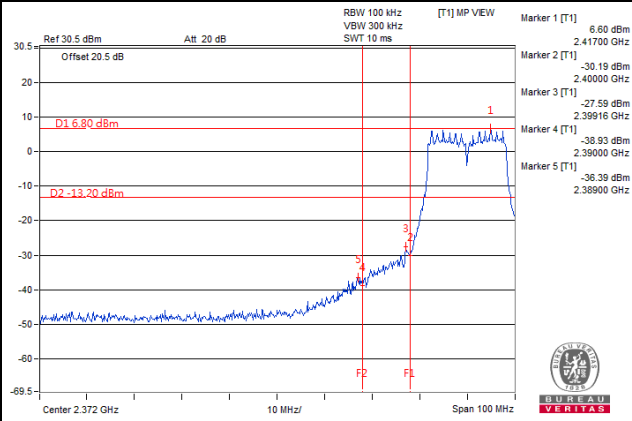

CH 11 Band edge

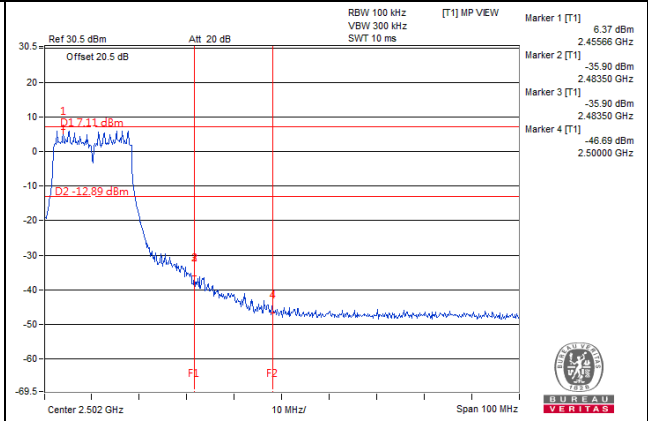

### 802.11n (20MHz): Chain 0

#### CH 1

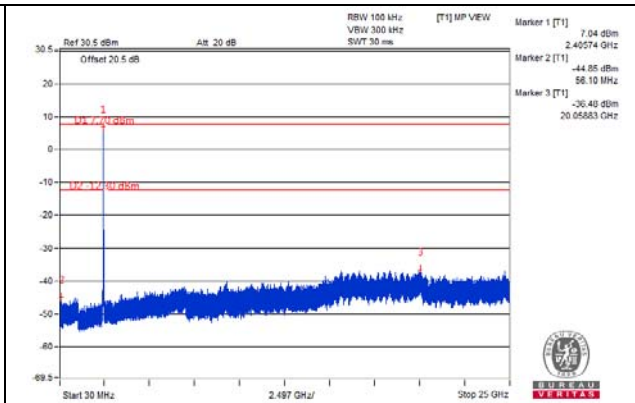
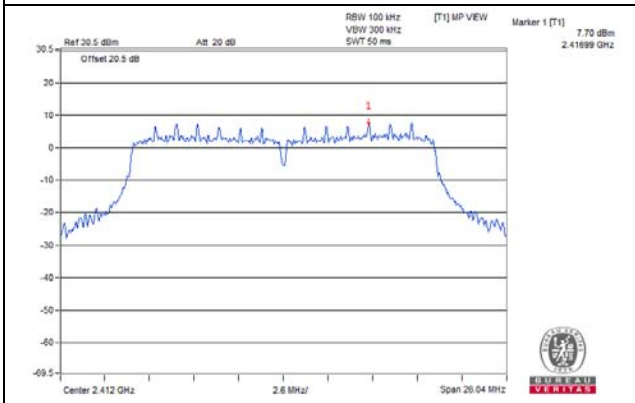

#### CH 6

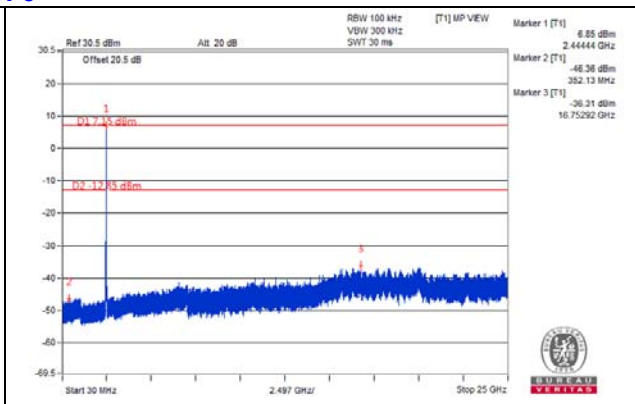
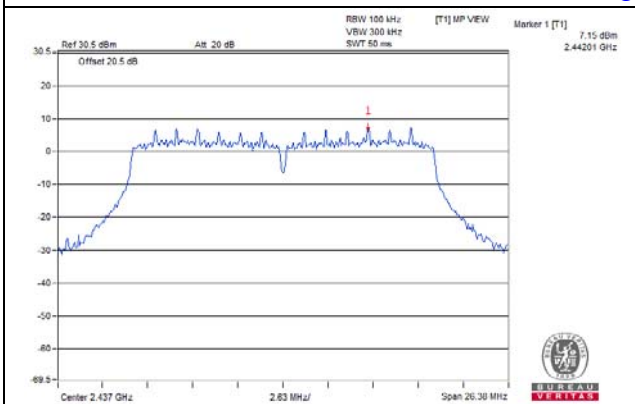

#### CH 11

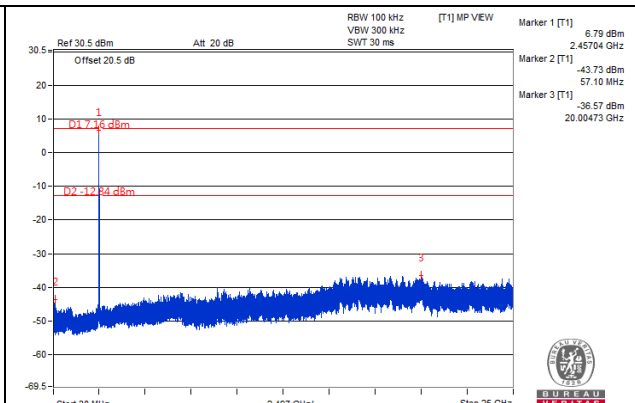
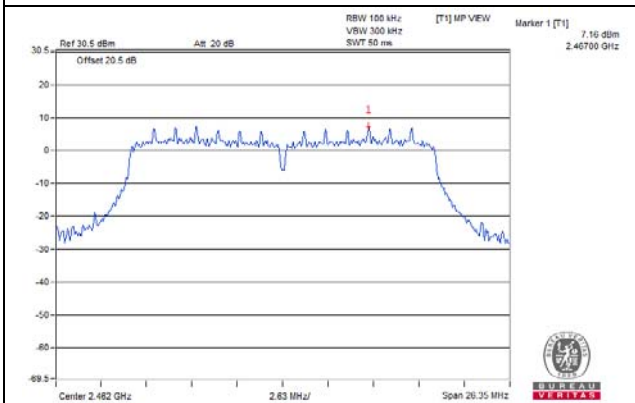

#### CH 1 Band edge

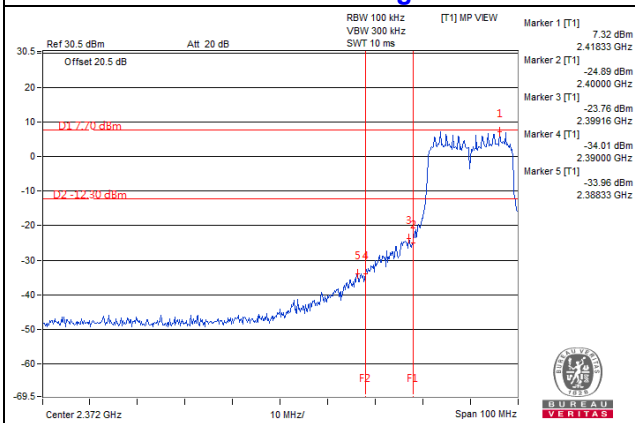

#### CH 11 Band edge

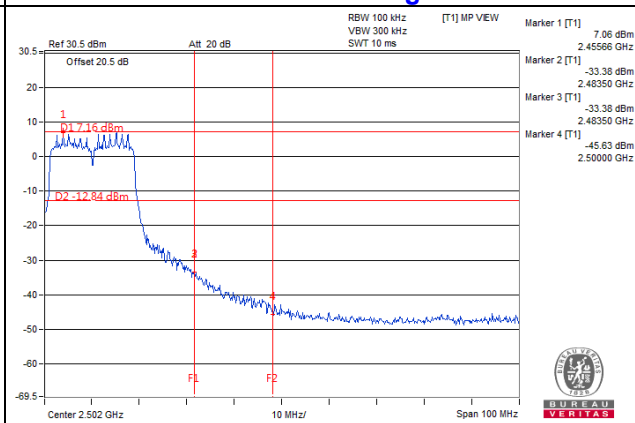



### Chain 1

#### CH 1

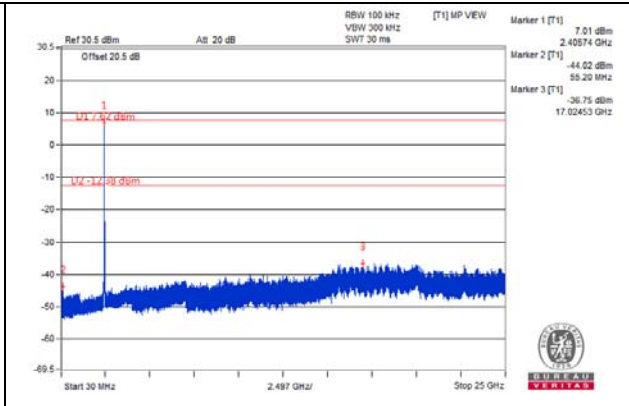
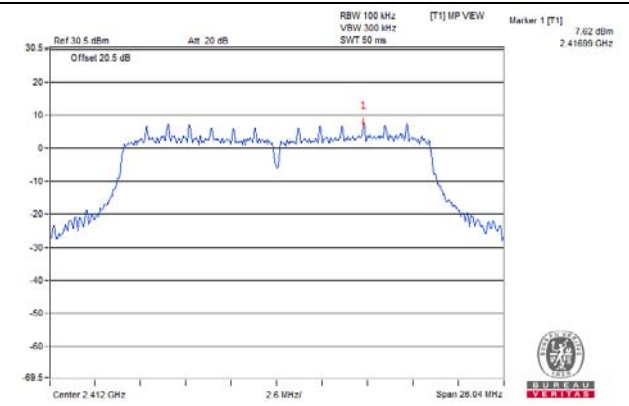

#### CH 6

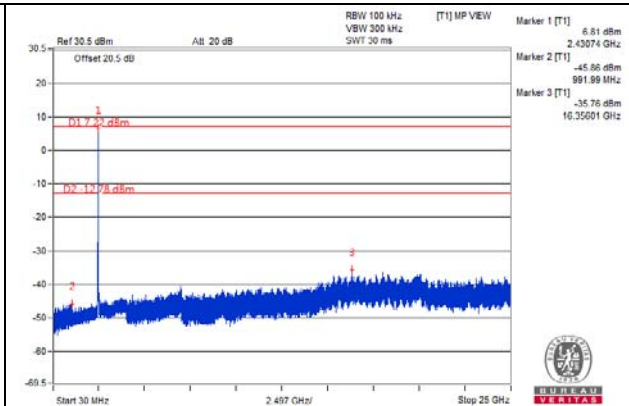
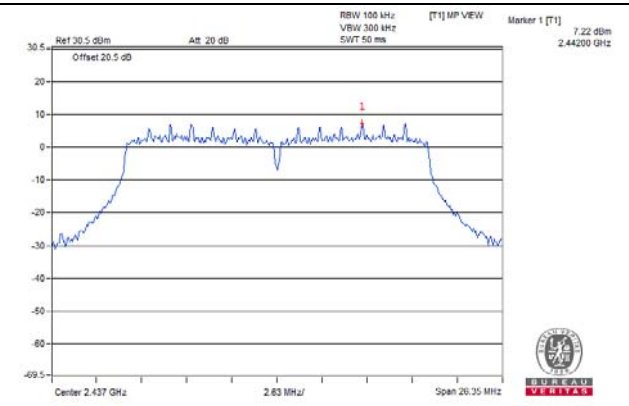

#### CH 11

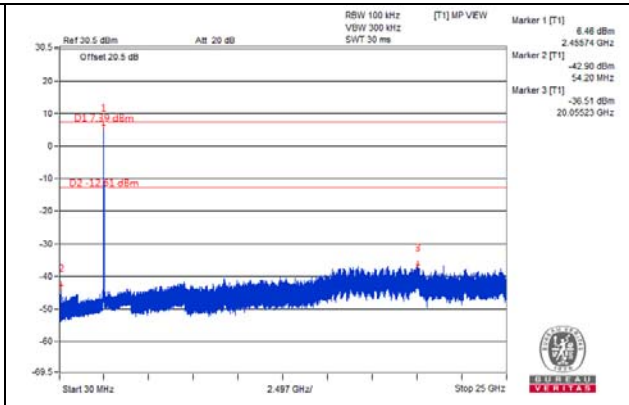
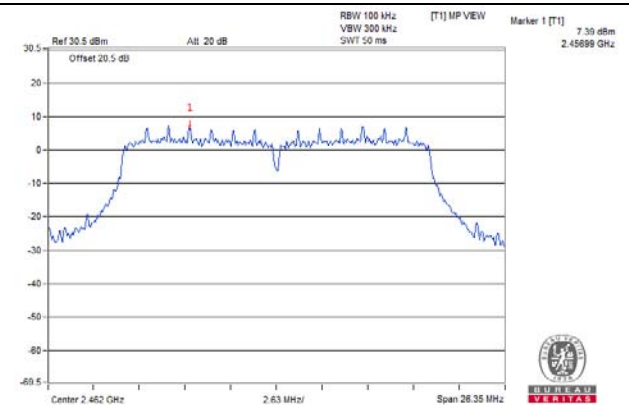

#### CH 1 Band edge

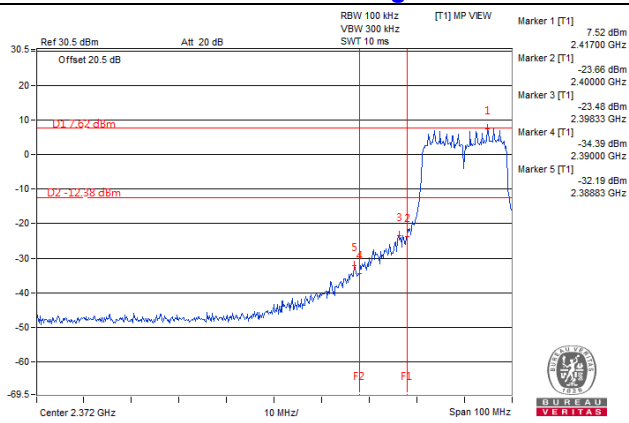

#### CH 11 Band edge

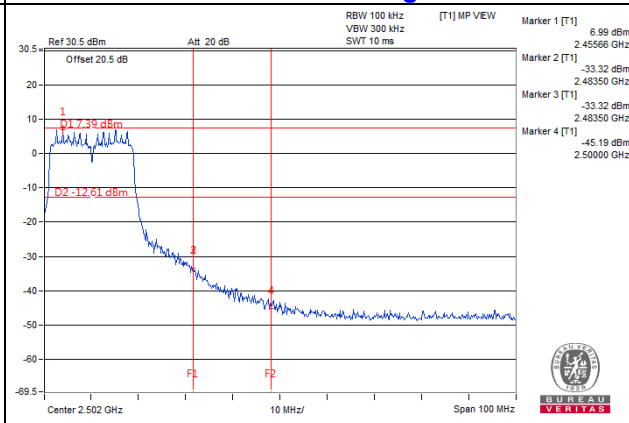

### 802.11n (40MHz): Chain 0

#### CH 3

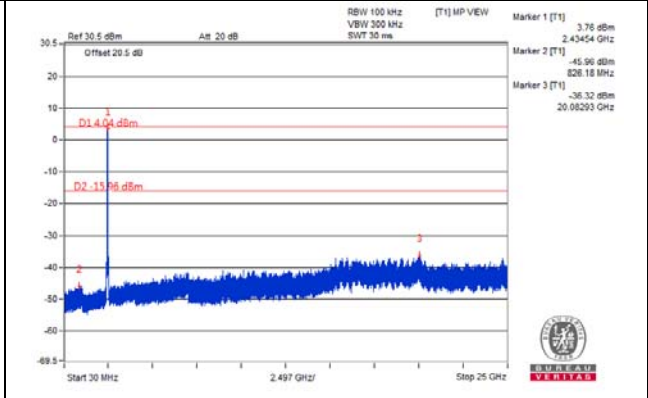
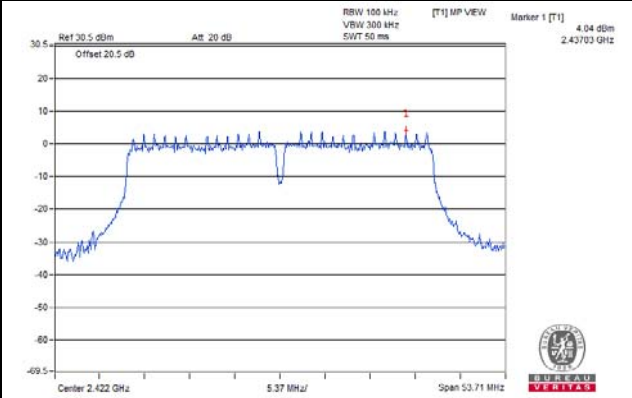

#### CH 6

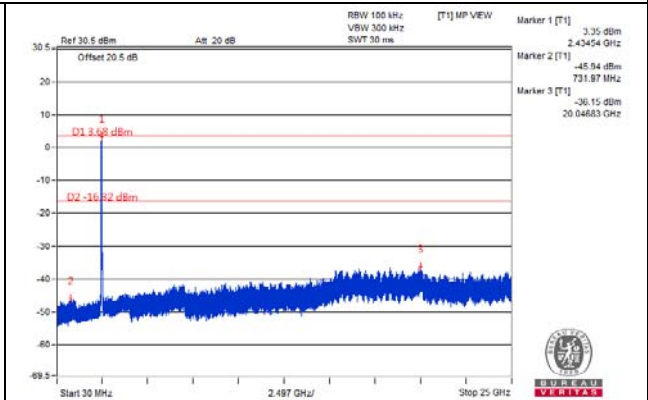
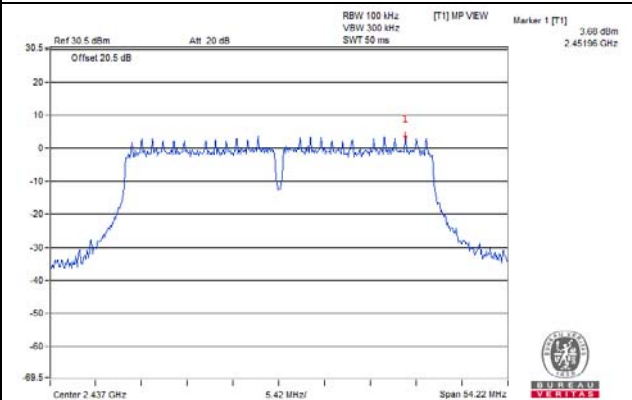

#### CH 9

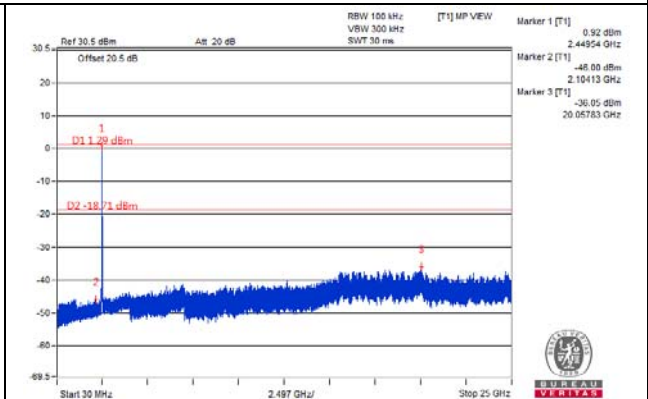
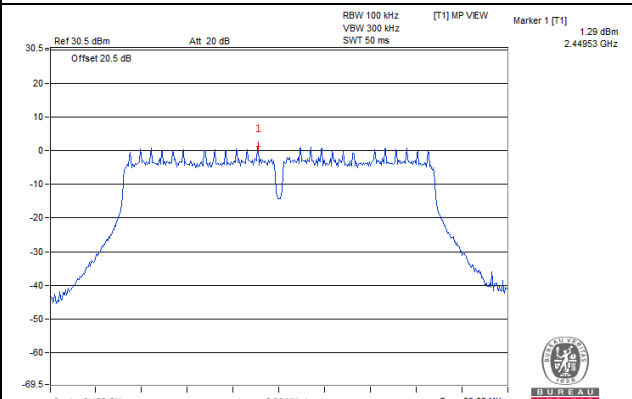

#### CH 3 Band edge

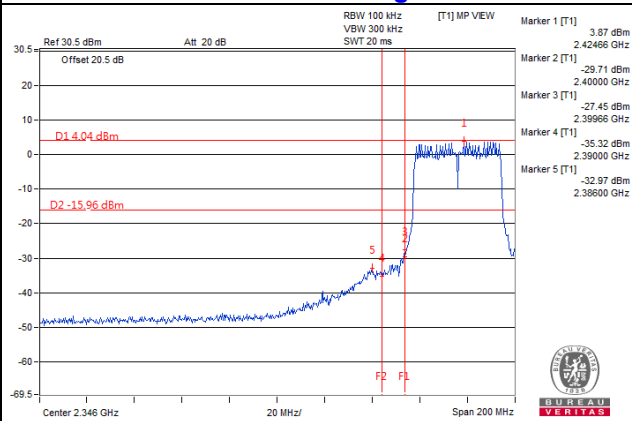

#### CH 9 Band edge

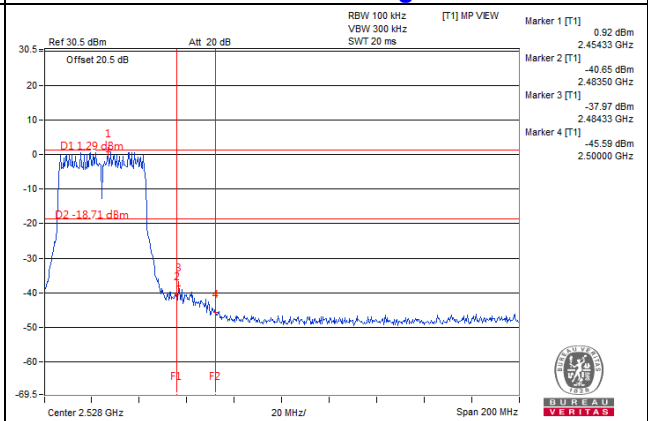

Chain 1

CH 3

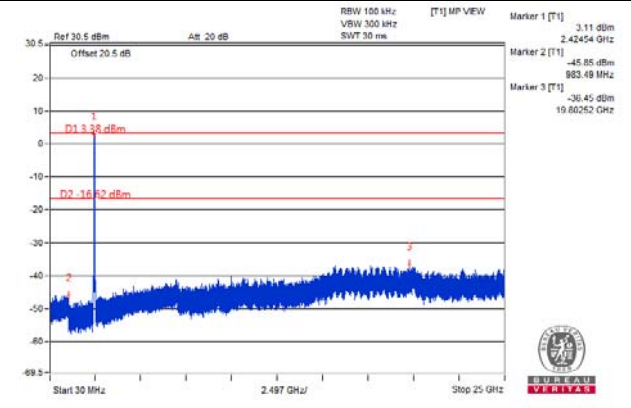
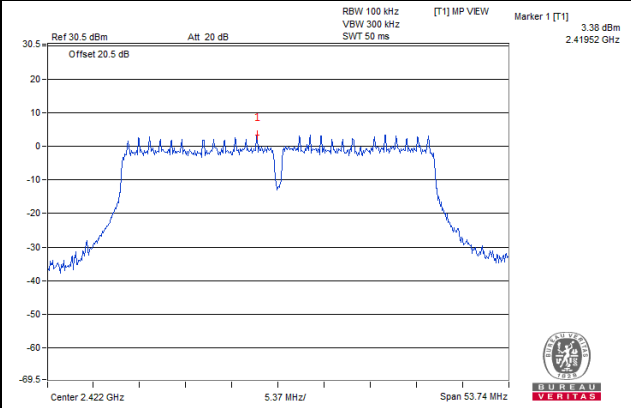

CH 6

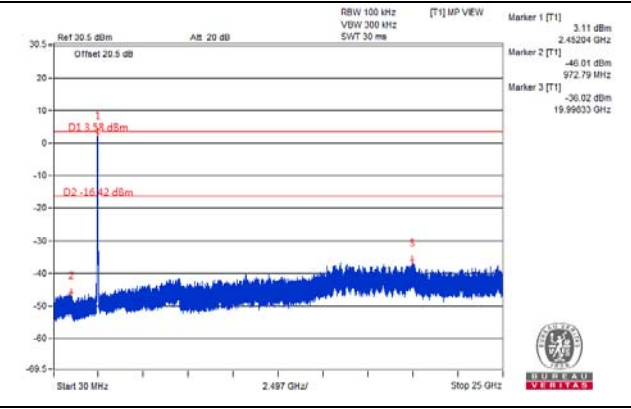
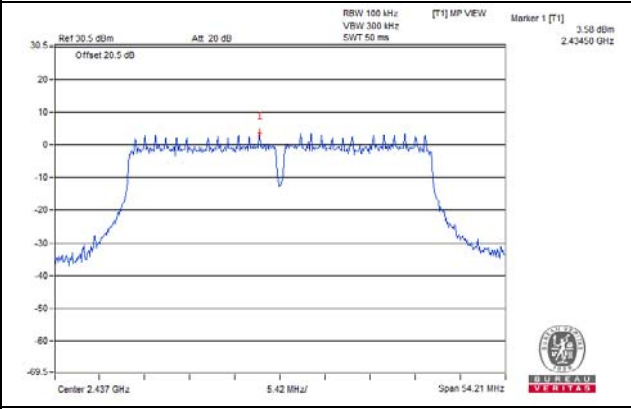

CH 9

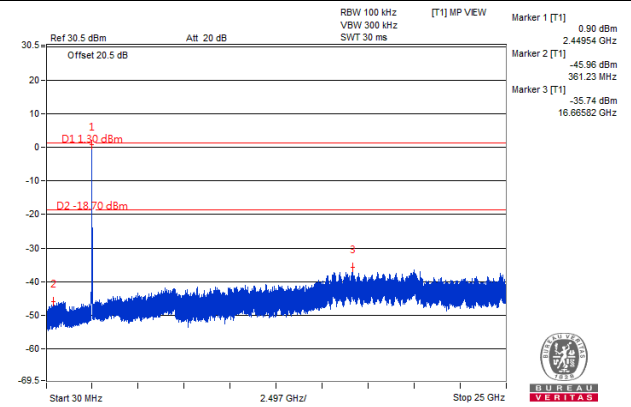
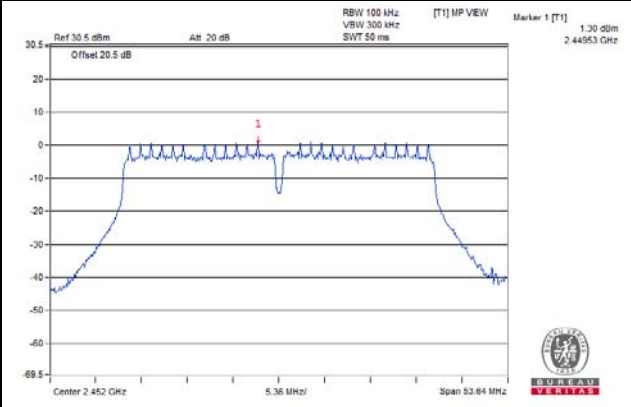

CH 3 Band edge

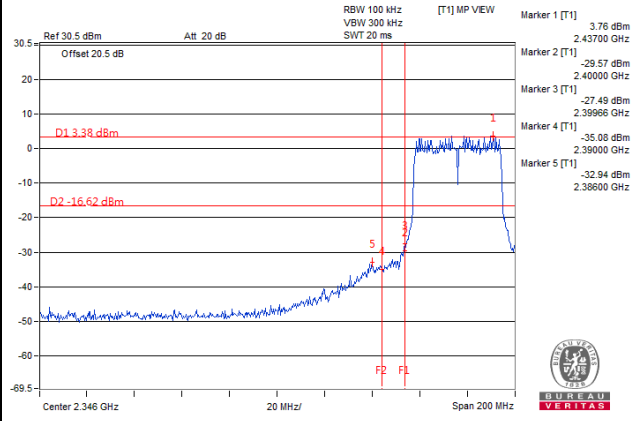

CH 9 Band edge

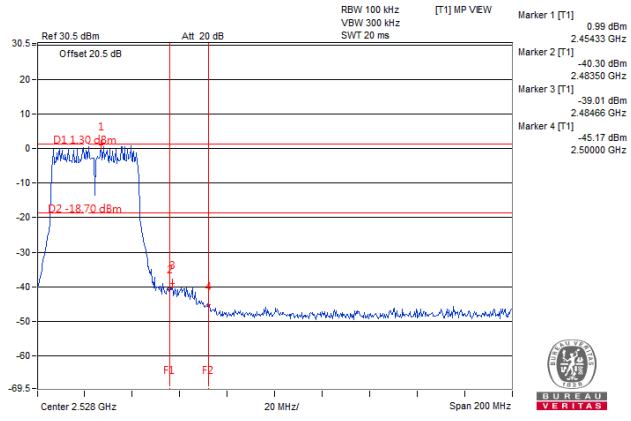

## 5 Pictures of Test Arrangements

Please refer to the attached file (Test Setup Photo).

## Appendix – Information of the Testing Laboratories

We, Bureau Veritas Consumer Products Services (H.K.) Ltd., Taoyuan Branch, were founded in 1988 to provide our best service in EMC, Radio, Telecom and Safety consultation. Our laboratories are FCC recognized accredited test firms and accredited according to ISO/IEC 17025.

If you have any comments, please feel free to contact us at the following:

**Lin Kou EMC/RF Lab**

Tel: 886-2-26052180

Fax: 886-2-26051924

**Hsin Chu EMC/RF/Telecom Lab**

Tel: 886-3-6668565

Fax: 886-3-6668323

**Hwa Ya EMC/RF/Safety Lab**

Tel: 886-3-3183232

Fax: 886-3-3270892

**Email:** [service.adt@tw.bureauveritas.com](mailto:service.adt@tw.bureauveritas.com)

**Web Site:** [www.bureauveritas-adt.com](http://www.bureauveritas-adt.com)

The address and road map of all our labs can be found in our web site also.

--- END ---