

Wireless Network Camera



User's Guide

Table of Contents

CHAPTER 1 INTRODUCTION.....	1
Overview	1
Physical Details - Network Camera	4
Package Contents	7
CHAPTER 2 BASIC SETUP	8
System Requirements.....	8
Installation - Network Camera.....	8
Setup using the Windows Wizard	10
CHAPTER 3 VIEWING LIVE VIDEO	15
Overview	15
Requirements.....	15
Connecting to a Camera on your LAN.....	15
Connecting to a Camera via the Internet	17
Viewing Live Video	19
CHAPTER 4 ADVANCED VIEWING SETUP	21
Introduction	21
Adjusting the Video Image	21
Controlling User Access to the Video Stream	24
Making Video available from the Internet.....	25
Viewing Live Video via the Internet	28
Motion Detection Alerts.....	29
CHAPTER 5 WEB-BASED MANAGEMENT	30
Introduction	30
Connecting to Network Camera.....	30
Welcome Screen.....	31
Administration Menu.....	32
System Screen	33
Network Screen.....	35
Wireless Screen.....	39
DDNS Screen	42
IP Filter	44
I/O Port.....	45
Streamings.....	46
Video & Audio Screen.....	49
Video Access Screen	51
User Database Screen.....	53
Motion Detection Screen.....	54
Audio Detection Screen.....	55
E-Mail Screen	56
FTP Screen.....	58
HTTP Screen	59
SD Card Screen	60
SMB/CIFS Client Screen	62
Event Trigger Screen	63
Maintenance Screen	65
Status Screen.....	67
Log Screen.....	69

CHAPTER 6 WINDOWS VIEWING/RECORDING UTILITY	70
Overview	70
System Requirements.....	70
Installation	70
System Tray Icon.....	71
LiveView Screen	72
Camera Setup	73
LiveView Program - for Streams Live Viewing.....	75
View Recordings Program - for Streams Recording.....	77
Setup Program - for Streams Configuration.....	79
CHAPTER 7 TROUBLESHOOTING	82
Overview	82
Problems.....	82
APPENDIX A SPECIFICATIONS.....	85
Network Camera	85
Regulatory Approvals	85
Copyright Notice.....	86
APPENDIX B NETWORK CAMERA HTTP CGI	87
User-level CGI commands (user level privilege).....	87
Admin-level CGI commands (administrator level privilege).....	102

Copyright © 2014. All Rights Reserved.

Document Version: 1.0

All trademarks and trade names are the properties of their respective owners.

Introduction

This Chapter provides details of the Network Camera's features, components and capabilities.

Overview

The Wireless Network Camera has an Integrated Microcomputer and a high quality Mega Pixel Omni Vision CMOS Sensor, enabling it to display high quality live streaming video over your wired LAN, the Internet, and for the Network Camera, an 802.11N Wireless LAN.

Using enhanced H.264 technologies, the Network Camera is able to stream high quality video and audio directly to your PC. The high compression capabilities of H.264 reduce network bandwidth requirements to amazingly low levels.

The Network Camera also features an SD (Secure Digital) card slot, which enables the users to read and write data to SD card inserted in the slot.

A convenient and user-friendly Windows program is provided for both viewing and recording video. If necessary, you can even view video using your Web Browser, on a variety of software platforms.

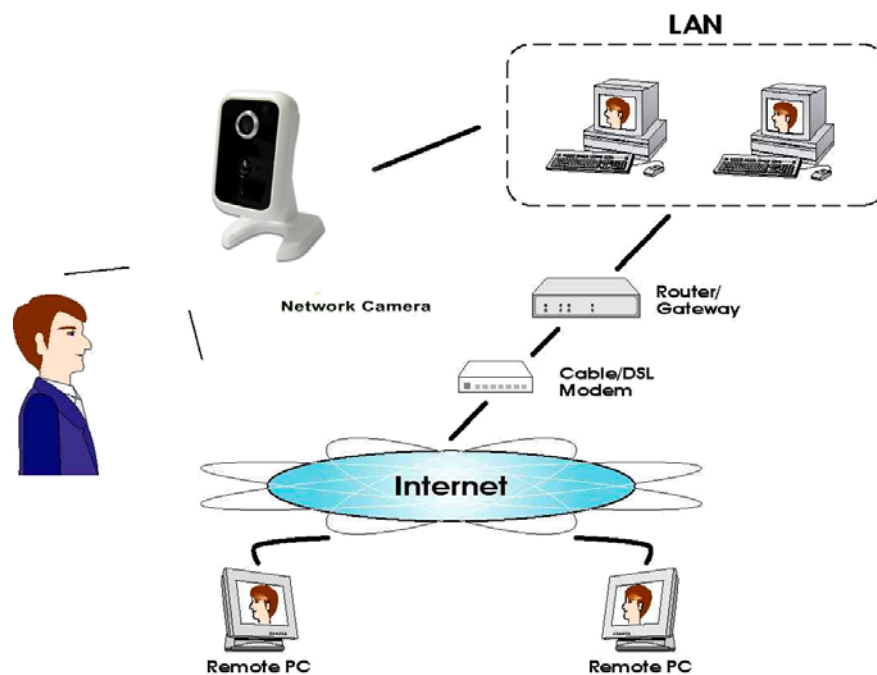

Figure 1: Network Camera

Features

- **Standalone Design.** The Network Camera is a standalone system with built-in CPU and Video encoder. It requires only a power source and a connection to your LAN or Wireless LAN.

- **Triple Video Support.** The Network Camera can support H.264, MPEG4 and MJPEG video for different image compression.
- **Stream Live Video to Multiple Users.** The video encoder and HTTP server built into the camera generate a ready-to-view video stream. Just connect to the camera using your Web browser or the provided Windows utility to view live video.
- **Suitable for Home, Business or Public Facilities.** Whether for Home, Business or Public Facility surveillance, or just for entertainment and fun, the Network Camera has the features you need.
- **SD Card Slot.** With the slot, you can insert the SD card to store recording files.
- **Multi-Protocol Support.** Supporting TCP/IP networking, SMTP (E-mail), HTTP and other Internet related protocols, the Network Camera can be easily integrated into your existing network.
- **Easy Configuration.** A Windows-based Wizard is provided for initial setup. Subsequent administration and management can be performed using a standard web browser. The administrator can configure and manage the Network Camera via the LAN or Internet.
- **PIR (Passive Infrared Sensor) Support.** The Network Camera is embedded with a PIR Sensor, which senses infrared light radiating from human bodies in its field of view. This feature is very helpful in enhancing home security systems.
- **Viewing/Recording Utility.** A user-friendly Windows utility is provided for viewing live video. For periods when you are absent, or for scheduled recording, this application also allows you to export video to your PC. The recorded files are in a standard Windows Media format, and thus usable by a wide variety of programs if required.
- **Motion Detection.** This feature can detect motion in the field of view. The Network Camera will compare consecutive frames to detect changes caused by the movement of large objects. This function only works indoors due to the sensitivity of the CMOS sensor. When motion is detected, an E-mail alert can be sent, or some other action may be triggered.
- **Flexible Scheduling.** You can limit access to the video stream to specified times using a flexible scheduling system. The Motion Detection feature can also have its own schedule, so it is active only when required.
- **Syslog Support.** If you have a Syslog Server, the Network Camera can send its log data to your Syslog Server.
- **Audio Support.** You can listen as well as look! Audio is encoded with the video if desired. With built-in microphone, it is useful for bi-direction voice conversation.

Internet Features

- **User-definable HTTP/HTTPS port number.** This allows Internet Gateways to use "port mapping" so the Network Camera and a Web Server can share the same Internet IP address.
- **DDNS Support.** In order to view video over the Internet, users must know the Internet IP address of the gateway used by the Network Camera. But if the Gateway has a dynamic IP address, DDNS (Dynamic DNS) is required. Since many existing Gateways do not support DDNS, this function is incorporated into the Network Camera.
- **NTP (Network-Time-Protocol) Support.** NTP allows the Network Camera to calibrate its internal clock from an Internet Time-Server. This ensures that the time stamp on Video from the Network Camera will be correct.

Security Features

- **User Authentication.** If desired, access to live video can be restricted to known users. Users will have to enter their username and password before being able to view the video stream.
- **Password-Protected Configuration.** Configuration data can be password protected, so that it only can be changed by the Network Camera Administrator.

Wireless Features

- **Supports 11n Wireless Stations.** The 802.11n Draft standard provides for backward compatibility with the 802.11b standard, so 802.11n, 802.11b and 802.11g Wireless stations can be used simultaneously.
- **Wired and Wireless Network Support.** The Network Camera supports either wired or wireless transmission.
- **WEP Support.** Full WEP support (64/128 Bit) on the Wireless interface is provided.
- **WPA/WPA2 Support.** The WPA Personal/WPA2 Personal standard is also supported, allowing advanced encryption of wireless data.
- **WPS Support.** WPS (Wi-Fi Protected Setup) can simplify the process of connecting any device to the wireless network by using the push button configuration (PBC) on the Wireless Access Point, or entering a PIN code if there's no button.

Physical Details – Wireless Network Camera

Front – Wireless Network Camera

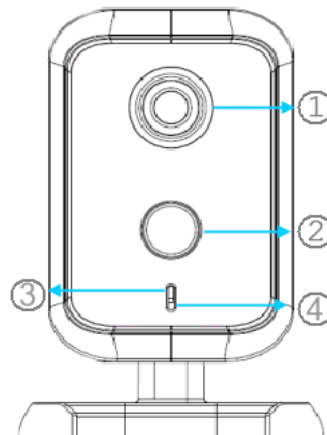

Figure 2: Front Panel

- | | |
|-----------------------|---|
| 1. Lens | No physical adjustment is required or possible for the lens, but you should ensure that the lens cover remain clean. The image quality is degraded if the lens cover is dirty or smudged. |
| 2. PIR Sensor | The PIR sensor is designed for human body detection. |
| 3. Privacy LED | On - The Privacy function is enabled.
Off - The Privacy function is disabled. |
| 4. Microphone | The built-in microphone is useful for bi-direction voice conversation. |

Rear – Wireless Network Camera

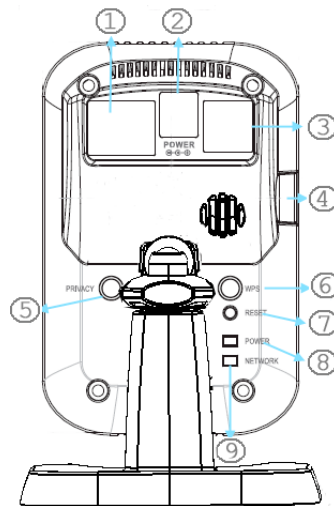

Figure 3: Rear Panel

1. LAN port

Use a standard LAN cable to connect your Network Camera to a 10/100BaseT hub or switch.

Note:

- Plugging in the LAN cable will disable the Wireless interface. Only 1 interface can be active at any time.
- The LAN cable should only be connected or disconnected when the camera is powered OFF. Attaching or detaching the LAN cable while the camera is powered on does NOT switch the interface between wired and wireless.

2. Power Input

Connect the supplied 12V power adapter here. Do not use other power adapters; doing so may damage the camera.

3. External Input/Output

The GPIO terminal block includes 1 input port and 1 output port. Please see the following *External I/O Port* section for more details.

4. Micro-SD Card slot

Insert the SD card into the slot, if required.

5. Privacy Button

On (Green) - The privacy mode is activated. User can not access to the video/audio from the camera.

Off - The privacy mode is not in use. User can get access to the video/audio from the camera.

6. WPS Button

Push the WPS button on the device and on your other wireless device to perform WPS function that easily creates an encryption-secured wireless connection automatically.

- **WPS PBC Mode.** When pressed and released (less than 3 seconds), the Network Camera will be in the WPS PBC mode (Auto link mode).
- **WPS Pin Code Mode.** When pressed and held for over 3 seconds, the Network Camera will be in the WPS Pin Code mode.

7. Reset Button

This button is recessed; you need a pin or paper clip can be used to

depress it. It can be activated at any time the camera is in the "ready" mode.

- **Reset to manufacturer default valued and reboot.** When pressed and held over 10 seconds, the settings of Network Camera will be set to their default values.

Note:

After this procedure is completed, the *Power* LED will blink three times to confirm that the reset was completed successfully.

8. Power LED (Green)

On - Power on.

Off - No power.

Blinking - The *Power* LED will blink during start up. This will take 55 to 57 seconds.

9. Network//WPS LED (Green, Amber)

On (Green) - Network (Wireless or LAN) connection is available.

Off - Wireless or LAN is not connected or camera is not sending/receiving data.

Blinking (Green) - Data is being transmitted or received via the LAN or Wireless connection.

On (Amber) - If the LED is on for 5 seconds, the WPS function is failed.

Blinking (Amber) - WPS function is being processed.

External I/O Port

The following is the I/O port image and the definition table:

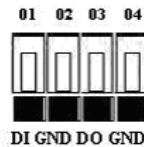

Pin Definition

Pin No	Function	Description
1	DI	Photo Coupler Input: Type: Photo coupler Isolated digital input port which can be used to connect DI/GND. Connect to DI/GND to activate or leave floating (or unconnected) to deactivate.
2	GND	DI/GND
3	DO	Open Collector Output: Type: NPN transistor Collector (Pin3) to emitter input voltage (Pin4):+24VDC Collector current: 100mA This output has an open collector NPN transistor with the emitter connected to GND (Pin4). If it is used with an external relay, a diode must be connected in parallel with the load for protection

		against any voltage transients.
4	GND	DO/GND

Package Contents

The following items should be included: If any of these items are damaged or missing, please contact your dealer immediately.

1. Wireless Network Camera
2. Camera Stand
3. Power adapter
4. Quick Installation Guide

Chapter 2

Basic Setup



This Chapter provides details of installing and configuring the Network Camera.

System Requirements

- To use the wired LAN interface, a standard 10/100BaseT hub or switch and network cable is required.
- To use the Wireless interface on the wireless model, other Wireless devices must be compliant with the IEEE802.11b, IEEE802.11g or IEEE 802.11n specifications. All Wireless stations must use compatible settings.



The default Wireless settings are:

Mode: Infrastructure
SSID: ANY
Wireless Security: Disabled
Domain: USA
Channel No.: Auto

Installation – Wireless Network Camera

1. Assemble the Camera

Attach the Camera Stand to the camera.

2. Connect the LAN Cable

Connect the Network Camera to a 10/100BaseT hub or switch, using a standard LAN cable.



For this Model, it will disable the Wireless Interface. The Wireless and LAN interfaces cannot be used simultaneously. Using the LAN interface is recommended for initial configuration. After the Wireless settings are correct, the Wireless interface can be used.

The first time you connect to the camera, you should connect the LAN cable and configure the Network Camera with appropriate settings. Then you can unplug the LAN cable and power off the camera. The Network Camera will be in wireless interface when you power on the camera again.

3. Power Up

Connect the supplied 12V power adapter to the Network Camera and power up. Use only the power adapter provided. Using a different one may cause hardware damage.

4. Check the LEDs

- The *Power* LED will turn on briefly, then start blinking. It will blink during startup, which takes 55 to 57 seconds. After startup is completed, the *Power* LED should remain ON.
- The *Network* LED should be ON.

For more information, refer to *Physical Details – Wireless Network Camera* in Chapter 1.

Setup using the Windows Wizard

Initial setup should be performed using the supplied Windows-based setup Wizard. This program can locate the Network Camera even if its IP address is invalid for your network. You can then configure the Network Camera with appropriate TCP/IP settings for your LAN.

Subsequent administration can be performed with your Web browser, as explained in *Chapter 5 - Web-based Management*.

Setup Procedure

1. Insert the supplied CD-ROM into your drive. If the setup program does not start automatically, run **NetworkCamera.exe** in the root folder.
 - You will see the *Welcome* screen shown below.
 - Click the *Setup Camera* button to start the setup Wizard



Figure 4: Welcome Screen

2. The next screen, shown below, will list all the Network Cameras on your LAN.

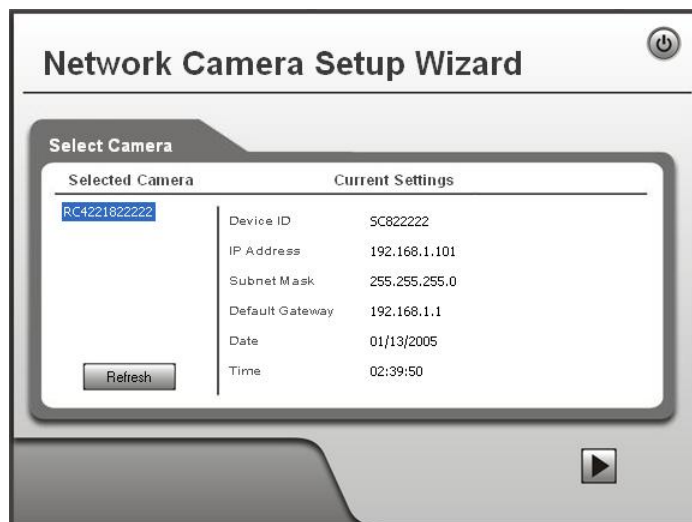

Figure 5: Camera List Screen

- Select the desired Camera from the list on the left. The current settings for the selected Camera will be displayed in the table on the right.
 - Click *Next* to continue.
3. You will be prompted to enter the *Administrator Name* and *Administrator Password*, as shown below.
- If using the default values, enter **administrator** for the name, and leave the password blank.
 - Otherwise, enter the *Administrator Name* and *Administrator Password* set on the *Maintenance* screen.



A dialog box titled "Password Dialog" with a blue title bar and a close button (X) in the top right corner. It contains two text input fields: "Administrator Name:" and "Administrator Password:". Below the fields are two buttons: "OK" and "Cancel".

Figure 6: Password Dialog

4. This screen allows you to enter a suitable **Description**, and set the correct **Time Zone**, **Date**, and **Time**. Make any desired changes, then click *Next* to continue.



The "Network Camera Setup Wizard" window shows the "Camera Settings" step. It features a "Selected Camera" list on the left with "RC4221822222" selected. The "Camera Settings" table on the right includes fields for "Device Name" (RC4221822222), "Description" (empty), "Time Zone" (dropdown menu showing "(GMT+08:00) Taipei"), "Date (MM/DD/YYYY)" (dropdown menu showing "01/13/2005"), and "Time (HH:MM:SS)" (dropdown menu showing "02:39:50"). There is also a checkbox for "Date and Time sync with PC" which is currently unchecked. Navigation arrows are visible at the bottom right.

Figure 7: Camera Settings

5. On the following **IP Address Settings** screen, shown below, choose *Fixed IP Address*, *Dynamic IP Address* or *PPPoE*.



Figure 8: Fixed or Dynamic IP Selection

- *Fixed IP Address* is recommended, and can always be used.
- *Dynamic IP Address* can only be used if your LAN has a DHCP Server.
- *PPPoE (PPP over Ethernet)* is the most common login method, widely used with DSL modems.

Click *Next* to continue.

6. If you chose *Fixed IP Address*, the following **TCP/IP Settings** screen will be displayed.

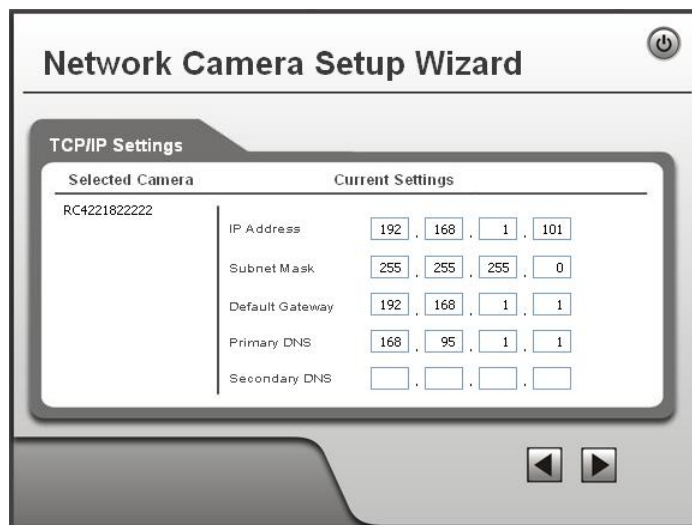

Figure 9: TCP/IP Settings

- Enter an unused **IP Address** from within the address range used on your LAN.
- The **Subnet Mask** and **Default Gateway** fields must match the values used by PCs on your LAN.
- The **Primary DNS** address is required in order to use the E-mail alert or Dynamic DNS features. Enter the DNS (Domain Name Server) address recommended by your ISP.
- The **Secondary DNS** is optional. If provided, it will be used if the Primary DNS is unavailable.

Click *Next* to continue.

7. If you chose *PPPoE*, the following **PPPoE Settings** screen will be displayed.

Selected Camera	Current Settings
RC4221822222	User Name: <input type="text"/>
	Password: <input type="text"/>

Figure 10: PPPoE Settings Screen

- Enter the **User Name** provided by your ISP.
- Enter the **Password** for the user name above.

Click *Next*.

8. The next screen, shown below, displays all details of the Network Camera.
 - Click *Next* if the settings are correct
 - Click *Back* to modify any incorrect values.

Selected Camera	New Settings
RC4221822222	Device Name RC4221822222
	IP Address 192.168.1.101
	Subnet 255.255.255.0
	Default Gateway 192.168.1.1
	Date 01/13/2005
	Time 02:39:50

Figure 11: Save Settings

9. Click *OK* to confirm that you want to save the new settings. If you want to cancel your changes, click *Cancel*.



Figure 12: Confirm Screen

10. After clicking *OK*, you will see the screen below.



Figure 13: Final Screen

Clicking the *Install Utility* button will install the Viewing/Recording utility described in **Chapter 6 - Windows Viewing/Recording Utility**.

11. Click *Exit* to end the Wizard.
Setup is now complete.

Chapter 3

3

Viewing Live Video

This Chapter provides basic information about viewing live video.

Overview

After finishing setup via the Windows-based Wizard, all LAN users can view live video using Internet Explorer on Windows.

This Chapter has details of viewing live video using Internet Explorer.

But many other powerful features and options are available:

- To view multiple cameras simultaneously, or record video (either interactively or by schedule), you should install the Windows Viewing/Recording utility. Refer to **Chapter 6 - Windows Viewing/Recording Utility** for details on installing and using this program.
- The camera administrator can also adjust the Video Stream, and restrict access to the video stream to known users by requiring viewers to supply a username and password. See **Chapter 4 - Advanced Viewing Setup** for details.
- To make Live Video from the camera available via the Internet, your Internet Gateway or Router must be configured correctly. See *Making Video available from the Internet* in **Chapter 4 - Advanced Viewing Setup** for details.

Requirements

To view the live video stream generated by the Network Camera, you need to meet the following requirements:

- Windows XP, 32-bit Windows Vista/Windows 7.
- Internet Explorer 6 or later, Firefox 3.0 or later.

Connecting to a Camera on your LAN

To establish a connection from your PC to the Network Camera:

1. Use the Windows utility to get the IP address of the Network Camera.
2. Start Internet Explorer.
3. In the Address box, enter "HTTP://" and the IP Address of the Network Camera.
4. When you connect, the following screen will be displayed.

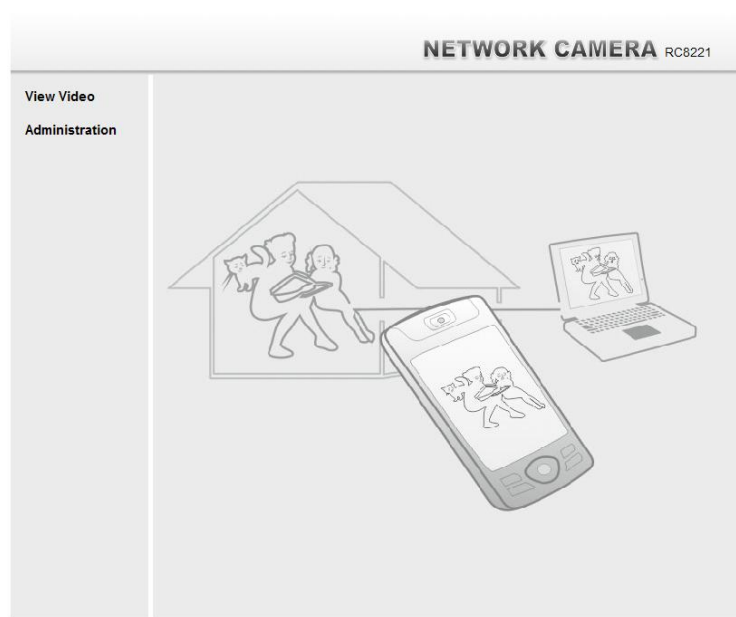

Figure 14: Home Screen

5. Click *View Video*.
6. If the Administrator has restricted access to known users, you will then be prompted for a username and password.
Enter the name and password assigned to you by the Network Camera administrator.
7. The first time you connect to the camera, you will be prompted to install an ActiveX component (OCX or CAB file), as in the example below.
You must install this ActiveX component (OCX or CAB file) in order to view the Video stream in Internet Explorer.
Click the "Yes" button to install the ActiveX component.



Figure 15: ActiveX OCX Prompt

8. Video will start playing automatically. There may be a delay of a few seconds while the video stream is buffered.

Connecting to a Camera via the Internet

You can NOT connect to a camera via the Internet unless the camera Administrator has configured both the camera and the Internet Gateway/Router used by the camera.

See *Making Video available from the Internet* in **Chapter 4 - Advanced Viewing Setup** for details of the required configuration.

Also, you need a broadband Internet connection to view video effectively. Dial-up connections are NOT supported.

To establish a connection from your PC to the Network Camera via the Internet:

1. Obtain the following information from the Administrator of the camera you wish to connect to:
 - Internet IP Address or Domain Name of the camera.
 - Port number for HTTP connections.
 - Login (username, password) if required.

2. Start Internet Explorer.

3. In the Address box, enter the following:

`HTTP://Internet_Address:port_number`

Where `Internet_Address` is the Internet IP address or Domain Name of the camera, and `port_number` is the port number used for HTTP (Web) connections to the camera.

Examples using an IP address:

`HTTP://203.70.212.52:1024`

Where the Internet IP address is 203.70.212.52 and the HTTP port number is 1024.

Example using a Domain Name:

`HTTP://mycamera.dyndns.tv:1024`

Where the Domain name (using DDNS in this example) is `mycamera.dyndns.tv` and the HTTP port number is 1024.

- When you connect, the following screen will be displayed.

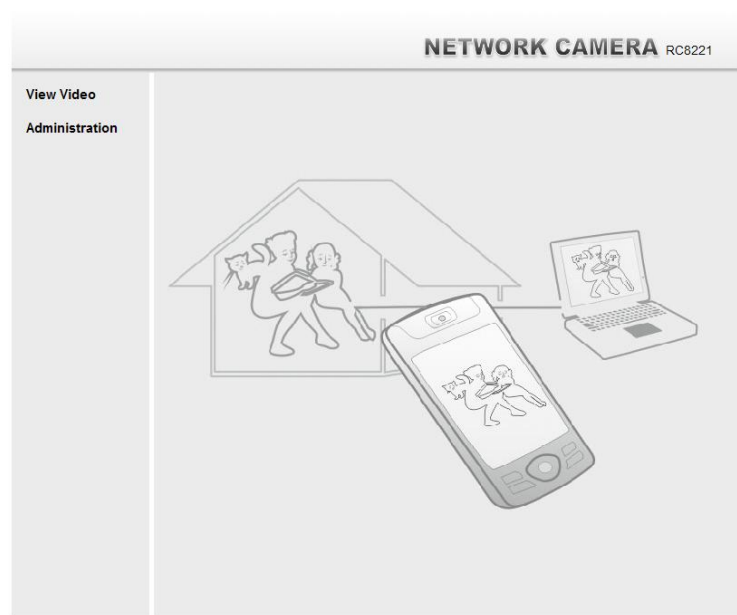

Figure 16: Home Screen

- Click *View Video*.
- If the Administrator has restricted access to known users, you will then be prompted for a username and password.
Enter the name and password assigned to you by the Network Camera administrator.
- The first time you connect to the camera, you will be prompted to install an ActiveX component (OCX or CAB file), as in the example below.
You must install this ActiveX component (OCX or CAB file) in order to view the Video stream in Internet Explorer.
Click the "Yes" button to install the ActiveX component.



Figure 17: ActiveX OCX Prompt

- Video will start playing automatically. There may be a delay of a few seconds while the video stream is buffered.

Viewing Live Video

After installing the ActiveX component, you will be able to view the live video stream in its own window, as shown below.

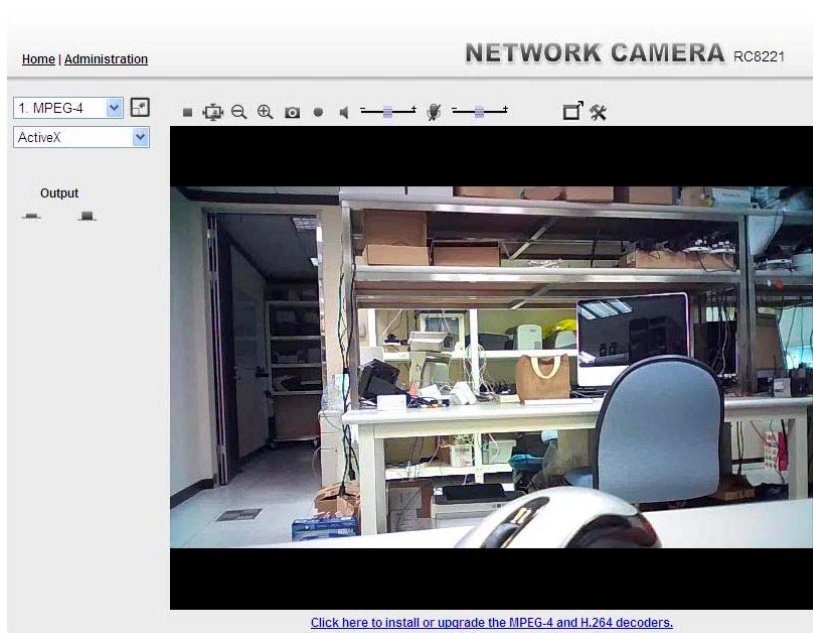

Figure 18: View Video Screen

There are a number of options available on this screen, accessed by select list, button or icon. See the table below for details.

Note: The options can only be configured while using IE browser. Other browsers can just view the video rather than configuration.

If after installing the OCX, the video still cannot be viewed, please install the decoders to solve this problem. You can install it from the following screens:

- Supplied Windows-based setup Wizard
- View Video Screen (preferred)

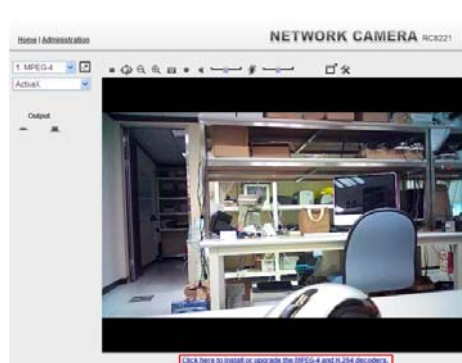















Figure 19: Install Decoders

- Motion Detection Screen

General Options

These options are always available, regardless of the type of camera you are connected to.

	Streaming. Use this drop-down list to select the desired streaming.
	Full Size. When using high-resolution mode (1280*720), click this button to see the full size of the image.
	Select the desired option from the drop-down list.
	Use this icon to start/stop viewing.
	Use this icon to make the image back to original size.
	Zoom Out. A digital zoom out feature is available. To zoom out the window, click this icon.
	Zoom In. A digital zoom in feature is available. To zoom in the window, click this icon.
	Snapshot. Click this to take a single JPEG "snapshot" image of the current video.
	Speaker On/Off. Use this button to turn the PC's speaker on or off.
	Microphone On/Off. Use this button to toggle the microphone on or off.
	Volume. If Speaker or Microphone is enabled, use this slider to adjust the volume.
	Full Screen Display. Click this button to see the full screen of the image.
	Setup. Select the desired folder to save the file.

Chapter 4

Advanced Viewing Setup



This Chapter provides information about the optional settings and features for viewing video via the Network Camera. This Chapter is for the Camera Administrator only.

Introduction

This chapter describes some additional settings and options for viewing live Video:

- Adjusting the video image
- Controlling user access to the live video stream
- Making video available from the Internet
- Using the *Motion Detection* feature

Adjusting the Video Image

If necessary, the Network Camera Administrator can adjust the Video image.

To Adjust the Video Image:

1. Connect to the Web-based interface of the Network Camera. (See *Chapter 5 - Web-based Management* for details.)
2. Select *Administration*, then *Streamings*. You will see a screen like the example below.



Figure 20: Streamings Screen

3. Make the required adjustments, as explained below, and save your changes.

Default Streaming Channel	Select the default channel for streaming from the drop-down list.
Streaming 1 Settings	
Video Format	Select the desired format from the list.
Resolution	Select the desired video resolution format.
Video Quality Control	<ul style="list-style-type: none"> • Constant Bit Rate: Select the desired bit rate. The default is set to 1.0 Mbps. • Fixed Quality: Select the desired option. The default fix quality is set to Normal.
Profile	<p>This is only for H.264 format only. There are 3 options:</p> <ul style="list-style-type: none"> • Baseline Profile • Main Profile • High Profile
Fixed Video Quality	<p>This option is for MJPEG format only. Select the desired option. The default fix quality is set to Normal.</p>
GOV Length	<p>Adjust the GOV interval in frame base. "2" means 1 I frame and 1 P Frame. "3" means 1 I frame and 2 P Frames. Enter the desired value between 2 and 150.</p>
Max. Frame Rate	<p>Select the desired Maximum frame rate for the video stream. The default value is 30.</p>
User Defined URI	<p>You may enter the URI up to 32 characters long for accessing the live video from camera through cell phone connection.</p>
Streaming 2/3 Settings	
Enable	Check the box if you want to enable the streaming.
Cropping (Streaming 3 Only)	Choose the desired option as required.
Video Format	Select the desired format from the list.
Resolution	Select the desired video resolution format.
Video Quality Control	<ul style="list-style-type: none"> • Constant Bit Rate: Select the desired bit rate. The default is set to 1.0 Mbps. • Fixed Quality: Select the desired option. The default fix quality is set to Normal.
Profile	<p>This is only for H.264 format only. There are 3 options:</p> <ul style="list-style-type: none"> • Baseline Profile • Main Profile • High Profile
Fixed Video Quality	<p>This option is for MJPEG format only. Select the desired option. The default fix quality is set to Normal.</p>
GOV Length	<p>Adjust the GOV interval in frame base. "2" means 1 I frame and 1 P Frame. "3" means 1 I frame and 2 P Frames. Enter the desired value between 2 and 150.</p>

Max. Frame Rate	Select the desired Maximum frame rate for the video stream. The default value is 30 .
User Defined URI	You may enter the URI up to 32 characters long for accessing the live video from camera through cell phone connection.

Controlling User Access to the Video Stream

By default, anyone can connect to the Wireless Network Camera and view live Video at any time.

If desired, you can limit access to scheduled times, and also restrict access to known users.

To Control User Access to Live Video:

1. Connect to the Web-based interface of the Network Camera. (See *Chapter 5 - Web-based Management* for details.)
2. Select *Administration*, then *Video Access*.
3. Set the desired options for **Access**.

Access

Select the desired option as required:

- If the **User Access** is enabled, users will be prompted for a username and password when they connect to the camera for viewing video.
- When Video Access is enabled, viewing video is only available during the scheduled periods, and unavailable at other times. If this option is selected, you need to define a schedule; otherwise it is always disabled.

However, viewing video is still possible by logging in as the Administrator.

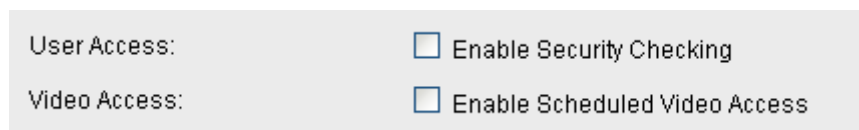

User Access:	<input type="checkbox"/> Enable Security Checking
Video Access:	<input type="checkbox"/> Enable Scheduled Video Access

Figure 21: Controlling User Access

See *Chapter 5 - Web-based Management* for further details about using the *Video Access* and *User Database* screens.

Making Video available from the Internet

If your LAN is connected to the Internet, typically by a Broadband Gateway/Router and Broadband modem, you can make the Network Camera available via the Internet. You will need to configure your Router or Gateway to allow connections from the Internet to the camera.

Router/Gateway Setup

Your Router or Gateway must be configured to pass incoming TCP (HTTP) connections (from Internet Viewers) to the Network Camera. The Router/Gateway uses the *Port Number* to determine which incoming connections are intended for the Network Camera.

This feature is normally called *Port Forwarding* or *Virtual Servers*, and is illustrated below. The Port Forwarding/Virtual Server entry tells the Router/Gateway that incoming TCP connections on port 1024 should be passed to the Network Camera. If necessary, check the user manual for your Router/Gateway for further details.

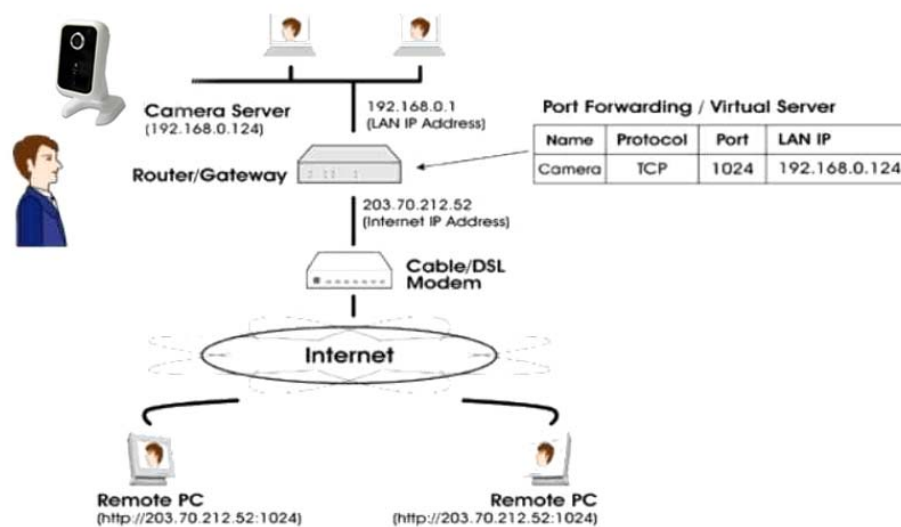

Figure 22: Connecting via the Internet



The "Port" for the *Port Forwarding / Virtual Server* entry above is the "Secondary Port" number specified on the *Network* screen of the Network Camera.

Network Camera Setup

The Wireless Network Camera configuration does NOT have to be changed, unless:

- You wish to change the port number from the default value.
- You wish to use the DDNS (Dynamic DNS) feature of the Network Camera.

HTTPS Port Configuration

Normally, HTTP (Web) connections use port 80. Since the Network Camera uses HTTP, but port 80 is likely to be used by a Web Server, you can use a different port for the Network Camera. This port is called the *Secondary Port*.

The default *HTTP/HTTPS Secondary Port* is 1024/1025. If you prefer to use a different port number, you can specify the port number on the Network Camera's **Network** screen, as shown below.

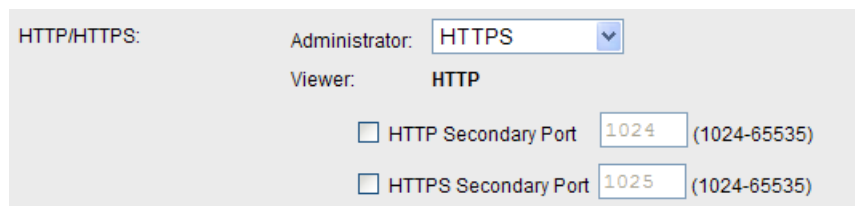

HTTP/HTTPS: Administrator: HTTPS
Viewer: HTTP
 HTTP Secondary Port 1024 (1024-65535)
 HTTPS Secondary Port 1025 (1024-65535)

Figure 23: Network Screen

See *Chapter 5 - Web-based Management* for further details on using the **Network** screen.



Viewers need to know this port number in order to connect and view live Video, so you must inform viewers of the correct port number.

DDNS (Dynamic DNS)

Many internet connections use a "Dynamic IP address", where the Internet IP address is allocated whenever the Internet connection is established.

This means that other Internet users don't know the IP address, so can't establish a connection.

DDNS is designed to solve this problem, by allowing users to connect to your LAN using a domain name, rather than an IP address.

To use DDNS:

1. Register for the DDNS service with a supported DDNS service provider. You can then apply for, and be allocated, a Domain Name.
2. Enter and save the correct DDNS settings on the **DDNS** screen of the Network Camera.
3. Both Router and Camera should use the same port number for DDNS service.

Home | View Video | Logout **NETWORK CAMERA** RC8221

Setup Enable DDNS

System
Network
Wireless
DDNS
IP Filter
I/O Port

Service Provider: DynDNS.org

Domain (Host) Name:

Account/E-Mail:

Password/Key:

Check WAN IP Address: Every 24 Hrs

Starting at 12 Hour(s) 00 Minute(s)

Video & Audio

Streamings
Video & Audio
Video Access
User Database

Event

Motion Detection
Audio Detection
E-Mail
FTP
HTTP
SD Card
SMB/CIFS Client
Event Trigger

Administration

Maintenance
Status
Log

Figure 24: DDNS Screen

4. Operation is then automatic:

- The Network Camera will automatically contact the DDNS server whenever it detects that the Internet IP address has changed, and inform the DDNS server of the new IP address.
- Internet users can then connect to the camera using the Domain Name allocated by the DDNS service provider.

Example: HTTP://mycamera.dyndns.tv:1024

mycamera.dyndns.tv is domain host name. 1024 is the port number.

Viewing Live Video via the Internet

Clients (viewers) will also need a broadband connection; dial-up connections are NOT recommended.

Viewing Live Video Using your Web Browser

If using your Web browser, you need to know the Internet IP address (or the Domain name) of the camera's Router/Gateway, and the correct port number.

Enter the Internet address of the Router/Gateway, and its port number, in the *Address* (or *Location*) field of your Browser.

Example - IP address:

HTTP://203.70.212.52:1024

Where the Router/Gateway's Internet IP address is 203.70.212.52 and the "Secondary Port" number on the Network Camera is 1024.

Example - Domain Name:

HTTP://mycamera.dyndns.tv:1024

Where the Router/Gateway's Domain name is mycamera.dyndns.tv and the "Secondary Port" number on the Network Camera is 1024.

Viewing Live Video with the Viewing/Recording Utility

If using the Windows Viewing/Recording Utility, the details of the Network Camera must be entered on the *Setup* screen.

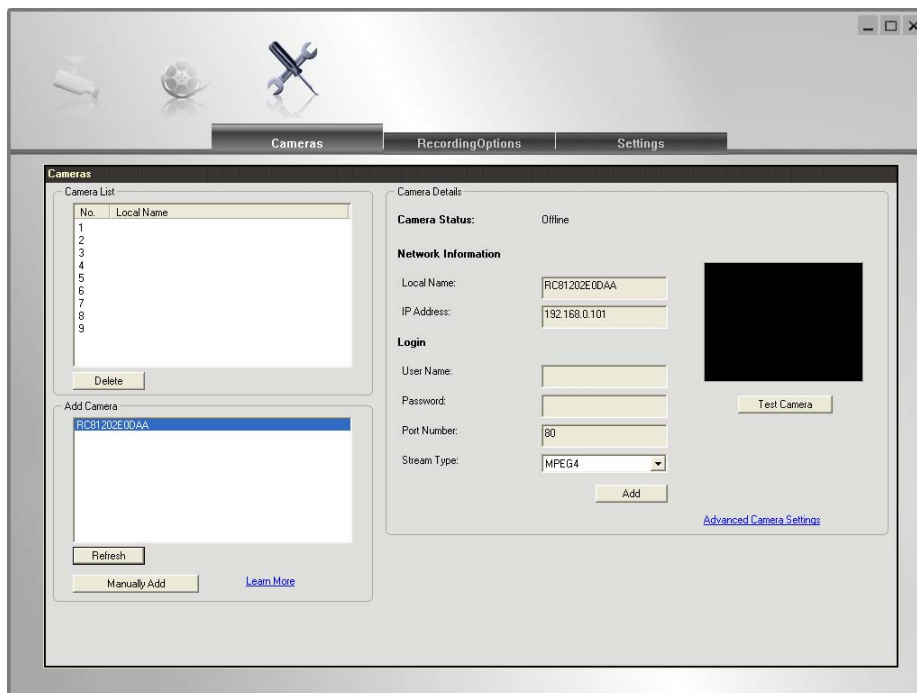

Figure 25: Add Camera from LAN

See *Chapter 6 - Window Viewing/Recording Utility* for full details on using the Windows Viewing/Recording utility.

Motion Detection Alerts

The *Motion Detection* feature can generate an Alert when motion is detected.

The Network Camera will compare consecutive frames to detect changes caused by the movement of large objects.

But the motion detector can also be triggered by:

- Sudden changes in the level of available light
- Movement of the camera itself.

Try to avoid these situations. The motion detection feature works best in locations where there is good steady illumination, and the camera is mounted securely. It cannot be used outdoors due to the sensitivity of the CMOS sensor.

Note: The Motion Detection settings can only be configured while using IE browser.

To Use Motion Detection Alerts

Using the Web-based interface on the Network Camera, select the *Motion Detection* screen, then configure this screen as described below.

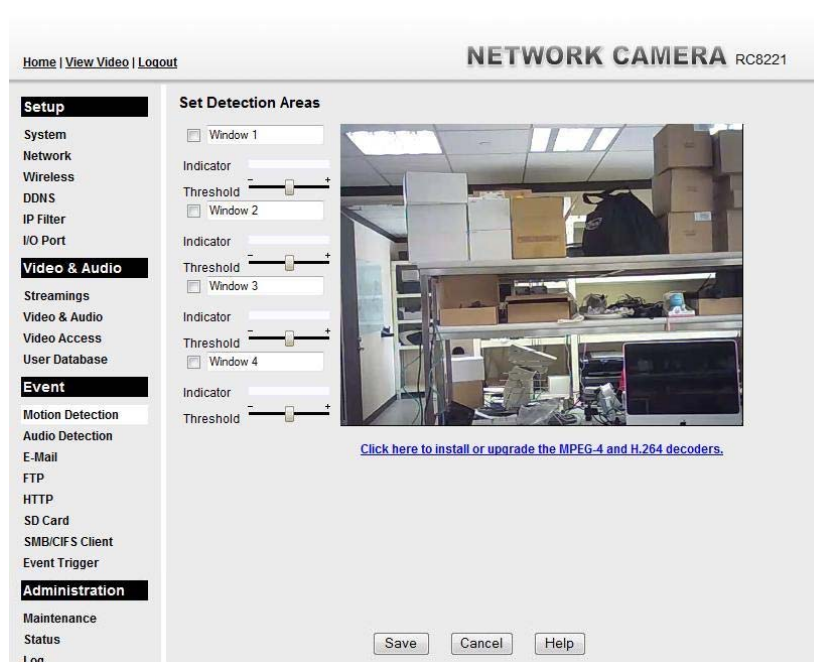

Figure 26: Motion Detection

1. Enable the *Motion Detection* feature.
2. Set the area or areas of the video image to be examined for movement. You can define up to 4 areas, and set the motion threshold individually for each area.
3. If using a schedule, define the desired schedule in *Event Trigger* screen.
4. Save your changes.



If the Motion Detection feature is enabled, but the related options in the *Event Trigger* screen are not enabled, then the only action when motion is detected is to log this event in the system log.

Chapter 5

5

Web-based Management

This Chapter provides Setup details of the Network Camera's Web-based Interface. This Chapter is for the Camera Administrator only.

Introduction

The Wireless Network Camera can be configured using your Web Browser. The Network Camera must have an IP address which is compatible with your PC.

The recommended method to ensure this is to use the supplied Windows-based Wizard, as described in *Chapter 2 - Basic Setup*.

Connecting to Network Camera

- If using only your Web Browser, use the following procedure to establish a connection from your PC to the Network Camera:
- Once connected, you can add the Network Camera to your Browser's *Favorites* or *Bookmarks*.

Connecting using your Web Browser

1. Use the Windows utility to get the IP address of the Network Camera.
2. Start your WEB browser.
3. In the Address box, enter "HTTP://" and the IP Address of the Network Camera.
4. You will then be prompted for a username and password.
 - If using the default values, enter **administrator** for the name, and leave the password blank.
 - Otherwise, enter the *Administrator ID* and *Administrator Password* set on the *Maintenance* screen.

Welcome Screen

When you connect, the following screen will be displayed.

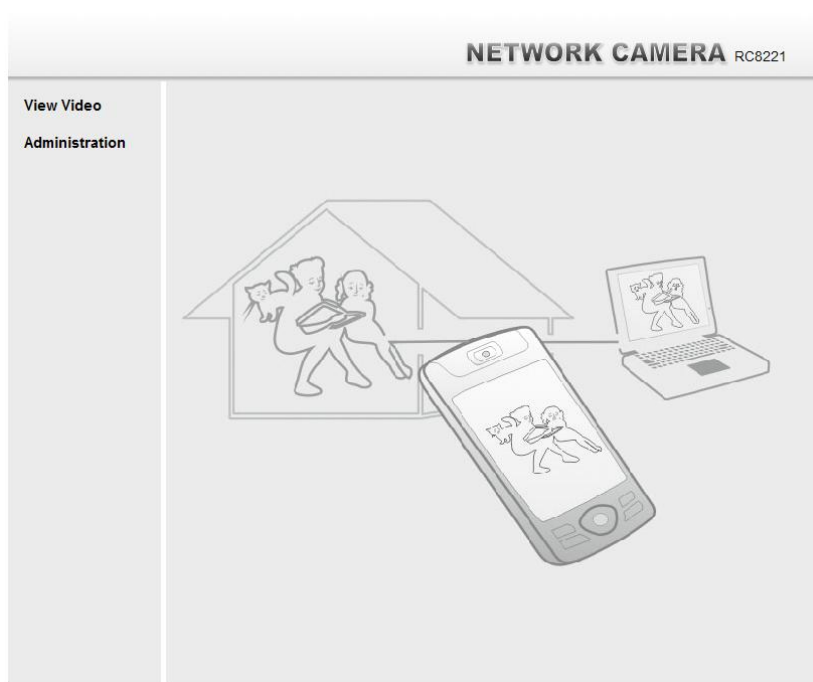

Figure 27: Welcome Screen

The menu options available from this screen are:

- **View Video** - View live Video using your Web Browser. See *Chapter 3 - Viewing Live Video* for details.
- **Administration** - Access the Administration menu.

Administration Menu

Clicking on *Administration* on the menu provides access to all the settings for the Network Camera.

The *Administration* menu contains the following options:

Setup

- System
- Network
- Wireless
- DDNS
- IP Filter
- I/O Port

Video & Audio

- Streaming
- Video & Audio
- Video Access
- User Database

Event

- Motion Detection
- Audio Detection
- E-Mail
- FTP
- HTTP
- SD Card
- SMB/CIFS Client
- Event Trigger

Administration

- Maintenance
- Status
- Log

System Screen

After clicking *Administration* on the main menu, or selecting *System* on the *Administration* menu, you will see a screen like the example below.

Figure 28: System Screen

Data - System Screen

System Settings	
Device ID	This displays the ID for the Network Camera.
Camera Name	Enter the desired name for the Network Camera.
Description	This field is used for entering a description, such as the location of the Network Camera.
Date & Time	
Date Format	<p>Select the desired date format, it will also be used to display the date and time as an overlay on the video image.</p> <p>The abbreviations used to predefine the date formats are list as follows:</p> <ul style="list-style-type: none"> • YYYY-MM-DD = Year-Month-Day, e.g. 2006-01-31 • MM/DD/YYYY = Month/Day/Year, e.g. 01/31/2006 • DD/MM/YYYY = Day/Month/Year, e.g. 31/01/2006
Current Date & Time	<p>This displays the current date and time on the camera.</p> <p>If it's not correct, click the Change button to modify the date/time settings. This button will open a sub-screen where you have 2 options:</p> <ul style="list-style-type: none"> • Set the camera's date and time to match your PC. • Enter the correct date and time.

Time Zone	Choose the Time Zone for your location from the drop-down list. If your location is currently using Daylight Saving, please enable the Adjust for daylight saving checkbox.
Network Time Protocol	Enable or disable the Time Server feature as required. If Enabled, the Network Camera will contact a Network Time Server at regular intervals and update its internal timer.
NTP Server Address	Enter the address for the desired NTP server.
Update	The Schedule determines how often the Network Camera contacts the NTP Server. Select the desired options.
LED Operation Privacy Button	Enable this if you want to use this function. If Enabled, click the <i>Privacy</i> button will stop uploading the stream without turning the camera off. Click the button one more time to continue uploading. The default is Enabled.

Network Screen

This screen is displayed when the *Network* option is clicked.

The screenshot shows the 'Network Screen' for a 'NETWORK CAMERA RC8221'. The page has a top navigation bar with 'Home | View Video | Logout' and a title 'NETWORK CAMERA RC8221'. On the left is a sidebar menu with categories: Setup (highlighted), System, Network, Wireless, DDNS, IP Filter, I/O Port, Video & Audio, Streamings, Video & Audio, Video Access, User Database, Event, Motion Detection, Audio Detection, E-Mail, FTP, HTTP, SD Card, SMB/CIFS Client, Event Trigger, Administration, Maintenance, Status, and Log. The main content area is divided into sections for network configuration:

- Internet Connection Type:** Obtain Address Automatically (DHCP) (selected)
- DNS Server Address:** Obtain DNS server address automatically (radio button), Use the following DNS server address (radio button selected).
 - Primary DNS server: 168, 95, 1, 1 (IP address)
 - Secondary DNS server: [][][][] (IP address)
- WINS Address:** It takes effect only when the "SMB/CIFS" is enabled.
 - Obtain WINS address automatically (radio button selected)
 - Use the following WINS address (radio button)
- HTTP/HTTPS:** Administrator: HTTP (dropdown), Viewer: HTTP.
 - HTTP Secondary Port: 1024 (1024-65535) (checkbox)
- RTP/RTSP:**
 - RTSP Port: 554 (554, 1024-65535)
 - RTP Data Port: 5000 (1024-65494, even values only)
 - Max RTP Data Packet: 1400 bytes (400-1400)
- Multicast RTP/RTSP:** Enable Multicast (checkbox).
 - Video Address: 224, 2, 0, 1 (Streaming 1 only)
 - Video Port: 2290 (1024-65534, even values only)
 - Audio Address: 224, 2, 0, 1
 - Audio Port: 2292 (1024-65534, even values only)
 - Time to Live: 16 (1-255)
- UPnP:** Enable Discovery (checkbox checked), Enable Traversal (Port Mapping) (checkbox)
- Bonjour:** Enable Bonjour Service (checkbox checked)
- QoS:** Enable QoS Mode (for Video and Audio) (checkbox).
 - DSCP: 32 (0-63)

At the bottom are buttons for 'Save', 'Cancel', and 'Help'.

Figure 29: Network Screen

Data - Network Screen

Network	
Internet Connection Type	<p>There are 3 connection types:</p> <ul style="list-style-type: none"> • Obtain Address Automatically (DHCP): If selected, the Network Camera will obtain its IP address and related information from a DHCP Server. Only select this option if your LAN has a DHCP Server. • Static IP Address: If selected, you must assign the following data to the Network Camera. <ul style="list-style-type: none"> • IP Address - Enter an unused IP address from the address range used on your LAN. • Subnet Mask - Use the same value as PCs on your LAN. • Default Gateway - Use the same value as PCs on your LAN. • PPPoE (PPP over Ethernet): This is the most common login method, widely used with DSL modems. Normally, your ISP will have provided some software to connect and login. This software is no longer required, and should not be used. <ul style="list-style-type: none"> • Username - The user name (or account name) provided by your ISP. • Password - Enter the password for the login name above.
Obtain DNS server address automatically	<p>If selected, the Network Camera will use the DNS address or addresses provided by the DHCP server. This option is only available if the IP address setting is <i>Obtain an IP address Automatically</i>.</p>
Use the following DNS server address	<p>Primary DNS server - Use the same value as PCs on your LAN. Normally, your ISP will provide this address.</p> <p>Secondary DNS server - This is optional. If entered, this DNS will be used if the Primary DNS does not respond.</p>
WINS Address	<p>There are 2 options:</p> <ul style="list-style-type: none"> • Obtain WINS address automatically - If selected, the Network Camera will obtain its IP address from DHCP server. • Use the following WINS address - Enter the IP address of your WINS server.

HTTP/HTTPS	<p>This sets the port number for HTTP/HTTPS connections to the Camera, whether for administration or viewing video.</p> <p>The HTTP (HyperText Transfer Protocol) is used for the standard of transferring files (text, graphic images and other multimedia files) on the World Wide Web. The default HTTP port is 1024.</p> <p>HTTPS (Hypertext Transfer Protocol Secure) can provide more secure communication with the SSL/TLS protocol, which support data encryption to HTTP clients and servers. The default HTTPS port is 1025.</p> <p>The Secondary port can be used for DDNS, other service and when more than 2 cameras are in use.</p> <p>If enabled, you can connect using either port 80 or the Secondary port. You must enter the Secondary port number (between 1024 to 65535) in the field provided.</p> <p>Note that when using a port number which is not 80, you must specify the port number in the URL. For example, if the Camera's IP address was 192.168.1.100 and the Secondary port was 1024, you would specify the URL for the Camera as follows:</p> <p style="text-align: center;">http://192.168.1.100:1024</p>
RTP/RTSP	<p>The RTSP (Real Time Streaming Protocol), a standard for connected client(s) to control streaming data (MPEG-4) over the World Wide Web. Enter the RTSP Port number (between 1024 and 65535) in the field provided. The default RTSP Port is 554.</p> <p>The RTP (Real Time Transport Protocol), an Internet protocol for transmitting real-time data such as audio and video.</p> <p><i>Max RTP Data Packet</i> field will let users limit the size of the file. Enter the desired value between 400 and 1400.</p> <p>Note: RTSP and RTP settings are for cell phone only.</p>
Multicast RTP/RTSP	
Enable Multicast	Enable the feature as required.
Video Address	Enter the address of video (Streaming 1 only).
Video Port	Enter the desired value (between 1024 to 65534) in the field provided. The number you entered must be even values.
Audio Address	Enter the address of the audio.
Audio Port	Enter the desired value (between 1024 to 65534) in the field provided. The number you entered must be even values.
Time to Live	Enter the desired length of time, if the packets fail to be delivered to their destination within. The Time to Live you entered must be in-between 1 to 255.
UPnP	
Enable Discovery	If enabled, the Network Camera will broadcast its availability through UPnP. UPnP compatible systems such as Windows XP will then be able to detect the presence of the Network Camera.

Enable Traversal	If enabled, HTTP connections (from your Web Browser or the Viewer and Recorder utility) can use secondary port instead of port 80 (the standard HTTP port) to access the camera.
Bonjour	
Enable Bonjour Service	If enabled, the Network Camera can be accessed through a "Bonjour" enabled browser, such as Microsoft Internet Explorer (with a Bonjour plug-in) or Safari browser. You can also find other Bonjour-enabled devices on your network.
QoS	
Enable QoS Mode	If enabled, the throughput level (for Video and Audio) is guaranteed through QoS (Quality of Service).
DSCP	Enter the desired value of Differentiated Services Code Point (DSCP). The value must be between 0 and 63.

Wireless Screen

This screen is displayed when the *Wireless* menu option is clicked.

The screenshot shows the 'Wireless Network' configuration page for a NETWORK CAMERA RC8221. The page has a sidebar menu on the left with categories: Setup (System, Network, Wireless, DDNS, IP Filter, I/O Port), Video & Audio (Streamings, Video & Audio, Video Access, User Database), Event (Motion Detection, Audio Detection, E-Mail, FTP, HTTP, SD Card, SMB/CIFS Client, Event Trigger), and Administration (Maintenance, Status, Log). The main content area is titled 'Wireless Network' and includes the following fields:

- Site Survey:
- WSC PIN Code: 85284180
- Network Type: Infrastructure (dropdown)
- SSID: WRT300N-UK
- Domain: USA (dropdown)
- Channel No.: Auto (dropdown)
- Security System: WPA/WPA2 Personal (dropdown)
- Shared Key: (8 to 63 characters or 64 hex characters)

At the bottom of the form are three buttons: Save, Cancel, and Help.

Figure 30: Wireless Screen

Data - Wireless Screen

Wireless Network	
Site Survey	Click the "Site Survey" button and select from a list of available APs.
WSC PIN Code	It displays the WSC PIN code number for the camera.
Network Type	This determines the type of wireless communication used by the Network Camera. <ul style="list-style-type: none"> • If you have an Access Point, select <i>Infrastructure</i>. • Otherwise, select <i>Ad-hoc</i>.
SSID	This must match the value used by other devices on your wireless LAN. The Default is ANY . Note! The SSID is case sensitive.
Domain	Select your region from the drop-down list.

Channel No.	<ul style="list-style-type: none"> • In <i>Infrastructure</i> mode, this setting is ignored. The Network Camera will use the Channel set on the Access Point. • For <i>Ad-hoc</i> mode, select the Channel you wish to use on your Network Camera. Other Wireless stations should use the same setting. • If you experience interference (shown by lost connections and/or slow data transfers) you may need to experiment with different channels to see which one is the best.
Security	
Security System	<p>Select the desired option, and then enter the settings for the selected method:</p> <ul style="list-style-type: none"> • Disabled - No security is used. Anyone using the correct SSID can connect to your network. This is default. • WEP - The 802.11b standard. Data is encrypted before transmission, but the encryption system is not very strong. • WPA/WPA2 Personal - Like WEP, data is encrypted before transmission. WPA is more secure than WEP, and should be used if possible. WPA Personal is the version of WPA which does NOT require a Radius Server on your LAN.
WEP	
Authentication Type	<p>Normally this can be left at the default value of "Automatic." If that fails, select the appropriate value - "Open System" or "Shared Key." Check your wireless card's documentation to see what method to use.</p> <p>Note: In <i>Infrastructure</i> mode, either setting will normally work, since most Access Points can use both methods.</p>
WEP Encryption	<p>Select the WEP Encryption level:</p> <ul style="list-style-type: none"> • 64 Bit Keys (10 Hex chars) • 128 Bit Keys (26 Hex chars) • 64 Bit Keys (5 ASCII chars) • 128 Bit Keys (13 ASCII chars)
Passphrase	<p>Enter a word or group of printable characters in the Passphrase box and click the "Generate Key" button to automatically configure the WEP Key(s). If encryption strength is set to 64-bit, then each of the four key fields will be populated with key values. If encryption strength is set to 128-bit, then only the selected WEP key field will be given a key value.</p>
WEP Keys	<ul style="list-style-type: none"> • Use the radio buttons to select the default key. • Enter the key value you wish to use. Other stations must have the same key values. • Keys must be entered in Hex. Hex characters are the digits (0 ~ 9) and the letters A ~ F. • Click <i>Clear Keys</i> to set the Keys to be blank.

WPA/WPA2 Personal**Shared Key**

Enter the key value. Data is encrypted using a key derived from the network key. Other Wireless Stations must use the same network key. The PSK must be from 8 to 63 characters or 64 hex characters in length.

DDNS Screen

Many Internet connections use a "Dynamic IP address", where the Internet IP address is allocated whenever the Internet connection is established.

This means that other Internet users don't know the IP address, so can't establish a connection.

DDNS is designed to solve this problem, as follows:

- You must register for the DDNS service with a DDNS service provider. The DDNS Service provider will allocate a Domain Name to you upon request.
- The DDNS settings on the **DDNS** screen above must be correct.
- The Network Camera will then contact the DDNS server whenever it detects that the Internet IP address has changed, and inform the DDNS server of the new IP address. (The *Check WAN IP Address* determines how often the Network Camera checks if the Internet IP address has changed.)

This system allows other internet users to connect to you using the Domain Name allocated by the DDNS service provider.

This screen is displayed when the **DDNS** menu option is clicked.

Figure 31: DDNS Screen

Data - DDNS Screen

DDNS	
Enable DDNS	Enable or disable the DDNS function, as required. Only enable this feature if you have registered for the DDNS Service with a DDNS Server provider.
Service Provider	Choose a service provider from the list.
Web Site Button	Click this button to open a new window and connect to the Web site for the selected DDNS service provider.

Domain (Host) Name	Enter the Domain Name (Host Name) allocated to you by the DDNS Server provider.
Account/E-Mail	Enter the login name for the DDNS account.
Password/Key	Enter the password for the DDNS account.
Check WAN IP Address	<p>Set the schedule for checking if the Internet IP address has changed. If the IP address has changed, the DDNS Server will be notified.</p> <p>NOTE: If the DDNS Service provided some software to perform this IP address update or notification, you should NOT use this software. The update is performed by the camera.</p>

IP Filter

The IP Filter feature allows administrator to control network camera access by filtering IP addresses. This screen is displayed when the *IP Filter* menu option is clicked.

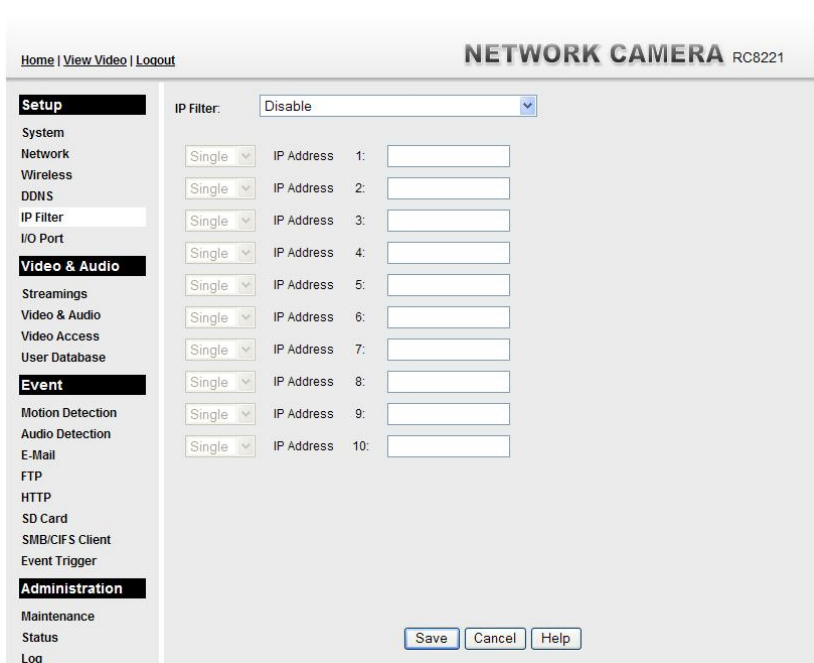

Figure 32: IP Filter Screen

Data - IP Filter Screen

IP Filter	
IP Filter	Select the desired method to perform the IP address (or addresses) filtering function.
Single/Range	Select to perform either single IP address or a range of IP addresses that you desired.
IP Address	Enter an IP address or a range of IP addresses you would like to allow or deny.

I/O Port

The Network Camera supports 1 input port and 1 output port. This screen is displayed when the *I/O Port* menu option is clicked.

Figure 33: I/O Port Screen

Data - I/O Port Screen

Input Ports	
Current State	It indicates the current state of the input port. Once the configured state is happened, it will trigger the event actions.
Triggered When...	Select the desired State: <ul style="list-style-type: none"> • High • Low • Rising • Falling
Output Ports	
Current State	It indicates the current state of the output port.
Default State	Select the desired option from the drop-down list.
Manual Trigger	Select the option to control the output state.
Action When Triggered	If an event is happened, it will trigger the event alerting.

Streamings

This screen is displayed when the *Streamings* menu option is clicked.

If you want to view streaming via the cell phone:

1. Cell phone should be supported by 3GPP protocol.
2. Enter 554 for RTSP port number in the *Network* screen.
3. Both MPEG-4 and H.264 format support cell phone option.
4. Enter the following address in the URI:
RTSP:// Router IP address / User Defined URI
5. Select 15 fps for Max Frame Rate.

Note! Due to the bandwidth limitation for the cell phone usage, please set the resolution, quality and frame rate to lower values.

Home | View Video | Logout

NETWORK CAMERA RC8221

Setup

- System
- Network
- Wireless
- DDNS
- IP Filter
- I/O Port

Video & Audio

- Streamings**
- Video & Audio
- Video Access
- User Database

Event

- Motion Detection
- Audio Detection
- E-Mail
- FTP
- HTTP
- SD Card
- SMB/CIFS Client
- Event Trigger

Administration

- Maintenance
- Status
- Log

Default Streaming Channel

Streaming Channel: Streaming 3

Streaming 1 Settings

Video Format: H.264

Resolution: 1280*720

Video Quality Control:

Constant Bit Rate: 512 Kbps

Fixed Quality: Very High

Profile: High Profile

GOV Length: 10 (2~150)

Max Frame Rate: 30 fps

User Defined URI: _____

Streaming 2 Settings Enable

Video Format: MPEG-4

Resolution: 640*480

Video Quality Control:

Constant Bit Rate: 64 Kbps

Fixed Quality: Very High

GOV Length: 10 (2~150)

Max Frame Rate: 30 fps

User Defined URI: _____

Streaming 3 Settings Enable

Cropping: None

Video Format: MPEG-4

Resolution: 1280*720

Video Quality Control:

Constant Bit Rate: 1.0 Mbps

Fixed Quality: Normal

GOV Length: 10 (2~150)

Max Frame Rate: 30 fps

User Defined URI: _____

Save Cancel Help

Figure 34: Streamings Screen

Data - Streamings Screen

Default Streaming Channel	Select the default channel for streaming from the drop-down list.
Streaming 1 Settings	
Video Format	Select the desired format from the list.
Resolution	Select the desired video resolution format.
Video Quality Control	<ul style="list-style-type: none"> • Constant Bit Rate: Select the desired bit rate. The default is set to 1.0 Mbps. • Fixed Quality: Select the desired option. The default fix quality is set to Normal.
Profile	<p>This is only for H.264 format only. There are 3 options:</p> <ul style="list-style-type: none"> • Baseline Profile • Main Profile • High Profile
Fixed Video Quality	This option is for MJPEG format only. Select the desired option. The default fix quality is set to Normal.
GOV Length	Adjust the GOV interval in frame base. "2" means 1 I frame and 1 P Frame. "3" means 1 I frame and 2 P Frames. Enter the desired value between 2 and 150.
Max. Frame Rate	Select the desired Maximum frame rate for the video stream. The default value is 30 .
User Defined URI	You may enter the URI up to 32 characters long for accessing the live video from camera through cell phone connection.
Streaming 2/3 Settings	
Enable	Check the box if you want to enable the streaming.
Cropping (Streaming 3 Only)	Choose the desired option as required.
Video Format	Select the desired format from the list.
Resolution	Select the desired video resolution format.
Video Quality Control	<ul style="list-style-type: none"> • Constant Bit Rate: Select the desired bit rate. The default is set to 1.0 Mbps. • Fixed Quality: Select the desired option. The default fix quality is set to Normal.
Profile	<p>This is only for H.264 format only. There are 3 options:</p> <ul style="list-style-type: none"> • Baseline Profile • Main Profile • High Profile
Fixed Video Quality	This option is for MJPEG format only. Select the desired option. The default fix quality is set to Normal.
GOV Length	Adjust the GOV interval in frame base. "2" means 1 I frame and 1 P Frame. "3" means 1 I frame and 2 P Frames. Enter the desired value between 2 and 150.

Max. Frame Rate	Select the desired Maximum frame rate for the video stream. The default value is 30 .
User Defined URI	You may enter the URI up to 32 characters long for accessing the live video from camera through cell phone connection.

Video & Audio Screen

This screen is displayed when the *Video & Audio* menu option is clicked.

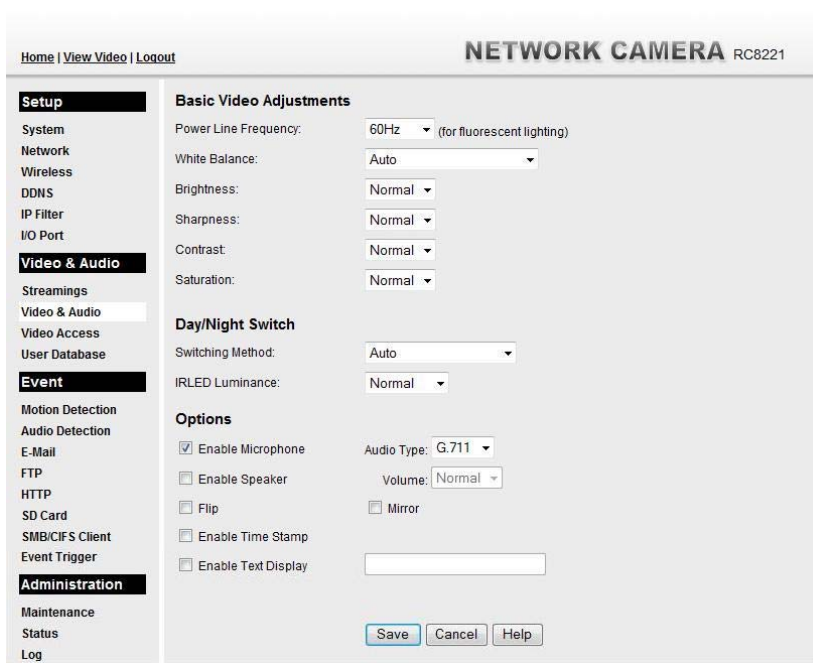

Figure 35: Video & Audio Screen

Data - Video & Audio Screen

Basic Video Adjustment	
Power Line Frequency	Select the power line frequency (50Hz or 60Hz) used in your region, to improve the picture quality under florescent lighting.
White Balance	Select the desired option to match the current environment and lighting.
Brightness	If necessary, you can adjust the brightness to obtain a better image. For example, if the camera is facing a bright light, the image may be too dark. In this case, you can increase the brightness.
Sharpness	Select the desired option for the sharpness. You can select a Sharpness value between -3 and 3.
Contrast	Select the desired option for the Contrast. You can select a value between -3 and 3.
Saturation	Select the desired option for the Saturation. You can select a value between -3 and 3.
Day/Night Switch	
Switching Method	The Network Camera supports Day/Night mode switch for getting better quality of the low light condition. Select the desired method to use this function.
IRLED Luminance	Select the desired lightness for the IR LED.

Options	
Enable Microphone	Enable audio by checking this checkbox. Using Audio will increase the bandwidth requirements slightly.
Audio Type	Select the desired audio type.
Enable Speaker	Enable speaker sound by checking this checkbox.
Volume	Choose the desired volume for the speaker.
Flip	This setting will have the image swapped top-to-bottom.
Mirror	This setting will have the image swapped left-to-right.
Enable Time Stamp	If enabled, the current time will be displayed on the Video image.
Enable Text Display	Enable this setting if you want text to be displayed on the Video image, and enter the desired text - up to 20 characters. This feature is often used to identify each camera when multiple cameras are installed.

Video Access Screen

This screen is displayed when the *Video Access* option is clicked.

The screenshot shows the 'Video Access' configuration page for a 'NETWORK CAMERA RC8221'. The left sidebar contains a navigation menu with categories: Setup, Video & Audio, Event, and Administration. The main content area is divided into several sections: 'User Access' with a checkbox for 'Enable Security Checking'; 'Video Access' with a checkbox for 'Enable Scheduled Video Access'; 'Access Schedule' which is currently empty; and 'Add New Schedule' which includes a 'Day' dropdown menu (set to 'Every day'), 'Start Time' and 'End Time' fields (each with hour and minute dropdowns), and 'Add' and 'Clear' buttons. At the bottom of the main area are 'Save', 'Cancel', and 'Help' buttons.

Figure 36: Video Access Screen

Data - Video Access Screen

User Access	
Enable Security Checking	<ul style="list-style-type: none"> If disabled (default) - No login required. Users do not have to provide a username and password when they connect to the camera for viewing video. If enabled - Require login. Users will be prompted for a username and password when they connect to the camera for viewing video. The camera administrator must use the "User Database" menu option to create the desired users.
Video Access	
Enable Scheduled Video Access	<ul style="list-style-type: none"> If enabled - Viewing video is available during the scheduled periods, and unavailable at other times. If this option is selected, you need to define a schedule. If no schedule is defined, this option is always disabled. If disabled - The option will remain disabled until you enable it. <p>Note that regardless of which setting is chosen, the Administrator can ALWAYS access the camera and view live video.</p>
Access Schedule	
Scheduled Periods	This displays all periods you have entered into the database. If you have not entered any periods, this list will be empty.
Delete	Use the Delete button to delete the selected item in the list.

Add New Schedule	
Day	Choose the desired option for the period.
Start Time	Enter the start time using a 24 hr clock.
End Time	Enter the end time using a 24 hr clock.
Add	Click this button to add a new period.
Clear	Use this button to clear the input fields.

User Database Screen

This screen is displayed when the *User Database* option is clicked.

Figure 37: User Database Screen

Data - User Database Screen

Existing Users	
User List	This displays all users you have entered into the User database. If you have not entered any users, this list will be empty. The maximum number of users is 20.
Edit, Delete, Delete All	Use these buttons to manage the user database.
User Properties	
User Name	Enter the name for the user here. <ul style="list-style-type: none"> Spaces, punctuation, and special characters must NOT be used in the name. The name is case insensitive (case is ignored), so you can not have 2 names which differ only by case.
User Password	The password for this user.
Confirm Password	Re-enter the password for the user, to ensure it is correct.
Control Level	Select either <i>Viewer</i> or <i>Operator</i> for the user you plan to add.
Add Button	Click this button to add a new user, using the data shown on screen.
Clear Button	Use this button to clear the input fields, ready to add a new user.

Motion Detection Screen

This screen is displayed when the *Motion Detection* option on the *Event* menu is clicked.

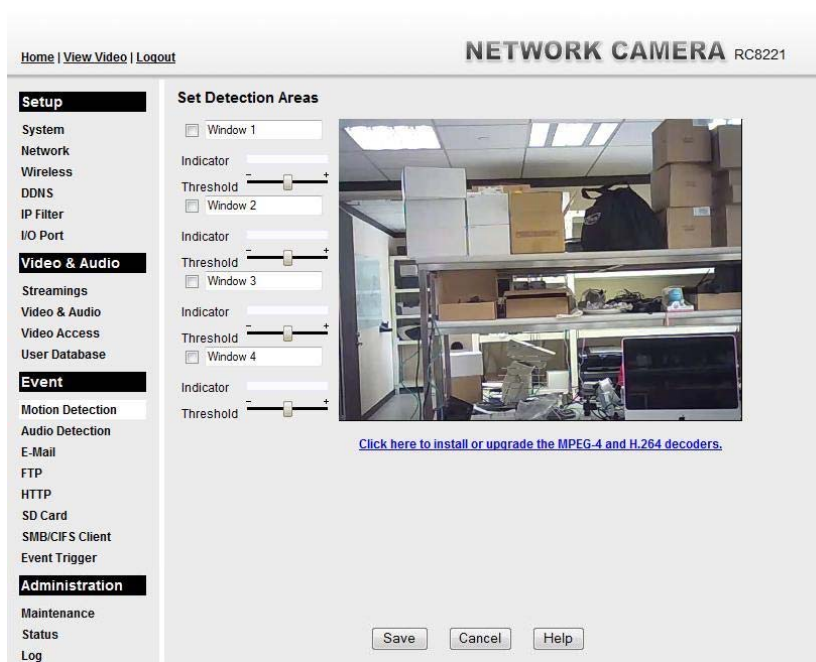

Figure 38: Motion Detection Screen

Data - Motion Detection Screen

Motion Detection	
Set Detection Areas	<p>You can set the full screen or selected areas of the video image to be examined.</p> <p>Note: Motion detection can be triggered by rapid changes in lighting condition, as well as by moving objects. For this reason, it should only be used indoors.</p>
Indicator/Threshold	<p>Administrator needs to adjust the relation between indicator and threshold for each area.</p>

Audio Detection Screen

This screen is displayed when the *Audio Detection* option on the *Event* menu is clicked.

The screenshot shows a web interface for a network camera. At the top, there are links for 'Home', 'View Video', and 'Logout', and the title 'NETWORK CAMERA RC8221'. A left sidebar contains a menu with categories: 'Setup' (System, Network, Wireless, DDNS, IP Filter, I/O Port), 'Video & Audio' (Streamings, Video & Audio, Video Access, User Database), 'Event' (Motion Detection, Audio Detection, E-Mail, FTP, HTTP, SD Card, SMB/CIFS Client, Event Trigger), and 'Administration' (Maintenance, Status, Log). The 'Audio Detection' option is selected. The main content area is titled 'Set Detection Volume' and contains three fields: 'Current Volume:' with a text input and a 'Refresh' button; 'Triggered Volume:' with a horizontal slider; and 'Triggered When:' with a dropdown menu set to 'Low to high'. At the bottom of the main area are 'Save', 'Cancel', and 'Help' buttons.

Figure 39: Audio Detection Screen

Data - Audio Detection Screen

Audio Detection	
Current Volume	It displays the current volume of the environment. Click <i>Refresh</i> to update the status.
Triggered Volume	Drag the bar to set the volume for triggering.
Triggered When	Choose the desired situation for triggering the audio detection.

E-Mail Screen

This screen is displayed when the *E-Mail* option on the *Event* menu is clicked.

Figure 40: E-Mail Screen

Data - E-Mail Screen

Primary/Secondary SMTP Server	
SMTP Server Address	Enter the address of the SMTP (Simple Mail Transport Protocol) Server to be used to send E-Mail.
Authentication	Select the desired Authentication type for the SMTP Server.
SMTP Login name	Enter your login name for the SMTP Server.
SMTP Password	Enter your password for the SMTP Server.
POP server name	Enter the name for the POP Server.
Show "From" as	Enter the E-Mail address to be shown in the "From" field when the E-Mail is received.
Test the Server	Click this button to test the server connection.
Secondary SMTP	Check the box to upload to the Secondary SMTP if the camera can not connect to the primary SMTP.
E-Mail Setup	
E-mail Address	Enter at least one (1) E-Mail address; the 2nd and 3rd addresses are optional. The E-Mail alert will be sent to the E-Mail address or addresses specified here.
With Attachment	Enable the checkbox if you want to attaché files to the E-mail.

Subject	Enter the desired text to be shown as the "Subject" for the E-Mail when it is received. Subject can not exceed 48 alphanumeric characters.
----------------	--

FTP Screen

This screen is displayed when the *FTP* option on the *Event* menu is clicked.

Figure 41: FTP Screen

Data - FTP Screen

Primary/Secondary FTP	
FTP Server	Enter the address of the FTP Server.
Port	Enter the Port of the FTP Server to be connected.
Login name	Enter your login name for the FTP Server.
Password	Enter your password for the FTP Server.
Enable Passive Mode	Check the box to enable the Passive mode feature of the FTP.
File Path Name	Enter the file path/name of the FTP.
Test the Server	Click this button to test the server connection.
Secondary FTP	Check the box to upload to the Secondary FTP if the camera can not connect to the primary FTP.

HTTP Screen

This screen is displayed when the *HTTP* option on the *Event* menu is clicked.

Figure 42: HTTP Screen

Data - HTTP Screen

HTTP Notification	
URL	Enter the URL of your HTTP notification server.
User Name	Enter the user name of your HTTP server.
Password	Enter the password to match the user name above.
Proxy Server Name	Specify the proxy server name in the provided field if the camera needs to pass through a Proxy Server to do the HTTP notification.
Proxy User Name	Enter the user name for the proxy server.
Proxy Password	Enter the password for the proxy server.
Proxy Port Number	Enter the port number for the proxy server.
Method	<p>Select the desired method of form data encoding.</p> <ul style="list-style-type: none"> Get - It should be used if and only if the form processing is independent, which typically means a pure query form. Generally it is advisable to do so. Post - If there are problems related to long URLs and non-ASCII character repertoires, which can make it necessary to use "POST" even for independent processing.

SD Card Screen

This screen is displayed when the *SD Card* option is clicked.

Figure 43: SD Card Screen

Data - SD Card Screen

Card Management	
Card Status	It shows details of the card, if any. <ul style="list-style-type: none"> Total Size Used Size Free Size Used (%)
Refresh	Click this button to update the status of the current SD card
Format	Format the SD card by clicking the <i>Format</i> button.
Safely Remove	When you want to remove the card, click this button.

Video Clips	Click <i>View</i> button to see the details of the video clips.
Recording	
Enable	Check the box if you want to enable recording function. Enter the desired time (minute) to set the maximum time period of a recording.
When disk is full	Select the desired option for the behavior when the disk space limit is reached. <ul style="list-style-type: none"> • Overwrite oldest file. The Recorder will overwrite the oldest file if the space is not enough for further recording. • Stop recording. If the disk space limit is reached, no further recording is done.
Access Schedule	
Scheduled Periods	This displays all periods you have entered into the database. If you have not entered any periods, this list will be empty.
Delete	Use the Delete button to delete the selected item in the list.
Add New Schedule	
Day	Choose the desired option for the period.
Start Time	Enter the start time using a 24 hr clock.
End Time	Enter the end time using a 24 hr clock.
Add	Click this button to add a new period.
Clear	Use this button to clear the input fields.

SMB/CIFS Client Screen

This screen is displayed when the *SMB/CIFS Client* option on the *Event* menu is clicked.

The screenshot shows a web interface for a network camera. At the top, there are links for 'Home | View Video | Logout' and the title 'NETWORK CAMERA RC8221'. On the left is a navigation menu with categories: 'Setup' (System, Network, Wireless, DDNS, IP Filter, I/O Port), 'Video & Audio' (Streamings, Video & Audio, Video Access, User Database), 'Event' (Motion Detection, Audio Detection, E-Mail, FTP, HTTP, SD Card, SMB/CIFS Client, Event Trigger), and 'Administration' (Maintenance, Status, Log). The 'SMB/CIFS Client' option is selected. The main area contains the following fields and buttons:

- Browse SMB/CIFS Server:
- Server Name:
- File Path:
- User Name:
- Password:
-
- At the bottom:

Figure 44: SMB/CIFS Client Screen

Data - SMB/CIFS Client Screen

SMB/CIFS Client	
Browse SMB/CIFS Server	Click <i>Browse</i> button to select the desired SMB/CIFS server.
Server Name	Enter the name of your SMB/CIFS server.
File Path	Enter the file path of your SMB/CIFS server.
User Name	Enter the user name for the SMB/CIFS client account.
Password	Enter the password for the SMB/CIFS client account.
Test the Server	Click this button to test the server connection.

Event Trigger Screen

This screen is displayed when the *Event Trigger* option is clicked.

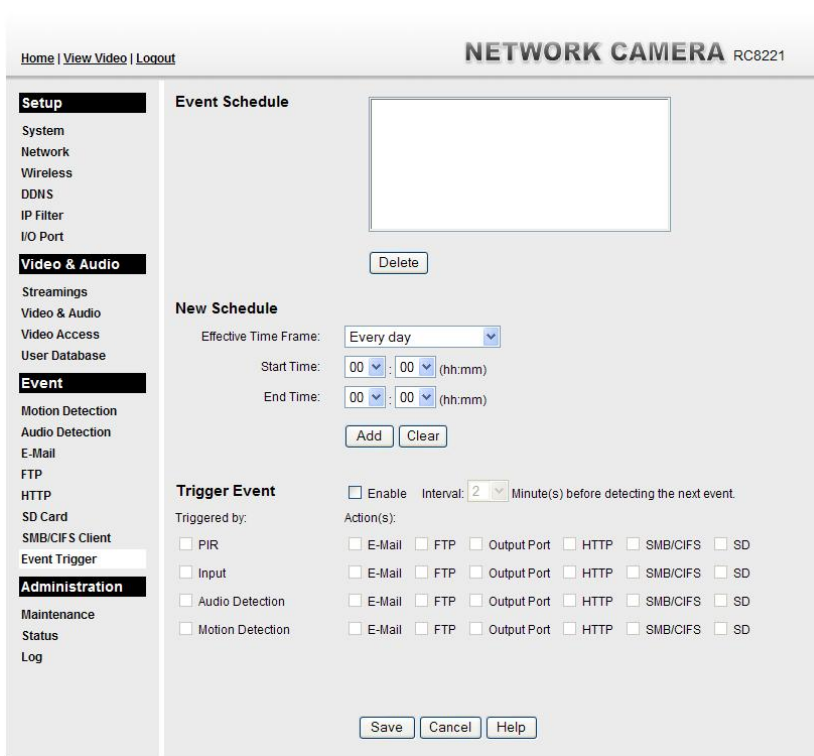

Figure 45: Event Trigger Screen

Data - Event Trigger Screen

Event Schedule	
Schedule List	<p>The Event Schedule shows all of the event types currently configured in the Network Camera, along with various information about their configuration, as listed below:</p> <ul style="list-style-type: none"> • Name - the descriptive event name set by the user. • Effective Time Frame - shows when the event at a set time will be triggered. • Trigger by - shows what kind trigger activate the event. • Action - shows what kind of the actions will be issued when the event been triggered.
New Schedule	
Effective Time Frame	Choose the desired option for the period.
Start Time	Choose the desired start time using a 24 hr clock.
End Time	Choose the desired end time using a 24 hr clock.

Trigger Event	
Enable	Check to perform all of the event(s) that were configured and scheduled.
Interval	Select the desired option for the events interval. (* "0" = No Delay)
Trigger by	<ul style="list-style-type: none"> • PIR - If the PIR sensor detects a human body, it will be used to trigger events. • Input - This describes the states that the input must be in for an event to be triggered. Only one input can be used, also note that the states for the input used must first be reached before the event will be triggered. • Audio Detection - The sound detection can be used to trigger events. • Motion Detection - Movement in a motion detection window can be used to trigger events.
Actions	<ul style="list-style-type: none"> • E-Mail - If checked, an E-Mail (with "Attachment") will be delivered to the SMTP server. (SMTP Server must be configured on the E-Mail page.) • FTP - If checked, an FTP upload will be activated to the FTP server. (FTP servers must be configured on the FTP page.) • Output Port - If checked, the output port state will be activated as configured. (Output port must first be configured on the I/O Port page.) • HTTP - If checked, a HTTP CGI command will be delivered to the HTTP server. • SMB/CIFS - If checked, JPEG image(s) or video files will be uploaded to the SMB server. (SMB must first be enabled and configured on the SMB Client page.) • SD - If checked, the SD card state will be activated, and the avi files will be saved in the SD card.
Attachment Type	<ul style="list-style-type: none"> • Streaming Channel - Select the desired type for the video file. • Pre/Post Capture - Select the desired length. The size of the file depends on this setting, and also the Video size and degree of compression.

Maintenance Screen

Figure 46: Maintenance Screen

Data - Maintenance Screen

Administrator Login	
Administrator ID	Enter the name for the Administrator here. Spaces, punctuation, and special characters must NOT be used in the name.
Administrator Password	The password for the Administrator.
Verify Password	Re-enter the password for the Administrator, to ensure it is correct.
Firmware Upgrade	
Upgrade File	Click the "Browse" button and browse to the location on your PC where you stored the Firmware file. Select this file.
Start	Click this button to start the Firmware. When the upgrade is finished, the Network Camera will restart, and this management connection will be unavailable during the restart.
Clear File Name	This does NOT stop the Upgrade process if it has started. It only clears the input for the "Upgrade File" field.

Backup & Restore	
Backup Configuration File	Click <i>Backup</i> button to save the current configuration information to a text file. It is suggested to backup the configuration file, in order to restore the camera easily.
Restore Configuration File	Click <i>Restore</i> button to reinitialize the camera to load the new updated software. Do this after loading the upgrade file.
Clear File Name	This does NOT stop the Restore process if it has started. It only clears the input for the "Restore Configuration File" field.
Restore Factory Defaults	Click <i>Defaults</i> button to reloads all default settings on the camera.
Restart Camera	Click <i>Restart</i> button to restarts the camera.

Status Screen

Figure 47: Status Screen

Data - Status Screen

System	
Device Name	This shows the name of the Network Camera.
Description	This shows the description of the Network Camera, such as location.
F/W version	The version of the current firmware installed.
Network	
MAC Address	The current IP address of the Network Camera.
IP Address	The IP Address of the Network Camera.
Network Mask	The network mask associated with the IP address above.
Gateway	The IP Address of the remote Gateway associated with the IP Address above.
WINS Address	The IP Address of the WINS server.

Wireless	
WSC PIN Code	It displays the current WSC PIN code.
Network Type	This shows the Network Type currently in use (Ad-hoc or Infrastructure).
SSID	This displays the wireless SSID.
Channel	This shows the wireless channel currently used.
Security	The current security setting for Wireless connections.
Signal Strength	This shows the strength of the signal.
Streaming (1~3)	
Video Format	It displays the current format of video.
Resolution	The image size of the video stream.
Video Quality	This displays the image quality of the video stream.
Frame Rate	This displays the frame rate of the video stream.
Buttons	
Refresh	Update the log and any other data on screen.

Log Screen

This screen displays a log of system activity.

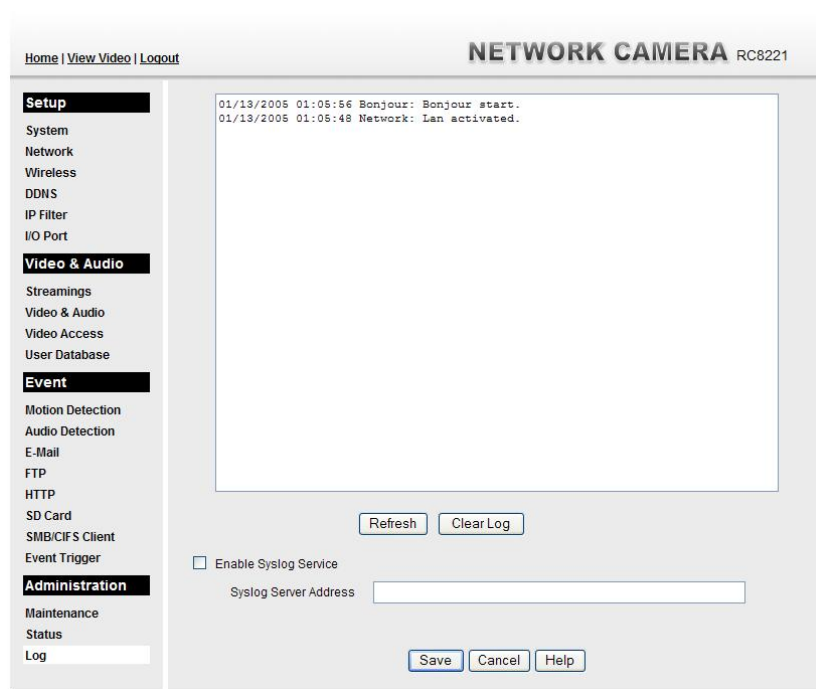

Figure 48: Log Screen

Data - Log Screen

Log	
System Log	This is a log of system activity.
Refresh Button	Click this to update the data shown on screen.
Clear Log	Click this button to restart the log.
Enable Syslog Service	Check the box to enable the System Log Server feature.
Syslog Server Address	Enter the address of the Syslog Server.

Chapter 6

Windows

6

Viewing/Recording Utility

This Chapter describes how to use the supplied Utilities package to view and listen the live streams generated by the Network Camera.

Overview

The Utilities package includes following three functions:

- LiveView - to view/listen the live streams.
- View Recordings - to record the live streams.
- Setup - to configure the Utilities such as adding camera, making recording schedules and setting required parameters, etc..

The Utilities must be installed in the Windows before they can be configured.

System Requirements

In order to use the utility of Network Camera, you need to meet the following requirements:

- Windows XP SP3, 32-bit Windows Vista/Windows 7.
- Microsoft .NET Framework 3.5 Service Pack 1 (it should be installed on Windows XP/VISTA via "Windows Update").
- Internet Explorer 6 or later, Firefox 3.0 or later
- 2GB RAM
- Individual Graphic Card

Installation

1. Insert the supplied CD-ROM into your drive. If the setup program does not start automatically, run **NetworkCamera.exe** in the root folder. You will see the *Welcome* screen shown below.



Figure 49: Welcome Screen

2. Click the *Install Utility* button to start the installation of the Utilities package.
3. Follow the prompts to complete the installation.
4. After the installation, double click the Monitor icon on the desktop or click Monitor menu item in the Windows main program menu to launch the Utilities.

System Tray Icon

When started, the program will create an icon in the Windows system tray on the taskbar, as shown below.



Figure 50: System Tray Icon

You can right click the icon and it will provides a menu which allows you to launch utility program, view the utility details or even exit the utility package.

LiveView Screen

When Utility launched, the Camera Utility screen like the example below will be displayed.

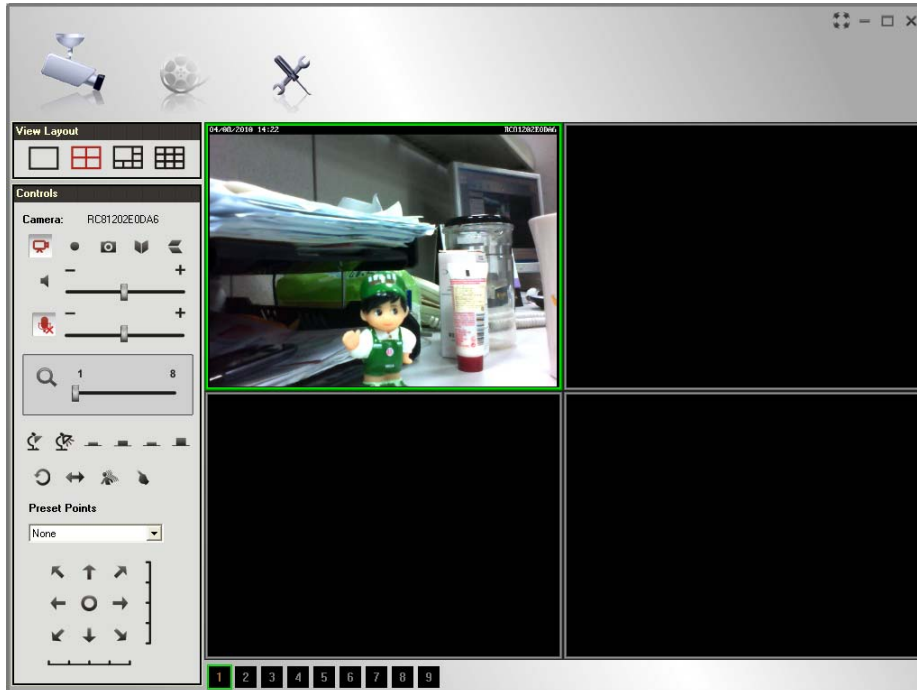

Figure 51: Main Screen

If no cameras have been defined and added to the Utilities, no video will be displayed. Utilities should be configured first to view the camera streams. See the following section for information on defining a camera. Note that each Camera is given a number (Channel Number).

Camera Setup

To define a camera and associate it with a *Channel Number*:

1. Click the *Setup* icon on the main screen. You will see a screen like the example below.

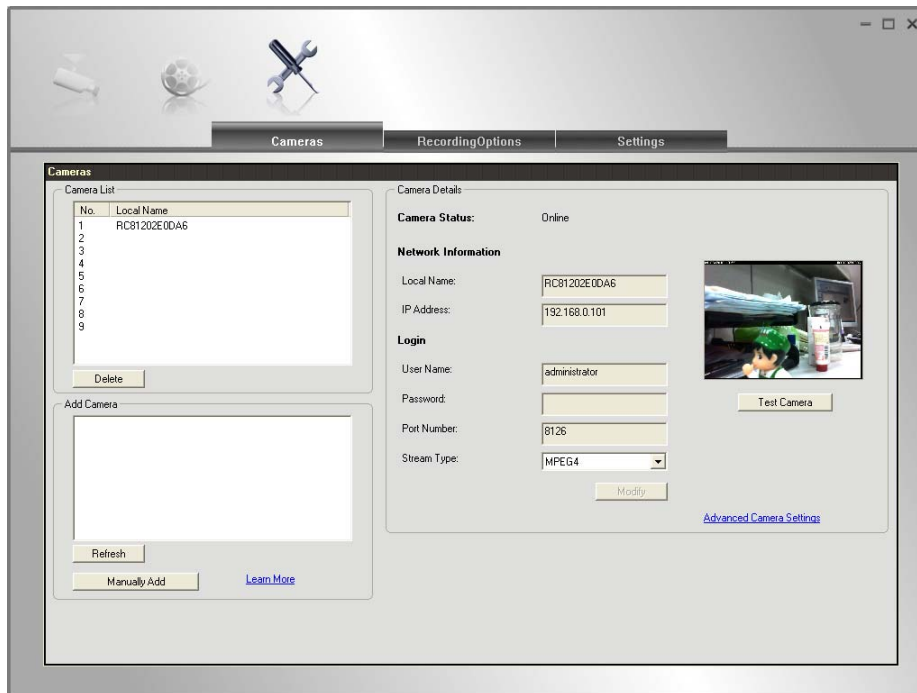

Figure 52: Cameras Setup Screen

2. Add desired Network Camera to the *Camera List*:
 - **To associate a camera automatically with the current Channel:**
 - The Utilities will search and display all available Network Cameras found on your LAN in the Add Camera list automatically. The *Add Camera* list can be updated by clicking the *Refresh* button.
 - The *Camera Details* panel, on the right, displays the data for the selected camera.
 - Check that the *Camera Details* shown on the right is correct. Enter associated User Name and Password.
Note: The **Port Number**, **User Name**, **Password** and **Stream Type** can only be modified in the WEB UI instead of Camera Setup screen.
 - Click the *Test Camera* button to check that a connection and login can be performed successfully.
 - Click *Add* button. The camera will now appear in the *Camera List*.
 - **To associate a camera manually with the current Channel:**
 - Click *Manually Add* button.
 - Enter the *Local Name*, *IP Address*, *User Name*, *Password*, *Port Number* and *Stream Type* in the *Camera Details* section.
Note: The **Port Number**, **User Name**, **Password** and **Stream Type** can only be modified in the WEB UI instead of Camera Setup screen.

- Click the *Test Camera* button to check that a connection and login can be performed successfully.
- Click *Add* button. The camera will now appear in the *Camera List*.

Cameras Data

Camera list	This displays the cameras you've added, if any. Use the <i>Delete</i> button to delete the selected camera in the list.
Add cameras	This list displays all available Network Cameras found on your LAN.
Address	If you cannot find the desired camera in the above list, you can add it manually by entering the IP address in this field.
Camera Status	This displays the current status of the selected camera.
Local Name	This is the default name for the Wireless Network Camera, and can be changed.
IP Address	The current IP address of the Wireless Network Camera. Or enter the Domain Name or Internet IP address of the desired Wireless Network Camera.
Login	<p>The camera Administrator can require that users provide a username and password before being allowed to view the live video.</p> <ul style="list-style-type: none"> • If the Administrator has not enabled this option, the <i>Login</i> fields can be left blank. • Otherwise, you must enter the <i>User Name</i> and <i>Password</i> allocated to your by Administrator.
Port Number	This will normally display "80". Only change this if requested to do so by the Wireless Network Camera Administrator.
Stream Type	Select the desired type from the drop-down list.
Delete Button	Click this button to delete the selected camera in <i>My camera list</i> .
Refresh Button	The <i>Add cameras</i> list can be updated by clicking the <i>Refresh</i> button.
Add Button	Click the button to add the selected camera to the list.
Test Camera	Check the connection of the selected camera by clicking this button.
Advanced Camera Settings	Click this link to connect to the Web UI of the Network Camera immediately.

LiveView Program - for Streams Live Viewing

You can view live video in the Monitor screen. The built-in software can let you view up to 9 cameras on a single computer screen at one central location.

The following table lists the icons displayed on the Monitor screen:



View Layout. Use this to select the number of Channels (Cameras) to be displayed on screen. Up to 9 cameras can be displayed.



View. This indicates if the camera stream is being viewed.
Red indicates the configured camera is being viewed.
Gray indicates that no camera is configured or the configured camera is not connected to the Monitor.



Instant Record. Click this to start recording the current stream. While recording, this button will be red. To stop recording, click this button again.
Gray indicates no recording.
Red indicates recording is in progress.



Snapshot. Click this to take a still image of the current video stream. The image format is BMP.



Mirror. Click this to have the image swapped left-to-right.



Flip Video. Click this to have the image swapped top-to-bottom.



Speaker On/Off. To turn On/Off the speaker volume for the camera in focused viewport.



Microphone On/Off. To turn On/Off the audio upload function for the camera in the focused viewport.



Volume. If Speaker/Microphone is enabled, you can click the icon, then drag and drop to raise or lower the volume.



Zoom Camera. A digital zoom-in feature is available. Drag the slider bar to the desired magnified rate in a viewport.



Day/Night Mode. The Network Camera supports Day/Night mode switch for getting better quality of the low light condition. This function is available depending on the model of Network Camera.



IO Port 1/2. It indicates if there is any I/O type triggered event detected in the port 1/2.



Patrol. Move through the Preset positions in the sequence defined by the Camera Administrator.



Camera Auto Pan. Click this to have the camera moved from left to right automatically.



Motion Detection. Click this button to have the camera moved to the Motion Detection Preset position.



Direct P/T. Use this to move the camera to the Pan/Tilt position directly.



Preset Points. Select the desired Preset points.

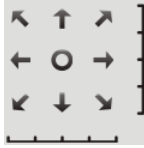

Move Control. Use this to move the camera to the desired position. There may be a short delay after clicking the desired icon. You should wait a couple of seconds rather than click again.
Or you can drag the vertical or horizontal slider bar to have quicker movement of the Network Camera to the desired position.



Setup. Click this button to open the Utilities configuration program.



View Recordings. Click this button to launch the recording program, which allows you to browse through the previously saved recordings. Please see the " View Recordings Program - for Streams Recording " section for details.



Channel Indicator. This indicates the current channel (camera).

View Recordings Program - for Streams Recording

To access the saved recordings of the Cameras, click *View Recordings* icon on the top of the screen, then you will see a screen like following.

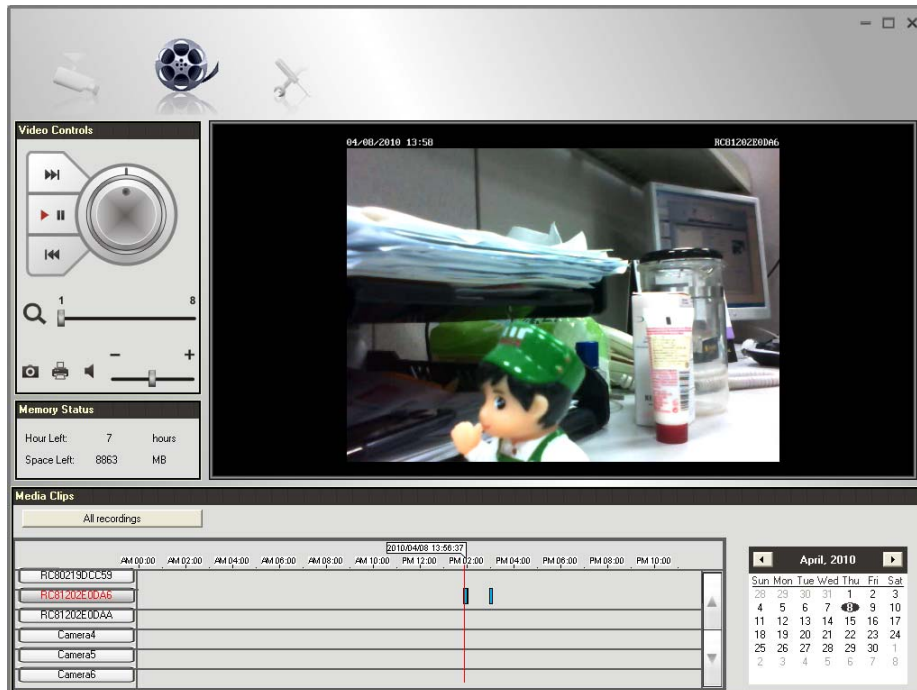



Figure 53: View Recordings Screen

Searching Recorded Streams Files

Skip to Next Record. Use this to view the next available record.

Play. Use this to re-start viewing, after using the Pause button.

Playing speed. Use the  to accelerate (right) or decelerate (left) the playing speed.

Pause. Use this to temporarily stop playing.

Skip to Previous Record. Use this to view the previous record.

Zoom In. To zoom in on a section of the window, drag the slider bar to the desired magnified rate of a viewport.

Snapshot. Click this to take a still image of the current video.

Print. Click this to print the current frame which is showing in the screen.

Speaker. To play a recorded file, select the desired volume.

Hour Left. It displays the possible available time for recording.

Space Left. It displays the current available space of the memory.

All recordings. Click this button to select the type (*All recordings* or *Event recordings*) of the recorded files.

Select Camera. Click the desired camera to find the recordings.

Recording Bar. It displays the recordings that match your requests.

Calendar. Choose the date of the calendar for finding desired recordings.

Setup Program - for Streams Configuration

There are 3 tabs of the Setup program:

- Cameras
- Recording Options
- Settings

For the *Cameras* configuration, please refer to the Camera Setup for details.

You can record the streams from camera by pressing the *Instant Record* button in the Monitor program as mentioned in the "LiveView Program - for Streams Live viewing" section or by making schedules to let the recording happen on the arranged time period.

All the recorded streams are stored in files with a proprietary format and can be viewed via Playback program in the Utilities package.

If you want to change the default settings of recording parameters before doing any recording, please see the "Settings" section for details.

Recording Options

To make recording schedules, click the *Recording Options* tab on the Setup screen. You will see a screen like the example below.

NO.	Day	Start Day	Start Time	End Time	Event Only
3	One Time	2010/04/08	13:52	13:53	V
2	One Time	2010/04/08	13:40	13:41	V
1	One Time	2010/04/08	14:00	14:02	V

Figure 54: Recording Options

If necessary, change these settings to suit your environment. Please follow the steps below to make a schedule for recording:

1. Select a camera from the available camera list.
2. Select either *Always Record* or *Record in a Scheduled Time Range* for recording type.
3. If *Record in a Scheduled Time Range* is selected, set the recording time range from Start Date, Start Time and End Time boxes.

4. Press *Add* button to add the schedule.

You will see all the schedules in the recording list.

Settings

Clicking the *Settings* tab on the Configuration program to make change of default Utilities parameter settings.

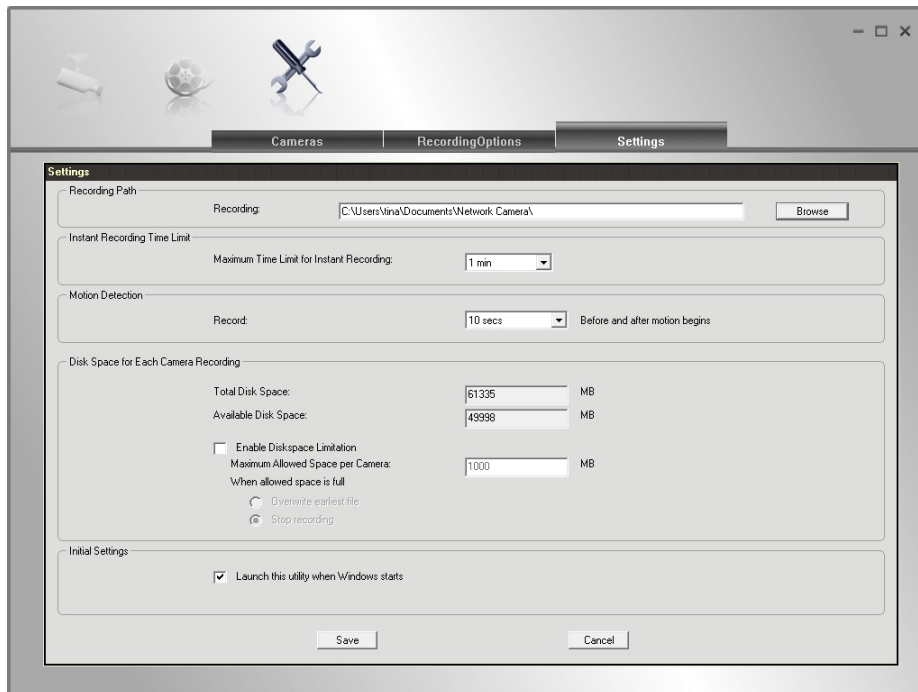

Figure 55: Settings Screen

Data - Settings

Recording Path	
Recording	This is the Drive and Folder on your PC/Notebook where recorded files will be placed. You need a drive which has large amounts (Gigabytes) of free space. Click the Browse button to select the drive and folder if you want to change the default path. Note that file names for the recordings are automatically assigned, using an internal date-time coding rule.
Instant Recording Time Limit	
Maximum Time Limit for Instant Recording	This sets the maximum time period of a recording which is started by clicking the Record button on the Monitor main screen. If the recording is not stopped manually before the arranged time period elapsed, it will be terminated automatically when the end time hit.
Motion Detection	
Record Before and after motion begins	Set the time so that the Recorder will make a pre-recording and post-recording for at most the specified time range while a motion begins and ends.

Disk Space for Each Camera Recording	
Total Disk Space	This displays the total size of the selected disk.
Available Disk Space	This displays the available space of the selected disk for storing recordings.
Enable Disk space limitation	Enable this if you wish to limit the disk space used by video recordings.
Maximum Allowed Space per Camera	Enter the maximum amount of disk space assigned to each camera for stream recordings.
When allowed space is full.	<p>Select the desired option for the behavior when the disk space limit is reached.</p> <ul style="list-style-type: none"> • Overwrite earliest file. The Recorder will overwrite the oldest file if the space is not enough for further recording. • Stop Recording. If the disk space limit is reached, no further recording is done.
Initial Settings	
Launch this utility when Windows starts	Check this to have this utility start when Windows starts.

Chapter 7

Troubleshooting



This chapter covers the most likely problems and their solutions.

Overview

This chapter covers some common problems that may be encountered while using the Network Camera and some possible solutions to them. If you follow the suggested steps and the Network Camera still does not function properly, contact your dealer for further advice.

Problems

Problem 1: I can't connect to the Network Camera with my Web Browser to configure it.

Solution 1: It is possible that your PC's IP address is not compatible with the IP address of the Network Camera.
Use the Windows utility to configure the Network Camera with a valid IP address.

Problem 2: The Windows utility doesn't list any Network Camera.

Solution 2: Check the following:

- The Network Camera is installed, LAN connections are OK, it is powered ON and startup is complete.
- Ensure that your PC and the Network Camera are on the same network segment. (If you don't have a router, this must be the case.)
- Ensure that your PC has the TCP/IP network protocol loaded. In Windows, this is done by using *Control Panel-Network*.
 - If an entry for TCP/IP -> Network card is not listed, use *Add - Protocol - Microsoft - TCP/IP* to add it.
 - You then need to select the new entry (TCP/IP -> Network card), click *Properties*, and configure the *IP Address* tab.
 - If your LAN has a DHCP Server, you can select "Obtain an IP Address automatically". Otherwise, you must select "Specify an IP Address", and enter values for *IP Address*, *Subnet Mask*, and *Gateway*. All devices on your LAN must use compatible values. Remember that each device needs a **unique** IP Address, and the **same** Subnet Mask.

Problem 3 When I try to connect to the Network Camera, I get prompted for a user name and password.

Solution 3 You SHOULD be prompted for a user name and password if trying to access the *Administration* menu.
Enter the *Administrator ID* and *Administrator Password* set on the *Maintenance* screen.

If you are just trying to view Video, the User Name/Password prompt indicates that the Administrator has restricted access to specified users. Ask the Administrator for your User Name and Password.

Problem 4 **I can't connect to the Network Camera using a Wireless connection.**

Solution 4 1) If a LAN cable is connected to the LAN port, the Wireless interface is disabled. Only one interface can be active.
2) Check that your PC and the Network Camera have compatible Wireless settings.

- Mode (Infrastructure or Ad-hoc) must be correct.
- ESSID must match.
- WEP settings must match.
- In Ad-hoc mode, the Channel should match, although this is often not required.

Problem 5 **Video quality may suddenly deteriorate.**

Solution 5 This can happen when an additional viewer connects to the Network Camera, overloading the camera or the available bandwidth. The image size and quality can be adjusted to cater for the required number of viewers and the available bandwidth.

Problem 6 **The motion detection feature doesn't send me any E-mail.**

Solution 6 It may be that the SMTP (Simple Mail Transport Protocol) server used by the camera to send the E-Mail will not accept mail. (This is to prevent spam being sent from the server.). Try using a different SMTP server, or contact your ISP to see if SMTP access is being blocked.

Problem 7 **Using the motion detection feature, I receive E-Mails which don't show any moving objects.**

Solution 7 The motion detection feature doesn't actually detect motion. It compares frames to see if they are different. Major differences between frames are assumed to be caused by moving objects.

But the motion detector can also be triggered by:

- Sudden changes in the level of available light
- Movement of the camera itself.

Try to avoid these situations. The motion detection feature works best in locations where there is good steady illumination, and the camera is mounted securely. This feature can NOT be used if the camera is outdoors.

Problem 8 **The image is blurry.**

Solution 8 Try cleaning the lens, or adjusting the *Video Quality Control* setting on the *Streamings* screen. Video created by the lower settings will contain less detail; this is the trade-off for using less bandwidth.

Problem 9 **When is the best time to press WPS button?**

Solution 9 If there is no cable connected, you can press the WPS button after the *Power* LED starts blinking.

Problem 10 **In some older Window XP systems, it may not be able to see H.264/MPEG4 video streaming.**

- Solution 10** In order to view H.264/MPEG4 video streaming in the older Window XP systems, please install the Microsoft .net framework 2.0 or later version, so the system will be able to deploy the built-in H.264/MPEG4 decoder of the camera.
- Problem 11** **I use the camera via IE browser in protected mode of Windows Vista/7, there is no local recording/setup feature to be used.**
- Even if I run it with IE browser in non-protected mode of Windows 7, the folder like "Windows" still can not be accessed. (There is no recording files found in this folder as well)**
- Solution 11** There will be no local recording files and the setup service of associated folder if the IE browser is in protected mode.
To use the local recording feature, please operate IE browser in non-protected mode.
Note! Some folders (ex. "Windows" folder) with high integrity level can not be accessed via non-protected mode of IE in Window 7.

Appendix A

Specifications



Network Camera

Model	Network Camera
Dimensions	63mm (W) x 95mm (H) x 35mm (D)
Operating Temperature	0° C to 50° C
Video compression	H.264, MPEG4 and MJPEG
Image resolution	1280x 720, 640x480 (720p system default), 320x 240 (QVGA), 160 x 120 (QQVGA)
Storage Temperature	-20° C to 70° C
Network Protocols	TCP/IP, HTTP, HTTPS, DHCP, NTP, SMTP, UPnP, FTP, RTP/RTSP
Network Interface	1 Ethernet 10/100BaseT (RJ45) LAN connection
Wireless interface	IEEE 802.11n/802.11b/802.11g compatible, Infrastructure/Ad-hoc mode, WEP 64/128 bit, WPA/WPA2 personal security support
LEDs	3
Micro-SD Card slot	1
Power Adapter	12V/1A, 100~240 VAC

Regulatory Approvals

FCC Statement

This equipment generates, uses, and can radiate radio frequency energy and, if not installed and used in accordance with the instructions, may cause harmful interference to radio communications. However, there is no guarantee that interference will not occur in a particular installation. If this equipment does cause harmful interference to radio or television reception, which can be determined by turning the equipment off and on, the user is encouraged to try to correct the interference by one of the following measures:

- Reorient or relocate the receiving antenna.
- Increase the separation between the equipment and receiver.
- Connect the equipment into an outlet on a circuit different from that to which the receiver is connected.
- Consult the dealer or an experienced radio/TV technician for help.

To assure continued compliance, any changes or modifications not expressly approved by the party responsible for compliance could void the user's authority to operate this equipment. (Example - use only shielded interface cables when connecting to computer or peripheral devices).

FCC Radiation Exposure Statement

This equipment complies with FCC RF radiation exposure limits set forth for an uncontrolled environment. This equipment should be installed and operated with a minimum distance of 20 centimeters between the radiator and your body.

This device complies with Part 15 of the FCC Rules. Operation is subject to the following two conditions:

- (1) This device may not cause harmful interference, and
- (2) This device must accept any interference received, including interference that may cause undesired operation.

This transmitter must not be co-located or operating in conjunction with any other antenna or transmitter.

CE Approvals

The Network Camera and the Ethernet Network Camera meet the guidelines of the European Union and comply with the 99/5/EEC and RTTE 99/5EG directives, including the following standards:

- EN60950
- EN300 328
- EN301 489-1
- EN301 489-17

This is a Class B product. In a domestic environment this product may cause radio interference in which case the user may be required to take adequate measures.

Copyright Notice

Many software components are covered by the GNU GPL (General Public License). Some are covered by other Licenses.

You can check more details of each applicable license by clicking the *License* button in the **Maintenance** screen.

Appendix B



Network Camera HTTP CGI

User-level CGI commands (user level privilege)

Notes: If camera is in privacy mode, it will reject the streaming/snapshot request with “406 Not Acceptable” and stop video post for event.

Video and Image commands

Stream M-JPEG video

HTML page for the end user

Method: GET

URL: <http://<ip>/img/mjpeg.htm>

Return:

```
HTTP/1.0 200 OK\r\n
...
content-type: text/html\r\n
...
http://<ip>/img/video.mjpeg
...
```

Server Push page for the programmer

Method: GET

URL: <http://<ip>/img/video.mjpeg> (utility)

The camera will check the request User-Agent parameter in HTTP header to identify the client type. The camera will regard the client as MSIE if there is the string "MSIE", regard the client as SerComm OCX if there are the strings "CameraActiveX" or "Viewer" or "AlertCfg", and regard others as PushServer.

Return (**OK** situation):

If the client is MSIE

```
HTTP/1.0 200 OK\r\n
...
content-type: image/jpeg\r\n
...
<MJPEG data>
```

If the client is SerComm OCX

```
HTTP/1.0 200 OK\r\n
...
<MJPEG video or AUDIO data>
```

The format of motion JPEG for OCX, to support the audio stream feature, we add an extra header at begin of the stream data (mjpeg/audio) to describe the frame information and sending status. The extra header contains 48 bytes in little-endian, the fields are shown as following:

Location	Parameter	Value and description
0-3	Magic String	The string to identify the header. It must be "MJPG".
4-7	Frame Size	The frame size. (bytes)
8-9	Width	The JPEG width.
10-11	Height	The JPEG height.
12-15	Sent Size	The size of the sent frame. (bytes)
16-17	Slice Size	The size of the slice. (bytes)
18-21	Timestamp	The time stamp of the frame. The time stamp of the first frame is always 0.
22	Frame Type	The frame type. 0x01 (01): JPEG 0x02 (02): G.726 Audio 0x03 (03): G.711 a law Audio 0x04 (04): G.711 u law Audio 0x05 (05): AMR Audio 0x10 (16): LPCM mono Audio at 8KHz Sample Rate

23-24	Bit Rate	The audio bit rate. 0x02 (02): 2 KbytesPerSecond 0x04 (04): 4 KbytesPerSecond 0x08 (08): 8 KbytesPerSecond
25	Version	The version number. It is 0x02 (02).
26-45	Time String	The ASCII string to present the current camera time. (Not used)
46	Padding flag	The padding flag 0x00: No padding data 0x01: There is the padding data at the end of the frame, please refer to chapter “ Padding data format ” for details
47	Reserved	Reserved

Example, A normal JPEG frame:

Image size is 5930, width is 320, height is 240, sent data size is 2000, slice size is 2000, timestamp is 0, frame type is 1 (JPEG), version number is 1. The header will look like as follows:

```

4D 4A 50 47 2A 17 00 00 40 01 F0 00 D0 07 00 00
D0 07 00 00 00 00 01 02 00 02 00 00 00 00 00 00
00 00 00 00 00 00 00 00 00 00 00 00 00 00 00 00
(2000 bytes JPEG data)

```

We will regard others client as the PushServer.

```

HTTP/1.0 200 OK\r\n
...
content-type: multipart/x-mixed-released;boundary=<xxx>\r\n
--<xxx>
content-type:image/jpeg\r\n
content-length: <image-size>\r\n\r\n
<jpeg image date>
--<xxx>
content-type:image/jpeg\r\n
content-length: <image-size>\r\n\r\n
<jpeg image date>
...
--<boundary>--

```

Return (**ERROR** situation):

```

HTTP/1.0 400 Bad Request\r\n

```

```

...
content-type: text/plain\r\n
\r\n
current_resolution=A\r\n
current_framerate=B\r\n

```

The A and B are in the following format.

Parameter	Value and description
A	Image resolution 1: 160x120 (or 160x128, 176x120 (NTSC)/ 176x144(PAL), depends on models) 2: 320x240 (or 352x240(NTSC)/ 352x288(PAL), depends on models) 3: 640x480 (or 704x480(NTSC)/ 704x576(PAL), depends on models) 4: 1280x960 (depends on models)
B	Frame rate 1 ~ 30fps

Snapshot

Method: GET

URL: [http://<ip>/img/snapshot.cgi?\[size=<value>\]\[&quality=<value>\]](http://<ip>/img/snapshot.cgi?[size=<value>][&quality=<value>])

Parameter	Value and description
size	Image resolution 1: 160x120 (or 160x128, 176x120 (NTSC)/ 176x144(PAL), depends on models) 2: 320x240 (or 352x240(NTSC)/ 352x288(PAL), depends on models) 3: 640x480 (or 704x480(NTSC)/ 704x576(PAL), depends on models) 4: 1280x720 (depends on models)
quality	Quality level 1: Very high 2: High 3: Normal 4: Low 5: Very low

Example 1: To snapshot a 640x480 (or 704x480(NTSC)/ 704x576(PAL), depends on models) very high quality JPEG image from network camera 192.168.0.99.

<http://192.168.0.99/img/snapshot.cgi?size=3&quality=1>

Example 2: To snapshot a JPEG image from network camera 192.168.0.99 (with current resolution and quality)

<http://192.168.0.99/img/snapshot.cgi>

Example 3: To snapshot a low quality JPEG image with current resolution from the network camera 192.168.0.99.

<http://192.168.0.99/img/snapshot.cgi?quality=4>

Return: A JPEG image will be returned to client with user specified resolution and quality.

```

HTTP/1.0 200 OK\r\n

```

```
...
content-type: image/jpeg\r\n
...
<JPEG image data>
```

SDP (MPEG-4/H.264 video/MJPEG)

Method: GET

URL: <http://<ip>/img/media.sdp>

Return: A SDP file will be returned.

```
HTTP/1.0 200 OK\r\n
...
<SDP data>
```

Audio Upload (uploading audio streaming to the camera)

Method: POST

URL: <http://<ip>/img/g726.cgi> G.726 audio stream (16Kbps or 32Kbps, depends on models)

URL: <http://<ip>/img/g711a.cgi> G.711 a-law audio stream (64Kbps)

URL: <http://<ip>/img/g711u.cgi> G.711 u-law audio stream (64Kbps)

Example (client side):

```
POST /IMG/g726.cgi HTTP/1.0\r\n
Host: 192.168.0.99\r\n
```

Return:

```
OK
HTTP/1.0 200 OK\r\n
```

Client starts to upload the audio stream.

```
Unauthorized (Bad username, password)
HTTP/1.0 401 Unauthorized\r\n
```

RTP/RTSP

User can stream video and audio through the following URLs.

Video and audio: <rtsp://<ip>/img/media.sav>

Video only: <rtsp://<ip>/img/video.sav>

Audio only: <rtsp://<ip>/img/audio.sav>

If the client player is QuickTime player, there are always around 3 seconds latency. If there is not audio content in the streaming, you can use the extension parameter “[?]&]latency=no” to push QuickTime player to play the streaming without any latency, but this method causes the frame rate is not stable. Example:
<rtsp://<ip>/img/video.sav?latency=no>

Note that camera is able to support the following four RTP protocols. But user needs to specify the desired RTP protocol in the player.

1. Unicast RTP
2. Multicast RTP
3. RTP over RTSP (RTP over TCP)
4. RTP over RTSP over HTTP (HTTP tunnel)

Return: Video and/or audio will be returned.

SWF/FLV

Method: GET

URL: <http://<ip>/img/media.swf>

Return: Action script content to trigger the player to get the media content.

```
HTTP/1.0 200 OK\r\n
...
<data>
```

Method: GET

URL: <http://<ip>/img/media.flv>

Return: media content.

```
HTTP/1.0 200 OK\r\n
...
<data>
```

Extension to the streaming URL defines

We extend some parameters for some products which support the multiple streamings simultaneously.

Related URLs:

video.asf, video.mjpeg, mjpeg.cgi, snapshot.cgi, media.sdp, media.sav, video.sav

Extension syntax:

Parameter	Description
channel	<p>If the product supports multiple streaming channels simultaneously, we will append the parameter “[?]&channel=[1 2 ...]” to identify, example:</p> <p>To view the 1st channel streaming: video.sav or video.sav?channel=1</p> <p>To view the 2nd channel streaming: video.sav?channel=2</p>
video	<p>If the product supports multiple video codec simultaneously, we will append the parameter “[?]&video=[MPEG4 MJPEG H264]” at the end of original URL to identify, example:</p> <p>To view streaming with MPEG4 video: video.sav?video=MPEG4</p> <p>To view streaming with H264 video: video.sav?video=H264</p>
Mix the parameters channel and video	<p>If the product supports multiple streaming channels and multiple video codec at one video channel simultaneously, we will append both channel and video parameters to identify, the parameter “channel” is the main key with priority.</p> <p>Response error if parameters are not correct.</p> <p>If only “channel” parameter provided, stream the default video, priority is: MPEG4, MJPEG, H264.</p> <p>If none parameter provide, use the default channel number, and then stream the video by priority channel 1,2,3...</p> <p>If only “video” parameter provided, stream the video from the channel supports, use the default channel number, and then priority is: 1,2,3,...</p> <p>Example#1:</p> <p>Total is 3 channels, the 1st channel has H264 video and the 2nd channel has MPEG4 video, the 3rd channel has MJPEG video, default viewer channel is 1st, then:</p> <p>To view the H264 (or to view the 1st channel video):</p> <p>video.sav?channel=1 or video.sav?video=H264 or video.sav?channel=1&video=H264</p> <p>To view the MPEG4 (or to view the 2nd channel video):</p> <p>video.sav?channel=2 or video.sav?video=MPEG4 or video.sav?channel=2&video=MPEG4</p> <p>To view the MJPEG (or to view the 3rd channel video):</p> <p>video.mjpeg</p> <p>Example#2:</p> <p>Total is 3 channels, the 1st channel has H264 video</p>

	<p>and the 2nd channel has H264 video, the 3rd channel has MJPEG video, default viewer channel is 1st, then:</p> <p>To view the H264 at 1st channel: video.sav?channel=1&video=H264 or video.sav?video=H264</p> <p>To view the H264 at 2nd channel: video.sav?channel=2&video=H264</p> <p>Have not MPEG4 video for viewing.</p> <p>To view the MJPEG: video.mjpeg</p> <p>Example#3 (not supported in product spec yet): Total is 2 channels, the 1st channel has H264 video and the 2nd channel has H264 & MPEG4 videos, default viewer channel is 1st, then:</p> <p>To view the H264 at 1st channel: video.sav?channel=1&video=H264</p> <p>To view the H264 at 2nd channel: video.sav?channel=2&video=H264</p> <p>To view the MPEG4 at 2nd channel: video.sav?channel=2&video= MPEG4 or video.sav?video=MPEG4</p>
padding	<p>If the product supports padding data over the streaming, such as motion information, we will append the parameter “[?]&]padding=[no yes]” to identify, default (no this parameter) depends on products and streaming types. Example:</p> <p>To view the streaming without padding data: video.sav?padding=no</p> <p>To view the streaming with padding data: video.sav?padding=yes</p> <p>* You can refer to the section 2.11 for more details.</p>

Player commands

Query

Method: GET

URL: <http://<ip>/util/query.cgi?extension=value>

This CGI indicates the H/W capability, component setting. Ex: The camera got I/O port (or not). The camera got Speaker (or not), etc.

Parameter	Value and description
extension	<p>Extension value</p> <p>yes: extension is enabled, the extended data as below will be extended to generic response.</p> <p>fw_ver=V1.0.0R44\r\n</p> <p>ip_addr=192.168.1.12\r\n</p> <p>netmask=255.255.255.0\r\n</p> <p>gateway=192.168.1.1\r\n</p> <p>current_time=07/02/2008 10:12:10\r\n -> MM/DD/YYYY HH:MM:SS 24-Hour format</p> <p>timezone=4\r\n</p> <p>http_port=80\r\n -> The value is -1 or none this parameter indicate the HTTP disabled.</p> <p>https_port=443\r\n -> The value is -1 or none this parameter indicate the HTTPS disabled.</p> <p>rtsp_port=554\r\n</p>

Return:

```

HTTP/1.0 200 OK \r\n
...
content-type: text/plain\r\n
\r\n
<parameter pair>\r\n
<parameter pair>\r\n
.....

```

Here are the details of parameter pairs:

Parameter	Value and description
hostname	Camera name, example: sc123456
description	Camera description, example: Hello camera
defname	Camera default name, example: default name
mac	Camera's MAC address, example: 00C002123456
company_name	Camera's company name, example: SerComm
model_number	Camera's model number, example: RC8020
resolutions	<p>Phase out in new projects. The resolutions camera support, depends on models, valid values:</p> <p>[1280*960,640*480,320*240,160*120 704*480,352*240,176*120 704*576,352*288,176*144]</p>

wireless	Wireless HW capability, example: [on off]
sw_pppoe	PPPoE software feature capability/supported, valid values: [yes no]

URL: <http://<ip>/img/query.cgi>

This CGI indicates the accessed user's privilege with some H/W features. Ex. The user could use Speaker Out, but couldn't control the I/O ports, etc.

Return:

```
HTTP/1.0 200 OK \r\n
...
content-type: text/plain\r\n
\r\n
mic_in=[on|off]\r\n
speaker_out=[on|off]\r\n
ptctrl=[on|off]\r\n
ioctrl=[on|off]\r\n
interlace=[0|1]\r\n(only for analog CCTV input)
```

Query/Control the peripheral components status (Operator, combination CGI)

Notes: This combination CGI command will replace the separated peripheral control CGIs.

Query the peripheral components status

Method: GET

URL: [http://<ip>/io/query_pc.cgi\[?<parameter>\[&<parameter>...\]\]](http://<ip>/io/query_pc.cgi[?<parameter>[&<parameter>...]])

Input parameters:

None parameter provided, CGI responds all supported peripherals' status.

The peripheral parameter provided, CGI just responds the specific peripherals' status. Please refer to the “**Parameter Pairs Table**” for specific input parameters.

Return:

```
HTTP/1.0 200 OK \r\n
...
content-type: text/plain\r\n
\r\n
<parameter pair>\r\n
<parameter pair>\r\n
.....
```

Here are the details of parameter pairs, **parameters depend on product models.**
“error” value response indicate that “Failed to query/control the peripheral equipments”

Parameter Pairs Table

Parameter	Get/Set	Value and description
privacy_button	Query only	Privacy button status, valid values: [disabled off on]
pir	Query only	PIR status, valid values: [disabled actionless active]
light_sensor	Query only	Light sensor status, valid values: [disabled night day]
pt_position	Query only	Query current Pan & Tilt position, because the MCU can't get response from PT, so the values maybe wrong under some conditions. Format is “X,Y” “X” is the Pan position; “Y” is the Tilt position.
input_1 input_2	Query only	Input #1,#2 status, valid values: [high low]
output_1 output_2	Get & Set	Onput #1,#2 status, Query format is “A,B”. “A” valid values: [high low] “B” valid values: [pulse static] Control format is “A”. “A” valid values: [high low]

dn_mode	Get & Set	Day/Night mode status, valid values: [day night] Day mode, IR LED off, IR cut switch close the window to filter the IR lights. Night mode, IR LED on, IR cut switch open the window not to filter the IR lights.
ir_cut	Get & Set	IR cut switch status, valid values: [close open]
ir_leds	Get & Set	IR LEDs status, valid values: [disabled off on], disabled is only valid for query CGI
wl_leds	Get & Set	White light LEDs status, valid values: [disabled off on], disabled is only valid for query CGI

Control the peripheral components status

Method: GET

URL: [http://<ip>/io/control_pc.cgi?<parameter>=<value>\[&<parameter pair>...\]](http://<ip>/io/control_pc.cgi?<parameter>=<value>[&<parameter pair>...])

Parameter	Value and description
Please refer to the "Parameter Pairs Table"	

Return:

Successful request returns all group parameters or the specified parameters as below.

```
HTTP/1.0 200 OK\r\n
...
content-type: text/plain\r\n
...
\r\n
OK\r\n
```

Query IR cut switch status

Method: GET

URL: http://<ip>/io/query_filter.cgi

Return: Network Camera will return a Web page that contains the following messages.

```
HTTP/1.0 200 OK \r\n
...
content-type: text/plain\r\n
\r\n
filter=[0|1]\r\n                <- 0= Close the window; 1= Open the window
\r\n
```

Admin-level CGI commands (administrator level privilege)

Query FW version

Method: GET

URL: <http://<ip>/adm/sysinfo.cgi>

Return: Network Camera will return a Web page that contains the following messages.

```
HTTP/1.0 200 OK \r\n
...
content-type: text/plain\r\n
\r\n
Firmware Version: V1.0.01\r\n
Serial Number: SQJ00G100001\r\n
```

Reboot

Method: GET

URL: <http://<ip>/adm/reboot.cgi>

Return:

```
HTTP/1.0 200 OK \r\n
...
content-type: text/plain\r\n
\r\n
OK\r\n
```

Restore to factory defaults

Method: GET

URL: http://<ip>/adm/reset_to_default.cgi

Return:

```
HTTP/1.0 200 OK \r\n
...
content-type: text/plain\r\n
\r\n
OK\r\n
```

Query/Control the peripheral components status

Start/Stop the camera privacy mode

Method: GET

URL: http://<ip>/adm/privacy_ctl.cgi?privacy=<parameter>

Parameter	Value and description
start	start: camera enter privacy mode. Any user can't view the video any more.
stop	stop: camera end the privacy mode.

Return:

Successful request returns all group parameters or the specified parameters as below.

```
HTTP/1.0 200 OK\r\n
...
content-type: text/plain\r\n
...
\r\n
OK\r\n
```

Get/Set group parameters

Get group parameters

Method: GET

URL: [http://<ip>/adm/get_group.cgi?<parameter>=<value>\[&<value>...\]](http://<ip>/adm/get_group.cgi?<parameter>=<value>[&<value>...])

Parameter	Value and description
group	<ol style="list-style-type: none">To get all group settings group_name (The group name is case insensitive.)To get a specific setting from a group group_name.parameter_nameTo get the settings from multiple groups group_name&group_name... <p>Note that all group_name and parameter_name are defined in the <i>Network Camera Configuration Spec</i></p>

Return:

All group settings or one group setting will be returned as below.

```
HTTP/1.0 200 OK\r\n
...
content-type: text/plain\r\n
```

```

...
\r\n
[group1]\r\n
<parameter pair>\r\n
<parameter pair>\r\n
...\r\n
[group2]\r\n
<parameter pair>\r\n
<parameter pair>\r\n
...\r\n

```

Where <parameter pair> is <parameter_name>=<parameter_value>.

Set group parameters

Method: GET

URL: [http://<ip>/adm/set_group.cgi?<parameter>=<value>\[&<parameter pair>...\]](http://<ip>/adm/set_group.cgi?<parameter>=<value>[&<parameter pair>...])

Parameter	Value and description
group	<p>Group name is specified here. (The group name is case insensitive.)</p> <p>Note that all group values are defined in the <u>Network Camera Configuration Spec.</u></p> <ol style="list-style-type: none"> To set a specific setting in a group <p>group=group1&key=value...</p> To get the settings from multiple groups <p>group=group1&key=value...&group=group2&key=value...</p>

Return:

Successful request returns all group parameters or the specified parameters as below.

```

HTTP/1.0 200 OK\r\n
...
content-type: text/plain\r\n
...
\r\n
OK\r\n

```

Get/Set System date and time

Method: GET

URL: [http://<ip>/adm/date.cgi?action=<value>\[&<parameter pair>...\]](http://<ip>/adm/date.cgi?action=<value>[&<parameter pair>...])

Parameter	Value and description
action	Get/Set the system date and time get= Get the system date and time set= Set the system date and time
time_zone	The index value in time zone table (Readonly), please refer to Network Configuration file Spec
year	Year (2005~2037)
month	Month (1~12)
day	Day (1~31)
hour	Hour (0~23)
minute	Minute (0~59)
second	Second (0~59)

Return:

Successful request returns all group parameters or the specified parameters as below.

```
HTTP/1.0 200 OK\r\n
...
content-type: text/plain\r\n
...
\r\n
OK\r\n
<parameter pair>\r\n
<parameter pair>\r\n
... \r\n
```

Upgrade firmware

Method: POST

URL: <http://<ip>/adm/upgrade.cgi>

Message body:

```
...
...
<boundary=...>
...
<FW binary data>
```

The client must wait as least 5 minutes to make sure all flashes have been programmed.

Return: A FW Upgrade Progress window will be returned.

Upload/Download configuration

Download configuration content

Method: GET

URL: <http://<ip>/adm/admcfg.cfg>

Return:

```
HTTP/1.0 200 OK \r\n
...
content-type: application/configuration\r\n
\r\n
<configuration content encoded in Base64 format>
```

All data in the configuration are encoded in a Base64 format.

There is the hidden check sum data inside the configuration content to validate the data, Because we use the dword-aligned checksum algorithm, so we will ignore the last data misaligned by dword.

Upload configuration content

Method: POST

URL: <http://<ip>/adm/upload.cgi>

Message body:

```
...
<boundary=...>
<configuration content encoded in Base64 fformat>
```

All data in the configuration are encoded in a Base64 format.

Network camera will be automatically rebooted after received and loaded the configuration content.

Return:

```
HTTP/1.0 200 OK \r\n
...
content-type: text/plain\r\n
\r\n
OK\r\n
```

Extension to the configuration format

The configuration contents are shown as following:

Items	Data length (Bytes)	Description
Configuration file	Variable	The general/original configuration file
0x00x0	2	Ending characters, for backward support

TLV blocks	Variable	TLV blocks content for extension items, such Logo image... Type: 4 bytes, block types Length: 4 bytes, block size excluding Type & Length items Value: Block content
TLV blocks ...	Variable	
File tail	12	File tail information: Version: 4 bytes, (init as 0x0001) Checksum: 4 bytes, validation information for the whole configuration content excluding this file tail. Because we use the dword-aligned checksum algorithm, so we will ignore the last data misaligned by dword. DataSize: 4 bytes, the size of configuration content excluding this file tail.

TLV block type define:

Type	Description
0x0001	Logo image
0x0002	HTTPS CA
0x0003	802.1x ROOT CA
0x0004	802.1x User CA

Download logs

Method: GET

URL: <http://<ip>/adm/log.cgi>

Return:

```
HTTP/1.0 200 OK \r\n
...
content-type: text/plain\r\n\r\n
...
<log data>
```

Motion detection commands

The user could configure the motion detection in max up to 4 specific areas (depends on models). Each area could have its own name and its own threshold setting. Once the moving indicators exceed the user-configured threshold, then it should have a motion detection event.

Here's the definition of the detected area coordinate.

For some reasons, the client S/W might need to **backward support** the motion detection CGI and padding data within the old models of camera. Please refer the [appendix](#) section to get the details..

The home (0, 0) position is located at the left-top corner. The whole scale is for 640x480 resolution. So the horizontal position, x, will be expressed as an integer value from 0 to 639 and ascend from left to right. The vertical position, y, will be expressed as an integer value from 0 to 479 and ascend from top to bottom.

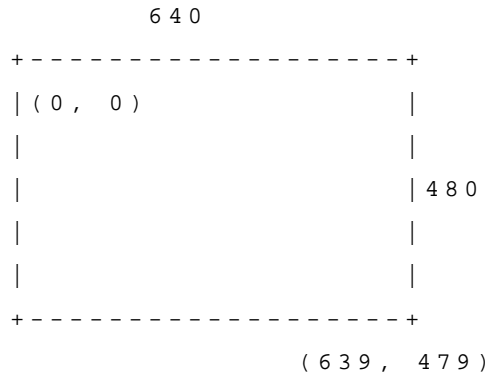

The configured area coordinate:

The left-top corner is the start position. The right-bottom corner is the stop position.

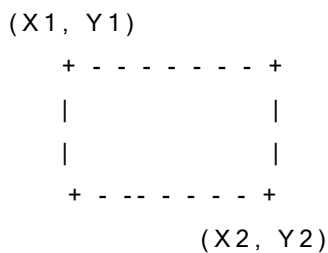

Whatever the current streaming resolution is, the replied coordinate always maps to the **640x480** scale.

Get Motion Detection Settings

Method: **GET**

URL: http://<IP>/adm/get_group.cgi?group=MOTION

(Please refer to **Get group parameters** command.)

Parameter	Value and description
group	Motion This is a required paramter & value to let the CGI know the request is for “ motion detection ” group.

Return:

All group settings or one group setting will be returned as below.

```
HTTP/1.0 200 OK\r\n
```

```
...
content-type: text/plain \r\n
...
\r\n
[MOTION]
.... ← Please refer to the chapter [MOTION] group in Configuration file Spec
document.
\r\n
```

Set Motion Detection Settings

Method: **GET**

URL: http://<IP>/adm/set_group.cgi?group=MOTION&<parameter>=<value>...

(Please refer to **Set group parameters** command and Configuration file Spec document.)

Return:

```
HTTP/1.0 200 OK\r\n
...
content-type: text/plain\r\n
\r\n
OK\r\n
```

Notes:

In some special models (the first motion window is used for full screen), the S/W (OCX) side needs to do it as the following way (without changing any configure item):

1. Use "md_switch1" as the switch of "full screen" or "sub-windows".
2. The md_window1 always sets to 640x480 size.

If "md_switch1=1", then the camera needs to detect in the whole screen video. The OCX can't allow the user to configure the rest windows (sub-window 1~3).

If "md_switch1=0", then the camera will detect in the "md_window2~4" area. (It's the same as the sub-windows 1~3.)

Motion Vector Data

To include the motion vector values in the streaming packets.

Whatever the streaming method is - ASF (through HTTP) or RTP (through UDP), the streaming data will include such information to let the client side S/W to judge whether the motion event is triggered or not.

The data locates in the padding bytes of the streaming data.

As to the data format in the streaming packet, please refer to the [next section](#).

Padding Data Format

The purpose of the padding data field is to let the PC side software (ActiveX or Utility...) could parse the padding data to get the relative information.

The F/W (camera side) should always pad the data if it supports some features (even is disabled).

1. MPEG-4 platform.
 - 1.1. The F/W always pad the data over video.asf streaming
 - 1.2. The F/W does not pad anything over the RTP/RTSP streaming
2. H.264 platform

The F/W pads the data over the streamings if the client bring the extension parameter “padding=yes” by request, please refer to the chapter ” Extension to the streaming URL defines” for details.

The following padding data starts from the 1st byte of the padding area (after the normal streaming frames)

Padding format (Intel format):

4 Bytes	1 Byte	1 ~ 4 Byte	XXX Byte	1 Byte	1 ~ 4 Byte	XXX Byte	2 Bytes
Total Length	Command_1	Length	Data	Command_2	Length	Data		Padding End

Rules:

1. The 1st 4 bytes padding is to declaim the total padding length, including these 4 bytes and the “Padding End” (from 1st byte to the last byte, including length and end command).
2. The following padding data will divide into 3 parts:
 - A. Padding command (1 byte)
 - B. Padding length for the specific command (1~4 bytes)
 - C. Padding data for the specific command
3. The length of the “padding length” depends on the command range.
 - A. **0x00 ~ 0xBF**: the length field is in “*1 byte*”
 - B. **0xC0 ~ 0xDF**: the length field is in “*2 bytes*”
 - C. **0xE0 ~ 0xFF**: the length field is in “*4 bytes*”
4. The last 2 bytes are the “Padding End” (**0xBF00**) command. It equals to the “command=END” + “length=0”.
5. The padding command could be in any sequence.

Command	Description
0x01	<p>Motion Detection Padding, in video frame</p> <p>The data length is 13.</p> <p>Byte 1: Motion detection is enabled or not (main switch) and whether it is in the effect schedule or not..</p> <p style="padding-left: 40px;">0x00 = 0 = Off</p> <p style="padding-left: 40px;">0x01 = 1 = On & not in effect schedule</p> <p style="padding-left: 40px;">0x11 = 17 = On & in effect schedule</p> <p>Byte 2 ~ 5 Current motion indicator of the detected window 1 ~ 4</p> <p style="padding-left: 40px;">0 ~ 255</p> <p>Byte 6 ~ 9 Current threshold of the detected window 1 ~ 4</p> <p style="padding-left: 40px;">0 ~ 255</p> <p>Byte 10 ~ 13 Motion detect window 1 ~ 4 is enabled or not.</p> <p style="padding-left: 40px;">0 = Off</p> <p style="padding-left: 40px;">1 = On</p>
0x11	<p>Motion Detection Padding (extension), depends on models, in video frame</p> <p>Byte 1: The data length of the data, depends on the windows number.</p> <p>Byte 2: Motion detection is enabled or not (main switch) and whether it is in the effect schedule or not.</p> <p style="padding-left: 40px;">0x00 = 0 = Off</p> <p style="padding-left: 40px;">0x01 = 1 = On & not in effect schedule</p> <p style="padding-left: 40px;">0x11 = 17 = On & in effect schedule</p> <p>Block1~n: The Motion windows information block</p> <p style="padding-left: 40px;">8 bytes per block, the blocks numbers is the windows number</p> <p style="padding-left: 40px;">Byte 1,2 in block: Current motion indicator of the detected window, word type</p> <p style="padding-left: 80px;">0 ~ 65535, currently use only 0~255</p> <p style="padding-left: 40px;">Byte 3 in block: Motion detect window is enabled or not</p> <p style="padding-left: 80px;">0 = Off</p> <p style="padding-left: 80px;">1 = On</p> <p style="padding-left: 40px;">Byte 4 in block: Current frequency of the detected window,</p> <p style="padding-left: 80px;">How frequently is the movement updated into the reference frame.</p> <p style="padding-left: 80px;">100 indicate to update per frame.</p> <p style="padding-left: 80px;">1 ~ 100</p>

	<p>Byte 5,6 in block: Current threshold of the detected window, word type 0 ~ 65535, currently use only 0~255</p> <p>Byte 7,8 in block: Current sensitivity of the detected window, word type 0 ~ 65535, currently use only 0~10, 10 is the most sensitive.</p>
0x02	<p>Input I/O Ports Padding, in video frame The data length is 2.</p> <p>Byte 1: The Input port 1 is triggered or not.. and whether it is in the effect schedule or not.. 0x00 = 0 = Off 0x01 = 1 = On & Triggered & not in effect schedule 0x11 = 17 = On & Triggered & in effect schedule</p> <p>Byte 2: The Input port 2 is triggered or not.. and whether it is in the effect schedule or not.. 0x00 = 0 = Off 0x01 = 1 = On & Triggered & not in effect schedule 0x11 = 17 = On & Triggered & in effect schedule</p>
0x03	<p>PIR sensor Padding, in video frame The data length is 1.</p> <p>Byte 1: The PIR sensor is triggered or not.. and whether it is in the effect schedule or not.. 0x00 = 0 = Off 0x01 = 1 = On & Triggered & not in effect schedule 0x11 = 17 = On & Triggered & in effect schedule</p>
0x04	<p>Audio Volume Detection Padding, in audio frame The data length is 2.</p> <p>Byte 1: Audio Volume detection is enabled or not (main switch) and whether it is in the effect schedule or not.. 0x00 = 0 = Off 0x01 = 1 = On & not in effect schedule 0x11 = 17 = On & in effect schedule</p> <p>Byte 2: Current audio volume level 0 ~ 100</p>
0xBF	<p>End-Of-Padding The data length is 0. There's no additional padding after this command (0xBF00).</p>

Examples:

A. The padding contains motion detection data only.

Length				Command	Length	On/Off	Indicator				Threshold				Window - On/Off				End	
0x00	0x00	0x00	0x15	0x01	0x0D	0 (OFF)	20	30	129	0	128	128	128	128	1	1	1	0	0xBF	0x00

0x15 = 21 (total length = 21 bytes)

B. The padding contains both motion detection and input ports data.

Length				Command	Length	On	Indicator				Threshold				On/Off				Command	Length	In-1	In-2	End	
0x00	0x00	0x00	0x19	0x01	0x0D	1	0	3	2	0	128	128	128	128	0	1	1	0	0x02	0x02	0	0	0xBF	0x00

0x19 = 25 (total length = 25 bytes)

C. The padding contains some long commands. (Ex. Command 0xC1 needs length 500 data)

Length				Command	Length		Total = 500 bytes										End					
0x00	0x00	0x01	0xFD	0xC1	0x01	0xF4	Data...	Data	Data	0xBF	0x00

0x1FD = 509 (total length = 509 bytes)

0x01F4 = 500 (length of command 0xC1 = 500 bytes)

Wireless Commands

Wireless Site Survey

Method: GET

URL: http://<ip>/adm/site_survey.cgi

Return:

The result to wireless site survey will be returned after a timeout, the timeout in camera is around 10 seconds, and the maximal number of sites is 30, so the maximal length of data is up to around 16Kbytes.

Successful request returns the result of wireless site survey as below, case sensitive.

```

HTTP/1.0 200 OK\r\n
...
Content-type: text/xml\r\n
...
\r\n
<?xml version="1.0" encoding="utf-8"?>\r\n
<SiteList>\r\n
    <Site>\r\n
        <SSID>SerComm</SSID>\r\n
        <BSSID>00:C0:02:FF:C2:B3</BSSID>\r\n
    
```

```

        <Mode>Infrastructure</Mode>\r\n
        <Security>WPA-PSK/WPA2-PSK</Security>\r\n
        <AUTH>OpenSystem</AUTH>\r\n
        <Encryption>Mixed(TKIP,AES)</Encryption>\r\n
        <Channel>6</Channel>\r\n
        <Signal>72</Signal>\r\n
        <WPS>Yes</WPS>\r\n
    </Site>\r\n
    .....
</SiteList>\r\n

```

If can't survey anything or wireless card is not available, the result as below, case sensitive.

```

HTTP/1.0 200 OK\r\n
...
Content-type: text/xml\r\n
...
\r\n
<?xml version="1.0" encoding="utf-8"?>\r\n
<SiteList>\r\n
</SiteList>\r\n

```

The parameters of result as below.

Parameter	Value Description
SSID	Wireless SSID, up to 32 ASCII characters, but because the result is xml file format, the max string length will catch up to 192, and the translated characters as below: " -> ""," '<' -> "<," '>' -> ">," '&' -> "&,"
BSSID	Wireless BSSID, six groups of two hexadecimal digits, upper case, separated by colons (:), example: 00:C0:02:FF:C2:B3
Mode	Wireless network type, the value can be: Ad-hoc Infrastructure

Security	Wireless security system, the value can be as below, and using '/' to express multiple selections: None WEP WPA-PSK WPA2-PSK WPA-Enterprise WPA2-Enterprise Example for expressing multiple selections: WPA-PSK/WPA2-PSK
AUTH	Wireless authentication type, the value can be as below, ShareKey type is only support in WEP security mode: Unknown OpenSystem SharedKey
Encryption	Wireless encryption method, the value can be: Unknown None WEP TKIP AES Mixed(TKIP+AES)
Channel	Wireless channel, Integer type, the value can be 1~14
Signal	Wireless signal, percentage, Integer type, the value can be 1~100, 100 is the strongest
WPS	Expressing whether AP support WPS(Wi-Fi Protected Setup) function, the value can be: No Yes PBC PIN-Code

Wireless status query

Method: GET

URL: http://<ip>/adm/wireless_status.cgi

Return: Network Camera will return a Web page that contains the following messages.

```
HTTP/1.0 200 OK \r\n
...
```

```

content-type: text/plain\r\n
\r\n
signal_strength=100\r\n          # Wireless signal, percentage, Integer type, the
value can be 1~100, 100 is the strongest.
\r\n

```

SMB/CIFS Server/SharedFolder commands

SMB/CIFS Server Survey

Method: GET

URL: [http://<ip>/adm/smb_survey.cgi\[?parameter=value\[¶meter=value...\]\]](http://<ip>/adm/smb_survey.cgi[?parameter=value[¶meter=value...]])

Parameter	Value and description
timeout	Optional, the timeout in seconds of the cgi, the cgi will stop survey and return the result if timeout, valid values: 5-120, default is 30
action	Optional, this CGI will terminate survey action. stop

Return:

The result will be returned in xml format as following, the content size depends on how many servers in the network.

Successful request returns the result of Samba site survey as below, case sensitive.

```

HTTP/1.0 200 OK\r\n
...
Content-type: text/xml\r\n
...
\r\n
<?xml version="1.0" encoding="utf-8"?>\r\n
<List>\r\n
  <WorkGroup>\r\n
    <Name></Name>\r\n
    <List>\r\n
      <Server>\r\n
        <Name></Name>\r\n
        <Comment></Comment>\r\n
      </Server>\r\n
      ...
    </List>\r\n
  </WorkGroup>\r\n

```

```

...
</List>\r\n

```

The xml tag description

Parameter	Value Description
Name (WorkGroup)	It's the work group name, up to 15 characters.
Name (Server)	It's the PC name of the server, up to 63 characters.
Comment (Server)	It's the description of the server, up to 256 characters.

SMB/CIFS SharedFolder command

Method: GET

URL: [http://<ip>/adm/smb_dirctrl.cgi?server=value\[¶meter=value...\]](http://<ip>/adm/smb_dirctrl.cgi?server=value[¶meter=value...])

Parameter	Value and description
server	Server address, Up to 64 characters
path	Optional, depends on the parater "cmd". The operation folder. Up to 128 character
cmd	Optional, the valid value is: mkdir: create a new folder,given by the "path" parameter. rmdir: delete a folder,given by the "path" parameter. If there is no this parameter, the CGI will survey the shared folder list in the given url by default
need_rights	Optional, check the user rights for the folder, only for the survey command. Regard as read rights without this parameter. r: Have the read rights w: Have the write rights rw or wr: Have the Read and Write
user	Optional, the username to login the server
pass	Optional, the password to login the server

Return:

Successful request returns the result, case sensitivity; the <List> content will be responded only when the status is ok.

```

HTTP/1.0 200 OK\r\n
...
Content-type: text/xml\r\n

```



```

...
\r\n
<?xml version="1.0" encoding="utf-8"?>\r\n
<List>
    <Status></Status>
    <Folder>
        <Name></Name>
        ....
    </Folder>
</List>

```

The xml tag description

Parameter	Value Description
Status	Value as following (all are in lower case): ok → Operate the folder successfully. invalid → Invalid input parameters unauth → Need the correct username/password denied → Denied , resource occupied file-exist → There is the file, reject the operation. readonly → Read only rights. writeonly → Write only rights. error → Error happened
Name	The folder name