



DFS MEASUREMENT REPORT

FCC ID: P27OT4221
Applicant: Sercomm Corporation
Product: Dual Band ONT
Model No.: AOT-4221SR
Brand Name: Airtel
FCC Classification: Unlicensed National Information Infrastructure (NII)
FCC Rule Part(s): Part 15 Subpart E (Section 15.407)
Result: Complies
Test Date: 2022-03-27 ~ 2022-04-10

Reviewed By:

Approved By:



The test results relate only to the samples tested.

This equipment has been shown to be capable of compliance with the applicable technical standards as indicated in the measurement report and was tested in accordance with the measurement procedures specified in KDB 905462. Test results reported herein relate only to the item(s) tested.

The test report shall not be reproduced except in full without the written approval of MRT Technology (Suzhou) Co., Ltd.

Revision History

Report No.	Version	Description	Issue Date	Note
2202RSU049-U4	Rev. 01	Initial Report	2022-07-31	Invalid
2202RSU049-U4	Rev. 02	Add adapter2#	2022-10-13	Valid

CONTENTS

Description	Page
1. General Information	5
1.1. Applicant	5
1.2. Manufacturer	5
1.3. Testing Facility	5
1.4. Product Information	6
1.5. Radio Specification	6
1.6. Working Frequencies	7
1.7. Antenna Details	7
2. Test Configuration.....	9
2.1. Test Mode	9
2.2. Test Channel	9
2.3. Applied Standards	9
2.4. Test Environment Condition.....	9
3. DFS Detection Thresholds and Radar Test Waveforms	10
3.1. Applicability	10
3.2. DFS Devices Requirements	11
3.3. DFS Detection Threshold Values	13
3.4. Parameters of DFS Test Signals	14
3.5. Conducted Test Setup	17
4. Measuring Instrument.....	18
5. Test Result	19
5.1. Summary.....	19
5.2. Radar Waveform Calibration Measurement	20
5.2.1. Calibration Setup	20
5.2.2. Calibration Procedure	20
5.2.3. Calibration & Channel Loading Result	20
5.3. NII Detection Bandwidth Measurement	21
5.3.1. Test Limit.....	21
5.3.2. Test Procedure.....	21
5.3.3. Test Result	22
5.4. Initial Channel Availability Check Time Measurement.....	23
5.4.1. Test Limit.....	23
5.4.2. Test Procedure.....	23
5.4.3. Test Result	23
5.5. Radar Burst at the Beginning of the Channel Availability Check Time Measurement	24

5.5.1.	Test Limit.....	24
5.5.2.	Test Procedure.....	24
5.5.3.	Test Result	24
5.6.	Radar Burst at the End of the Channel Availability Check Time Measurement.....	25
5.6.1.	Test Limit.....	25
5.6.2.	Test Procedure.....	25
5.6.3.	Test Result	25
5.7.	In-Service Monitoring for Channel Move Time, Channel Closing Transmission Time and Non-Occupancy Period Measurement.....	26
5.7.1.	Test Limit.....	26
5.7.2.	Test Procedure.....	26
5.7.3.	Test Result	27
5.8.	Statistical Performance Check Measurement	28
5.8.1.	Test Limit.....	28
5.8.2.	Test Procedure.....	28
5.8.3.	Test Result	29
Appendix A – Test Result.....		30
A.1	Calibration Test Result.....	30
A.2	Channel Loading Test Result.....	32
A.3	NII Detection Bandwidth Test Result	33
A.4	Initial Channel Availability Check Time Test Result	36
A.5	Radar Burst at the Beginning of the Channel Availability Check Time Test Result.....	37
A.6	Radar Burst at the End of the Channel Availability Check Time Test Result	38
A.7	In-Service Monitoring for Channel Move Time, Channel Closing Transmission Time and Non-Occupancy Period Test Result.....	39
A.8	Statistical Performance Check	40
Appendix B – Test Setup Photograph		126
Appendix C – EUT Photograph		127

1.4. Product Information

Product Name	Dual Band ONT
Model No.	AOT-4221SR
Brand Name	Airtel
Serial No.	SROT3B010064
Wi-Fi Specification	802.11 a/b/g/n/ac
Antenna Information	Refer to clause 1.7
Operating Temp.	0~45°C
Accessory	
Adapter 1#	Model No.: MSA-C2000IS12.0-24W-IN Input Power: 90 - 270V ~ 50/60Hz, 0.7A max Output Power: 12V dc 2.0A
Adapter 2#	Model No.: WS1202000A10FI Input Power: 90 - 270V ~ 50/60Hz, 0.6A Output Power: 12V = 2.0A
Remark: 1. The information of EUT was provided by the manufacturer, and the accuracy of the information shall be the responsibility of the manufacturer. 2. We choose Adapter 1# to RF testing.	

1.5. Radio Specification

Frequency Range	For 802.11a/n-HT20/ac-VHT20: 5260~5320MHz, 5500~5720MHz For 802.11n-HT40/ac-VHT40: 5270~5310MHz, 5510~5710MHz For 802.11ac-VHT80: 5290MHz, 5530MHz, 5610 MHz, 5690MHz
Type of Modulation	802.11a/n/ac: OFDM
Data Rate	802.11a: 6/9/12/18/24/36/48/54Mbps 802.11n: up to 300Mbps 802.11ac: up to 866.7Mbps
Power-on cycle	Requires 142.2 seconds to complete its power-on cycle
Uniform Spreading (For DFS Frequency Band)	For the 5250-5350MHz, 5470-5725 MHz bands, the Master device provides, on aggregate, uniform loading of the spectrum across all devices by selecting an operating channel among the available channels using a random algorithm.

Note: For other features of this EUT, test reports will be issued separately.

1.6. Working Frequencies

802.11a/n-HT20/ac-VHT20

Channel	Frequency	Channel	Frequency	Channel	Frequency
52	5260 MHz	56	5280 MHz	60	5300 MHz
64	5320 MHz	100	5500 MHz	104	5520 MHz
108	5540 MHz	112	5560 MHz	116	5580 MHz
120	5600 MHz	124	5620 MHz	128	5640 MHz
132	5660 MHz	136	5680 MHz	140	5700 MHz
144	5720 MHz	--	--	--	--

802.11n-HT40/ac-VHT40

Channel	Frequency	Channel	Frequency	Channel	Frequency
54	5270 MHz	62	5310 MHz	102	5510 MHz
110	5550 MHz	118	5590 MHz	126	5630 MHz
134	5670 MHz	142	5710 MHz	--	--

802.11ac-VHT80

Channel	Frequency	Channel	Frequency	Channel	Frequency
58	5290 MHz	106	5530 MHz	122	5610 MHz
138	5690 MHz	--	--	--	--

1.7. Antenna Details

Antenna Type	Frequency Band (MHz)	Tx Paths	Max Antenna Gain (dBi)	Beamforming Directional Gain (dBi)	CDD Directional Gain (dBi)	
					For Power	For PSD
PIFA Antenna	2412 ~ 2462	2	3.50	--	3.50	6.51
	5180 ~ 5240	2	3.20	6.21	3.20	6.21
	5260 ~ 5320	2	3.20	6.21	3.20	6.21
	5500 ~ 5720	2	3.30	6.31	3.30	6.31
	5745 ~ 5825	2	3.20	6.21	3.20	6.21

Remark:

1. The EUT supports Cyclic Delay Diversity (CDD) mode and CDD signals are correlated.

If all antennas have the same gain, G_{ANT} , Directional gain = G_{ANT} + Array Gain, where Array Gain is as follows.

- For power spectral density (PSD) measurements on all devices,

Array Gain = $10 \log (N_{\text{ANT}}/ N_{\text{SS}})$ dB;

- For power measurements on IEEE 802.11 devices,

Array Gain = 0 dB for $N_{\text{ANT}} \leq 4$;

2. The EUT also supports Beam Forming, but only in 802.11n/ac mode (5GHz). BF Directional gain = $G_{\text{ANT}} + 10 \log (N_{\text{ANT}})$.

2. Test Configuration

2.1. Test Mode

Mode 1: Operating under AP mode

2.2. Test Channel

Test Mode	Test Channel	Test Frequency
802.11ac-VHT20	100	5500 MHz
802.11ac-VHT40	102	5510 MHz
802.11ac-VHT80	106	5530 MHz

2.3. Applied Standards

According to the specifications of the manufacturer, the EUT must comply with the requirements of the following standards:

- FCC Part 15.407 Section (h)(2)
- KDB 905462 D02v02
- KDB 905462 D04v01

2.4. Test Environment Condition

Ambient Temperature	15 ~ 35°C
Relative Humidity	20 ~ 75%RH

3. DFS Detection Thresholds and Radar Test Waveforms

3.1. Applicability

The following table from FCC KDB 905462 D02 NII DFS Compliance Procedures New Rules v02 lists the applicable requirements for the DFS testing.

Requirement	Operational Mode		
	Master	Client Without Radar Detection	Client With Radar Detection
Non-Occupancy Period	Yes	Not required	Yes
DFS Detection Threshold	Yes	Not required	Yes
Channel Availability Check Time	Yes	Not required	Not required
U-NII Detection Bandwidth	Yes	Not required	Yes

Table 3-1: Applicability of DFS Requirements Prior to Use of a Channel

Requirement	Operational Mode	
	Master Device or Client With Radar Detection	Client Without Radar Detection
DFS Detection Threshold	Yes	Not required
Channel Closing Transmission Time	Yes	Yes
Channel Move Time	Yes	Yes
U-NII Detection Bandwidth	Yes	Not required

Additional requirements for devices with multiple bandwidth modes	Master Device or Client with Radar Detection	Client Without Radar Detection
U-NII Detection Bandwidth and Statistical Performance Check	All BW modes must be tested	Not required
Channel Move Time and Channel Closing Transmission Time	Test using widest BW mode available	Test using the widest BW mode available for the link
All other tests	Any single BW mode	Not required

Note: Frequencies selected for statistical performance check should include several frequencies within the radar detection bandwidth and frequencies near the edge of the radar detection bandwidth. For 802.11 devices it is suggested to select frequencies in each of the bonded 20 MHz channels and the channel center frequency.

Table 3-2: Applicability of DFS Requirements during normal operation

3.2. DFS Devices Requirements

Per FCC KDB 905462 D02 NII DFS Compliance Procedures New Rules v02 the following are the requirements for Master Devices:

- (a) The Master Device will use DFS in order to detect Radar Waveforms with received signal strength above the DFS Detection Threshold in the 5250 ~ 5350 MHz and 5470 ~ 5725 MHz bands. DFS is not required in the 5150 ~ 5250 MHz or 5725 ~ 5825 MHz bands.
- (b) Before initiating a network on a Channel, the Master Device will perform a Channel Availability Check for a specified time duration (Channel Availability Check Time) to ensure that there is no radar system operating on the Channel, using DFS described under subsection a) above.
- (c) The Master Device initiates a U-NII network by transmitting control signals that will enable other U-NII devices to Associate with the Master Device.
- (d) During normal operation, the Master Device will monitor the Channel (In-Service Monitoring) to ensure that there is no radar system operating on the Channel, using DFS described under a).
- (e) If the Master Device has detected a Radar Waveform during In-Service Monitoring as described under d), the Operating Channel of the U-NII network is no longer an Available Channel. The Master Device will instruct all associated Client Device(s) to stop transmitting on this Channel within the Channel Move Time. The transmissions during the Channel Move Time will be limited to the Channel Closing Transmission Time.
- (f) Once the Master Device has detected a Radar Waveform it will not utilize the Channel for the duration of the Non-Occupancy Period.
- (g) If the Master Device delegates the In-Service Monitoring to a Client Device, then the combination will be tested to the requirements described under d) through f) above.

Channel Move Time and Channel Closing Transmission Time requirements are listed in the following table.

Parameter	Value
Non-occupancy period	Minimum 30 minutes
Channel Availability Check Time	60 seconds
Channel Move Time	10 seconds See Note 1.
Channel Closing Transmission Time	200 milliseconds + an aggregate of 60 milliseconds over remaining 10 second period. See Notes 1 and 2.
U-NII Detection Bandwidth	Minimum 100% of the U-NII 99% transmission power bandwidth. See Note 3.
<p>Note 1: Channel Move Time and the Channel Closing Transmission Time should be performed with Radar Type 0. The measurement timing begins at the end of the Radar Type 0 burst.</p> <p>Note 2: The Channel Closing Transmission Time is comprised of 200 milliseconds starting at the beginning of the Channel Move Time plus any additional intermittent control signals required to facilitate a Channel move (an aggregate of 60 milliseconds) during the remainder of the 10 second period. The aggregate duration of control signals will not count quiet periods in between transmissions.</p> <p>Note 3: During the U-NII Detection Bandwidth detection test, radar type 0 should be used. For each frequency step the minimum percentage of detection is 90 percent. Measurements are performed with no data traffic.</p>	

Table 3-3: DFS Response Requirements

3.3. DFS Detection Threshold Values

The DFS detection thresholds are defined for Master devices and Client Devices with In-service monitoring.

These detection thresholds are listed in the following table.

Maximum Transmit Power	Value (See Notes 1, 2, and 3)
EIRP \geq 200 milliwatt	-64 dBm
EIRP < 200 milliwatt and power spectral density < 10 dBm/MHz	-62 dBm
EIRP < 200 milliwatt that do not meet the power spectral density requirement	-64 dBm
<p>Note 1: This is the level at the input of the receiver assuming a 0 dBi receive antenna.</p> <p>Note 2: Throughout these test procedures an additional 1 dB has been added to the amplitude of the test transmission waveforms to account for variations in measurement equipment. This will ensure that the test signal is at or above the detection threshold level to trigger a DFS response.</p> <p>Note3: EIRP is based on the highest antenna gain. For MIMO devices refer to KDB Publication 662911 D01.</p>	

Table 3-4: Detection Thresholds for Master Devices and Client Devices with Radar Detection

3.4. Parameters of DFS Test Signals

This section provides the parameters for required test waveforms, minimum percentage of successful detections, and the minimum number of trials that must be used for determining DFS conformance. Step intervals of 0.1 microsecond for Pulse Width, 1 microsecond for PRI, 1 MHz for chirp width and 1 for the number of pulses will be utilized for the random determination of specific test waveforms.

Short Pulse Radar Test Waveforms

Radar Type	Pulse Width (μsec)	PRI (μsec)	Number of Pulses	Minimum Percentage of Successful Detection	Minimum Number of Trials
0	1	1428	18	See Note 1	See Note 1
1	1	Test A: 15 unique PRI values randomly selected from the list of 23 PRI values in Table 3-6	$\text{Roundup} \left\{ \left(\frac{1}{360} \right) \cdot \left(\frac{19 \cdot 10^6}{\text{PRI}_{\mu\text{sec}}} \right) \right\}$	60%	30
		Test B: 15 unique PRI values randomly selected within the range of 518-3066 μsec, with a minimum increment of 1 μsec, excluding PRI values selected in Test A			
2	1-5	150-230	23-29	60%	30
3	6-10	200-500	16-18	60%	30
4	11-20	200-500	12-16	60%	30
Aggregate (Radar Types 1-4)				80%	120
Note: Short Pulse Radar Type 0 should be used for the detection bandwidth test, channel move time, and channel closing time tests.					

Table 3-5: Parameters for Short Pulse Radar Waveforms

A minimum of 30 unique waveforms are required for each of the Short Pulse Radar Types 2 through 4. If more than 30 waveforms are used for Short Pulse Radar Types 2 through 4, then each additional waveform must also be unique and not repeated from the previous waveforms.

Pulse Repetition Frequency Number	Pulse Repetition Frequency (Pulses Per Second)	Pulse Repetition Interval (Microseconds)
1	1930.5	518
2	1858.7	538
3	1792.1	558
4	1730.1	578
5	1672.2	598
6	1618.1	618
7	1567.4	638
8	1519.8	658
9	1474.9	678
10	1432.7	698
11	1392.8	718
12	1355	738
13	1319.3	758
14	1285.3	778
15	1253.1	798
16	1222.5	818
17	1193.3	838
18	1165.6	858
19	1139	878
20	1113.6	898
21	1089.3	918
22	1066.1	938
23	326.2	3066

Table 3-6: Pulse Repetition Intervals Values for Test A

Long Pulse Radar Test Waveform

Radar Type	Pulse Width (μsec)	Chirp Width (MHz)	PRI (μsec)	Number of Pulses per Burst	Number of Bursts	Minimum Percentage of Successful Detection	Minimum Number of Trials
5	50 - 100	5 - 20	1000 - 2000	1 - 3	8 - 20	80%	30

Table 3-7: Parameters for Long Pulse Radar Waveforms

The parameters for this waveform are randomly chosen. Thirty unique waveforms are required for the Long Pulse Radar Type waveforms. If more than 30 waveforms are used for the Long Pulse Radar Type waveforms, then each additional waveform must also be unique and not repeated from the previous waveforms.

Frequency Hopping Radar Test Waveform

Radar Type	Pulse Width (μsec)	PRI (μsec)	Pulses Per Hop	Hopping Rate (kHz)	Hopping Sequence Length (msec)	Minimum Percentage of Successful Detection	Minimum Number of Trials
6	1	333	9	0.333	300	70%	30

Table 3-8: Parameters for Frequency Hopping Radar Waveforms

For the Frequency Hopping Radar Type, the same Burst parameters are used for each waveform. The hopping sequence is different for each waveform and a 100-length segment is selected from the hopping sequence defined by the following algorithm:

The first frequency in a hopping sequence is selected randomly from the group of 475 integer frequencies from 5250 – 5724MHz. Next, the frequency that was just chosen is removed from the group and a frequency is randomly selected from the remaining 474 frequencies in the group. This process continues until all 475 frequencies are chosen for the set. For selection of a random frequency, the frequencies remaining within the group are always treated as equally likely.

3.5. Conducted Test Setup

The FCC KDB 905462 D02 NII DFS Compliance Procedures New Rules v02 describes a radiated test setup and a conducted test setup. The conducted test setup was used for this testing. Figure 3-1 shows the typical test setup.

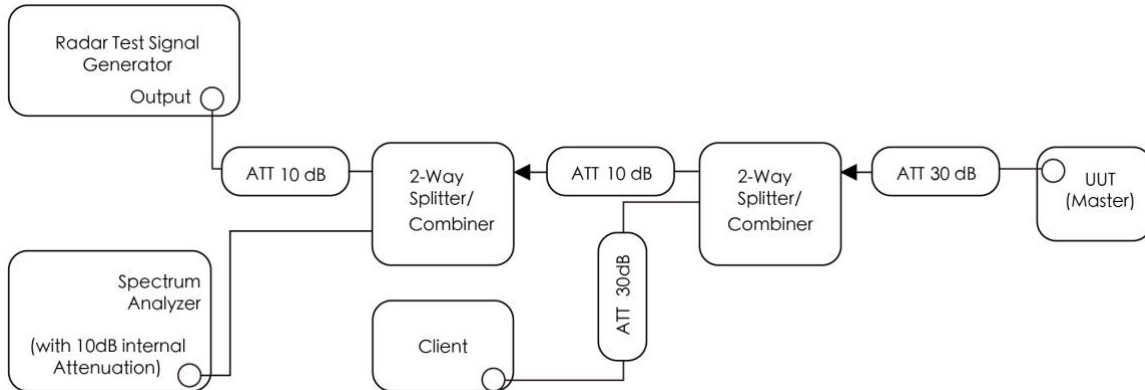

Figure 3-1: Conducted Test Setup where UUT is a Master and Radar Test Waveforms are injected into the Masters

4. Measuring Instrument

Instrument	Manufacturer	Model No.	Asset No.	Last Cali. Date	Cali. Due Date	Test Site
Signal Analyzer	Keysight	N9030B	MRTSUE06395	1 year	2022/8/8	SIP-TR2
Signal Generator	Keysight	N5182B	MRTSUE06605	1 year	2022/10/31	SIP-TR2
Thermohygrometer	testo	622	MRTSUE06628	1 year	2022/11/2	SIP-TR2

Client Information

Instrument	Manufacturer	Type No.	Certification Number
Wi-Fi Module	Intel	AX200NGW	FCC ID: PD9AX200NG

Software	Version	Manufacturer	Function
Signal Studio	V2.2.0.0	Keysight	DFS Test Software

5. Test Result

5.1. Summary

Parameter	Verdict	Reference
NII Detection Bandwidth Measurement	Pass	Section 5.3
Initial Channel Availability Check Time	Pass	Section 5.4
Radar Burst at the Beginning of the Channel Availability Check Time	Pass	Section 5.5
Radar Burst at the End of the Channel Availability Check Time	Pass	Section 5.6
In-Service Monitoring for Channel Move Time, Channel Closing Transmission Time	Pass	Section 5.7
Non-Occupancy Period	Pass	Section 5.7
Statistical Performance Check	Pass	Section 5.8

5.2. Radar Waveform Calibration Measurement

5.2.1. Calibration Setup

The conducted test setup was used for this calibration testing. Figure 3-2 shows the typical test setup.

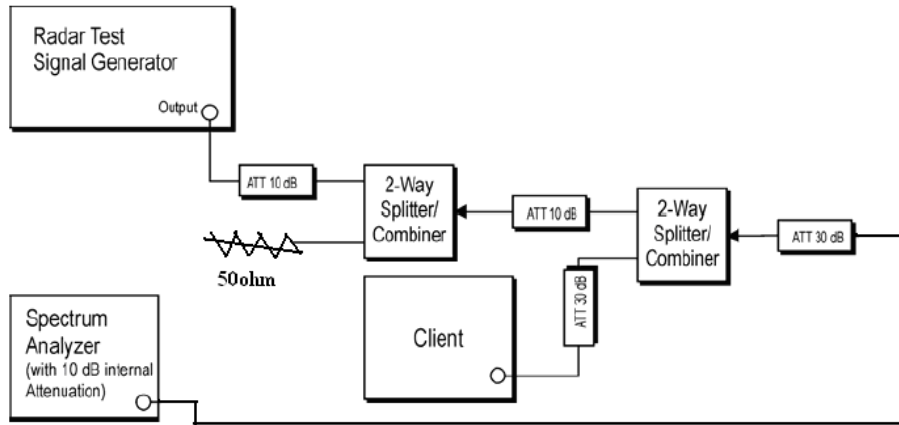

Figure 3-2: Conducted Test Setup

5.2.2. Calibration Procedure

The Interference Radar Detection Threshold Level is $(-64\text{dBm}) + (0) [\text{dBi}] + 1 \text{ dB} = -63 \text{ dBm}$ that had been taken into account the output power range and antenna gain. The above equipment setup was used to calibrate the conducted Radar Waveform. A vector signal generator was utilized to establish the test signal level for each radar type. During this process there were replace 50ohm terminal form Master and Client device and no transmissions by either the Master or Client Device. The spectrum analyzer was switched to the zero span (Time Domain) at the frequency of the Radar Waveform generator. Peak detection was used. The spectrum analyzer resolution bandwidth (RBW) and video bandwidth (VBW) were set to at least 3MHz. The vector signal generator amplitude was set so that the power level measured at the spectrum analyzer was $(-64\text{dBm}) + (0) [\text{dBi}] + 1 \text{ dB} = -63\text{dBm}$. Capture the spectrum analyzer plots on short pulse radar types, long pulse radar type and hopping radar waveform.

5.2.3. Calibration & Channel Loading Result

Refer to Appendix A.1 & A.2.

5.3. NII Detection Bandwidth Measurement

5.3.1. Test Limit

Minimum 100% of the NII 99% transmission power bandwidth. During the U-NII Detection Bandwidth detection test, each frequency step the minimum percentage of detection is 90 percent. Measurements are performed with no data traffic.

5.3.2. Test Procedure

1. Adjust the equipment to produce a single Burst of any one of the Short Pulse Radar Types 0-4 in Table 3-5 at the center frequency of the EUT Operating Channel at the specified DFS Detection Threshold level.
2. The generating equipment is configured as shown in the Conducted Test Setup above section 3.5.
3. The EUT is set up as a stand-alone device (no associated Client or Master, as appropriate) and no traffic. Frame based systems will be set to a talk/listen ratio reflecting the worst case (maximum) that is user configurable during this test.
4. Generate a single radar Burst, and note the response of the EUT. Repeat for a minimum of 10 trials. The EUT must detect the Radar Waveform using the specified U-NII Detection Bandwidth criterion shown in Table 3-5. In cases where the channel bandwidth may exceed past the DFS band edge on specific channels (i.e., 802.11ac or wideband frame based systems) select a channel that has the entire emission bandwidth within the DFS band. If this is not possible, test the detection BW to the DFS band edge.
5. Starting at the center frequency of the UUT operating Channel, increase the radar frequency in 5 MHz steps, repeating the above test sequence, until the detection rate falls below the U-NII Detection Bandwidth criterion specified in Table 3-3. Repeat this measurement in 1MHz steps at frequencies 5 MHz below where the detection rate begins to fall. Record the highest frequency (denote as FH) at which detection is greater than or equal to the U-NII Detection Bandwidth criterion. Recording the detection rate at frequencies above FH is not required to demonstrate compliance.
6. Starting at the center frequency of the EUT operating Channel, decrease the radar frequency in 1 MHz steps, repeating the above item 4 test sequence, until the detection rate falls below the U-NII Detection Bandwidth criterion. Record the lowest frequency (denote as FL) at which detection is greater than or equal to the U-NII Detection Bandwidth criterion. Recording the detection rate at frequencies below FL is not required to demonstrate compliance.
7. The U-NII Detection Bandwidth is calculated as follows: $U\text{-NII Detection Bandwidth} = FH - FL$

8. The U-NII Detection Bandwidth must be at least 100% of the EUT transmitter 99% power, otherwise, the EUT does not comply with DFS requirements.

5.3.3. Test Result

Refer to Appendix A.3.

5.4. Initial Channel Availability Check Time Measurement

5.4.1. Test Limit

The EUT shall perform a Channel Availability Check to ensure that there is no radar operating on the channel. After power-up sequence, receive at least 1 minute on the intended operating frequency.

5.4.2. Test Procedure

1. The U-NII devices will be powered on and be instructed to operate on the appropriate U-NII Channel that must incorporate DFS functions. At the same time the EUT is powered on, the spectrum analyzer will be set to zero span mode with a 3 MHz RBW and 3 MHz VBW on the Channel occupied by the radar (Chr) with a 2.5 minute sweep time. The spectrum analyzer's sweep will be started at the same time power is applied to the U-NII device.
2. The EUT should not transmit any beacon or data transmissions until at least 1 minute after the completion of the power-on cycle.
3. Confirm that the EUT initiates transmission on the channel. Measurement system showing its nominal noise floor is marker1.

5.4.3. Test Result

Refer to Appendix A.4.

5.5. Radar Burst at the Beginning of the Channel Availability Check Time Measurement

5.5.1. Test Limit

In beginning of the Channel Availability Check (CAC) Time, radar is detected on this channel, select another intended channel and perform a CAC on that channel.

5.5.2. Test Procedure

1. The steps below define the procedure to verify successful radar detection on the selected Channel during a period equal to the Channel Availability Check Time and avoidance of operation on that Channel when a radar Burst with a level equal to the DFS Detection Threshold + 1 dB occurs at the beginning of the Channel Availability Check Time.
2. The EUT is in completion power-up cycle (from T0 to T1). T1 denotes the instant when the EUT has completed its power-up sequence. The Channel Availability Check Time commences at instant T1 and will end no sooner than T1 + 60 seconds. A single Burst of one of Short Pulse Radar Types 0-4 at DFS Detection Threshold + 1 dB will commence within a 6 second window starting at T1.
3. Visual indication on the EUT of successful detection of the radar Burst will be recorded and reported. Observation of emissions will continue for 2.5 minutes after the radar Burst has been generated. Verify that during the 2.5 minutes measurement window no EUT transmissions occurred.

5.5.3. Test Result

Refer to Appendix A.5.

5.6. Radar Burst at the End of the Channel Availability Check Time Measurement

5.6.1. Test Limit

In the end of Channel Availability Check (CAC) Time, radar is detected on this channel, select another intended channel and perform a CAC on that channel.

5.6.2. Test Procedure

1. The steps below define the procedure to verify successful radar detection on the selected Channel during a period equal to the Channel Availability Check Time and avoidance of operation on that Channel when a radar Burst with a level equal to the DFS Detection Threshold + 1 dB occurs at the beginning of the Channel Availability Check Time.
2. The EUT is powered on at T0. T1 denotes the instant when the EUT has completed its power-up sequence. The Channel Availability Check Time commences at instant T1 and will end no sooner than T1 + 60 seconds. A single Burst of one of Short Pulse Radar Types 0-4 at DFS Detection Threshold + 1 dB will commence within a 6 second window starting at T1+ 54 seconds.
3. Visual indication on the EUT of successful detection of the radar Burst will be recorded and reported. Observation of emissions will continue for 2.5 minutes after the radar Burst has been generated. Verify that during the 2.5 minutes measurement window no EUT transmissions occurred.

5.6.3. Test Result

Refer to Appendix A.6.

5.7. In-Service Monitoring for Channel Move Time, Channel Closing Transmission Time and Non-Occupancy Period Measurement

5.7.1. Test Limit

The EUT has In-Service Monitoring function to continuously monitor the radar signals. If the radar is detected, must leave the channel (Shutdown). The Channel Move Time to cease all transmissions on the current channel upon detection of a Radar Waveform above the DFS Detection Threshold within 10 sec. The total duration of Channel Closing Transmission Time is 260ms, consisting of data signals and the aggregate of control signals, by a U-NII device during the Channel Move Time. The Non-Occupancy Period time is 30 minute during which a Channel will not be utilized after a Radar Waveform is detected on that Channel.

5.7.2. Test Procedure

1. The test should be performed with Radar Type 0. The measurement timing begins at the end of the Radar Type 0.
2. When the radar burst with a level equal to the DFS Detection Threshold + 1dB is generated on the Operating Channel of the U-NII device. A U-NII device operating as a Master Device will associate with the Client Device at Channel. Stream the MPEG test file from the Master Device to the Client Device on the selected Channel for the entire period of the test. At time T0 the Radar Waveform generator sends a Burst of pulses for each of the radar types at Detection Threshold + 1dB.
3. Observe the transmissions of the EUT at the end of the radar Burst on the Operating Channel. Measure and record the transmissions from the EUT during the observation time (Channel Move Time).
4. Measurement of the aggregate duration of the Channel Closing Transmission Time method. With the spectrum analyzer set to zero span tuned to the center frequency of the EUT operating channel at the radar simulated frequency, peak detection, and max hold, the dwell time per bin is given by: $Dwell (1.5ms) = S (12 \text{ sec}) / B (8000)$; where Dwell is the dwell time per spectrum analyzer sampling bin, S is the sweep time and B is the number of spectrum analyzer sampling bins. An upper bound of the aggregate duration of the intermittent control signals of Channel Closing Transmission Time is calculated by: $C = N \times Dwell$; where C is the Closing Time, N is the number of spectrum analyzer sampling bins showing a U-NII transmission and Dwell is the dwell time per bin.
5. Measure the EUT for more than 30 minutes following the channel close/move time to verify that the EUT does not resume any transmissions on this Channel.

5.7.3. Test Result

Refer to Appendix A.7.

5.8. Statistical Performance Check Measurement

5.8.1. Test Limit

The minimum percentage of successful detection requirements found in below table when a radar burst with a level equal to the DFS Detection Threshold + 1dB is generated on the Operating Channel of the U-NII device (In- Service Monitoring).

Radar Type	Minimum Number of Trails	Detection Probability
0	30	Pd > 60%
1	30(15 of test A and 15 of test B)	Pd > 60%
2	30	Pd > 60%
3	30	Pd > 60%
4	30	Pd > 60%
Aggregate (Radar Types 1-4)	120	Pd > 80%
5	30	Pd > 80%
6	30	Pd > 70%

Note: The percentage of successful detection is calculated by:
 $(\text{Total Waveform Detections} / \text{Total Waveform Trails}) * 100 = \text{Probability of Detection Radar Waveform In}$
 addition an aggregate minimum percentage of successful detection across all Short Pulse Radar Types 1-4 is required and is calculated as follows: $(Pd1 + Pd2 + Pd3 + Pd4) / 4$.

5.8.2. Test Procedure

1. Stream the MPEG test file from the Master Device to the Client Device on the test Channel for the entire period of the test.
2. At time T0 the Radar Waveform generator sends the individual waveform for each of the Radar Types 1-6, at levels equal to the DFS Detection Threshold + 1dB, on the Operating Channel.
3. Observe the transmissions of the EUT at the end of the Burst on the Operating Channel for duration greater than 10 seconds for Short Pulse Radar Types 0 to ensure detection occurs.
4. Observe the transmissions of the EUT at the end of the Burst on the Operating Channel for duration greater than 22 seconds for Long Pulse Radar Type 5 to ensure detection occurs.
5. The device can utilize a test mode to demonstrate when detection occurs to prevent the need to reset the device between trial runs.
6. The Minimum number of trails, minimum percentage of successful detection and the average minimum percentage of successful detection are found in below table

5.8.3. Test Result

Refer to Appendix A.8.

Appendix A – Test Result

A.1 Calibration Test Result

Test Site	SIP-TR2	Test Engineer	Alisa Deng
Test Date	2022/03/27	Test Item	Radar Waveform Calibration

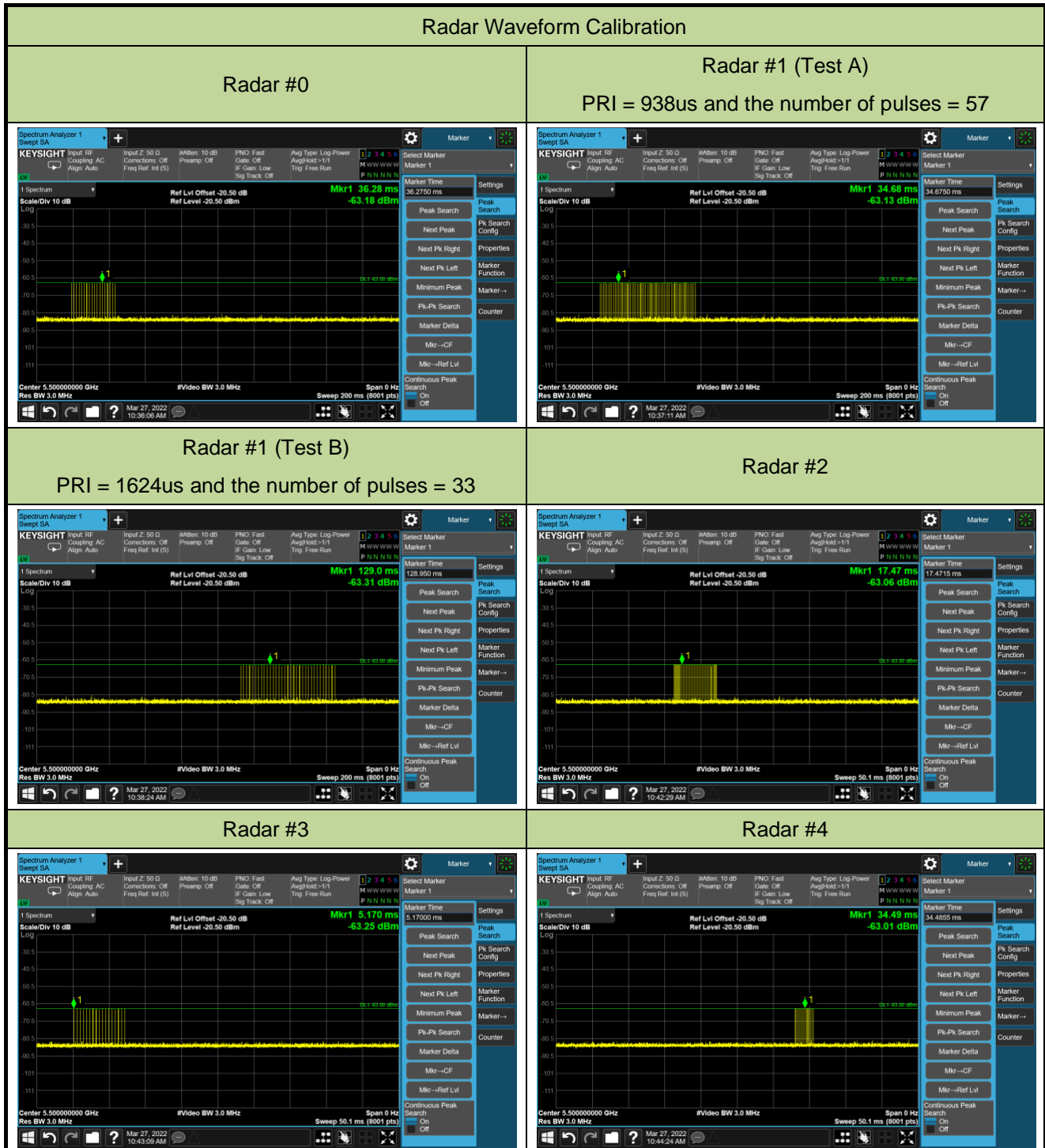



A.2 Channel Loading Test Result

Test Site	SIP-TR2	Test Engineer	Alisa Deng
Test Date	2022/03/27	Test Item	Channel Loading

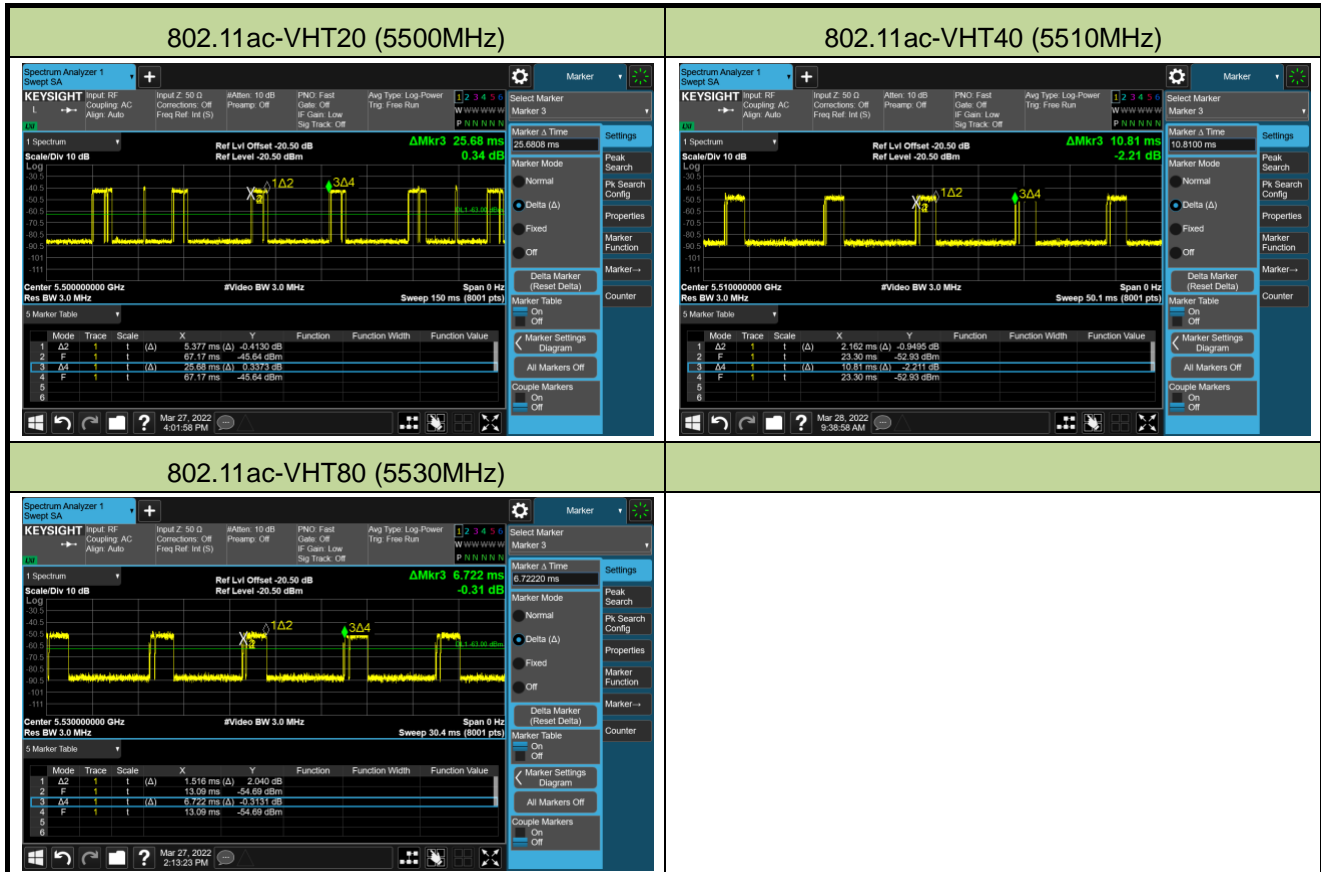

Test Mode	Test Frequency	Packet ratio	Requirement ratio	Test Result
802.11ac-VHT20	5500 MHz	20.94%	≥ 17%	Pass
802.11ac-VHT40	5510 MHz	20.00%	≥ 17%	Pass
802.11ac-VHT80	5530 MHz	22.55%	≥ 17%	Pass

Note: System testing was performed with the designated iperf test file. This file is used by IP and Frame based systems for loading the test channel during the In-service compliance testing of the U-NII device.

Packet ratio = Time On / (Time On + Off Time).

A.3 NII Detection Bandwidth Test Result

Test Site	SIP-TR2	Test Engineer	Alisa Deng
Test Date	2022/04/10		
Test Item	Detection Bandwidth (802.11ac-VHT20 mode - 5500MHz)		

Radar Frequency (MHz)	DFS Detection Trials (1=Detection, 0= No Detection)										Detection Rate (%)
	1	2	3	4	5	6	7	8	9	10	
5490 FL	1	1	1	1	1	1	1	1	1	1	100%
5495	1	1	1	1	1	1	1	1	1	1	100%
5500	1	1	1	1	1	1	1	1	1	1	100%
5505	1	1	1	1	1	1	1	1	1	1	100%
5510 FH	1	1	1	1	1	1	1	1	1	1	100%

Note 1: All NII channels for this device have identical Channel bandwidths. Therefore, all DFS testing was done at 5500MHz. The 99% channel bandwidth is 17.53MHz. (See the 99% BW section of the RF report for further measurement details).

Note 2: Detection Bandwidth = FH - FL = 5510MHz – 5490MHz = 20MHz

Note 3: NII Detection Bandwidth Min. Limit (MHz): 17.53MHz x 100% = 17.53MHz.

Test Site	SIP-TR2	Test Engineer	Alisa Deng
Test Date	2022/04/10		
Test Item	Detection Bandwidth (802.11ac-VHT40 mode - 5510MHz)		

Radar Frequency (MHz)	DFS Detection Trials (1=Detection, 0= No Detection)										Detection Rate (%)
	1	2	3	4	5	6	7	8	9	10	
5490 FL	1	1	1	1	1	1	1	1	1	1	100%
5495	1	1	1	1	1	1	1	1	1	1	100%
5500	1	1	1	1	1	1	1	1	1	1	100%
5505	1	1	1	1	1	1	1	1	1	1	100%
5510	1	1	1	1	1	1	1	1	1	1	100%
5515	1	1	1	1	1	1	1	1	1	1	100%
5520	1	1	1	1	1	1	1	1	1	1	100%
5525	1	1	1	1	1	1	1	1	1	1	100%
5530 FH	1	1	1	1	1	1	1	1	1	1	100%

Note 1: All NII channels for this device have identical Channel bandwidths. Therefore, all DFS testing was done at 5510MHz. The 99% channel bandwidth is 35.914MHz. (See the 99% BW section of the RF report for further measurement details).

Note 2: Detection Bandwidth = FH - FL = 5530MHz - 5490MHz = 40MHz.

Note 3: NII Detection Bandwidth Min. Limit (MHz): 35.914MHz x 100% = 35.914MHz.

Test Site	SIP-TR2	Test Engineer	Alisa Deng
Test Date	2022/04/10		
Test Item	Detection Bandwidth (802.11ac-VHT80 mode - 5530MHz)		

Radar Frequency (MHz)	DFS Detection Trials (1=Detection, 0= No Detection)										Detection Rate (%)
	1	2	3	4	5	6	7	8	9	10	
5490 FL	1	1	1	1	1	1	1	1	1	1	100%
5495	1	1	1	1	1	1	1	1	1	1	100%
5500	1	1	1	1	1	1	1	1	1	1	100%
5505	1	1	1	1	1	1	1	1	1	1	100%
5510	1	1	1	1	1	1	1	1	1	1	100%
5515	1	1	1	1	1	1	1	1	1	1	100%
5520	1	1	1	1	1	1	1	1	1	1	100%
5525	1	1	1	1	1	1	1	1	1	1	100%
5530	1	1	1	1	1	1	1	1	1	1	100%
5535	1	1	1	1	1	1	1	1	1	1	100%
5540	1	1	1	1	1	1	1	1	1	1	100%
5545	1	1	1	1	1	1	1	1	1	1	100%
5550	1	1	1	1	1	1	1	1	1	1	100%
5555	1	1	1	1	1	1	1	1	1	1	100%
5560	1	1	1	1	1	1	1	1	1	1	100%
5565	1	1	1	1	1	1	1	1	1	1	100%
5570 FH	1	1	1	1	1	1	1	1	1	1	100%

Note 1: All NII channels for this device have identical Channel bandwidths. Therefore, all DFS testing was done at 5530MHz. The 99% channel bandwidth is 75.156MHz. (See the 99% BW section of the RF report for further measurement details).

Note 2: Detection Bandwidth = FH - FL = 5570MHz - 5490MHz = 80MHz.

Note 3: NII Detection Bandwidth Min. Limit (MHz): 75.156MHz x 100% = 75.156MHz.

A.4 Initial Channel Availability Check Time Test Result

Test Site	SIP-TR2	Test Engineer	Alisa Deng
Test Date	2022/03/27		
Test Item	Initial Channel Availability Check Time (802.11ac-VHT20 mode - 5500MHz)		

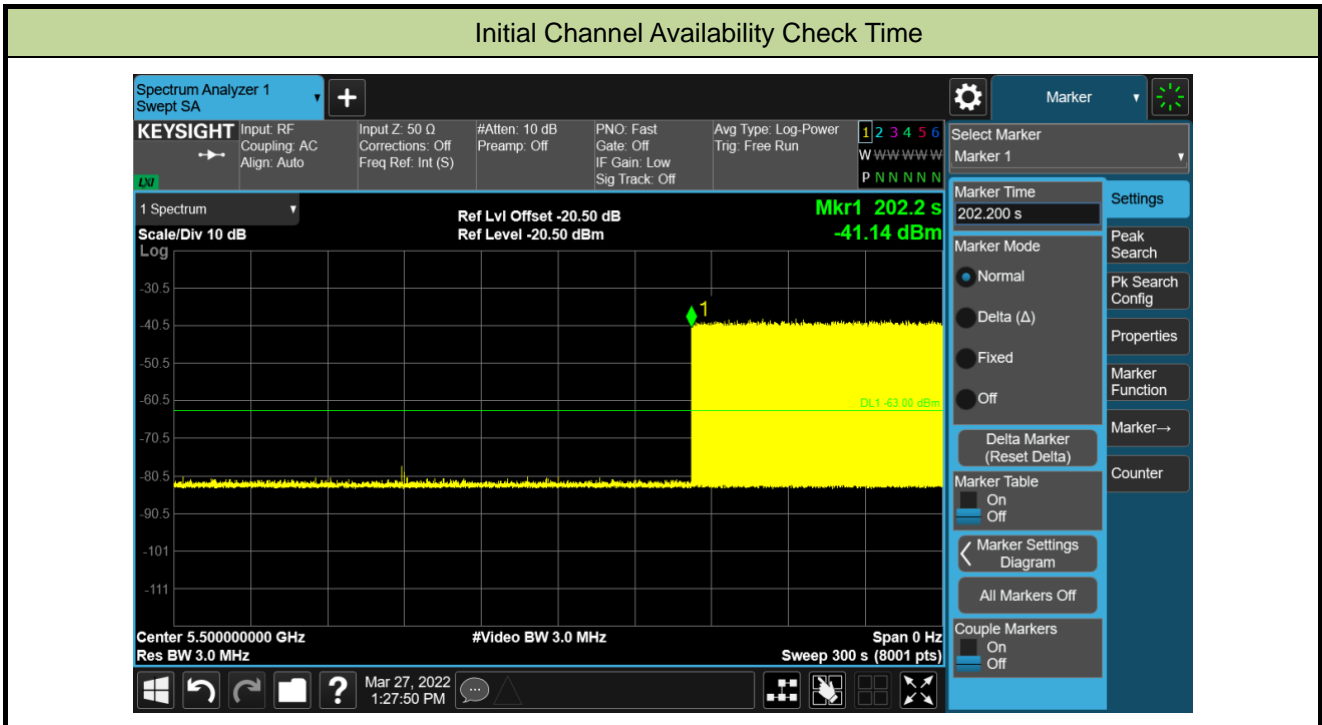

Note: The EUT does not transmit any beacon or data transmissions until at least 1 minute after the completion of the power-on cycle (142.2 sec). Initial beacons/data transmissions are indicated by marker 1 (202.2 sec).

A.5 Radar Burst at the Beginning of the Channel Availability Check Time Test Result

Test Site	SIP-TR2	Test Engineer	Alisa Deng
Test Date	2022/03/27		
Test Item	Beginning of the Channel Availability Check Time (802.11ac-VHT20 mode - 5500MHz)		

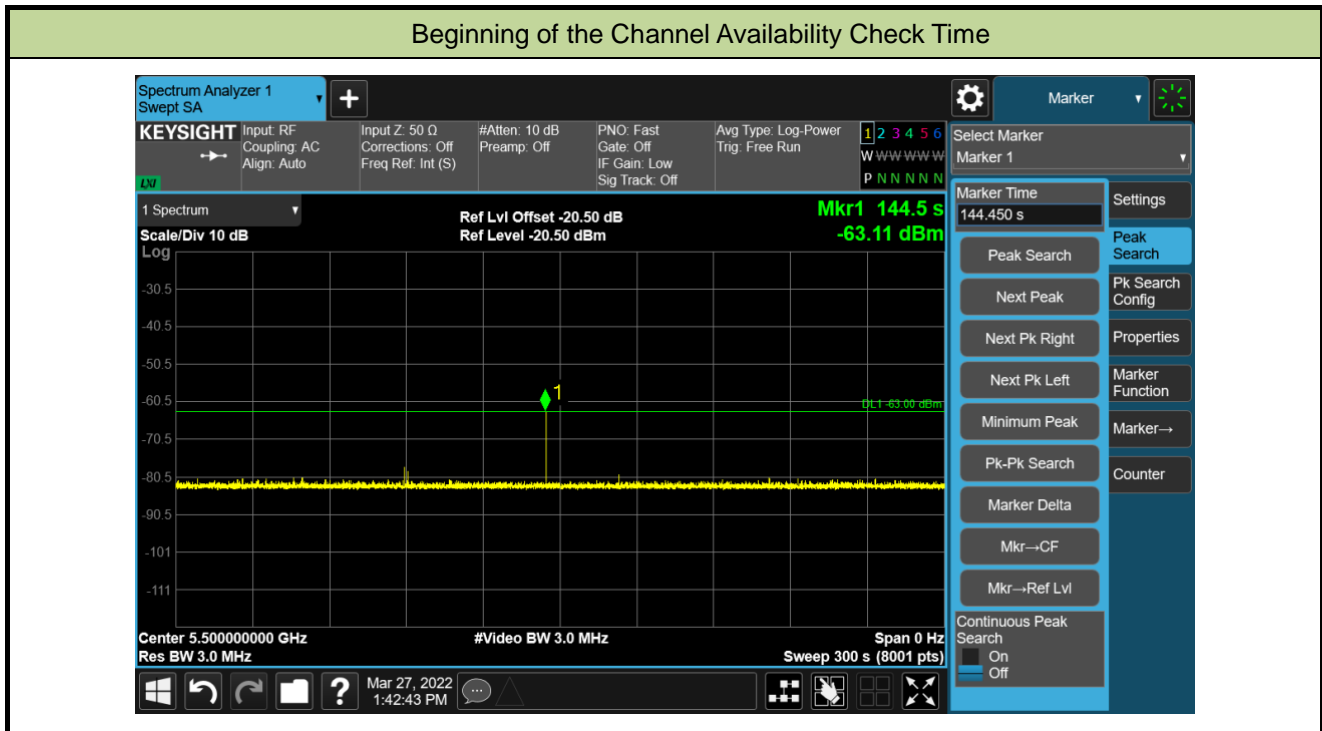

A.6 Radar Burst at the End of the Channel Availability Check Time Test Result

Test Site	SIP-TR2	Test Engineer	Alisa Deng
Test Date	2022/03/27		
Test Item	End of the Channel Availability Check Time (802.11ac-VHT20 mode - 5500MHz)		

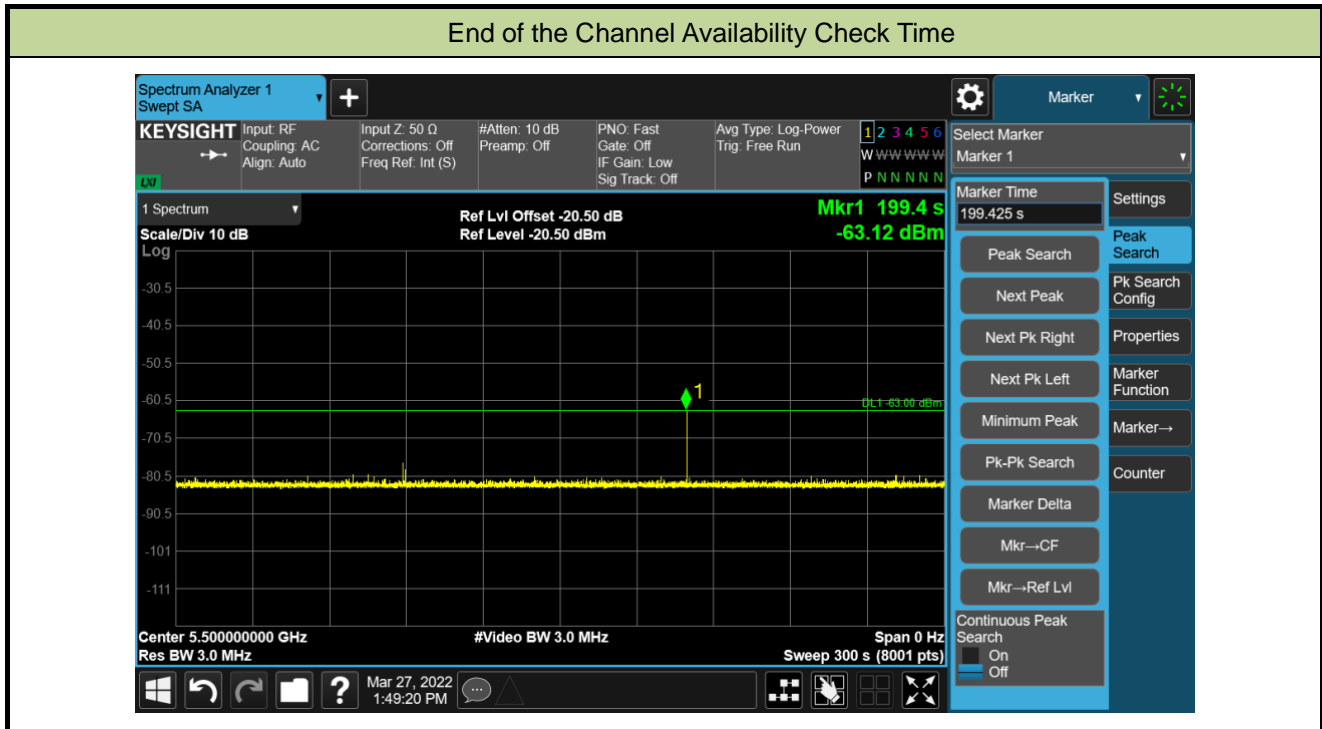

A.7 In-Service Monitoring for Channel Move Time, Channel Closing Transmission Time and Non-Occupancy Period Test Result

Test Site	SIP-TR2	Test Engineer	Alisa Deng
Test Date	2022/03/27		
Test Item	Channel Move Time and Channel Closing Transmission Time (802.11ac-VHT80 mode - 5530MHz)		

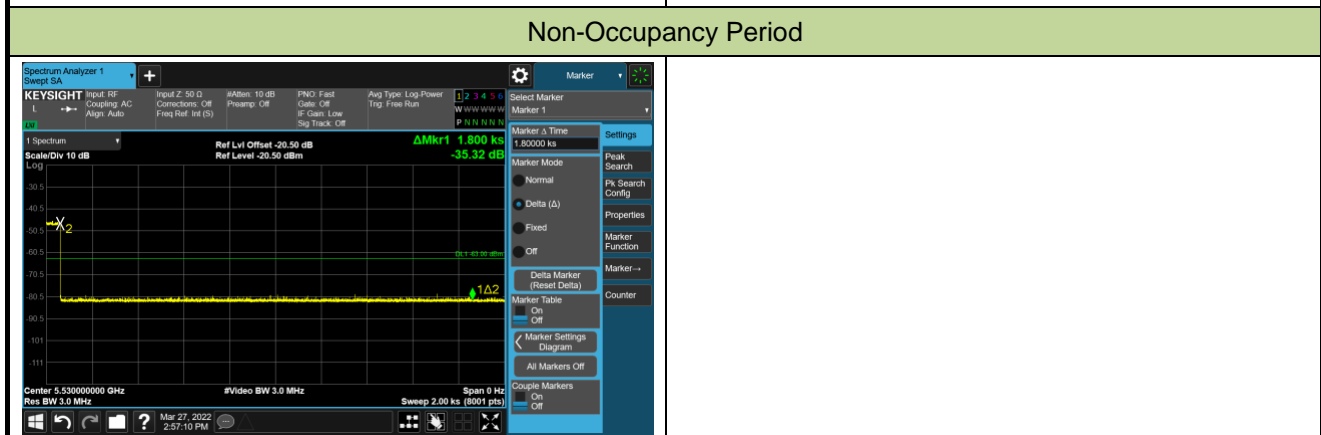
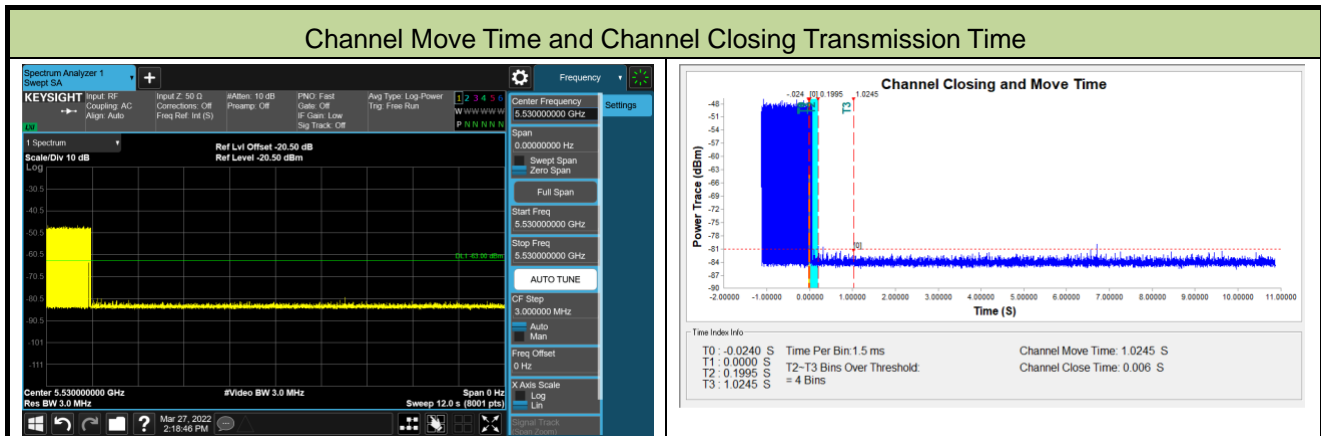

Parameter	Test Result	Limit
Channel Move Time (s)	1.0245s	<10s
Channel Closing Transmission Time (ms) (Note)	6ms	< 60ms
Non-Occupancy Period (min)	≥ 30min	≥ 30 min

Note: The Channel Closing Transmission Time is comprised of 200 milliseconds starting at the beginning of the Channel Move Time plus any additional intermittent control signals required to facilitate a Channel move (an aggregate of 60 milliseconds) during the remainder of the 10 seconds period. The aggregate duration of control signals will not count quiet periods in between transmissions.

A.8 Statistical Performance Check

Test Site	SIP-TR2	Test Engineer	Alisa Deng
Test Date	2022/04/10		
Test Item	Radar Statistical Performance Check (802.11ac-VHT20 – 5500MHz)		

Radar Type 1-4 - Radar Statistical Performance								
Trial	Radar Type 1		Radar Type 2		Radar Type 3		Radar Type 4	
	Frequency (MHz)	1=detect 0=no detect	Frequency (MHz)	1=detect 0=no detect	Frequency (MHz)	1=detect 0=no detect	Frequency (MHz)	1=detect 0=no detect
0	5500	0	5497	1	5503	1	5490	0
1	5503	1	5494	1	5510	1	5495	1
2	5494	1	5503	1	5497	1	5501	1
3	5492	1	5495	1	5491	0	5504	1
4	5504	1	5500	1	5502	0	5503	1
5	5500	1	5491	1	5509	1	5503	0
6	5490	1	5501	1	5492	1	5498	0
7	5507	1	5509	0	5495	1	5507	1
8	5510	1	5499	1	5502	1	5495	0
9	5494	1	5500	1	5492	0	5509	1
10	5504	1	5503	1	5495	1	5506	1
11	5508	1	5501	1	5493	1	5509	1
12	5498	0	5498	0	5499	1	5499	1
13	5495	1	5504	1	5509	1	5495	0
14	5499	1	5490	1	5496	1	5509	1
15	5503	1	5498	1	5503	1	5491	1
16	5506	1	5499	1	5492	1	5494	0
17	5505	1	5497	1	5505	1	5501	0
18	5509	1	5503	1	5504	1	5490	1
19	5510	1	5502	1	5500	1	5504	1
20	5492	1	5503	0	5491	1	5510	1
21	5490	1	5506	1	5504	0	5494	1
22	5501	1	5507	1	5505	1	5503	1
23	5505	1	5510	1	5505	1	5504	1
24	5494	1	5491	0	5498	0	5496	1
25	5499	1	5494	1	5490	0	5501	1
26	5506	1	5498	1	5506	1	5503	1
27	5499	1	5508	1	5500	0	5506	1
28	5508	1	5504	1	5503	1	5497	0

29	5496	1	5504	0	5490	1	5510	1
Probability:	93.3%		83.3%		76.7%		73.3%	
Aggregate:	$P_{Aggregate}=(P_1+P_2+P_3+P_4)/4=(93.3\%+83.3\%+76.7\%+73.3\%)/4=81.65\% (>80\%)$							

Radar Type 1 - Radar Waveform							Radar Type 2 - Radar Waveform						
Trial List							Trial List						
Download	Trial Id	Radar Type	Pulse Width (us)	PRI (us)	Number of Pulses	Waveform Length (us)	Download	Trial Id	Radar Type	Pulse Width (us)	PRI (us)	Number of Pulses	Waveform Length (us)
Download	0	Type 1	1.0	678.0	78	52884.0	Download	0	Type 2	2.8	164.0	26	4264.0
Download	1	Type 1	1.0	858.0	62	53196.0	Download	1	Type 2	3.9	160.0	27	4320.0
Download	2	Type 1	1.0	738.0	72	53136.0	Download	2	Type 2	4.8	215.0	29	6235.0
Download	3	Type 1	1.0	878.0	61	53558.0	Download	3	Type 2	4.1	202.0	28	5656.0
Download	4	Type 1	1.0	938.0	57	53466.0	Download	4	Type 2	3.5	203.0	27	5481.0
Download	5	Type 1	1.0	918.0	58	53244.0	Download	5	Type 2	3.7	154.0	27	4158.0
Download	6	Type 1	1.0	538.0	99	53262.0	Download	6	Type 2	1.1	230.0	23	5290.0
Download	7	Type 1	1.0	618.0	86	53148.0	Download	7	Type 2	4.2	204.0	28	5712.0
Download	8	Type 1	1.0	798.0	67	53466.0	Download	8	Type 2	1.0	166.0	23	3818.0
Download	9	Type 1	1.0	898.0	59	52982.0	Download	9	Type 2	2.7	169.0	25	4225.0
Download	10	Type 1	1.0	518.0	102	52836.0	Download	10	Type 2	4.5	190.0	29	5510.0
Download	11	Type 1	1.0	718.0	74	53132.0	Download	11	Type 2	4.4	195.0	28	5460.0
Download	12	Type 1	1.0	3066.0	18	55188.0	Download	12	Type 2	2.8	185.0	26	4810.0
Download	13	Type 1	1.0	588.0	89	53222.0	Download	13	Type 2	3.0	181.0	26	4706.0
Download	14	Type 1	1.0	838.0	63	52794.0	Download	14	Type 2	1.0	218.0	23	5014.0
Download	15	Type 1	1.0	2846.0	19	54074.0	Download	15	Type 2	3.5	173.0	27	4671.0
Download	16	Type 1	1.0	562.0	94	52828.0	Download	16	Type 2	1.1	227.0	23	5221.0
Download	17	Type 1	1.0	1335.0	40	53400.0	Download	17	Type 2	2.5	193.0	25	4825.0
Download	18	Type 1	1.0	1748.0	31	54188.0	Download	18	Type 2	2.4	205.0	25	5125.0
Download	19	Type 1	1.0	3047.0	18	54846.0	Download	19	Type 2	5.0	208.0	29	6032.0
Download	20	Type 1	1.0	850.0	63	53550.0	Download	20	Type 2	2.5	152.0	25	3800.0
Download	21	Type 1	1.0	2404.0	22	52888.0	Download	21	Type 2	4.9	210.0	29	6090.0
Download	22	Type 1	1.0	1611.0	33	53163.0	Download	22	Type 2	4.5	211.0	29	6119.0
Download	23	Type 1	1.0	2904.0	19	55176.0	Download	23	Type 2	1.5	158.0	23	3634.0
Download	24	Type 1	1.0	2736.0	20	54720.0	Download	24	Type 2	3.7	179.0	27	4833.0
Download	25	Type 1	1.0	3044.0	18	54792.0	Download	25	Type 2	3.9	199.0	27	5373.0
Download	26	Type 1	1.0	1604.0	33	52932.0	Download	26	Type 2	3.9	222.0	28	6216.0
Download	27	Type 1	1.0	2695.0	20	53900.0	Download	27	Type 2	1.6	171.0	24	4104.0
Download	28	Type 1	1.0	2004.0	27	54108.0	Download	28	Type 2	2.6	225.0	25	5625.0
Download	29	Type 1	1.0	2642.0	20	52840.0	Download	29	Type 2	4.5	216.0	29	6264.0

Radar Type 3 - Radar Waveform							Radar Type 4 - Radar Waveform						
Trial List							Trial List						
	Trial Id	Radar Type	Pulse Width (us)	PRI (us)	Number of Pulses	Waveform Length (us)		Trial Id	Radar Type	Pulse Width (us)	PRI (us)	Number of Pulses	Waveform Length (us)
Download	0	Type 3	7.8	333.0	17	5661.0	Download	0	Type 4	15.1	333.0	14	4662.0
Download	1	Type 3	8.9	349.0	18	6282.0	Download	1	Type 4	17.4	349.0	15	5235.0
Download	2	Type 3	9.8	228.0	18	4104.0	Download	2	Type 4	19.6	228.0	16	3648.0
Download	3	Type 3	9.1	256.0	18	4608.0	Download	3	Type 4	18.0	256.0	15	3840.0
Download	4	Type 3	8.5	402.0	17	6834.0	Download	4	Type 4	16.5	402.0	15	6030.0
Download	5	Type 3	8.7	340.0	17	5780.0	Download	5	Type 4	17.0	340.0	15	5100.0
Download	6	Type 3	6.1	392.0	16	6272.0	Download	6	Type 4	11.2	392.0	12	4704.0
Download	7	Type 3	9.2	383.0	18	6894.0	Download	7	Type 4	18.1	383.0	15	5745.0
Download	8	Type 3	6.0	460.0	16	7360.0	Download	8	Type 4	11.1	460.0	12	5520.0
Download	9	Type 3	7.7	336.0	17	5712.0	Download	9	Type 4	14.7	336.0	14	4704.0
Download	10	Type 3	9.5	381.0	18	6858.0	Download	10	Type 4	18.8	381.0	16	6096.0
Download	11	Type 3	9.4	306.0	18	5508.0	Download	11	Type 4	18.5	306.0	16	4896.0
Download	12	Type 3	7.8	210.0	17	3570.0	Download	12	Type 4	15.1	210.0	14	2940.0
Download	13	Type 3	8.0	222.0	17	3774.0	Download	13	Type 4	15.5	222.0	14	3108.0
Download	14	Type 3	6.0	480.0	16	7680.0	Download	14	Type 4	11.0	480.0	12	5760.0
Download	15	Type 3	8.5	358.0	17	6086.0	Download	15	Type 4	16.5	358.0	15	5370.0
Download	16	Type 3	6.1	470.0	16	7520.0	Download	16	Type 4	11.2	470.0	12	5640.0
Download	17	Type 3	7.5	465.0	17	7905.0	Download	17	Type 4	14.3	465.0	13	6045.0
Download	18	Type 3	7.4	217.0	17	3689.0	Download	18	Type 4	14.2	217.0	13	2821.0
Download	19	Type 3	10.0	278.0	18	5004.0	Download	19	Type 4	19.8	278.0	16	4448.0
Download	20	Type 3	7.5	407.0	17	6919.0	Download	20	Type 4	14.5	407.0	13	5291.0
Download	21	Type 3	9.9	281.0	18	5058.0	Download	21	Type 4	19.8	281.0	16	4496.0
Download	22	Type 3	9.5	226.0	18	4068.0	Download	22	Type 4	18.9	226.0	16	3616.0
Download	23	Type 3	6.5	297.0	16	4752.0	Download	23	Type 4	12.2	297.0	12	3564.0
Download	24	Type 3	8.7	406.0	17	6902.0	Download	24	Type 4	16.9	406.0	15	6090.0
Download	25	Type 3	8.9	235.0	18	4230.0	Download	25	Type 4	17.4	235.0	15	3525.0
Download	26	Type 3	8.9	479.0	18	8622.0	Download	26	Type 4	17.5	479.0	15	7185.0
Download	27	Type 3	6.6	401.0	16	6416.0	Download	27	Type 4	12.3	401.0	12	4812.0
Download	28	Type 3	7.6	219.0	17	3723.0	Download	28	Type 4	14.6	219.0	14	3066.0
Download	29	Type 3	9.5	354.0	18	6372.0	Download	29	Type 4	18.9	354.0	16	5664.0



Radar Type 5 - Radar Statistical Performance					
Trail #	Test Freq. (MHz)	1=Detection 0=No Detection	Trail #	Test Freq. (MHz)	1=Detection 0=No Detection
0	5500	1	15	5497	1
1	5500	1	16	5493	0
2	5500	1	17	5495	1
3	5500	1	18	5495	1
4	5500	1	19	5499	1
5	5500	1	20	5505	1
6	5500	1	21	5501	1
7	5500	1	22	5502	1
8	5500	0	23	5506	0
9	5500	1	24	5503	1
10	5498	1	25	5503	1
11	5498	1	26	5503	1
12	5496	1	27	5506	0
13	5496	1	28	5505	1
14	5493	0	29	5502	1
Detection Percentage (%)			83.3%		

Type 5 Radar Waveform_0										
Download	0	Type 5	13	0.9230769	12.0000000	5.500000000				
		Burst ID	Burst Offset (us)	Pulse Width (us)	Chirp Width (MHz)	Number of Pulses per Burst	PRI-1 (us)	PRI-2 (us)	PRI-3 (us)	
		0	644105.0	72.8	12	2	1089.0	1169.0	-	
		1	865014.0	85.5	12	3	1476.0	1358.0	1992.0	
		2	169540.0	97.5	12	3	1112.0	1742.0	1581.0	
		3	392549.0	88.7	12	3	1216.0	1568.0	1160.0	
		4	615845.0	80.6	12	2	1475.0	1906.0	-	
		5	839990.0	83.2	12	2	1152.0	1034.0	-	
		6	142624.0	51.2	12	1	1022.0	-	-	
		7	364785.0	89.3	12	3	1368.0	1722.0	1623.0	
		8	589498.0	51.0	12	1	1617.0	-	-	
		9	811564.0	70.8	12	2	2000.0	1223.0	-	
		10	114631.0	93.1	12	3	1751.0	1199.0	1656.0	
		11	337387.0	91.6	12	3	1453.0	1829.0	1329.0	
		12	560765.0	72.8	12	2	1830.0	1763.0	-	

Type 5 Radar Waveform_1

Download	1	Type 5	17	0.7058824	12.0000000	5.500000000				
		Burst ID	Burst Offset (us)	Pulse Width (us)	Chirp Width (MHz)	Number of Pulses per Burst	PRI-1 (us)	PRI-2 (us)	PRI-3 (us)	
		0	599783.0	75.1	16	2	1180.0	1063.0	-	
		1	66838.0	50.0	16	1	1817.0	-	-	
		2	237079.0	80.8	16	2	1747.0	1603.0	-	
		3	408420.0	51.6	16	1	1704.0	-	-	
		4	578645.0	68.4	16	2	1033.0	1352.0	-	
		5	45703.0	67.7	16	2	1657.0	1723.0	-	
		6	215589.0	98.9	16	3	1898.0	1472.0	1613.0	
		7	387194.0	69.5	16	2	1010.0	1038.0	-	
		8	555677.0	98.5	16	3	1113.0	1819.0	1916.0	
		9	24683.0	93.7	16	3	1240.0	1904.0	1171.0	
		10	195662.0	57.1	16	1	1338.0	-	-	
		11	365865.0	83.0	16	2	1511.0	1119.0	-	
		12	534815.0	85.7	16	3	1673.0	1910.0	1159.0	
		13	3723.0	86.2	16	3	1589.0	1914.0	1166.0	
		14	174636.0	57.3	16	1	1252.0	-	-	
		15	344822.0	70.0	16	2	1641.0	1058.0	-	
		16	513873.0	93.6	16	3	1982.0	1412.0	1342.0	

Type 5 Radar Waveform_2

Download	2	Type 5	20	0.6000000	12.0000000	5.500000000				
		Burst ID	Burst Offset (us)	Pulse Width (us)	Chirp Width (MHz)	Number of Pulses per Burst	PRI-1 (us)	PRI-2 (us)	PRI-3 (us)	
		0	582244.0	79.8	20	2	1407.0	1686.0	-	
		1	130437.0	62.9	20	1	1573.0	-	-	
		2	275567.0	56.7	20	1	1588.0	-	-	
		3	418675.0	83.5	20	3	1219.0	1896.0	1355.0	
		4	565679.0	53.9	20	1	1753.0	-	-	
		5	112641.0	54.9	20	1	1138.0	-	-	
		6	256430.0	84.8	20	3	1811.0	1161.0	1543.0	
		7	400592.0	84.4	20	3	1636.0	1678.0	1590.0	
		8	544739.0	84.6	20	3	1861.0	1262.0	1980.0	
		9	94426.0	71.0	20	2	1306.0	1881.0	-	
		10	238804.0	84.9	20	3	1183.0	1047.0	1876.0	
		11	382865.0	83.8	20	3	1016.0	1998.0	1810.0	
		12	530029.0	50.6	20	1	1646.0	-	-	
		13	76503.0	90.0	20	3	1084.0	1808.0	1030.0	
		14	221071.0	87.0	20	3	1024.0	1665.0	1230.0	
		15	367071.0	65.7	20	1	1586.0	-	-	
		16	511930.0	60.5	20	1	1907.0	-	-	
		17	58930.0	55.0	20	1	1534.0	-	-	
		18	203216.0	99.4	20	3	1205.0	1444.0	1409.0	
		19	347636.0	89.2	20	3	1621.0	1535.0	1099.0	

Type 5 Radar Waveform_3

Download	3	Type 5	18	0.6666667	12.0000000	5.500000000				
		Burst ID	Burst Offset (us)	Pulse Width (us)	Chirp Width (MHz)	Number of Pulses per Burst	PRI-1 (us)	PRI-2 (us)	PRI-3 (us)	
		0	549676.0	54.3	17	1	1251.0	-	-	
		1	45858.0	63.6	17	1	1046.0	-	-	
		2	206709.0	73.4	17	2	1278.0	1000.0	-	
		3	367291.0	77.7	17	2	1304.0	1973.0	-	
		4	529651.0	64.5	17	1	1434.0	-	-	
		5	25704.0	74.4	17	2	1036.0	1781.0	-	
		6	186096.0	91.9	17	3	1503.0	1526.0	1967.0	
		7	346617.0	90.4	17	3	1860.0	1339.0	1711.0	
		8	509597.0	55.7	17	1	1669.0	-	-	
		9	5859.0	95.0	17	3	1585.0	1519.0	1224.0	
		10	166336.0	97.0	17	3	1938.0	1345.0	1685.0	
		11	327211.0	93.9	17	3	1580.0	1057.0	1536.0	
		12	489185.0	69.2	17	2	1150.0	1260.0	-	
		13	650785.0	57.4	17	1	1903.0	-	-	
		14	146384.0	91.1	17	3	1950.0	1878.0	1972.0	
		15	308062.0	80.1	17	2	1720.0	1070.0	-	
		16	467721.0	84.8	17	3	1782.0	1609.0	1312.0	
		17	628391.0	89.3	17	3	1447.0	1990.0	1137.0	

Type 5 Radar Waveform_4

Download	4	Type 5	15	0.8000000	12.0000000	5.500000000				
		Burst ID	Burst Offset (us)	Pulse Width (us)	Chirp Width (MHz)	Number of Pulses per Burst	PRI-1 (us)	PRI-2 (us)	PRI-3 (us)	
		0	152871.0	71.1	14	2	1060.0	1193.0	-	
		1	344891.0	95.1	14	3	1929.0	1984.0	1700.0	
		2	537817.0	96.0	14	3	1954.0	1952.0	1320.0	
		3	732393.0	67.2	14	2	1718.0	1529.0	-	
		4	128780.0	83.9	14	3	1307.0	1064.0	1484.0	
		5	321745.0	96.7	14	3	1874.0	1151.0	1139.0	
		6	516470.0	63.9	14	1	1521.0	-	-	
		7	706746.0	85.7	14	3	1602.0	1831.0	1890.0	
		8	104854.0	97.8	14	3	1505.0	1531.0	1894.0	
		9	299102.0	53.6	14	1	1140.0	-	-	
		10	492125.0	70.1	14	2	1229.0	1088.0	-	
		11	685607.0	67.3	14	2	1087.0	1209.0	-	
		12	81269.0	75.1	14	2	1538.0	1745.0	-	
		13	274690.0	81.2	14	2	1653.0	1075.0	-	
		14	468815.0	58.0	14	1	1431.0	-	-	

Type 5 Radar Waveform_5

Download	5	Type 5	16	0.7500000	12.0000000	5.500000000				
		Burst ID	Burst Offset (us)	Pulse Width (us)	Chirp Width (MHz)	Number of Pulses per Burst	PRI-1 (us)	PRI-2 (us)	PRI-3 (us)	
		0	619700.0	80.9	15	2	1452.0	1561.0	-	
		1	53790.0	89.2	15	3	1204.0	1630.0	1443.0	
		2	235473.0	66.1	15	1	1666.0	-	-	
		3	414999.0	89.5	15	3	1999.0	1651.0	1549.0	
		4	597619.0	79.1	15	2	1102.0	1618.0	-	
		5	31582.0	68.9	15	2	1380.0	1231.0	-	
		6	212768.0	79.6	15	2	1853.0	1039.0	-	
		7	394576.0	63.1	15	1	1732.0	-	-	
		8	574303.0	94.5	15	3	1059.0	1065.0	1683.0	
		9	9249.0	78.6	15	2	1220.0	1857.0	-	
		10	189910.0	89.6	15	3	1221.0	1841.0	1942.0	
		11	371511.0	74.1	15	2	1962.0	1201.0	-	
		12	551978.0	91.0	15	3	1182.0	1092.0	1787.0	
		13	734935.0	64.6	15	1	1981.0	-	-	
		14	167799.0	93.3	15	3	1494.0	1071.0	1794.0	
		15	348331.0	99.0	15	3	1682.0	1471.0	1867.0	

Type 5 Radar Waveform_6

Download	6	Type 5	8	1.5000000	12.0000000	5.500000000				
		Burst ID	Burst Offset (us)	Pulse Width (us)	Chirp Width (MHz)	Number of Pulses per Burst	PRI-1 (us)	PRI-2 (us)	PRI-3 (us)	
		0	1064019.0	56.8	5	1	1596.0	-	-	
		1	1426096.0	80.9	5	2	1604.0	1393.0	-	
		2	292117.0	71.2	5	2	1749.0	1483.0	-	
		3	654352.0	83.9	5	3	1779.0	1532.0	1698.0	
		4	1019358.0	54.2	5	1	1446.0	-	-	
		5	1380862.0	93.2	5	3	1142.0	1389.0	1020.0	
		6	247087.0	87.2	5	3	1812.0	1415.0	1911.0	
		7	610196.0	79.8	5	2	1924.0	1847.0	-	

Type 5 Radar Waveform_7

Download	7	Type 5	18	0.6666667	12.0000000	5.500000000				
		Burst ID	Burst Offset (us)	Pulse Width (us)	Chirp Width (MHz)	Number of Pulses per Burst	PRI-1 (us)	PRI-2 (us)	PRI-3 (us)	
		0	431661.0	76.7	17	2	1640.0	1295.0	-	
		1	594359.0	63.7	17	1	1006.0	-	-	
		2	89930.0	78.9	17	2	1086.0	1482.0	-	
		3	250888.0	76.6	17	2	1571.0	1279.0	-	
		4	410939.0	88.2	17	3	1145.0	1986.0	1243.0	
		5	573111.0	70.2	17	2	1118.0	1466.0	-	
		6	69860.0	88.5	17	3	1421.0	1424.0	1905.0	
		7	231039.0	69.8	17	2	1002.0	1901.0	-	
		8	392765.0	65.8	17	1	1645.0	-	-	
		9	551596.0	85.8	17	3	1170.0	1696.0	1727.0	
		10	50098.0	88.3	17	3	1514.0	1267.0	1815.0	
		11	211377.0	68.2	17	2	1100.0	1277.0	-	
		12	372008.0	74.9	17	2	1273.0	1960.0	-	
		13	532114.0	90.7	17	3	1562.0	1663.0	1001.0	
		14	30478.0	55.7	17	1	1127.0	-	-	
		15	191406.0	70.4	17	2	1697.0	1116.0	-	
		16	351535.0	91.5	17	3	1497.0	1554.0	1413.0	
		17	513261.0	81.9	17	2	1569.0	1445.0	-	

Type 5 Radar Waveform_8

Download	8	Type 5	8	1.5000000	12.0000000	5.500000000				
		Burst ID	Burst Offset (us)	Pulse Width (us)	Chirp Width (MHz)	Number of Pulses per Burst	PRI-1 (us)	PRI-2 (us)	PRI-3 (us)	
		0	23854.0	51.5	5	1	1563.0	-	-	
		1	388520.0	88.6	5	3	1608.0	1019.0	1845.0	
		2	749142.0	94.3	5	3	1994.0	1652.0	1008.0	
		3	1113558.0	72.6	5	2	1124.0	1179.0	-	
		4	1476963.0	73.0	5	2	1121.0	1014.0	-	
		5	342068.0	71.0	5	2	1805.0	1680.0	-	
		6	705854.0	54.5	5	1	1715.0	-	-	
		7	1069120.0	54.6	5	1	1877.0	-	-	

Type 5 Radar Waveform_9

Download	9	Type 5	13	0.9230769	12.0000000	5.500000000				
		Burst ID	Burst Offset (us)	Pulse Width (us)	Chirp Width (MHz)	Number of Pulses per Burst	PRI-1 (us)	PRI-2 (us)	PRI-3 (us)	
		0	880776.0	63.2	11	1	1928.0	-	-	
		1	182492.0	86.4	11	3	1395.0	1314.0	1947.0	
		2	406738.0	53.9	11	1	1256.0	-	-	
		3	627842.0	97.3	11	3	1401.0	1792.0	1671.0	
		4	853693.0	53.8	11	1	1457.0	-	-	
		5	154972.0	87.8	11	3	1430.0	1912.0	1804.0	
		6	379193.0	52.0	11	1	1271.0	-	-	
		7	600292.0	86.4	11	3	1995.0	1731.0	1319.0	
		8	828502.0	62.7	11	1	1076.0	-	-	
		9	128020.0	65.3	11	1	1761.0	-	-	
		10	350191.0	90.0	11	3	1939.0	1376.0	1793.0	
		11	575343.0	53.0	11	1	1077.0	-	-	
		12	797778.0	74.9	11	2	1284.0	1153.0	-	

Type 5 Radar Waveform_10

Download	10	Type 5	19	0.6315789	12.0000000	5.498000000				
		Burst ID	Burst Offset (us)	Pulse Width (us)	Chirp Width (MHz)	Number of Pulses per Burst	PRI-1 (us)	PRI-2 (us)	PRI-3 (us)	
		0	88681.0	74.2	18	2	1210.0	1642.0	-	
		1	220705.0	90.2	18	3	1143.0	1181.0	1559.0	
		2	373962.0	69.8	18	2	1041.0	1123.0	-	
		3	527241.0	58.2	18	1	1416.0	-	-	
		4	49925.0	55.1	18	1	1250.0	-	-	
		5	201973.0	76.3	18	2	1949.0	1870.0	-	
		6	354511.0	75.0	18	2	1360.0	1951.0	-	
		7	507582.0	74.1	18	2	1396.0	1052.0	-	
		8	31080.0	66.2	18	1	1552.0	-	-	
		9	183577.0	75.1	18	2	1237.0	1356.0	-	
		10	336452.0	50.8	18	1	1983.0	-	-	
		11	487115.0	92.5	18	3	1649.0	1490.0	1462.0	
		12	12245.0	72.3	18	2	1178.0	1040.0	-	
		13	164511.0	91.6	18	3	1021.0	1451.0	1173.0	
		14	316645.0	98.6	18	3	1550.0	1177.0	1234.0	
		15	468484.0	85.5	18	3	1507.0	1852.0	1108.0	
		16	623780.0	54.1	18	1	1232.0	-	-	
		17	145598.0	90.7	18	3	1163.0	1280.0	1866.0	
		18	298993.0	57.9	18	1	1648.0	-	-	

Type 5 Radar Waveform_11

Download	11	Type 5	18	0.666667	12.000000	5.49800000				
		Burst ID	Burst Offset (us)	Pulse Width (us)	Chirp Width (MHz)	Number of Pulses per Burst	PRI-1 (us)	PRI-2 (us)	PRI-3 (us)	
		0	475441.0	72.0	18	2	1965.0	1767.0	-	
		1	635471.0	83.6	18	3	1714.0	1587.0	1215.0	
		2	134490.0	56.9	18	1	1661.0	-	-	
		3	296006.0	52.0	18	1	1141.0	-	-	
		4	456845.0	65.8	18	1	1974.0	-	-	
		5	616728.0	68.5	18	2	1766.0	1634.0	-	
		6	114479.0	82.0	18	2	1300.0	1198.0	-	
		7	276128.0	50.5	18	1	1132.0	-	-	
		8	436970.0	66.2	18	1	2000.0	-	-	
		9	596383.0	88.5	18	3	1548.0	1375.0	1066.0	
		10	94606.0	77.9	18	2	1594.0	1126.0	-	
		11	255263.0	90.4	18	3	1184.0	1258.0	1241.0	
		12	416565.0	80.4	18	2	1293.0	1582.0	-	
		13	575561.0	88.5	18	3	1762.0	1777.0	1628.0	
		14	74927.0	57.0	18	1	1336.0	-	-	
		15	235539.0	77.4	18	2	1991.0	1461.0	-	
		16	395489.0	98.5	18	3	1557.0	1575.0	1826.0	
		17	558061.0	74.4	18	2	1131.0	1344.0	-	

Type 5 Radar Waveform_12

Download	12	Type 5	13	0.9230769	12.000000	5.49600000				
		Burst ID	Burst Offset (us)	Pulse Width (us)	Chirp Width (MHz)	Number of Pulses per Burst	PRI-1 (us)	PRI-2 (us)	PRI-3 (us)	
		0	76279.0	64.3	12	1	1185.0	-	-	
		1	299186.0	67.8	12	2	1290.0	1987.0	-	
		2	521477.0	94.7	12	3	1744.0	1025.0	1899.0	
		3	745462.0	79.6	12	2	1217.0	1918.0	-	
		4	48685.0	80.6	12	2	1120.0	1062.0	-	
		5	271087.0	97.1	12	3	1959.0	1814.0	1605.0	
		6	495907.0	61.3	12	1	1197.0	-	-	
		7	719340.0	53.1	12	1	1391.0	-	-	
		8	21188.0	54.8	12	1	1551.0	-	-	
		9	244421.0	81.5	12	2	1311.0	1244.0	-	
		10	467184.0	96.2	12	3	1301.0	1098.0	1125.0	
		11	691567.0	53.5	12	1	1709.0	-	-	
		12	915272.0	50.9	12	1	1463.0	-	-	

Type 5 Radar Waveform_13

Download	13	Type 5	14	0.8571429	12.000000	5.49600000				
		Burst ID	Burst Offset (us)	Pulse Width (us)	Chirp Width (MHz)	Number of Pulses per Burst	PRI-1 (us)	PRI-2 (us)	PRI-3 (us)	
		0	201742.0	58.6	13	1	1035.0	-	-	
		1	408710.0	74.7	13	2	1353.0	1073.0	-	
		2	615404.0	82.1	13	2	1276.0	1985.0	-	
		3	823409.0	81.1	13	2	1028.0	1286.0	-	
		4	175442.0	91.4	13	3	1439.0	1774.0	1341.0	
		5	383075.0	67.2	13	2	1495.0	1155.0	-	
		6	589472.0	88.1	13	3	1564.0	1265.0	1043.0	
		7	798924.0	53.9	13	1	1187.0	-	-	
		8	149946.0	89.8	13	3	1206.0	1788.0	1706.0	
		9	357263.0	73.2	13	2	1619.0	1712.0	-	
		10	564509.0	75.7	13	2	1743.0	1331.0	-	
		11	772637.0	58.8	13	1	1979.0	-	-	
		12	124392.0	85.6	13	3	1659.0	1679.0	1964.0	
		13	330934.0	88.4	13	3	1886.0	1650.0	1909.0	

Type 5 Radar Waveform_14

Download	14	Type 5	8	1.500000	12.000000	5.49300000				
		Burst ID	Burst Offset (us)	Pulse Width (us)	Chirp Width (MHz)	Number of Pulses per Burst	PRI-1 (us)	PRI-2 (us)	PRI-3 (us)	
		0	943933.0	84.7	5	3	1577.0	1164.0	1539.0	
		1	1307743.0	70.4	5	2	1746.0	1332.0	-	
		2	174056.0	54.0	5	1	1489.0	-	-	
		3	537615.0	65.3	5	1	1146.0	-	-	
		4	900747.0	64.2	5	1	1789.0	-	-	
		5	1264050.0	50.0	5	1	1862.0	-	-	
		6	129324.0	61.0	5	1	1082.0	-	-	
		7	491459.0	89.8	5	3	1567.0	1948.0	1825.0	

Type 5 Radar Waveform_15

Download	15	Type 5	15	0.8000000	12.0000000	5.497000000				
		Burst ID	Burst Offset (us)	Pulse Width (us)	Chirp Width (MHz)	Number of Pulses per Burst	PRI-1 (us)	PRI-2 (us)	PRI-3 (us)	
		0	455402.0	72.9	14	2	1639.0	1287.0	-	
		1	649506.0	63.2	14	1	1957.0	-	-	
		2	44867.0	92.5	14	3	1626.0	1684.0	1227.0	
		3	238615.0	53.0	14	1	1786.0	-	-	
		4	432430.0	59.9	14	1	1374.0	-	-	
		5	623922.0	90.8	14	3	1689.0	1468.0	1023.0	
		6	21193.0	62.7	14	1	1165.0	-	-	
		7	214798.0	63.7	14	1	1676.0	-	-	
		8	408331.0	50.5	14	1	1843.0	-	-	
		9	602360.0	54.4	14	1	1245.0	-	-	
		10	796153.0	62.6	14	1	1176.0	-	-	
		11	190234.0	87.6	14	3	1485.0	1798.0	1383.0	
		12	363932.0	69.2	14	2	1597.0	1397.0	-	
		13	577995.0	65.7	14	1	1940.0	-	-	
		14	769650.0	96.3	14	3	1078.0	1270.0	1556.0	

Type 5 Radar Waveform_16

Download	16	Type 5	8	1.5000000	12.0000000	5.493000000				
		Burst ID	Burst Offset (us)	Pulse Width (us)	Chirp Width (MHz)	Number of Pulses per Burst	PRI-1 (us)	PRI-2 (us)	PRI-3 (us)	
		0	313619.0	57.3	5	1	1670.0	-	-	
		1	676925.0	65.6	5	1	1859.0	-	-	
		2	1040511.0	60.1	5	1	1515.0	-	-	
		3	1404219.0	60.3	5	1	1218.0	-	-	
		4	268585.0	70.5	5	2	1426.0	1759.0	-	
		5	631661.0	74.6	5	2	1919.0	1144.0	-	
		6	993961.0	94.7	5	3	1865.0	1303.0	1032.0	
		7	1357440.0	69.0	5	2	1795.0	1632.0	-	

Type 5 Radar Waveform_17

Download	17	Type 5	12	1.0000000	12.0000000	5.495000000				
		Burst ID	Burst Offset (us)	Pulse Width (us)	Chirp Width (MHz)	Number of Pulses per Burst	PRI-1 (us)	PRI-2 (us)	PRI-3 (us)	
		0	149142.0	70.8	10	2	1436.0	1384.0	-	
		1	390519.0	95.0	10	3	1067.0	1750.0	1202.0	
		2	633381.0	58.6	10	1	1963.0	-	-	
		3	875041.0	76.6	10	2	1027.0	1386.0	-	
		4	119273.0	82.7	10	2	1600.0	1679.0	-	
		5	361521.0	50.8	10	1	1933.0	-	-	
		6	603841.0	66.1	10	1	1506.0	-	-	
		7	844666.0	82.0	10	2	1835.0	1255.0	-	
		8	89680.0	53.5	10	1	1501.0	-	-	
		9	330863.0	89.9	10	3	1128.0	1915.0	1422.0	
		10	573019.0	68.8	10	2	1349.0	1685.0	-	
		11	815806.0	51.7	10	1	1961.0	-	-	

Type 5 Radar Waveform_18

Download	18	Type 5	12	1.0000000	12.0000000	5.495000000				
		Burst ID	Burst Offset (us)	Pulse Width (us)	Chirp Width (MHz)	Number of Pulses per Burst	PRI-1 (us)	PRI-2 (us)	PRI-3 (us)	
		0	59777.0	68.9	10	2	1042.0	1692.0	-	
		1	300836.0	88.7	10	3	1944.0	1627.0	1837.0	
		2	542413.0	88.4	10	3	1595.0	1268.0	1892.0	
		3	786472.0	57.2	10	1	1350.0	-	-	
		4	29909.0	97.4	10	3	1887.0	1418.0	1930.0	
		5	271382.0	91.3	10	3	1136.0	1856.0	1469.0	
		6	513552.0	76.0	10	2	1129.0	1932.0	-	
		7	755404.0	72.7	10	2	1875.0	1103.0	-	
		8	191.0	71.3	10	2	1797.0	1486.0	-	
		9	241678.0	96.2	10	3	1523.0	1327.0	1458.0	
		10	483046.0	96.1	10	3	1233.0	1540.0	1780.0	
		11	726064.0	69.1	10	2	1363.0	1004.0	-	

Type 5 Radar Waveform_19										
Download	19	Type 5	20	0.6000000	12.0000000	5.489000000				
		Burst ID	Burst Offset (us)	Pulse Width (us)	Chirp Width (MHz)	Number of Pulses per Burst	PRI-1 (us)	PRI-2 (us)	PRI-3 (us)	
		0	578922.0	69.0	20	2	1674.0	1685.0	-	
		1	127146.0	72.1	20	2	1596.0	1053.0	-	
		2	271050.0	96.7	20	3	1802.0	1556.0	1425.0	
		3	416145.0	99.7	20	3	1517.0	1095.0	1117.0	
		4	563240.0	54.0	20	1	1091.0	-	-	
		5	108887.0	89.8	20	3	1996.0	1574.0	1340.0	
		6	253577.0	90.6	20	3	1011.0	1689.0	1348.0	
		7	399957.0	65.2	20	1	1296.0	-	-	
		8	544276.0	78.3	20	2	1122.0	1147.0	-	
		9	91298.0	94.3	20	3	1009.0	1051.0	1616.0	
		10	236194.0	71.6	20	2	1610.0	1387.0	-	
		11	381797.0	58.0	20	1	1725.0	-	-	
		12	527181.0	51.2	20	1	1404.0	-	-	
		13	73780.0	64.1	20	1	1266.0	-	-	
		14	218405.0	80.1	20	2	1351.0	1520.0	-	
		15	363938.0	62.9	20	1	1703.0	-	-	
		16	506802.0	84.4	20	3	1454.0	1513.0	1370.0	
		17	55815.0	72.5	20	2	1061.0	1044.0	-	
		18	201067.0	59.1	20	1	1378.0	-	-	
		19	343971.0	97.7	20	3	1736.0	1734.0	1851.0	

Type 5 Radar Waveform_20										
Download	20	Type 5	13	0.9230769	12.0000000	5.505000000				
		Burst ID	Burst Offset (us)	Pulse Width (us)	Chirp Width (MHz)	Number of Pulses per Burst	PRI-1 (us)	PRI-2 (us)	PRI-3 (us)	
		0	756743.0	50.4	11	1	1283.0	-	-	
		1	58488.0	64.0	11	1	1687.0	-	-	
		2	281506.0	79.4	11	2	1195.0	1955.0	-	
		3	504286.0	68.7	11	2	1840.0	1913.0	-	
		4	727940.0	77.3	11	2	1510.0	1373.0	-	
		5	30963.0	52.8	11	1	1647.0	-	-	
		6	254540.0	62.9	11	1	1281.0	-	-	
		7	477249.0	79.3	11	2	1406.0	1525.0	-	
		8	696629.0	98.6	11	3	1863.0	1542.0	1869.0	
		9	3432.0	71.9	11	2	1432.0	1365.0	-	
		10	226156.0	97.7	11	3	1713.0	1096.0	1908.0	
		11	449763.0	74.6	11	2	1248.0	1677.0	-	
		12	671538.0	97.0	11	3	1402.0	1946.0	1479.0	

Type 5 Radar Waveform_21										
Download	21	Type 5	20	0.6000000	12.0000000	5.501000000				
		Burst ID	Burst Offset (us)	Pulse Width (us)	Chirp Width (MHz)	Number of Pulses per Burst	PRI-1 (us)	PRI-2 (us)	PRI-3 (us)	
		0	579967.0	89.6	20	3	1369.0	1809.0	1285.0	
		1	129612.0	57.6	20	1	1017.0	-	-	
		2	274607.0	60.5	20	1	1620.0	-	-	
		3	419768.0	54.2	20	1	1570.0	-	-	
		4	564795.0	66.4	20	1	1688.0	-	-	
		5	111329.0	77.9	20	2	1816.0	1282.0	-	
		6	256612.0	63.7	20	1	1897.0	-	-	
		7	399649.0	99.4	20	3	1796.0	1818.0	1294.0	
		8	547374.0	53.6	20	1	1192.0	-	-	
		9	93573.0	73.5	20	2	1298.0	1317.0	-	
		10	238487.0	74.7	20	2	1487.0	1055.0	-	
		11	383439.0	67.0	20	2	1222.0	1242.0	-	
		12	527896.0	80.3	20	2	1188.0	1801.0	-	
		13	75846.0	55.9	20	1	1675.0	-	-	
		14	220357.0	83.3	20	2	1478.0	1824.0	-	
		15	365991.0	61.1	20	1	1806.0	-	-	
		16	511104.0	63.1	20	1	1768.0	-	-	
		17	57666.0	86.3	20	3	1196.0	1868.0	1760.0	
		18	201947.0	98.8	20	3	1880.0	1323.0	1820.0	
		19	346339.0	87.1	20	3	1110.0	1769.0	1988.0	

Type 5 Radar Waveform_22										
Download	22	Type 5	19	0.6315789	12.0000000	5.502000000				
		Burst ID	Burst Offset (us)	Pulse Width (us)	Chirp Width (MHz)	Number of Pulses per Burst	PRI-1 (us)	PRI-2 (us)	PRI-3 (us)	
		0	519182.0	50.3	18	1	1873.0	-	-	
		1	42163.0	68.7	18	2	1175.0	1247.0	-	
		2	195036.0	55.0	18	1	1508.0	-	-	
		3	346356.0	92.8	18	3	1717.0	1186.0	1308.0	
		4	499495.0	77.9	18	2	1584.0	1390.0	-	
		5	23329.0	72.4	18	2	1705.0	1755.0	-	
		6	176089.0	51.1	18	1	1953.0	-	-	
		7	328264.0	76.8	18	2	1450.0	1516.0	-	
		8	482105.0	61.3	18	1	1158.0	-	-	
		9	4576.0	66.6	18	1	1739.0	-	-	
		10	157359.0	56.3	18	1	1631.0	-	-	
		11	308606.0	96.6	18	3	1545.0	1807.0	1398.0	
		12	460916.0	97.1	18	3	1726.0	1502.0	1135.0	
		13	615899.0	61.1	18	1	1433.0	-	-	
		14	138624.0	61.7	18	1	1249.0	-	-	
		15	291399.0	56.5	18	1	1465.0	-	-	
		16	443197.0	69.5	18	2	1162.0	1756.0	-	
		17	597111.0	58.6	18	1	1394.0	-	-	
		18	119411.0	67.9	18	2	1764.0	1496.0	-	

Type 5 Radar Waveform_23										
Download	23	Type 5	9	1.3333333	12.0000000	5.506000000				
		Burst ID	Burst Offset (us)	Pulse Width (us)	Chirp Width (MHz)	Number of Pulses per Burst	PRI-1 (us)	PRI-2 (us)	PRI-3 (us)	
		0	574817.0	94.6	7	3	1728.0	1437.0	1357.0	
		1	897051.0	95.4	7	3	1388.0	1624.0	1576.0	
		2	1219439.0	98.4	7	3	1773.0	1212.0	1467.0	
		3	212916.0	96.8	7	3	1664.0	1156.0	1236.0	
		4	535156.0	90.6	7	3	1931.0	1372.0	1130.0	
		5	859130.0	54.7	7	1	1839.0	-	-	
		6	1182302.0	51.7	7	1	1565.0	-	-	
		7	173079.0	97.1	7	3	1833.0	1361.0	1827.0	
		8	495380.0	96.9	7	3	1724.0	1546.0	1366.0	

Type 5 Radar Waveform_24										
Download	24	Type 5	16	0.7500000	12.0000000	5.503000000				
		Burst ID	Burst Offset (us)	Pulse Width (us)	Chirp Width (MHz)	Number of Pulses per Burst	PRI-1 (us)	PRI-2 (us)	PRI-3 (us)	
		0	460026.0	79.7	15	2	1085.0	1347.0	-	
		1	641497.0	68.1	15	2	1174.0	1066.0	-	
		2	74768.0	85.4	15	3	1770.0	1937.0	1784.0	
		3	255740.0	83.7	15	3	1442.0	1799.0	1069.0	
		4	436135.0	96.9	15	3	1660.0	1997.0	1435.0	
		5	617628.0	87.5	15	3	1328.0	1528.0	1235.0	
		6	52582.0	96.6	15	3	1758.0	1941.0	1007.0	
		7	233768.0	70.9	15	2	1633.0	1701.0	-	
		8	415937.0	52.5	15	1	1392.0	-	-	
		9	596088.0	67.8	15	2	1637.0	1522.0	-	
		10	30396.0	76.3	15	2	1213.0	1544.0	-	
		11	211176.0	94.1	15	3	1591.0	1752.0	1003.0	
		12	393182.0	76.7	15	2	1056.0	1079.0	-	
		13	573126.0	87.0	15	3	1629.0	1018.0	1359.0	
		14	8055.0	88.1	15	3	1614.0	1414.0	1299.0	
		15	188857.0	87.0	15	3	1134.0	1672.0	1707.0	

Type 5 Radar Waveform_25

Download	25	Type 5	17	0.7058824	12.0000000	5.503000000			
		Burst ID	Burst Offset (us)	Pulse Width (us)	Chirp Width (MHz)	Number of Pulses per Burst	PRI-1 (us)	PRI-2 (us)	PRI-3 (us)
		0	348355.0	67.1	16	2	1926.0	1438.0	-
		1	518499.0	78.1	16	2	1966.0	1721.0	-
		2	689512.0	70.0	16	2	1611.0	1354.0	-
		3	157156.0	69.1	16	2	1333.0	1263.0	-
		4	326994.0	94.3	16	3	1470.0	1272.0	1423.0
		5	497831.0	76.7	16	2	1871.0	1379.0	-
		6	666982.0	91.6	16	3	1480.0	1785.0	1310.0
		7	136454.0	54.4	16	1	1005.0	-	-
		8	306409.0	70.3	16	2	1693.0	1606.0	-
		9	478008.0	54.1	16	1	1530.0	-	-
		10	646484.0	91.8	16	3	1473.0	1499.0	1111.0
		11	115342.0	51.9	16	1	1337.0	-	-
		12	285362.0	71.9	16	2	1518.0	1922.0	-
		13	456921.0	64.5	16	1	1599.0	-	-
		14	624734.0	88.0	16	3	1923.0	1168.0	1872.0
		15	94084.0	76.1	16	2	1322.0	1583.0	-
		16	264570.0	75.3	16	2	1157.0	1771.0	-

Type 5 Radar Waveform_26

Download	26	Type 5	17	0.7058824	12.0000000	5.503000000			
		Burst ID	Burst Offset (us)	Pulse Width (us)	Chirp Width (MHz)	Number of Pulses per Burst	PRI-1 (us)	PRI-2 (us)	PRI-3 (us)
		0	436085.0	54.2	16	1	1269.0	-	-
		1	603607.0	97.2	16	3	1572.0	1772.0	1836.0
		2	72911.0	93.2	16	3	1417.0	1846.0	1302.0
		3	243597.0	81.2	16	2	1695.0	1194.0	-
		4	414133.0	72.7	16	2	1403.0	1399.0	-
		5	583580.0	97.7	16	3	1254.0	1429.0	1408.0
		6	52163.0	59.5	16	1	1822.0	-	-
		7	222871.0	64.5	16	1	1975.0	-	-
		8	392281.0	90.9	16	3	1449.0	1504.0	1364.0
		9	564449.0	53.9	16	1	1803.0	-	-
		10	31161.0	51.7	16	1	1105.0	-	-
		11	201509.0	82.4	16	2	1850.0	1288.0	-
		12	372429.0	73.9	16	2	1190.0	1037.0	-
		13	542259.0	67.8	16	2	1524.0	1776.0	-
		14	10098.0	58.4	16	1	1691.0	-	-
		15	180982.0	60.3	16	1	1318.0	-	-
		16	351901.0	59.8	16	1	1239.0	-	-

Type 5 Radar Waveform_27

Download	27	Type 5	9	1.3333333	12.0000000	5.506000000			
		Burst ID	Burst Offset (us)	Pulse Width (us)	Chirp Width (MHz)	Number of Pulses per Burst	PRI-1 (us)	PRI-2 (us)	PRI-3 (us)
		0	986720.0	73.4	7	2	1848.0	1555.0	-
		1	1309799.0	76.6	7	2	1172.0	1694.0	-
		2	301874.0	81.8	7	2	1615.0	1855.0	-
		3	624506.0	78.0	7	2	1969.0	1292.0	-
		4	948318.0	52.6	7	1	1537.0	-	-
		5	1271395.0	52.9	7	1	1459.0	-	-
		6	262098.0	76.5	7	2	1828.0	1882.0	-
		7	584867.0	80.9	7	2	1464.0	1579.0	-
		8	908432.0	63.3	7	1	1683.0	-	-

Type 5 Radar Waveform_28

Download	28	Type 5	13	0.9230769	12.0000000	5.505000000			
		Burst ID	Burst Offset (us)	Pulse Width (us)	Chirp Width (MHz)	Number of Pulses per Burst	PRI-1 (us)	PRI-2 (us)	PRI-3 (us)
		0	849421.0	94.7	11	3	1849.0	1440.0	1214.0
		1	153600.0	95.8	11	3	1821.0	1512.0	1346.0
		2	376557.0	94.6	11	3	1405.0	1456.0	1289.0
		3	599464.0	99.1	11	3	1029.0	1509.0	1553.0
		4	822342.0	88.1	11	3	1149.0	1800.0	1148.0
		5	126363.0	79.8	11	2	1313.0	1917.0	-
		6	350158.0	50.2	11	1	1377.0	-	-
		7	572772.0	68.8	11	2	1668.0	1200.0	-
		8	795507.0	72.5	11	2	1662.0	1719.0	-
		9	98723.0	89.9	11	3	1775.0	1735.0	1208.0
		10	321211.0	94.9	11	3	1488.0	1945.0	1978.0
		11	545833.0	55.7	11	1	1936.0	-	-
		12	766555.0	94.5	11	3	1813.0	1730.0	1607.0

Type 5 Radar Waveform_29										
Download	29	Type 5	19	0.6315789	12.0000000	5.502000000				
		Burst ID	Burst Offset (us)	Pulse Width (us)	Chirp Width (MHz)	Number of Pulses per Burst	PRI-1 (us)	PRI-2 (us)	PRI-3 (us)	
		0	46775.0	80.5	18	2	1601.0	1643.0	-	
		1	201573.0	80.4	18	1	1970.0	-	-	
		2	354758.0	54.5	18	1	1109.0	-	-	
		3	507124.0	53.3	18	1	1783.0	-	-	
		4	30043.0	72.7	18	2	1167.0	1253.0	-	
		5	182207.0	89.9	18	3	1225.0	1031.0	1635.0	
		6	334929.0	72.1	18	2	1746.0	1226.0	-	
		7	486044.0	96.5	18	3	1259.0	1612.0	1834.0	
		8	11206.0	86.3	18	3	1638.0	1382.0	1716.0	
		9	163195.0	83.4	18	3	1958.0	1012.0	1920.0	
		10	315673.0	91.7	18	3	1203.0	1385.0	1334.0	
		11	469725.0	82.0	18	1	1474.0	-	-	
		12	620867.0	91.1	18	3	1045.0	1013.0	1114.0	
		13	145176.0	61.3	18	1	1838.0	-	-	
		14	297128.0	94.4	18	3	1026.0	1050.0	1411.0	
		15	449111.0	97.4	18	3	1592.0	1335.0	1048.0	
		16	603503.0	51.5	18	1	1702.0	-	-	
		17	125758.0	94.2	18	3	1854.0	1107.0	1895.0	
		18	278985.0	66.7	18	2	1072.0	1015.0	-	

Radar Type 6 - Radar Statistical Performance			
Trail #	1=Detection 0=No Detection	Trail #	1=Detection 0=No Detection
0	1	15	1
1	1	16	1
2	1	17	1
3	1	18	1
4	1	19	1
5	1	20	1
6	1	21	1
7	1	22	1
8	1	23	1
9	1	24	1
10	1	25	1
11	1	26	1
12	1	27	1
13	1	28	1
14	1	29	1
Detection Percentage (%)		100.0%	

Type 6 Radar Waveform_0								
Download	0	Type 6	1.0	333.3	9	0.3333	300.000000	4
		Frequency List (MHz)	0	1	2	3	4	
		0	5624	5513	5554	5305	5628	
		5	5422	5470	5499	5407	5306	
		10	5485	5466	5478	5479	5420	
		15	5636	5661	5264	5720	5279	
		20	5649	5325	5596	5287	5386	
		25	5262	5389	5297	5321	5648	
		30	5476	5643	5274	5630	5599	
		35	5679	5398	5662	5269	5313	
		40	5498	5312	5416	5540	5647	
		45	5544	5388	5383	5434	5358	
		50	5586	5441	5412	5347	5322	
		55	5535	5683	5268	5589	5507	
		60	5428	5452	5433	5480	5259	
		65	5548	5551	5574	5304	5610	
		70	5424	5323	5403	5603	5587	
		75	5634	5365	5567	5353	5685	
		80	5688	5382	5578	5652	5655	
		85	5411	5343	5380	5584	5707	
		90	5296	5701	5283	5531	5446	
		95	5340	5465	5477	5570	5509	

Type 6 Radar Waveform_1

Download	1	Type 6	1.0	333.3	9	0.3333	300.0000000	2
		Frequency List (MHz)	0	1	2	3	4	
		0	5404	5277	5490	5466	5373	
		5	5464	5492	5574	5570	5513	
		10	5319	5255	5519	5674	5441	
		15	5724	5313	5367	5290	5658	
		20	5287	5718	5266	5685	5260	
		25	5652	5589	5592	5401	5355	
		30	5690	5462	5600	5489	5419	
		35	5343	5458	5422	5702	5337	
		40	5354	5683	5644	5473	5368	
		45	5395	5411	5317	5588	5398	
		50	5261	5530	5456	5543	5625	
		55	5423	5562	5645	5679	5380	
		60	5377	5520	5369	5253	5646	
		65	5634	5593	5681	5675	5573	
		70	5259	5252	5341	5526	5471	
		75	5256	5669	5564	5359	5408	
		80	5538	5283	5262	5547	5327	
		85	5655	5434	5351	5611	5346	
		90	5347	5587	5449	5632	5448	
		95	5660	5349	5267	5379	5499	

Type 6 Radar Waveform_2

Download	2	Type 6	1.0	333.3	9	0.3333	300.0000000	3
		Frequency List (MHz)	0	1	2	3	4	
		0	5659	5516	5426	5530	5690	
		5	5506	5514	5649	5258	5342	
		10	5250	5519	5560	5394	5462	
		15	5715	5440	5470	5335	5375	
		20	5673	5409	5682	5677	5708	
		25	5540	5538	5320	5602	5389	
		30	5354	5351	5557	5607	5556	
		35	5714	5385	5580	5254	5672	
		40	5616	5651	5575	5670	5448	
		45	5263	5305	5348	5549	5453	
		50	5464	5571	5289	5449	5500	
		55	5559	5474	5644	5400	5315	
		60	5444	5691	5624	5687	5678	
		65	5563	5570	5585	5466	5388	
		70	5484	5369	5262	5576	5317	
		75	5485	5593	5399	5650	5341	
		80	5505	5615	5306	5405	5283	
		85	5579	5604	5706	5301	5704	
		90	5598	5619	5627	5427	5288	
		95	5547	5720	5674	5697	5719	

Type 6 Radar Waveform_3

Download	3	Type 6	1.0	333.3	9	0.3333	300.0000000	4
		Frequency List (MHz)	0	1	2	3	4	
		0	5342	5280	5362	5691	5435	
		5	5645	5439	5724	5421	5549	
		10	5656	5308	5601	5492	5580	
		15	5328	5567	5573	5283	5681	
		20	5478	5720	5291	5331	5390	
		25	5523	5706	5326	5396	5715	
		30	5514	5347	5330	5437	5524	
		35	5671	5622	5350	5627	5490	
		40	5658	5608	5688	5260	5709	
		45	5632	5511	5517	5625	5447	
		50	5465	5500	5686	5382	5321	
		55	5357	5354	5505	5263	5268	
		60	5345	5666	5519	5509	5393	
		65	5626	5621	5676	5287	5441	
		70	5545	5293	5444	5409	5713	
		75	5542	5631	5593	5615	5572	
		80	5466	5402	5453	5661	5518	
		85	5570	5711	5569	5660	5455	
		90	5369	5544	5489	5707	5674	
		95	5525	5406	5391	5367	5718	

Type 6 Radar Waveform_4

Download	4	Type 6	1.0	333.3	9	0.3333	300.0000000	3
		Frequency List (MHz)	0	1	2	3	4	
		0	5597	5519	5298	5377	5277	
		5	5687	5461	5324	5584	5281	
		10	5490	5572	5264	5601	5416	
		15	5694	5579	5328	5284	5689	
		20	5644	5661	5283	5654	5717	
		25	5251	5335	5360	5438	5701	
		30	5471	5562	5482	5257	5663	
		35	5384	5418	5503	5541	5426	
		40	5363	5546	5453	5638	5308	
		45	5715	5472	5570	5415	5323	
		50	5641	5551	5300	5680	5265	
		55	5545	5695	5460	5714	5474	
		60	5665	5611	5448	5427	5455	
		65	5594	5575	5657	5508	5550	
		70	5468	5610	5628	5365	5652	
		75	5647	5403	5261	5568	5612	
		80	5273	5529	5302	5648	5564	
		85	5630	5331	5437	5614	5703	
		90	5567	5631	5578	5371	5719	
		95	5260	5254	5498	5423	5288	

Type 6 Radar Waveform_5

Download	5	Type 6	1.0	333.3	9	0.3333	300.0000000	5
		Frequency List (MHz)	0	1	2	3	4	
		0	5377	5283	5709	5538	5497	
		5	5254	5386	5399	5650	5585	
		10	5421	5458	5305	5407	5622	
		15	5504	5724	5682	5373	5476	
		20	5600	5713	5602	5372	5627	
		25	5582	5666	5357	5439	5394	
		30	5480	5590	5428	5302	5256	
		35	5455	5705	5475	5689	5278	
		40	5285	5446	5484	5596	5470	
		45	5288	5323	5530	5623	5674	
		50	5342	5389	5406	5587	5258	
		55	5262	5410	5279	5685	5506	
		60	5355	5556	5280	5350	5498	
		65	5417	5524	5718	5442	5271	
		70	5614	5465	5501	5362	5250	
		75	5381	5593	5525	5263	5433	
		80	5425	5592	5299	5564	5523	
		85	5402	5665	5387	5321	5467	
		90	5612	5631	5353	5277	5309	
		95	5579	5267	5597	5360	5722	

Type 6 Radar Waveform_6

Download	6	Type 6	1.0	333.3	9	0.3333	300.0000000	2
		Frequency List (MHz)	0	1	2	3	4	
		0	5632	5522	5645	5699	5339	
		5	5296	5408	5474	5338	5317	
		10	5255	5722	5346	5602	5643	
		15	5495	5376	5310	5418	5668	
		20	5608	5404	5543	5364	5600	
		25	5373	5518	5560	5640	5428	
		30	5619	5479	5385	5420	5275	
		35	5369	5566	5582	5431	5466	
		40	5579	5529	5422	5361	5251	
		45	5399	5646	5406	5588	5567	
		50	5453	5653	5478	5704	5531	
		55	5349	5691	5573	5656	5635	
		60	5520	5501	5587	5651	5444	
		65	5618	5473	5550	5712	5549	
		70	5279	5468	5350	5599	5321	
		75	5597	5302	5574	5689	5589	
		80	5277	5660	5467	5616	5270	
		85	5724	5585	5486	5513	5365	
		90	5294	5563	5694	5624	5700	
		95	5583	5572	5717	5253	5322	

Type 6 Radar Waveform_7

Download	7	Type 6	1.0	333.3	9	0.3333	300.0000000	5
		Frequency List (MHz)	0	1	2	3	4	
		0	5315	5286	5581	5385	5559	
		5	5435	5333	5549	5501	5524	
		10	5661	5511	5387	5322	5664	
		15	5583	5503	5413	5366	5616	
		20	5473	5453	5573	5261	5467	
		25	5288	5269	5462	5465	5342	
		30	5635	5657	5508	5378	5584	
		35	5380	5418	5612	5360	5601	
		40	5345	5706	5626	5489	5632	
		45	5454	5329	5694	5704	5527	
		50	5537	5645	5392	5530	5289	
		55	5685	5543	5419	5477	5390	
		60	5441	5422	5571	5285	5507	
		65	5352	5448	5586	5568	5674	
		70	5575	5280	5566	5621	5445	
		75	5555	5554	5386	5470	5656	
		80	5340	5293	5370	5458	5335	
		85	5710	5670	5497	5405	5651	
		90	5576	5395	5474	5311	5547	
		95	5592	5603	5328	5306	5526	

Type 6 Radar Waveform_8

Download	8	Type 6	1.0	333.3	9	0.3333	300.0000000	4
		Frequency List (MHz)	0	1	2	3	4	
		0	5570	5525	5517	5546	5401	
		5	5477	5355	5624	5664	5353	
		10	5592	5300	5428	5420	5685	
		15	5671	5630	5516	5411	5674	
		20	5527	5639	5522	5445	5319	
		25	5491	5373	5496	5703	5354	
		30	5299	5375	5334	5293	5647	
		35	5273	5649	5359	5294	5317	
		40	5298	5366	5342	5635	5606	
		45	5572	5607	5719	5680	5395	
		50	5280	5278	5350	5322	5250	
		55	5599	5408	5589	5501	5418	
		60	5488	5348	5400	5336	5642	
		65	5371	5399	5520	5669	5571	
		70	5426	5551	5714	5438	5266	
		75	5633	5331	5251	5345	5403	
		80	5290	5575	5370	5397	5676	
		85	5578	5648	5603	5341	5582	
		90	5655	5583	5425	5474	5628	
		95	5490	5485	5431	5504	5621	

Type 6 Radar Waveform_9

Download	9	Type 6	1.0	333.3	9	0.3333	300.0000000	4
		Frequency List (MHz)	0	1	2	3	4	
		0	5350	5289	5453	5707	5621	
		5	5519	5280	5699	5255	5560	
		10	5426	5564	5469	5615	5706	
		15	5284	5282	5522	5456	5391	
		20	5535	5708	5463	5534	5415	
		25	5646	5694	5477	5530	5367	
		30	5340	5256	5590	5583	5491	
		35	5689	5364	5445	5512	5305	
		40	5668	5400	5711	5509	5339	
		45	5586	5655	5665	5263	5606	
		50	5556	5571	5331	5551	5644	
		55	5438	5553	5598	5408	5472	
		60	5547	5540	5433	5701	5379	
		65	5465	5320	5643	5327	5669	
		70	5336	5574	5275	5527	5673	
		75	5407	5634	5614	5507	5466	
		80	5287	5392	5273	5714	5639	
		85	5622	5446	5675	5421	5423	
		90	5506	5588	5554	5537	5595	
		95	5442	5529	5612	5485	5464	

Type 6 Radar Waveform_10

Download	10	Type 6	1.0	333.3	9	0.3333	300.0000000	4
		Frequency List (MHz)	0	1	2	3	4	
		0	5605	5528	5389	5296	5463	
		5	5561	5302	5299	5418	5292	
		10	5357	5450	5510	5335	5252	
		15	5275	5312	5625	5404	5583	
		20	5543	5399	5501	5526	5492	
		25	5681	5595	5325	5581	5564	
		30	5409	5704	5686	5708	5311	
		35	5353	5552	5338	5665	5694	
		40	5507	5483	5274	5336	5396	
		45	5566	5263	5723	5316	5272	
		50	5382	5456	5374	5588	5626	
		55	5313	5702	5443	5676	5705	
		60	5475	5467	5527	5666	5269	
		65	5582	5634	5614	5286	5641	
		70	5674	5599	5406	5632	5279	
		75	5680	5619	5288	5673	5662	
		80	5587	5651	5556	5699	5339	
		85	5411	5629	5669	5621	5671	
		90	5594	5491	5322	5459	5584	
		95	5596	5383	5346	5637	5522	

Type 6 Radar Waveform_11

Download	11	Type 6	1.0	333.3	9	0.3333	300.0000000	4
		Frequency List (MHz)	0	1	2	3	4	
		0	5385	5389	5325	5457	5683	
		5	5700	5702	5374	5581	5596	
		10	5288	5714	5551	5530	5273	
		15	5363	5439	5253	5449	5300	
		20	5454	5565	5442	5615	5465	
		25	5569	5447	5528	5307	5598	
		30	5451	5593	5645	5448	5509	
		35	5606	5492	5643	5609	5440	
		40	5608	5346	5663	5490	5514	
		45	5333	5546	5684	5369	5283	
		50	5686	5433	5642	5672	5435	
		55	5339	5461	5503	5424	5317	
		60	5708	5395	5420	5319	5450	
		65	5271	5392	5693	5618	5356	
		70	5417	5455	5627	5677	5382	
		75	5591	5723	5529	5348	5576	
		80	5515	5254	5544	5265	5689	
		85	5659	5651	5495	5662	5434	
		90	5279	5680	5344	5361	5697	
		95	5525	5679	5338	5476	5639	

Type 6 Radar Waveform_12

Download	12	Type 6	1.0	333.3	9	0.3333	300.0000000	7
		Frequency List (MHz)	0	1	2	3	4	
		0	5543	5628	5261	5618	5525	
		5	5267	5724	5449	5269	5328	
		10	5597	5503	5689	5250	5294	
		15	5451	5566	5356	5494	5492	
		20	5462	5634	5383	5607	5438	
		25	5457	5396	5256	5411	5632	
		30	5590	5579	5602	5663	5283	
		35	5329	5534	5259	5405	5593	
		40	5619	5660	5271	5428	5657	
		45	5427	5526	5429	5325	5548	
		50	5562	5527	5484	5495	5379	
		55	5415	5693	5718	5288	5362	
		60	5560	5365	5626	5276	5314	
		65	5690	5642	5557	5676	5695	
		70	5710	5302	5675	5358	5550	
		75	5692	5649	5491	5292	5277	
		80	5656	5502	5554	5337	5722	
		85	5719	5639	5703	5464	5350	
		90	5493	5694	5661	5654	5682	
		95	5368	5540	5419	5348	5416	

Type 6 Radar Waveform_13

Download	13	Type 6	1.0	333.3	9	0.3333	300.0000000	4
		Frequency List (MHz)	0	1	2	3	4	
		0	5323	5392	5672	5304	5270	
		5	5309	5649	5427	5335	5535	
		10	5528	5292	5255	5348	5315	
		15	5539	5693	5459	5684	5470	
		20	5325	5421	5696	5411	5723	
		25	5515	5666	5632	5468	5559	
		30	5403	5435	5624	5673	5350	
		35	5298	5271	5533	5596	5354	
		40	5366	5422	5424	5561	5409	
		45	5512	5378	5438	5703	5345	
		50	5701	5618	5369	5408	5537	
		55	5259	5491	5250	5310	5555	
		60	5674	5260	5416	5591	5593	
		65	5518	5498	5305	5524	5334	
		70	5509	5564	5538	5544	5377	
		75	5581	5437	5653	5697	5457	
		80	5276	5685	5343	5587	5463	
		85	5362	5691	5709	5496	5346	
		90	5607	5274	5645	5552	5661	
		95	5374	5263	5631	5585	5569	

Type 6 Radar Waveform_14

Download	14	Type 6	1.0	333.3	9	0.3333	300.0000000	3
		Frequency List (MHz)	0	1	2	3	4	
		0	5578	5631	5608	5465	5587	
		5	5351	5671	5502	5498	5267	
		10	5362	5556	5296	5543	5336	
		15	5530	5345	5487	5401	5478	
		20	5394	5688	5384	5611	5575	
		25	5662	5619	5700	5674	5357	
		30	5516	5521	5684	5347	5337	
		35	5441	5569	5447	5435	5437	
		40	5304	5421	5490	5389	5595	
		45	5286	5431	5692	5404	5586	
		50	5434	5519	5645	5331	5701	
		55	5598	5356	5705	5620	5415	
		60	5352	5387	5500	5661	5714	
		65	5540	5629	5718	5313	5679	
		70	5293	5682	5405	5373	5310	
		75	5468	5533	5317	5680	5321	
		80	5282	5650	5514	5457	5593	
		85	5270	5438	5552	5639	5711	
		90	5657	5381	5715	5703	5568	
		95	5624	5329	5251	5450	5640	

Type 6 Radar Waveform_15

Download	15	Type 6	1.0	333.3	9	0.3333	300.0000000	2
		Frequency List (MHz)	0	1	2	3	4	
		0	5358	5395	5544	5626	5332	
		5	5490	5596	5577	5661	5571	
		10	5293	5442	5337	5263	5357	
		15	5618	5375	5568	5532	5593	
		20	5389	5560	5303	5302	5402	
		25	5524	5345	5259	5338	5343	
		30	5473	5261	5361	5642	5476	
		35	5629	5365	5674	5458	5274	
		40	5617	5717	5427	5418	5322	
		45	5369	5678	5344	5484	5587	
		50	5580	5637	5523	5342	5492	
		55	5519	5655	5691	5553	5579	
		60	5297	5694	5326	5627	5440	
		65	5489	5550	5680	5482	5462	
		70	5290	5408	5697	5286	5405	
		75	5437	5251	5500	5349	5563	
		80	5709	5360	5435	5708	5630	
		85	5420	5690	5387	5380	5546	
		90	5721	5467	5488	5641	5384	
		95	5710	5445	5522	5659	5575	

Type 6 Radar Waveform_16

Download	16	Type 6	1.0	333.3	9	0.3333	300.0000000	3
		Frequency List (MHz)	0	1	2	3	4	
		0	5516	5634	5480	5312	5649	
		5	5532	5618	5662	5349	5303	
		10	5699	5706	5378	5458	5502	
		15	5671	5577	5407	5397	5629	
		20	5341	5294	5330	5290	5376	
		25	5496	5449	5293	5380	5707	
		30	5430	5476	5610	5365	5518	
		35	5720	5636	5362	5372	5588	
		40	5700	5655	5570	5415	5251	
		45	5286	5402	5537	5377	5444	
		50	5281	5688	5709	5640	5436	
		55	5609	5406	5550	5306	5270	
		60	5717	5526	5724	5670	5263	
		65	5438	5604	5285	5475	5534	
		70	5276	5411	5546	5386	5374	
		75	5557	5394	5481	5253	5399	
		80	5513	5626	5547	5429	5250	
		85	5385	5644	5635	5675	5711	
		90	5501	5370	5689	5658	5439	
		95	5694	5343	5683	5479	5712	

Type 6 Radar Waveform_17

Download	17	Type 6	1.0	333.3	9	0.3333	300.0000000	4
		Frequency List (MHz)	0	1	2	3	4	
		0	5296	5398	5416	5376	5394	
		5	5574	5543	5252	5415	5510	
		10	5533	5495	5419	5653	5399	
		15	5319	5629	5299	5622	5599	
		20	5405	5320	5282	5383	5303	
		25	5556	5325	5699	5553	5327	
		30	5422	5596	5387	5691	5287	
		35	5660	5657	5336	5529	5602	
		40	5286	5524	5308	5496	5335	
		45	5412	5558	5329	5369	5363	
		50	5590	5264	5698	5457	5323	
		55	5463	5283	5420	5563	5666	
		60	5521	5435	5662	5358	5550	
		65	5616	5464	5640	5592	5270	
		70	5606	5262	5511	5298	5723	
		75	5721	5677	5440	5559	5505	
		80	5623	5655	5311	5544	5624	
		85	5263	5256	5442	5253	5598	
		90	5408	5401	5355	5438	5630	
		95	5297	5494	5678	5716	5710	

Type 6 Radar Waveform_18

Download	18	Type 6	1.0	333.3	9	0.3333	300.0000000	2
		Frequency List (MHz)	0	1	2	3	4	
		0	5551	5637	5352	5537	5711	
		5	5713	5565	5327	5578	5339	
		10	5464	5284	5460	5276	5420	
		15	5310	5281	5402	5570	5316	
		20	5389	5698	5375	5444	5652	
		25	5427	5657	5361	5582	5344	
		30	5334	5536	5480	5321	5325	
		35	5280	5297	5363	5391	5434	
		40	5575	5506	5487	5309	5452	
		45	5421	5643	5529	5574	5633	
		50	5315	5412	5664	5702	5608	
		55	5517	5311	5485	5492	5564	
		60	5600	5704	5287	5376	5562	
		65	5665	5336	5579	5366	5300	
		70	5723	5514	5622	5592	5682	
		75	5690	5700	5583	5540	5282	
		80	5258	5436	5374	5541	5641	
		85	5533	5694	5634	5693	5649	
		90	5656	5566	5472	5512	5335	
		95	5314	5549	5614	5362	5414	

Type 6 Radar Waveform_19

Download	19	Type 6	1.0	333.3	9	0.3333	300.0000000	4
		Frequency List (MHz)	0	1	2	3	4	
		0	5331	5401	5288	5698	5456	
		5	5280	5490	5402	5266	5546	
		10	5395	5548	5501	5471	5441	
		15	5398	5408	5615	5508	5324	
		20	5555	5261	5464	5724	5332	
		25	5504	5630	5383	5603	5301	
		30	5549	5688	5678	5363	5518	
		35	5596	5433	5686	5677	5571	
		40	5372	5340	5503	5416	5667	
		45	5535	5479	5599	5450	5334	
		50	5366	5487	5699	5682	5693	
		55	5290	5649	5594	5299	5605	
		60	5488	5285	5634	5432	5644	
		65	5614	5568	5641	5562	5345	
		70	5251	5521	5534	5368	5692	
		75	5437	5538	5636	5544	5472	
		80	5279	5254	5561	5429	5367	
		85	5409	5394	5444	5604	5268	
		90	5512	5719	5517	5695	5425	
		95	5478	5664	5684	5462	5519	

Type 6 Radar Waveform_20

Download	20	Type 6	1.0	333.3	9	0.3333	300.0000000	5
		Frequency List (MHz)	0	1	2	3	4	
		0	5586	5640	5699	5384	5298	
		5	5322	5512	5477	5429	5278	
		10	5704	5434	5639	5666	5482	
		15	5486	5438	5511	5660	5700	
		20	5332	5624	5677	5456	5697	
		25	5598	5453	5261	5487	5645	
		30	5457	5258	5289	5498	5502	
		35	5706	5489	5683	5600	5516	
		40	5654	5310	5483	5500	5723	
		45	5647	5618	5440	5652	5681	
		50	5326	5510	5417	5687	5493	
		55	5412	5425	5691	5501	5337	
		60	5347	5455	5594	5426	5551	
		65	5689	5709	5554	5369	5324	
		70	5350	5541	5317	5617	5320	
		75	5544	5531	5465	5297	5381	
		80	5473	5597	5356	5314	5717	
		85	5446	5526	5711	5470	5443	
		90	5348	5659	5252	5410	5698	
		95	5620	5418	5520	5690	5550	

Type 6 Radar Waveform_21

Download	21	Type 6	1.0	333.3	9	0.3333	300.0000000	6
		Frequency List (MHz)	0	1	2	3	4	
		0	5269	5404	5635	5545	5518	
		5	5364	5437	5552	5495	5582	
		10	5698	5680	5386	5483	5574	
		15	5565	5614	5608	5417	5718	
		20	5315	5618	5670	5486	5305	
		25	5464	5591	5463	5687	5346	
		30	5690	5504	5696	5641	5322	
		35	5285	5361	5611	5355	5262	
		40	5723	5497	5652	5627	5701	
		45	5498	5705	5568	5580	5686	
		50	5468	5301	5340	5600	5379	
		55	5406	5320	5308	5620	5539	
		60	5258	5523	5512	5658	5590	
		65	5676	5594	5628	5613	5303	
		70	5717	5547	5520	5559	5500	
		75	5585	5440	5466	5491	5254	
		80	5286	5660	5435	5551	5447	
		85	5631	5302	5541	5394	5450	
		90	5434	5489	5476	5380	5536	
		95	5462	5617	5333	5405	5616	

Type 6 Radar Waveform_22

Download	22	Type 6	1.0	333.3	9	0.3333	300.0000000	5
		Frequency List (MHz)	0	1	2	3	4	
		0	5524	5643	5571	5706	5380	
		5	5503	5459	5627	5658	5314	
		10	5566	5487	5721	5581	5504	
		15	5565	5692	5717	5653	5609	
		20	5251	5481	5559	5634	5277	
		25	5254	5667	5695	5400	5351	
		30	5710	5647	5622	5388	5516	
		35	5305	5413	5556	5514	5525	
		40	5291	5442	5661	5488	5494	
		45	5484	5607	5309	5283	5358	
		50	5456	5387	5519	5390	5334	
		55	5284	5313	5333	5499	5517	
		60	5279	5508	5310	5662	5349	
		65	5443	5713	5626	5411	5486	
		70	5431	5307	5289	5720	5396	
		75	5399	5518	5372	5705	5464	
		80	5718	5601	5510	5450	5723	
		85	5432	5271	5350	5570	5265	
		90	5258	5359	5659	5698	5654	
		95	5482	5414	5321	5674	5479	

Type 6 Radar Waveform_23

Download	23	Type 6	1.0	333.3	9	0.3333	300.0000000	6
		Frequency List (MHz)	0	1	2	3	4	
		0	5304	5407	5507	5392	5580	
		5	5545	5384	5702	5346	5521	
		10	5400	5276	5287	5679	5525	
		15	5653	5344	5345	5698	5326	
		20	5259	5550	5597	5626	5616	
		25	5640	5581	5395	5421	5434	
		30	5393	5696	5604	5362	5540	
		35	5714	5347	5504	5352	5667	
		40	5439	5605	5599	5631	5588	
		45	5413	5587	5517	5336	5720	
		50	5332	5563	5570	5479	5632	
		55	5606	5501	5689	5628	5637	
		60	5475	5526	5494	5650	5486	
		65	5536	5556	5565	5718	5281	
		70	5709	5379	5372	5375	5477	
		75	5341	5253	5629	5445	5495	
		80	5614	5291	5311	5429	5350	
		85	5412	5325	5450	5613	5374	
		90	5452	5488	5448	5678	5686	
		95	5496	5252	5301	5676	5538	

Type 6 Radar Waveform_24

Download	24	Type 6	1.0	333.3	9	0.3333	300.0000000	3
		Frequency List (MHz)	0	1	2	3	4	
		0	5559	5646	5443	5456	5422	
		5	5587	5406	5302	5509	5350	
		10	5331	5540	5328	5399	5546	
		15	5266	5471	5351	5268	5615	
		20	5645	5716	5538	5715	5589	
		25	5431	5433	5598	5525	5468	
		30	5435	5585	5561	5577	5314	
		35	5534	5486	5595	5720	5442	
		40	5450	5444	5608	5537	5396	
		45	5342	5567	5475	5575	5389	
		50	5510	5683	5264	5621	5665	
		55	5455	5550	5689	5404	5630	
		60	5599	5291	5640	5326	5573	
		65	5432	5262	5505	5601	5453	
		70	5551	5512	5548	5358	5348	
		75	5569	5436	5688	5373	5675	
		80	5426	5272	5724	5547	5681	
		85	5283	5253	5288	5545	5667	
		90	5664	5622	5650	5494	5385	
		95	5560	5320	5513	5307	5382	

Type 6 Radar Waveform_25

Download	25	Type 6	1.0	333.3	9	0.3333	300.0000000	3
		Frequency List (MHz)	0	1	2	3	4	
		0	5717	5410	5379	5617	5642	
		5	5629	5331	5377	5672	5557	
		10	5640	5329	5369	5594	5567	
		15	5354	5501	5454	5691	5332	
		20	5653	5310	5479	5707	5562	
		25	5319	5382	5704	5502	5574	
		30	5474	5518	5317	5466	5625	
		35	5686	5516	5595	5364	5283	
		40	5378	5636	5582	5649	5450	
		45	5558	5633	5345	5397	5462	
		50	5440	5279	5278	5402	5670	
		55	5449	5570	5420	5330	5513	
		60	5399	5463	5551	5540	5285	
		65	5443	5693	5620	5344	5351	
		70	5418	5327	5395	5657	5493	
		75	5343	5407	5524	5359	5328	
		80	5370	5534	5423	5478	5631	
		85	5668	5348	5262	5535	5618	
		90	5470	5674	5597	5419	5429	
		95	5530	5362	5366	5472	5660	

Type 6 Radar Waveform_26

Download	26	Type 6	1.0	333.3	9	0.3333	300.0000000	5
		Frequency List (MHz)	0	1	2	3	4	
		0	5497	5271	5315	5303	5484	
		5	5293	5353	5452	5263	5289	
		10	5571	5690	5410	5314	5588	
		15	5442	5628	5557	5261	5524	
		20	5661	5476	5517	5321	5535	
		25	5682	5709	5432	5258	5536	
		30	5616	5460	5475	5435	5715	
		35	5552	5667	5399	5312	5273	
		40	5278	5694	5396	5316	5401	
		45	5579	5578	5430	5641	5594	
		50	5398	5662	5338	5723	5368	
		55	5479	5341	5493	5527	5309	
		60	5646	5444	5549	5495	5458	
		65	5465	5700	5421	5286	5500	
		70	5576	5713	5496	5692	5427	
		75	5451	5645	5354	5529	5613	
		80	5389	5485	5679	5372	5584	
		85	5534	5597	5323	5673	5631	
		90	5510	5311	5357	5669	5643	
		95	5668	5364	5603	5356	5702	

Type 6 Radar Waveform_27

Download	27	Type 6	1.0	333.3	9	0.3333	300.0000000	6
		Frequency List (MHz)	0	1	2	3	4	
		0	5277	5510	5251	5464	5704	
		5	5335	5278	5527	5426	5593	
		10	5502	5479	5451	5509	5609	
		15	5433	5280	5660	5306	5716	
		20	5572	5545	5458	5313	5508	
		25	5473	5658	5635	5459	5570	
		30	5349	5432	5650	5392	5372	
		35	5331	5490	5680	5523	5289	
		40	5533	5254	5544	5576	5410	
		45	5724	5652	5549	5689	5317	
		50	5299	5457	5302	5663	5681	
		55	5481	5499	5465	5415	5581	
		60	5403	5394	5623	5367	5487	
		65	5449	5612	5327	5605	5386	
		70	5413	5454	5494	5657	5498	
		75	5636	5532	5466	5456	5482	
		80	5365	5601	5320	5393	5534	
		85	5371	5368	5416	5488	5529	
		90	5390	5550	5661	5472	5431	
		95	5268	5260	5391	5573	5516	

Type 6 Radar Waveform_28

Download	28	Type 6	1.0	333.3	9	0.3333	300.0000000	3
		Frequency List (MHz)	0	1	2	3	4	
		0	5532	5274	5662	5625	5449	
		5	5377	5300	5602	5589	5325	
		10	5336	5268	5607	5630	5521	
		15	5407	5288	5351	5433	5580	
		20	5711	5399	5402	5481	5361	
		25	5510	5363	5563	5604	5322	
		30	5713	5389	5390	5641	5570	
		35	5470	5581	5476	5676	5678	
		40	5372	5562	5667	5309	5670	
		45	5339	5332	5710	5504	5565	
		50	5493	5350	5546	5600	5394	
		55	5435	5689	5284	5386	5348	
		60	5701	5313	5310	5398	5551	
		65	5537	5400	5577	5458	5554	
		70	5343	5633	5272	5467	5281	
		75	5675	5447	5708	5495	5621	
		80	5290	5345	5317	5685	5437	
		85	5291	5334	5266	5333	5674	
		90	5664	5686	5694	5615	5327	
		95	5369	5659	5527	5415	5263	

Type 6 Radar Waveform_29								
Download	29	Type 6	1.0	333.3	9	0.3333	300.0000000	2
		Frequency List (MHz)	0	1	2	3	4	
		0	5312	5513	5598	5311	5291	
		5	5419	5322	5677	5277	5532	
		10	5267	5630	5327	5651	5609	
		15	5534	5294	5299	5625	5588	
		20	5305	5437	5394	5454	5627	
		25	5362	5566	5667	5638	5364	
		30	5699	5346	5605	5318	5390	
		35	5672	5272	5354	5592	5686	
		40	5549	5268	5370	5415	5671	
		45	5557	5701	5344	5669	5401	
		50	5257	5423	5582	5389	5307	
		55	5481	5357	5515	5533	5372	
		60	5259	5511	5347	5587	5369	
		65	5670	5380	5385	5706	5339	
		70	5721	5428	5485	5402	5408	
		75	5314	5405	5608	5297	5361	
		80	5676	5628	5506	5384	5718	
		85	5251	5695	5399	5636	5596	
		90	5597	5591	5698	5505	5315	
		95	5427	5283	5280	5510	5381	

Test Site	SIP-TR2	Test Engineer	Alisa Deng
Test Date	2022/04/10		
Test Item	Radar Statistical Performance Check (802.11ac-VHT40 – 5510MHz)		

Radar Type 1-4 - Radar Statistical Performance								
Trial	Radar Type 1		Radar Type 2		Radar Type 3		Radar Type 4	
	Frequency (MHz)	1=detect 0=no detect	Frequency (MHz)	1=detect 0=no detect	Frequency (MHz)	1=detect 0=no detect	Frequency (MHz)	1=detect 0=no detect
0	5502	1	5517	1	5518	1	5510	1
1	5502	1	5519	1	5490	1	5520	1
2	5510	1	5502	1	5502	1	5497	1
3	5496	1	5528	0	5511	1	5502	1
4	5530	1	5523	1	5517	1	5494	1
5	5501	1	5490	1	5493	0	5518	1
6	5507	1	5508	1	5491	1	5504	1
7	5515	1	5500	1	5529	1	5496	0
8	5512	1	5496	1	5495	1	5493	1
9	5495	1	5521	1	5527	1	5504	1
10	5508	1	5511	0	5506	1	5530	0
11	5521	1	5507	0	5503	1	5500	1
12	5500	1	5490	0	5510	1	5494	1
13	5498	1	5521	1	5525	1	5529	1
14	5502	1	5523	1	5491	1	5523	1
15	5525	1	5529	1	5519	0	5507	1
16	5518	1	5503	1	5530	1	5490	1
17	5528	1	5513	1	5530	1	5505	1
18	5508	1	5507	1	5521	1	5520	0
19	5516	1	5524	1	5518	1	5522	1
20	5500	1	5521	1	5519	1	5490	1
21	5506	1	5519	1	5503	1	5517	1
22	5496	1	5530	0	5530	0	5503	1
23	5504	1	5502	1	5525	1	5500	1
24	5504	1	5496	1	5528	1	5528	1
25	5493	1	5510	1	5502	1	5503	1
26	5492	1	5518	1	5499	1	5492	1



Radar Type 1-4 - Radar Statistical Performance								
Trial	Radar Type 1		Radar Type 2		Radar Type 3		Radar Type 4	
	Frequency (MHz)	1=detect 0=no detect	Frequency (MHz)	1=detect 0=no detect	Frequency (MHz)	1=detect 0=no detect	Frequency (MHz)	1=detect 0=no detect
27	5520	1	5501	1	5520	1	5527	1
28	5490	1	5499	0	5499	1	5520	1
29	5511	1	5497	1	5500	1	5525	0
Probability:	100.0%		80.0%		90.0%		86.7%	
Aggregate:	$P_{Aggregate}=(P_1+P_2+P_3+P_4)/4=(100.0\%+80.0\%+90.0\%+86.7\%)/4=89.18\% (>80\%)$							

Radar Type 1 - Radar Waveform							Radar Type 2 - Radar Waveform						
Trial List							Trial List						
	Trial Id	Radar Type	Pulse Width (us)	PRI (us)	Number of Pulses	Waveform Length (us)		Trial Id	Radar Type	Pulse Width (us)	PRI (us)	Number of Pulses	Waveform Length (us)
Download	0	Type 1	1.0	778.0	68	52904.0	Download	0	Type 2	4.8	224.0	29	6496.0
Download	1	Type 1	1.0	798.0	67	53466.0	Download	1	Type 2	2.7	194.0	25	4850.0
Download	2	Type 1	1.0	838.0	63	52794.0	Download	2	Type 2	2.0	206.0	24	4944.0
Download	3	Type 1	1.0	938.0	57	53466.0	Download	3	Type 2	3.2	229.0	26	5954.0
Download	4	Type 1	1.0	598.0	89	53222.0	Download	4	Type 2	1.6	215.0	24	5160.0
Download	5	Type 1	1.0	878.0	61	53558.0	Download	5	Type 2	4.2	193.0	28	5404.0
Download	6	Type 1	1.0	918.0	58	53244.0	Download	6	Type 2	3.3	218.0	27	5886.0
Download	7	Type 1	1.0	758.0	70	53080.0	Download	7	Type 2	2.1	228.0	24	5472.0
Download	8	Type 1	1.0	858.0	62	53196.0	Download	8	Type 2	4.6	191.0	29	5539.0
Download	9	Type 1	1.0	618.0	86	53148.0	Download	9	Type 2	1.1	156.0	23	3588.0
Download	10	Type 1	1.0	818.0	65	53170.0	Download	10	Type 2	1.5	220.0	23	5060.0
Download	11	Type 1	1.0	538.0	99	53262.0	Download	11	Type 2	1.2	152.0	23	3496.0
Download	12	Type 1	1.0	658.0	81	53298.0	Download	12	Type 2	4.1	208.0	28	5824.0
Download	13	Type 1	1.0	718.0	74	53132.0	Download	13	Type 2	5.0	180.0	29	5220.0
Download	14	Type 1	1.0	698.0	76	53048.0	Download	14	Type 2	2.2	192.0	25	4800.0
Download	15	Type 1	1.0	1622.0	33	53526.0	Download	15	Type 2	5.0	212.0	29	6148.0
Download	16	Type 1	1.0	1679.0	32	53728.0	Download	16	Type 2	3.5	151.0	27	4077.0
Download	17	Type 1	1.0	1372.0	39	53508.0	Download	17	Type 2	4.0	185.0	28	5180.0
Download	18	Type 1	1.0	2823.0	19	53637.0	Download	18	Type 2	2.3	181.0	25	4525.0
Download	19	Type 1	1.0	2836.0	19	53884.0	Download	19	Type 2	3.4	209.0	27	5643.0
Download	20	Type 1	1.0	2586.0	21	54306.0	Download	20	Type 2	2.0	176.0	24	4224.0
Download	21	Type 1	1.0	1522.0	35	53270.0	Download	21	Type 2	3.9	196.0	28	5488.0
Download	22	Type 1	1.0	2900.0	19	55100.0	Download	22	Type 2	3.8	185.0	27	4455.0
Download	23	Type 1	1.0	2612.0	21	54852.0	Download	23	Type 2	4.2	168.0	28	4704.0
Download	24	Type 1	1.0	869.0	61	53009.0	Download	24	Type 2	3.3	157.0	26	4082.0
Download	25	Type 1	1.0	2152.0	25	53800.0	Download	25	Type 2	1.2	169.0	23	3887.0
Download	26	Type 1	1.0	1713.0	31	53103.0	Download	26	Type 2	4.5	161.0	29	4669.0
Download	27	Type 1	1.0	1402.0	38	53276.0	Download	27	Type 2	3.1	201.0	26	5226.0
Download	28	Type 1	1.0	1344.0	40	53760.0	Download	28	Type 2	1.5	164.0	23	3772.0
Download	29	Type 1	1.0	2522.0	21	52962.0	Download	29	Type 2	1.2	226.0	23	5198.0



Radar Type 3 - Radar Waveform							Radar Type 4 - Radar Waveform						
Trial List							Trial List						
	Trial Id	Radar Type	Pulse Width (us)	PRF (us)	Number of Pulses	Waveform Length (us)		Trial Id	Radar Type	Pulse Width (us)	PRF (us)	Number of Pulses	Waveform Length (us)
Download	0	Type 3	9.8	315.0	18	5670.0	Download	0	Type 4	19.5	315.0	16	5040.0
Download	1	Type 3	7.7	492.0	17	8364.0	Download	1	Type 4	14.7	492.0	14	6888.0
Download	2	Type 3	7.0	279.0	16	4464.0	Download	2	Type 4	13.2	279.0	13	3627.0
Download	3	Type 3	8.2	385.0	17	6545.0	Download	3	Type 4	16.1	385.0	14	5390.0
Download	4	Type 3	6.6	475.0	16	7600.0	Download	4	Type 4	12.4	475.0	12	5700.0
Download	5	Type 3	9.2	244.0	18	4392.0	Download	5	Type 4	18.1	244.0	15	3660.0
Download	6	Type 3	8.3	310.0	17	5270.0	Download	6	Type 4	16.2	310.0	14	4340.0
Download	7	Type 3	7.1	360.0	16	5760.0	Download	7	Type 4	13.5	360.0	13	4680.0
Download	8	Type 3	9.6	470.0	18	8460.0	Download	8	Type 4	19.1	470.0	16	7520.0
Download	9	Type 3	6.1	392.0	16	6272.0	Download	9	Type 4	11.4	392.0	12	4704.0
Download	10	Type 3	6.5	269.0	16	4304.0	Download	10	Type 4	12.1	269.0	12	3228.0
Download	11	Type 3	6.2	299.0	16	4784.0	Download	11	Type 4	11.4	299.0	12	3588.0
Download	12	Type 3	9.1	254.0	18	4572.0	Download	12	Type 4	17.9	254.0	15	3810.0
Download	13	Type 3	10.0	468.0	18	8424.0	Download	13	Type 4	19.9	468.0	16	7488.0
Download	14	Type 3	7.2	210.0	16	3360.0	Download	14	Type 4	13.7	210.0	13	2730.0
Download	15	Type 3	10.0	245.0	18	4410.0	Download	15	Type 4	20.0	245.0	16	3920.0
Download	16	Type 3	8.5	370.0	17	6290.0	Download	16	Type 4	16.5	370.0	15	5550.0
Download	17	Type 3	9.0	327.0	18	5886.0	Download	17	Type 4	17.8	327.0	15	4905.0
Download	18	Type 3	7.3	441.0	16	7056.0	Download	18	Type 4	13.9	441.0	13	5733.0
Download	19	Type 3	8.4	294.0	17	4998.0	Download	19	Type 4	16.3	294.0	14	4116.0
Download	20	Type 3	7.0	422.0	16	6752.0	Download	20	Type 4	13.3	422.0	13	5486.0
Download	21	Type 3	8.9	377.0	18	6786.0	Download	21	Type 4	17.5	377.0	15	5685.0
Download	22	Type 3	8.8	231.0	18	4158.0	Download	22	Type 4	17.4	231.0	15	3465.0
Download	23	Type 3	9.2	474.0	18	8532.0	Download	23	Type 4	18.2	474.0	15	7110.0
Download	24	Type 3	8.3	242.0	17	4114.0	Download	24	Type 4	16.1	242.0	14	3388.0
Download	25	Type 3	6.2	495.0	16	7920.0	Download	25	Type 4	11.6	495.0	12	5940.0
Download	26	Type 3	9.5	396.0	18	7128.0	Download	26	Type 4	18.8	396.0	16	6336.0
Download	27	Type 3	8.1	325.0	17	5525.0	Download	27	Type 4	15.8	325.0	14	4550.0
Download	28	Type 3	6.5	239.0	16	3824.0	Download	28	Type 4	12.1	239.0	12	2868.0
Download	29	Type 3	6.2	375.0	16	6000.0	Download	29	Type 4	11.6	375.0	12	4500.0



Radar Type 5 - Radar Statistical Performance					
Trail #	Test Freq. (MHz)	1=Detection 0=No Detection	Trail #	Test Freq. (MHz)	1=Detection 0=No Detection
0	5510	1	15	5499	1
1	5510	1	16	5497	1
2	5510	1	17	5497	1
3	5510	1	18	5495	0
4	5510	1	19	5497	1
5	5510	1	20	5525	1
6	5510	1	21	5523	1
7	5510	1	22	5523	1
8	5510	1	23	5522	1
9	5510	0	24	5524	1
10	5493	1	25	5527	1
11	5493	1	26	5522	1
12	5498	1	27	5524	1
13	5499	1	28	5527	0
14	5495	1	29	5527	0
Detection Percentage (%)			86.7%		

Type 5 Radar Waveform_0										
Download	0	Type 5	20	0.60000000	12.00000000	5.5100000000				
		Burst ID	Burst Offset (us)	Pulse Width (us)	Chirp Width (MHz)	Number of Pulses per Burst	PRI-1 (us)	PRI-2 (us)	PRI-3 (us)	
		0	105466.0	96.8	19	3	1845.0	1194.0	1335.0	
		1	250479.0	70.8	19	2	1065.0	1995.0	-	
		2	395961.0	62.5	19	1	1988.0	-	-	
		3	540030.0	78.0	19	2	1110.0	1948.0	-	
		4	68142.0	58.0	19	1	1176.0	-	-	
		5	232289.0	89.5	19	3	1228.0	1317.0	1421.0	
		6	377026.0	78.9	19	2	1938.0	1742.0	-	
		7	523553.0	64.1	19	1	1508.0	-	-	
		8	69905.0	94.9	19	3	1807.0	1216.0	1119.0	
		9	215390.0	52.3	19	1	1445.0	-	-	
		10	360690.0	56.1	19	1	1226.0	-	-	
		11	505860.0	52.5	19	1	1287.0	-	-	
		12	52030.0	88.4	19	3	1677.0	1692.0	1624.0	
		13	196535.0	99.1	19	3	1595.0	1798.0	1003.0	
		14	342705.0	65.0	19	1	1395.0	-	-	
		15	485711.0	99.6	19	3	1367.0	1040.0	1656.0	
		16	34377.0	80.6	19	2	1336.0	1525.0	-	
		17	178555.0	87.5	19	3	1332.0	1685.0	2000.0	
		18	324689.0	66.3	19	1	1640.0	-	-	
		19	468237.0	79.5	19	2	1732.0	1912.0	-	

Type 5 Radar Waveform_1

Download	1	Type 5	13	0.9230769	12.0000000	5.510000000				
		Burst ID	Burst Offset (us)	Pulse Width (us)	Chirp Width (MHz)	Number of Pulses per Burst	PRI-1 (us)	PRI-2 (us)	PRI-3 (us)	
		0	25633.0	62.8	11	1	1133.0	-	-	
		1	248104.0	86.2	11	3	1612.0	1492.0	1838.0	
		2	471147.0	85.2	11	3	1312.0	1199.0	1716.0	
		3	694100.0	89.7	11	3	1025.0	1873.0	1193.0	
		4	918205.0	78.1	11	2	1180.0	1686.0	-	
		5	221532.0	53.5	11	1	1380.0	-	-	
		6	443238.0	93.2	11	3	1848.0	1558.0	1772.0	
		7	667221.0	76.4	11	2	1896.0	1400.0	-	
		8	892092.0	56.2	11	1	1443.0	-	-	
		9	194054.0	53.3	11	1	1107.0	-	-	
		10	417459.0	61.3	11	1	1553.0	-	-	
		11	638443.0	99.8	11	3	1811.0	1441.0	1916.0	
		12	862009.0	86.7	11	3	1338.0	1413.0	1410.0	

Type 5 Radar Waveform_2

Download	2	Type 5	11	1.0909091	12.0000000	5.510000000				
		Burst ID	Burst Offset (us)	Pulse Width (us)	Chirp Width (MHz)	Number of Pulses per Burst	PRI-1 (us)	PRI-2 (us)	PRI-3 (us)	
		0	196366.0	82.2	8	2	1825.0	1809.0	-	
		1	459590.0	86.6	8	3	1578.0	1389.0	1788.0	
		2	725319.0	52.8	8	1	1296.0	-	-	
		3	965760.0	93.4	8	3	1869.0	1797.0	1841.0	
		4	164217.0	50.3	8	1	1425.0	-	-	
		5	428102.0	76.0	8	2	1082.0	1231.0	-	
		6	690847.0	92.7	8	3	1777.0	1427.0	1113.0	
		7	953245.0	96.5	8	3	1972.0	1958.0	1679.0	
		8	131486.0	69.9	8	2	1776.0	1166.0	-	
		9	395582.0	72.1	8	2	1102.0	1207.0	-	
		10	658695.0	84.4	8	3	1722.0	1026.0	1059.0	

Type 5 Radar Waveform_3

Download	3	Type 5	15	0.8000000	12.0000000	5.510000000				
		Burst ID	Burst Offset (us)	Pulse Width (us)	Chirp Width (MHz)	Number of Pulses per Burst	PRI-1 (us)	PRI-2 (us)	PRI-3 (us)	
		0	677117.0	60.6	13	1	1936.0	-	-	
		1	72507.0	71.6	13	2	1650.0	1398.0	-	
		2	265268.0	93.5	13	3	1863.0	1559.0	1202.0	
		3	460222.0	54.2	13	1	1064.0	-	-	
		4	650513.0	94.5	13	3	1617.0	1793.0	1900.0	
		5	48728.0	82.5	13	2	1337.0	1232.0	-	
		6	241477.0	98.6	13	3	1014.0	1933.0	1771.0	
		7	434552.0	91.1	13	3	1261.0	1743.0	1361.0	
		8	628167.0	87.1	13	3	1129.0	1029.0	1384.0	
		9	24907.0	67.5	13	2	1326.0	1197.0	-	
		10	218563.0	54.5	13	1	1635.0	-	-	
		11	412009.0	60.5	13	1	1989.0	-	-	
		12	603100.0	85.7	13	3	1889.0	1960.0	1371.0	
		13	1082.0	72.9	13	2	1310.0	1319.0	-	
		14	194027.0	100.0	13	3	1523.0	1810.0	1114.0	

Type 5 Radar Waveform_4

Download	4	Type 5	10	1.2000000	12.0000000	5.510000000				
		Burst ID	Burst Offset (us)	Pulse Width (us)	Chirp Width (MHz)	Number of Pulses per Burst	PRI-1 (us)	PRI-2 (us)	PRI-3 (us)	
		0	583002.0	54.5	7	1	1444.0	-	-	
		1	870860.0	96.3	7	3	1984.0	1564.0	1778.0	
		2	1164534.0	52.4	7	1	1282.0	-	-	
		3	256397.0	57.9	7	1	1966.0	-	-	
		4	546046.0	91.6	7	3	1063.0	1575.0	1325.0	
		5	835863.0	91.1	7	3	1874.0	1447.0	1013.0	
		6	1128530.0	56.4	7	1	1488.0	-	-	
		7	220676.0	65.9	7	1	1586.0	-	-	
		8	511219.0	56.1	7	1	1844.0	-	-	
		9	801773.0	62.5	7	1	1899.0	-	-	

Type 5 Radar Waveform_5

Download	5	Type 5	18	0.666667	12.000000	5.51000000				
		Burst ID	Burst Offset (us)	Pulse Width (us)	Chirp Width (MHz)	Number of Pulses per Burst	PRI-1 (us)	PRI-2 (us)	PRI-3 (us)	
		0	606654.0	62.2	17	1	1283.0	-	-	
		1	102566.0	56.1	17	1	1805.0	-	-	
		2	263430.0	80.3	17	2	1322.0	1454.0	-	
		3	425273.0	61.4	17	1	1481.0	-	-	
		4	586076.0	73.7	17	2	1538.0	1672.0	-	
		5	82567.0	83.0	17	2	1545.0	1359.0	-	
		6	242756.0	92.9	17	3	1499.0	1736.0	1834.0	
		7	405653.0	64.1	17	1	1067.0	-	-	
		8	566370.0	50.8	17	1	1902.0	-	-	
		9	62702.0	79.0	17	2	1489.0	1789.0	-	
		10	224127.0	56.4	17	1	1699.0	-	-	
		11	385748.0	60.0	17	1	1103.0	-	-	
		12	545001.0	89.0	17	3	1100.0	1318.0	1321.0	
		13	42958.0	82.0	17	2	1006.0	1125.0	-	
		14	203768.0	73.7	17	2	1763.0	1542.0	-	
		15	365440.0	54.7	17	1	1876.0	-	-	
		16	525942.0	70.2	17	2	1424.0	1374.0	-	
		17	23138.0	62.6	17	1	1172.0	-	-	

Type 5 Radar Waveform_6

Download	6	Type 5	15	0.800000	12.000000	5.51000000				
		Burst ID	Burst Offset (us)	Pulse Width (us)	Chirp Width (MHz)	Number of Pulses per Burst	PRI-1 (us)	PRI-2 (us)	PRI-3 (us)	
		0	221097.0	69.1	14	2	1468.0	1211.0	-	
		1	414227.0	77.7	14	2	1626.0	1527.0	-	
		2	607676.0	76.0	14	2	1375.0	1530.0	-	
		3	3902.0	67.2	14	2	1106.0	1739.0	-	
		4	197093.0	70.5	14	2	1607.0	1819.0	-	
		5	391235.0	50.3	14	1	1493.0	-	-	
		6	584467.0	71.5	14	2	1058.0	1023.0	-	
		7	774602.0	96.4	14	3	2000.0	1799.0	1755.0	
		8	173075.0	94.1	14	3	1741.0	1218.0	1484.0	
		9	367344.0	62.0	14	1	1569.0	-	-	
		10	559594.0	80.6	14	2	1582.0	1973.0	-	
		11	752886.0	93.3	14	3	1249.0	1049.0	1121.0	
		12	149769.0	54.1	14	1	1987.0	-	-	
		13	343596.0	55.7	14	1	1327.0	-	-	
		14	535495.0	87.3	14	3	1268.0	1150.0	1591.0	

Type 5 Radar Waveform_7

Download	7	Type 5	11	1.090909	12.000000	5.51000000				
		Burst ID	Burst Offset (us)	Pulse Width (us)	Chirp Width (MHz)	Number of Pulses per Burst	PRI-1 (us)	PRI-2 (us)	PRI-3 (us)	
		0	995162.0	91.7	9	3	1259.0	1363.0	1001.0	
		1	171565.0	82.2	9	2	1985.0	1713.0	-	
		2	435558.0	76.4	9	2	1757.0	1167.0	-	
		3	699244.0	68.2	9	2	1834.0	1577.0	-	
		4	963101.0	79.7	9	2	1419.0	1729.0	-	
		5	139342.0	63.3	9	1	1688.0	-	-	
		6	402388.0	84.5	9	3	1829.0	1562.0	1333.0	
		7	667982.0	61.6	9	1	1201.0	-	-	
		8	928709.0	96.4	9	3	1618.0	1871.0	1875.0	
		9	106420.0	84.8	9	3	1826.0	1872.0	1887.0	
		10	369871.0	93.9	9	3	1540.0	1392.0	1993.0	

Type 5 Radar Waveform_8

Download	8	Type 5	19	0.6315789	12.0000000	5.510000000				
		Burst ID	Burst Offset (us)	Pulse Width (us)	Chirp Width (MHz)	Number of Pulses per Burst	PRI-1 (us)	PRI-2 (us)	PRI-3 (us)	
		0	365603.0	93.6	19	3	1689.0	1507.0	1402.0	
		1	518549.0	94.6	19	3	1015.0	1479.0	1035.0	
		2	42945.0	57.3	19	1	1696.0	-	-	
		3	195166.0	70.5	19	2	1910.0	1541.0	-	
		4	346986.0	84.3	19	3	1188.0	1616.0	1590.0	
		5	499106.0	86.8	19	3	1511.0	1561.0	1311.0	
		6	24075.0	70.8	19	2	1146.0	1928.0	-	
		7	175937.0	93.8	19	3	1747.0	1840.0	1518.0	
		8	328221.0	96.8	19	3	1343.0	1764.0	1341.0	
		9	481758.0	78.5	19	2	1290.0	1280.0	-	
		10	5285.0	86.6	19	3	1991.0	1399.0	1393.0	
		11	157432.0	95.1	19	3	1606.0	1659.0	1000.0	
		12	309331.0	85.7	19	3	1603.0	1882.0	1275.0	
		13	462730.0	80.0	19	2	1173.0	1718.0	-	
		14	613333.0	90.0	19	3	1584.0	1285.0	1937.0	
		15	139078.0	77.3	19	2	1254.0	1266.0	-	
		16	290747.0	89.0	19	3	1579.0	1482.0	1394.0	
		17	443439.0	80.9	19	2	1944.0	1669.0	-	
		18	594472.0	83.6	19	3	1439.0	1676.0	1835.0	

Type 5 Radar Waveform_9

Download	9	Type 5	8	1.5000000	12.0000000	5.510000000				
		Burst ID	Burst Offset (us)	Pulse Width (us)	Chirp Width (MHz)	Number of Pulses per Burst	PRI-1 (us)	PRI-2 (us)	PRI-3 (us)	
		0	266599.0	57.5	5	1	1158.0	-	-	
		1	649206.0	74.8	5	2	1373.0	1883.0	-	
		2	1013366.0	50.6	5	1	1552.0	-	-	
		3	1375899.0	72.7	5	2	1042.0	1476.0	-	
		4	241146.0	97.3	5	3	1535.0	1907.0	1904.0	
		5	603684.0	99.8	5	3	1521.0	1906.0	1827.0	
		6	967272.0	97.4	5	3	1187.0	1080.0	1340.0	
		7	1329209.0	86.5	5	3	1614.0	1214.0	1888.0	

Type 5 Radar Waveform_10

Download	10	Type 5	9	1.3333333	12.0000000	5.493000000				
		Burst ID	Burst Offset (us)	Pulse Width (us)	Chirp Width (MHz)	Number of Pulses per Burst	PRI-1 (us)	PRI-2 (us)	PRI-3 (us)	
		0	174711.0	90.6	6	3	1146.0	1532.0	1704.0	
		1	496834.0	99.3	6	3	1641.0	1648.0	1600.0	
		2	818927.0	84.7	6	3	1816.0	1929.0	1300.0	
		3	1144257.0	66.0	6	1	1345.0	-	-	
		4	135177.0	79.7	6	2	1703.0	1031.0	-	
		5	457505.0	82.4	6	2	1930.0	1920.0	-	
		6	780229.0	76.6	6	2	1999.0	1370.0	-	
		7	1104298.0	58.7	6	1	1547.0	-	-	
		8	95416.0	76.9	6	2	1277.0	1589.0	-	

Type 5 Radar Waveform_11

Download	11	Type 5	8	1.5000000	12.0000000	5.493000000				
		Burst ID	Burst Offset (us)	Pulse Width (us)	Chirp Width (MHz)	Number of Pulses per Burst	PRI-1 (us)	PRI-2 (us)	PRI-3 (us)	
		0	470104.0	89.1	5	3	1221.0	1565.0	1248.0	
		1	833545.0	73.5	5	2	1406.0	1512.0	-	
		2	1196632.0	77.8	5	2	1774.0	1147.0	-	
		3	62564.0	93.8	5	3	1557.0	1723.0	1474.0	
		4	425608.0	72.5	5	2	1486.0	1864.0	-	
		5	789373.0	80.3	5	1	1867.0	-	-	
		6	1152971.0	59.0	5	1	1539.0	-	-	
		7	17938.0	58.8	5	1	1143.0	-	-	

Type 5 Radar Waveform_12

Download	12	Type 5	17	0.7058824	12.0000000	5.498000000				
		Burst ID	Burst Offset (us)	Pulse Width (us)	Chirp Width (MHz)	Number of Pulses per Burst	PRI-1 (us)	PRI-2 (us)	PRI-3 (us)	
		0	179166.0	55.1	17	1	1891.0	-	-	
		1	348732.0	87.2	17	3	1824.0	1334.0	1094.0	
		2	518793.0	90.7	17	3	1599.0	1204.0	1593.0	
		3	689257.0	88.3	17	3	1079.0	1909.0	1071.0	
		4	157633.0	89.7	17	3	1033.0	1455.0	1636.0	
		5	327629.0	86.1	17	3	1858.0	1170.0	1529.0	
		6	497437.0	95.6	17	3	1356.0	1791.0	1813.0	
		7	669113.0	80.8	17	2	1517.0	1678.0	-	
		8	137271.0	62.8	17	1	1027.0	-	-	
		9	307212.0	77.3	17	2	1660.0	1675.0	-	
		10	477298.0	69.0	17	2	1837.0	1945.0	-	
		11	647483.0	92.9	17	3	1693.0	1053.0	1141.0	
		12	115905.0	71.8	17	2	1130.0	1773.0	-	
		13	287073.0	60.0	17	1	1250.0	-	-	
		14	456471.0	70.7	17	2	1998.0	1556.0	-	
		15	625201.0	86.9	17	3	1765.0	1975.0	1615.0	
		16	95048.0	50.3	17	1	1832.0	-	-	

Type 5 Radar Waveform_13

Download	13	Type 5	20	0.6000000	12.0000000	5.498000000				
		Burst ID	Burst Offset (us)	Pulse Width (us)	Chirp Width (MHz)	Number of Pulses per Burst	PRI-1 (us)	PRI-2 (us)	PRI-3 (us)	
		0	225102.0	80.3	20	2	1833.0	1923.0	-	
		1	369053.0	94.5	20	3	1781.0	1566.0	1469.0	
		2	515875.0	62.1	20	1	1951.0	-	-	
		3	62907.0	62.5	20	1	1613.0	-	-	
		4	208215.0	56.9	20	1	1096.0	-	-	
		5	352966.0	62.6	20	1	1946.0	-	-	
		6	498117.0	59.0	20	1	1821.0	-	-	
		7	44947.0	73.2	20	2	1056.0	1668.0	-	
		8	190047.0	63.0	20	1	1963.0	-	-	
		9	333825.0	88.3	20	3	1018.0	1267.0	1935.0	
		10	480602.0	65.4	20	1	1378.0	-	-	
		11	27149.0	53.1	20	1	1726.0	-	-	
		12	171231.0	89.9	20	3	1859.0	1448.0	1955.0	
		13	316138.0	85.1	20	3	1622.0	1165.0	1223.0	
		14	462576.0	64.4	20	1	1563.0	-	-	
		15	9251.0	91.7	20	3	1037.0	1271.0	1075.0	
		16	154334.0	63.8	20	1	1892.0	-	-	
		17	297786.0	92.2	20	3	1504.0	1609.0	1990.0	
		18	444966.0	62.6	20	1	1203.0	-	-	
		19	589850.0	56.6	20	1	1551.0	-	-	

Type 5 Radar Waveform_14

Download	14	Type 5	11	1.0909091	12.0000000	5.495000000				
		Burst ID	Burst Offset (us)	Pulse Width (us)	Chirp Width (MHz)	Number of Pulses per Burst	PRI-1 (us)	PRI-2 (us)	PRI-3 (us)	
		0	247923.0	98.2	9	3	1500.0	1349.0	1451.0	
		1	512628.0	50.9	9	1	1818.0	-	-	
		2	776766.0	63.2	9	1	1820.0	-	-	
		3	1038356.0	89.2	9	3	1241.0	1403.0	1842.0	
		4	215265.0	85.3	9	3	1865.0	1503.0	1921.0	
		5	479843.0	66.8	9	2	1352.0	1032.0	-	
		6	744345.0	55.1	9	1	1651.0	-	-	
		7	1008309.0	57.6	9	1	1884.0	-	-	
		8	183453.0	63.8	9	1	1608.0	-	-	
		9	447774.0	55.1	9	1	1288.0	-	-	
		10	711202.0	79.1	9	2	1196.0	1377.0	-	

Type 5 Radar Waveform_15

Download	15	Type 5	20	0.6000000	12.0000000	5.439000000				
		Burst ID	Burst Offset (us)	Pulse Width (us)	Chirp Width (MHz)	Number of Pulses per Burst	PRI-1 (us)	PRI-2 (us)	PRI-3 (us)	
		0	536639.0	52.8	20	1	1078.0	-	-	
		1	82524.0	90.9	20	3	1431.0	1783.0	1115.0	
		2	226883.0	93.5	20	3	1152.0	1721.0	1745.0	
		3	370940.0	92.2	20	3	1870.0	1979.0	1316.0	
		4	518317.0	65.9	20	1	1574.0	-	-	
		5	64697.0	97.0	20	3	1409.0	1379.0	1830.0	
		6	209030.0	96.4	20	3	1339.0	1996.0	1472.0	
		7	354228.0	98.3	20	3	1070.0	1104.0	1209.0	
		8	499263.0	74.5	20	2	1674.0	1307.0	-	
		9	47062.0	81.6	20	2	1516.0	1183.0	-	
		10	192334.0	65.1	20	1	1428.0	-	-	
		11	336902.0	76.6	20	2	1414.0	1086.0	-	
		12	479830.0	97.8	20	3	1974.0	1843.0	1145.0	
		13	29213.0	80.1	20	2	1495.0	1305.0	-	
		14	173747.0	77.7	20	2	1943.0	1905.0	-	
		15	318848.0	72.9	20	2	1252.0	1631.0	-	
		16	462210.0	92.2	20	3	1896.0	1645.0	1219.0	
		17	11402.0	54.5	20	1	1236.0	-	-	
		18	156649.0	51.2	20	1	1126.0	-	-	
		19	301470.0	57.9	20	1	1970.0	-	-	

Type 5 Radar Waveform_16

Download	16	Type 5	15	0.8000000	12.0000000	5.497000000				
		Burst ID	Burst Offset (us)	Pulse Width (us)	Chirp Width (MHz)	Number of Pulses per Burst	PRI-1 (us)	PRI-2 (us)	PRI-3 (us)	
		0	595037.0	67.9	14	2	1927.0	1116.0	-	
		1	790190.0	58.1	14	1	1156.0	-	-	
		2	184669.0	80.3	14	2	1195.0	1785.0	-	
		3	378788.0	52.1	14	1	1256.0	-	-	
		4	570810.0	79.4	14	2	1866.0	1760.0	-	
		5	764650.0	81.3	14	2	1880.0	1043.0	-	
		6	160730.0	72.9	14	2	1697.0	1918.0	-	
		7	354208.0	77.3	14	2	1462.0	1411.0	-	
		8	547120.0	90.1	14	3	1353.0	1008.0	1118.0	
		9	741811.0	57.5	14	1	1855.0	-	-	
		10	137307.0	51.4	14	1	1473.0	-	-	
		11	330987.0	59.3	14	1	1442.0	-	-	
		12	524727.0	57.9	14	1	1344.0	-	-	
		13	718273.0	59.1	14	1	1515.0	-	-	
		14	113505.0	62.6	14	1	1099.0	-	-	

Type 5 Radar Waveform_17

Download	17	Type 5	17	0.7058824	12.0000000	5.497000000				
		Burst ID	Burst Offset (us)	Pulse Width (us)	Chirp Width (MHz)	Number of Pulses per Burst	PRI-1 (us)	PRI-2 (us)	PRI-3 (us)	
		0	271049.0	62.2	16	1	1140.0	-	-	
		1	439725.0	96.5	16	3	1925.0	1505.0	1292.0	
		2	610304.0	92.9	16	3	1437.0	1198.0	1483.0	
		3	78754.0	98.6	16	3	1245.0	1240.0	1501.0	
		4	249198.0	94.7	16	3	1301.0	1011.0	1076.0	
		5	419901.0	67.5	16	2	1272.0	1571.0	-	
		6	589479.0	93.9	16	3	1065.0	1728.0	1159.0	
		7	57674.0	88.1	16	3	1683.0	1657.0	1992.0	
		8	228424.0	75.1	16	2	1142.0	1592.0	-	
		9	398597.0	83.1	16	2	1762.0	1611.0	-	
		10	569397.0	74.3	16	2	1440.0	1416.0	-	
		11	36930.0	65.4	16	1	1617.0	-	-	
		12	207752.0	59.0	16	1	1601.0	-	-	
		13	378429.0	57.5	16	1	1849.0	-	-	
		14	547225.0	94.0	16	3	1109.0	1519.0	1727.0	
		15	15905.0	62.9	16	1	1449.0	-	-	
		16	186760.0	53.1	16	1	1422.0	-	-	

Type 5 Radar Waveform_18

Download	18	Type 5	12	1.0000000	12.0000000	5.495000000				
		Burst ID	Burst Offset (us)	Pulse Width (us)	Chirp Width (MHz)	Number of Pulses per Burst	PRI-1 (us)	PRI-2 (us)	PRI-3 (us)	
		0	507010.0	62.6	10	1	1243.0	-	-	
		1	746500.0	97.2	10	3	1205.0	1997.0	1694.0	
		2	991480.0	61.2	10	1	1233.0	-	-	
		3	234193.0	94.8	10	3	1215.0	1630.0	1587.0	
		4	477241.0	60.6	10	1	1101.0	-	-	
		5	717006.0	91.4	10	3	1596.0	1415.0	1560.0	
		6	961711.0	62.8	10	1	1162.0	-	-	
		7	204525.0	84.6	10	3	1024.0	1939.0	1108.0	
		8	446389.0	74.0	10	2	1759.0	1598.0	-	
		9	688307.0	69.1	10	2	1408.0	1658.0	-	
		10	931432.0	58.2	10	1	1633.0	-	-	
		11	175048.0	67.0	10	2	1238.0	1262.0	-	

Type 5 Radar Waveform_19

Download	19	Type 5	15	0.8000000	12.0000000	5.497000000				
		Burst ID	Burst Offset (us)	Pulse Width (us)	Chirp Width (MHz)	Number of Pulses per Burst	PRI-1 (us)	PRI-2 (us)	PRI-3 (us)	
		0	333213.0	80.2	14	2	1696.0	1178.0	-	
		1	527164.0	55.7	14	1	1931.0	-	-	
		2	719740.0	68.7	14	2	1583.0	1435.0	-	
		3	115831.0	88.7	14	3	1066.0	1903.0	1555.0	
		4	309046.0	67.5	14	2	1941.0	1846.0	-	
		5	503746.0	65.4	14	1	1260.0	-	-	
		6	696332.0	76.5	14	2	1169.0	1390.0	-	
		7	92048.0	99.4	14	3	1348.0	1711.0	1628.0	
		8	286061.0	55.9	14	1	1548.0	-	-	
		9	479598.0	56.5	14	1	1737.0	-	-	
		10	671565.0	90.5	14	3	1324.0	1054.0	1299.0	
		11	68473.0	74.0	14	2	1418.0	1122.0	-	
		12	261576.0	70.1	14	2	1740.0	1731.0	-	
		13	456029.0	55.1	14	1	1247.0	-	-	
		14	647928.0	69.0	14	2	1853.0	1637.0	-	

Type 5 Radar Waveform_20

Download	20	Type 5	11	1.0909091	12.0000000	5.525000000				
		Burst ID	Burst Offset (us)	Pulse Width (us)	Chirp Width (MHz)	Number of Pulses per Burst	PRI-1 (us)	PRI-2 (us)	PRI-3 (us)	
		0	60985.0	55.1	9	1	1687.0	-	-	
		1	325212.0	65.8	9	1	1498.0	-	-	
		2	589604.0	63.9	9	1	1175.0	-	-	
		3	852019.0	69.7	9	2	1908.0	1665.0	-	
		4	28382.0	96.1	9	3	1815.0	1182.0	1097.0	
		5	291803.0	94.6	9	3	1357.0	1769.0	1588.0	
		6	555341.0	98.4	9	3	1533.0	1667.0	1315.0	
		7	818356.0	96.8	9	3	1429.0	1922.0	1787.0	
		8	1085613.0	60.8	9	1	1200.0	-	-	
		9	259413.0	98.0	9	3	1253.0	1430.0	1780.0	
		10	523652.0	67.8	9	2	1168.0	1756.0	-	

Type 5 Radar Waveform_21

Download	21	Type 5	17	0.7058824	12.0000000	5.523000000				
		Burst ID	Burst Offset (us)	Pulse Width (us)	Chirp Width (MHz)	Number of Pulses per Burst	PRI-1 (us)	PRI-2 (us)	PRI-3 (us)	
		0	510095.0	51.6	16	1	1171.0	-	-	
		1	681018.0	55.0	16	1	1163.0	-	-	
		2	146881.0	80.0	16	2	1758.0	1004.0	-	
		3	318047.0	63.9	16	1	1350.0	-	-	
		4	487589.0	70.7	16	2	1386.0	1880.0	-	
		5	656413.0	98.5	16	3	1977.0	1407.0	1572.0	
		6	125429.0	85.7	16	3	1304.0	1983.0	1969.0	
		7	296605.0	71.0	16	2	1276.0	1010.0	-	
		8	465904.0	95.0	16	3	1412.0	1828.0	1072.0	
		9	637546.0	77.4	16	2	1366.0	1303.0	-	
		10	105018.0	55.5	16	1	1768.0	-	-	
		11	275315.0	76.8	16	2	1452.0	1524.0	-	
		12	444797.0	91.6	16	3	1192.0	1971.0	1383.0	
		13	614822.0	92.2	16	3	1954.0	1546.0	1127.0	
		14	83881.0	67.4	16	2	1180.0	1463.0	-	
		15	255014.0	63.6	16	1	1047.0	-	-	
		16	423275.0	97.2	16	3	1911.0	1654.0	1924.0	

Type 5 Radar Waveform_22

Download	22	Type 5	17	0.7058824	12.0000000	5.523000000				
		Burst ID	Burst Offset (us)	Pulse Width (us)	Chirp Width (MHz)	Number of Pulses per Burst	PRI-1 (us)	PRI-2 (us)	PRI-3 (us)	
		0	596349.0	56.0	16	1	1702.0	-	-	
		1	62971.0	56.7	16	1	1510.0	-	-	
		2	232997.0	87.2	16	3	1391.0	1372.0	1179.0	
		3	403392.0	74.7	16	2	1708.0	1968.0	-	
		4	575191.0	55.4	16	1	1850.0	-	-	
		5	41833.0	72.3	16	2	1961.0	1154.0	-	
		6	212778.0	57.7	16	1	1456.0	-	-	
		7	382750.0	68.8	16	2	1083.0	1976.0	-	
		8	554417.0	60.1	16	1	1522.0	-	-	
		9	20797.0	99.4	16	3	1952.0	1536.0	1045.0	
		10	191692.0	62.1	16	1	1610.0	-	-	
		11	361973.0	72.5	16	2	1364.0	1270.0	-	
		12	532141.0	81.8	16	2	1767.0	1385.0	-	
		13	704100.0	58.9	16	1	1627.0	-	-	
		14	170762.0	57.8	16	1	1155.0	-	-	
		15	340334.0	90.7	16	3	1714.0	1044.0	1174.0	
		16	509542.0	99.7	16	3	1812.0	1597.0	1949.0	

Type 5 Radar Waveform_23

Download	23	Type 5	18	0.6666667	12.0000000	5.522000000				
		Burst ID	Burst Offset (us)	Pulse Width (us)	Chirp Width (MHz)	Number of Pulses per Burst	PRI-1 (us)	PRI-2 (us)	PRI-3 (us)	
		0	644969.0	63.7	17	1	1684.0	-	-	
		1	140840.0	71.4	17	2	1953.0	1733.0	-	
		2	301533.0	69.3	17	2	1994.0	1914.0	-	
		3	461584.0	92.0	17	3	1581.0	1663.0	1652.0	
		4	622020.0	85.9	17	3	1734.0	1273.0	1957.0	
		5	120910.0	92.0	17	3	1550.0	1061.0	1753.0	
		6	261762.0	88.4	17	3	1487.0	1041.0	1313.0	
		7	441363.0	99.1	17	3	1646.0	1947.0	1978.0	
		8	605374.0	60.2	17	1	1534.0	-	-	
		9	101276.0	91.6	17	3	1030.0	1291.0	1052.0	
		10	261770.0	99.6	17	3	1724.0	1465.0	1135.0	
		11	422509.0	89.0	17	3	1450.0	1605.0	1112.0	
		12	584218.0	72.3	17	2	1509.0	1485.0	-	
		13	81486.0	77.5	17	2	1446.0	1715.0	-	
		14	242225.0	78.7	17	2	1878.0	1782.0	-	
		15	403110.0	80.9	17	2	1919.0	1602.0	-	
		16	565552.0	51.1	17	1	1629.0	-	-	
		17	61516.0	90.8	17	3	1347.0	1706.0	1705.0	

Type 5 Radar Waveform_24

Download	24	Type 5	15	0.8000000	12.0000000	5.524000000				
		Burst ID	Burst Offset (us)	Pulse Width (us)	Chirp Width (MHz)	Number of Pulses per Burst	PRI-1 (us)	PRI-2 (us)	PRI-3 (us)	
		0	267967.0	54.1	13	1	1217.0	-	-	
		1	461638.0	60.7	13	1	1320.0	-	-	
		2	652847.0	93.2	13	3	1213.0	1528.0	1621.0	
		3	50137.0	96.3	13	3	1354.0	1700.0	1913.0	
		4	243718.0	82.8	13	2	1060.0	1420.0	-	
		5	436687.0	72.3	13	2	1567.0	1744.0	-	
		6	629545.0	95.2	13	3	1124.0	1073.0	1573.0	
		7	26509.0	60.6	13	1	1257.0	-	-	
		8	219443.0	99.2	13	3	1323.0	1351.0	1436.0	
		9	413028.0	73.5	13	2	1897.0	1136.0	-	
		10	605351.0	98.5	13	3	1230.0	1222.0	1854.0	
		11	2646.0	63.1	13	1	1666.0	-	-	
		12	195913.0	68.4	13	2	1625.0	1480.0	-	
		13	368026.0	97.8	13	3	1932.0	1664.0	1885.0	
		14	581811.0	86.1	13	3	1623.0	1298.0	1068.0	

Type 5 Radar Waveform_25

Download	25	Type 5	8	1.5000000	12.0000000	5.527000000				
		Burst ID	Burst Offset (us)	Pulse Width (us)	Chirp Width (MHz)	Number of Pulses per Burst	PRI-1 (us)	PRI-2 (us)	PRI-3 (us)	
		0	1456211.0	92.0	6	3	1039.0	1926.0	1093.0	
		1	323344.0	78.4	6	2	1087.0	1752.0	-	
		2	686007.0	96.0	6	3	1019.0	1149.0	1643.0	
		3	1048401.0	94.3	6	3	1331.0	1302.0	1862.0	
		4	1414293.0	55.1	6	1	1120.0	-	-	
		5	278683.0	70.2	6	2	1457.0	1028.0	-	
		6	642356.0	64.8	6	1	1368.0	-	-	
		7	1003492.0	98.9	6	3	1314.0	1647.0	1879.0	

Type 5 Radar Waveform_26

Download	26	Type 5	19	0.6315789	12.0000000	5.522000000				
		Burst ID	Burst Offset (us)	Pulse Width (us)	Chirp Width (MHz)	Number of Pulses per Burst	PRI-1 (us)	PRI-2 (us)	PRI-3 (us)	
		0	574450.0	75.6	18	2	1632.0	1234.0	-	
		1	97909.0	95.2	18	3	1681.0	1387.0	1786.0	
		2	250607.0	80.7	18	2	1237.0	1868.0	-	
		3	403950.0	58.2	18	1	1673.0	-	-	
		4	554930.0	79.9	18	2	1720.0	1980.0	-	
		5	79331.0	87.8	18	3	1189.0	1151.0	1365.0	
		6	232084.0	71.8	18	2	1005.0	1417.0	-	
		7	382843.0	83.5	18	3	1901.0	1638.0	1877.0	
		8	535776.0	91.6	18	3	1779.0	1092.0	1294.0	
		9	60691.0	80.7	18	2	1184.0	1308.0	-	
		10	213352.0	68.2	18	2	1157.0	1077.0	-	
		11	366321.0	53.7	18	1	1661.0	-	-	
		12	517858.0	80.0	18	2	1181.0	1982.0	-	
		13	41940.0	56.4	18	1	1856.0	-	-	
		14	194443.0	67.5	18	2	1186.0	1397.0	-	
		15	346618.0	88.7	18	3	1123.0	1051.0	1091.0	
		16	497691.0	97.1	18	3	1568.0	1836.0	1513.0	
		17	23036.0	96.9	18	3	1438.0	1490.0	1405.0	
		18	175706.0	75.2	18	2	1284.0	1105.0	-	

Type 5 Radar Waveform_27

Download	27	Type 5	14	0.8571429	12.0000000	5.524000000				
		Burst ID	Burst Offset (us)	Pulse Width (us)	Chirp Width (MHz)	Number of Pulses per Burst	PRI-1 (us)	PRI-2 (us)	PRI-3 (us)	
		0	444376.0	92.8	13	3	1981.0	1852.0	1670.0	
		1	654366.0	64.9	13	1	1002.0	-	-	
		2	5861.0	50.5	13	1	1655.0	-	-	
		3	212707.0	97.2	13	3	1520.0	1293.0	1396.0	
		4	420460.0	73.2	13	2	1137.0	1263.0	-	
		5	628496.0	51.8	13	1	1401.0	-	-	
		6	835798.0	52.8	13	1	1649.0	-	-	
		7	187470.0	80.4	13	2	1346.0	1754.0	-	
		8	393999.0	99.2	13	3	1021.0	1881.0	1502.0	
		9	602034.0	82.7	13	2	1585.0	1090.0	-	
		10	806974.0	86.6	13	3	1466.0	1857.0	1775.0	
		11	161575.0	96.0	13	3	1934.0	1212.0	1962.0	
		12	369350.0	70.5	13	2	1164.0	1330.0	-	
		13	575300.0	89.4	13	3	1329.0	1464.0	1671.0	

Type 5 Radar Waveform_28

Download	28	Type 5	9	1.3333333	12.0000000	5.527000000				
		Burst ID	Burst Offset (us)	Pulse Width (us)	Chirp Width (MHz)	Number of Pulses per Burst	PRI-1 (us)	PRI-2 (us)	PRI-3 (us)	
		0	1221997.0	61.9	6	1	1062.0	-	-	
		1	212647.0	67.6	6	2	1255.0	1036.0	-	
		2	535690.0	51.0	6	1	1735.0	-	-	
		3	858573.0	52.0	6	1	1847.0	-	-	
		4	1181680.0	64.0	6	1	1644.0	-	-	
		5	172958.0	65.2	6	1	1712.0	-	-	
		6	495639.0	72.8	6	2	1220.0	1242.0	-	
		7	817572.0	77.3	6	2	1950.0	1886.0	-	
		8	1139769.0	90.1	6	3	1144.0	1738.0	1244.0	

Type 5 Radar Waveform_29											
Download	29	Type 5	8	1.5000000	12.0000000	5.527000000					
		Burst ID	Burst Offset (us)	Pulse Width (us)	Chirp Width (MHz)	Number of Pulses per Burst	PRI-1 (us)	PRI-2 (us)	PRI-3 (us)		
		0	149911.0	56.8	6	1	1050.0	-	-		
		1	512778.0	82.5	6	2	1795.0	1227.0	-		
		2	876561.0	50.1	6	1	1794.0	-	-		
		3	1237526.0	94.0	6	3	1639.0	1940.0	1111.0		
		4	105097.0	56.1	6	1	1543.0	-	-		
		5	467655.0	85.5	6	3	1358.0	1423.0	1526.0		
		6	832097.0	60.8	6	1	1265.0	-	-		
		7	1195454.0	57.3	6	1	1433.0	-	-		



Radar Type 6 - Radar Statistical Performance			
Trail #	1=Detection 0=No Detection	Trail #	1=Detection 0=No Detection
0	1	15	1
1	1	16	1
2	1	17	1
3	1	18	1
4	1	19	1
5	1	20	1
6	1	21	1
7	1	22	1
8	1	23	1
9	1	24	1
10	1	25	1
11	1	26	1
12	1	27	1
13	1	28	1
14	1	29	1
Detection Percentage (%)		100%	

Type 6 Radar Waveform_0								
Download	0	Type 6	1.0	333.3	9	0.3333	300.000000	7
		Frequency List (MHz)	0	1	2	3	4	
		0	5552	5555	5350	5602	5510	
		5	5570	5336	5348	5288	5579	
		10	5424	5362	5693	5318	5257	
		15	5571	5279	5720	5383	5313	
		20	5696	5328	5454	5655	5470	
		25	5339	5334	5550	5305	5620	
		30	5373	5395	5293	5617	5637	
		35	5606	5663	5340	5721	5675	
		40	5580	5650	5325	5657	5714	
		45	5485	5365	5371	5440	5703	
		50	5530	5375	5370	5474	5448	
		55	5517	5479	5421	5583	5511	
		60	5393	5416	5691	5548	5275	
		65	5659	5398	5307	5390	5414	
		70	5368	5473	5529	5538	5447	
		75	5574	5532	5281	5527	5629	
		80	5723	5544	5516	5492	5460	
		85	5632	5534	5581	5359	5557	
		90	5250	5437	5292	5646	5308	
		95	5349	5644	5284	5666	5321	

Type 6 Radar Waveform_1

Download	1	Type 6	1.0	333.3	9	0.3333	300.0000000	9
		Frequency List (MHz)	0	1	2	3	4	
		0	5710	5319	5286	5288	5352	
		5	5612	5261	5423	5354	5408	
		10	5355	5723	5259	5416	5278	
		15	5562	5406	5348	5428	5505	
		20	5704	5397	5395	5647	5443	
		25	5702	5661	5506	5654	5649	
		30	5444	5330	5610	5445	5437	
		35	5679	5459	5493	5635	5514	
		40	5663	5588	5565	5546	5465	
		45	5448	5429	5396	5309	5551	
		50	5421	5660	5271	5461	5570	
		55	5375	5676	5264	5425	5581	
		60	5258	5643	5471	5318	5608	
		65	5434	5614	5692	5440	5629	
		70	5446	5652	5424	5605	5385	
		75	5504	5439	5607	5513	5474	
		80	5334	5542	5555	5597	5488	
		85	5257	5422	5494	5510	5701	
		90	5681	5328	5451	5367	5282	
		95	5403	5316	5577	5500	5662	

Type 6 Radar Waveform_2

Download	2	Type 6	1.0	333.3	9	0.3333	300.0000000	10
		Frequency List (MHz)	0	1	2	3	4	
		0	5490	5558	5697	5449	5572	
		5	5654	5283	5498	5517	5615	
		10	5286	5512	5300	5611	5299	
		15	5650	5436	5354	5473	5712	
		20	5563	5336	5261	5416	5590	
		25	5513	5481	5610	5688	5691	
		30	5333	5287	5253	5694	5257	
		35	5343	5410	5352	5646	5549	
		40	5450	5368	5526	5330	5651	
		45	5475	5445	5531	5390	5380	
		50	5660	5252	5472	5274	5308	
		55	5329	5391	5624	5710	5554	
		60	5271	5678	5297	5264	5389	
		65	5557	5373	5349	5552	5398	
		70	5609	5542	5632	5656	5365	
		75	5415	5675	5470	5586	5658	
		80	5495	5285	5506	5292	5510	
		85	5382	5377	5273	5505	5272	
		90	5465	5539	5426	5428	5528	
		95	5392	5423	5281	5455	5579	

Type 6 Radar Waveform_3

Download	3	Type 6	1.0	333.3	9	0.3333	300.0000000	9
		Frequency List (MHz)	0	1	2	3	4	
		0	5270	5322	5633	5610	5414	
		5	5696	5683	5573	5680	5347	
		10	5595	5301	5341	5331	5320	
		15	5263	5563	5457	5421	5623	
		20	5632	5374	5253	5389	5381	
		25	5462	5587	5714	5722	5258	
		30	5319	5719	5466	5371	5455	
		35	5482	5501	5560	5289	5451	
		40	5367	5473	5307	5425	5614	
		45	5448	5502	5645	5536	5428	
		50	5523	5363	5295	5252	5471	
		55	5283	5581	5443	5681	5436	
		60	5404	5695	5685	5687	5506	
		65	5409	5656	5676	5528	5257	
		70	5505	5466	5324	5287	5613	
		75	5567	5435	5508	5541	5670	
		80	5355	5507	5577	5377	5590	
		85	5565	5430	5493	5278	5672	
		90	5591	5434	5465	5274	5667	
		95	5440	5336	5439	5477	5664	

Type 6 Radar Waveform_4

Download	4	Type 6	1.0	333.3	9	0.3333	300.0000000	10
		Frequency List (MHz)	0	1	2	3	4	
		0	5525	5561	5569	5674	5634	
		5	5360	5705	5648	5368	5651	
		10	5526	5565	5382	5341	5351	
		15	5690	5560	5466	5606	5631	
		20	5323	5315	5342	5362	5269	
		25	5314	5343	5281	5397	5683	
		30	5676	5620	5275	5524	5592	
		35	5419	5574	5474	5603	5534	
		40	5305	5713	5267	5711	5405	
		45	5697	5506	5555	5532	5412	
		50	5604	5452	5593	5659	5712	
		55	5296	5640	5337	5601	5568	
		60	5521	5413	5552	5348	5391	
		65	5714	5479	5278	5514	5260	
		70	5354	5442	5283	5256	5440	
		75	5548	5590	5618	5322	5359	
		80	5418	5407	5297	5280	5529	
		85	5528	5559	5298	5544	5395	
		90	5537	5499	5301	5457	5520	
		95	5375	5546	5663	5583	5567	

Type 6 Radar Waveform_5

Download	5	Type 6	1.0	333.3	9	0.3333	300.0000000	12
		Frequency List (MHz)	0	1	2	3	4	
		0	5683	5325	5505	5360	5476	
		5	5402	5252	5723	5434	5383	
		10	5457	5354	5423	5721	5362	
		15	5342	5663	5511	5420	5639	
		20	5489	5256	5334	5335	5535	
		25	5263	5518	5544	5315	5439	
		30	5572	5633	5297	5473	5690	
		35	5388	5442	5617	5718	5478	
		40	5264	5640	5385	5305	5467	
		45	5608	5322	5666	5625	5541	
		50	5416	5372	5486	5459	5526	
		55	5466	5291	5610	5543	5347	
		60	5674	5614	5501	5364	5696	
		65	5509	5282	5447	5597	5678	
		70	5418	5717	5700	5560	5327	
		75	5529	5367	5631	5578	5523	
		80	5481	5404	5492	5658	5371	
		85	5588	5276	5498	5299	5446	
		90	5436	5313	5474	5504	5370	
		95	5525	5306	5565	5301	5546	

Type 6 Radar Waveform_6

Download	6	Type 6	1.0	333.3	9	0.3333	300.0000000	11
		Frequency List (MHz)	0	1	2	3	4	
		0	5463	5564	5441	5521	5696	
		5	5444	5652	5323	5597	5590	
		10	5291	5715	5464	5344	5383	
		15	5430	5469	5556	5612	5550	
		20	5558	5294	5423	5308	5721	
		25	5648	5349	5481	5541	5546	
		30	5293	5327	5396	5583	5502	
		35	5399	5281	5322	5656	5718	
		40	5261	5472	5268	5388	5525	
		45	5661	5684	5542	5676	5252	
		50	5617	5365	5560	5620	5278	
		55	5497	5595	5456	5555	5375	
		60	5270	5437	5450	5420	5433	
		65	5304	5519	5363	5527	5297	
		70	5572	5680	5373	5510	5619	
		75	5266	5359	5641	5401	5687	
		80	5658	5688	5551	5371	5606	
		85	5549	5547	5413	5611	5470	
		90	5422	5491	5501	5488	5504	
		95	5394	5601	5660	5513	5669	

Type 6 Radar Waveform_7

Download	7	Type 6	1.0	333.3	9	0.3333	300.0000000	9
		Frequency List (MHz)	0	1	2	3	4	
		0	5718	5425	5377	5682	5538	
		5	5583	5674	5398	5285	5419	
		10	5697	5504	5602	5539	5404	
		15	5518	5499	5297	5329	5558	
		20	5724	5710	5415	5281	5689	
		25	5442	5449	5277	5383	5523	
		30	5447	5547	5696	5491	5466	
		35	5487	5379	5665	5313	5692	
		40	5405	5594	5386	5258	5401	
		45	5723	5471	5617	5474	5418	
		50	5657	5252	5341	5440	5309	
		55	5651	5574	5391	5475	5468	
		60	5627	5621	5500	5304	5571	
		65	5566	5638	5399	5359	5285	
		70	5671	5266	5688	5569	5463	
		75	5279	5273	5635	5541	5703	
		80	5516	5396	5376	5615	5704	
		85	5561	5611	5563	5503	5320	
		90	5708	5301	5555	5434	5605	
		95	5556	5641	5497	5324	5280	

Type 6 Radar Waveform_8

Download	8	Type 6	1.0	333.3	9	0.3333	300.0000000	8
		Frequency List (MHz)	0	1	2	3	4	
		0	5498	5664	5313	5368	5283	
		5	5625	5599	5473	5448	5626	
		10	5531	5293	5643	5259	5425	
		15	5606	5400	5549	5521	5566	
		20	5318	5651	5504	5254	5577	
		25	5391	5555	5381	5417	5662	
		30	5336	5496	5472	5311	5508	
		35	5578	5650	5333	5702	5488	
		40	5532	5352	5708	5703	5554	
		45	5544	5670	5361	5294	5358	
		50	5303	5430	5263	5631	5364	
		55	5528	5484	5342	5281	5542	
		60	5611	5397	5609	5461	5348	
		65	5395	5475	5466	5285	5603	
		70	5724	5594	5413	5659	5648	
		75	5389	5396	5443	5292	5699	
		80	5464	5469	5574	5658	5439	
		85	5568	5431	5441	5440	5543	
		90	5622	5553	5539	5365	5600	
		95	5522	5278	5462	5418	5505	

Type 6 Radar Waveform_9

Download	9	Type 6	1.0	333.3	9	0.3333	300.000000	7
		Frequency List (MHz)	0	1	2	3	4	
		0	5278	5428	5724	5529	5600	
		5	5667	5621	5548	5514	5358	
		10	5462	5557	5684	5454	5446	
		15	5597	5503	5594	5713	5477	
		20	5484	5689	5496	5702	5465	
		25	5718	5283	5582	5451	5704	
		30	5322	5461	5711	5624	5606	
		35	5647	5669	5543	5583	5616	
		40	5370	5668	5470	5391	5349	
		45	5637	5683	5602	5723	5626	
		50	5534	5354	5519	5561	5575	
		55	5552	5482	5674	5588	5313	
		60	5410	5476	5487	5443	5320	
		65	5555	5662	5297	5334	5307	
		70	5347	5638	5469	5452	5700	
		75	5553	5382	5468	5705	5453	
		80	5328	5499	5652	5607	5355	
		85	5295	5419	5464	5311	5634	
		90	5375	5404	5508	5719	5251	
		95	5631	5664	5475	5639	5666	

Type 6 Radar Waveform_10

Download	10	Type 6	1.0	333.3	9	0.3333	300.000000	8
		Frequency List (MHz)	0	1	2	3	4	
		0	5436	5667	5660	5690	5345	
		5	5709	5546	5623	5677	5662	
		10	5393	5346	5250	5552	5467	
		15	5685	5405	5606	5542	5430	
		20	5485	5553	5630	5585	5675	
		25	5256	5486	5686	5271	5418	
		30	5354	5398	5329	5311	5285	
		35	5339	5261	5627	5684	5276	
		40	5631	5566	5663	5720	5301	
		45	5513	5424	5710	5705	5287	
		50	5422	5265	5389	5407	5284	
		55	5539	5641	5432	5275	5621	
		60	5501	5721	5370	5517	5628	
		65	5625	5526	5624	5569	5676	
		70	5512	5254	5588	5373	5434	
		75	5580	5609	5433	5674	5515	
		80	5292	5614	5367	5597	5567	
		85	5272	5559	5492	5449	5321	
		90	5670	5412	5582	5664	5656	
		95	5521	5335	5701	5331	5540	

Type 6 Radar Waveform_11

Download	11	Type 6	1.0	333.3	9	0.3333	300.0000000	6
		Frequency List (MHz)	0	1	2	3	4	
		0	5691	5431	5596	5279	5662	
		5	5373	5568	5698	5365	5394	
		10	5702	5707	5291	5272	5488	
		15	5298	5532	5709	5587	5622	
		20	5493	5719	5571	5577	5648	
		25	5619	5519	5689	5315	5410	
		30	5672	5375	5569	5550	5624	
		35	5450	5473	5610	5414	5541	
		40	5620	5359	5724	5299	5343	
		45	5398	5643	5328	5621	5354	
		50	5303	5300	5411	5456	5319	
		55	5585	5366	5453	5293	5579	
		60	5604	5255	5668	5331	5377	
		65	5679	5544	5447	5686	5670	
		70	5406	5349	5520	5428	5695	
		75	5572	5528	5555	5471	5611	
		80	5419	5512	5357	5363	5578	
		85	5289	5334	5270	5567	5657	
		90	5712	5513	5265	5647	5486	
		95	5676	5446	5367	5295	5301	

Type 6 Radar Waveform_12

Download	12	Type 6	1.0	333.3	9	0.3333	300.0000000	10
		Frequency List (MHz)	0	1	2	3	4	
		0	5471	5670	5532	5440	5407	
		5	5415	5493	5298	5528	5601	
		10	5633	5496	5332	5467	5509	
		15	5386	5562	5715	5632	5339	
		20	5404	5313	5609	5666	5621	
		25	5410	5371	5417	5419	5553	
		30	5452	5561	5309	5324	5347	
		35	5492	5564	5406	5664	5455	
		40	5459	5442	5662	5539	5340	
		45	5327	5623	5411	5679	5665	
		50	5651	5587	5507	5408	5688	
		55	5641	5722	5294	5423	5604	
		60	5700	5511	5370	5490	5412	
		65	5619	5345	5559	5315	5292	
		70	5596	5672	5377	5531	5430	
		75	5570	5256	5257	5470	5527	
		80	5286	5626	5270	5506	5620	
		85	5379	5580	5513	5682	5383	
		90	5724	5312	5356	5586	5703	
		95	5537	5558	5360	5639	5449	

Type 6 Radar Waveform_13

Download	13	Type 6	1.0	333.3	9	0.3333	300.0000000	8
		Frequency List (MHz)	0	1	2	3	4	
		0	5251	5434	5488	5601	5724	
		5	5457	5515	5373	5691	5430	
		10	5564	5285	5682	5530	5377	
		15	5689	5343	5677	5628	5412	
		20	5479	5550	5658	5594	5298	
		25	5320	5523	5587	5494	5450	
		30	5667	5524	5476	5642	5631	
		35	5655	5299	5342	5466	5622	
		40	5600	5304	5634	5506	5262	
		45	5363	5455	5288	5558	5497	
		50	5706	5632	5257	5676	5484	
		55	5717	5575	5354	5661	5364	
		60	5671	5436	5710	5568	5381	
		65	5391	5585	5679	5675	5701	
		70	5507	5389	5539	5376	5608	
		75	5474	5386	5270	5326	5283	
		80	5346	5648	5348	5680	5571	
		85	5448	5518	5286	5665	5341	
		90	5310	5417	5606	5419	5329	
		95	5411	5570	5444	5640	5281	

Type 6 Radar Waveform_14

Download	14	Type 6	1.0	333.3	9	0.3333	300.0000000	9
		Frequency List (MHz)	0	1	2	3	4	
		0	5409	5673	5404	5287	5469	
		5	5499	5440	5448	5282	5637	
		10	5398	5549	5414	5382	5551	
		15	5465	5341	5446	5625	5345	
		20	5420	5548	5491	5272	5567	
		25	5564	5647	5251	5724	5621	
		30	5633	5436	5624	5642	5250	
		35	5365	5295	5271	5570	5495	
		40	5380	5612	5705	5538	5447	
		45	5431	5563	5486	5577	5698	
		50	5416	5342	5306	5464	5609	
		55	5586	5432	5479	5445	5630	
		60	5674	5439	5546	5483	5351	
		65	5309	5650	5594	5517	5320	
		70	5601	5477	5690	5533	5665	
		75	5300	5550	5348	5508	5496	
		80	5276	5455	5638	5507	5283	
		85	5389	5280	5541	5643	5666	
		90	5413	5472	5534	5485	5506	
		95	5316	5354	5391	5528	5346	

Type 6 Radar Waveform_15

Download	15	Type 6	1.0	333.3	9	0.3333	300.0000000	6
		Frequency List (MHz)	0	1	2	3	4	
		0	5664	5437	5340	5448	5311	
		5	5638	5462	5523	5445	5369	
		10	5329	5338	5552	5480	5572	
		15	5553	5468	5549	5670	5537	
		20	5331	5714	5432	5264	5540	
		25	5452	5596	5454	5353	5655	
		30	5675	5325	5581	5382	5402	
		35	5660	5337	5362	5366	5648	
		40	5294	5451	5313	5476	5687	
		45	5428	5492	5466	5281	5469	
		50	5607	5657	5640	5297	5255	
		55	5423	5633	5584	5292	5258	
		60	5517	5612	5516	5254	5482	
		65	5420	5425	5259	5356	5433	
		70	5272	5493	5605	5651	5303	
		75	5399	5459	5307	5380	5616	
		80	5322	5436	5318	5490	5288	
		85	5447	5261	5551	5604	5703	
		90	5383	5683	5671	5388	5273	
		95	5637	5460	5521	5635	5397	

Type 6 Radar Waveform_16

Download	16	Type 6	1.0	333.3	9	0.3333	300.0000000	7
		Frequency List (MHz)	0	1	2	3	4	
		0	5444	5676	5276	5609	5531	
		5	5680	5387	5598	5608	5576	
		10	5638	5699	5593	5675	5641	
		15	5595	5652	5715	5254	5339	
		20	5405	5470	5353	5513	5340	
		25	5448	5657	5457	5689	5717	
		30	5538	5597	5651	5480	5476	
		35	5453	5259	5423	5305	5493	
		40	5414	5452	5425	5324	5446	
		45	5268	5522	5494	5436	5341	
		50	5711	5386	5553	5270	5346	
		55	5482	5552	5391	5266	5681	
		60	5296	5411	5721	5371	5480	
		65	5415	5392	5643	5639	5299	
		70	5403	5626	5435	5349	5465	
		75	5417	5570	5503	5544	5611	
		80	5515	5456	5454	5666	5478	
		85	5477	5458	5361	5328	5422	
		90	5533	5649	5619	5295	5284	
		95	5474	5497	5369	5258	5273	

Type 6 Radar Waveform_17

Download	17	Type 6	1.0	333.3	9	0.3333	300.0000000	6
		Frequency List (MHz)	0	1	2	3	4	
		0	5699	5440	5687	5295	5373	
		5	5722	5409	5673	5296	5405	
		10	5569	5488	5634	5395	5614	
		15	5632	5625	5658	5285	5446	
		20	5347	5474	5411	5345	5486	
		25	5606	5300	5385	5561	5723	
		30	5381	5675	5495	5337	5328	
		35	5678	5615	5641	5530	5576	
		40	5694	5701	5352	5692	5422	
		45	5253	5426	5351	5575	5284	
		50	5312	5517	5287	5475	5376	
		55	5689	5534	5492	5672	5371	
		60	5362	5716	5718	5644	5317	
		65	5283	5364	5331	5434	5574	
		70	5720	5406	5314	5700	5696	
		75	5608	5398	5613	5325	5649	
		80	5273	5357	5288	5629	5670	
		85	5589	5528	5706	5526	5431	
		90	5359	5415	5494	5631	5668	
		95	5263	5577	5695	5464	5470	

Type 6 Radar Waveform_18

Download	18	Type 6	1.0	333.3	9	0.3333	300.0000000	7
		Frequency List (MHz)	0	1	2	3	4	
		0	5479	5679	5623	5456	5593	
		5	5289	5334	5273	5362	5612	
		10	5500	5277	5675	5590	5635	
		15	5720	5286	5708	5638	5258	
		20	5640	5352	5434	5459	5494	
		25	5724	5491	5287	5660	5423	
		30	5564	5452	5455	5577	5498	
		35	5279	5257	5326	5254	5608	
		40	5540	5659	5668	5360	5516	
		45	5560	5406	5358	5628	5646	
		50	5663	5596	5338	5536	5722	
		55	5446	5387	5568	5333	5427	
		60	5661	5550	5470	5263	5484	
		65	5313	5367	5685	5704	5280	
		70	5706	5409	5324	5290	5665	
		75	5404	5654	5379	5599	5723	
		80	5581	5468	5357	5702	5689	
		85	5554	5482	5521	5691	5437	
		90	5393	5295	5511	5686	5684	
		95	5620	5680	5418	5559	5682	

Type 6 Radar Waveform_19

Download	19	Type 6	1.0	333.3	9	0.3333	300.0000000	8
		Frequency List (MHz)	0	1	2	3	4	
		0	5637	5443	5559	5520	5435	
		5	5428	5356	5348	5525	5344	
		10	5334	5541	5716	5310	5656	
		15	5333	5404	5389	5278	5355	
		20	5268	5709	5390	5426	5432	
		25	5285	5576	5694	5391	5465	
		30	5453	5409	5670	5254	5696	
		35	5321	5597	5504	5619	5379	
		40	5267	5606	5600	5513	5489	
		45	5289	5517	5416	5584	5436	
		50	5539	5297	5275	5400	5480	
		55	5577	5387	5304	5556	5701	
		60	5382	5393	5306	5685	5262	
		65	5403	5596	5558	5612	5692	
		70	5509	5648	5618	5537	5524	
		75	5322	5360	5376	5261	5362	
		80	5531	5326	5643	5663	5260	
		85	5544	5652	5482	5422	5533	
		90	5252	5719	5381	5330	5557	
		95	5528	5668	5561	5599	5308	

Type 6 Radar Waveform_20

Download	20	Type 6	1.0	333.3	9	0.3333	300.0000000	14
		Frequency List (MHz)	0	1	2	3	4	
		0	5417	5682	5495	5681	5655	
		5	5470	5261	5423	5688	5648	
		10	5265	5330	5282	5408	5677	
		15	5421	5531	5492	5323	5547	
		20	5274	5400	5331	5515	5405	
		25	5525	5422	5253	5507	5439	
		30	5366	5410	5503	5516	5460	
		35	5490	5657	5533	5315	5447	
		40	5544	5365	5510	5418	5269	
		45	5600	5377	5637	5318	5473	
		50	5440	5364	5698	5327	5526	
		55	5354	5292	5653	5685	5391	
		60	5689	5694	5252	5508	5686	
		65	5342	5349	5361	5306	5300	
		70	5512	5717	5577	5506	5368	
		75	5438	5371	5618	5695	5486	
		80	5543	5383	5638	5386	5712	
		85	5674	5387	5487	5500	5539	
		90	5546	5449	5513	5642	5321	
		95	5459	5461	5411	5436	5652	

Type 6 Radar Waveform_21

Download	21	Type 6	1.0	333.3	9	0.3333	300.0000000	10
		Frequency List (MHz)	0	1	2	3	4	
		0	5672	5446	5431	5367	5497	
		5	5512	5303	5498	5376	5380	
		10	5671	5594	5323	5603	5698	
		15	5412	5658	5595	5271	5361	
		20	5660	5469	5272	5507	5378	
		25	5439	5377	5625	5599	5287	
		30	5646	5328	5655	5714	5530	
		35	5286	5335	5447	5629	5482	
		40	5605	5250	5724	5683	5435	
		45	5690	5588	5669	5649	5491	
		50	5453	5521	5308	5403	5624	
		55	5339	5556	5593	5618	5520	
		60	5673	5709	5635	5559	5283	
		65	5639	5612	5693	5536	5667	
		70	5511	5419	5481	5399	5384	
		75	5549	5540	5675	5638	5325	
		80	5294	5255	5538	5273	5262	
		85	5711	5455	5301	5699	5525	
		90	5659	5279	5258	5357	5460	
		95	5514	5634	5368	5354	5558	

Type 6 Radar Waveform_22

Download	22	Type 6	1.0	333.3	9	0.3333	300.0000000	9
		Frequency List (MHz)	0	1	2	3	4	
		0	5452	5307	5367	5528	5717	
		5	5554	5703	5573	5442	5587	
		10	5505	5480	5364	5323	5719	
		15	5500	5688	5601	5316	5553	
		20	5668	5635	5310	5596	5351	
		25	5327	5704	5353	5325	5321	
		30	5314	5280	5268	5429	5534	
		35	5641	5718	5557	5585	5458	
		40	5468	5613	5420	5273	5504	
		45	5654	5291	5493	5475	5545	
		50	5350	5542	5722	5593	5427	
		55	5262	5575	5697	5595	5721	
		60	5538	5450	5443	5716	5532	
		65	5584	5317	5391	5547	5272	
		70	5615	5669	5495	5347	5312	
		75	5400	5560	5494	5655	5451	
		80	5612	5537	5395	5541	5642	
		85	5260	5486	5695	5492	5521	
		90	5401	5558	5335	5581	5634	
		95	5676	5334	5255	5342	5617	

Type 6 Radar Waveform_23

Download	23	Type 6	1.0	333.3	9	0.3333	300.0000000	6
		Frequency List (MHz)	0	1	2	3	4	
		0	5610	5546	5303	5689	5462	
		5	5693	5250	5648	5605	5416	
		10	5436	5269	5502	5518	5265	
		15	5588	5340	5704	5361	5270	
		20	5676	5251	5324	5593	5653	
		25	5459	5429	5355	5255	5678	
		30	5712	5483	5581	5257	5305	
		35	5334	5450	5263	5372	5307	
		40	5696	5358	5513	5598	5486	
		45	5684	5374	5454	5321	5421	
		50	5526	5253	5545	5537	5615	
		55	5594	5290	5516	5469	5500	
		60	5411	5580	5282	5662	5258	
		65	5533	5353	5601	5348	5623	
		70	5619	5715	5422	5548	5316	
		75	5432	5700	5381	5337	5604	
		80	5675	5534	5590	5444	5698	
		85	5563	5543	5294	5280	5566	
		90	5564	5272	5366	5268	5389	
		95	5323	5628	5720	5652	5365	

Type 6 Radar Waveform_24

Download	24	Type 6	1.0	333.3	9	0.3333	300.0000000	7
		Frequency List (MHz)	0	1	2	3	4	
		0	5390	5310	5714	5375	5304	
		5	5260	5650	5723	5293	5623	
		10	5367	5533	5543	5713	5286	
		15	5676	5467	5332	5406	5462	
		20	5587	5395	5667	5677	5297	
		25	5481	5505	5662	5389	5394	
		30	5567	5669	5698	5355	5552	
		35	5444	5425	5721	5416	5621	
		40	5401	5296	5278	5595	5415	
		45	5664	5457	5512	5374	5627	
		50	5675	5702	5644	5342	5368	
		55	5384	5328	5548	5480	5335	
		60	5440	5629	5576	5525	5589	
		65	5570	5608	5556	5482	5433	
		70	5715	5426	5691	5341	5718	
		75	5271	5524	5413	5663	5362	
		80	5617	5314	5360	5531	5423	
		85	5283	5298	5528	5497	5445	
		90	5478	5256	5306	5280	5307	
		95	5678	5348	5460	5529	5639	

Type 6 Radar Waveform_25

Download	25	Type 6	1.0	333.3	9	0.3333	300.0000000	13
		Frequency List (MHz)	0	1	2	3	4	
		0	5645	5549	5272	5536	5524	
		5	5302	5672	5323	5456	5355	
		10	5676	5322	5584	5336	5307	
		15	5667	5594	5435	5354	5654	
		20	5595	5464	5705	5669	5270	
		25	5369	5454	5390	5637	5423	
		30	5436	5553	5626	5438	5507	
		35	5372	5583	5516	5517	5666	
		40	5297	5557	5484	5709	5421	
		45	5592	5344	5547	5540	5570	
		50	5330	5417	5551	5403	5695	
		55	5431	5328	5502	5670	5532	
		60	5411	5283	5266	5470	5518	
		65	5493	5554	5282	5643	5510	
		70	5704	5385	5327	5343	5498	
		75	5500	5632	5575	5414	5269	
		80	5252	5468	5505	5347	5265	
		85	5721	5490	5396	5451	5693	
		90	5298	5576	5340	5605	5389	
		95	5349	5499	5291	5521	5657	

Type 6 Radar Waveform_26

Download	26	Type 6	1.0	333.3	9	0.3333	300.0000000	9
		Frequency List (MHz)	0	1	2	3	4	
		0	5425	5313	5683	5600	5366	
		5	5344	5597	5398	5522	5659	
		10	5607	5586	5625	5531	5328	
		15	5280	5721	5538	5399	5371	
		20	5603	5630	5646	5283	5718	
		25	5635	5306	5593	5363	5457	
		30	5478	5442	5583	5556	5281	
		35	5570	5686	5396	5567	5550	
		40	5661	5589	5651	5527	5623	
		45	5383	5682	5427	5579	5271	
		50	5520	5392	5650	5456	5385	
		55	5351	5382	5412	5431	5415	
		60	5350	5319	5580	5380	5364	
		65	5475	5402	5507	5346	5347	
		70	5476	5331	5504	5695	5557	
		75	5324	5521	5362	5535	5486	
		80	5428	5322	5250	5679	5585	
		85	5361	5502	5466	5496	5277	
		90	5390	5498	5554	5372	5419	
		95	5636	5393	5553	5472	5606	

Type 6 Radar Waveform_27

Download	27	Type 6	1.0	333.3	9	0.3333	300.0000000	9
		Frequency List (MHz)	0	1	2	3	4	
		0	5680	5552	5619	5286	5586	
		5	5483	5473	5685	5391	5441	
		10	5472	5666	5251	5349	5368	
		15	5276	5544	5444	5563	5514	
		20	5321	5587	5275	5691	5523	
		25	5633	5467	5491	5617	5331	
		30	5540	5296	5433	5390	5289	
		35	5698	5681	5497	5600	5710	
		40	5272	5488	5426	5580	5507	
		45	5706	5589	5436	5569	5303	
		50	5280	5322	5609	5690	5594	
		55	5320	5410	5575	5645	5256	
		60	5541	5596	5457	5657	5717	
		65	5543	5306	5329	5672	5310	
		70	5626	5299	5671	5452	5290	
		75	5340	5603	5305	5298	5375	
		80	5607	5699	5646	5425	5517	
		85	5250	5521	5269	5302	5704	
		90	5456	5714	5316	5311	5510	
		95	5383	5356	5317	5518	5591	

Type 6 Radar Waveform_28

Download	28	Type 6	1.0	333.3	9	0.3333	300.0000000	13
		Frequency List (MHz)	0	1	2	3	4	
		0	5363	5316	5555	5447	5428	
		5	5525	5544	5548	5373	5598	
		10	5372	5261	5707	5446	5370	
		15	5456	5403	5647	5489	5280	
		20	5522	5390	5528	5364	5664	
		25	5314	5582	5427	5571	5659	
		30	5317	5497	5511	5682	5588	
		35	5411	5477	5272	5611	5549	
		40	5355	5426	5666	5583	5412	
		45	5487	5359	5557	5320	5513	
		50	5441	5508	5290	5367	5702	
		55	5670	5286	5402	5543	5507	
		60	5278	5339	5517	5467	5491	
		65	5698	5382	5449	5520	5627	
		70	5345	5460	5271	5550	5485	
		75	5388	5709	5422	5712	5628	
		80	5329	5494	5669	5514	5691	
		85	5723	5532	5619	5400	5340	
		90	5690	5663	5266	5462	5254	
		95	5303	5634	5461	5642	5448	

Type 6 Radar Waveform_29								
Download	29	Type 6	1.0	333.3	9	0.3333	300.000000	4
		Frequency List (MHz)	0	1	2	3	4	
		0	5618	5555	5491	5608	5648	
		5	5567	5566	5623	5536	5427	
		10	5303	5525	5273	5641	5391	
		15	5447	5530	5275	5437	5569	
		20	5556	5356	5259	5677	5434	
		25	5630	5675	5559	5701	5681	
		30	5454	5251	5456	5408	5470	
		35	5502	5425	5485	5438	5364	
		40	5334	5341	5467	5397	5705	
		45	5542	5721	5433	5632	5424	
		50	5409	5336	5385	5696	5318	
		55	5383	5661	5673	5702	5451	
		60	5347	5321	5369	5532	5330	
		65	5375	5252	5359	5294	5392	
		70	5368	5452	5307	5586	5314	
		75	5580	5317	5327	5595	5644	
		80	5552	5297	5419	5432	5531	
		85	5302	5292	5589	5537	5461	
		90	5260	5606	5697	5282	5414	
		95	5253	5514	5719	5421	5588	

Test Site	SIP-TR2	Test Engineer	Alisa Deng
Test Date	2022/04/10		
Test Item	Radar Statistical Performance Check (802.11ac-VHT80 – 5530MHz)		

Radar Type 1-4 - Radar Statistical Performance								
Trial	Radar Type 1		Radar Type 2		Radar Type 3		Radar Type 4	
	Frequency (MHz)	1=detect 0=no detect	Frequency (MHz)	1=detect 0=no detect	Frequency (MHz)	1=detect 0=no detect	Frequency (MHz)	1=detect 0=no detect
0	5559	1	5551	1	5517	1	5490	1
1	5518	1	5553	1	5502	1	5498	1
2	5559	1	5570	1	5530	1	5559	1
3	5490	1	5564	1	5515	1	5549	1
4	5563	1	5536	1	5542	1	5493	1
5	5530	1	5502	1	5498	1	5515	1
6	5493	1	5507	1	5530	1	5548	1
7	5497	1	5565	0	5530	1	5566	1
8	5527	1	5511	1	5517	1	5539	1
9	5498	1	5510	1	5492	1	5552	1
10	5499	1	5564	1	5556	1	5543	1
11	5496	1	5518	1	5512	1	5508	0
12	5560	1	5514	1	5494	1	5496	0
13	5514	1	5548	0	5565	1	5551	1
14	5534	1	5530	1	5526	1	5501	1
15	5559	1	5505	0	5503	1	5495	0
16	5568	1	5511	1	5556	1	5560	1
17	5558	1	5491	1	5567	1	5540	1
18	5547	1	5541	1	5515	1	5533	1
19	5535	1	5559	1	5555	1	5556	1
20	5507	1	5490	1	5516	1	5492	1
21	5518	1	5533	0	5562	1	5566	1
22	5501	1	5536	1	5570	1	5546	0
23	5518	1	5539	1	5521	1	5548	1
24	5506	1	5565	1	5515	1	5502	1
25	5542	1	5556	1	5507	1	5552	0
26	5542	1	5512	0	5503	1	5545	1

Radar Type 1-4 - Radar Statistical Performance								
Trial	Radar Type 1		Radar Type 2		Radar Type 3		Radar Type 4	
	Frequency (MHz)	1=detect 0=no detect	Frequency (MHz)	1=detect 0=no detect	Frequency (MHz)	1=detect 0=no detect	Frequency (MHz)	1=detect 0=no detect
27	5555	1	5502	0	5490	0	5508	0
28	5496	1	5525	1	5493	1	5530	1
29	5570	1	5547	1	5538	1	5570	1
Probability:	100.0%		80.0%		96.7%		80.0%	
Aggregate:	$P_{Aggregate}=(P_1+P_2+P_3+P_4)/4=(100.0\%+80.0\%+96.7\%+80.0\%)/4=89.18\% (>80\%)$							

Radar Type 1 - Radar Waveform							Radar Type 2 - Radar Waveform						
Trial List							Trial List						
	Trial Id	Radar Type	Pulse Width (us)	PRI (us)	Number of Pulses	Waveform Length (us)		Trial Id	Radar Type	Pulse Width (us)	PRI (us)	Number of Pulses	Waveform Length (us)
Download	0	Type 1	1.0	778.0	68	52904.0	Download	0	Type 2	2.6	220.0	25	5500.0
Download	1	Type 1	1.0	738.0	72	53136.0	Download	1	Type 2	1.5	228.0	23	5244.0
Download	2	Type 1	1.0	578.0	92	53176.0	Download	2	Type 2	3.2	180.0	26	4680.0
Download	3	Type 1	1.0	538.0	99	53262.0	Download	3	Type 2	2.4	175.0	25	4375.0
Download	4	Type 1	1.0	838.0	63	52794.0	Download	4	Type 2	3.9	210.0	27	5670.0
Download	5	Type 1	1.0	658.0	81	53296.0	Download	5	Type 2	4.7	151.0	29	4379.0
Download	6	Type 1	1.0	618.0	86	53148.0	Download	6	Type 2	1.5	170.0	23	3910.0
Download	7	Type 1	1.0	3066.0	18	55188.0	Download	7	Type 2	4.2	209.0	28	5652.0
Download	8	Type 1	1.0	598.0	89	53222.0	Download	8	Type 2	4.1	195.0	28	5460.0
Download	9	Type 1	1.0	818.0	65	53170.0	Download	9	Type 2	3.7	202.0	27	5454.0
Download	10	Type 1	1.0	678.0	78	52884.0	Download	10	Type 2	2.5	152.0	25	3800.0
Download	11	Type 1	1.0	878.0	61	53558.0	Download	11	Type 2	2.1	207.0	24	4968.0
Download	12	Type 1	1.0	718.0	74	53132.0	Download	12	Type 2	1.3	167.0	23	3841.0
Download	13	Type 1	1.0	518.0	102	52836.0	Download	13	Type 2	2.8	196.0	26	5096.0
Download	14	Type 1	1.0	638.0	83	52954.0	Download	14	Type 2	3.4	183.0	27	4941.0
Download	15	Type 1	1.0	820.0	65	53300.0	Download	15	Type 2	2.4	187.0	25	4675.0
Download	16	Type 1	1.0	2796.0	19	53124.0	Download	16	Type 2	1.7	153.0	24	3672.0
Download	17	Type 1	1.0	987.0	54	53298.0	Download	17	Type 2	1.5	224.0	23	5152.0
Download	18	Type 1	1.0	1349.0	40	53960.0	Download	18	Type 2	2.2	225.0	25	5625.0
Download	19	Type 1	1.0	2203.0	24	52872.0	Download	19	Type 2	1.8	161.0	24	3864.0
Download	20	Type 1	1.0	1773.0	30	53190.0	Download	20	Type 2	1.5	191.0	23	4393.0
Download	21	Type 1	1.0	1062.0	50	53100.0	Download	21	Type 2	2.9	223.0	26	5798.0
Download	22	Type 1	1.0	1218.0	44	53592.0	Download	22	Type 2	3.1	218.0	26	5668.0
Download	23	Type 1	1.0	2742.0	20	54840.0	Download	23	Type 2	2.8	206.0	26	5356.0
Download	24	Type 1	1.0	1129.0	47	53063.0	Download	24	Type 2	2.8	199.0	26	5174.0
Download	25	Type 1	1.0	1400.0	38	53200.0	Download	25	Type 2	2.7	203.0	25	5075.0
Download	26	Type 1	1.0	531.0	100	53100.0	Download	26	Type 2	1.0	198.0	23	4554.0
Download	27	Type 1	1.0	1106.0	48	53088.0	Download	27	Type 2	4.7	174.0	29	5046.0
Download	28	Type 1	1.0	2402.0	22	52844.0	Download	28	Type 2	4.4	221.0	28	6188.0
Download	29	Type 1	1.0	2778.0	19	52782.0	Download	29	Type 2	2.0	166.0	24	3984.0



Radar Type 3 - Radar Waveform							Radar Type 4 - Radar Waveform						
Trial List							Trial List						
	Trial Id	Radar Type	Pulse Width (us)	PRI (us)	Number of Pulses	Waveform Length (us)		Trial Id	Radar Type	Pulse Width (us)	PRI (us)	Number of Pulses	Waveform Length (us)
Download	0	Type 3	7.6	296.0	17	5032.0	Download	0	Type 4	14.7	296.0	14	4144.0
Download	1	Type 3	6.5	333.0	16	5328.0	Download	1	Type 4	12.1	333.0	12	3996.0
Download	2	Type 3	8.2	331.0	17	5627.0	Download	2	Type 4	16.0	331.0	14	4634.0
Download	3	Type 3	7.4	212.0	17	3604.0	Download	3	Type 4	14.1	212.0	13	2756.0
Download	4	Type 3	8.9	247.0	18	4446.0	Download	4	Type 4	17.4	247.0	15	3705.0
Download	5	Type 3	9.7	450.0	18	8100.0	Download	5	Type 4	19.3	450.0	16	7200.0
Download	6	Type 3	6.5	227.0	16	3632.0	Download	6	Type 4	12.1	227.0	12	2724.0
Download	7	Type 3	9.2	338.0	18	6084.0	Download	7	Type 4	18.1	338.0	15	5070.0
Download	8	Type 3	9.1	245.0	18	4410.0	Download	8	Type 4	18.0	245.0	15	3675.0
Download	9	Type 3	8.7	325.0	18	5850.0	Download	9	Type 4	17.1	325.0	15	4875.0
Download	10	Type 3	7.5	203.0	17	3451.0	Download	10	Type 4	14.5	203.0	13	2839.0
Download	11	Type 3	7.1	218.0	16	3488.0	Download	11	Type 4	13.4	218.0	13	2834.0
Download	12	Type 3	6.3	201.0	16	3216.0	Download	12	Type 4	11.7	201.0	12	2412.0
Download	13	Type 3	7.8	423.0	17	7191.0	Download	13	Type 4	15.1	423.0	14	5922.0
Download	14	Type 3	8.4	500.0	17	8500.0	Download	14	Type 4	16.4	500.0	15	7500.0
Download	15	Type 3	7.4	311.0	17	5287.0	Download	15	Type 4	14.3	311.0	13	4043.0
Download	16	Type 3	6.7	381.0	16	6096.0	Download	16	Type 4	12.7	381.0	12	4572.0
Download	17	Type 3	6.5	485.0	16	7760.0	Download	17	Type 4	12.1	485.0	12	5820.0
Download	18	Type 3	7.2	417.0	16	6672.0	Download	18	Type 4	13.7	417.0	13	5421.0
Download	19	Type 3	6.8	371.0	16	5936.0	Download	19	Type 4	12.8	371.0	13	4823.0
Download	20	Type 3	6.5	264.0	16	4224.0	Download	20	Type 4	12.1	264.0	12	3168.0
Download	21	Type 3	7.9	347.0	17	5899.0	Download	21	Type 4	15.3	347.0	14	4858.0
Download	22	Type 3	8.1	483.0	17	8211.0	Download	22	Type 4	15.8	483.0	14	6762.0
Download	23	Type 3	7.8	419.0	17	7123.0	Download	23	Type 4	15.0	419.0	14	5866.0
Download	24	Type 3	7.8	489.0	17	8313.0	Download	24	Type 4	15.2	489.0	14	6846.0
Download	25	Type 3	7.7	283.0	17	4811.0	Download	25	Type 4	14.8	283.0	14	3962.0
Download	26	Type 3	6.0	254.0	16	4064.0	Download	26	Type 4	11.0	254.0	12	3048.0
Download	27	Type 3	9.7	473.0	18	8514.0	Download	27	Type 4	19.2	473.0	16	7568.0
Download	28	Type 3	9.4	380.0	18	6840.0	Download	28	Type 4	18.7	380.0	16	6080.0
Download	29	Type 3	7.0	445.0	16	7120.0	Download	29	Type 4	13.3	445.0	13	5785.0

Radar Type 5 - Radar Statistical Performance					
Trail #	Test Freq. (MHz)	1=Detection 0=No Detection	Trail #	Test Freq. (MHz)	1=Detection 0=No Detection
0	5530	1	15	5496	1
1	5530	0	16	5495	1
2	5530	1	17	5495	1
3	5530	1	18	5496	1
4	5530	1	19	5495	1
5	5530	1	20	5566	1
6	5530	1	21	5563	1
7	5530	1	22	5563	1
8	5530	1	23	5563	1
9	5530	1	24	5563	1
10	5496	1	25	5564	1
11	5496	1	26	5566	0
12	5494	1	27	5560	1
13	5497	1	28	5561	1
14	5498	1	29	5564	1
Detection Percentage (%)			93.3%		

Type 5 Radar Waveform_0										
Download	0	Type 5	13	0.9230769	12.0000000	5.530000000				
		Burst ID	Burst Offset (us)	Pulse Width (us)	Chirp Width (MHz)	Number of Pulses per Burst	PRI-1 (us)	PRI-2 (us)	PRI-3 (us)	
		0	602605.0	70.6	11	2	1346.0	1219.0	-	
		1	826661.0	56.1	11	1	1447.0	-	-	
		2	128538.0	77.6	11	2	1754.0	1249.0	-	
		3	351652.0	67.3	11	2	1862.0	1227.0	-	
		4	573839.0	85.5	11	3	1566.0	1885.0	1141.0	
		5	796191.0	95.8	11	3	1727.0	1620.0	1717.0	
		6	101263.0	56.4	11	1	1077.0	-	-	
		7	323448.0	89.1	11	3	1982.0	1337.0	1813.0	
		8	546592.0	88.7	11	3	1265.0	1267.0	1737.0	
		9	769315.0	83.9	11	3	1454.0	1351.0	1603.0	
		10	73596.0	69.3	11	2	1563.0	1047.0	-	
		11	297104.0	63.5	11	1	1787.0	-	-	
		12	520487.0	54.0	11	1	1890.0	-	-	

Type 5 Radar Waveform_1

Download	1	Type 5	9	1.3333333	12.0000000	5.530000000				
		Burst ID	Burst Offset (us)	Pulse Width (us)	Chirp Width (MHz)	Number of Pulses per Burst	PRI-1 (us)	PRI-2 (us)	PRI-3 (us)	
		0	1074397.0	73.1	6	2	1179.0	1714.0	-	
		1	66638.0	80.1	6	2	1157.0	1572.0	-	
		2	369203.0	68.3	6	2	1879.0	1356.0	-	
		3	712865.0	59.6	6	1	1233.0	-	-	
		4	1035605.0	56.4	6	1	1666.0	-	-	
		5	26906.0	65.0	6	1	1767.0	-	-	
		6	350044.0	60.1	6	1	1041.0	-	-	
		7	672936.0	56.1	6	1	1498.0	-	-	
		8	994807.0	73.9	6	2	1110.0	1914.0	-	

Type 5 Radar Waveform_2

Download	2	Type 5	15	0.8000000	12.0000000	5.530000000				
		Burst ID	Burst Offset (us)	Pulse Width (us)	Chirp Width (MHz)	Number of Pulses per Burst	PRI-1 (us)	PRI-2 (us)	PRI-3 (us)	
		0	789673.0	76.8	13	2	1292.0	1326.0	-	
		1	185692.0	72.2	13	2	1512.0	1061.0	-	
		2	378783.0	73.1	13	2	1867.0	1360.0	-	
		3	572101.0	71.3	13	2	1508.0	1613.0	-	
		4	767275.0	50.2	13	1	1136.0	-	-	
		5	161389.0	95.5	13	3	1840.0	1895.0	1205.0	
		6	354276.0	92.4	13	3	1948.0	1422.0	1436.0	
		7	549583.0	63.0	13	1	1248.0	-	-	
		8	739148.0	92.9	13	3	1871.0	1886.0	1960.0	
		9	137672.0	86.6	13	3	1464.0	1974.0	1301.0	
		10	332058.0	66.5	13	1	1105.0	-	-	
		11	524205.0	81.0	13	2	1728.0	1824.0	-	
		12	718210.0	69.1	13	2	1101.0	1517.0	-	
		13	114390.0	50.6	13	1	1413.0	-	-	
		14	308150.0	51.9	13	1	1215.0	-	-	

Type 5 Radar Waveform_3

Download	3	Type 5	12	1.0000000	12.0000000	5.530000000				
		Burst ID	Burst Offset (us)	Pulse Width (us)	Chirp Width (MHz)	Number of Pulses per Burst	PRI-1 (us)	PRI-2 (us)	PRI-3 (us)	
		0	627489.0	66.2	10	1	1296.0	-	-	
		1	868243.0	67.4	10	2	1568.0	1408.0	-	
		2	113213.0	64.2	10	1	1355.0	-	-	
		3	355384.0	58.0	10	1	1445.0	-	-	
		4	597754.0	56.0	10	1	1128.0	-	-	
		5	836892.0	93.5	10	3	1092.0	1795.0	1951.0	
		6	83202.0	78.7	10	2	1942.0	1532.0	-	
		7	324573.0	84.3	10	3	1530.0	1043.0	1876.0	
		8	566679.0	77.6	10	2	1367.0	1933.0	-	
		9	808665.0	76.5	10	2	1936.0	1050.0	-	
		10	53528.0	53.4	10	1	1671.0	-	-	
		11	294660.0	69.6	10	3	1149.0	1410.0	1793.0	

Type 5 Radar Waveform_4

Download	4	Type 5	17	0.7058824	12.0000000	5.530000000				
		Burst ID	Burst Offset (us)	Pulse Width (us)	Chirp Width (MHz)	Number of Pulses per Burst	PRI-1 (us)	PRI-2 (us)	PRI-3 (us)	
		0	378715.0	75.9	16	2	1648.0	1193.0	-	
		1	547926.0	92.8	16	3	1244.0	1474.0	1786.0	
		2	16663.0	68.5	16	2	1492.0	1766.0	-	
		3	187667.0	50.7	16	1	1096.0	-	-	
		4	358256.0	57.3	16	1	1773.0	-	-	
		5	526660.0	94.6	16	3	1453.0	1923.0	1544.0	
		6	696184.0	96.7	16	3	1580.0	1846.0	1979.0	
		7	166289.0	79.4	16	2	1308.0	1156.0	-	
		8	337434.0	55.3	16	1	1329.0	-	-	
		9	506640.0	94.2	16	3	1188.0	1271.0	1185.0	
		10	678832.0	64.1	16	1	1697.0	-	-	
		11	145019.0	95.6	16	3	1258.0	1231.0	1211.0	
		12	316328.0	61.0	16	1	1457.0	-	-	
		13	484761.0	96.7	16	3	1423.0	1583.0	1940.0	
		14	658519.0	75.6	16	2	1997.0	1066.0	-	
		15	123869.0	91.1	16	3	1139.0	1777.0	1762.0	
		16	294501.0	82.8	16	2	1415.0	1909.0	-	

Type 5 Radar Waveform_5

Download	5	Type 5	19	0.6315789	12.0000000	5.530000000				
		Burst ID	Burst Offset (us)	Pulse Width (us)	Chirp Width (MHz)	Number of Pulses per Burst	PRI-1 (us)	PRI-2 (us)	PRI-3 (us)	
		0	415018.0	97.0	19	3	1303.0	1761.0	1330.0	
		1	568655.0	73.1	19	2	1375.0	1332.0	-	
		2	92527.0	54.0	19	1	1190.0	-	-	
		3	244747.0	79.4	19	2	1570.0	1340.0	-	
		4	397820.0	66.4	19	1	1959.0	-	-	
		5	548904.0	93.4	19	3	1515.0	1073.0	1222.0	
		6	73221.0	89.0	19	3	1775.0	1716.0	1751.0	
		7	226297.0	50.7	19	1	1988.0	-	-	
		8	379289.0	52.0	19	1	1496.0	-	-	
		9	532037.0	50.1	19	1	1575.0	-	-	
		10	54737.0	80.5	19	2	1035.0	1596.0	-	
		11	206723.0	96.1	19	3	1768.0	1086.0	1458.0	
		12	358276.0	87.9	19	3	1857.0	1658.0	1805.0	
		13	510834.0	95.6	19	3	1543.0	1431.0	1525.0	
		14	35853.0	94.9	19	3	1401.0	1850.0	1026.0	
		15	187968.0	96.8	19	3	1256.0	1427.0	1679.0	
		16	341423.0	55.8	19	1	1901.0	-	-	
		17	494631.0	66.5	19	1	1274.0	-	-	
		18	17169.0	70.3	19	2	1140.0	1083.0	-	

Type 5 Radar Waveform_6

Download	6	Type 5	9	1.3333333	12.0000000	5.530000000				
		Burst ID	Burst Offset (us)	Pulse Width (us)	Chirp Width (MHz)	Number of Pulses per Burst	PRI-1 (us)	PRI-2 (us)	PRI-3 (us)	
		0	358988.0	74.3	7	2	1626.0	1196.0	-	
		1	681127.0	85.8	7	3	1482.0	1246.0	1170.0	
		2	1005552.0	59.2	7	1	1255.0	-	-	
		3	1325385.0	86.5	7	3	1046.0	1721.0	1735.0	
		4	319170.0	72.4	7	2	1521.0	1591.0	-	
		5	641842.0	71.2	7	2	1331.0	1675.0	-	
		6	962808.0	96.6	7	3	1874.0	1520.0	1929.0	
		7	1287462.0	72.0	7	2	1640.0	1027.0	-	
		8	279683.0	53.3	7	1	1911.0	-	-	

Type 5 Radar Waveform_7

Download	7	Type 5	18	0.6666667	12.0000000	5.530000000				
		Burst ID	Burst Offset (us)	Pulse Width (us)	Chirp Width (MHz)	Number of Pulses per Burst	PRI-1 (us)	PRI-2 (us)	PRI-3 (us)	
		0	300327.0	68.7	17	2	1434.0	1667.0	-	
		1	460622.0	97.1	17	3	1601.0	1037.0	1384.0	
		2	623369.0	59.4	17	1	1852.0	-	-	
		3	119558.0	67.8	17	2	1597.0	1554.0	-	
		4	280363.0	87.7	17	3	1148.0	1142.0	1143.0	
		5	442684.0	51.4	17	1	1229.0	-	-	
		6	601917.0	80.7	17	2	1864.0	1741.0	-	
		7	99939.0	53.4	17	1	1803.0	-	-	
		8	260407.0	99.5	17	3	1497.0	1057.0	1241.0	
		9	422877.0	60.1	17	1	1115.0	-	-	
		10	583728.0	59.5	17	1	1760.0	-	-	
		11	79731.0	99.4	17	3	1920.0	1004.0	1748.0	
		12	240892.0	79.6	17	2	1889.0	1113.0	-	
		13	400877.0	100.0	17	3	1192.0	1602.0	1817.0	
		14	564125.0	55.2	17	1	1452.0	-	-	
		15	60004.0	94.4	17	3	1204.0	1656.0	1262.0	
		16	221554.0	66.2	17	1	1535.0	-	-	
		17	382060.0	81.4	17	2	1122.0	1818.0	-	

Type 5 Radar Waveform_8

Download	8	Type 5	18	0.6666667	12.0000000	5.530000000				
		Burst ID	Burst Offset (us)	Pulse Width (us)	Chirp Width (MHz)	Number of Pulses per Burst	PRI-1 (us)	PRI-2 (us)	PRI-3 (us)	
		0	543586.0	67.5	17	2	1078.0	1189.0	-	
		1	40147.0	96.7	17	3	1896.0	1441.0	1839.0	
		2	201261.0	69.2	17	2	1785.0	1144.0	-	
		3	361228.0	96.8	17	3	1630.0	1608.0	1542.0	
		4	524338.0	55.1	17	1	1505.0	-	-	
		5	20455.0	80.2	17	2	1033.0	1891.0	-	
		6	181691.0	55.3	17	1	1983.0	-	-	
		7	342261.0	66.8	17	2	1876.0	1339.0	-	
		8	502361.0	97.0	17	3	1203.0	1414.0	1665.0	
		9	625.0	87.8	17	3	1537.0	1147.0	1488.0	
		10	161136.0	86.7	17	3	1485.0	1937.0	1425.0	
		11	322435.0	81.6	17	2	1387.0	1842.0	-	
		12	484847.0	58.1	17	1	1160.0	-	-	
		13	645130.0	69.8	17	2	1103.0	1213.0	-	
		14	141792.0	71.3	17	2	1283.0	1564.0	-	
		15	301778.0	85.7	17	3	1247.0	1912.0	1905.0	
		16	463468.0	82.1	17	2	1404.0	1899.0	-	
		17	625798.0	54.9	17	1	1769.0	-	-	

Type 5 Radar Waveform_9

Download	9	Type 5	16	0.7500000	12.0000000	5.530000000				
		Burst ID	Burst Offset (us)	Pulse Width (us)	Chirp Width (MHz)	Number of Pulses per Burst	PRI-1 (us)	PRI-2 (us)	PRI-3 (us)	
		0	137066.0	90.8	15	3	1239.0	1242.0	1484.0	
		1	318680.0	62.6	15	1	1906.0	-	-	
		2	500291.0	60.4	15	1	1945.0	-	-	
		3	679019.0	86.5	15	3	1550.0	1661.0	1695.0	
		4	115207.0	64.9	15	1	1183.0	-	-	
		5	295326.0	91.5	15	3	1586.0	1561.0	1788.0	
		6	475769.0	97.3	15	3	1770.0	1870.0	1707.0	
		7	657248.0	95.8	15	3	1309.0	1641.0	1402.0	
		8	92765.0	56.9	15	1	1755.0	-	-	
		9	273458.0	70.9	15	2	1887.0	1998.0	-	
		10	454142.0	94.8	15	3	1259.0	1841.0	1232.0	
		11	634785.0	85.9	15	3	1420.0	1798.0	1354.0	
		12	70425.0	53.9	15	1	1621.0	-	-	
		13	250832.0	92.1	15	3	1220.0	1882.0	1782.0	
		14	433434.0	56.2	15	1	1624.0	-	-	
		15	612808.0	89.9	15	3	1064.0	1396.0	1757.0	

Type 5 Radar Waveform_10

Download	10	Type 5	13	0.9230769	12.0000000	5.496000000				
		Burst ID	Burst Offset (us)	Pulse Width (us)	Chirp Width (MHz)	Number of Pulses per Burst	PRI-1 (us)	PRI-2 (us)	PRI-3 (us)	
		0	59095.0	79.1	11	2	1191.0	1608.0	-	
		1	282310.0	73.4	11	2	1670.0	1111.0	-	
		2	504873.0	84.1	11	3	1373.0	1137.0	1432.0	
		3	728589.0	69.9	11	2	1600.0	1335.0	-	
		4	31575.0	91.9	11	3	1493.0	1272.0	1200.0	
		5	254757.0	79.2	11	2	1291.0	1704.0	-	
		6	478624.0	62.5	11	1	1612.0	-	-	
		7	700943.0	70.8	11	2	1677.0	1465.0	-	
		8	4127.0	54.5	11	1	1763.0	-	-	
		9	226848.0	93.0	11	3	1927.0	1772.0	1006.0	
		10	450076.0	66.8	11	2	2000.0	1696.0	-	
		11	673184.0	67.9	11	2	1844.0	1676.0	-	
		12	898534.0	52.0	11	1	1131.0	-	-	

Type 5 Radar Waveform_11

Download	11	Type 5	11	1.0909091	12.0000000	5.498000000				
		Burst ID	Burst Offset (us)	Pulse Width (us)	Chirp Width (MHz)	Number of Pulses per Burst	PRI-1 (us)	PRI-2 (us)	PRI-3 (us)	
		0	235728.0	89.8	9	3	1924.0	1576.0	1792.0	
		1	499954.0	78.1	9	2	1539.0	1729.0	-	
		2	762237.0	93.9	9	3	1863.0	1744.0	1804.0	
		3	1027622.0	67.9	9	2	1223.0	1947.0	-	
		4	204025.0	50.3	9	1	1396.0	-	-	
		5	468400.0	53.6	9	1	1084.0	-	-	
		6	732545.0	53.5	9	1	1341.0	-	-	
		7	994576.0	70.9	9	2	1946.0	1825.0	-	
		8	171326.0	81.0	9	2	1136.0	1212.0	-	
		9	434213.0	83.8	9	3	1747.0	1830.0	1582.0	
		10	699193.0	77.8	9	2	1578.0	1010.0	-	

Type 5 Radar Waveform_12

Download	12	Type 5	9	1.3333333	12.0000000	5.494000000				
		Burst ID	Burst Offset (us)	Pulse Width (us)	Chirp Width (MHz)	Number of Pulses per Burst	PRI-1 (us)	PRI-2 (us)	PRI-3 (us)	
		0	1178471.0	51.4	6	1	1702.0	-	-	
		1	169830.0	59.4	6	1	1478.0	-	-	
		2	492139.0	73.2	6	2	1953.0	1438.0	-	
		3	814434.0	84.5	6	3	1134.0	1074.0	1604.0	
		4	1137416.0	72.0	6	2	1389.0	1802.0	-	
		5	130052.0	61.1	6	1	1372.0	-	-	
		6	451785.0	83.8	6	3	1855.0	1865.0	1503.0	
		7	774299.0	94.6	6	3	1290.0	1853.0	1383.0	
		8	1097519.0	75.4	6	2	1955.0	1430.0	-	

Type 5 Radar Waveform_13

Download	13	Type 5	13	0.9230769	12.0000000	5.497000000				
		Burst ID	Burst Offset (us)	Pulse Width (us)	Chirp Width (MHz)	Number of Pulses per Burst	PRI-1 (us)	PRI-2 (us)	PRI-3 (us)	
		0	62396.0	68.3	12	2	1076.0	1234.0	-	
		1	285192.0	90.8	12	3	1538.0	1403.0	1042.0	
		2	507806.0	96.0	12	3	1712.0	1040.0	1764.0	
		3	733359.0	51.6	12	1	1030.0	-	-	
		4	34936.0	62.1	12	1	1055.0	-	-	
		5	258553.0	63.0	12	1	1063.0	-	-	
		6	461921.0	61.5	12	1	1540.0	-	-	
		7	705231.0	50.1	12	1	1790.0	-	-	
		8	7362.0	89.6	12	3	1778.0	1611.0	1281.0	
		9	230545.0	81.9	12	2	1715.0	1199.0	-	
		10	453829.0	72.0	12	2	1627.0	1053.0	-	
		11	677178.0	74.6	12	2	1251.0	1261.0	-	
		12	899929.0	79.4	12	2	1861.0	1177.0	-	

Type 5 Radar Waveform_14

Download	14	Type 5	15	0.8000000	12.0000000	5.498000000				
		Burst ID	Burst Offset (us)	Pulse Width (us)	Chirp Width (MHz)	Number of Pulses per Burst	PRI-1 (us)	PRI-2 (us)	PRI-3 (us)	
		0	175699.0	93.8	14	3	1093.0	1319.0	1394.0	
		1	369165.0	67.2	14	2	1552.0	1470.0	-	
		2	561618.0	92.9	14	3	1029.0	1701.0	1480.0	
		3	757569.0	50.8	14	1	1102.0	-	-	
		4	151914.0	67.9	14	2	1957.0	1848.0	-	
		5	346201.0	53.6	14	1	1072.0	-	-	
		6	537383.0	88.4	14	3	1467.0	1734.0	1691.0	
		7	733193.0	52.6	14	1	1667.0	-	-	
		8	128245.0	68.9	14	2	1120.0	1958.0	-	
		9	320814.0	98.1	14	3	1964.0	1449.0	1424.0	
		10	513755.0	89.6	14	3	1888.0	1221.0	1590.0	
		11	709361.0	56.2	14	1	1637.0	-	-	
		12	104426.0	68.4	14	2	1934.0	1226.0	-	
		13	297777.0	82.5	14	2	1487.0	1428.0	-	
		14	491967.0	55.9	14	1	1500.0	-	-	

Type 5 Radar Waveform_15

Download	15	Type 5	12	1.0000000	12.0000000	5.496000000				
		Burst ID	Burst Offset (us)	Pulse Width (us)	Chirp Width (MHz)	Number of Pulses per Burst	PRI-1 (us)	PRI-2 (us)	PRI-3 (us)	
		0	856423.0	78.1	10	2	1382.0	1207.0	-	
		1	100717.0	98.9	10	3	1984.0	1254.0	1298.0	
		2	342076.0	93.4	10	3	1275.0	1629.0	1843.0	
		3	585166.0	59.1	10	1	1832.0	-	-	
		4	825909.0	72.2	10	2	1860.0	1594.0	-	
		5	70976.0	92.6	10	3	1446.0	1736.0	1393.0	
		6	312477.0	83.8	10	3	1494.0	1722.0	1107.0	
		7	554177.0	99.0	10	3	1024.0	1080.0	1829.0	
		8	796619.0	80.1	10	2	1451.0	1400.0	-	
		9	41225.0	92.3	10	3	1589.0	1659.0	1638.0	
		10	283567.0	55.8	10	1	1381.0	-	-	
		11	523648.0	87.3	10	3	1528.0	1668.0	1823.0	

Type 5 Radar Waveform_16

Download	16	Type 5	10	1.2000000	12.0000000	5.495000000				
		Burst ID	Burst Offset (us)	Pulse Width (us)	Chirp Width (MHz)	Number of Pulses per Burst	PRI-1 (us)	PRI-2 (us)	PRI-3 (us)	
		0	919666.0	92.2	8	3	1236.0	1079.0	1534.0	
		1	13852.0	53.4	8	1	1049.0	-	-	
		2	304126.0	81.4	8	2	1153.0	1900.0	-	
		3	593903.0	99.2	8	3	1169.0	1483.0	1448.0	
		4	885770.0	61.8	8	1	1634.0	-	-	
		5	1177032.0	53.2	8	1	1001.0	-	-	
		6	268500.0	72.0	8	2	1009.0	1456.0	-	
		7	559235.0	65.7	8	1	1834.0	-	-	
		8	849914.0	56.0	8	1	1711.0	-	-	
		9	1138314.0	91.6	8	3	1771.0	1181.0	1094.0	

Type 5 Radar Waveform_17

Download	17	Type 5	9	1.3333333	12.0000000	5.495000000				
		Burst ID	Burst Offset (us)	Pulse Width (us)	Chirp Width (MHz)	Number of Pulses per Burst	PRI-1 (us)	PRI-2 (us)	PRI-3 (us)	
		0	258633.0	71.2	7	2	1130.0	1350.0	-	
		1	580389.0	93.3	7	3	1811.0	1359.0	1639.0	
		2	903565.0	80.2	7	2	1838.0	1548.0	-	
		3	1227449.0	56.2	7	1	1944.0	-	-	
		4	218743.0	72.7	7	2	1287.0	1995.0	-	
		5	540776.0	99.4	7	3	1392.0	1280.0	1952.0	
		6	863452.0	92.7	7	3	1184.0	1257.0	1533.0	
		7	1187852.0	58.3	7	1	1745.0	-	-	
		8	178915.0	95.4	7	3	1653.0	1070.0	1252.0	

Type 5 Radar Waveform_18

Download	18	Type 5	11	1.0909091	12.0000000	5.496000000				
		Burst ID	Burst Offset (us)	Pulse Width (us)	Chirp Width (MHz)	Number of Pulses per Burst	PRI-1 (us)	PRI-2 (us)	PRI-3 (us)	
		0	409428.0	93.7	9	3	1892.0	1880.0	1463.0	
		1	673651.0	80.6	9	2	1981.0	1781.0	-	
		2	939687.0	55.5	9	1	1016.0	-	-	
		3	113995.0	72.0	9	2	1087.0	1180.0	-	
		4	377102.0	90.8	9	3	1921.0	1197.0	1807.0	
		5	641104.0	88.6	9	3	1395.0	1217.0	1268.0	
		6	906895.0	62.8	9	1	1295.0	-	-	
		7	81494.0	52.4	9	1	1978.0	-	-	
		8	344954.0	86.9	9	3	1439.0	1008.0	1549.0	
		9	610023.0	59.9	9	1	1391.0	-	-	
		10	873129.0	68.2	9	2	1429.0	1379.0	-	

Type 5 Radar Waveform_19										
Download	19	Type 5	10	1.2000000	12.0000000	5.495000000				
		Burst ID	Burst Offset (us)	Pulse Width (us)	Chirp Width (MHz)	Number of Pulses per Burst	PRI-1 (us)	PRI-2 (us)	PRI-3 (us)	
		0	53875.0	62.7	8	1	1819.0	-	-	
		1	344657.0	58.6	8	1	1178.0	-	-	
		2	635055.0	62.1	8	1	1845.0	-	-	
		3	925536.0	66.3	8	1	1987.0	-	-	
		4	18035.0	96.3	8	3	1739.0	1930.0	1159.0	
		5	307874.0	99.3	8	3	1872.0	1284.0	1780.0	
		6	598057.0	87.6	8	3	1421.0	1472.0	1358.0	
		7	888201.0	99.0	8	3	1738.0	1059.0	1270.0	
		8	1179310.0	77.8	8	2	1681.0	1313.0	-	
		9	272951.0	53.0	8	1	1516.0	-	-	

Type 5 Radar Waveform_20										
Download	20	Type 5	9	1.3333333	12.0000000	5.568000000				
		Burst ID	Burst Offset (us)	Pulse Width (us)	Chirp Width (MHz)	Number of Pulses per Burst	PRI-1 (us)	PRI-2 (us)	PRI-3 (us)	
		0	624975.0	96.4	6	3	1524.0	1007.0	1856.0	
		1	947630.0	66.8	6	2	1925.0	1980.0	-	
		2	1270155.0	100.0	6	3	1333.0	1390.0	1081.0	
		3	262925.0	86.5	6	3	1152.0	1866.0	1556.0	
		4	585720.0	77.7	6	2	1651.0	1723.0	-	
		5	909745.0	50.1	6	1	1225.0	-	-	
		6	1230941.0	79.0	6	2	1943.0	1316.0	-	
		7	223692.0	66.0	6	1	1822.0	-	-	
		8	546168.0	69.8	6	2	1224.0	1713.0	-	

Type 5 Radar Waveform_21										
Download	21	Type 5	14	0.8571429	12.0000000	5.563000000				
		Burst ID	Burst Offset (us)	Pulse Width (us)	Chirp Width (MHz)	Number of Pulses per Burst	PRI-1 (us)	PRI-2 (us)	PRI-3 (us)	
		0	557376.0	84.4	12	3	1099.0	1397.0	1166.0	
		1	766016.0	56.2	12	1	1826.0	-	-	
		2	117947.0	71.7	12	2	1567.0	1654.0	-	
		3	324790.0	96.9	12	3	1586.0	1195.0	1125.0	
		4	533464.0	62.1	12	1	1117.0	-	-	
		5	740385.0	56.7	12	1	1917.0	-	-	
		6	92257.0	86.6	12	3	1828.0	1753.0	1305.0	
		7	299487.0	81.4	12	2	1622.0	1750.0	-	
		8	506469.0	90.6	12	3	1264.0	1005.0	1245.0	
		9	714839.0	60.6	12	1	1913.0	-	-	
		10	66909.0	99.0	12	3	1044.0	1121.0	1288.0	
		11	274712.0	50.7	12	1	1095.0	-	-	
		12	460082.0	85.1	12	3	1976.0	1114.0	1996.0	
		13	689935.0	55.7	12	1	1112.0	-	-	

Type 5 Radar Waveform_22										
Download	22	Type 5	14	0.8571429	12.0000000	5.563000000				
		Burst ID	Burst Offset (us)	Pulse Width (us)	Chirp Width (MHz)	Number of Pulses per Burst	PRI-1 (us)	PRI-2 (us)	PRI-3 (us)	
		0	41313.0	87.9	13	3	1831.0	1523.0	1990.0	
		1	248743.0	78.9	13	2	1365.0	1089.0	-	
		2	456429.0	62.5	13	1	1709.0	-	-	
		3	662685.0	81.2	13	2	1343.0	1672.0	-	
		4	15946.0	63.8	13	1	1068.0	-	-	
		5	223398.0	59.9	13	1	1731.0	-	-	
		6	430261.0	73.4	13	2	1649.0	1276.0	-	
		7	638154.0	61.7	13	1	1963.0	-	-	
		8	843056.0	93.8	13	3	1560.0	1919.0	1018.0	
		9	197494.0	80.6	13	2	1720.0	1519.0	-	
		10	403913.0	92.4	13	3	1323.0	1973.0	1378.0	
		11	610696.0	97.4	13	3	1685.0	1809.0	1135.0	
		12	820656.0	63.8	13	1	1293.0	-	-	
		13	172243.0	55.6	13	1	1954.0	-	-	

Type 5 Radar Waveform_23

Download	23	Type 5	13	0.9230769	12.0000000	5.563000000				
		Burst ID	Burst Offset (us)	Pulse Width (us)	Chirp Width (MHz)	Number of Pulses per Burst	PRI-1 (us)	PRI-2 (us)	PRI-3 (us)	
		0	407779.0	85.6	12	3	1357.0	1632.0	1546.0	
		1	632300.0	63.1	12	1	1992.0	-	-	
		2	853157.0	88.4	12	3	1039.0	1907.0	1774.0	
		3	157678.0	83.9	12	3	1116.0	1618.0	1126.0	
		4	380299.0	86.5	12	3	1644.0	1019.0	1965.0	
		5	604315.0	67.1	12	2	1377.0	1328.0	-	
		6	826843.0	75.6	12	2	1896.0	1577.0	-	
		7	130585.0	61.9	12	1	1263.0	-	-	
		8	353233.0	91.0	12	3	1210.0	1435.0	1015.0	
		9	577428.0	61.8	12	1	1733.0	-	-	
		10	800917.0	50.0	12	1	1694.0	-	-	
		11	103018.0	59.6	12	1	1518.0	-	-	
		12	326704.0	59.6	12	1	1014.0	-	-	

Type 5 Radar Waveform_24

Download	24	Type 5	14	0.8571429	12.0000000	5.563000000				
		Burst ID	Burst Offset (us)	Pulse Width (us)	Chirp Width (MHz)	Number of Pulses per Burst	PRI-1 (us)	PRI-2 (us)	PRI-3 (us)	
		0	509821.0	67.8	12	2	1904.0	1052.0	-	
		1	715917.0	97.0	12	3	1664.0	1011.0	1558.0	
		2	69878.0	86.4	12	3	1706.0	1017.0	1345.0	
		3	277175.0	78.8	12	2	1218.0	1617.0	-	
		4	485293.0	52.2	12	1	1209.0	-	-	
		5	692620.0	61.2	12	1	1536.0	-	-	
		6	44525.0	61.0	12	1	1527.0	-	-	
		7	252025.0	62.1	12	1	1573.0	-	-	
		8	459399.0	57.6	12	1	1812.0	-	-	
		9	667344.0	65.1	12	1	1171.0	-	-	
		10	18936.0	69.0	12	2	1344.0	1433.0	-	
		11	226565.0	65.2	12	1	1198.0	-	-	
		12	434075.0	56.0	12	1	1361.0	-	-	
		13	639057.0	96.5	12	3	1961.0	1480.0	1371.0	

Type 5 Radar Waveform_25

Download	25	Type 5	13	0.9230769	12.0000000	5.564000000				
		Burst ID	Burst Offset (us)	Pulse Width (us)	Chirp Width (MHz)	Number of Pulses per Burst	PRI-1 (us)	PRI-2 (us)	PRI-3 (us)	
		0	913351.0	72.7	11	2	1023.0	1606.0	-	
		1	216296.0	62.5	11	1	1966.0	-	-	
		2	438372.0	91.2	11	3	1652.0	1462.0	1623.0	
		3	663528.0	54.4	11	1	1362.0	-	-	
		4	887087.0	64.7	11	1	1347.0	-	-	
		5	188136.0	93.0	11	3	1491.0	1972.0	1636.0	
		6	411793.0	81.0	11	2	1174.0	1650.0	-	
		7	633849.0	95.9	11	3	1034.0	1499.0	1935.0	
		8	857694.0	77.5	11	2	1501.0	1837.0	-	
		9	161070.0	72.2	11	2	1854.0	1202.0	-	
		10	384671.0	65.1	11	1	1939.0	-	-	
		11	608589.0	64.3	11	1	1161.0	-	-	
		12	830640.0	68.0	11	2	1167.0	1703.0	-	

Type 5 Radar Waveform_26

Download	26	Type 5	8	1.5000000	12.0000000	5.566000000				
		Burst ID	Burst Offset (us)	Pulse Width (us)	Chirp Width (MHz)	Number of Pulses per Burst	PRI-1 (us)	PRI-2 (us)	PRI-3 (us)	
		0	217313.0	80.2	5	2	1967.0	1366.0	-	
		1	580603.0	75.9	5	2	1243.0	1312.0	-	
		2	942209.0	87.9	5	3	1994.0	1529.0	1526.0	
		3	1308298.0	50.6	5	1	1021.0	-	-	
		4	172552.0	81.1	5	2	1851.0	1903.0	-	
		5	536231.0	54.1	5	1	1541.0	-	-	
		6	899685.0	50.3	5	1	1490.0	-	-	
		7	1263269.0	55.6	5	1	1315.0	-	-	

Type 5 Radar Waveform_27

Download	27	Type 5	19	0.6315789	12.0000000	5.560000000			
		Burst ID	Burst Offset (us)	Pulse Width (us)	Chirp Width (MHz)	Number of Pulses per Burst	PRI-1 (us)	PRI-2 (us)	PRI-3 (us)
		0	53856.0	64.7	19	1	1318.0	-	-
		1	206549.0	55.4	19	1	1820.0	-	-
		2	359348.0	51.7	19	1	1710.0	-	-
		3	509704.0	90.2	19	3	1816.0	1479.0	1376.0
		4	34878.0	86.1	19	3	1158.0	1338.0	1502.0
		5	187733.0	52.7	19	1	1827.0	-	-
		6	338642.0	93.6	19	3	1565.0	1647.0	1993.0
		7	492270.0	78.0	19	2	1300.0	1718.0	-
		8	16120.0	98.0	19	3	1418.0	1835.0	1127.0
		9	168566.0	69.3	19	2	1969.0	1176.0	-
		10	321114.0	68.6	19	2	1815.0	1071.0	-
		11	474141.0	80.5	19	2	1109.0	1048.0	-
		12	625941.0	70.6	19	2	1201.0	1814.0	-
		13	150164.0	52.8	19	1	1585.0	-	-
		14	301778.0	99.5	19	3	1938.0	1002.0	1096.0
		15	453788.0	99.9	19	3	1858.0	1163.0	1277.0
		16	608485.0	57.3	19	1	1646.0	-	-
		17	130728.0	85.3	19	3	1765.0	1407.0	1364.0
		18	283572.0	66.7	19	2	1450.0	1388.0	-

Type 5 Radar Waveform_28

Download	28	Type 5	19	0.6315789	12.0000000	5.561000000			
		Burst ID	Burst Offset (us)	Pulse Width (us)	Chirp Width (MHz)	Number of Pulses per Burst	PRI-1 (us)	PRI-2 (us)	PRI-3 (us)
		0	435418.0	78.7	18	2	1794.0	1971.0	-
		1	588720.0	72.0	18	2	1619.0	1038.0	-
		2	112292.0	69.5	18	2	1168.0	1708.0	-
		3	265410.0	66.1	18	1	1363.0	-	-
		4	418225.0	63.7	18	1	1411.0	-	-
		5	568777.0	88.0	18	3	1032.0	1455.0	1444.0
		6	93308.0	93.2	18	3	1579.0	1003.0	1655.0
		7	245920.0	80.9	18	2	1922.0	1133.0	-
		8	398172.0	86.2	18	3	1020.0	1028.0	1299.0
		9	550733.0	69.7	18	2	1719.0	1406.0	-
		10	74874.0	64.4	18	1	1645.0	-	-
		11	226721.0	87.9	18	3	1660.0	1442.0	1123.0
		12	380577.0	61.1	18	1	1405.0	-	-
		13	533307.0	55.6	18	1	1531.0	-	-
		14	55737.0	90.8	18	3	1801.0	1678.0	1743.0
		15	208942.0	57.9	18	1	1320.0	-	-
		16	361538.0	57.0	18	1	1776.0	-	-
		17	511959.0	89.4	18	3	1182.0	1609.0	1833.0
		18	37238.0	64.3	18	1	1615.0	-	-

Type 5 Radar Waveform_29

Download	29	Type 5	11	1.0909091	12.0000000	5.564000000			
		Burst ID	Burst Offset (us)	Pulse Width (us)	Chirp Width (MHz)	Number of Pulses per Burst	PRI-1 (us)	PRI-2 (us)	PRI-3 (us)
		0	327975.0	78.7	9	2	1683.0	1931.0	-
		1	591146.0	90.2	9	3	1908.0	1317.0	1368.0
		2	854422.0	87.4	9	3	1571.0	1797.0	1466.0
		3	31791.0	67.8	9	2	1970.0	1593.0	-
		4	295411.0	79.5	9	2	1989.0	1928.0	-
		5	560235.0	52.8	9	1	1595.0	-	-
		6	822308.0	96.5	9	3	1495.0	1273.0	1628.0
		7	1086072.0	83.9	9	3	1477.0	1155.0	1514.0
		8	262774.0	97.5	9	3	1469.0	1240.0	1883.0
		9	526932.0	77.3	9	2	1725.0	1440.0	-
		10	791081.0	76.4	9	2	1013.0	1688.0	-



Radar Type 6 - Radar Statistical Performance			
Trail #	1=Detection 0=No Detection	Trail #	1=Detection 0=No Detection
0	1	15	1
1	1	16	1
2	1	17	1
3	1	18	1
4	1	19	1
5	1	20	1
6	1	21	1
7	1	22	1
8	1	23	1
9	1	24	1
10	1	25	1
11	1	26	1
12	1	27	1
13	1	28	1
14	1	29	1
Detection Percentage (%)		100.0%	

Type 6 Radar Waveform_0								
Download	0	Type 6	1.0	333.3	9	0.3333	300.0000000	15
		Frequency List (MHz)	0	1	2	3	4	
		0	5383	5597	5718	5424	5489	
		5	5580	5294	5547	5474	5460	
		10	5355	5336	5535	5569	5409	
		15	5275	5604	5521	5635	5638	
		20	5482	5583	5617	5653	5389	
		25	5309	5711	5410	5541	5469	
		30	5537	5481	5516	5334	5498	
		35	5436	5664	5314	5557	5377	
		40	5373	5682	5667	5312	5582	
		45	5347	5308	5425	5723	5522	
		50	5338	5490	5361	5351	5593	
		55	5350	5659	5691	5706	5256	
		60	5352	5270	5696	5642	5451	
		65	5636	5661	5287	5457	5328	
		70	5511	5456	5282	5333	5549	
		75	5614	5463	5471	5265	5393	
		80	5433	5621	5494	5665	5564	
		85	5477	5688	5493	5367	5404	
		90	5662	5318	5395	5478	5413	
		95	5397	5586	5412	5260	5704	

Type 6 Radar Waveform_1

Download	1	Type 6	1.0	333.3	9	0.3333	300.0000000	20
		Frequency List (MHz)	0	1	2	3	4	
		0	5638	5361	5654	5585	5709	
		5	5285	5602	5369	5613	5681	
		10	5391	5619	5474	5255	5590	
		15	5497	5402	5707	5566	5352	
		20	5646	5648	5524	5706	5626	
		25	5277	5258	5342	5514	5575	
		30	5511	5426	5438	5256	5583	
		35	5455	5637	5527	5460	5564	
		40	5568	5313	5456	5347	5447	
		45	5664	5716	5562	5430	5366	
		50	5381	5610	5398	5541	5337	
		55	5659	5295	5684	5304	5510	
		60	5580	5385	5517	5690	5528	
		65	5468	5494	5600	5349	5606	
		70	5680	5442	5687	5383	5421	
		75	5259	5495	5444	5723	5278	
		80	5649	5537	5496	5618	5689	
		85	5503	5308	5458	5418	5652	
		90	5482	5483	5498	5415	5506	
		95	5603	5363	5396	5586	5620	

Type 6 Radar Waveform_2

Download	2	Type 6	1.0	333.3	9	0.3333	300.0000000	22
		Frequency List (MHz)	0	1	2	3	4	
		0	5418	5697	5590	5271	5551	
		5	5327	5527	5444	5301	5413	
		10	5700	5505	5515	5450	5611	
		15	5585	5529	5335	5641	5654	
		20	5717	5562	5698	5599	5543	
		25	5545	5618	5609	5553	5412	
		30	5395	5374	5260	5275	5715	
		35	5353	5482	5627	5539	5285	
		40	5661	5548	5542	5513	5434	
		45	5400	5274	5690	5592	5426	
		50	5385	5617	5397	5258	5467	
		55	5329	5514	5682	5635	5380	
		60	5391	5440	5683	5534	5636	
		65	5619	5409	5277	5428	5358	
		70	5663	5342	5390	5379	5541	
		75	5425	5500	5388	5430	5604	
		80	5656	5615	5568	5345	5326	
		85	5372	5328	5680	5648	5504	
		90	5449	5555	5620	5380	5628	
		95	5565	5723	5606	5556	5263	

Type 6 Radar Waveform_3

Download	3	Type 6	1.0	333.3	9	0.3333	300.0000000	21
		Frequency List (MHz)	0	1	2	3	4	
		0	5576	5461	5526	5432	5296	
		5	5369	5549	5519	5464	5717	
		10	5631	5294	5556	5548	5632	
		15	5656	5438	5559	5358	5565	
		20	5408	5503	5312	5572	5431	
		25	5534	5273	5722	5643	5692	
		30	5301	5352	5589	5509	5473	
		35	5440	5331	5624	5395	5396	
		40	5466	5622	5698	5355	5280	
		45	5477	5522	5596	5385	5487	
		50	5287	5625	5391	5515	5683	
		55	5561	5585	5687	5657	5546	
		60	5372	5677	5667	5386	5409	
		65	5483	5575	5539	5511	5446	
		70	5627	5682	5639	5262	5499	
		75	5684	5406	5655	5498	5686	
		80	5293	5719	5612	5604	5471	
		85	5284	5560	5595	5291	5423	
		90	5500	5338	5510	5437	5637	
		95	5364	5447	5351	5403	5258	

Type 6 Radar Waveform_4

Download	4	Type 6	1.0	333.3	9	0.3333	300.0000000	23
		Frequency List (MHz)	0	1	2	3	4	
		0	5356	5700	5462	5593	5613	
		5	5508	5474	5594	5627	5449	
		10	5562	5558	5597	5268	5653	
		15	5664	5686	5541	5604	5550	
		20	5573	5477	5444	5304	5545	
		25	5697	5386	5476	5448	5677	
		30	5259	5665	5309	5329	5661	
		35	5293	5482	5422	5420	5645	
		40	5407	5305	5327	5539	5595	
		45	5277	5502	5679	5443	5540	
		50	5552	5404	5567	5694	5506	
		55	5408	5298	5641	5372	5345	
		60	5493	5675	5537	5622	5499	
		65	5615	5429	5707	5432	5611	
		70	5371	5306	5490	5518	5497	
		75	5630	5531	5638	5706	5619	
		80	5255	5484	5511	5467	5457	
		85	5307	5512	5324	5374	5601	
		90	5523	5312	5634	5377	5349	
		95	5698	5503	5516	5319	5261	

Type 6 Radar Waveform_5

Download	5	Type 6	1.0	333.3	9	0.3333	300.000000	13
		Frequency List (MHz)	0	1	2	3	4	
		0	5611	5464	5398	5657	5358	
		5	5550	5496	5669	5315	5656	
		10	5396	5347	5638	5463	5674	
		15	5277	5338	5547	5649	5267	
		20	5581	5643	5482	5393	5518	
		25	5585	5335	5679	5552	5711	
		30	5301	5651	5266	5544	5435	
		35	5491	5621	5513	5313	5323	
		40	5321	5619	5410	5477	5263	
		45	5274	5713	5287	5404	5593	
		50	5439	5280	5268	5270	5329	
		55	5352	5486	5595	5562	5639	
		60	5367	5702	5567	5428	5441	
		65	5375	5433	5381	5647	5673	
		70	5671	5687	5483	5255	5380	
		75	5591	5597	5578	5642	5465	
		80	5684	5723	5370	5509	5616	
		85	5374	5443	5504	5599	5331	
		90	5668	5357	5579	5293	5583	
		95	5429	5322	5308	5557	5324	

Type 6 Radar Waveform_6

Download	6	Type 6	1.0	333.3	9	0.3333	300.000000	16
		Frequency List (MHz)	0	1	2	3	4	
		0	5391	5703	5334	5343	5675	
		5	5592	5421	5269	5381	5485	
		10	5327	5611	5679	5658	5695	
		15	5365	5465	5650	5694	5459	
		20	5492	5712	5423	5385	5491	
		25	5376	5662	5310	5656	5270	
		30	5540	5698	5587	5311	5285	
		35	5604	5584	5476	5710	5555	
		40	5493	5415	5503	5271	5642	
		45	5370	5462	5646	5704	5631	
		50	5444	5321	5404	5530	5674	
		55	5549	5277	5458	5338	5392	
		60	5512	5260	5267	5256	5330	
		65	5586	5413	5468	5474	5284	
		70	5469	5258	5607	5567	5556	
		75	5547	5287	5541	5446	5461	
		80	5504	5688	5506	5336	5382	
		85	5546	5599	5467	5716	5358	
		90	5625	5638	5660	5619	5317	
		95	5454	5718	5455	5359	5603	

Type 6 Radar Waveform_7

Download	7	Type 6	1.0	333.3	9	0.3333	300.0000000	21
		Frequency List (MHz)	0	1	2	3	4	
		0	5646	5467	5270	5504	5420	
		5	5634	5443	5344	5544	5692	
		10	5258	5497	5720	5378	5716	
		15	5356	5592	5278	5642	5651	
		20	5500	5403	5364	5474	5464	
		25	5264	5514	5513	5285	5304	
		30	5482	5429	5655	5402	5361	
		35	5509	5327	5695	5380	5629	
		40	5721	5394	5673	5353	5268	
		45	5345	5453	5520	5699	5591	
		50	5507	5620	5372	5493	5618	
		55	5387	5503	5309	5587	5557	
		60	5554	5567	5665	5267	5457	
		65	5279	5622	5623	5263	5277	
		70	5552	5358	5456	5446	5515	
		75	5419	5407	5427	5713	5269	
		80	5377	5593	5531	5316	5432	
		85	5336	5536	5523	5631	5328	
		90	5491	5693	5494	5644	5288	
		95	5342	5412	5666	5298	5595	

Type 6 Radar Waveform_8

Download	8	Type 6	1.0	333.3	9	0.3333	300.0000000	20
		Frequency List (MHz)	0	1	2	3	4	
		0	5329	5706	5681	5665	5262	
		5	5298	5465	5419	5707	5424	
		10	5567	5286	5476	5444	5719	
		15	5381	5687	5368	5508	5472	
		20	5305	5466	5437	5627	5463	
		25	5716	5486	5338	5524	5415	
		30	5612	5617	5513	5408	5651	
		35	5404	5635	5708	5281	5291	
		40	5265	5403	5325	5536	5481	
		45	5655	5321	5423	5582	5478	
		50	5457	5560	5474	5260	5722	
		55	5499	5399	5491	5310	5658	
		60	5703	5455	5630	5555	5525	
		65	5538	5361	5422	5388	5527	
		70	5255	5490	5379	5541	5656	
		75	5500	5251	5569	5411	5300	
		80	5387	5391	5259	5688	5637	
		85	5362	5603	5503	5344	5273	
		90	5588	5623	5540	5507	5519	
		95	5294	5275	5558	5579	5467	

Type 6 Radar Waveform_9

Download	9	Type 6	1.0	333.3	9	0.3333	300.0000000	18
		Frequency List (MHz)	0	1	2	3	4	
		0	5584	5470	5617	5351	5482	
		5	5340	5390	5494	5395	5253	
		10	5498	5550	5424	5671	5283	
		15	5532	5274	5484	5257	5560	
		20	5419	5638	5343	5555	5410	
		25	5418	5315	5444	5590	5372	
		30	5566	5304	5569	5357	5287	
		35	5624	5605	5499	5544	5557	
		40	5549	5547	5364	5704	5651	
		45	5359	5710	5305	5619	5539	
		50	5708	5268	5637	5497	5474	
		55	5293	5409	5666	5314	5275	
		60	5629	5273	5412	5706	5317	
		65	5256	5481	5597	5665	5425	
		70	5358	5694	5524	5461	5398	
		75	5433	5301	5389	5645	5392	
		80	5322	5705	5341	5400	5446	
		85	5558	5480	5603	5265	5639	
		90	5554	5378	5643	5299	5485	
		95	5612	5458	5328	5462	5486	

Type 6 Radar Waveform_10

Download	10	Type 6	1.0	333.3	9	0.3333	300.0000000	12
		Frequency List (MHz)	0	1	2	3	4	
		0	5364	5709	5553	5512	5324	
		5	5382	5412	5569	5461	5460	
		10	5332	5339	5465	5391	5304	
		15	5620	5401	5490	5680	5374	
		20	5427	5707	5284	5547	5383	
		25	5306	5264	5647	5694	5406	
		30	5705	5668	5526	5475	5439	
		35	5347	5269	5590	5340	5710	
		40	5560	5483	5447	5642	5416	
		45	5356	5639	5285	5702	5597	
		50	5286	5533	5513	5673	5525	
		55	5675	5256	5379	5268	5600	
		60	5402	5577	5486	5635	5715	
		65	5677	5682	5698	5633	5497	
		70	5317	5636	5291	5607	5464	
		75	5478	5392	5704	5670	5444	
		80	5370	5422	5502	5578	5297	
		85	5404	5397	5263	5322	5592	
		90	5320	5608	5315	5277	5543	
		95	5271	5333	5270	5721	5384	

Type 6 Radar Waveform_11

Download	11	Type 6	1.0	333.3	9	0.3333	300.000000	15
		Frequency List (MHz)	0	1	2	3	4	
		0	5619	5473	5489	5673	5544	
		5	5424	5337	5644	5624	5667	
		10	5263	5603	5506	5586	5325	
		15	5611	5528	5593	5250	5566	
		20	5435	5398	5700	5636	5356	
		25	5572	5591	5278	5323	5440	
		30	5272	5654	5483	5690	5688	
		35	5642	5311	5681	5485	5474	
		40	5322	5627	5656	5353	5568	
		45	5265	5310	5558	5339	5420	
		50	5389	5374	5576	5471	5498	
		55	5675	5567	5697	5655	5309	
		60	5571	5531	5267	5431	5467	
		65	5541	5720	5505	5647	5707	
		70	5587	5342	5363	5705	5350	
		75	5351	5315	5490	5674	5612	
		80	5359	5461	5394	5458	5261	
		85	5555	5415	5573	5346	5563	
		90	5708	5277	5367	5258	5492	
		95	5438	5527	5282	5463	5281	

Type 6 Radar Waveform_12

Download	12	Type 6	1.0	333.3	9	0.3333	300.000000	20
		Frequency List (MHz)	0	1	2	3	4	
		0	5302	5712	5425	5359	5386	
		5	5563	5719	5312	5496	5669	
		10	5489	5547	5306	5346	5699	
		15	5655	5696	5295	5283	5564	
		20	5263	5628	5329	5460	5443	
		25	5481	5524	5474	5314	5543	
		30	5440	5430	5365	5450	5297	
		35	5504	5638	5388	5636	5710	
		40	5421	5350	5400	5720	5393	
		45	5616	5392	5685	5643	5550	
		50	5627	5560	5321	5522	5280	
		55	5651	5370	5603	5542	5660	
		60	5432	5376	5299	5464	5666	
		65	5706	5696	5608	5539	5382	
		70	5620	5532	5579	5567	5554	
		75	5326	5310	5545	5435	5633	
		80	5332	5451	5625	5530	5391	
		85	5653	5364	5578	5615	5607	
		90	5441	5397	5336	5398	5304	
		95	5412	5367	5509	5493	5511	

Type 6 Radar Waveform_13

Download	13	Type 6	1.0	333.3	9	0.3333	300.0000000	17
		Frequency List (MHz)	0	1	2	3	4	
		0	5557	5476	5361	5423	5606	
		5	5605	5284	5697	5475	5703	
		10	5503	5278	5588	5404	5367	
		15	5312	5307	5324	5340	5354	
		20	5633	5679	5717	5302	5251	
		25	5392	5684	5628	5508	5453	
		30	5529	5397	5645	5614	5660	
		35	5589	5485	5300	5316	5399	
		40	5318	5359	5564	5347	5329	
		45	5603	5674	5445	5572	5519	
		50	5678	5271	5619	5466	5468	
		55	5560	5422	5416	5314	5597	
		60	5321	5290	5612	5545	5644	
		65	5274	5604	5565	5570	5403	
		70	5680	5269	5514	5555	5410	
		75	5260	5493	5690	5388	5373	
		80	5267	5420	5578	5702	5406	
		85	5351	5584	5563	5289	5338	
		90	5294	5526	5548	5592	5553	
		95	5431	5299	5513	5586	5296	

Type 6 Radar Waveform_14

Download	14	Type 6	1.0	333.3	9	0.3333	300.0000000	13
		Frequency List (MHz)	0	1	2	3	4	
		0	5337	5715	5297	5584	5448	
		5	5647	5306	5541	5435	5434	
		10	5542	5629	5599	5388	5400	
		15	5427	5288	5667	5362	5324	
		20	5620	5709	5275	5614	5719	
		25	5412	5257	5445	5495	5418	
		30	5354	5291	5383	5631	5576	
		35	5571	5566	5313	5314	5498	
		40	5329	5441	5636	5583	5559	
		45	5635	5401	5395	5254	5360	
		50	5345	5619	5387	5346	5287	
		55	5363	5535	5591	5558	5255	
		60	5494	5561	5544	5701	5298	
		65	5648	5670	5252	5656	5703	
		70	5386	5578	5347	5391	5370	
		75	5274	5381	5278	5665	5267	
		80	5359	5638	5419	5402	5357	
		85	5253	5392	5651	5488	5640	
		90	5603	5548	5681	5534	5497	
		95	5408	5250	5290	5302	5718	

Type 6 Radar Waveform_15

Download	15	Type 6	1.0	333.3	9	0.3333	300.0000000	14
		Frequency List (MHz)	0	1	2	3	4	
		0	5592	5479	5708	5270	5668	
		5	5311	5706	5372	5704	5264	
		10	5365	5331	5670	5319	5409	
		15	5391	5464	5433	5333	5384	
		20	5273	5393	5658	5323	5723	
		25	5502	5615	5361	5537	5307	
		30	5503	5540	5678	5295	5667	
		35	5367	5719	5702	5250	5581	
		40	5710	5569	5438	5565	5563	
		45	5642	5693	5454	5724	5649	
		50	5603	5305	5449	5643	5257	
		55	5272	5513	5368	5358	5475	
		60	5452	5308	5514	5601	5456	
		65	5443	5619	5316	5436	5504	
		70	5370	5634	5673	5632	5662	
		75	5355	5698	5490	5635	5383	
		80	5530	5545	5341	5285	5385	
		85	5645	5676	5611	5617	5356	
		90	5605	5511	5418	5398	5309	
		95	5597	5657	5560	5446	5660	

Type 6 Radar Waveform_16

Download	16	Type 6	1.0	333.3	9	0.3333	300.0000000	22
		Frequency List (MHz)	0	1	2	3	4	
		0	5275	5718	5644	5431	5510	
		5	5353	5253	5447	5392	5471	
		10	5674	5595	5711	5514	5430	
		15	5479	5591	5536	5378	5576	
		20	5281	5559	5599	5315	5696	
		25	5293	5520	5721	5465	5513	
		30	5676	5268	5692	5498	5434	
		35	5283	5260	5397	5713	5564	
		40	5664	5648	5712	5435	5494	
		45	5543	5250	5276	5507	5525	
		50	5304	5356	5538	5466	5579	
		55	5460	5467	5558	5257	5707	
		60	5604	5617	5340	5547	5279	
		65	5623	5706	5685	5539	5620	
		70	5298	5328	5608	5621	5324	
		75	5343	5412	5493	5311	5709	
		80	5501	5282	5580	5548	5518	
		85	5661	5582	5407	5331	5583	
		90	5404	5318	5641	5344	5542	
		95	5265	5515	5598	5571	5581	

Type 6 Radar Waveform_17

Download	17	Type 6	1.0	333.3	9	0.3333	300.0000000	17
		Frequency List (MHz)	0	1	2	3	4	
		0	5530	5482	5580	5592	5255	
		5	5395	5653	5522	5555	5678	
		10	5605	5481	5374	5709	5451	
		15	5567	5718	5639	5423	5293	
		20	5289	5628	5540	5404	5669	
		25	5656	5372	5449	5666	5547	
		30	5657	5700	5458	5466	5696	
		35	5573	5531	5647	5627	5403	
		40	5272	5586	5477	5432	5326	
		45	5523	5333	5334	5560	5401	
		50	5480	5407	5648	5421	5273	
		55	5454	5258	5307	5673	5506	
		60	5641	5493	5341	5594	5358	
		65	5501	5488	5611	5606	5301	
		70	5652	5584	5671	5463	5679	
		75	5664	5603	5398	5564	5279	
		80	5300	5548	5457	5624	5450	
		85	5361	5529	5410	5280	5578	
		90	5691	5625	5717	5521	5368	
		95	5713	5596	5411	5566	5424	

Type 6 Radar Waveform_18

Download	18	Type 6	1.0	333.3	9	0.3333	300.0000000	14
		Frequency List (MHz)	0	1	2	3	4	
		0	5310	5343	5516	5278	5572	
		5	5437	5675	5597	5621	5410	
		10	5536	5270	5415	5332	5472	
		15	5655	5370	5267	5371	5582	
		20	5319	5578	5396	5642	5447	
		25	5321	5652	5295	5581	5285	
		30	5546	5657	5576	5618	5615	
		35	5562	5327	5325	5541	5717	
		40	5452	5524	5429	5255	5503	
		45	5416	5613	5666	5277	5656	
		50	5458	5338	5587	5361	5375	
		55	5463	5273	5649	5387	5715	
		60	5564	5303	5290	5630	5665	
		65	5393	5291	5305	5689	5304	
		70	5501	5539	5640	5486	5250	
		75	5315	5441	5616	5348	5465	
		80	5627	5276	5495	5451	5299	
		85	5518	5302	5349	5438	5692	
		90	5460	5352	5330	5609	5403	
		95	5374	5533	5691	5623	5561	

Type 6 Radar Waveform_19

Download	19	Type 6	1.0	333.3	9	0.3333	300.0000000	22
		Frequency List (MHz)	0	1	2	3	4	
		0	5565	5582	5452	5439	5317	
		5	5576	5600	5672	5309	5714	
		10	5370	5534	5456	5527	5493	
		15	5646	5400	5416	5299	5683	
		20	5388	5519	5485	5615	5335	
		25	5648	5380	5399	5327	5532	
		30	5614	5316	5392	5279	5653	
		35	5695	5478	5455	5535	5365	
		40	5482	5523	5562	5386	5499	
		45	5353	5666	5531	5357	5509	
		50	5427	5313	5314	5549	5329	
		55	5567	5620	5419	5637	5660	
		60	5267	5390	5504	5569	5663	
		65	5377	5675	5404	5350	5498	
		70	5512	5606	5393	5296	5693	
		75	5251	5604	5629	5690	5651	
		80	5312	5451	5616	5647	5710	
		85	5283	5366	5550	5547	5506	
		90	5720	5364	5347	5403	5513	
		95	5382	5477	5256	5311	5360	

Type 6 Radar Waveform_20

Download	20	Type 6	1.0	333.3	9	0.3333	300.0000000	21
		Frequency List (MHz)	0	1	2	3	4	
		0	5345	5346	5388	5503	5537	
		5	5618	5622	5272	5472	5446	
		10	5301	5323	5497	5722	5514	
		15	5259	5527	5376	5461	5491	
		20	5691	5554	5460	5477	5588	
		25	5601	5597	5583	5649	5466	
		30	5421	5571	5531	5544	5534	
		35	5418	5269	5253	5492	5303	
		40	5625	5520	5366	5582	5411	
		45	5343	5407	5533	5560	5516	
		50	5611	5636	5262	5283	5368	
		55	5386	5494	5548	5327	5605	
		60	5574	5313	5428	5663	5707	
		65	5555	5372	5449	5661	5577	
		70	5415	5457	5481	5251	5439	
		75	5277	5373	5264	5385	5318	
		80	5375	5648	5507	5354	5610	
		85	5427	5723	5320	5367	5671	
		90	5525	5285	5602	5473	5364	
		95	5458	5674	5508	5361	5580	

Type 6 Radar Waveform_21

Download	21	Type 6	1.0	333.3	9	0.3333	300.0000000	20
		Frequency List (MHz)	0	1	2	3	4	
		0	5503	5585	5324	5664	5379	
		5	5660	5547	5347	5635	5653	
		10	5610	5587	5538	5442	5535	
		15	5654	5479	5506	5683	5602	
		20	5720	5401	5566	5561	5489	
		25	5449	5689	5704	5508	5310	
		30	5528	5271	5318	5257	5557	
		35	5360	5287	5406	5380	5331	
		40	5701	5716	5390	5517	5420	
		45	5346	5665	5372	5675	5608	
		50	5283	5709	5611	5605	5434	
		55	5580	5353	5615	5558	5583	
		60	5465	5677	5492	5550	5614	
		65	5374	5612	5544	5350	5553	
		70	5618	5269	5507	5426	5391	
		75	5416	5371	5582	5258	5625	
		80	5641	5482	5438	5645	5702	
		85	5397	5670	5522	5591	5571	
		90	5565	5361	5531	5697	5484	
		95	5381	5658	5718	5652	5404	

Type 6 Radar Waveform_22

Download	22	Type 6	1.0	333.3	9	0.3333	300.0000000	17
		Frequency List (MHz)	0	1	2	3	4	
		0	5283	5349	5260	5350	5599	
		5	5702	5569	5422	5323	5482	
		10	5541	5376	5579	5637	5556	
		15	5435	5306	5582	5454	5400	
		20	5610	5314	5439	5558	5534	
		25	5377	5301	5417	5333	5717	
		30	5550	5296	5485	5389	5470	
		35	5552	5451	5559	5294	5645	
		40	5406	5654	5630	5514	5252	
		45	5326	5273	5430	5253	5495	
		50	5634	5410	5662	5316	5257	
		55	5427	5651	5402	5436	5331	
		60	5657	5592	5713	5440	5254	
		65	5561	5580	5274	5620	5356	
		70	5690	5255	5510	5275	5367	
		75	5375	5322	5491	5628	5714	
		80	5484	5549	5501	5642	5336	
		85	5633	5325	5344	5385	5526	
		90	5537	5256	5269	5594	5471	
		95	5264	5304	5697	5311	5472	

Type 6 Radar Waveform_23

Download	23	Type 6	1.0	333.3	9	0.3333	300.0000000	16
		Frequency List (MHz)	0	1	2	3	4	
		0	5538	5588	5671	5511	5441	
		5	5366	5494	5497	5389	5689	
		10	5472	5262	5620	5260	5577	
		15	5426	5433	5685	5499	5592	
		20	5618	5480	5380	5647	5507	
		25	5643	5250	5437	5276	5660	
		30	5442	5604	5719	5372	5263	
		35	5542	5451	5334	5305	5484	
		40	5489	5395	5656	5306	5356	
		45	5488	5285	5413	5713	5405	
		50	5458	5371	5254	5523	5696	
		55	5407	5460	5347	5537	5545	
		60	5363	5552	5510	5616	5581	
		65	5512	5634	5384	5716	5610	
		70	5599	5343	5669	5514	5296	
		75	5317	5654	5678	5564	5639	
		80	5617	5635	5653	5693	5431	
		85	5424	5376	5583	5691	5640	
		90	5668	5626	5703	5526	5723	
		95	5677	5579	5414	5670	5594	

Type 6 Radar Waveform_24

Download	24	Type 6	1.0	333.3	9	0.3333	300.0000000	18
		Frequency List (MHz)	0	1	2	3	4	
		0	5318	5352	5607	5672	5661	
		5	5408	5516	5572	5552	5421	
		10	5306	5526	5455	5598	5514	
		15	5463	5313	5544	5309	5529	
		20	5549	5321	5639	5577	5531	
		25	5348	5541	5310	5256	5646	
		30	5399	5344	5396	5570	5402	
		35	5255	5722	5487	5694	5420	
		40	5530	5538	5605	5488	5286	
		45	5439	5449	5359	5647	5289	
		50	5665	5494	5281	5693	5442	
		55	5477	5556	5418	5589	5512	
		60	5482	5474	5664	5278	5459	
		65	5555	5316	5307	5437	5456	
		70	5702	5613	5351	5697	5293	
		75	5638	5634	5296	5431	5724	
		80	5636	5434	5495	5656	5389	
		85	5330	5268	5403	5381	5411	
		90	5337	5581	5707	5575	5558	
		95	5517	5393	5689	5470	5265	

Type 6 Radar Waveform_25

Download	25	Type 6	1.0	333.3	9	0.3333	300.0000000	19
		Frequency List (MHz)	0	1	2	3	4	
		0	5476	5591	5543	5358	5503	
		5	5450	5441	5647	5715	5250	
		10	5712	5315	5324	5650	5619	
		15	5602	5590	5319	5492	5501	
		20	5537	5359	5253	5550	5322	
		25	5526	5551	5267	5344	5298	
		30	5535	5356	5559	5645	5390	
		35	5444	5346	5518	5640	5608	
		40	5259	5277	5468	5303	5417	
		45	5266	5522	5507	5412	5437	
		50	5366	5340	5583	5579	5637	
		55	5630	5431	5271	5252	5621	
		60	5677	5524	5306	5490	5352	
		65	5576	5408	5623	5674	5625	
		70	5310	5713	5675	5673	5607	
		75	5279	5485	5586	5717	5566	
		80	5312	5536	5629	5538	5434	
		85	5716	5718	5257	5381	5516	
		90	5601	5546	5652	5639	5293	
		95	5349	5636	5313	5473	5440	

Type 6 Radar Waveform_26

Download	26	Type 6	1.0	333.3	9	0.3333	300.0000000	14
		Frequency List (MHz)	0	1	2	3	4	
		0	5256	5355	5479	5519	5723	
		5	5492	5463	5722	5403	5457	
		10	5643	5579	5365	5370	5640	
		15	5690	5717	5422	5537	5315	
		20	5545	5309	5300	5720	5523	
		25	5685	5378	5657	5371	5437	
		30	5424	5313	5677	5322	5588	
		35	5583	5411	5415	5619	5573	
		40	5360	5406	5543	5599	5346	
		45	5624	5605	5565	5368	5324	
		50	5516	5542	5391	5294	5402	
		55	5484	5343	5385	5461	5531	
		60	5698	5275	5367	5469	5613	
		65	5413	5298	5302	5357	5627	
		70	5358	5421	5697	5296	5716	
		75	5524	5649	5686	5399	5628	
		80	5260	5363	5255	5496	5633	
		85	5375	5533	5349	5441	5276	
		90	5679	5338	5335	5289	5711	
		95	5658	5673	5650	5458	5563	

Type 6 Radar Waveform_27

Download	27	Type 6	1.0	333.3	9	0.3333	300.0000000	17
		Frequency List (MHz)	0	1	2	3	4	
		0	5511	5594	5415	5680	5565	
		5	5631	5388	5322	5469	5664	
		10	5477	5368	5406	5661	5303	
		15	5369	5525	5582	5507	5553	
		20	5475	5716	5334	5496	5476	
		25	5705	5385	5412	5479	5410	
		30	5270	5417	5571	5408	5722	
		35	5528	5682	5568	5533	5443	
		40	5686	5596	5653	5604	5688	
		45	5526	5421	5589	5295	5718	
		50	5442	5383	5603	5428	5434	
		55	5339	5651	5350	5669	5404	
		60	5532	5414	5445	5714	5719	
		65	5600	5306	5566	5665	5264	
		70	5699	5391	5282	5373	5625	
		75	5645	5448	5422	5674	5615	
		80	5365	5277	5535	5530	5544	
		85	5344	5593	5386	5537	5619	
		90	5401	5610	5435	5567	5677	
		95	5271	5281	5366	5301	5351	

Type 6 Radar Waveform_28

Download	28	Type 6	1.0	333.3	9	0.3333	300.0000000	15
		Frequency List (MHz)	0	1	2	3	4	
		0	5291	5358	5351	5269	5310	
		5	5673	5410	5397	5632	5493	
		10	5408	5254	5447	5663	5682	
		15	5294	5496	5628	5627	5699	
		20	5464	5544	5279	5326	5469	
		25	5364	5654	5588	5579	5446	
		30	5521	5299	5702	5723	5606	
		35	5386	5619	5478	5721	5348	
		40	5526	5660	5451	5593	5582	
		45	5584	5296	5474	5476	5646	
		50	5419	5472	5426	5275	5622	
		55	5293	5366	5547	5543	5533	
		60	5697	5359	5374	5637	5287	
		65	5255	5602	5400	5631	5502	
		70	5463	5268	5344	5601	5604	
		75	5320	5542	5342	5392	5475	
		80	5486	5596	5527	5361	5532	
		85	5722	5530	5340	5566	5292	
		90	5644	5317	5694	5362	5264	
		95	5280	5454	5429	5368	5511	

Type 6 Radar Waveform_29

Download	29	Type 6	1.0	333.3	9	0.3333	300.000000	20
		Frequency List (MHz)	0	1	2	3	4	
		0	5546	5597	5287	5430	5627	
		5	5715	5335	5472	5320	5700	
		10	5717	5518	5488	5383	5703	
		15	5382	5526	5256	5575	5416	
		20	5710	5695	5415	5442	5252	
		25	5506	5316	5305	5480	5660	
		30	5663	5659	5372	5497	5426	
		35	5428	5332	5274	5496	5458	
		40	5662	5706	5596	5691	5687	
		45	5414	5564	5379	5642	5527	
		50	5266	5522	5595	5544	5561	
		55	5724	5694	5722	5459	5366	
		60	5514	5387	5401	5681	5463	
		65	5708	5679	5541	5707	5632	
		70	5351	5347	5449	5577	5563	
		75	5289	5388	5678	5644	5314	
		80	5650	5661	5524	5556	5374	
		85	5342	5398	5391	5558	5637	
		90	5298	5688	5711	5381	5346	
		95	5259	5557	5495	5580	5517	

Appendix B – Test Setup Photograph

Refer to “2202RSU049-UT” file.

Appendix C – EUT Photograph

Refer to “2202RSU049-UE” file.

————— The End —————