

FCC 47 CFR PART 15 SUBPART C

TEST REPORT

For

HD IP Camera

Model:

OC830xxxxxxxx (the 1st x should be "blank" or "-"; the rest x could be 0 to 9, A to Z, "blank" or "-" , for marking purpose)

Trade Name: Sercomm

Issued to

Sercomm Corporation

8F, No. 3-1, YuanQu St., NanKang, Taipei 115, Taiwan, R.O.C.

Issued by

Compliance Certification Services Inc.

No.11, Wugong 6th Rd., Wugu Dist.,
New Taipei City 24891, Taiwan. (R.O.C.)

<http://www.ccsrf.com>

service@ccsrf.com

Issued Date: June 5, 2015



Note: This report shall not be reproduced except in full, without the written approval of Compliance Certification Services Inc. This document may be altered or revised by Compliance Certification Services Inc. personnel only, and shall be noted in the revision section of the document.

Revision History

Rev.	Issue Date	Revisions	Effect Page	Revised By
00	June 5, 2015	Initial Issue	ALL	Becca Chen

TABLE OF CONTENTS

1. TEST RESULT CERTIFICATION.....	4
2. EUT DESCRIPTION	5
3. TEST METHODOLOGY	6
3.1 EUT CONFIGURATION	6
3.2 EUT EXERCISE.....	6
3.3 GENERAL TEST PROCEDURES	6
3.4 FCC PART 15.205 RESTRICTED BANDS OF OPERATIONS	7
3.5 DESCRIPTION OF TEST MODES	8
4. INSTRUMENT CALIBRATION.....	9
4.1 MEASURING INSTRUMENT CALIBRATION	9
4.2 MEASUREMENT EQUIPMENT USED.....	9
4.3 MEASUREMENT UNCERTAINTY	10
5. FACILITIES AND ACCREDITATIONS	11
5.1 FACILITIES	11
5.2 EQUIPMENT	11
5.3 TABLE OF ACCREDITATIONS AND LISTINGS.....	12
6. SETUP OF EQUIPMENT UNDER TEST	13
6.1 SETUP CONFIGURATION OF EUT.....	13
6.2 SUPPORT EQUIPMENT.....	13
7. FCC PART 15.247 REQUIREMENTS.....	14
7.1 6DB BANDWIDTH	14
7.2 PEAK POWER	34
7.3 AVERAGE POWER	36
7.4 BAND EDGES MEASUREMENT	38
7.5 PEAK POWER SPECTRAL DENSITY	68
7.6 SPURIOUS EMISSIONS	88
7.7 RADIATED EMISSIONS	107
7.8 POWERLINE CONDUCTED EMISSIONS.....	124
APPENDIX I PHOTOGRAPHS OF TEST SETUP.....	127
APPENDIX 1 - PHOTOGRAPHS OF EUT	

1. TEST RESULT CERTIFICATION

Applicant: Sercomm Corporation
 8F, No. 3-1, YuanQu St., NanKang, Taipei 115, Taiwan, R.O.C.

Equipment Under Test: HD IP Camera

Trade Name: Sercomm

Model Number: OC830xxxxxxxx (the 1st x should be "blank" or "-"; the rest x could be 0 to 9, A to Z, "blank" or "--", for marking purpose)

Date of Test: May 28 ~ June 3, 2015

APPLICABLE STANDARDS	
STANDARD	TEST RESULT
FCC 47 CFR Part 15 Subpart C	No non-compliance noted

We hereby certify that:

The above equipment was tested by Compliance Certification Services Inc. The test data, data evaluation, test procedures, and equipment configurations shown in this report were made in accordance with the procedures given in ANSI C63.10: 2009 and the energy emitted by the sample EUT tested as described in this report is in compliance with the requirements of FCC Rules Part 15.207, 15.209, 15.247.

The test results of this report relate only to the tested sample EUT identified in this report.

Approved by:

Reviewed by:



 Miller Lee
 Manager
 Compliance Certification Services Inc.

 Angel Cheng
 Section Manager
 Compliance Certification Services Inc.

2. EUT DESCRIPTION

Product	HD IP Camera			
Trade Name	Sercomm			
Model Number	OC830xxxxxxxx (the 1st x should be "blank" or "-"; the rest x could be 0 to 9, A to Z, "blank" or “-“, for marking purpose)			
Received Date	May 8, 2015			
Power Adapter	Asian Power Devices Inc. Model: WA-18D12FU I/P: 100-240V, 50-60Hz, 0.5A MAX O/P: 12V, 1.5A			
Frequency Range	2412 ~ 2462 MHz			
Transmit Power	Mode	Frequency Range	Output Power (dBm)	Output Power (W)
	802.11b	2412 - 2462	20.64	0.1159
	802.11g	2412 - 2462	25.62	0.3648
	802.11n Standard-20 MHz	2412 - 2462	27.67	0.5848
	802.11n Standard-40 MHz	2422 - 2452	27.32	0.5395
Modulation Technique	IEEE 802.11b mode: DSSS (1, 2, 5.5 and 11 Mbps) IEEE 802.11g mode: OFDM (6, 9, 12, 18, 24, 36, 48 and 54 Mbps) IEEE 802.11n HT 20 MHz mode Channel mode: OFDM (6.5, 7.2, 13, 14.4, 14.44, 19.5, 21.7, 26, 28.89, 28.9, 39, 43.3, 43.33 52, 57.78, 57.8, 58.5, 65.0, 72.2, 78, 86.67, 104, 115.56, 117, 130, 144.44 Mbps) IEEE 802.11n HT 40 MHz mode: OFDM (13.5, 15, 27, 30, 40.5, 45, 54, 60, 81, 90, 108, 120, 121.5, 135, 150, 162, 180, 216, 240, 243, 270, 300 Mbps)			
Number of Channels	IEEE 802.11b/g mode: 11 Channels IEEE 802.11n HT 20 MHz mode: 11 Channels IEEE 802.11n HT 40 MHz mode: 7 Channels			
Antenna Specification	PIFA Antenna / 2.52dBi			

Remark:

1. The sample selected for test was engineering sample that approximated to production product and was provided by manufacturer.
2. This submittal(s) (test report) is intended for FCC ID: **P27OC830** filing to comply with Section 15.207, 15.209 and 15.247 of the FCC Part 15, Subpart C Rules.

3. TEST METHODOLOGY

The tests documented in this report were performed in accordance with ANSI C63.10: 2009 and FCC CFR 47 Part 15.207, 15.209, 15.247 and KDB558074.

3.1 EUT CONFIGURATION

The EUT configuration for testing is installed on RF field strength measurement to meet the Commissions requirement and operating in a manner that intends to maximize its emission characteristics in a continuous normal application.

3.2 EUT EXERCISE

The EUT was operated in the engineering mode to fix the TX frequency that was for the purpose of the measurements.

According to its specifications, the EUT must comply with the requirements of the Section 15.207, 15.209 and 15.247 under the FCC Rules Part 15 Subpart C.

3.3 GENERAL TEST PROCEDURES

Conducted Emissions

The EUT is placed on the turntable, which is 0.8 m above ground plane. According to the requirements in Section 13.1.4.1 of ANSI C63.10: 2009 Conducted emissions from the EUT measured in the frequency range between 0.15 MHz and 30MHz using CISPR Quasi-peak and average detector modes.

Radiated Emissions

The EUT is placed on a turn table, which is 1.5 m above ground plane. The turntable shall rotate 360 degrees to determine the position of maximum emission level. EUT is set 3m away from the receiving antenna, which varied from 1m to 4m to find out the highest emission. And also, each emission was to be maximized by changing the polarization of receiving antenna both horizontal and vertical. In order to find out the maximum emissions, exploratory radiated emission measurements were made according to the requirements in Section 13.1.4.1 of ANSI C63.10: 2009.

3.4 FCC PART 15.205 RESTRICTED BANDS OF OPERATIONS

(a) Except as shown in paragraph (d) of this section, only spurious emissions are permitted in any of the frequency bands listed below:

MHz	MHz	MHz	GHz
0.090 - 0.110	16.42 - 16.423	399.9 - 410	4.5 - 5.15
¹ 0.495 - 0.505	16.69475 - 16.69525	608 - 614	5.35 - 5.46
2.1735 - 2.1905	16.80425 - 16.80475	960 - 1240	7.25 - 7.75
4.125 - 4.128	25.5 - 25.67	1300 - 1427	8.025 - 8.5
4.17725 - 4.17775	37.5 - 38.25	1435 - 1626.5	9.0 - 9.2
4.20725 - 4.20775	73 - 74.6	1645.5 - 1646.5	9.3 - 9.5
6.215 - 6.218	74.8 - 75.2	1660 - 1710	10.6 - 12.7
6.26775 - 6.26825	108 - 121.94	1718.8 - 1722.2	13.25 - 13.4
6.31175 - 6.31225	123 - 138	2200 - 2300	14.47 - 14.5
8.291 - 8.294	149.9 - 150.05	2310 - 2390	15.35 - 16.2
8.362 - 8.366	156.52475 -	2483.5 - 2500	17.7 - 21.4
8.37625 - 8.38675	156.52525	2655 - 2900	22.01 - 23.12
8.41425 - 8.41475	156.7 - 156.9	3260 - 3267	23.6 - 24.0
12.29 - 12.293	162.0125 - 167.17	3332 - 3339	31.2 - 31.8
12.51975 - 12.52025	167.72 - 173.2	3345.8 - 3358	36.43 - 36.5
12.57675 - 12.57725	240 - 285	3600 - 4400	(²)
13.36 - 13.41	322 - 335.4		

¹ Until February 1, 1999, this restricted band shall be 0.490-0.510 MHz.

² Above 38.6

(b) Except as provided in paragraphs (d) and (e), the field strength of emissions appearing within these frequency bands shall not exceed the limits shown in Section 15.209. At frequencies equal to or less than 1000 MHz, compliance with the limits in Section 15.209 shall be demonstrated using measurement instrumentation employing a CISPR quasi-peak detector. Above 1000 MHz, compliance with the emission limits in Section 15.209 shall be demonstrated based on the average value of the measured emissions. The provisions in Section 15.35 apply to these measurements.

3.5 DESCRIPTION OF TEST MODES

The EUT (model: OC835-ADT) had been tested under operating condition.

Software used to control the EUT for staying in continuous transmitting mode was programmed.

After verification, all tests were carried out with the worst case test modes as shown below except radiated spurious emission below 1GHz and power line conducted emissions below 30MHz, which worst case was in normal link mode only.

The EUT is a 2x2 configuration spatial MIMO (2Tx & 2Rx) without beam forming function that operate in double TX chains and double RX chains. The 2x2 configuration is implemented with two outside TX & RX chains (Chain 0 and 1).

IEEE 802.11b mode:

Channel Low (2412MHz), Channel Mid (2437MHz) and Channel High (2462MHz) with 1Mbps data rate were chosen for full testing.

IEEE 802.11g mode:

Channel Low (2412MHz), Channel Mid (2437MHz) and Channel High (2462MHz) with 6Mbps data rate were chosen for full testing.

IEEE 802.11n HT 20 MHz mode:

Channel Low (2412MHz), Channel Mid (2437MHz) and Channel High (2462MHz) with 6.5Mbps data rate were chosen for full testing.

IEEE 802.11n HT 40 MHz mode:

Channel Low (2422MHz), Channel Mid (2437MHz) and Channel High (2452MHz) with 13.5Mbps data rate were chosen for full testing.

The field strength of spurious emission was measured in the following position: EUT stand-up position (Z axis), lie-down position (X, Y axis) and laptop mode. The worst emission was found in stand-up position (Z axis) and the worst case was recorded.

4. INSTRUMENT CALIBRATION

4.1 MEASURING INSTRUMENT CALIBRATION

The measuring equipment, which was utilized in performing the tests documented herein, has been calibrated in accordance with the manufacturer's recommendations for utilizing calibration equipment, which is traceable to recognized national standards.

4.2 MEASUREMENT EQUIPMENT USED

Equipment Used for Emissions Measurement

Remark: Each piece of equipment is scheduled for calibration once a year and Loop Antenna is scheduled for calibration once three years.

Conducted Emissions Test Site				
Name of Equipment	Manufacturer	Model	Serial Number	Calibration Due
Spectrum Analyzer	Agilent	E4446A	US42510252	11/23/2015
Thermostatic/Hrgrosatic Chamber	TAICHY	MHG-150LF	930619	10/07/2015
AC Power Source	EXTECH	6205	1140845	N.C.R
DC Power Supply	ABM	8301HD	D011531	N.C.R
Power Meter	Anritsu	ML2495A	1012009	06/03/2015
Power Sensor	Anritsu	MA2411A	0917072	06/03/2015
Spectrum Analyzer	ROHDE&SCHWARZ	FSV40	101073	07/09/2015

Wugu 966 Chamber A				
Name of Equipment	Manufacturer	Model	Serial Number	Calibration Due
Spectrum Analyzer	Agilent	E4446A	US42510268	01/25/2016
EMI Test Receiver	R&S	ESCI	100064	05/30/2015
Bilog Antenna	Sunol Sciences	JB3	A030105	08/19/2015
Horn Antenna	EMCO	3117	00055165	01/26/2016
Turn Table	CCS	CC-T-1F	N/A	N.C.R
Antenna Tower	CCS	CC-A-1F	N/A	N.C.R
Controller	CCS	CC-C-1F	N/A	N.C.R
Test S/W	EZ-EMC (CCS-3A1RE)			

Conducted Emission room # A				
Name of Equipment	Manufacturer	Model	Serial Number	Calibration Due
TEST RECEIVER	R&S	ESCI	101201	08/31/2015
LISN (EUT)	SCHWARZBECK	NSLK 8127	8127527	08/28/2015
LISN	SCHWARZBECK	NSLK 8127	8127526	08/28/2015
BNC CABLE	EMCI	CFD300-NL	BNC#A7	04/08/2016
Pulse Limiter	R&S	ESH3-Z2	C3010026-2	08/26/2015
THERMO-HYGRO METER	WISEWIND	201A	No. 02	05/10/2016
Test S/W	EZ-EMC			

4.3 MEASUREMENT UNCERTAINTY

PARAMETER	UNCERTAINTY
Powerline Conducted Emission	+/- 1.59
3M Semi Anechoic Chamber / 30M~200M	+/- 4.0138
3M Semi Anechoic Chamber / 200M~1000M	+/- 3.9483
3M Semi Anechoic Chamber / 1G~8G	+/- 2.5975
3M Semi Anechoic Chamber / 8G~18G	+/- 2.6112
3M Semi Anechoic Chamber / 18G~26G	+/- 2.7389
3M Semi Anechoic Chamber / 26G~40G	+/- 2.9683

Remark: This uncertainty represents an expanded uncertainty expressed at approximately the 95% confidence level using a coverage factor of $k=2$.

5. FACILITIES AND ACCREDITATIONS

5.1 FACILITIES

All measurement facilities used to collect the measurement data are located at

- No.139, Wugong Rd., Wugu Dist., New Taipei City 24891, Taiwan (R.O.C.)
Tel: 886-2-2298-4086 / Fax: 886-2-2298-1470
- No.11, Wugong 6th Rd., Wugu Dist., New Taipei City 24891, Taiwan. (R.O.C.)
Tel: 886-2-2299-9720 / Fax: 886-2-2298-4045
- No.81-1, Lane 210, Bade 2nd Rd., Lujhu Township, Taoyuan County 33841, TAIWAN, R.O.C.
Tel: 886-3-324-0332 / Fax: 886-3-324-5235
- No.163-1, Jhongsheng Rd. Sindian City, Taipei County 23151, Taiwan.
Tel: 886-2-2217-0894 / Fax: 886-2-2217-1029

*The powerline conducted emissions test items was tested at Compliance Certification Services Inc. (Sindian Lab.)
The test equipments were listed in page 9 and the test data, please refer page 125-126.*

The sites are constructed in conformance with the requirements of ANSI C63.7, ANSI C63.10: 2009 and CISPR Publication 22.

5.2 EQUIPMENT



Radiated emissions are measured with one or more of the following types of linearly polarized antennas: tuned dipole, biconical, log periodic, bi-log, and/or ridged waveguide, horn. Spectrum analyzers with pre-selectors and quasi-peak detectors are used to perform radiated measurements.

Conducted emissions are measured with Line Impedance Stabilization Networks and EMI Test Receivers.

Calibrated wideband preamplifiers, coaxial cables, and coaxial attenuators are also used for making measurements.

All receiving equipment conforms to CISPR Publication 16-1, "Radio Interference Measuring Apparatus and Measurement Methods."

5.3 TABLE OF ACCREDITATIONS AND LISTINGS

Country	Agency	Scope of Accreditation	Logo
USA	FCC	3M Semi Anechoic Chamber (FCC MRA: TW1039) to perform FCC Part 15 measurements	 FCC MRA: TW1039
Taiwan	TAF	LP0002, RTTE01, FCC Method-47 CFR Part 15 Subpart C, D, E, RSS-210, RSS-310 IDA TS SRD, AS/NZS 4268, AS/NZS 4771, TS 12.1 & 12.2, ETSI EN 300 440-1, ETSI EN 300 440-2, ETSI EN 300 328, ETSI EN 300 220-1, ETSI EN 300 220-2, ETSI EN 301 893, ETSI EN 301 489-1/3/7/17 FCC OET Bulletin 65 + Supplement C, EN 50360, EN 50361, EN 50371, RSS 102, EN 50383, EN 50385, EN 50392, IEC 62209, CNS 14958-1, CNS 14959 FCC Method -47 CFR Part 15 Subpart B IEC / EN 61000-3-2, IEC / EN 61000-3-3, IEC / EN 61000-4-2/3/4/5/6/8/11	 Testing Laboratory 1309
Canada	Industry Canada	3M Semi Anechoic Chamber (IC 2324G-1 / IC 2324G-2) to perform	 Canada IC 2324G-1 IC 2324G-2

* No part of this report may be used to claim or imply product endorsement by A2LA or any agency of the US Government.

6. SETUP OF EQUIPMENT UNDER TEST

6.1 SETUP CONFIGURATION OF EUT

See test photographs attached in Appendix II for the actual connections between EUT and support equipment.

6.2 SUPPORT EQUIPMENT

No	Equipment	Brand	Model	Series No.	FCC ID	Data Cable	Power Cord
1	Notebook PC (For Radiation)	IBM	7663 (T61)	L3E9812	N/A	N/A	AC I/P: Unshielded, 1.8m DC O/P: Unshielded, 1.8m with a core
2.	Server Notebook (Remote) (For Conduction)	DELL	E5420	6YRVLQ1	DOC BSMI: R33002	Unshielded, 20m	Unshielded, 1.8m

Remark:

1. All the equipment/cables were placed in the worst-case configuration to maximize the emission during the test.
2. Grounding was established in accordance with the manufacturer's requirements and conditions for the intended use.

7. FCC PART 15.247 REQUIREMENTS

7.1 6DB BANDWIDTH

LIMIT

According to §15.247(a)(2), systems using digital modulation techniques may operate in the 902 - 928 MHz, 2400 - 2483.5 MHz, and 5725 - 5850 MHz bands. The minimum 6dB bandwidth shall be at least 500 kHz.

Test Configuration

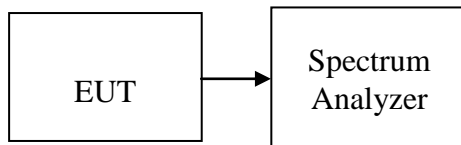

TEST PROCEDURE

1. Place the EUT on the table and set it in the transmitting mode.
2. Remove the antenna from the EUT and then connect a low loss RF cable from the antenna port to the spectrum analyzer.
3. Set the spectrum analyzer as RBW = 300 kHz, VBW = 1000 kHz, Sweep = auto.
4. Mark the peak frequency and -6dB (upper and lower) frequency.
5. Repeat until all the rest channels are investigated.

TEST RESULTS

No non-compliance noted.

Test Data

Test mode: IEEE 802.11b mode

Channel	Frequency (MHz)	Bandwidth (MHz)	Limit (kHz)	Result
Low	2412	10.3334	>500	PASS
Mid	2437	10.3334		PASS
High	2462	10.3334		PASS

Test mode: IEEE 802.11g mode

Channel	Frequency (MHz)	Bandwidth (MHz)	Limit (kHz)	Result
Low	2412	16.8333	>500	PASS
Mid	2437	16.8333		PASS
High	2462	16.8333		PASS

Test mode: IEEE 802.11n HT 20 MHz mode / Chain 0

Channel	Frequency (MHz)	Bandwidth (MHz)	Limit (kHz)	Result
Low	2412	17.8334	>500	PASS
Mid	2437	17.8334		PASS
High	2462	17.8334		PASS

Test mode: IEEE 802.11n HT 20 MHz mode / Chain 1

Channel	Frequency (MHz)	Bandwidth (MHz)	Limit (kHz)	Result
Low	2412	17.8334	>500	PASS
Mid	2437	17.8334		PASS
High	2462	17.8334		PASS

Test mode: IEEE 802.11n HT 40 MHz mode / Chain 0

Channel	Frequency (MHz)	Bandwidth (MHz)	Limit (kHz)	Result
Low	2422	36.4167	>500	PASS
Mid	2437	36.4167		PASS
High	2452	36.4167		PASS

Test mode: IEEE 802.11n HT 40 MHz mode / Chain 1

Channel	Frequency (MHz)	Bandwidth (MHz)	Limit (kHz)	Result
Low	2422	36.4166	>500	PASS
Mid	2437	36.5		PASS
High	2452	36.5		PASS

Test Plot

IEEE 802.11b mode

6dB Bandwidth (CH Low)

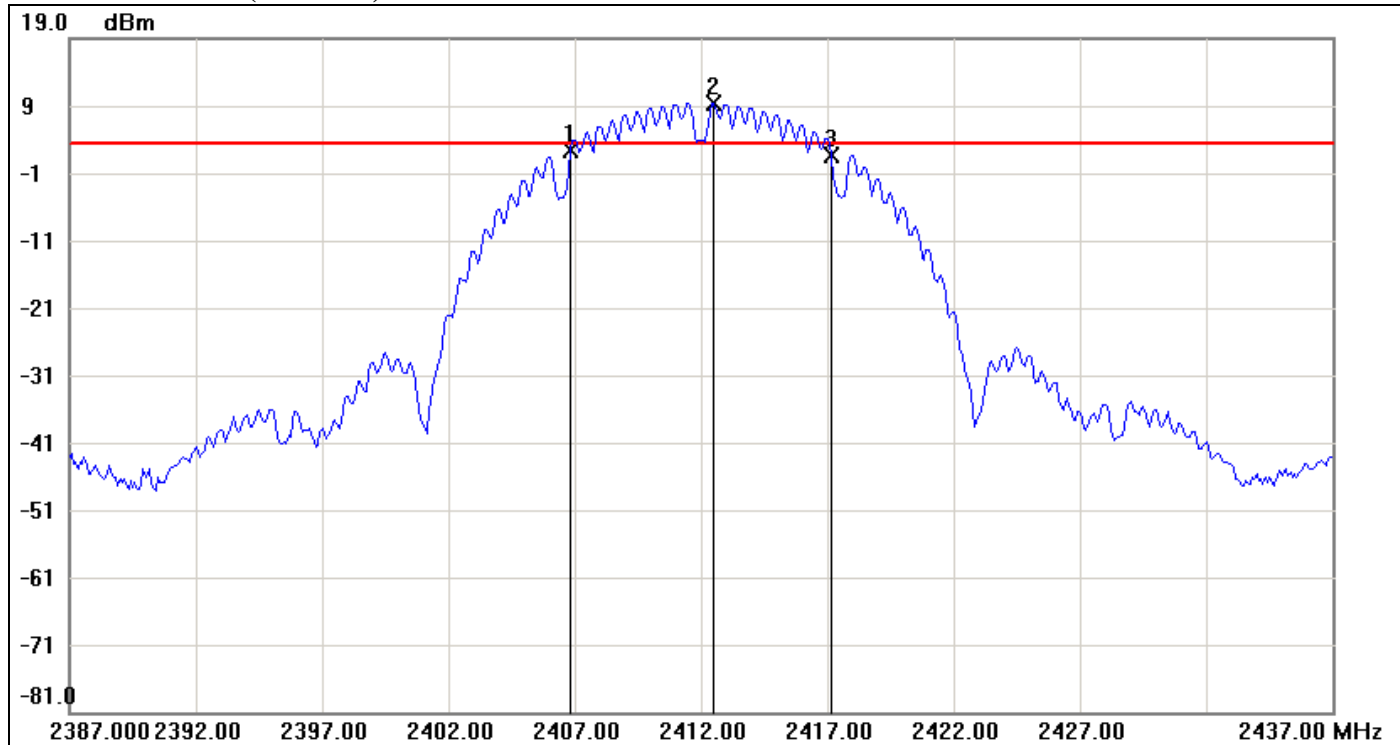

No.	Frequency(MHz)	Result(dBm)	Limit(dBm)	Margin(dBm)
1	2406.8333	2.24	3.38	-1.14
2	2412.5000	9.38	3.38	6.00
3	2417.1667	1.57	3.38	-1.81

No.		Δ Frequency(MHz)	Δ Level(dB)
1	mk3-mk1	10.3334	-0.67

6dB Bandwidth (CH Mid)

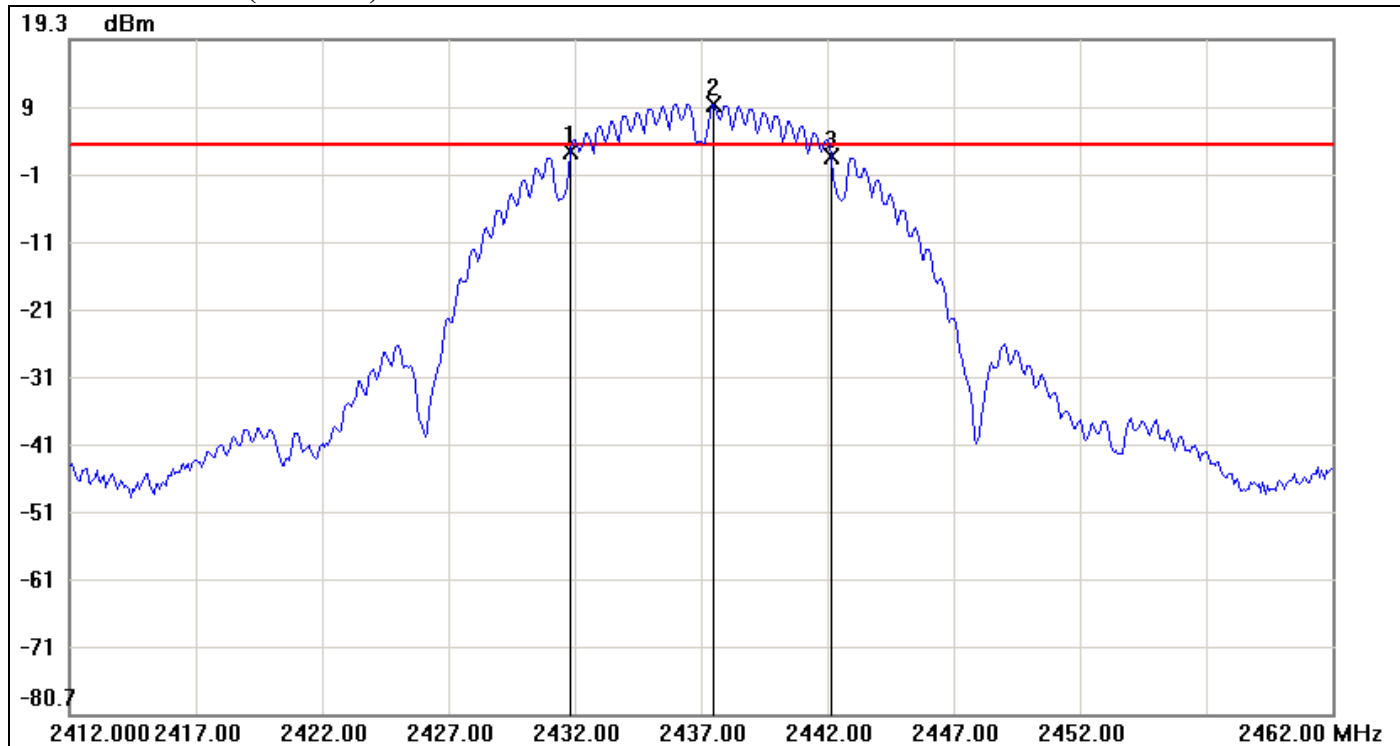

No.	Frequency(MHz)	Result(dBm)	Limit(dBm)	Margin(dBm)
1	2431.8333	2.79	3.77	-0.98
2	2437.5000	9.77	3.77	6.00
3	2442.1667	1.88	3.77	-1.89

No.		Δ Frequency(MHz)	Δ Level(dB)
1	mk3-mk1	10.3334	-0.91

6dB Bandwidth (CH High)

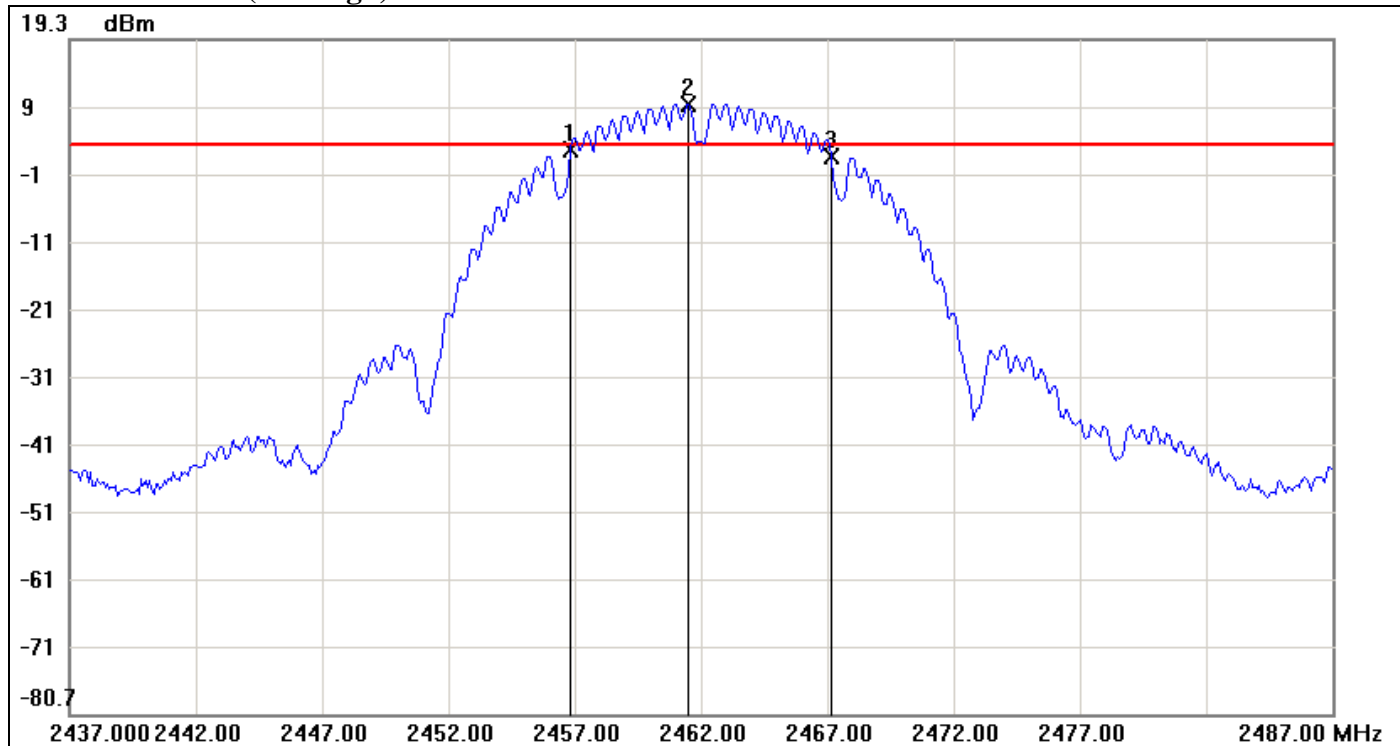

No.	Frequency(MHz)	Result(dBm)	Limit(dBm)	Margin(dBm)
1	2456.8333	2.94	3.75	-0.81
2	2461.5000	9.75	3.75	6.00
3	2467.1667	1.84	3.75	-1.91

No.		Δ Frequency(MHz)	Δ Level(dB)
1	mk3-mk1	10.3334	-1.1

IEEE 802.11g mode

6dB Bandwidth (CH Low)

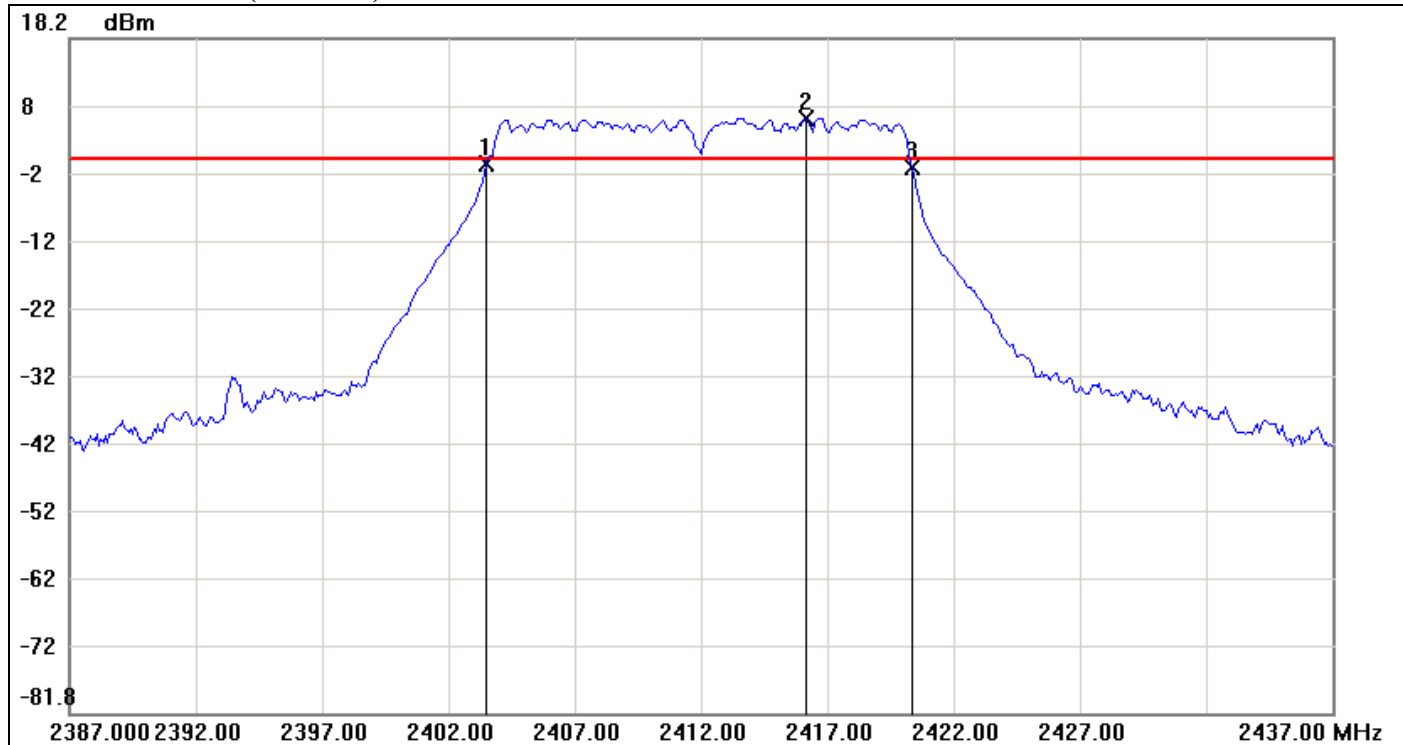

No.	Frequency(MHz)	Result(dBm)	Limit(dBm)	Margin(dBm)
1	2403.5000	-0.36	0.44	-0.80
2	2416.1667	6.44	0.44	6.00
3	2420.3333	-0.86	0.44	-1.30

No.		Δ Frequency(MHz)	Δ Level(dB)
1	mk3-mk1	16.8333	-0.5

6dB Bandwidth (CH Mid)

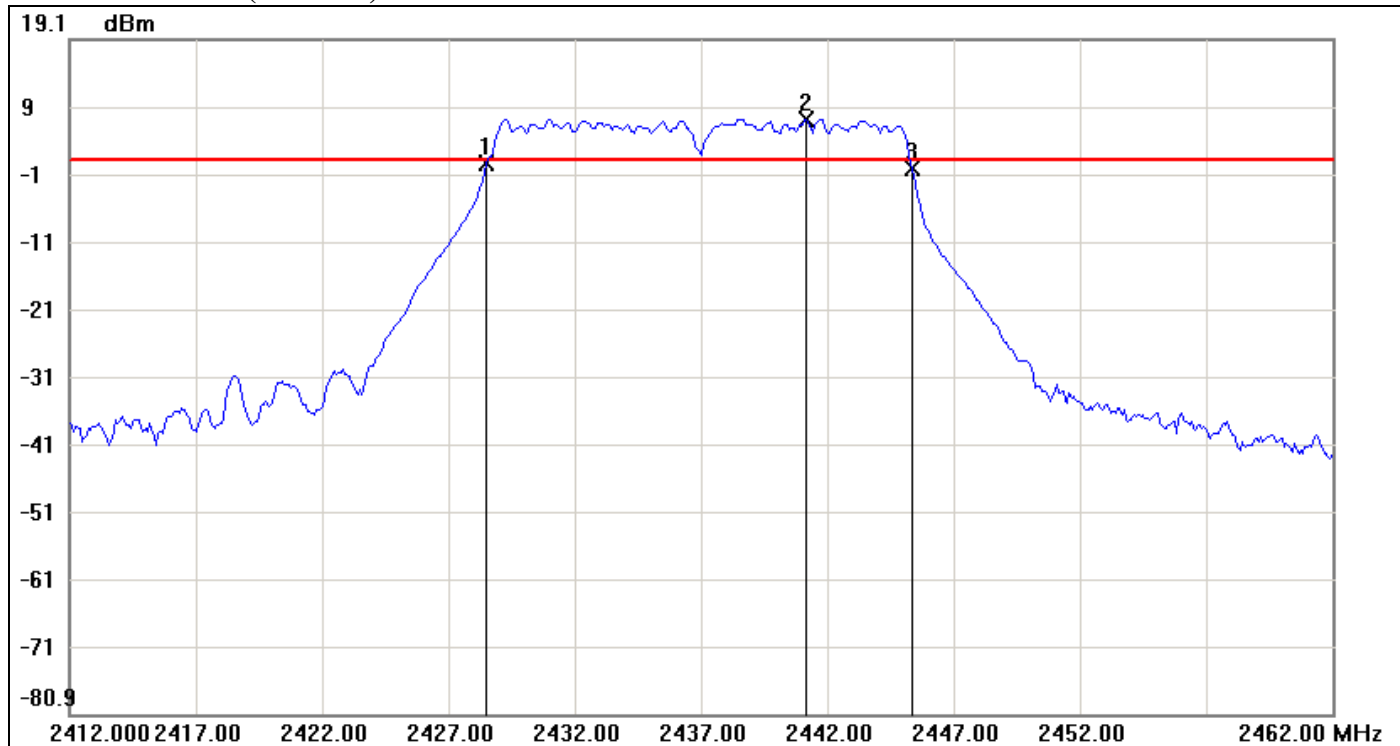

No.	Frequency(MHz)	Result(dBm)	Limit(dBm)	Margin(dBm)
1	2428.5000	0.69	1.29	-0.60
2	2441.1667	7.29	1.29	6.00
3	2445.3333	-0.03	1.29	-1.32

No.		Δ Frequency(MHz)	Δ Level(dB)
1	mk3-mk1	16.8333	-0.72

6dB Bandwidth (CH High)

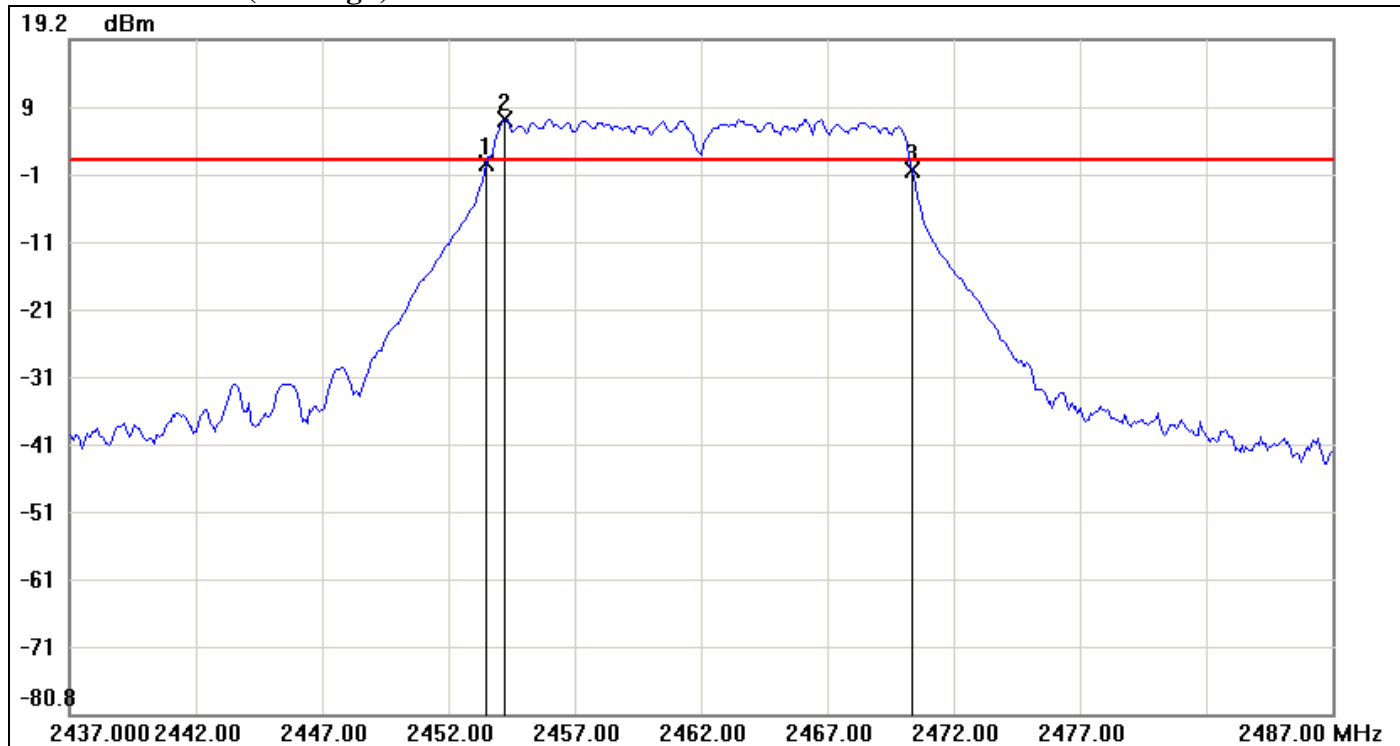

No.	Frequency(MHz)	Result(dBm)	Limit(dBm)	Margin(dBm)
1	2453.5000	0.89	1.38	-0.49
2	2454.2500	7.38	1.38	6.00
3	2470.3333	-0.26	1.38	-1.64

No.		Δ Frequency(MHz)	Δ Level(dB)
1	mk3-mk1	16.8333	-1.15

IEEE 802.11n HT 20 MHz mode / Chain 0

6dB Bandwidth (CH Low)

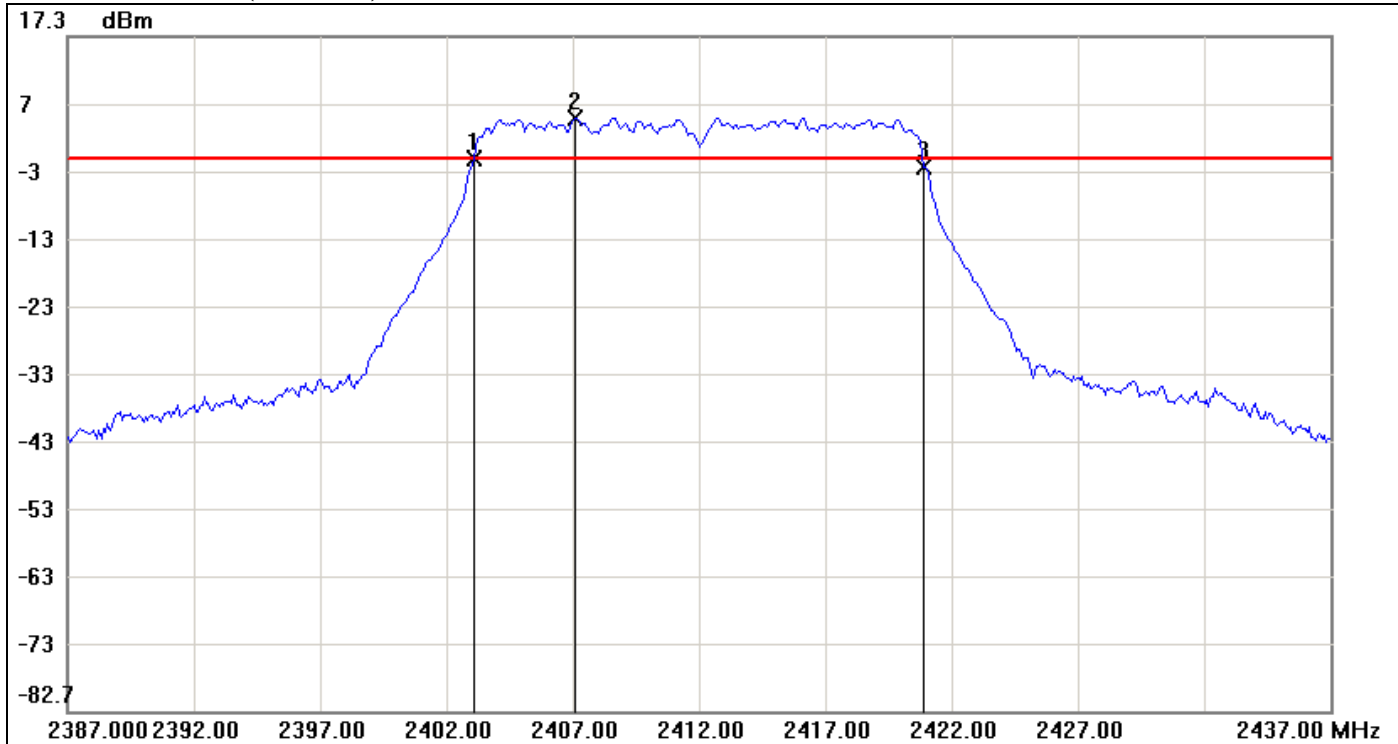

No.	Frequency(MHz)	Result(dBm)	Limit(dBm)	Margin(dBm)
1	2403.0833	-0.86	-0.76	-0.10
2	2407.0833	5.24	-0.76	6.00
3	2420.9167	-2.19	-0.76	-1.43

No.		Δ Frequency(MHz)	Δ Level(dB)
1	mk3-mk1	17.8334	-1.33

6dB Bandwidth (CH Mid)

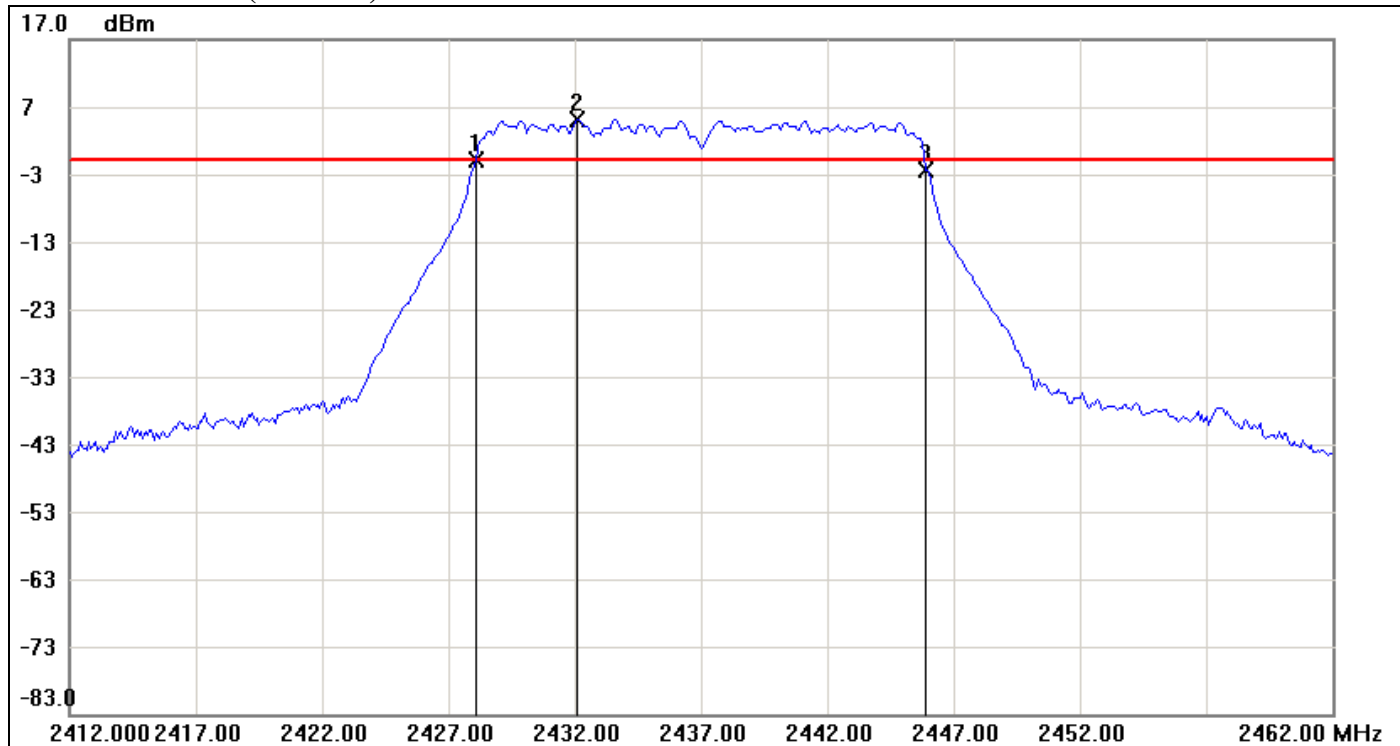

No.	Frequency(MHz)	Result(dBm)	Limit(dBm)	Margin(dBm)
1	2428.0833	-0.94	-0.82	-0.12
2	2432.0833	5.18	-0.82	6.00
3	2445.9167	-2.30	-0.82	-1.48

No.		Δ Frequency(MHz)	Δ Level(dB)
1	mk3-mk1	17.8334	-1.36

6dB Bandwidth (CH High)

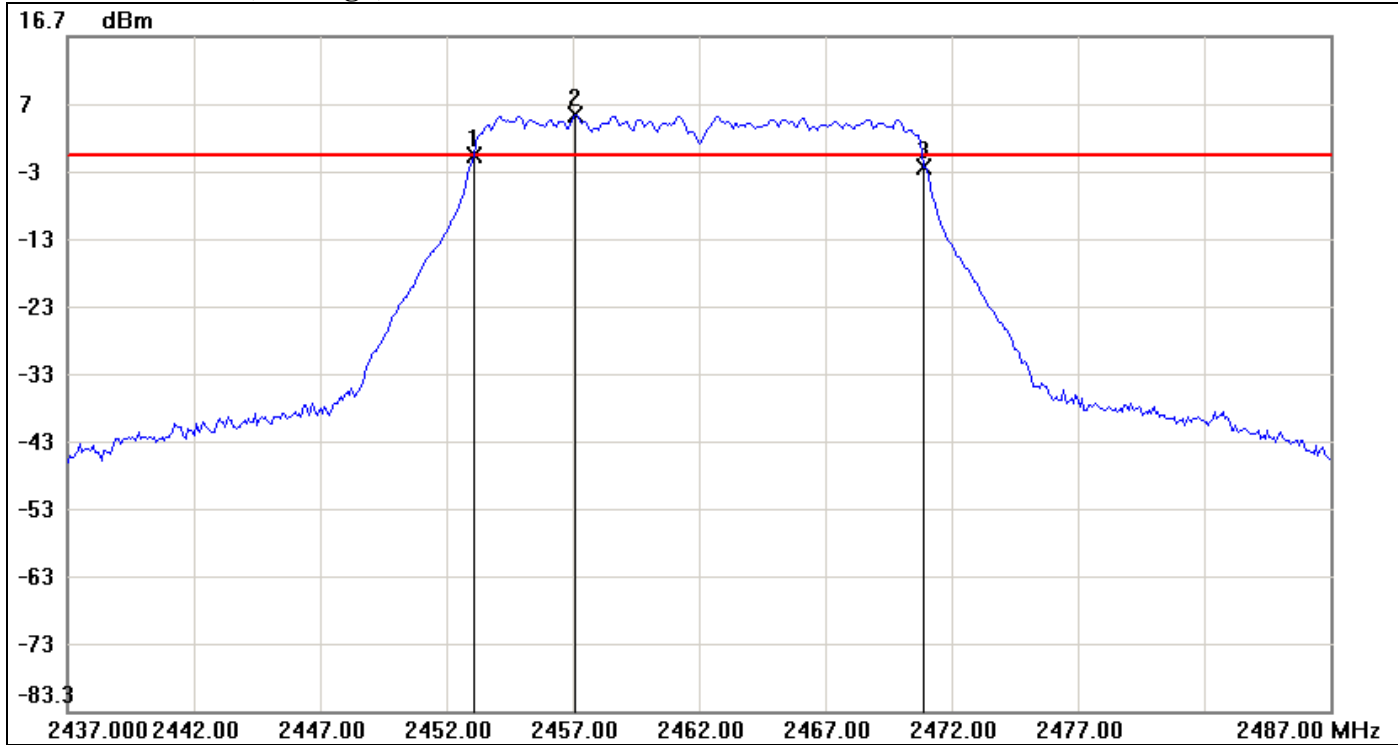

No.	Frequency(MHz)	Result(dBm)	Limit(dBm)	Margin(dBm)
1	2453.0833	-0.97	-0.87	-0.10
2	2457.0833	5.13	-0.87	6.00
3	2470.9167	-2.73	-0.87	-1.86

No.		Δ Frequency(MHz)	Δ Level(dB)
1	mk3-mk1	17.8334	-1.76

IEEE 802.11n HT 20 MHz mode / Chain 1

6dB Bandwidth (CH Low)

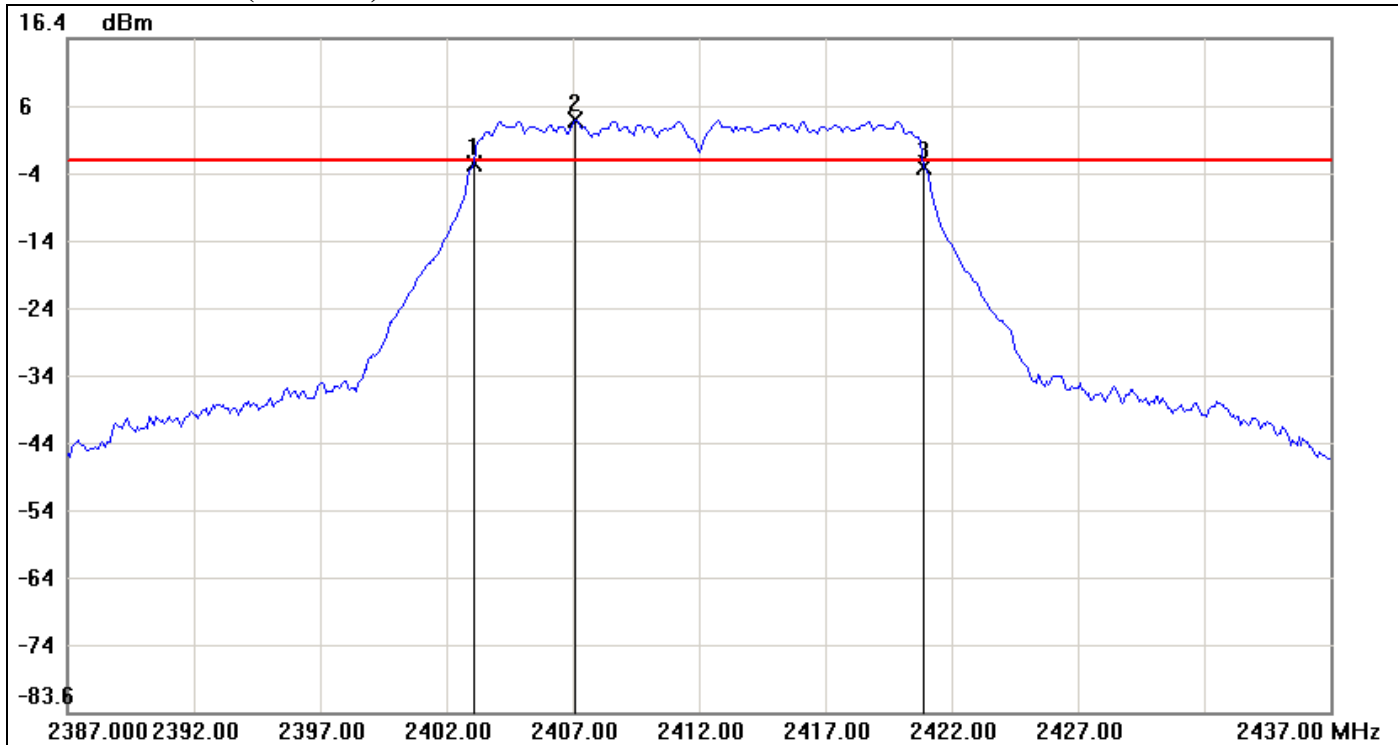

No.	Frequency(MHz)	Result(dBm)	Limit(dBm)	Margin(dBm)
1	2403.0833	-2.13	-1.76	-0.37
2	2407.0833	4.24	-1.76	6.00
3	2420.9167	-2.78	-1.76	-1.02

No.		Δ Frequency(MHz)	Δ Level(dB)
1	mk3-mk1	17.8334	-0.65

6dB Bandwidth (CH Mid)

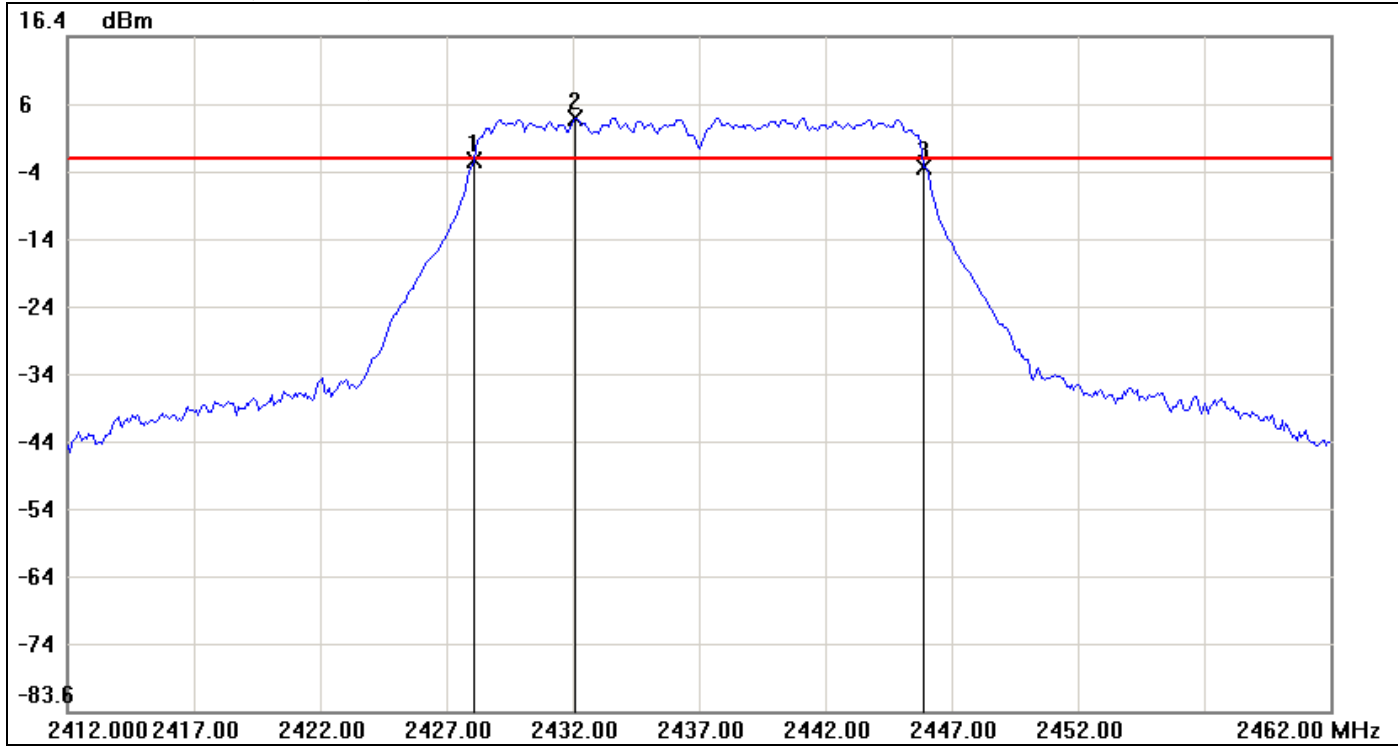

No.	Frequency(MHz)	Result(dBm)	Limit(dBm)	Margin(dBm)
1	2428.0833	-2.01	-1.62	-0.39
2	2432.0833	4.38	-1.62	6.00
3	2445.9167	-2.90	-1.62	-1.28

No.		Δ Frequency(MHz)	Δ Level(dB)
1	mk3-mk1	17.8334	-0.89

6dB Bandwidth (CH High)

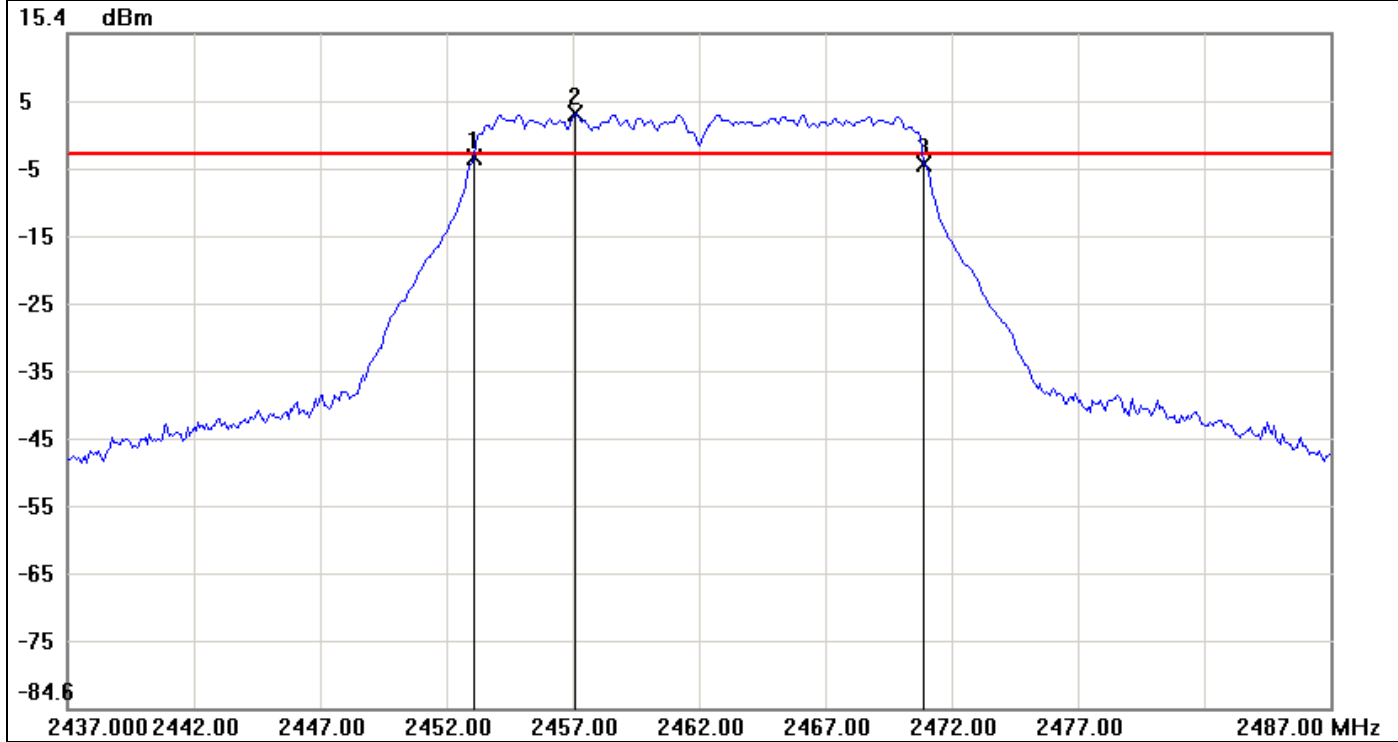

No.	Frequency(MHz)	Result(dBm)	Limit(dBm)	Margin(dBm)
1	2453.0833	-2.91	-2.61	-0.30
2	2457.0833	3.39	-2.61	6.00
3	2470.9167	-3.95	-2.61	-1.34

No.		Δ Frequency(MHz)	Δ Level(dB)
1	mk3-mk1	17.8334	-1.04

IEEE 802.11n HT 40 MHz mode / Chain 0

6dB Bandwidth (CH Low)

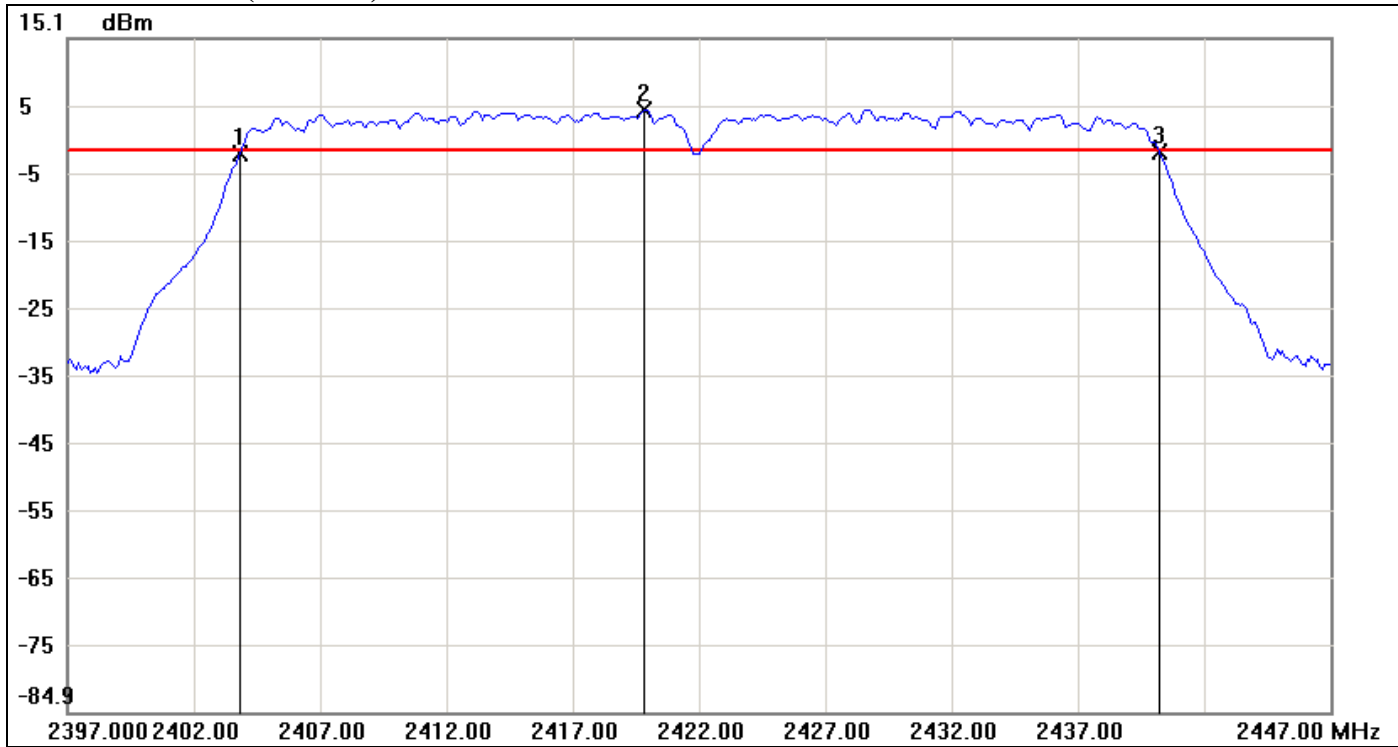

No.	Frequency(MHz)	Result(dBm)	Limit(dBm)	Margin(dBm)
1	2403.8333	-2.07	-1.49	-0.58
2	2419.8333	4.51	-1.49	6.00
3	2440.2500	-1.85	-1.49	-0.36

No.		Δ Frequency(MHz)	Δ Level(dB)
1	mk3-mk1	36.4167	0.22

6dB Bandwidth (CH Mid)

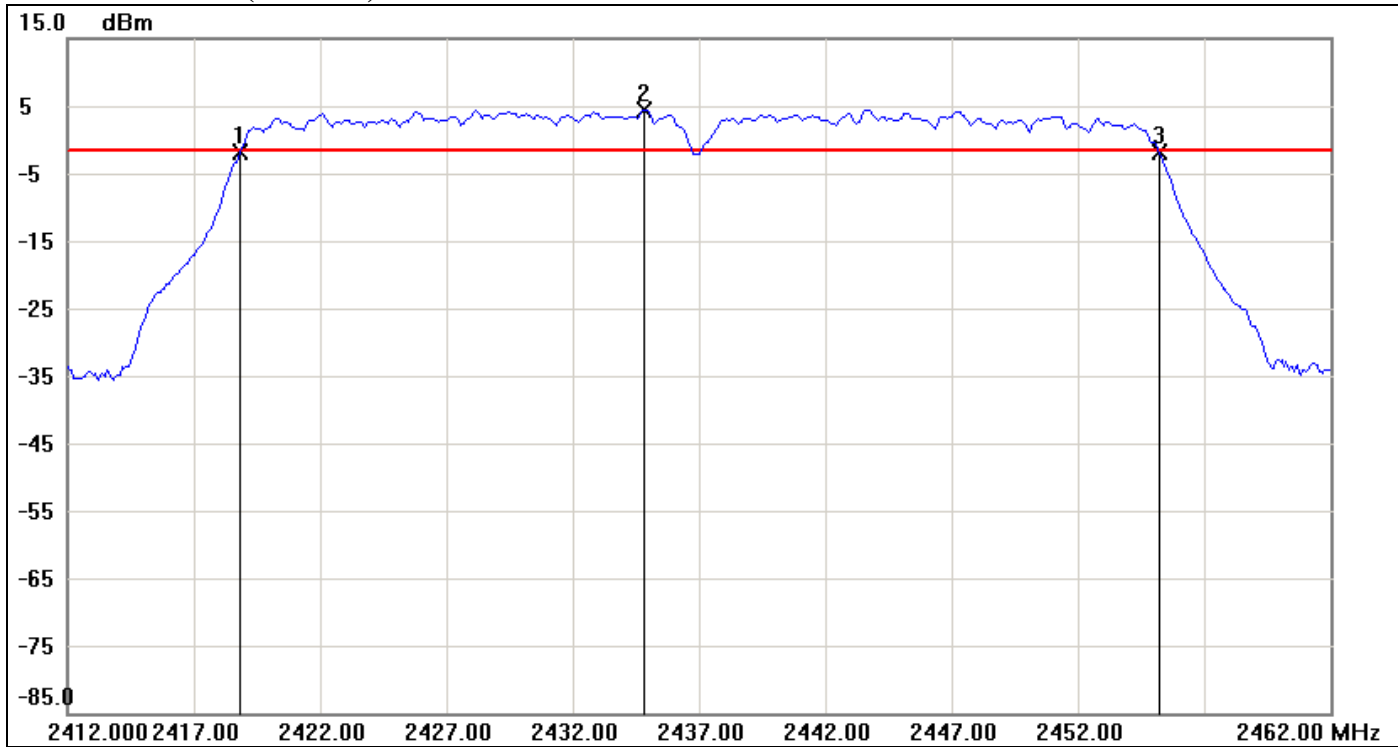

No.	Frequency(MHz)	Result(dBm)	Limit(dBm)	Margin(dBm)
1	2418.8333	-1.95	-1.55	-0.40
2	2434.8333	4.45	-1.55	6.00
3	2455.2500	-1.96	-1.55	-0.41

No.		Δ Frequency(MHz)	Δ Level(dB)
1	mk3-mk1	36.4167	-0.01

6dB Bandwidth (CH High)

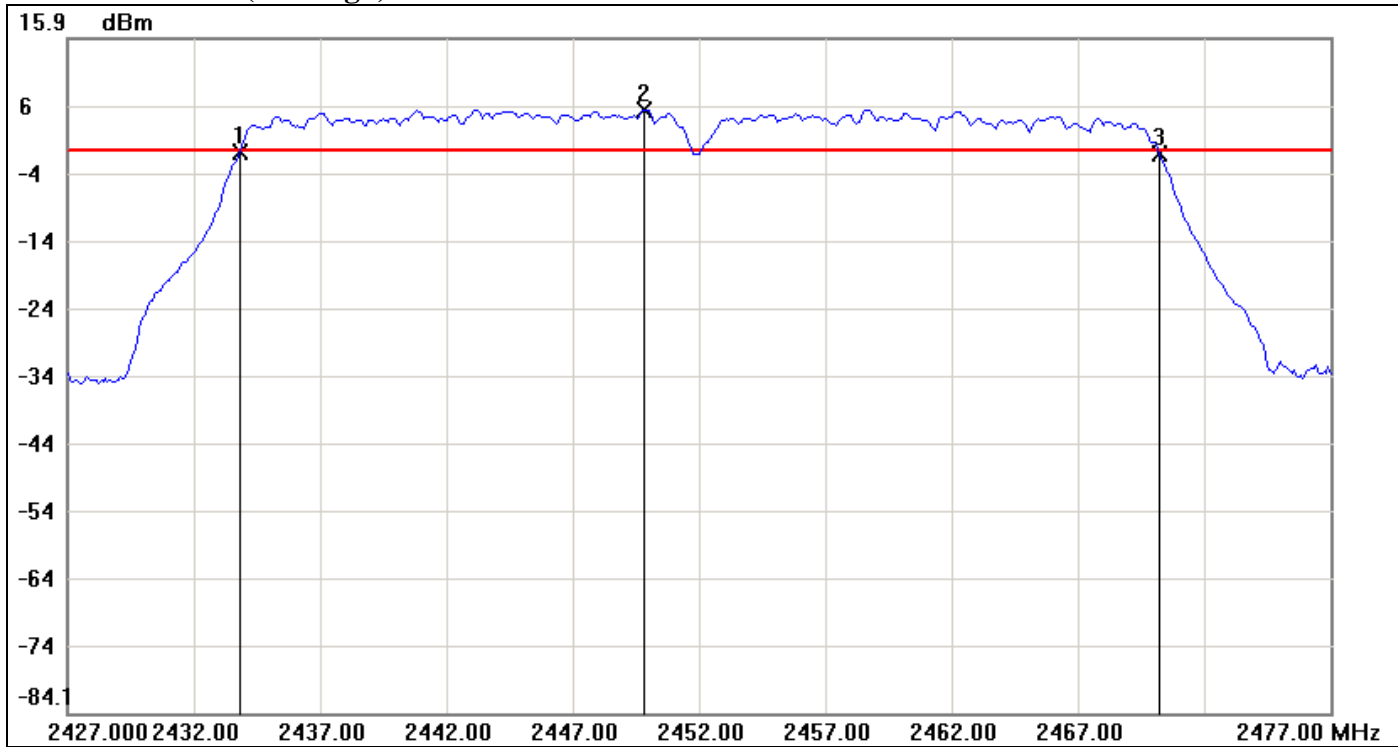

No.	Frequency(MHz)	Result(dBm)	Limit(dBm)	Margin(dBm)
1	2433.8333	-0.89	-0.65	-0.24
2	2449.8333	5.35	-0.65	6.00
3	2470.2500	-1.29	-0.65	-0.64

No.		Δ Frequency(MHz)	Δ Level(dB)
1	mk3-mk1	36.4167	-0.4

IEEE 802.11n HT 40 MHz mode / Chain 1

6dB Bandwidth (CH Low)

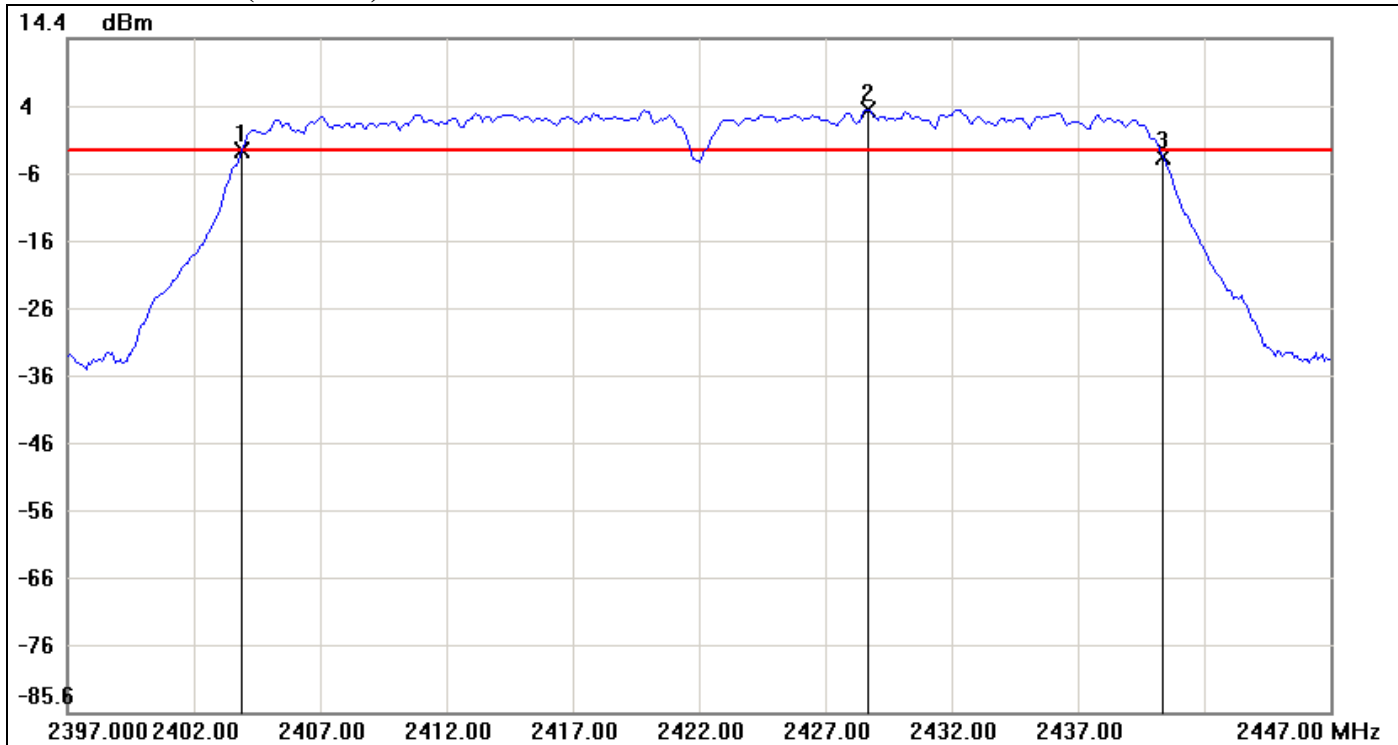

No.	Frequency(MHz)	Result(dBm)	Limit(dBm)	Margin(dBm)
1	2403.9167	-2.18	-2.15	-0.03
2	2428.6667	3.85	-2.15	6.00
3	2440.3333	-3.08	-2.15	-0.93

No.		Δ Frequency(MHz)	Δ Level(dB)
1	mk3-mk1	36.4166	-0.9

6dB Bandwidth (CH Mid)

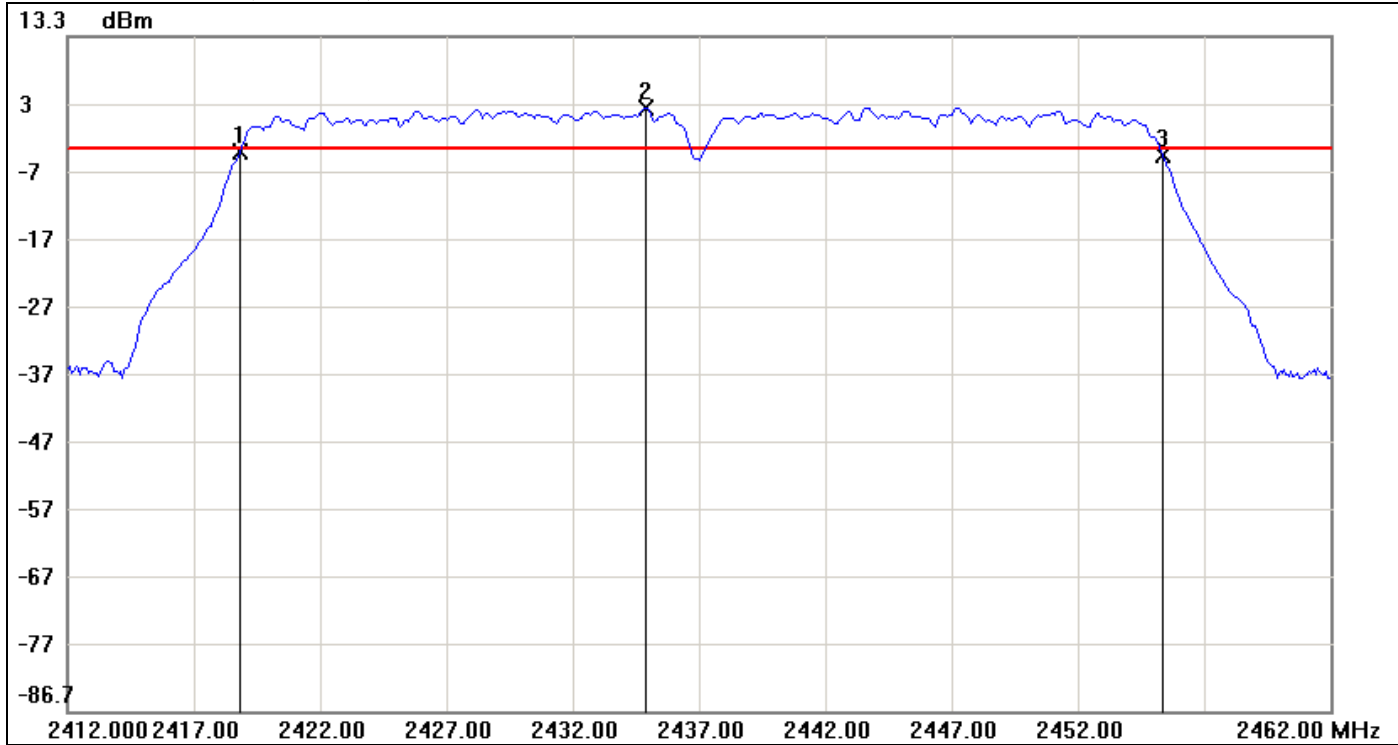

No.	Frequency(MHz)	Result(dBm)	Limit(dBm)	Margin(dBm)
1	2418.8333	-3.67	-3.26	-0.41
2	2434.9167	2.74	-3.26	6.00
3	2455.3333	-4.19	-3.26	-0.93

No.		Δ Frequency(MHz)	Δ Level(dB)
1	mk3-mk1	36.5	-0.52

6dB Bandwidth (CH High)

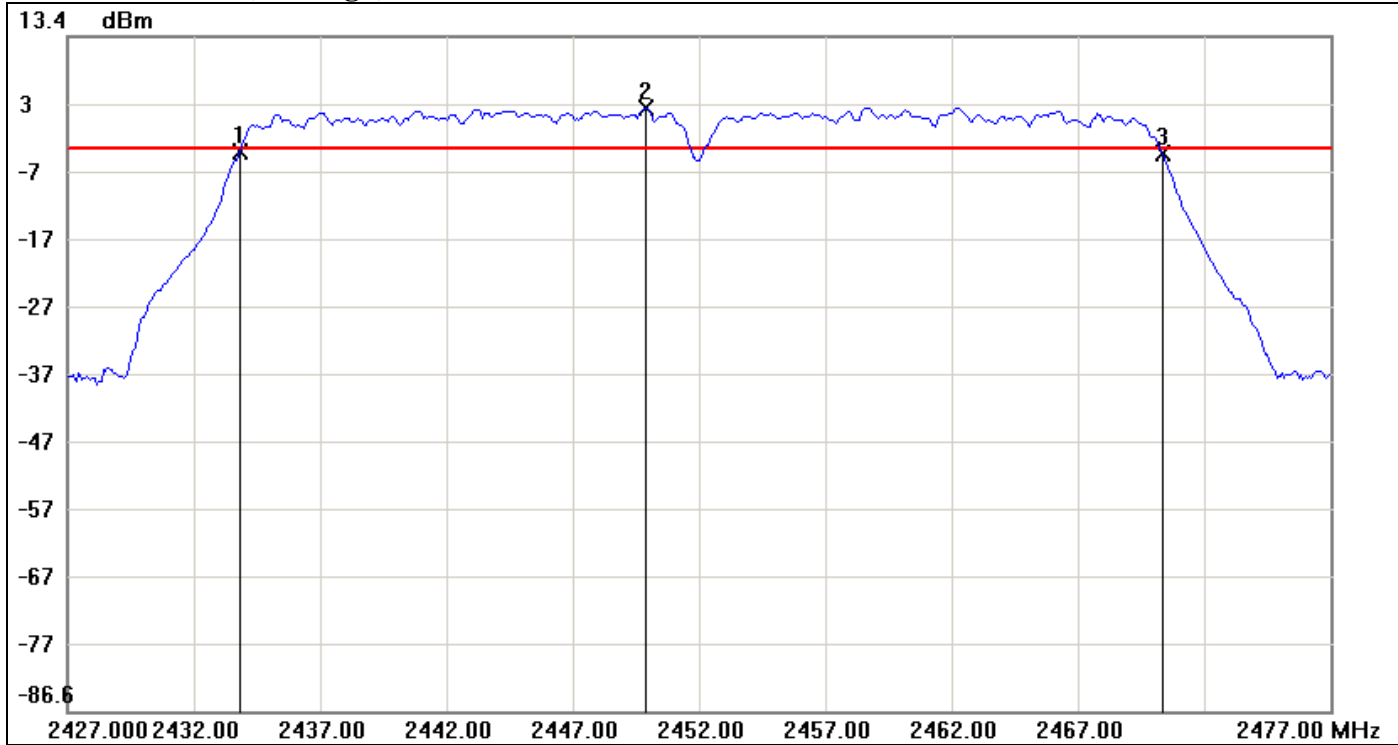

No.	Frequency(MHz)	Result(dBm)	Limit(dBm)	Margin(dBm)
1	2433.8333	-3.69	-3.22	-0.47
2	2449.9167	2.78	-3.22	6.00
3	2470.3333	-4.05	-3.22	-0.83

No.		Δ Frequency(MHz)	Δ Level(dB)
1	mk3-mk1	36.5	-0.36

7.2 PEAK POWER

LIMIT

The maximum peak output power of the intentional radiator shall not exceed the following:

1. According to §15.247(b)(3), for systems using digital modulation in the bands of 902-928 MHz, 2400-2483.5 MHz, and 5725-5850 MHz: 1 Watt.
2. According to §15.247(b)(4), the conducted output power limit specified in paragraph (b) of this section is based on the use of antennas with directional gains that do not exceed 6 dBi. Except as shown in paragraph (c) of this section, if transmitting antennas of directional gain greater than 6 dBi are used, the conducted output power from the intentional radiator shall be reduced below the stated values in paragraphs (b)(1), (b)(2), and (b)(3) of this section, as appropriate, by the amount in dB that the directional gain of the antenna exceeds 6 dBi.

Test Configuration

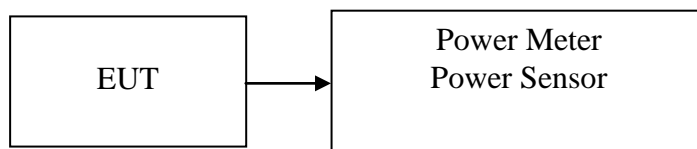

TEST PROCEDURE

The transmitter output is connected to the Power Meter. The Power Meter is set to the peak power detection.

Test Data

Test mode: IEEE 802.11b mode

Channel	Frequency (MHz)	Output Power (dBm)	Output Power (W)	Limit (W)	Result
Low	2412	20.64	0.1159	1.00	PASS
Mid	2437	20.43	0.1104		PASS
High	2462	20.20	0.1047		PASS

Test mode: IEEE 802.11g mode

Channel	Frequency (MHz)	Output Power (dBm)	Output Power (W)	Limit (W)	Result
Low	2412	25.62	0.3648	1.00	PASS
Mid	2437	25.51	0.3556		PASS
High	2462	25.60	0.3631		PASS

Test mode: IEEE 802.11n HT 20 MHz mode

Channel	Frequency (MHz)	Chain 0 Output Power (dBm)	Chain 1 Output Power (dBm)	Total Output Power (dBm)	Output Power (W)	Limit (W)	Result
Low	2412	24.92	24.07	27.53	0.5662	1.00	PASS
Mid	2437	25.12	24.14	27.67	0.5848		PASS
High	2462	24.68	24.08	27.40	0.5495		PASS

Test mode: IEEE 802.11n HT 40 MHz mode

Channel	Frequency (MHz)	Chain 0 Output Power (dBm)	Chain 1 Output Power (dBm)	Total Output Power (dBm)	Output Power (W)	Limit (W)	Result
Low	2422	24.31	24.11	27.22	0.5272	1.00	PASS
Mid	2437	24.51	24.09	27.32	0.5395		PASS
High	2452	24.35	24.22	27.30	0.5370		PASS

Remark:

1. Total Output Power (w) = Chain 0 (10^(Output Power /10)/1000)+ Chain 1 (10^(Output Power /10)/1000)

7.3 AVERAGE POWER

LIMIT

None; for reporting purposes only.

Test Configuration

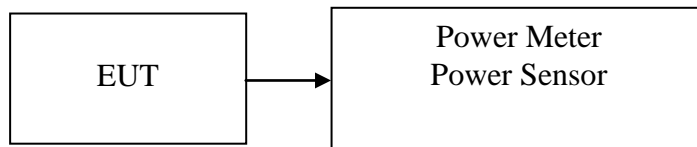

TEST PROCEDURE

The transmitter output is connected to the Power Meter. The Power Meter is set to the avg power detection.

TEST RESULTS

No non-compliance noted.

Test Data

Test mode: IEEE 802.11b mode

Channel	Frequency (MHz)	Output Power (dBm)	Output Power (W)
Low	2412	18.23	0.0665
Mid	2437	18.31	0.0678
High	2462	18.01	0.0632

Test mode: IEEE 802.11g mode

Channel	Frequency (MHz)	Output Power (dBm)	Output Power (W)
Low	2412	16.24	0.0421
Mid	2437	16.11	0.0408
High	2462	16.34	0.0431

Test mode: IEEE 802.11n HT 20 MHz mode

Channel	Frequency (MHz)	Chain 0 Output Power (dBm)	Chain 1 Output Power (dBm)	Total Output Power (dBm)	Output Power (W)
Low	2412	15.02	15.03	18.04	0.0637
Mid	2437	15.25	15.21	18.24	0.0667
High	2462	15.13	15.28	18.22	0.0664

Test mode: IEEE 802.11n HT 40 MHz mode

Channel	Frequency (MHz)	Chain 0 Output Power (dBm)	Chain 1 Output Power (dBm)	Total Output Power (dBm)	Output Power (W)
Low	2422	15.12	15.01	18.08	0.0643
Mid	2437	15.38	15.1	18.25	0.0668
High	2452	15.28	15.21	18.26	0.0670

Remark: Total Output Power (w) = Chain 0 (10^(Output Power /10)/1000)+ Chain 1 (10^(Output Power /10)/1000)

7.4 BAND EDGES MEASUREMENT

LIMIT

According to §15.247(d), in any 100 kHz bandwidth outside the frequency bands in which the spread spectrum intentional radiator is operating, the radio frequency power that is produced by the intentional radiator shall be at least 20 dB below that in the 100 kHz bandwidth within the band that contains the highest level of the desired power, based on either an RF conducted or a radiated measurement, provided the transmitter demonstrates compliance with the peak conducted power limits. In addition, radiated emissions which fall in the restricted bands, as defined in §15.205(a), must also comply with the radiated emission limits specified in 15.209(a) (see Section 15.205(c)).

Test Configuration

For Radiated

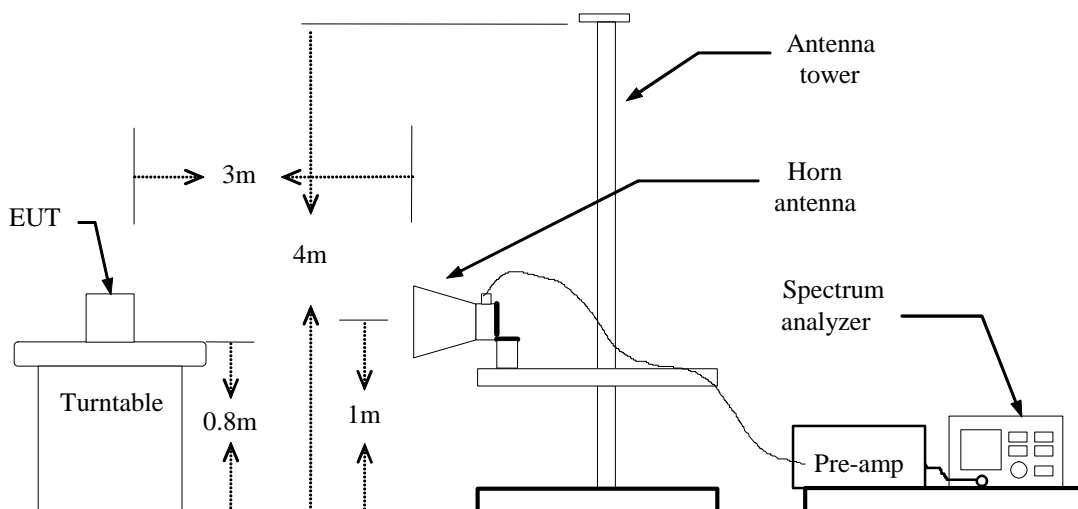

For Conducted

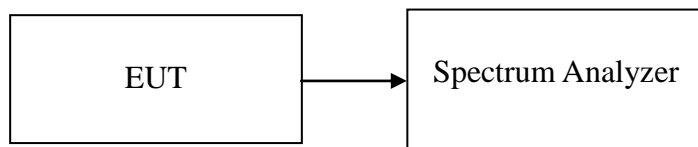

TEST PROCEDURE

For Radiated

1. The EUT is placed on a turntable, which is 1.5m above the ground plane.
2. The turntable shall be rotated for 360 degrees to determine the position of maximum emission level.
3. EUT is set 3m away from the receiving antenna, which is varied from 1m to 4m to find out the highest emission.
4. Set the spectrum analyzer in the following setting in order to capture the lower and upper band-edges of the emission:
 - (a) PEAK: RBW=VBW=3MHz / Sweep=AUTO
 - (b) AVERAGE: RBW=1MHz,
if duty cycle $\geq 98\%$, VBW=10Hz.
if duty cycle $< 98\%$ VBW=1/T.
IEEE 802.11b mode: $\geq 98\%$, VBW=10Hz
IEEE 802.11g mode: $\geq 98\%$, VBW=10Hz
IEEE 802.11n HT 20 MHz mode: $\geq 98\%$, VBW=10Hz
IEEE 802.11n HT 40 MHz mode: $\geq 98\%$, VBW=10Hz
5. Repeat the procedures until all the PEAK and AVERAGE versus POLARIZATION are measured.

For Conducted

Conducted RF measurements of the transmitter output were made to confirm that the EUT antenna port conducted emissions meet the specified limit and to identify any spurious signals that require further investigation or measurements on the radiated emissions site.

The transmitter output is connected to the spectrum analyzer. The resolution bandwidth is set to 100 kHz. The video bandwidth is set to 100 kHz.

TEST RESULTS

Refer to attach spectrum analyzer data chart.

Band Edges (IEEE 802.11b mode / CH Low)

Polarity: Vertical

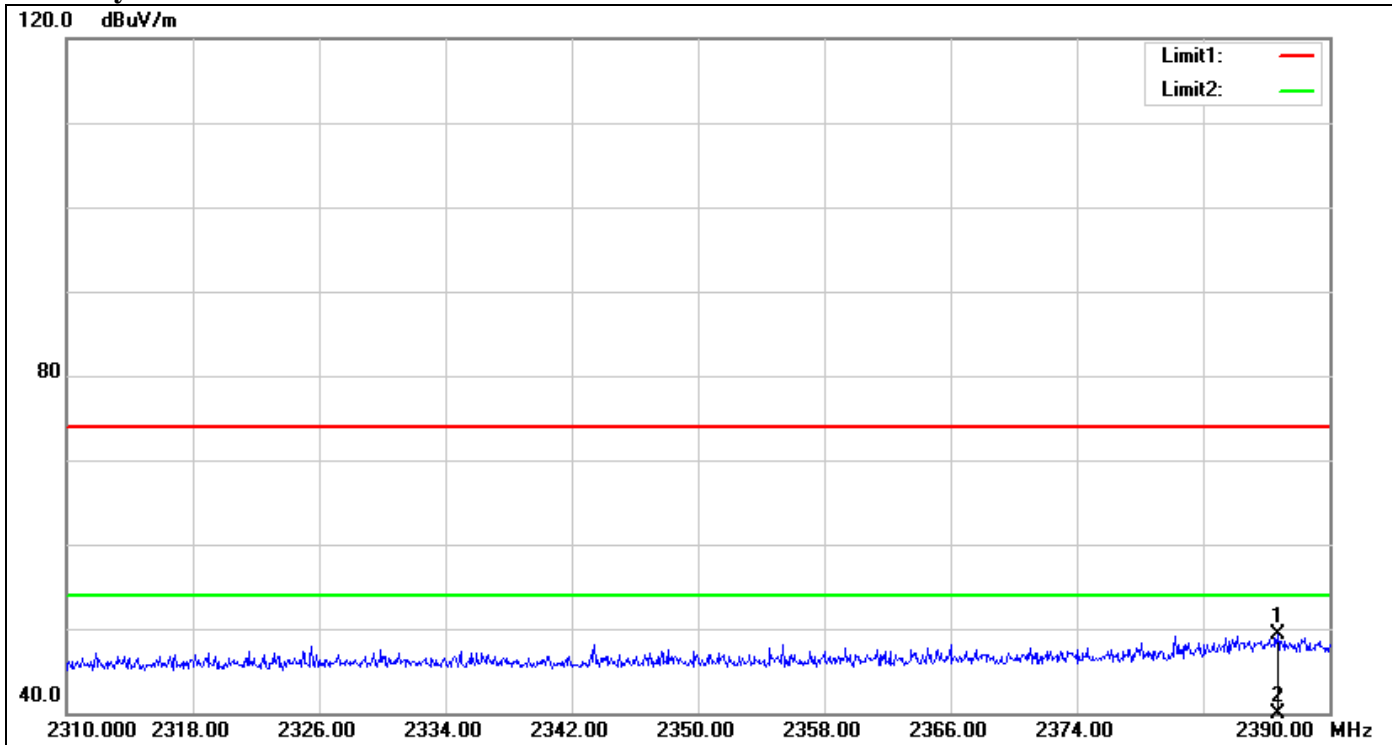

No.	Frequency (MHz)	Reading (dBuV)	Correct Factor(dB/m)	Result (dBuV/m)	Limit (dBuV/m)	Margin (dB)	Height (cm)	Degree (°)	Remark
1	2386.720	53.15	-3.80	49.35	74.00	-24.65	100	83	peak
2	2386.720	39.68	-3.80	35.88	54.00	-18.12	100	83	AVG

Polarity: Horizontal

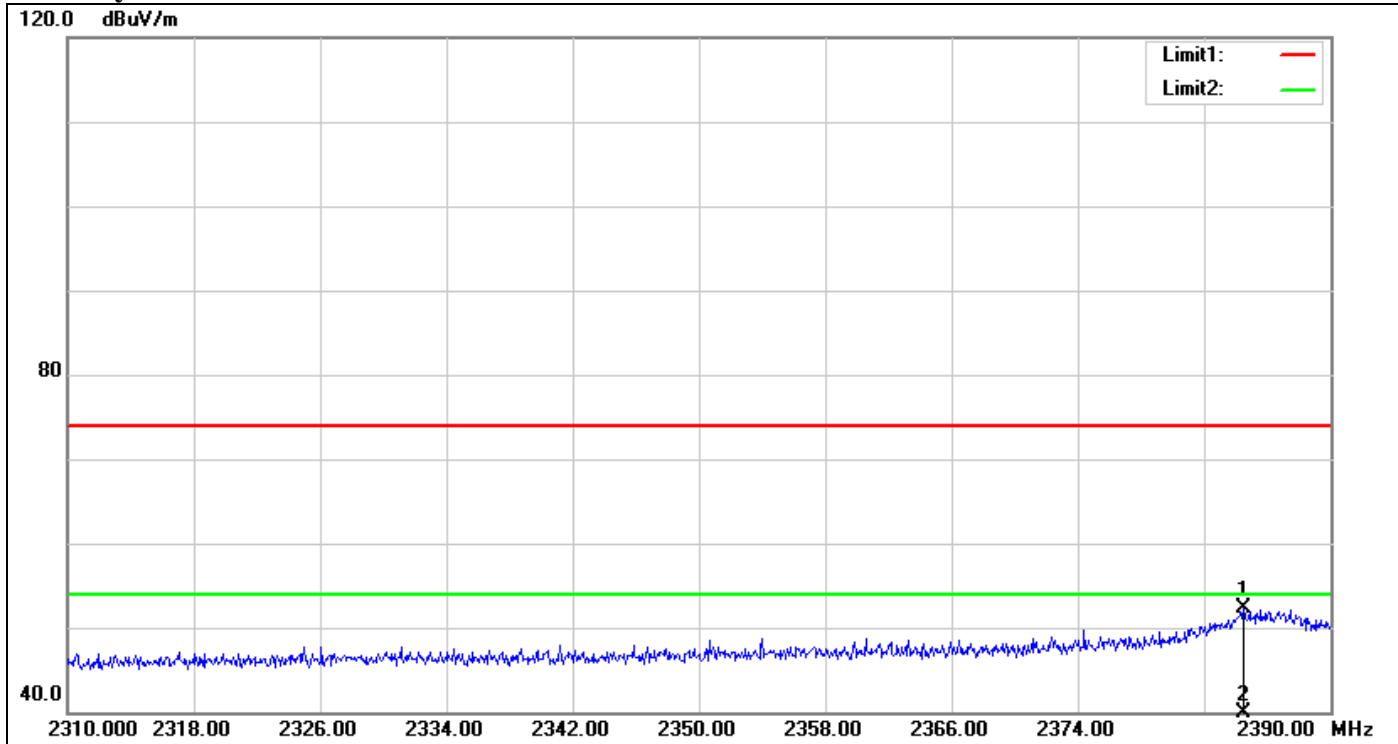

No.	Frequency (MHz)	Reading (dBuV)	Correct Factor(dB/m)	Result (dBuV/m)	Limit (dBuV/m)	Margin (dB)	Height (cm)	Degree (°)	Remark
1	2384.480	56.09	-3.82	52.27	74.00	-21.73	100	72	peak
2	2384.480	43.37	-3.82	39.55	54.00	-14.45	100	72	AVG

Band Edges (IEEE 802.11b mode / CH High)

Polarity: Vertical

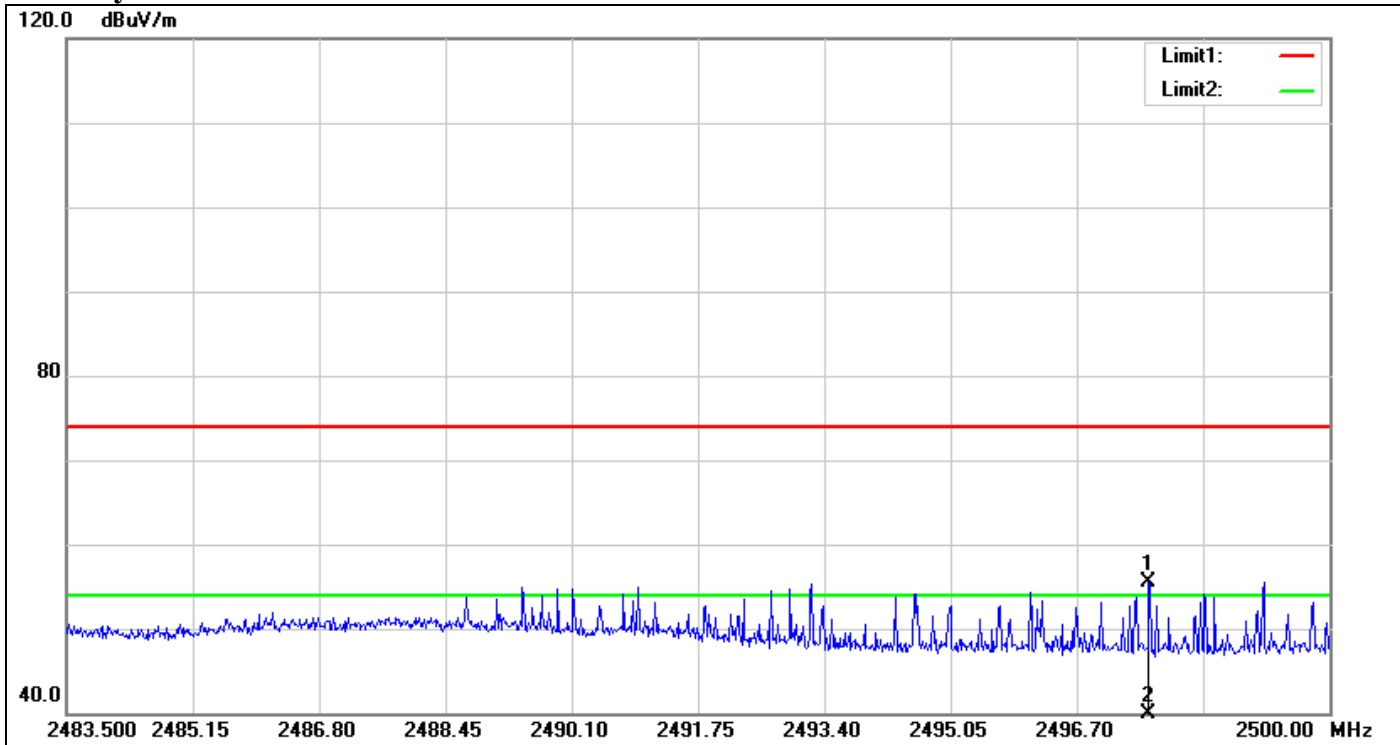

No.	Frequency (MHz)	Reading (dBuV)	Correct Factor(dB/m)	Result (dBuV/m)	Limit (dBuV/m)	Margin (dB)	Height (cm)	Degree (°)	Remark
1	2497.640	58.70	-3.14	55.56	74.00	-18.44	100	263	peak
2	2497.640	42.82	-3.14	39.68	54.00	-14.32	100	263	AVG

Polarity: Horizontal

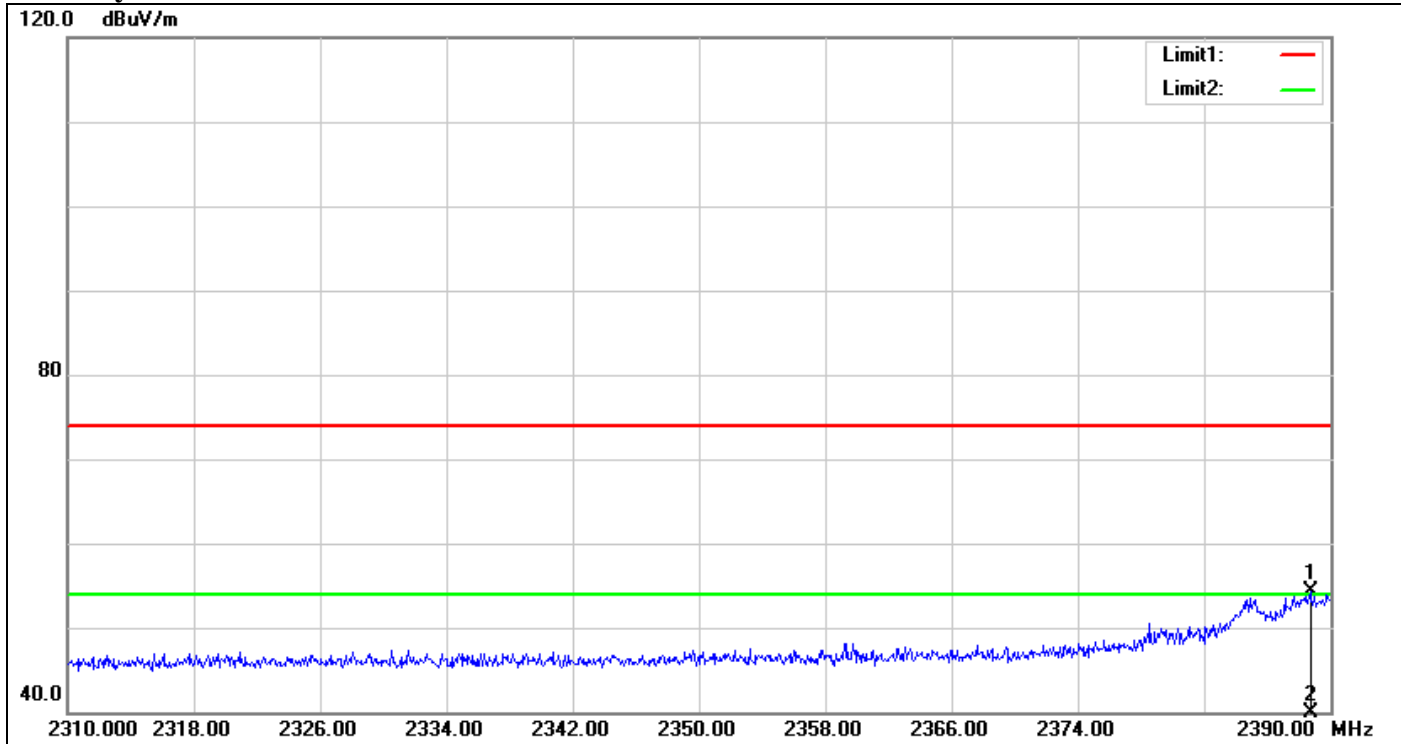

No.	Frequency (MHz)	Reading (dBuV)	Correct Factor(dB/m)	Result (dBuV/m)	Limit (dBuV/m)	Margin (dB)	Height (cm)	Degree (°)	Remark
1	2388.720	58.12	-3.78	54.34	74.00	-19.66	100	347	peak
2	2388.720	43.36	-3.78	39.58	54.00	-14.42	100	347	AVG

Band Edges (IEEE 802.11g mode / CH Low)

Polarity: Vertical

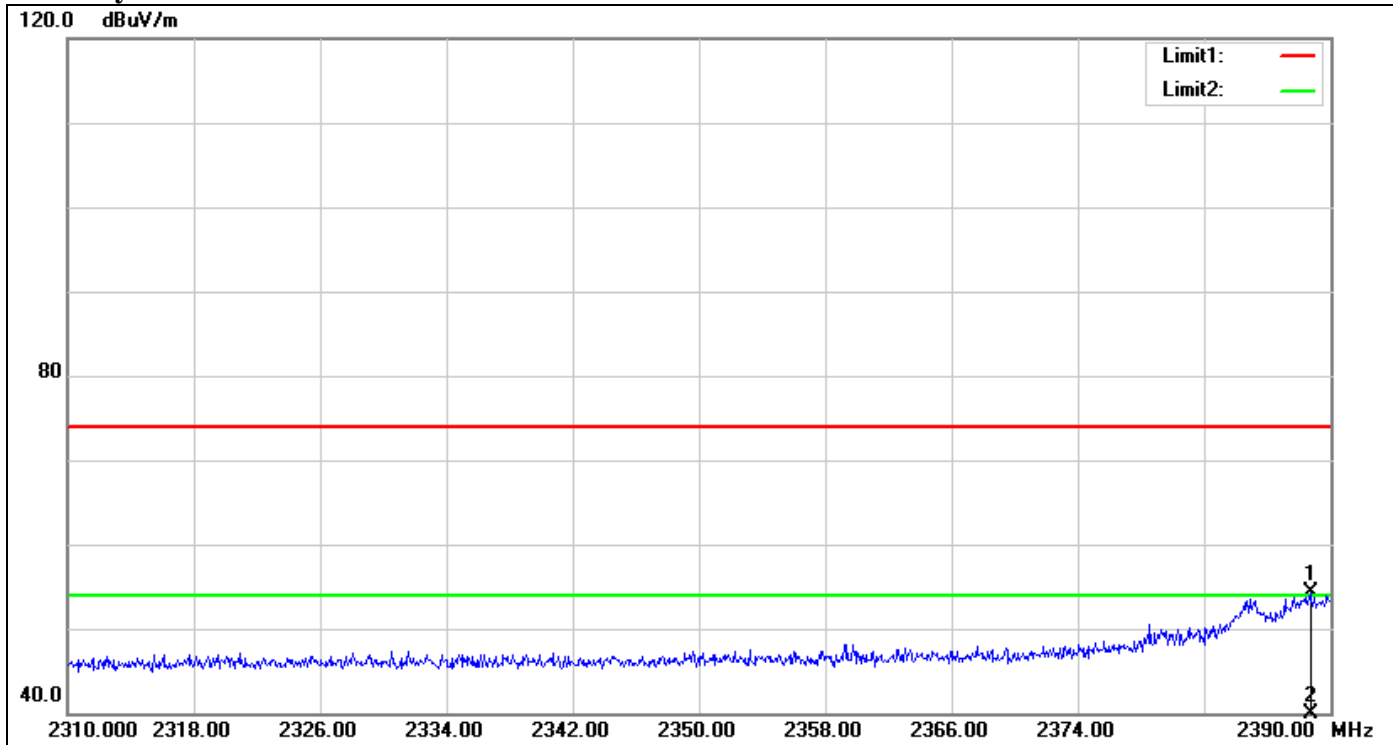

No.	Frequency (MHz)	Reading (dBuV)	Correct Factor(dB/m)	Result (dBuV/m)	Limit (dBuV/m)	Margin (dB)	Height (cm)	Degree (°)	Remark
1	2388.720	58.12	-3.78	54.34	74.00	-19.66	100	347	peak
2	2388.720	43.36	-3.78	39.58	54.00	-14.42	100	347	AVG

Polarity: Horizontal

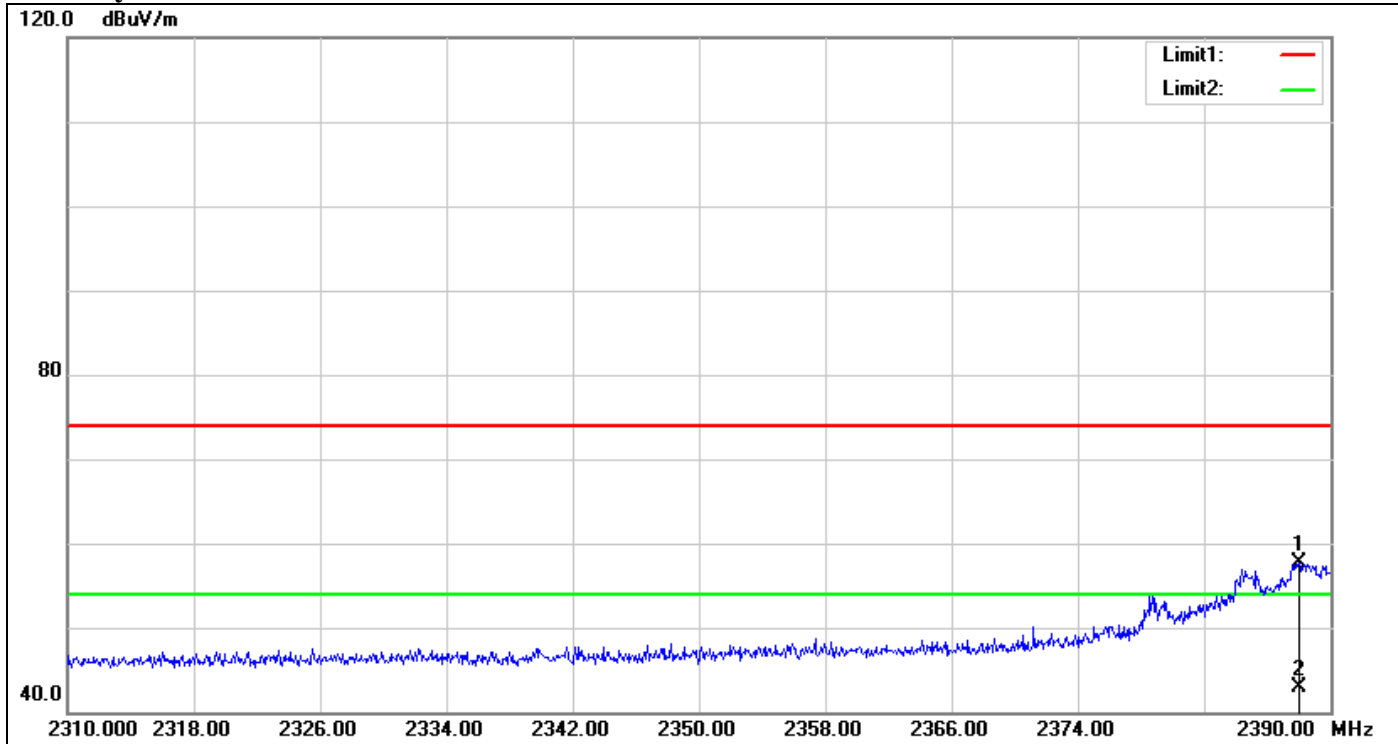

No.	Frequency (MHz)	Reading (dBuV)	Correct Factor(dB/m)	Result (dBuV/m)	Limit (dBuV/m)	Margin (dB)	Height (cm)	Degree (°)	Remark
1	2388.000	61.58	-3.79	57.79	74.00	-16.21	100	23	peak
2	2388.000	46.67	-3.79	42.88	54.00	-11.12	100	23	AVG

Band Edges (IEEE 802.11g mode / CH High)

Polarity: Vertical

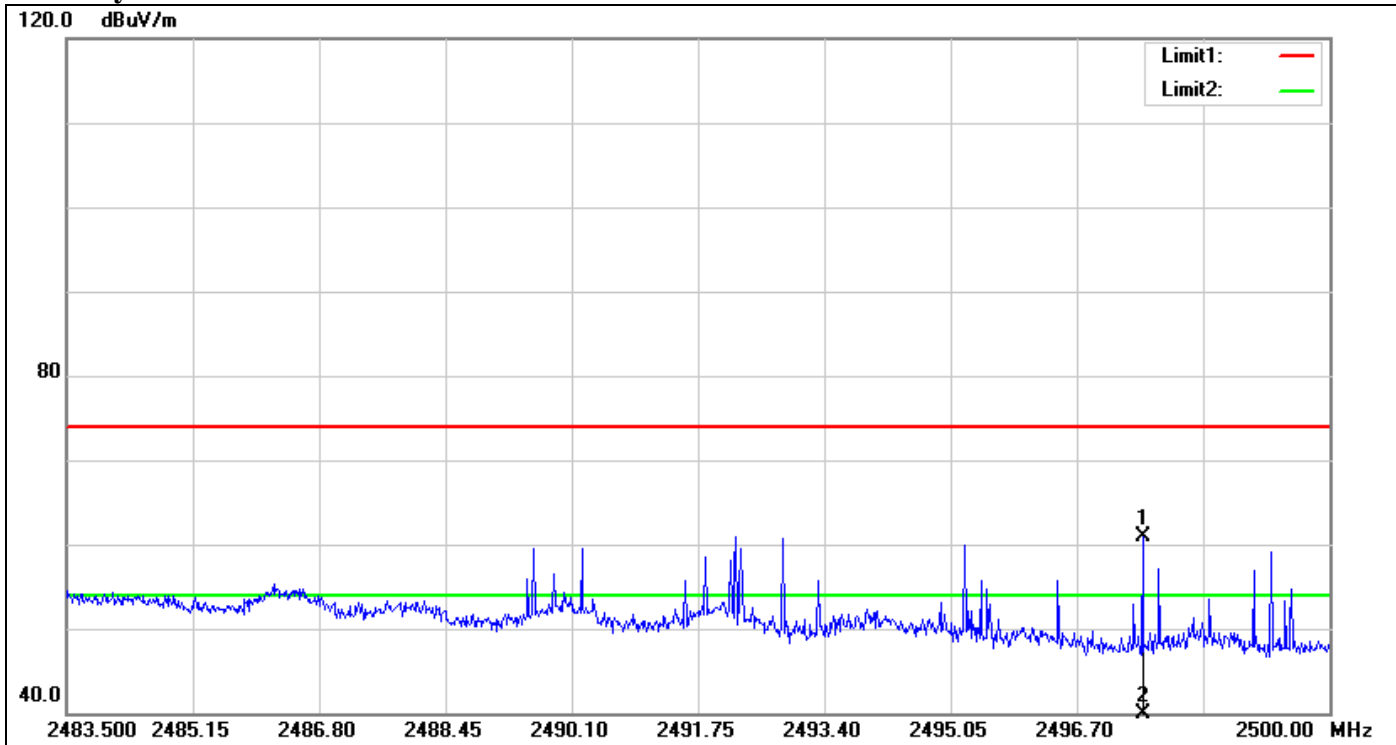

No.	Frequency (MHz)	Reading (dBuV)	Correct Factor(dB/m)	Result (dBuV/m)	Limit (dBuV/m)	Margin (dB)	Height (cm)	Degree (°)	Remark
1	2497.558	64.09	-3.14	60.95	74.00	-13.05	100	133	peak
2	2497.558	42.95	-3.14	39.81	54.00	-14.19	100	133	AVG

Polarity: Horizontal

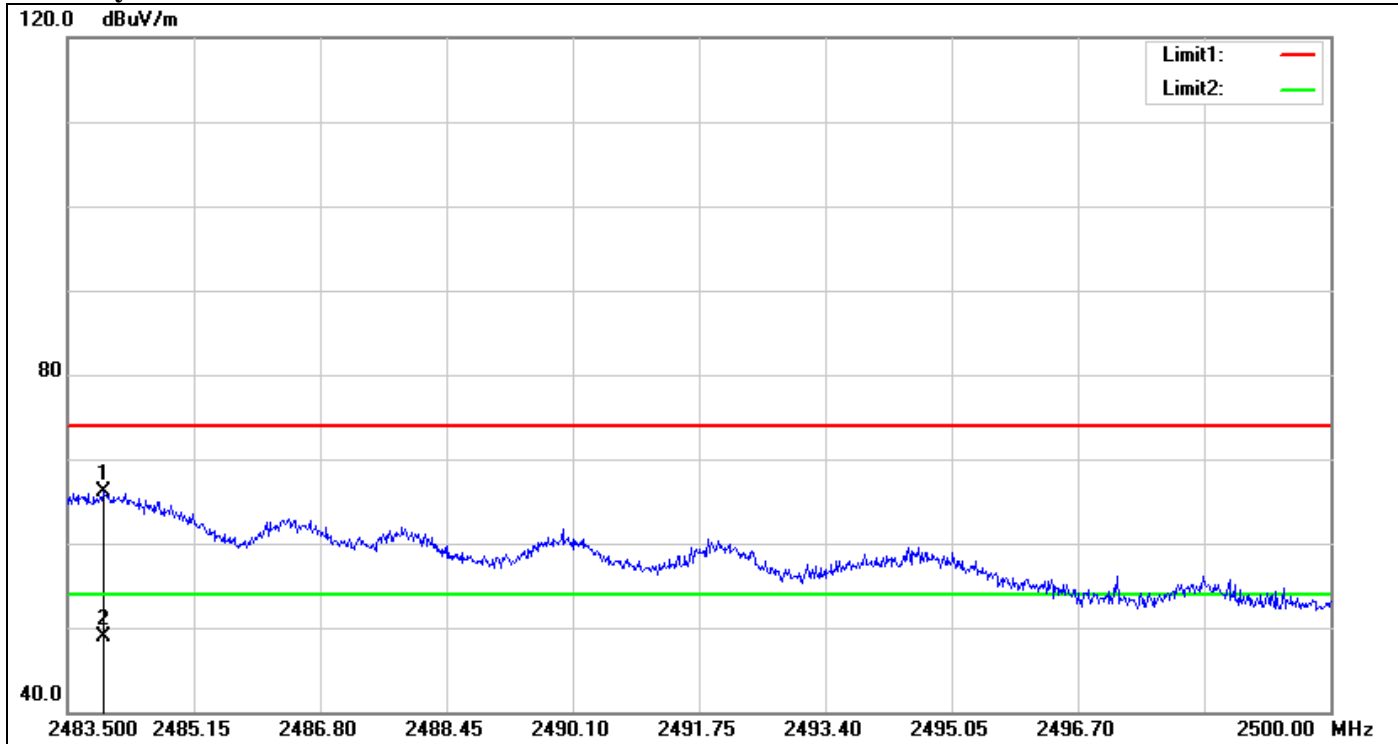

No.	Frequency (MHz)	Reading (dBuV)	Correct Factor(dB/m)	Result (dBuV/m)	Limit (dBuV/m)	Margin (dB)	Height (cm)	Degree (°)	Remark
1	2483.962	69.32	-3.27	66.05	74.00	-7.95	100	185	peak
2	2483.962	52.23	-3.27	48.96	54.00	-5.04	100	185	AVG

Band Edges (IEEE 802.11n HT 20 MHz mode / CH Low)

Polarity: Vertical

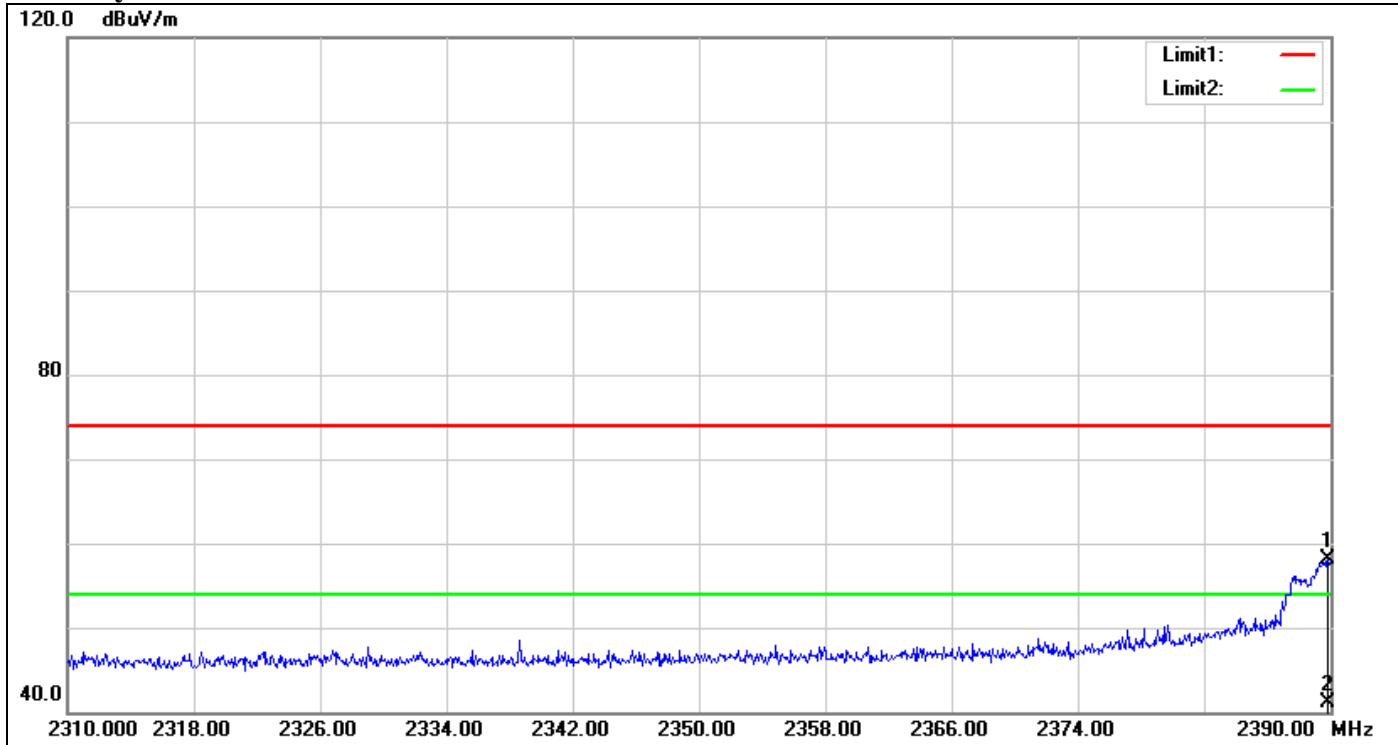

No.	Frequency (MHz)	Reading (dBuV)	Correct Factor(dB/m)	Result (dBuV/m)	Limit (dBuV/m)	Margin (dB)	Height (cm)	Degree (°)	Remark
1	2389.840	61.79	-3.77	58.02	74.00	-15.98	100	325	peak
2	2389.840	44.84	-3.77	41.07	54.00	-12.93	100	325	AVG

Polarity: Horizontal

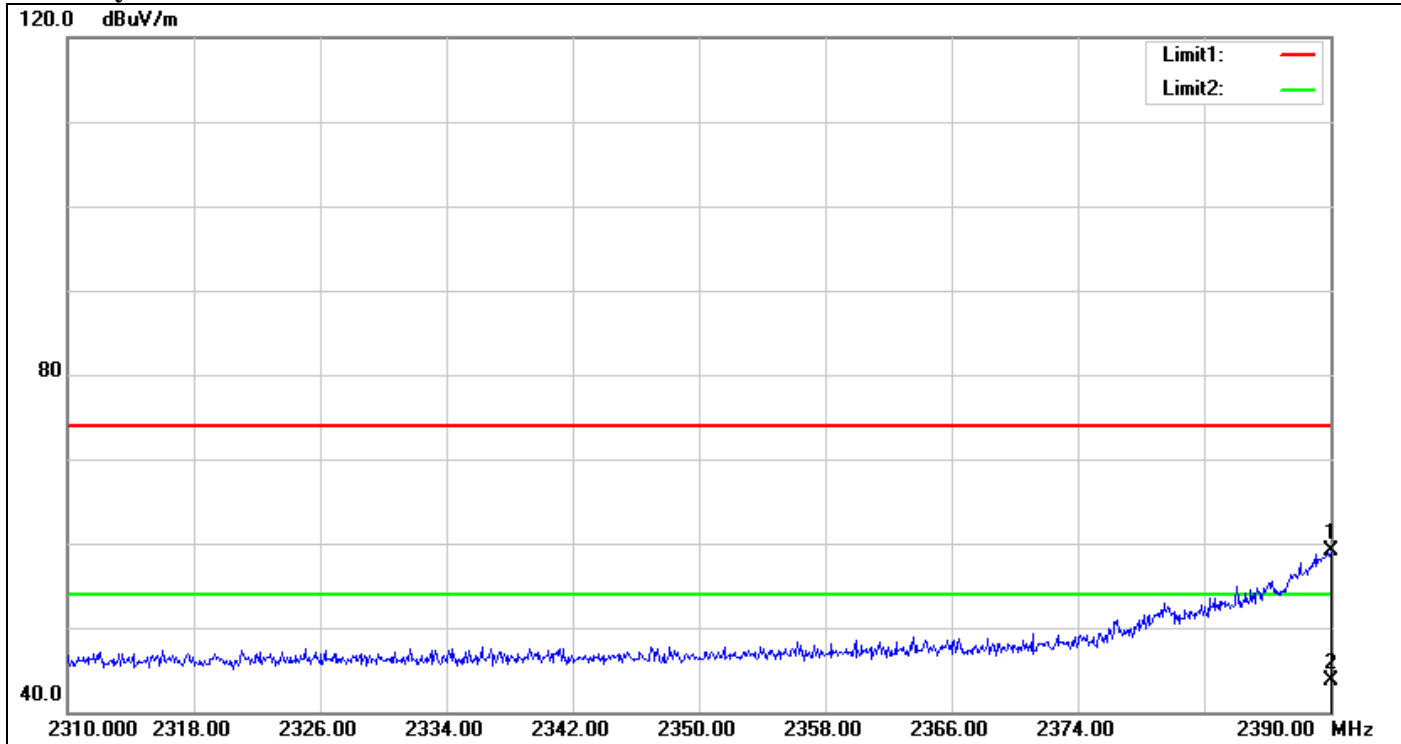

No.	Frequency (MHz)	Reading (dBuV)	Correct Factor(dB/m)	Result (dBuV/m)	Limit (dBuV/m)	Margin (dB)	Height (cm)	Degree (°)	Remark
1	2390.000	62.92	-3.77	59.15	74.00	-14.85	100	273	peak
2	2390.000	47.51	-3.77	43.74	54.00	-10.26	100	273	AVG

Band Edges (IEEE 802.11n HT 20 MHz mode / CH High)

Polarity: Vertical

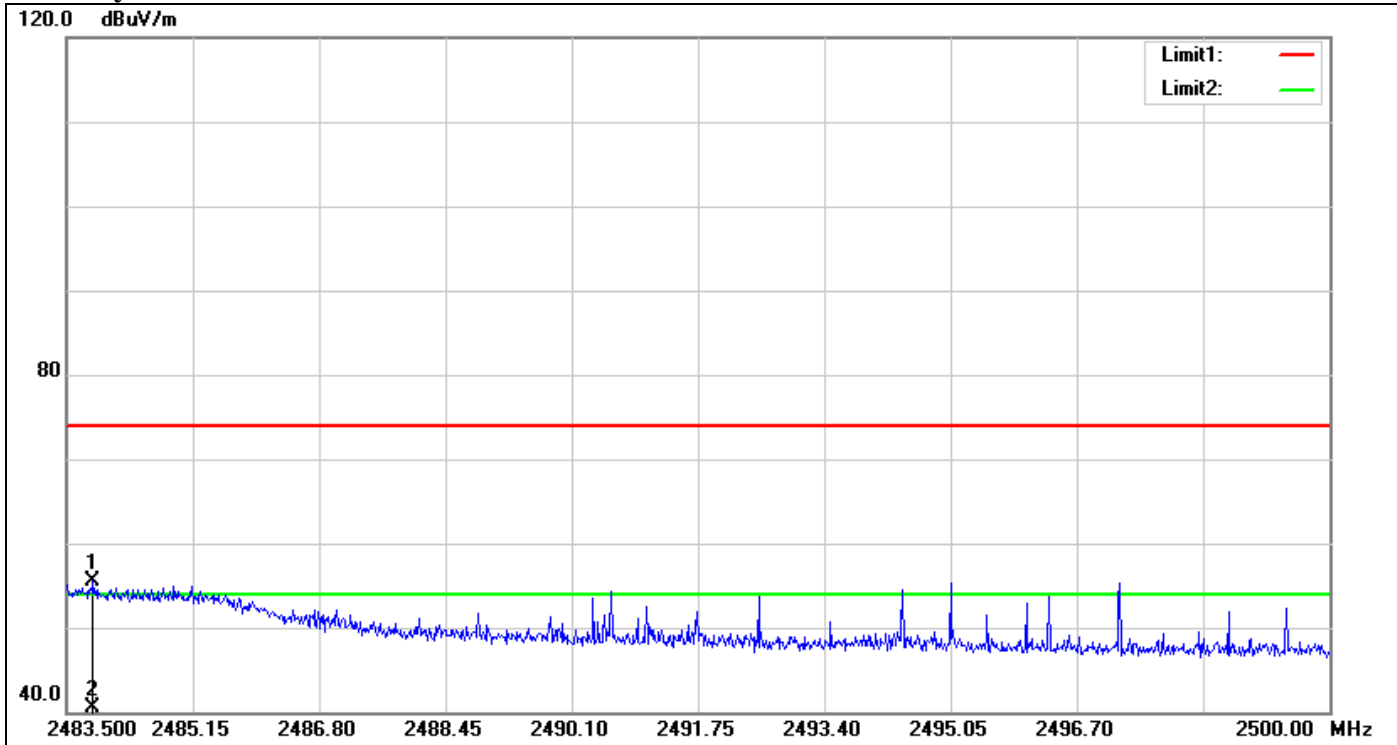

No.	Frequency (MHz)	Reading (dBuV)	Correct Factor(dB/m)	Result (dBuV/m)	Limit (dBuV/m)	Margin (dB)	Height (cm)	Degree (°)	Remark
1	2483.847	58.82	-3.27	55.55	74.00	-18.45	100	295	peak
2	2483.847	43.77	-3.27	40.50	54.00	-13.50	100	295	AVG

Polarity: Horizontal

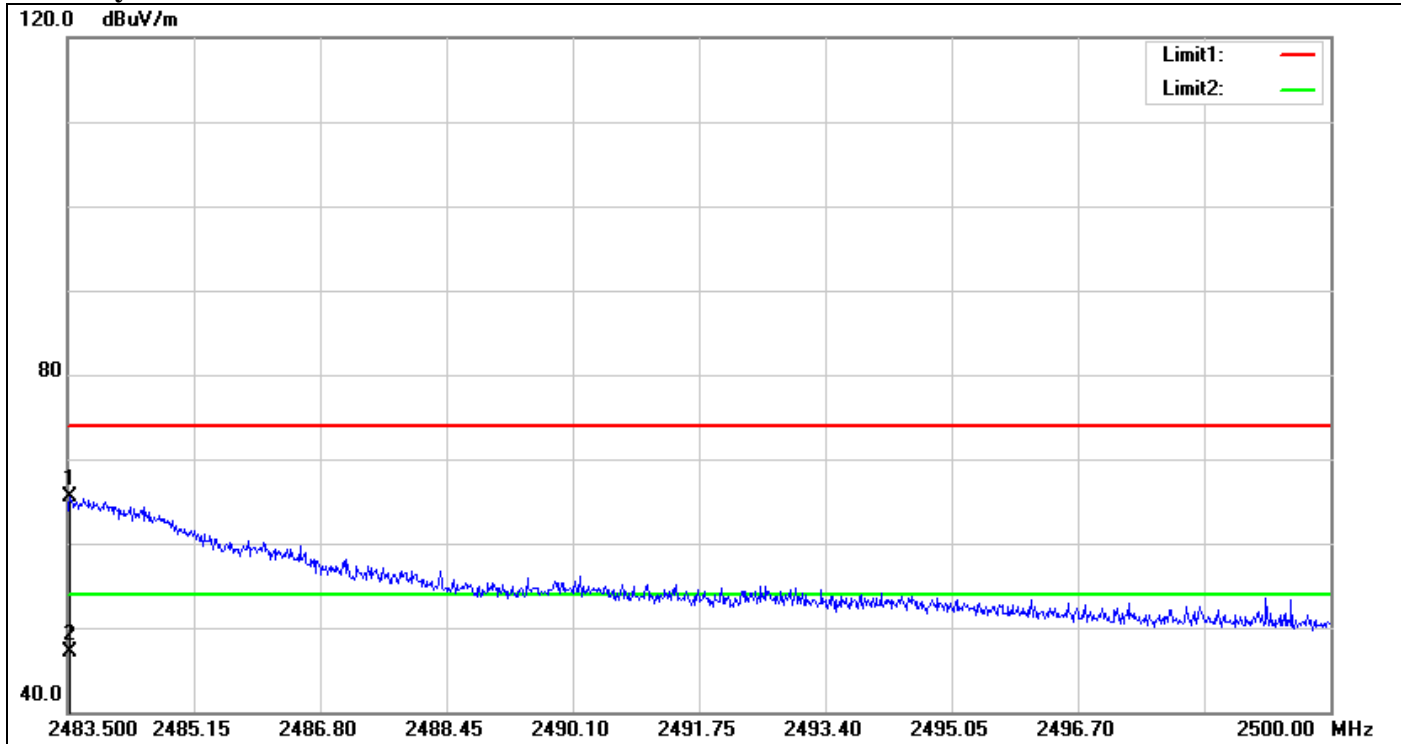

No.	Frequency (MHz)	Reading (dBuV)	Correct Factor(dB/m)	Result (dBuV/m)	Limit (dBuV/m)	Margin (dB)	Height (cm)	Degree (°)	Remark
1	2483.533	68.87	-3.27	65.60	74.00	-8.40	100	214	peak
2	2483.533	50.32	-3.27	47.05	54.00	-6.95	100	214	AVG

Band Edges (IEEE 802.11n HT 40 MHz mode / CH Low)

Polarity: Vertical

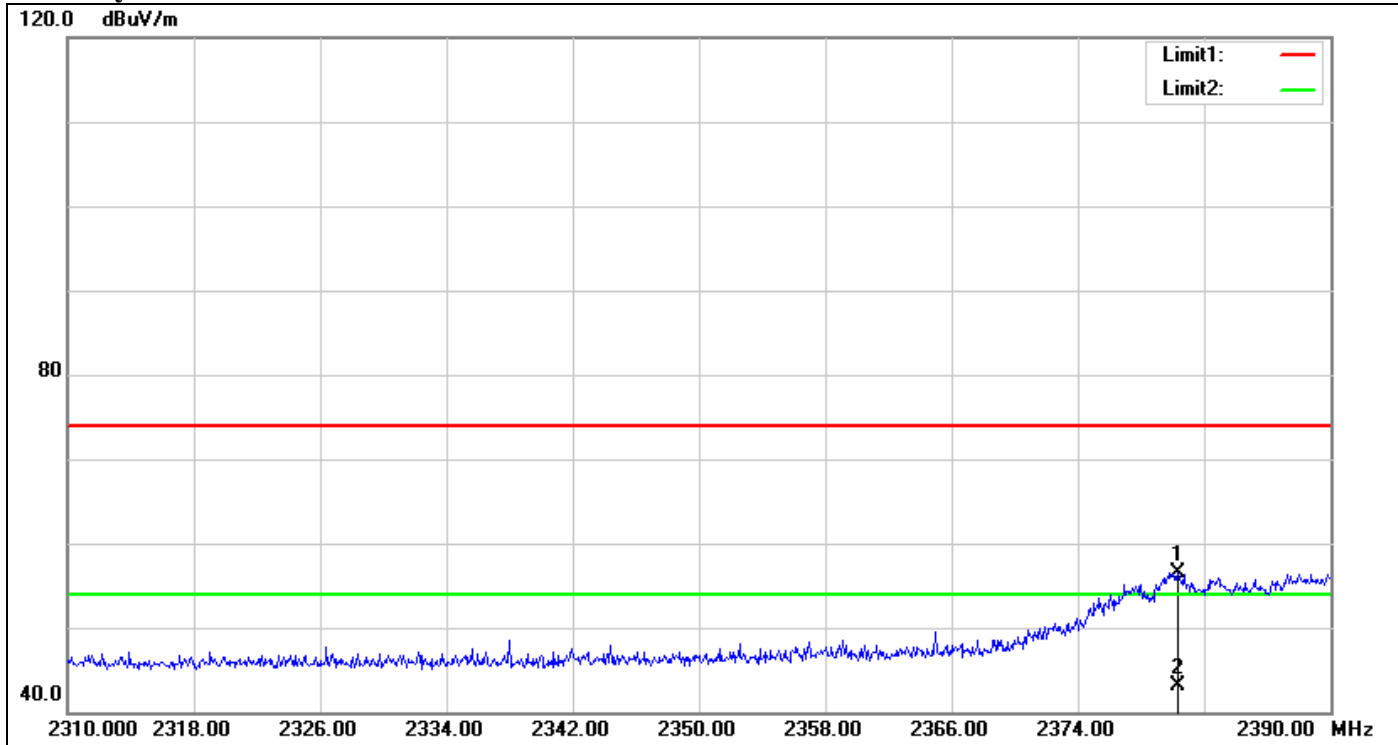

No.	Frequency (MHz)	Reading (dBuV)	Correct Factor(dB/m)	Result (dBuV/m)	Limit (dBuV/m)	Margin (dB)	Height (cm)	Degree (°)	Remark
1	2380.320	60.29	-3.86	56.43	74.00	-17.57	100	138	peak
2	2380.320	47.01	-3.86	43.15	54.00	-10.85	100	138	AVG

Polarity: Horizontal

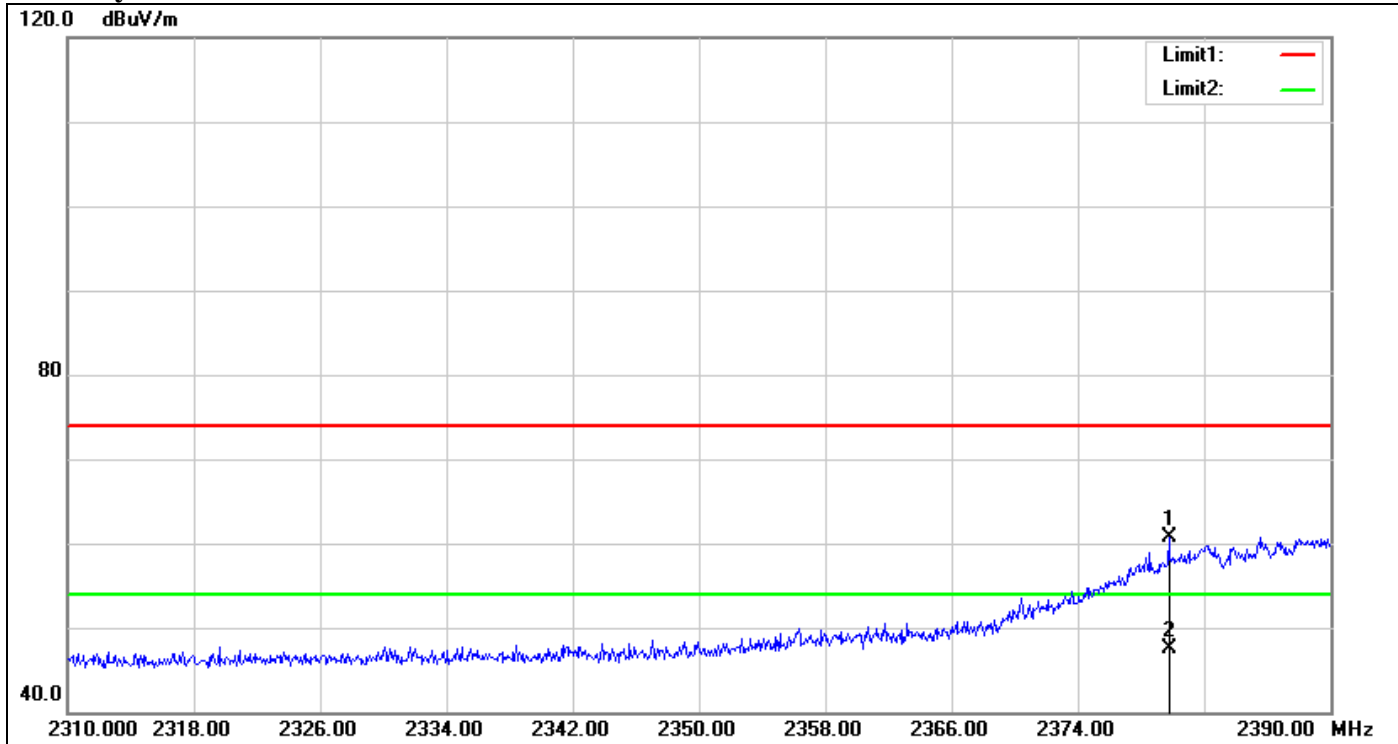

No.	Frequency (MHz)	Reading (dBuV)	Correct Factor(dB/m)	Result (dBuV/m)	Limit (dBuV/m)	Margin (dB)	Height (cm)	Degree (°)	Remark
1	2379.760	64.57	-3.86	60.71	74.00	-13.29	100	333	peak
2	2379.760	51.36	-3.86	47.50	54.00	-6.50	100	333	AVG

Band Edges (IEEE 802.11n HT 40 MHz mode / CH High)

Polarity: Vertical

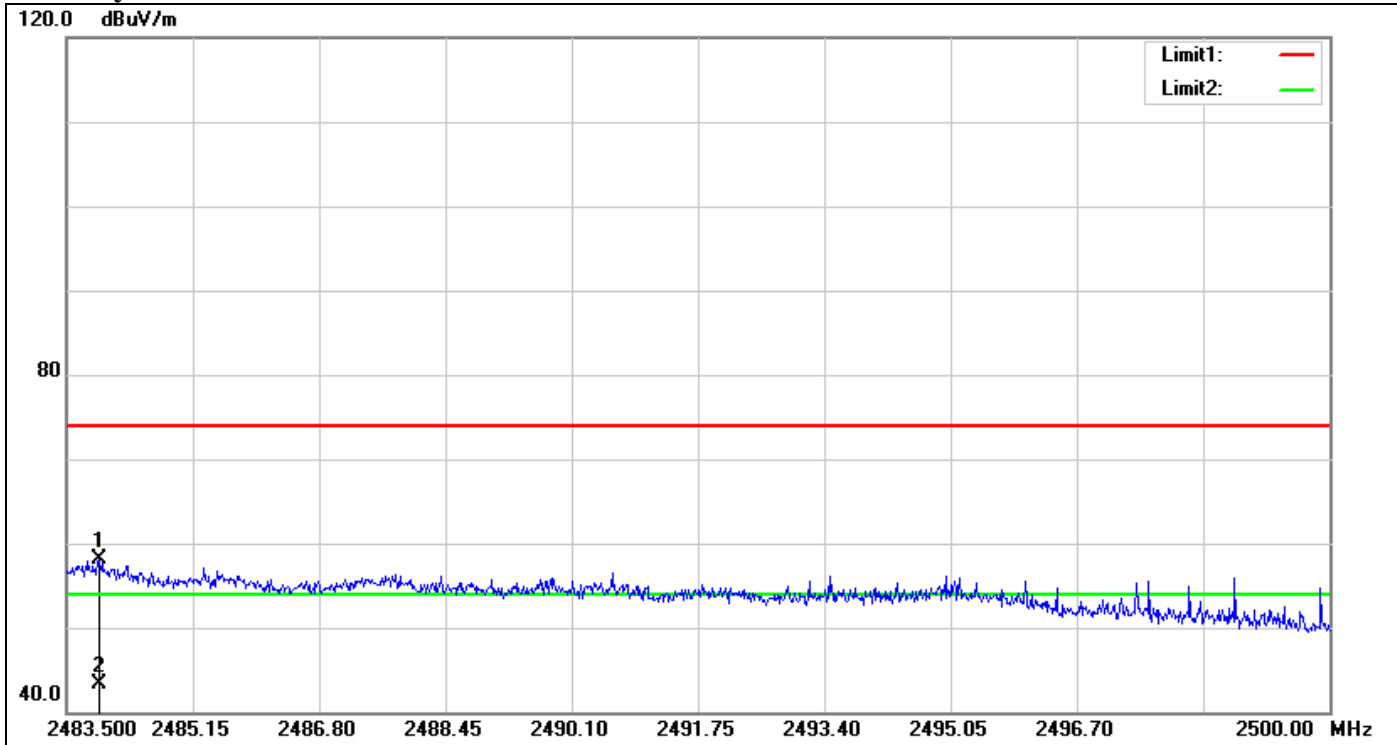

No.	Frequency (MHz)	Reading (dBuV)	Correct Factor(dB/m)	Result (dBuV/m)	Limit (dBuV/m)	Margin (dB)	Height (cm)	Degree (°)	Remark
1	2483.929	61.37	-3.27	58.10	74.00	-15.90	100	210	peak
2	2483.929	46.60	-3.27	43.33	54.00	-10.67	100	210	AVG

Polarity: Horizontal

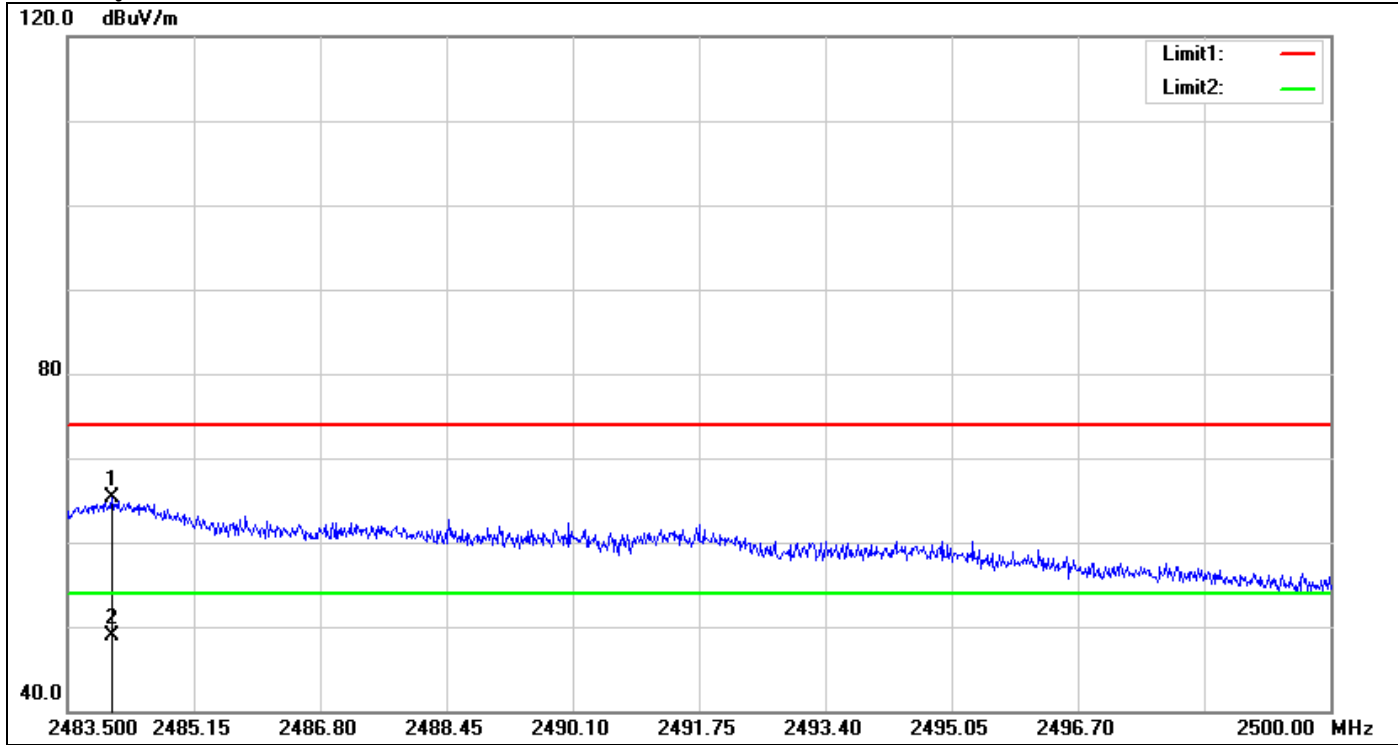

No.	Frequency (MHz)	Reading (dBuV)	Correct Factor(dB/m)	Result (dBuV/m)	Limit (dBuV/m)	Margin (dB)	Height (cm)	Degree (°)	Remark
1	2484.077	68.65	-3.27	65.38	74.00	-8.62	100	255	peak
2	2484.077	52.18	-3.27	48.91	54.00	-5.09	100	255	AVG

Test Plot

Conducted Band Edges (IEEE 802.11b mode / CH Low)

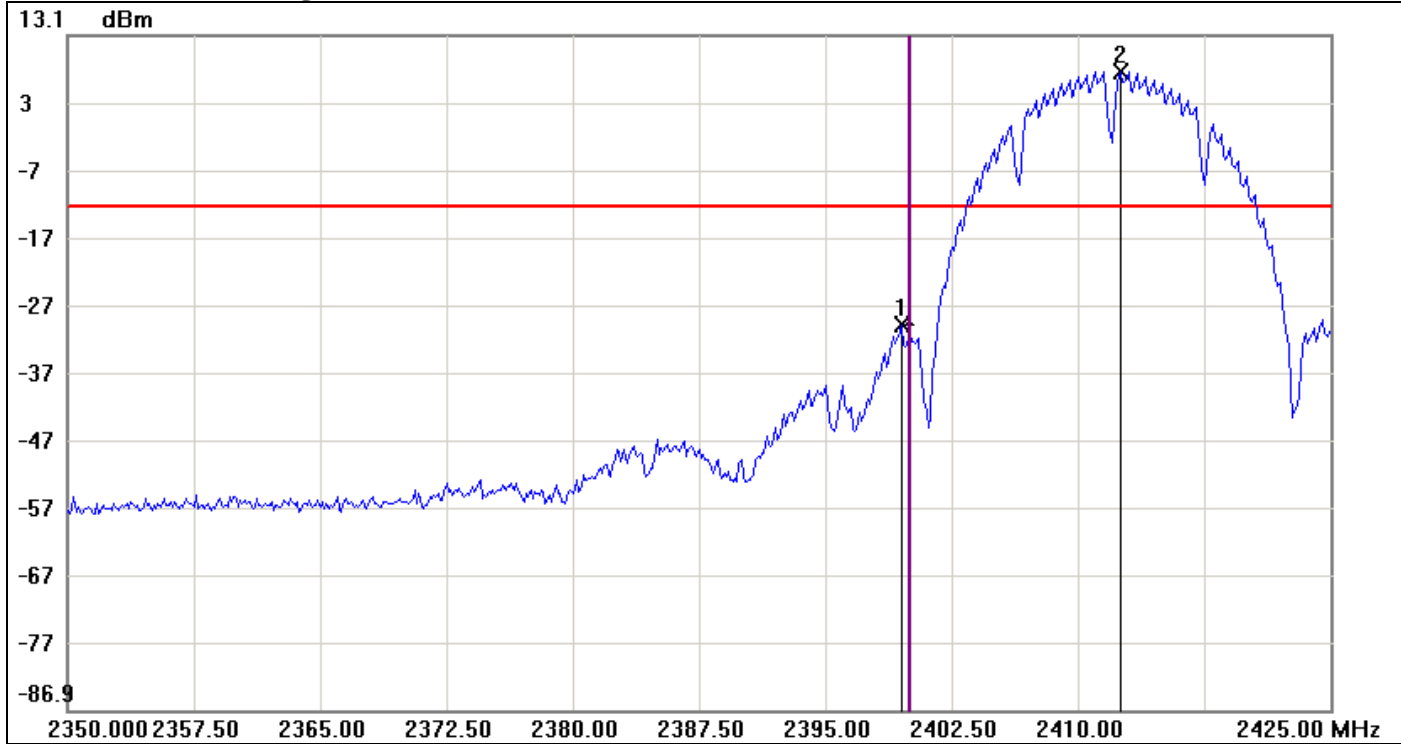

No.	Frequency(MHz)	Result(dBm)	Limit(dBm)	Margin(dBm)
1	2399.5000	-29.81	-12.25	-17.56
2	2412.5000	7.75	-12.25	20.00

Conducted Band Edges (IEEE 802.11b mode / CH High)

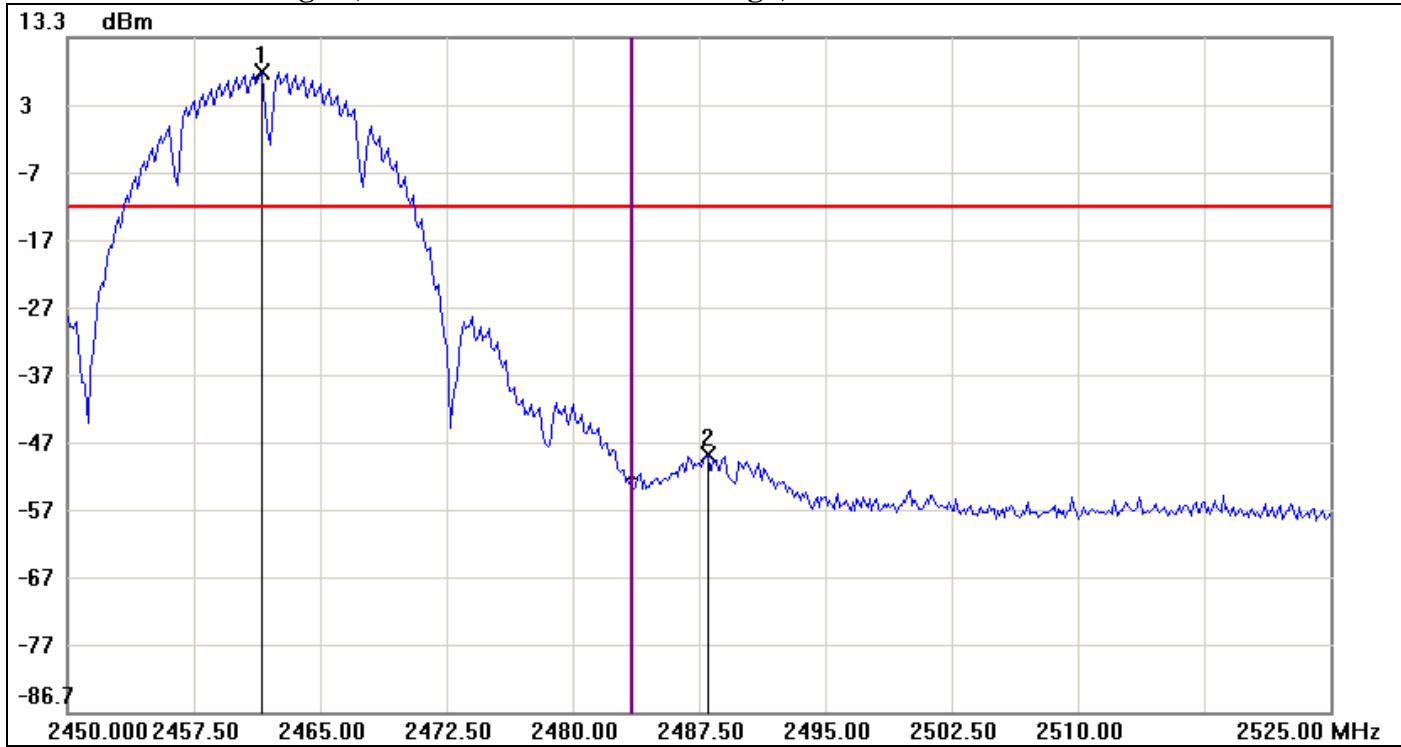

No.	Frequency(MHz)	Result(dBm)	Limit(dBm)	Margin(dBm)
1	2461.5000	8.12	-11.88	20.00
2	2488.0000	-48.65	-11.88	-36.77

Conducted Band Edges (IEEE 802.11g mode / CH Low)

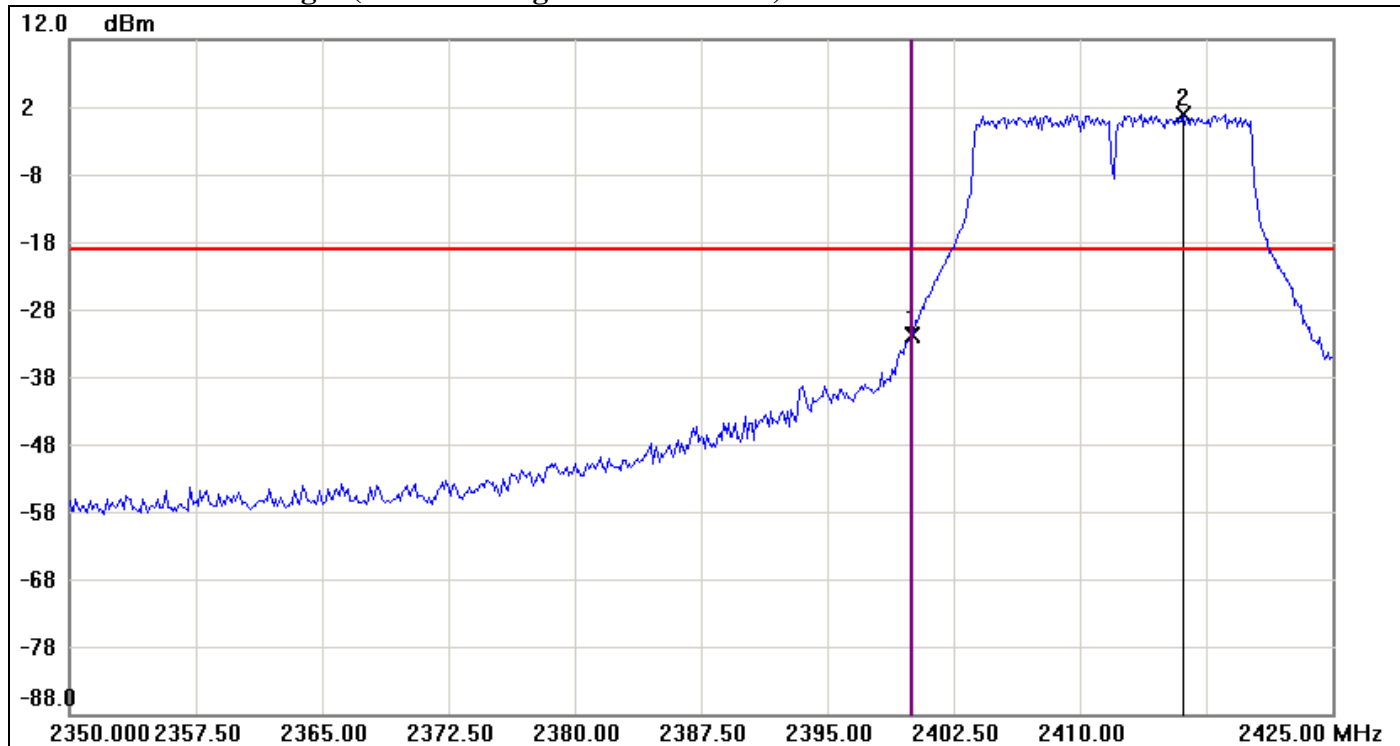

No.	Frequency(MHz)	Result(dBm)	Limit(dBm)	Margin(dBm)
1	2400.0000	-31.94	-19.01	-12.93
2	2416.1250	0.99	-19.01	20.00

Conducted Band Edges (IEEE 802.11g mode / CH High)

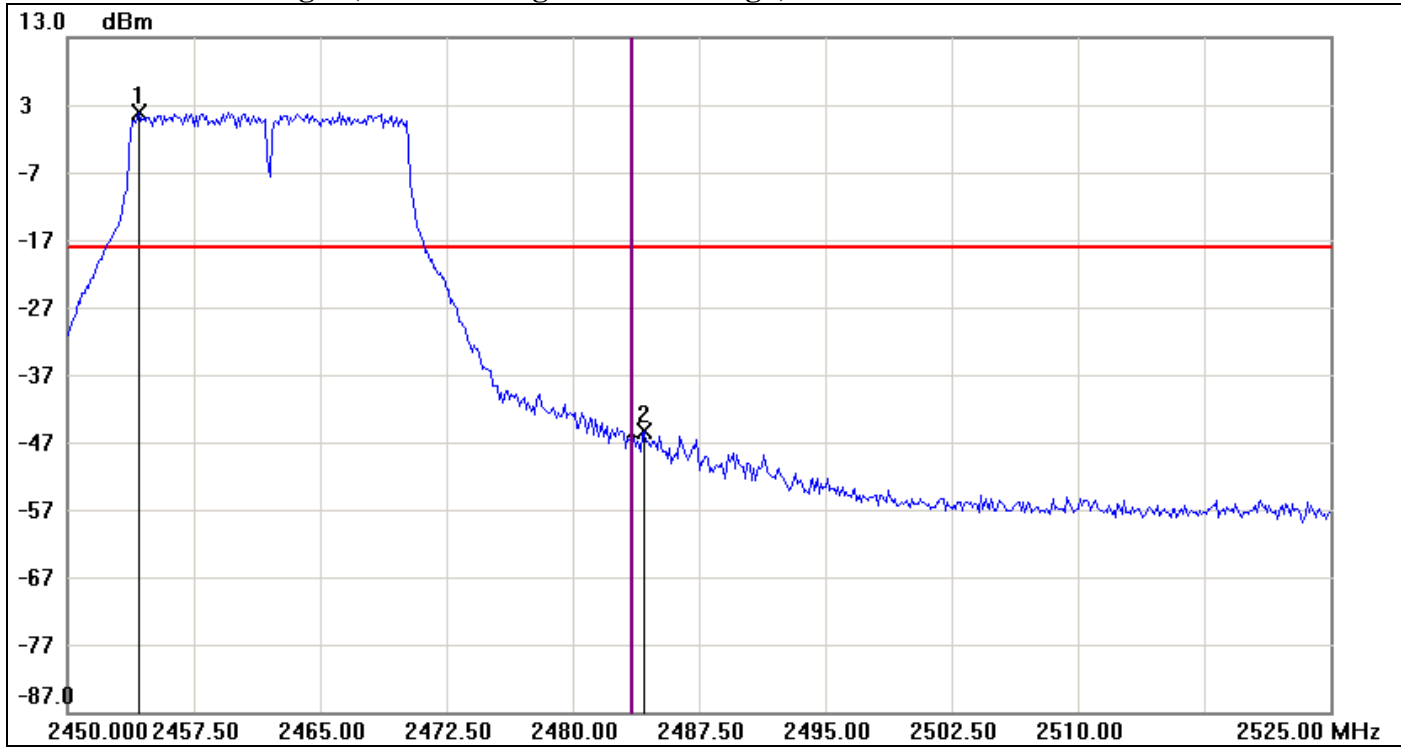

No.	Frequency(MHz)	Result(dBm)	Limit(dBm)	Margin(dBm)
1	2454.2500	2.00	-18.00	20.00
2	2484.2500	-45.48	-18.00	-27.48

Conducted Band Edges (IEEE 802.11n HT 20 MHz mode / CH Low / chain 0)

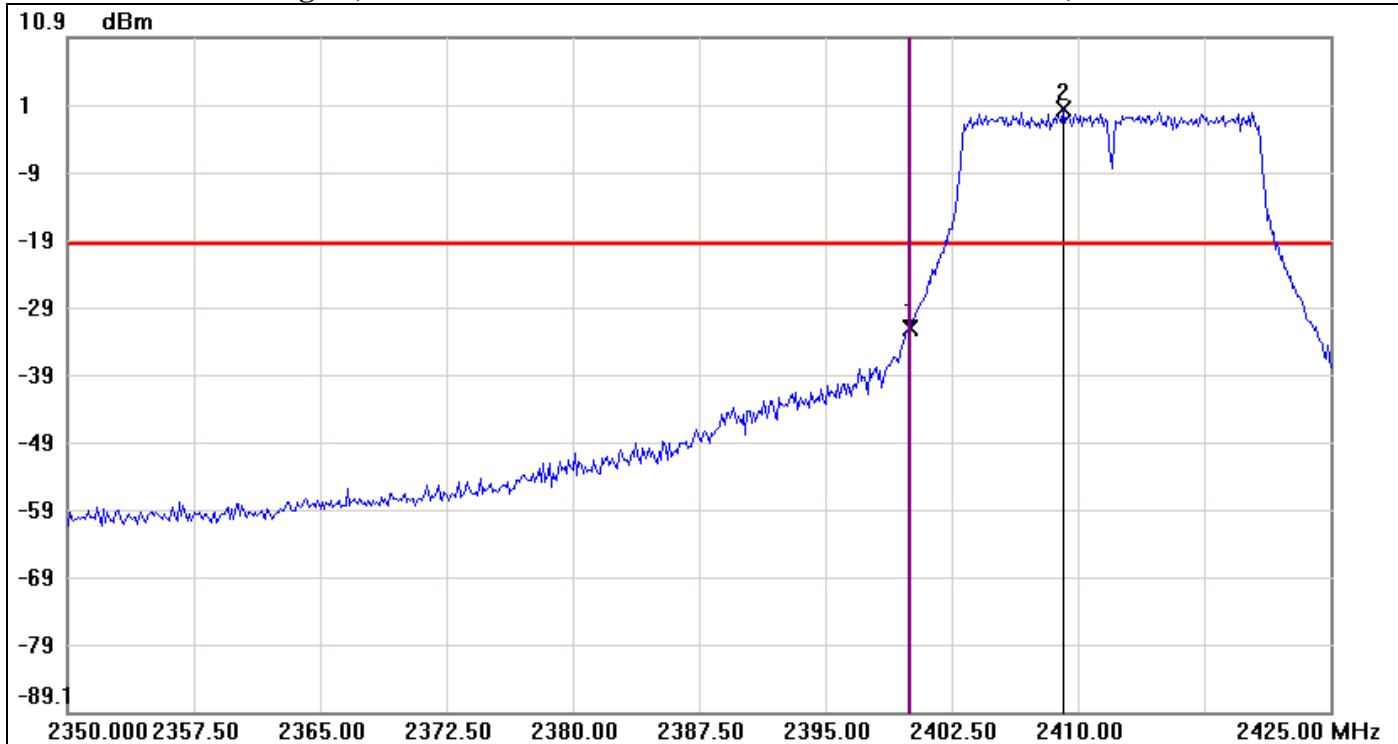

No.	Frequency(MHz)	Result(dBm)	Limit(dBm)	Margin(dBm)
1	2400.0000	-32.09	-19.66	-12.43
2	2409.1250	0.34	-19.66	20.00

Conducted Band Edges (IEEE 802.11n HT 20 MHz mode / CH High / chain 0)

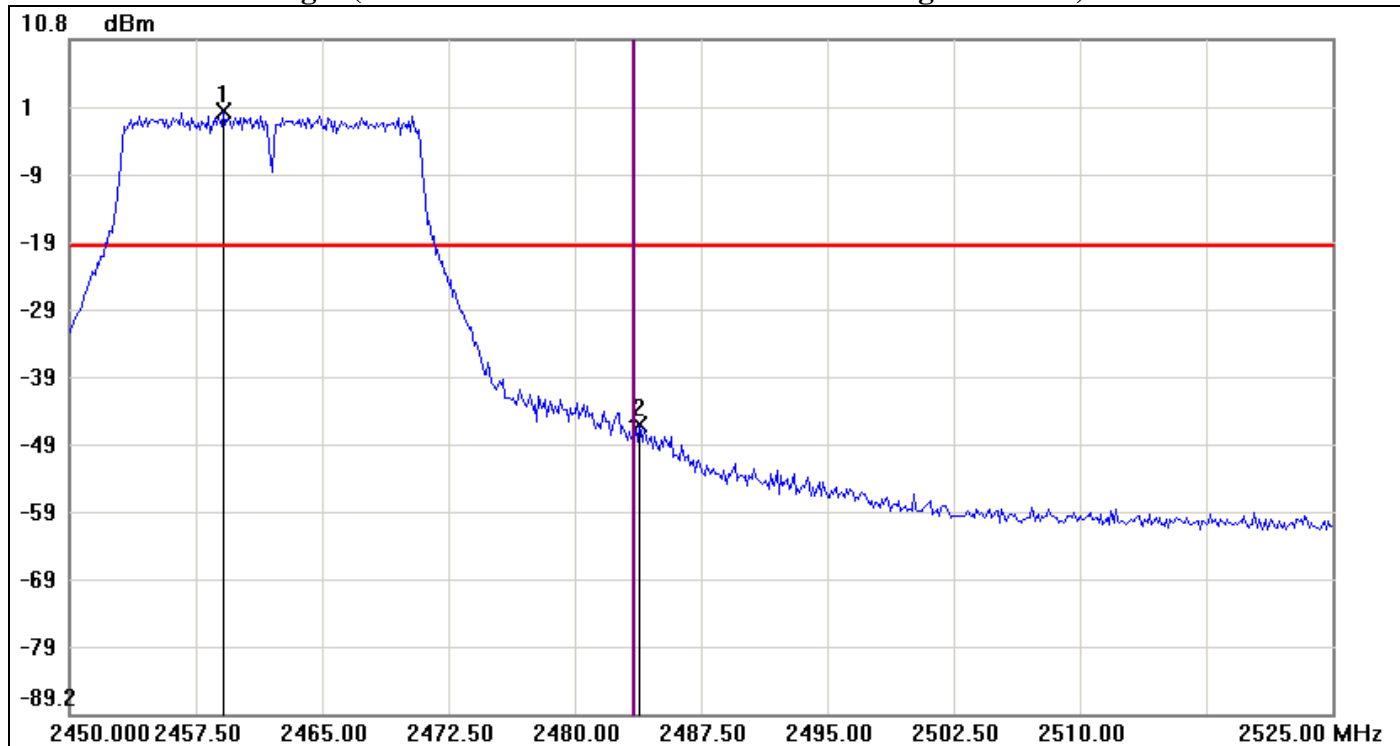

No.	Frequency(MHz)	Result(dBm)	Limit(dBm)	Margin(dBm)
1	2459.1250	0.24	-19.76	20.00
2	2483.8750	-46.24	-19.76	-26.48

Conducted Band Edges (IEEE 802.11n HT 20 MHz mode / CH Low / chain 1)

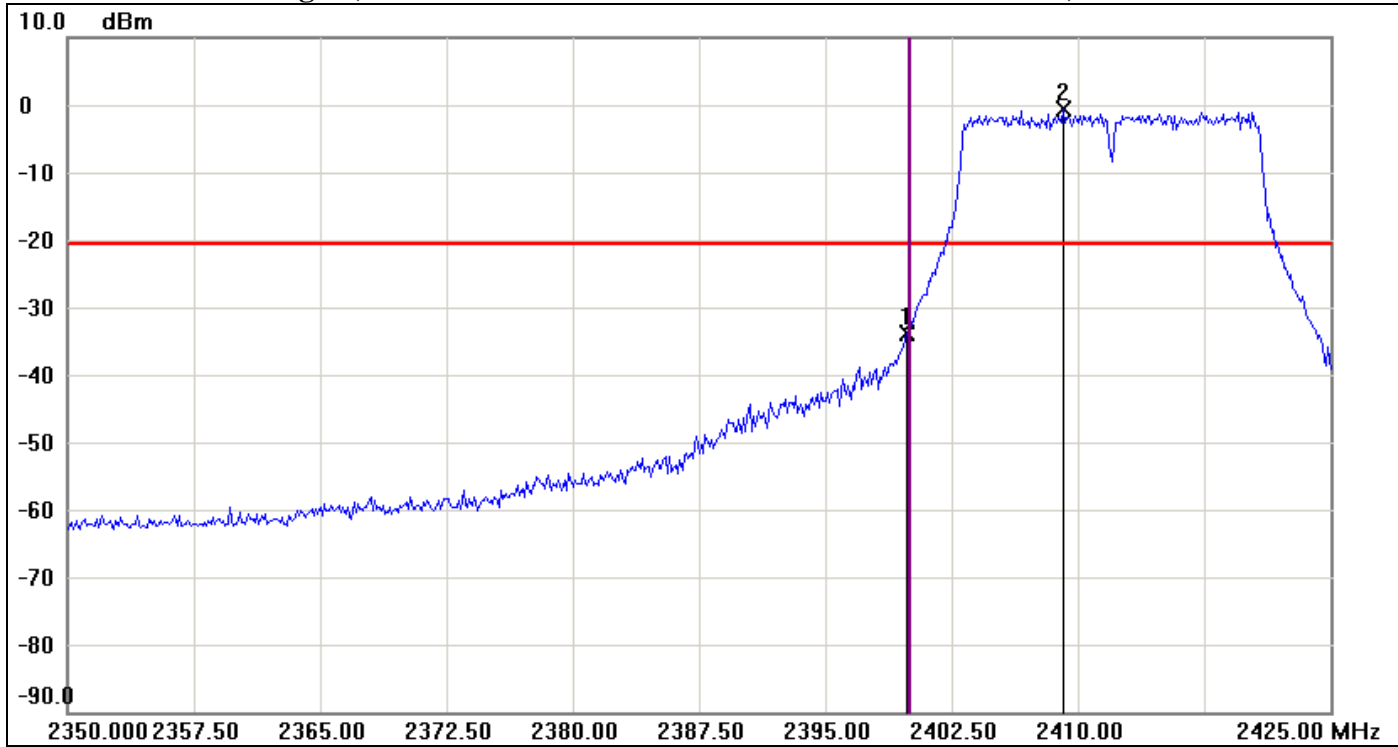

No.	Frequency(MHz)	Result(dBm)	Limit(dBm)	Margin(dBm)
1	2399.8750	-33.85	-20.60	-13.25
2	2409.1250	-0.60	-20.60	20.00

Conducted Band Edges (IEEE 802.11n HT 20 MHz mode / CH High / chain 1)

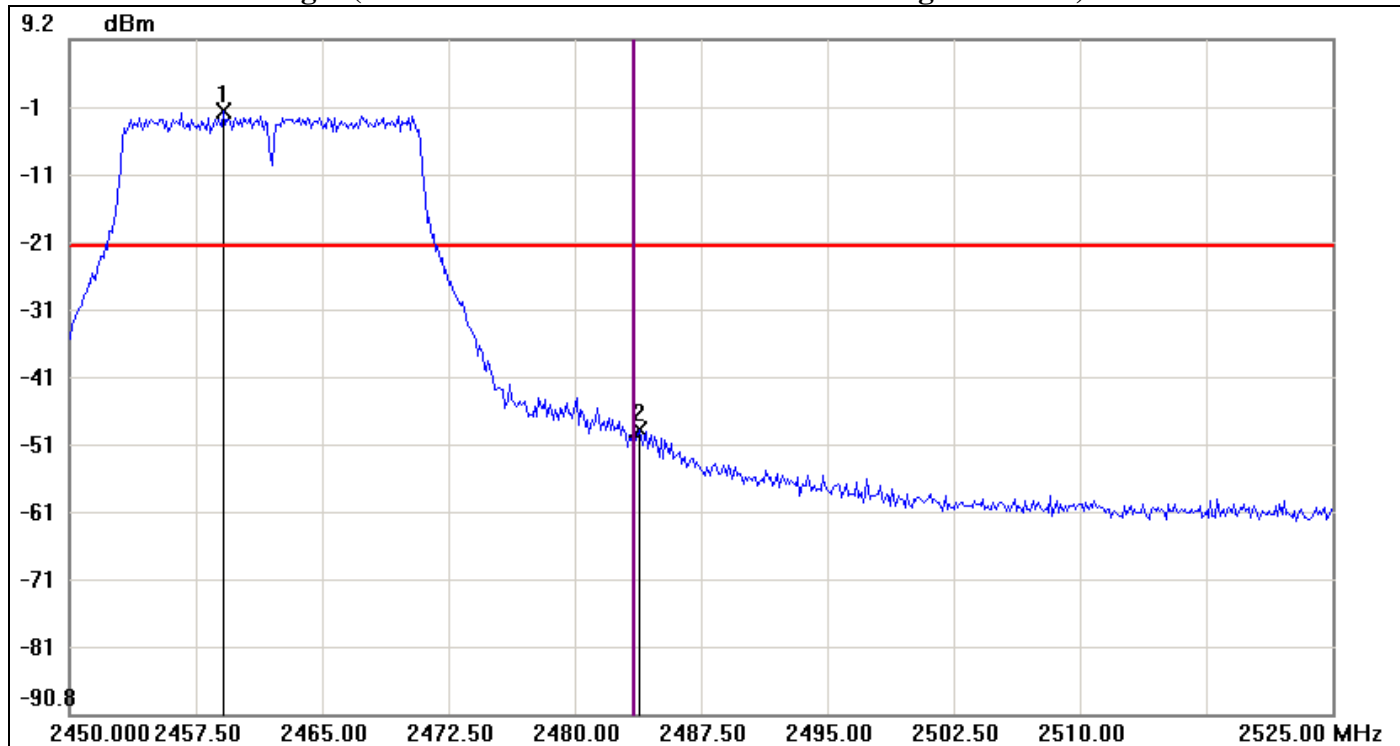

No.	Frequency(MHz)	Result(dBm)	Limit(dBm)	Margin(dBm)
1	2459.1250	-1.51	-21.51	20.00
2	2483.8750	-48.63	-21.51	-27.12

Conducted Band Edges (IEEE 802.11n HT 40 MHz mode / CH Low / chain 0)

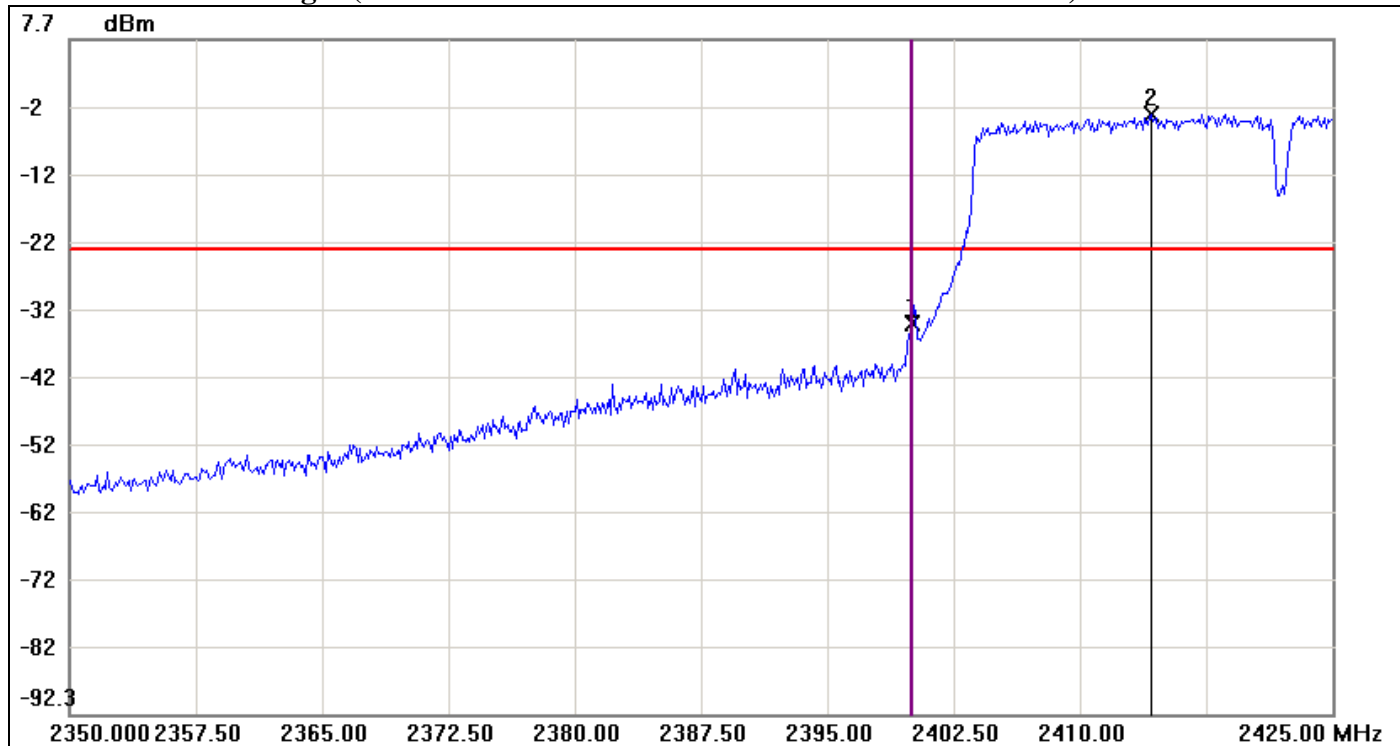

No.	Frequency(MHz)	Result(dBm)	Limit(dBm)	Margin(dBm)
1	2400.0000	-34.51	-23.28	-11.23
2	2414.2500	-3.28	-23.28	20.00

Conducted Band Edges (IEEE 802.11n HT 40 MHz mode / CH High / chain 0)

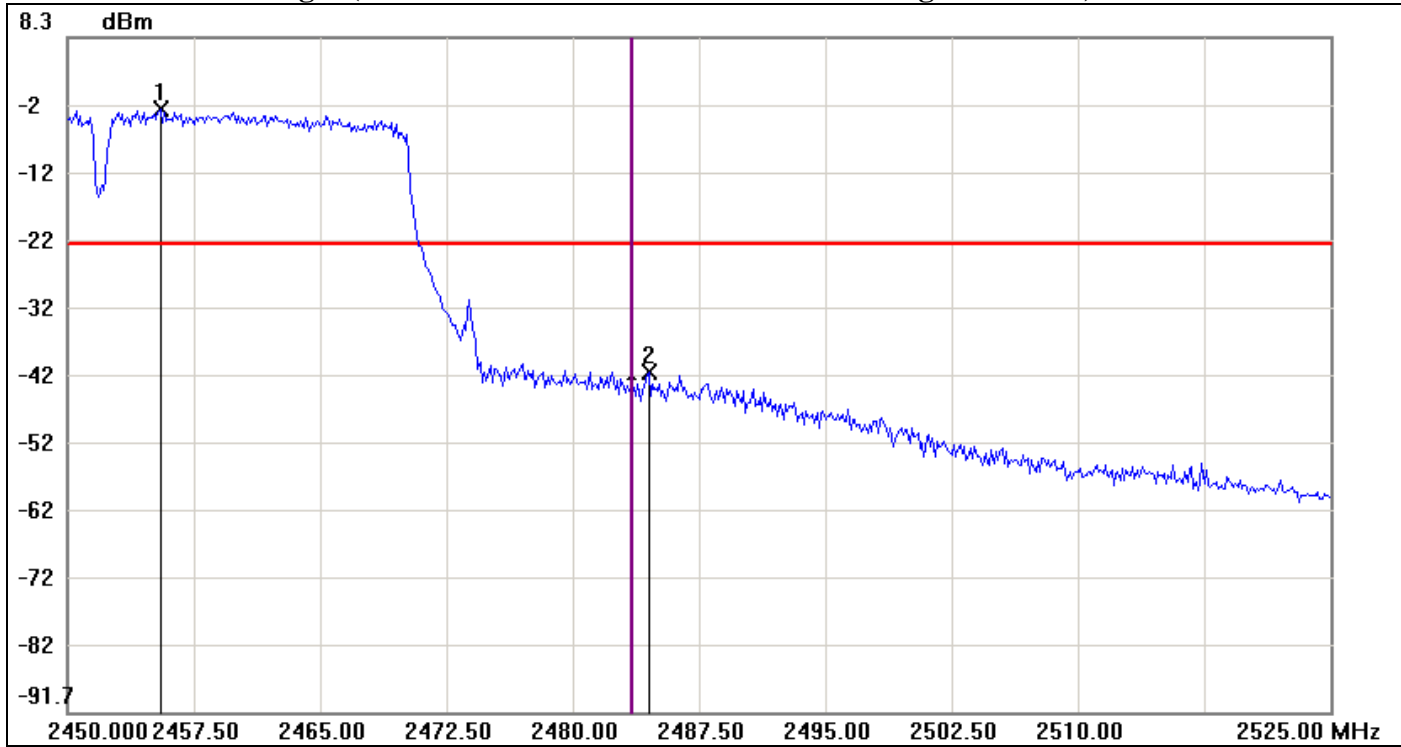

No.	Frequency(MHz)	Result(dBm)	Limit(dBm)	Margin(dBm)
1	2455.5000	-2.46	-22.46	20.00
2	2484.5000	-41.27	-22.46	-18.81

Conducted Band Edges (IEEE 802.11n HT 40 MHz mode / CH Low / chain 1)

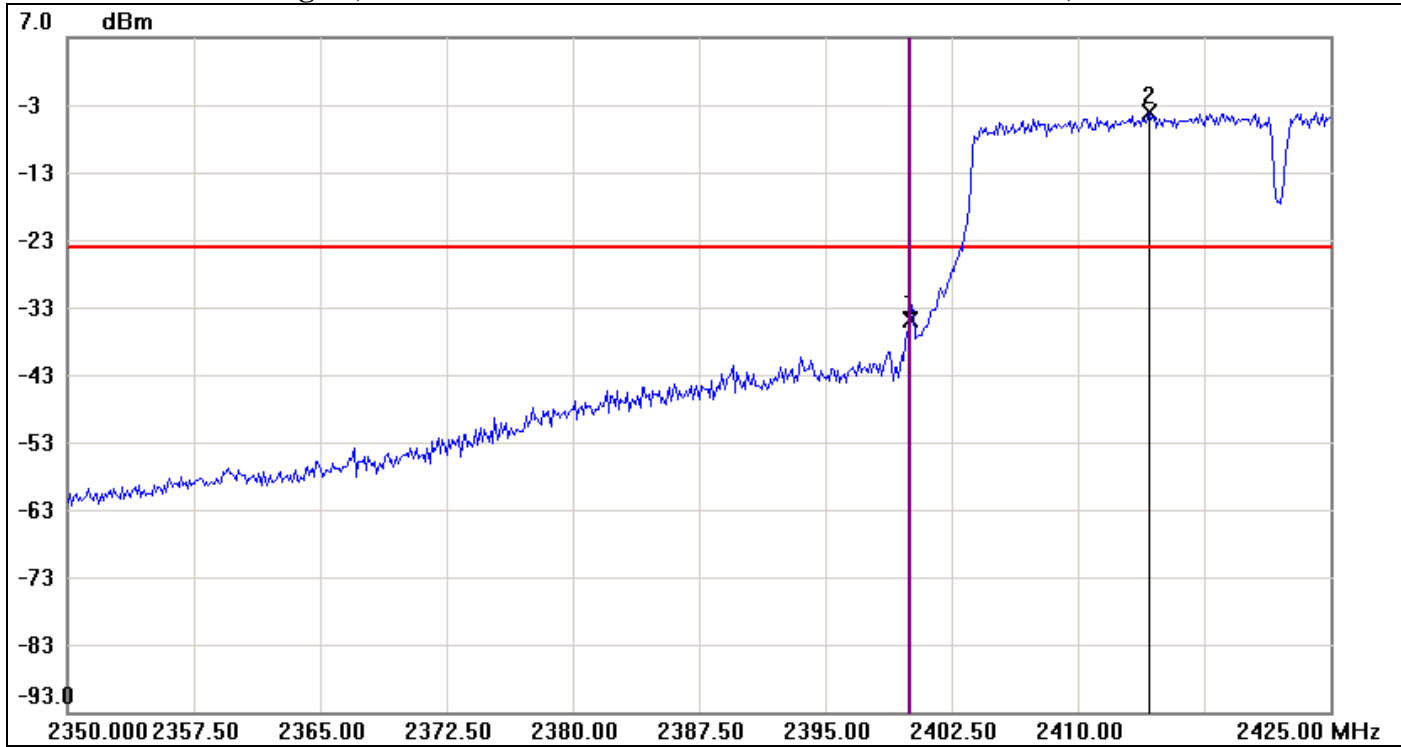

No.	Frequency(MHz)	Result(dBm)	Limit(dBm)	Margin(dBm)
1	2400.0000	-34.81	-24.18	-10.63
2	2414.2500	-4.18	-24.18	20.00

Conducted Band Edges (IEEE 802.11n HT 40 MHz mode / CH High / chain 1)

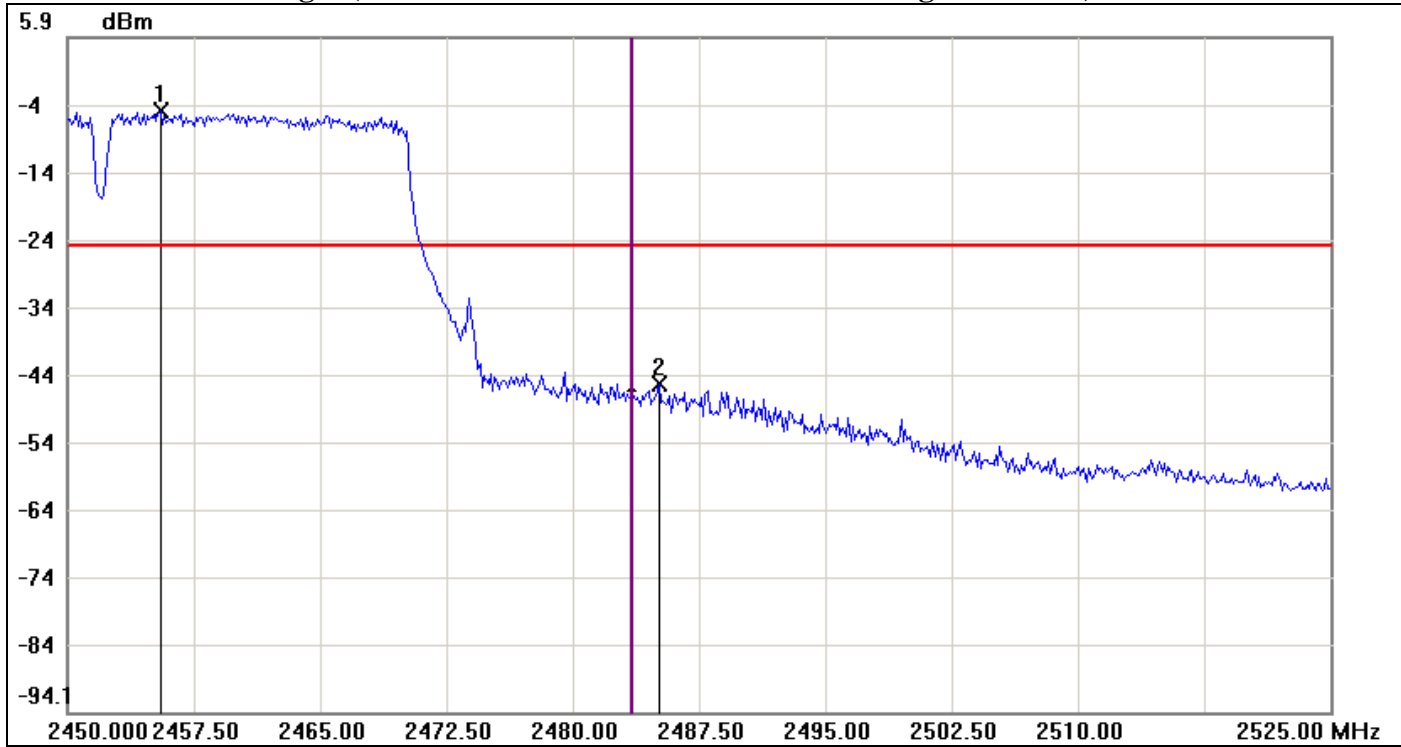

No.	Frequency(MHz)	Result(dBm)	Limit(dBm)	Margin(dBm)
1	2455.5000	-5.02	-25.02	20.00
2	2485.1250	-45.43	-25.02	-20.41

7.5 PEAK POWER SPECTRAL DENSITY

LIMIT

1. According to §15.247(e), for digitally modulated systems, the power spectral density conducted from the intentional radiator to the antenna shall not be greater than 8 dBm in any 3 kHz band during any time interval of continuous transmission.
2. According to §15.247(f), the digital modulation operation of the hybrid system, with the frequency hopping turned off, shall comply with the power density requirements of paragraph (d) of this section.

Test Configuration

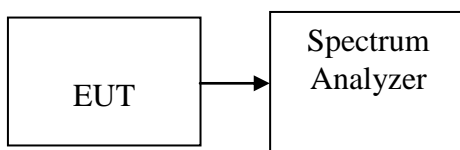

TEST PROCEDURE

1. Place the EUT on the table and set it in transmitting mode.
Remove the antenna from the EUT and then connect a low loss RF cable from the antenna port to the spectrum analyzer.
2. Set the spectrum analyzer as RBW=10kHz,VBW=100kHz,Span=1.5 times the DTS bandwidth, Sweep time= auto
3. Record the max reading.
4. Repeat the above procedure until the measurements for all frequencies are completed.

TEST RESULTS

No non-compliance noted.

Test Data

Test mode: IEEE 802.11b mode

Channel	Frequency (MHz)	PPSD (dBm)	Limit (dBm)	Result
Low	2412	-1.97	8.00	PASS
Mid	2437	-1.62		PASS
High	2462	-1.63		PASS

Test mode: IEEE 802.11g mode

Channel	Frequency (MHz)	PPSD (dBm)	Limit (dBm)	Result
Low	2412	-6.53	8.00	PASS
Mid	2437	-5.70		PASS
High	2462	-5.62		PASS

Test mode: IEEE 802.11n HT 20 MHz mode

Channel	Frequency (MHz)	Chain 0 PPSD (dBm)	Chain 1 PPSD (dBm)	PPSD (dBm)	Limit (dBm)	Result
Low	2412	-6.55	-7.34	-3.92	8.00	PASS
Mid	2437	-6.59	-7.38	-3.96		PASS
High	2462	-6.70	-8.30	-4.42		PASS

nTest mode: IEEE 802.11n HT 40 MHz mode

Channel	Frequency (MHz)	Chain 0 PPSD (dBm)	Chain 1 PPSD (dBm)	PPSD (dBm)	Limit (dBm)	Result
Low	2422	-9.24	-9.79	-6.50	8.00	PASS
Mid	2437	-9.26	-11.79	-7.33		PASS
High	2452	-8.12	-11.63	-6.52		PASS

Remark:

1. Total PPSD (dBm) = $10 * \text{LOG}(10^{(\text{Chain 0 PPSD} / 10)} + 10^{(\text{Chain 1 PPSD} / 10)})$

Test Plot

IEEE 802.11b mode

PPSD (CH Low)

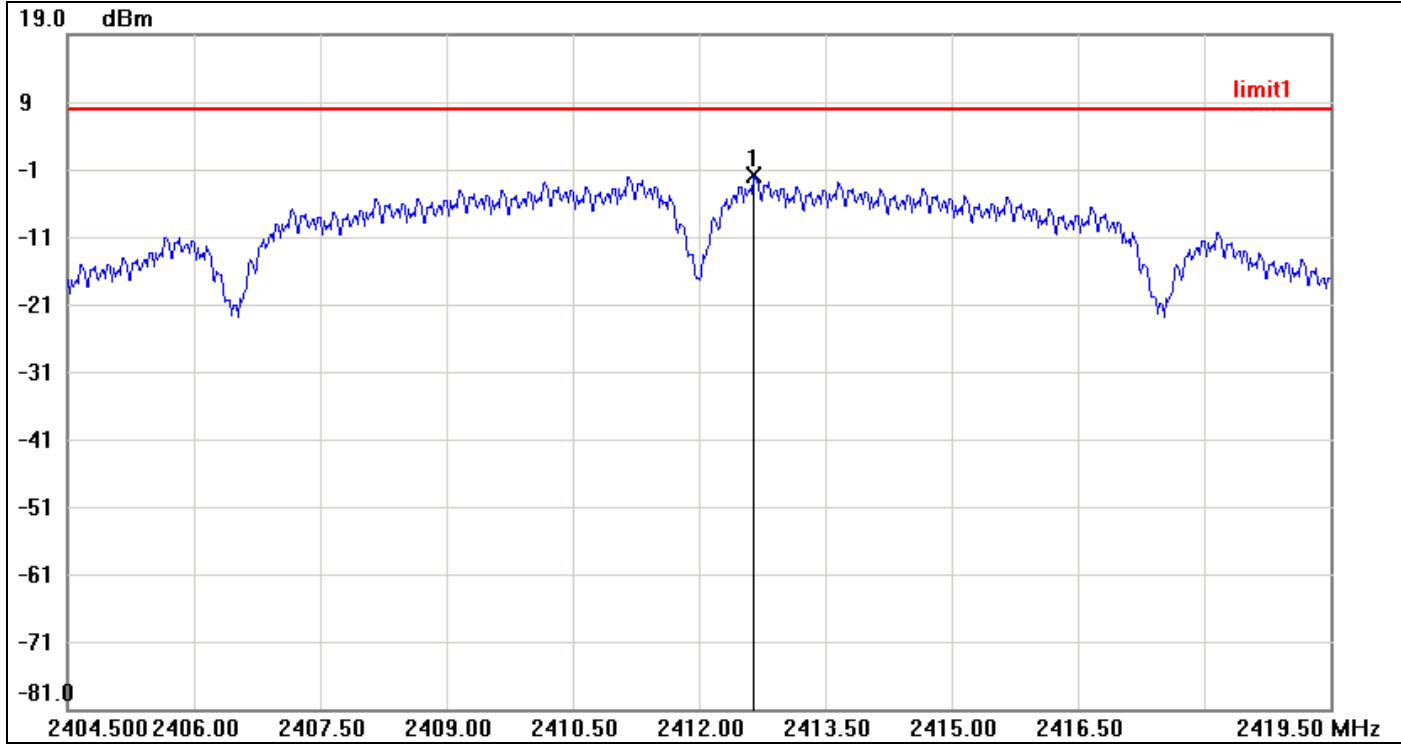

No.	Frequency(MHz)	Result(dBm)	Limit(dBm)	Margin(dBm)
1	2412.6500	-1.97	8.00	-9.97

PPSD (CH Mid)

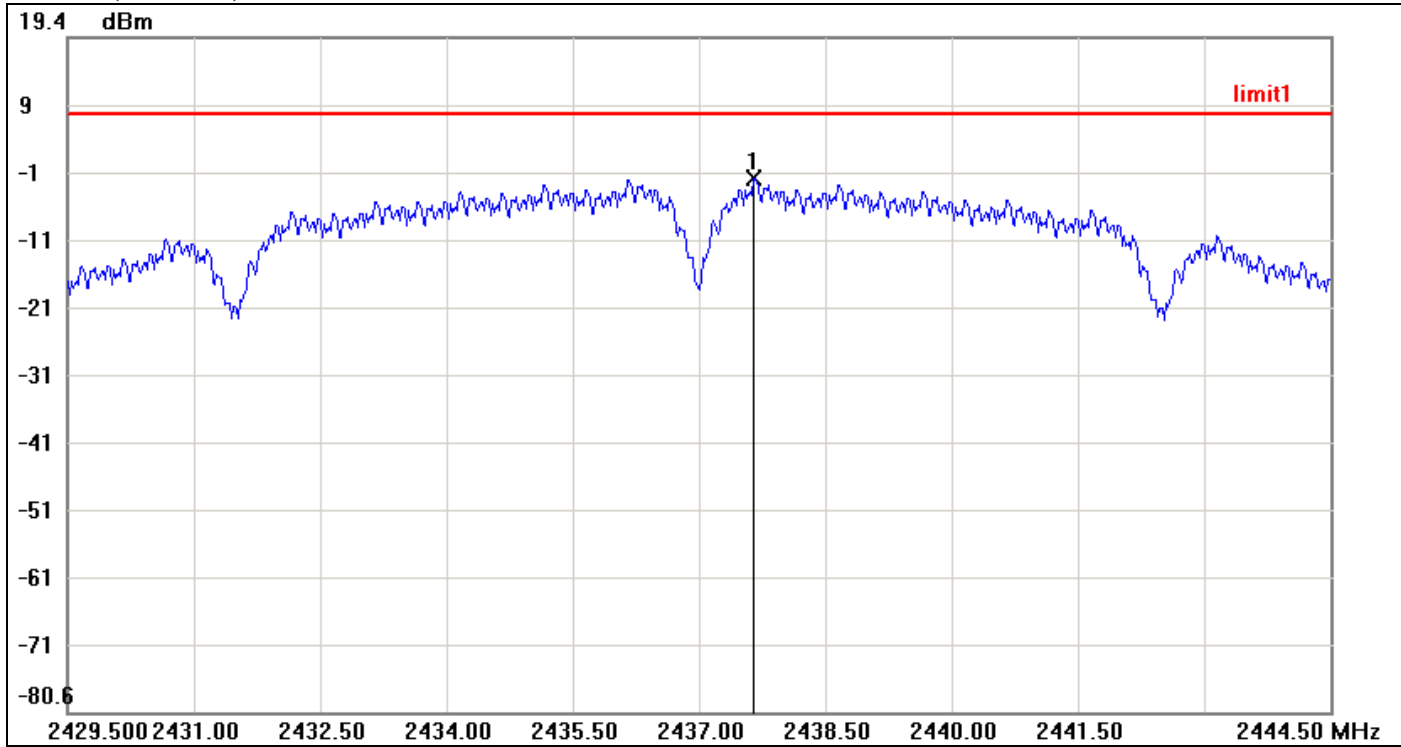

No.	Frequency(MHz)	Result(dBm)	Limit(dBm)	Margin(dBm)
1	2437.6500	-1.62	8.00	-9.62

PPSD (CH High)

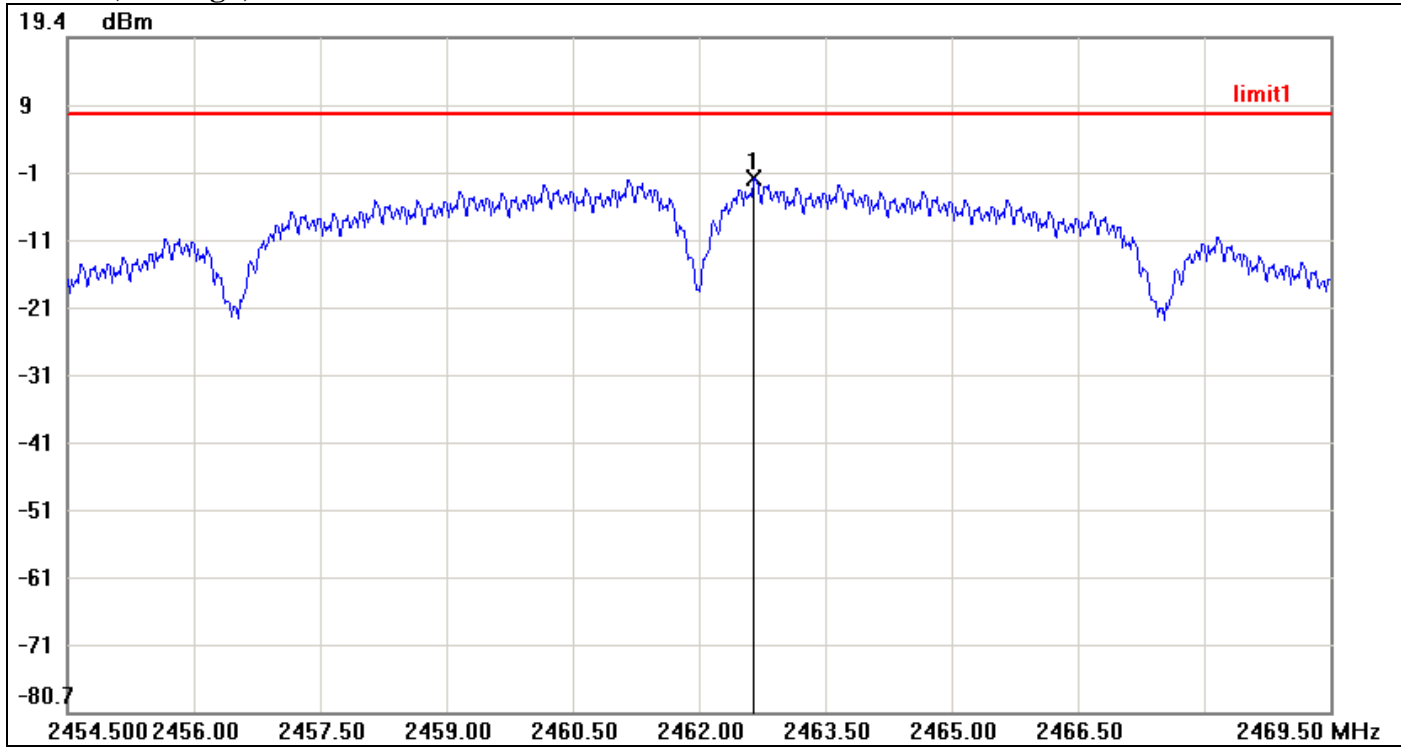

No.	Frequency(MHz)	Result(dBm)	Limit(dBm)	Margin(dBm)
1	2462.6500	-1.63	8.00	-9.63

IEEE 802.11g mode

PPSD (CH Low)

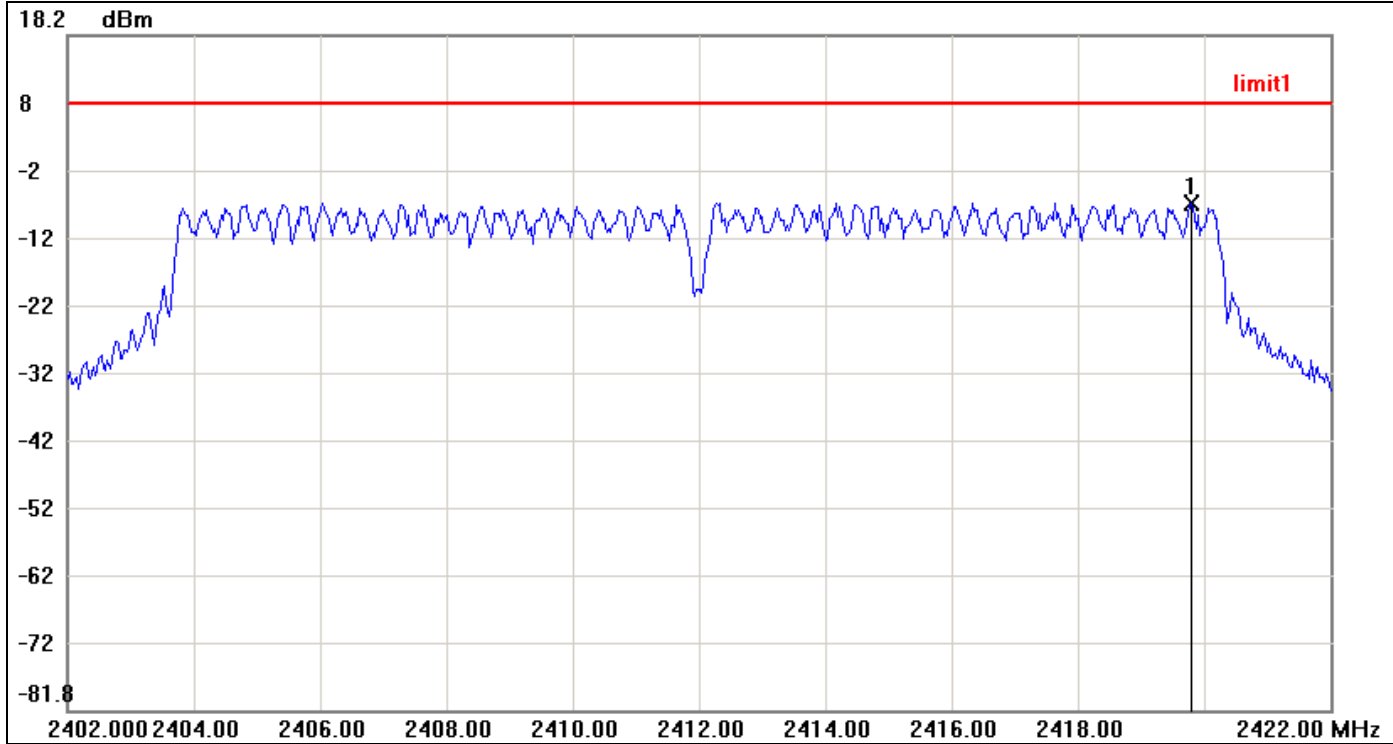

No.	Frequency(MHz)	Result(dBm)	Limit(dBm)	Margin(dBm)
1	2419.8000	-6.53	8.00	-14.53

PPSD (CH Mid)

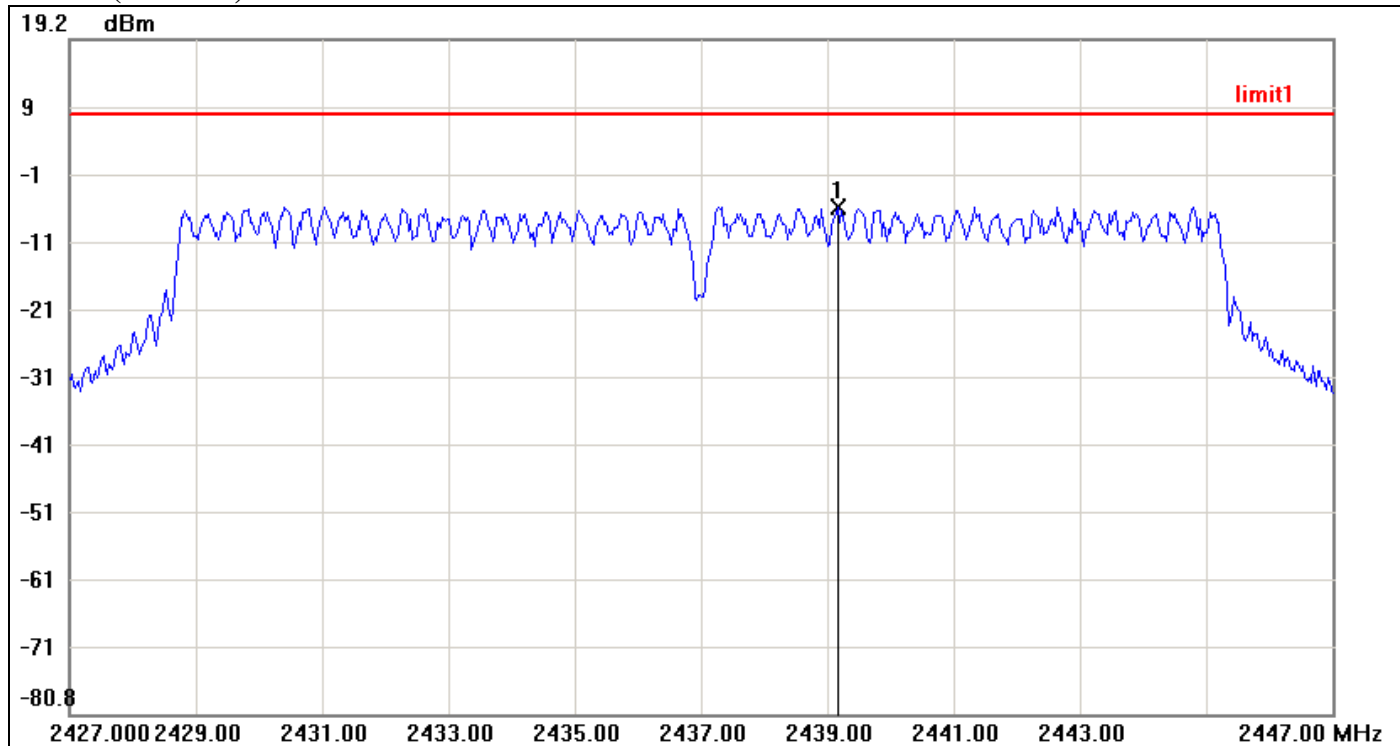

No.	Frequency(MHz)	Result(dBm)	Limit(dBm)	Margin(dBm)
1	2439.1667	-5.70	8.00	-13.70

PPSD (CH High)

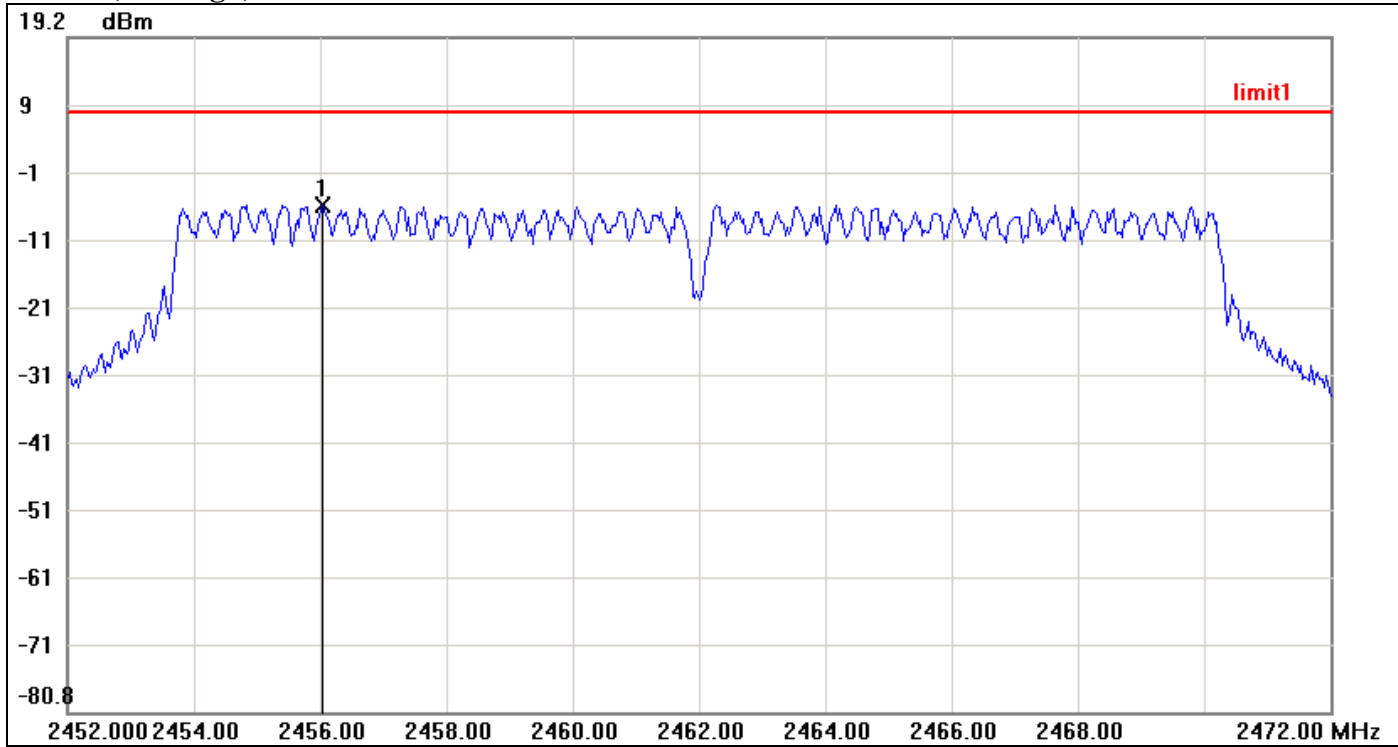

No.	Frequency(MHz)	Result(dBm)	Limit(dBm)	Margin(dBm)
1	2456.0333	-5.62	8.00	-13.62

IEEE 802.11n HT 20 MHz mode / Chain 0

PPSD (CH Low)

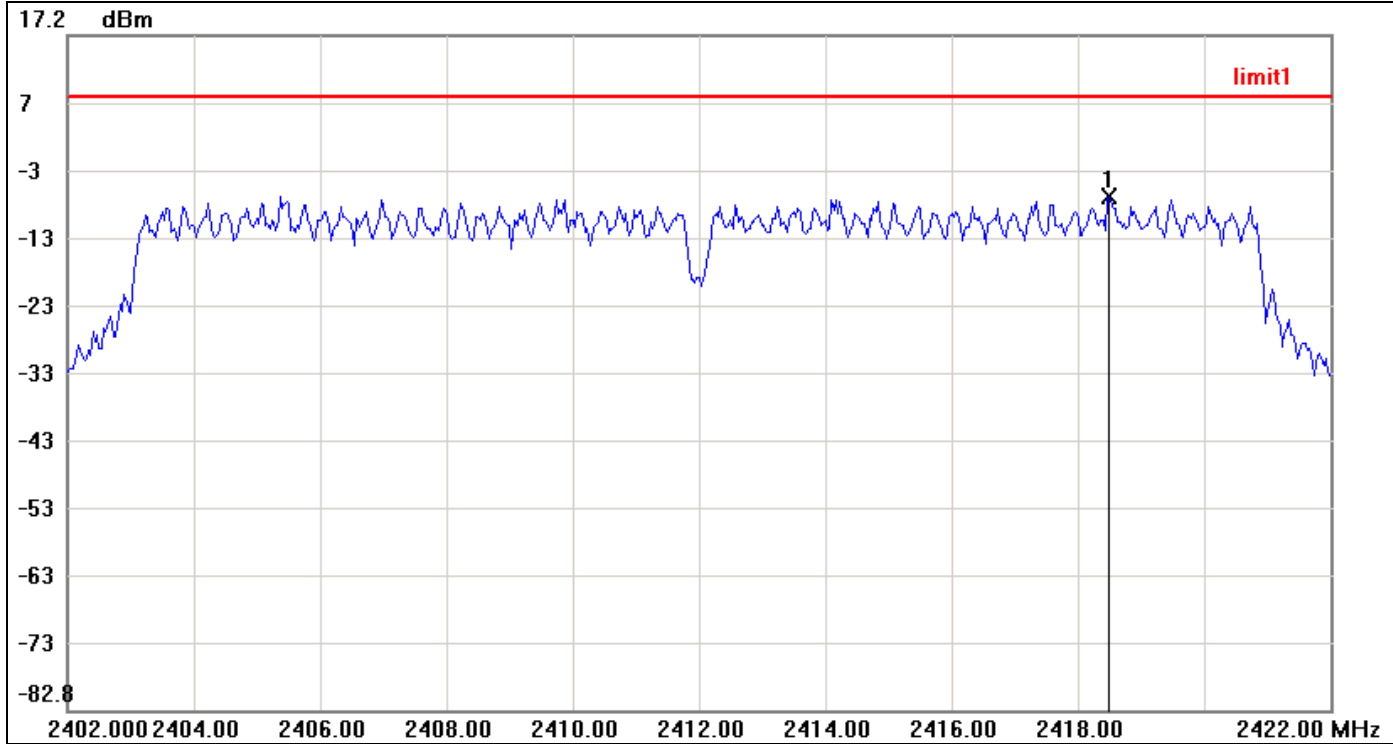

No.	Frequency(MHz)	Result(dBm)	Limit(dBm)	Margin(dBm)
1	2418.5000	-6.55	8.00	-14.55

PPSD (CH Mid)

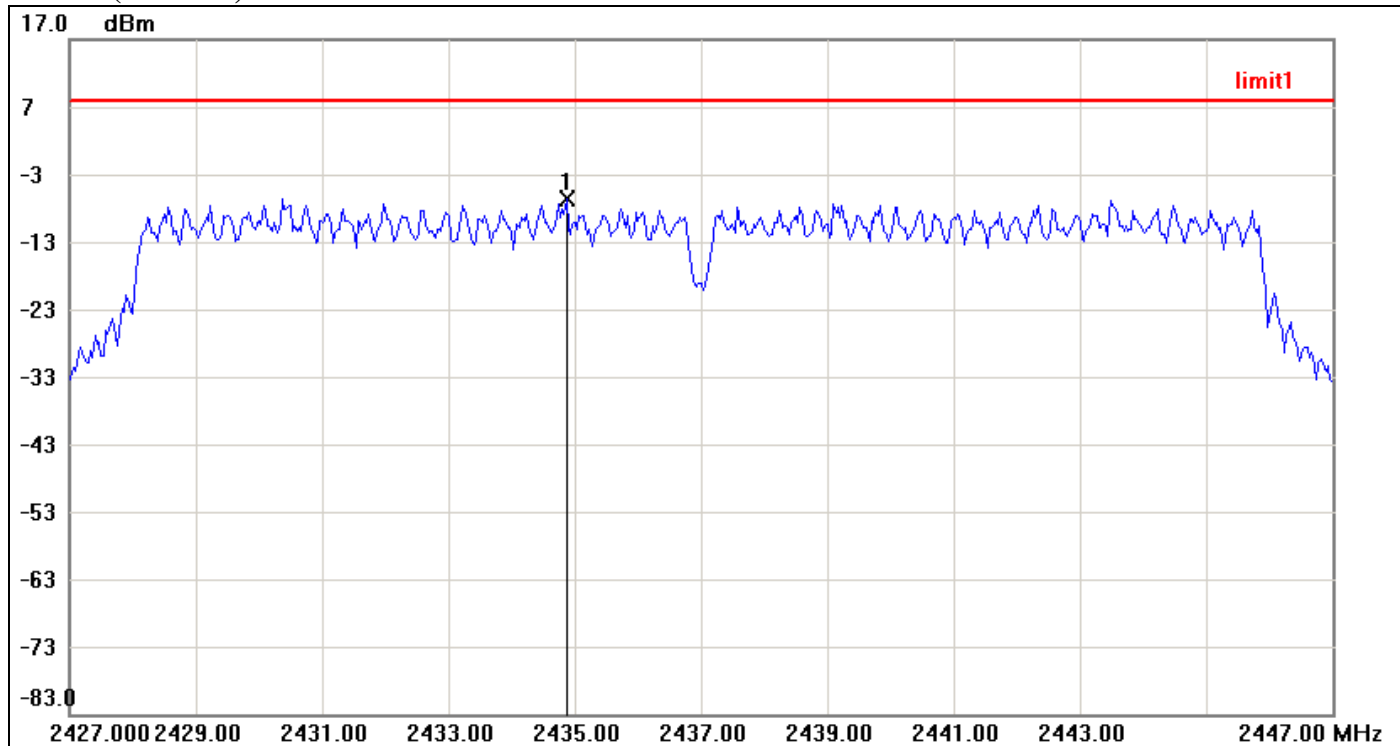

No.	Frequency(MHz)	Result(dBm)	Limit(dBm)	Margin(dBm)
1	2434.8667	-6.59	8.00	-14.59

PPSD (CH High)

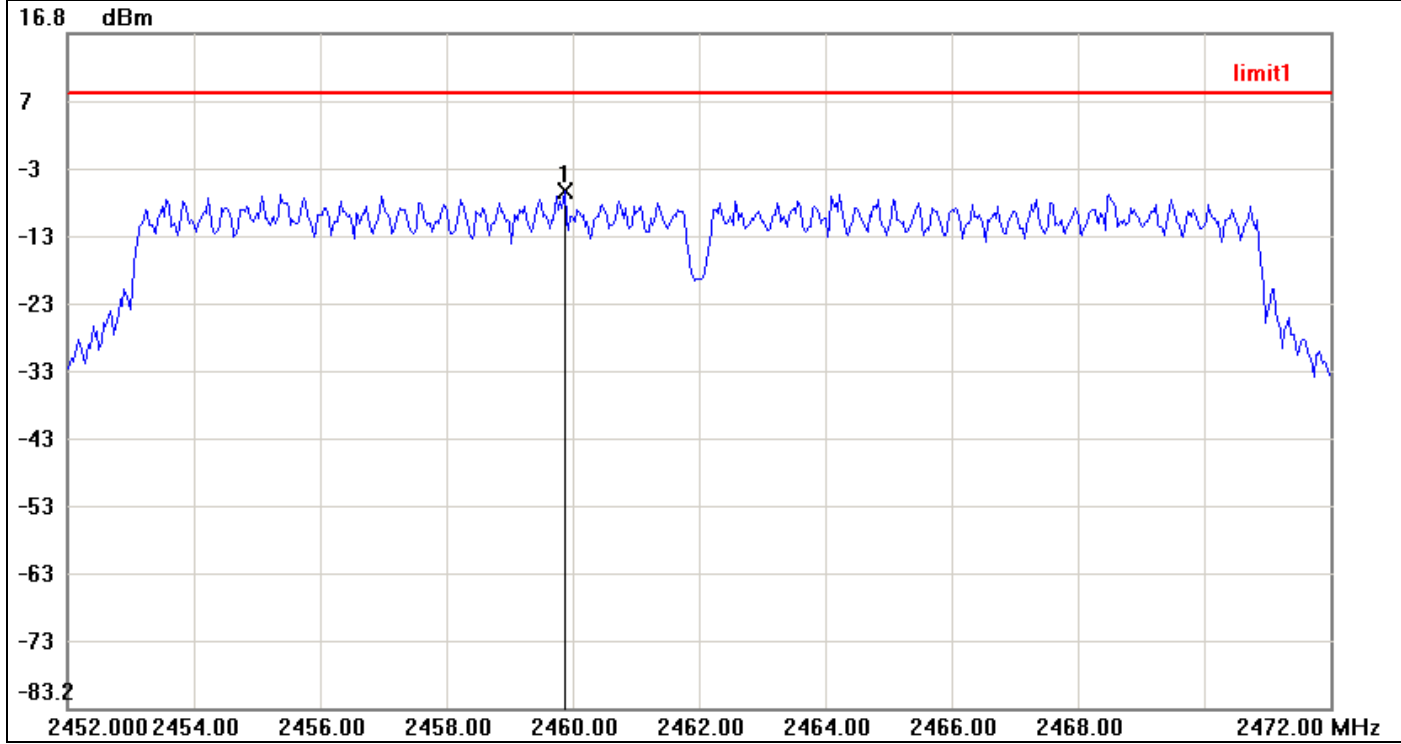

No.	Frequency(MHz)	Result(dBm)	Limit(dBm)	Margin(dBm)
1	2459.8667	-6.70	8.00	-14.70

IEEE 802.11n HT 20 MHz mode / Chain 1

PPSD (CH Low)

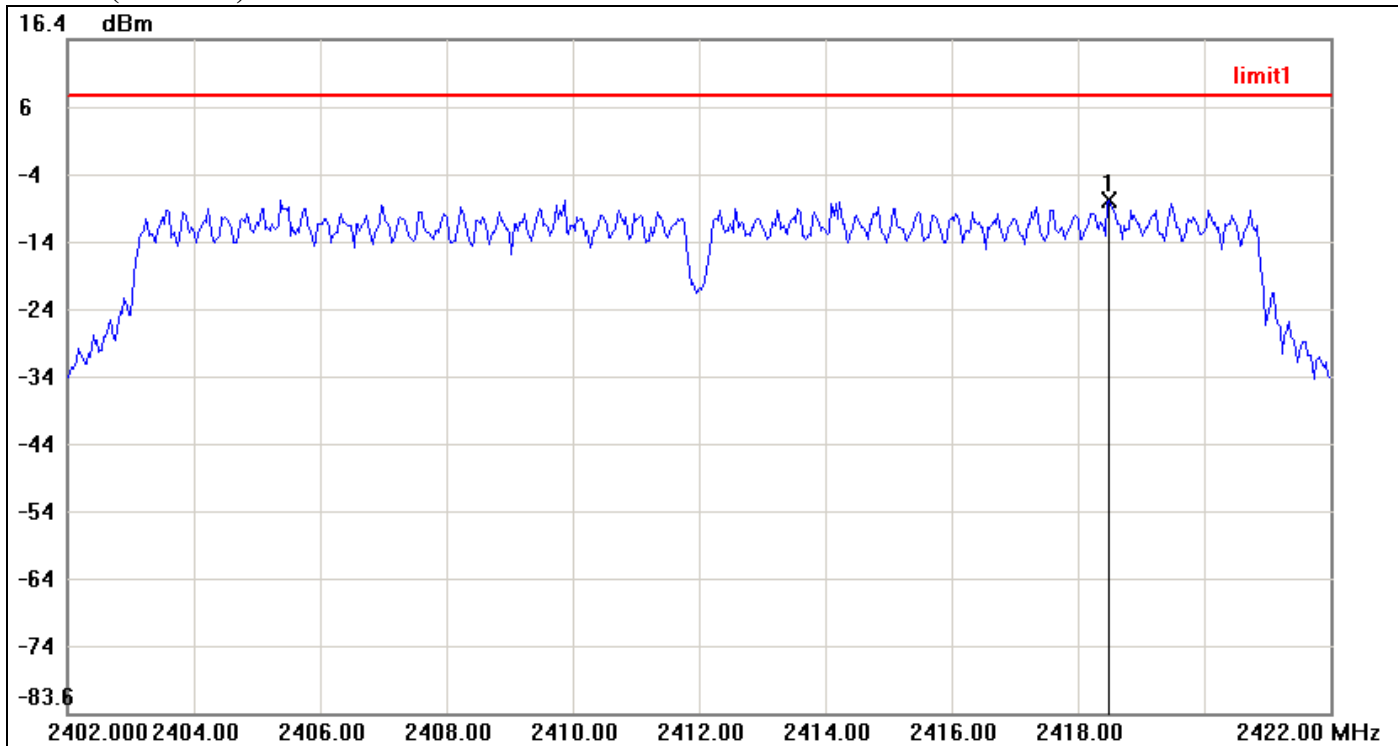

No.	Frequency(MHz)	Result(dBm)	Limit(dBm)	Margin(dBm)
1	2418.5000	-7.34	8.00	-15.34

PPSD (CH Mid)

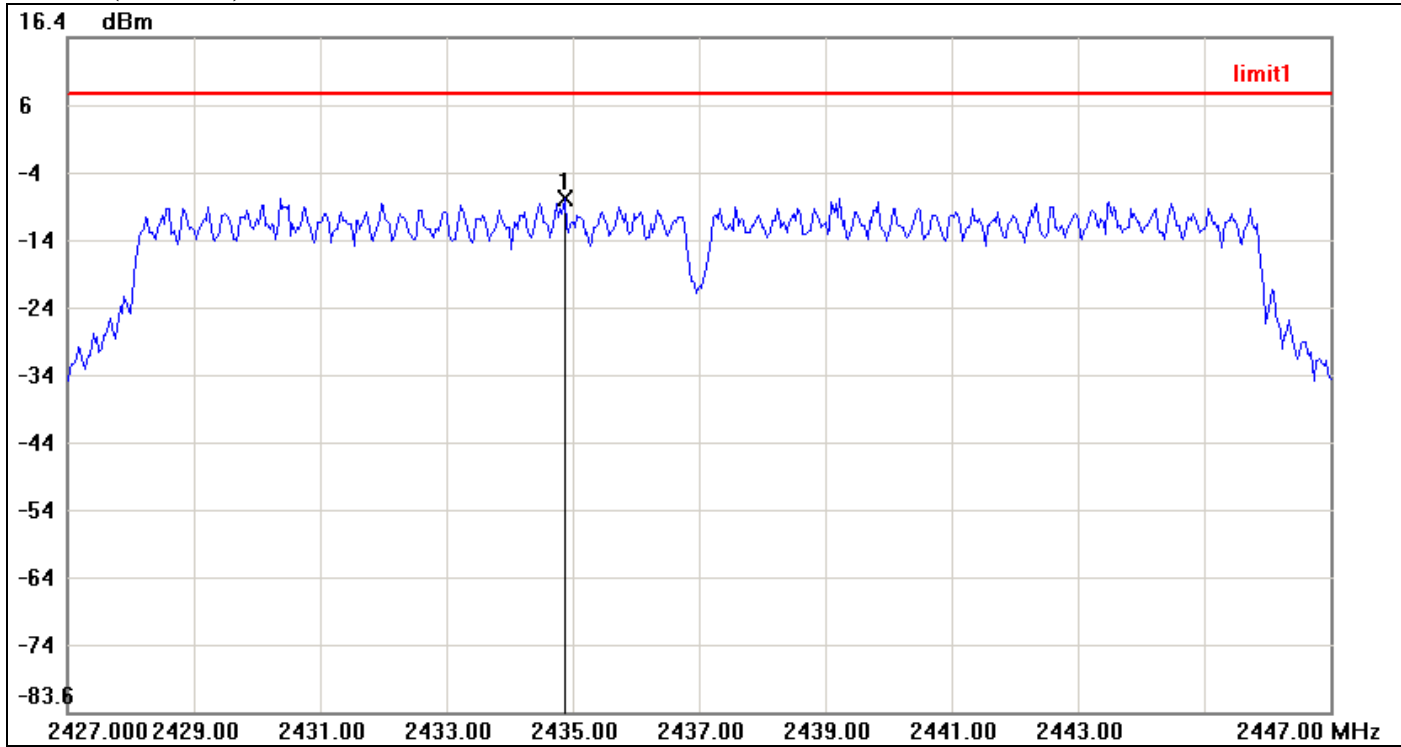

No.	Frequency(MHz)	Result(dBm)	Limit(dBm)	Margin(dBm)
1	2434.8667	-7.38	8.00	-15.38

PPSD (CH High)

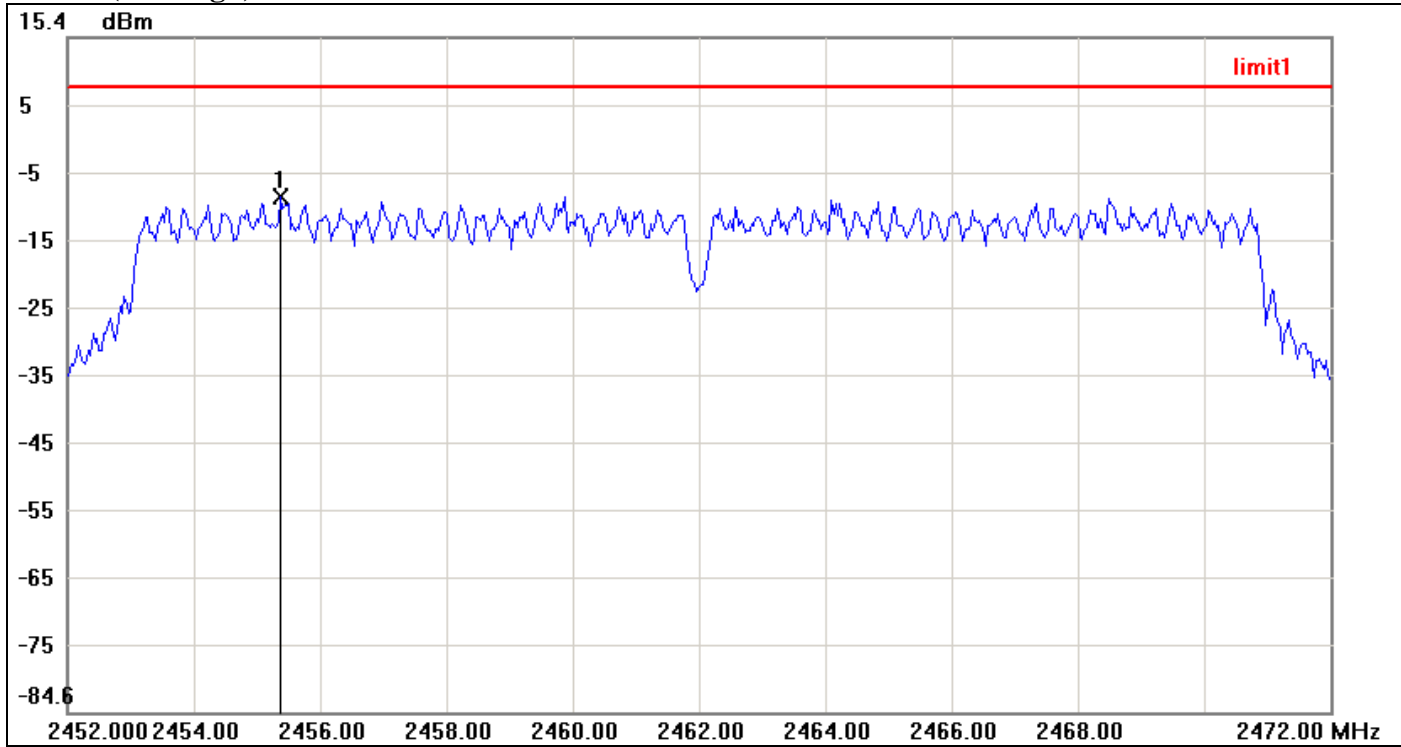

No.	Frequency(MHz)	Result(dBm)	Limit(dBm)	Margin(dBm)
1	2455.3667	-8.30	8.00	-16.30

IEEE 802.11n HT 40 MHz mode / Chain 0

PPSD (CH Low)

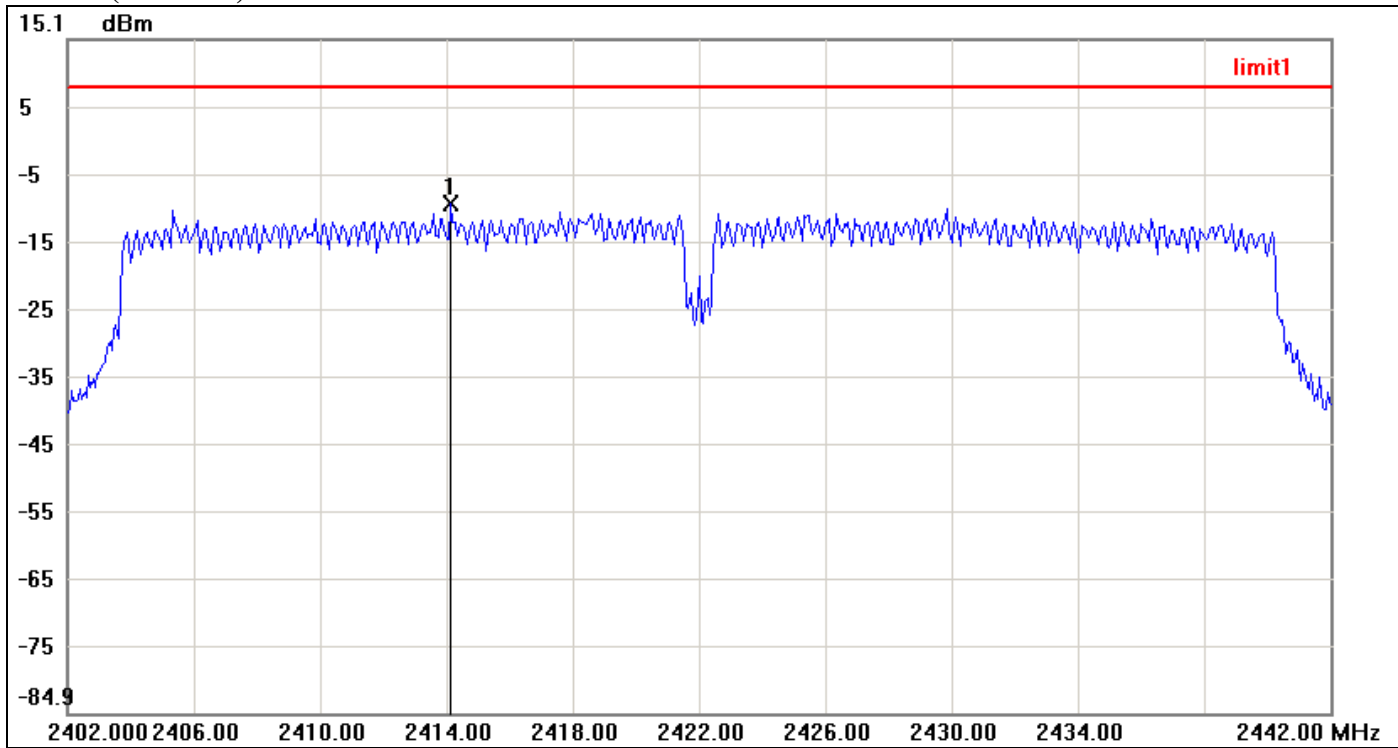

No.	Frequency(MHz)	Result(dBm)	Limit(dBm)	Margin(dBm)
1	2414.1333	-9.24	8.00	-17.24

PPSD (CH Mid)

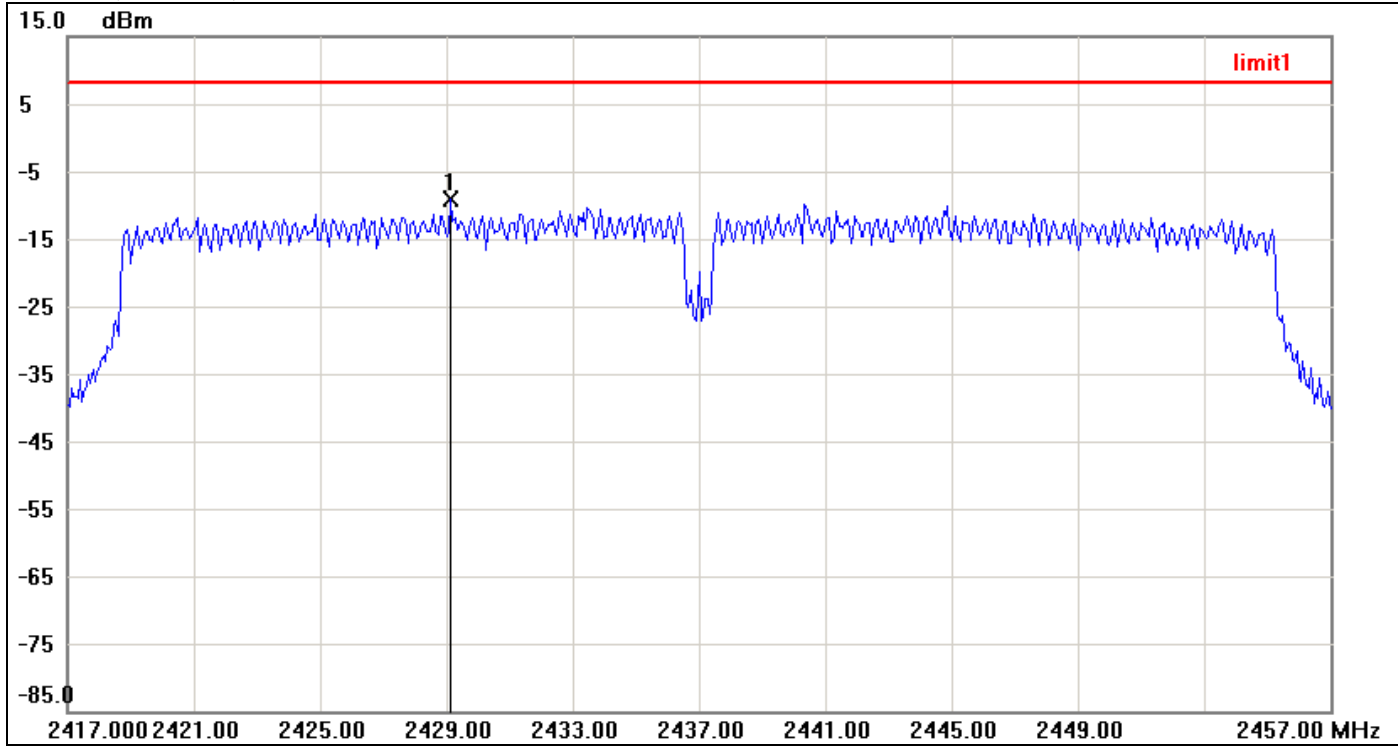

No.	Frequency(MHz)	Result(dBm)	Limit(dBm)	Margin(dBm)
1	2429.1333	-9.26	8.00	-17.26

PPSD (CH High)

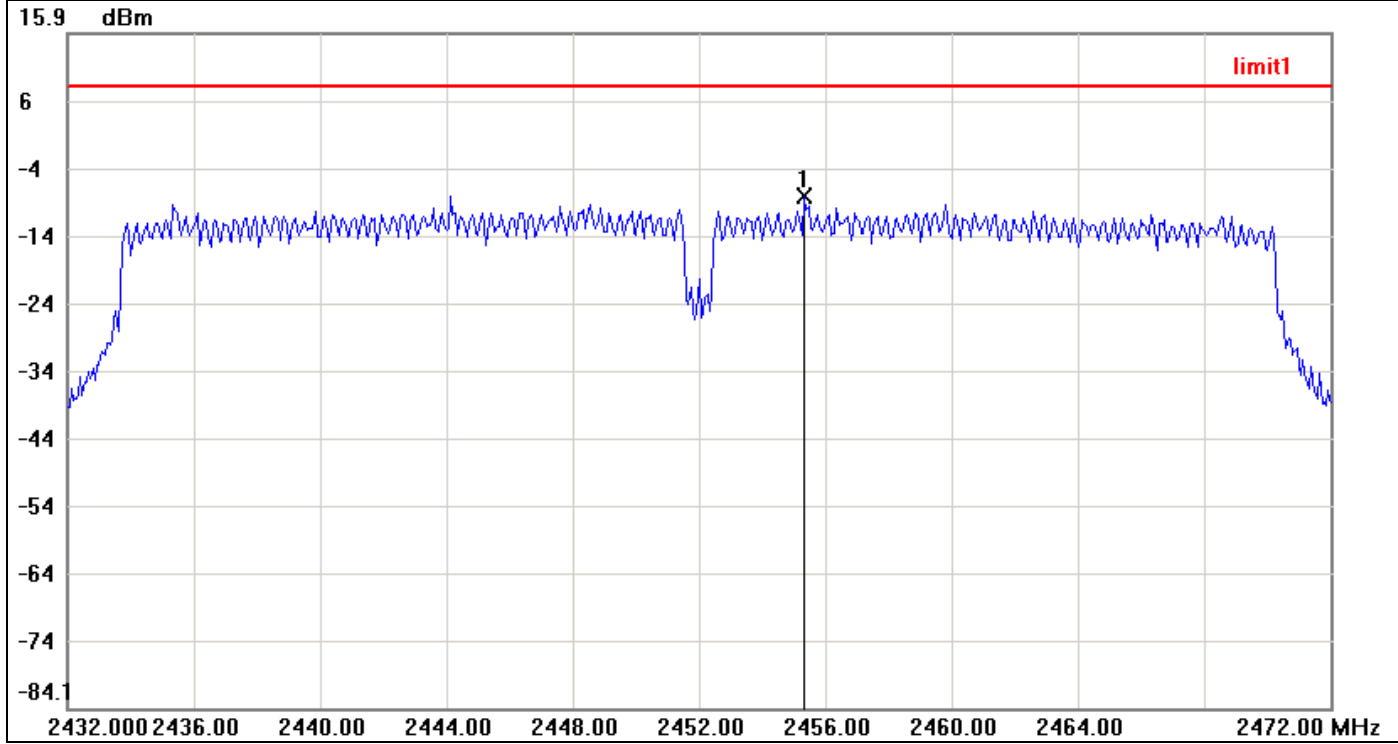

No.	Frequency(MHz)	Result(dBm)	Limit(dBm)	Margin(dBm)
1	2455.3333	-8.12	8.00	-16.12

IEEE 802.11n HT 40 MHz mode / Chain 1

PPSD (CH Low)

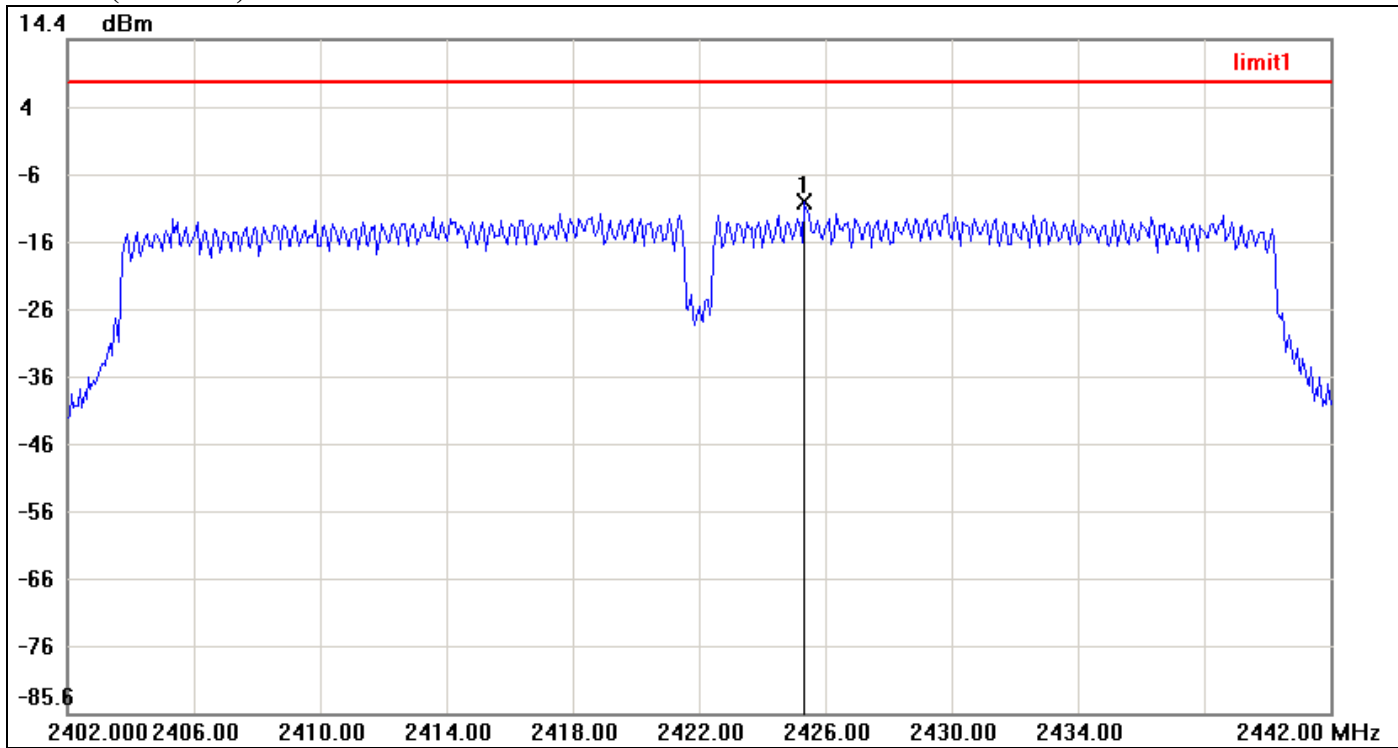

No.	Frequency(MHz)	Result(dBm)	Limit(dBm)	Margin(dBm)
1	2425.3333	-9.79	8.00	-17.79

PPSD (CH Mid)

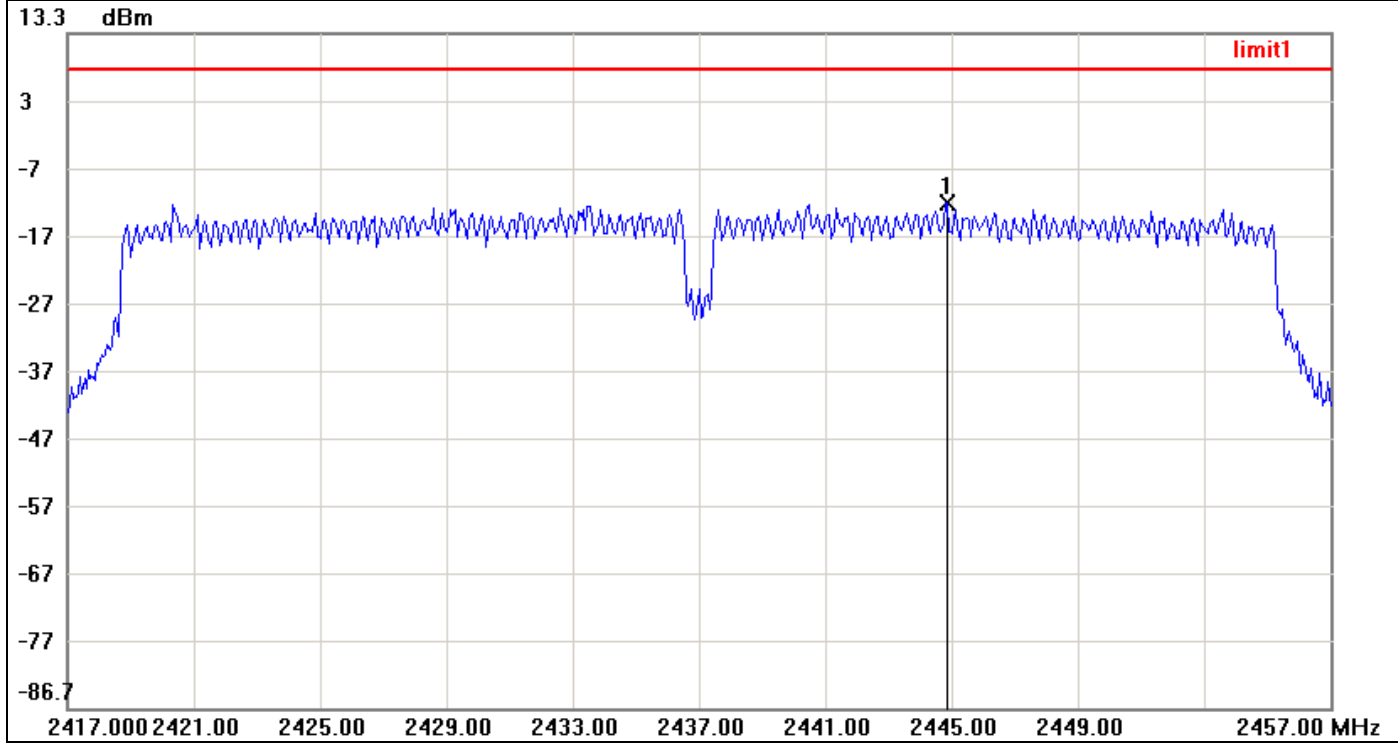

No.	Frequency(MHz)	Result(dBm)	Limit(dBm)	Margin(dBm)
1	2444.8667	-11.79	8.00	-19.79

PPSD (CH High)

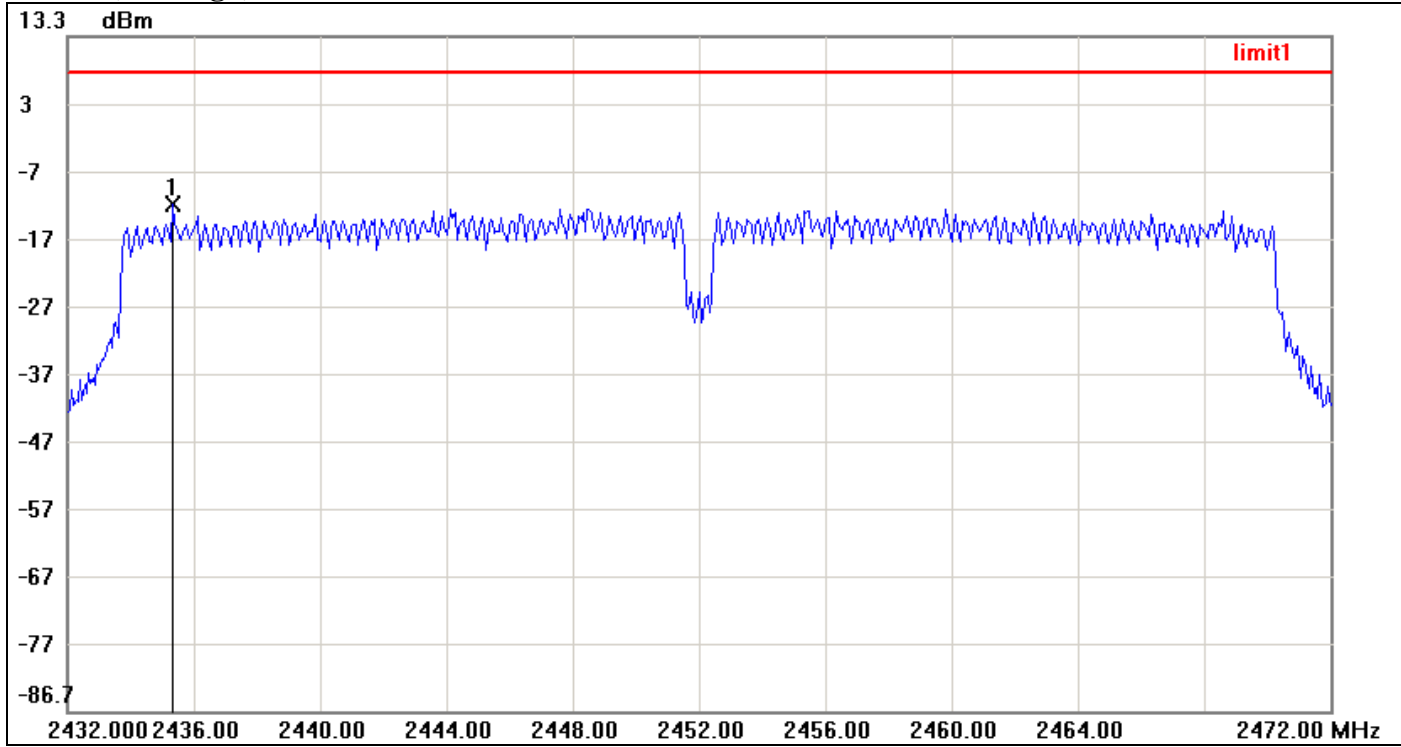

No.	Frequency(MHz)	Result(dBm)	Limit(dBm)	Margin(dBm)
1	2435.3333	-11.63	8.00	-19.63

7.6 SPURIOUS EMISSIONS

7.6.1 Conducted Measurement

LIMIT

According to §15.247(d), in any 100 kHz bandwidth outside the frequency bands in which the spread spectrum intentional radiator is operating, the radio frequency power that is produced by the intentional radiator shall be at least 20 dB below that in the 100 kHz bandwidth within the band that contains the highest level of the desired power, based on either an RF conducted or a radiated measurement, provided the transmitter demonstrates compliance with the peak conducted power limits. In addition, radiated emissions which fall in the restricted bands, as defined in §15.205(a), must also comply with the radiated emission limits specified in 15.209(a) (see Section 15.205(c)).

Test Configuration

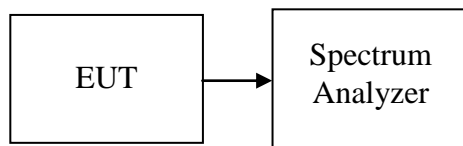

TEST PROCEDURE

Conducted RF measurements of the transmitter output were made to confirm that the EUT antenna port conducted emissions meet the specified limit and to identify any spurious signals that require further investigation or measurements on the radiated emissions site.

The transmitter output is connected to the spectrum analyzer. The resolution bandwidth is set to 100 kHz. The video bandwidth is set to 100 kHz.

Measurements are made over the 30MHz to 25GHz range with the transmitter set to the lowest, middle, and highest channels.

TEST RESULTS

No non-compliance noted.

Test Plot

IEEE 802.11b mode

CH Low

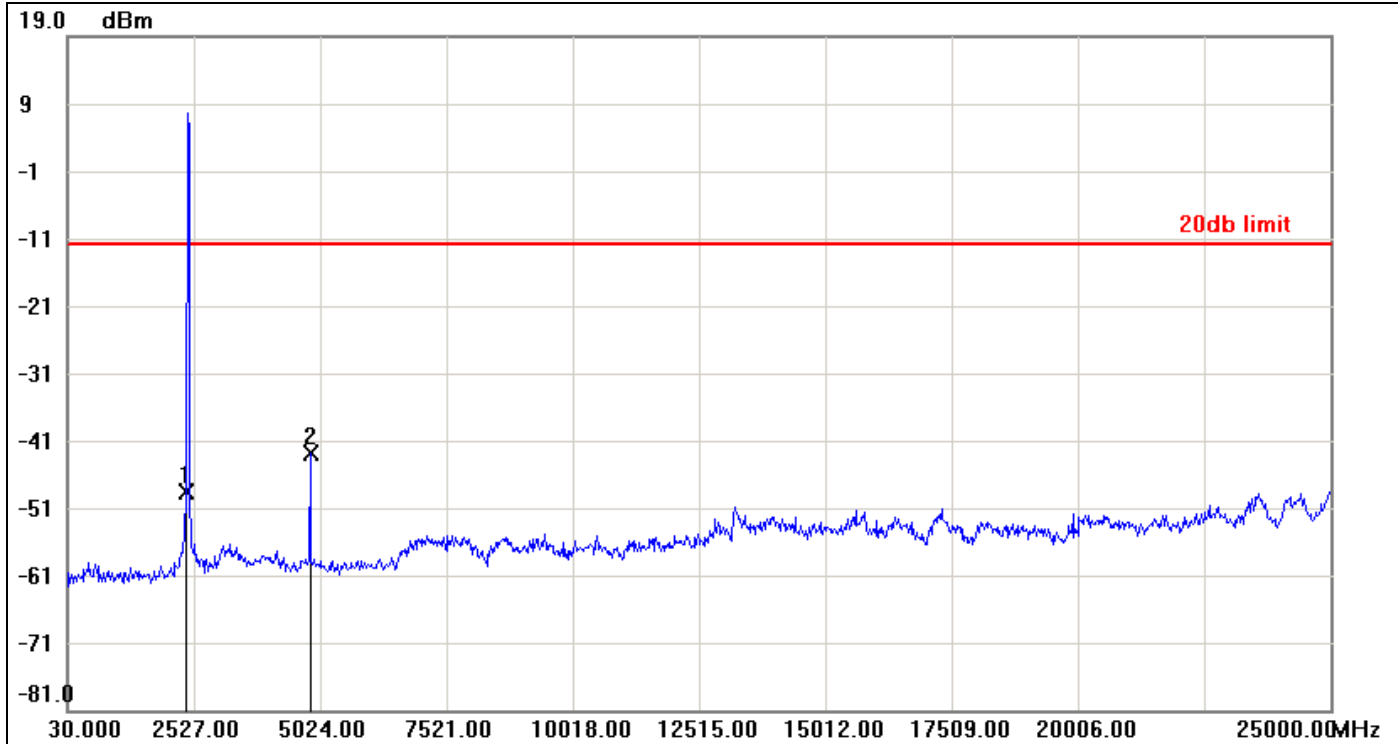

No.	Frequency(MHz)	Result(dBm)	Limit(dBm)	Margin(dBm)
1	2377.1800	-48.74	-11.84	-36.90
2	4824.2400	-42.89	-11.84	-31.05

CH Mid

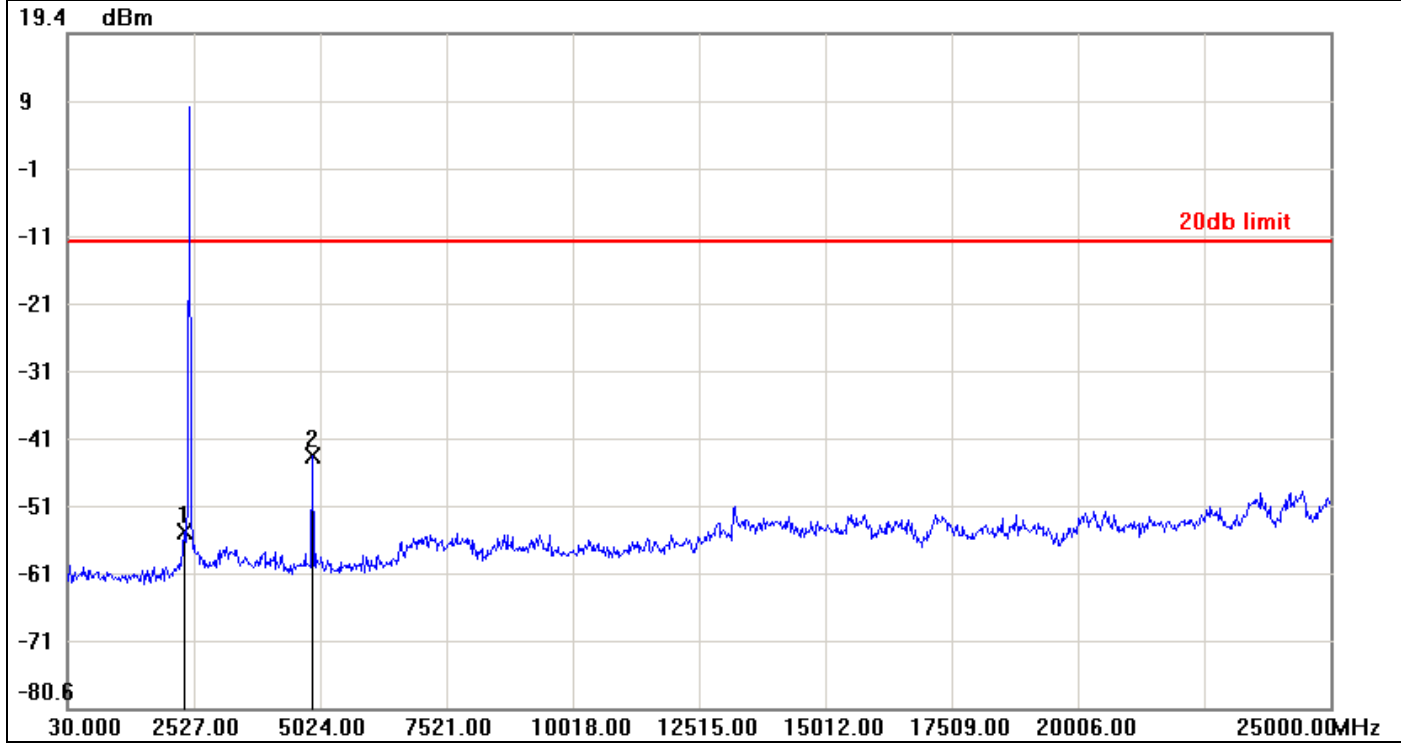

No.	Frequency(MHz)	Result(dBm)	Limit(dBm)	Margin(dBm)
1	2327.2400	-54.54	-11.46	-43.08
2	4874.1800	-43.19	-11.46	-31.73

CH High

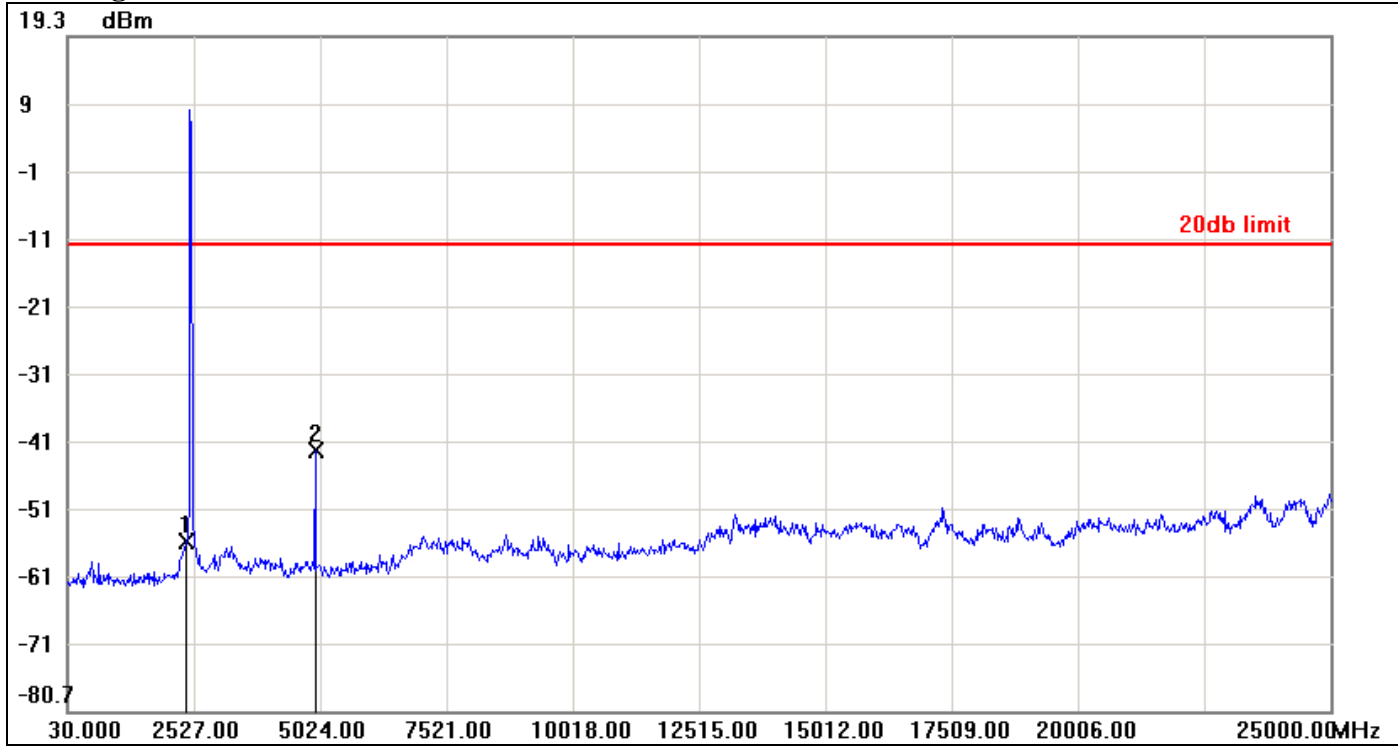

No.	Frequency(MHz)	Result(dBm)	Limit(dBm)	Margin(dBm)
1	2377.1800	-55.59	-11.46	-44.13
2	4924.1200	-41.98	-11.46	-30.52

IEEE 802.11g mode

CH Low

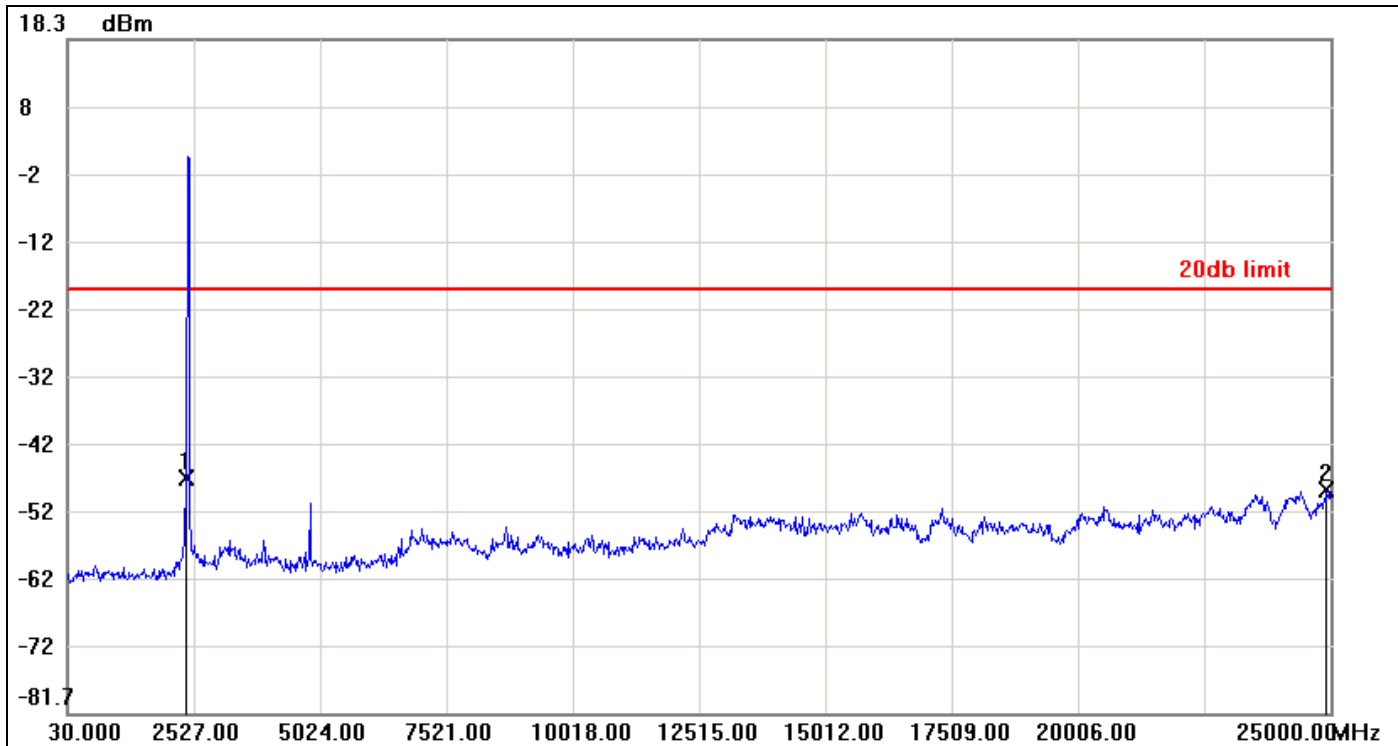

No.	Frequency(MHz)	Result(dBm)	Limit(dBm)	Margin(dBm)
1	2377.1800	-46.74	-18.72	-28.02
2	24925.0900	-48.67	-18.72	-29.95

CH Mid



No.	Frequency(MHz)	Result(dBm)	Limit(dBm)	Margin(dBm)
1	2377.1800	-55.74	-17.75	-37.99
2	24950.0600	-48.65	-17.75	-30.90

CH High



No.	Frequency(MHz)	Result(dBm)	Limit(dBm)	Margin(dBm)
1	2377.1800	-55.87	-17.63	-38.24
2	24425.6900	-48.41	-17.63	-30.78

IEEE 802.11n HT 20 MHz mode / Chain 0

CH Low

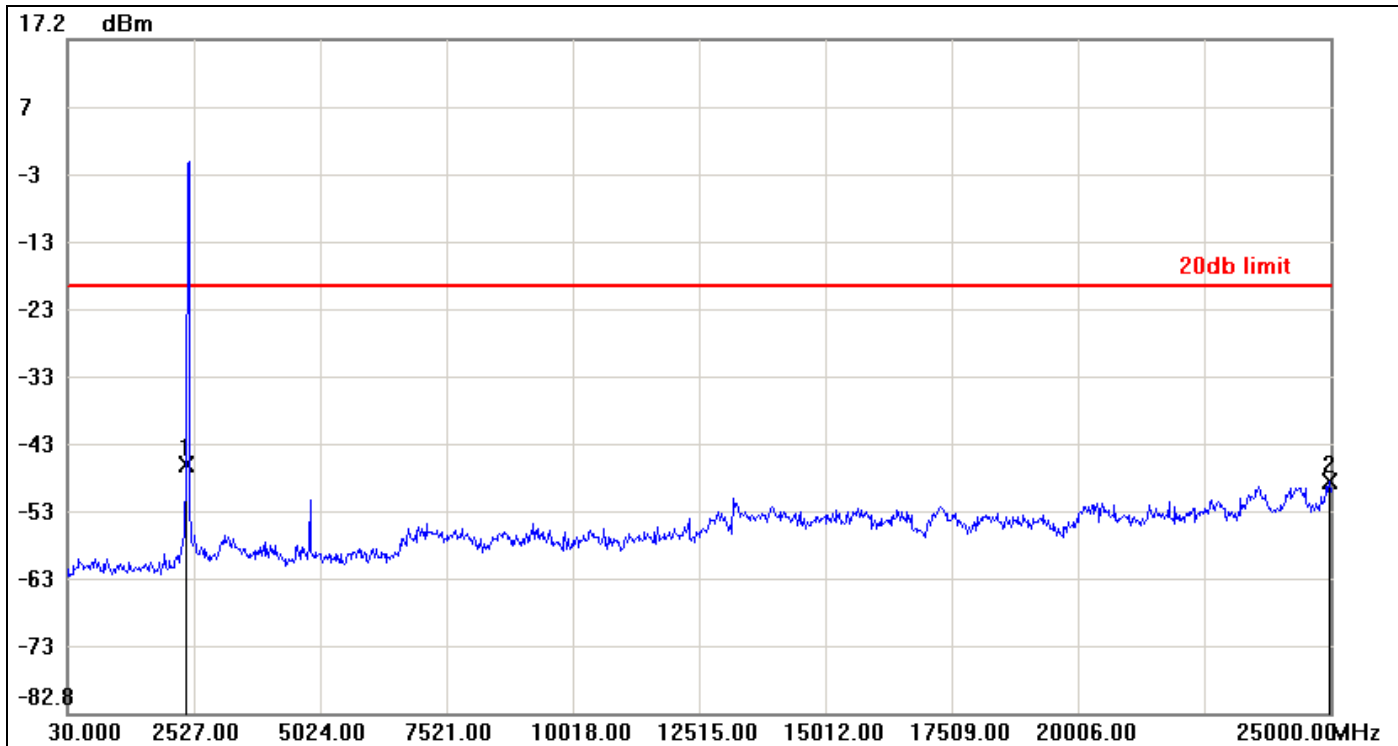

No.	Frequency(MHz)	Result(dBm)	Limit(dBm)	Margin(dBm)
1	2377.1800	-45.77	-19.46	-26.31
2	24975.0300	-48.46	-19.46	-29.00

CH Mid

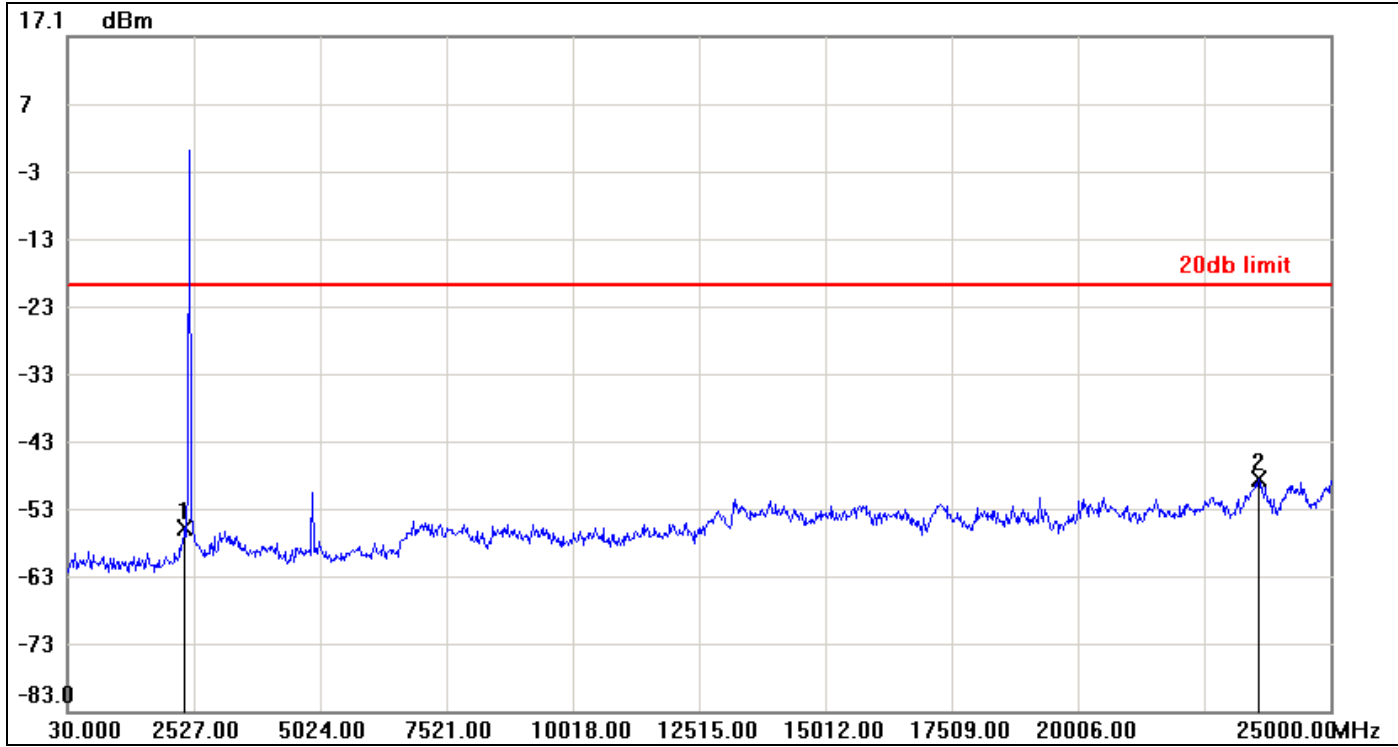

No.	Frequency(MHz)	Result(dBm)	Limit(dBm)	Margin(dBm)
1	2352.2100	-55.78	-19.75	-36.03
2	23576.7100	-48.56	-19.75	-28.81

CH High

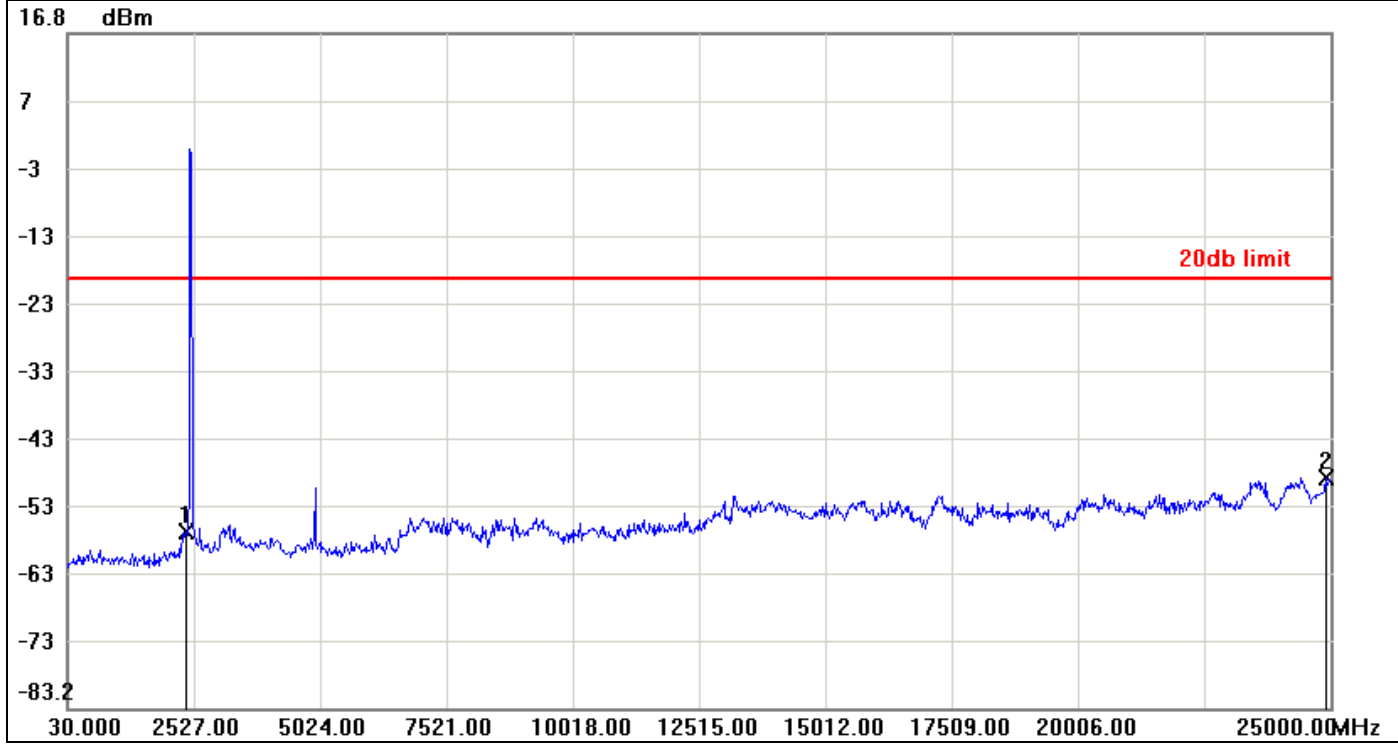

No.	Frequency(MHz)	Result(dBm)	Limit(dBm)	Margin(dBm)
1	2377.1800	-56.98	-19.51	-37.47
2	24900.1200	-49.05	-19.51	-29.54

IEEE 802.11n HT 20 MHz mode / Chain 1

CH Low

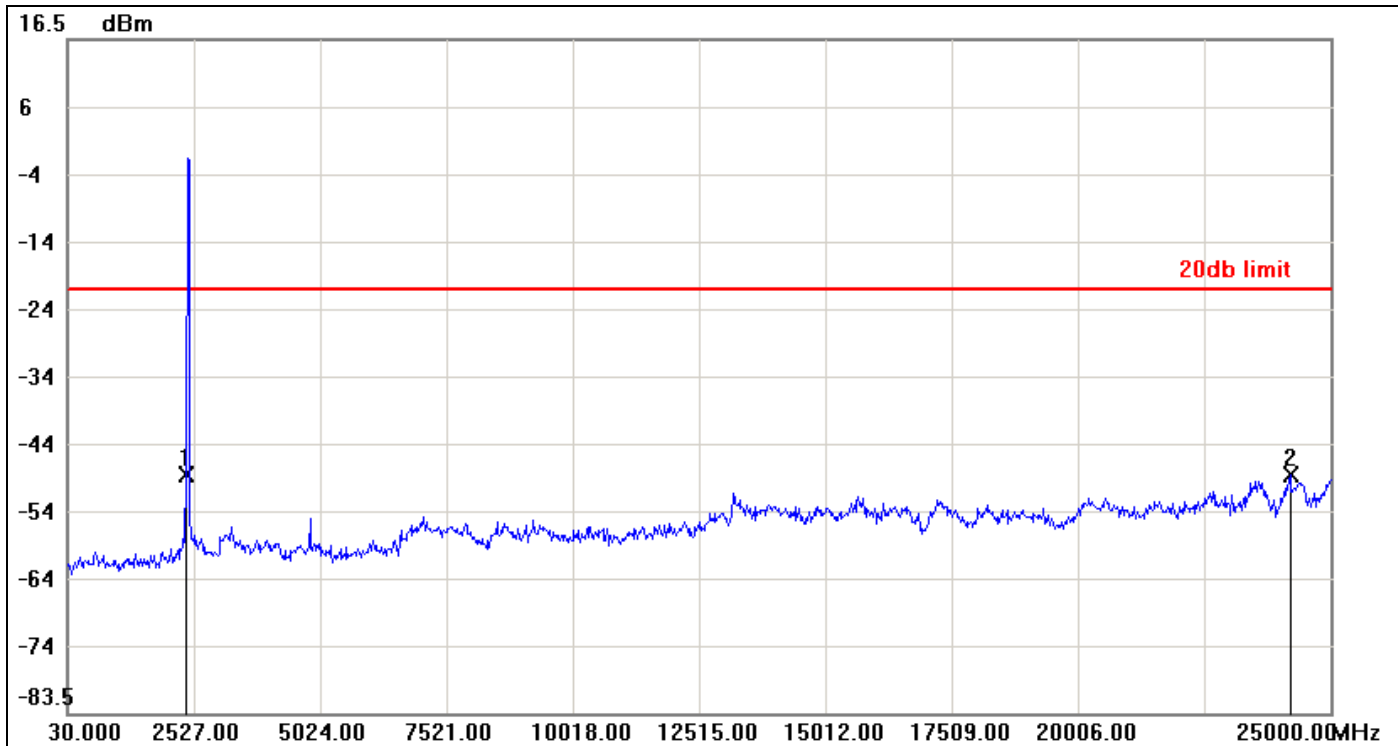

No.	Frequency(MHz)	Result(dBm)	Limit(dBm)	Margin(dBm)
1	2377.1800	-48.22	-20.64	-27.58
2	24200.9600	-48.18	-20.64	-27.54

CH Mid

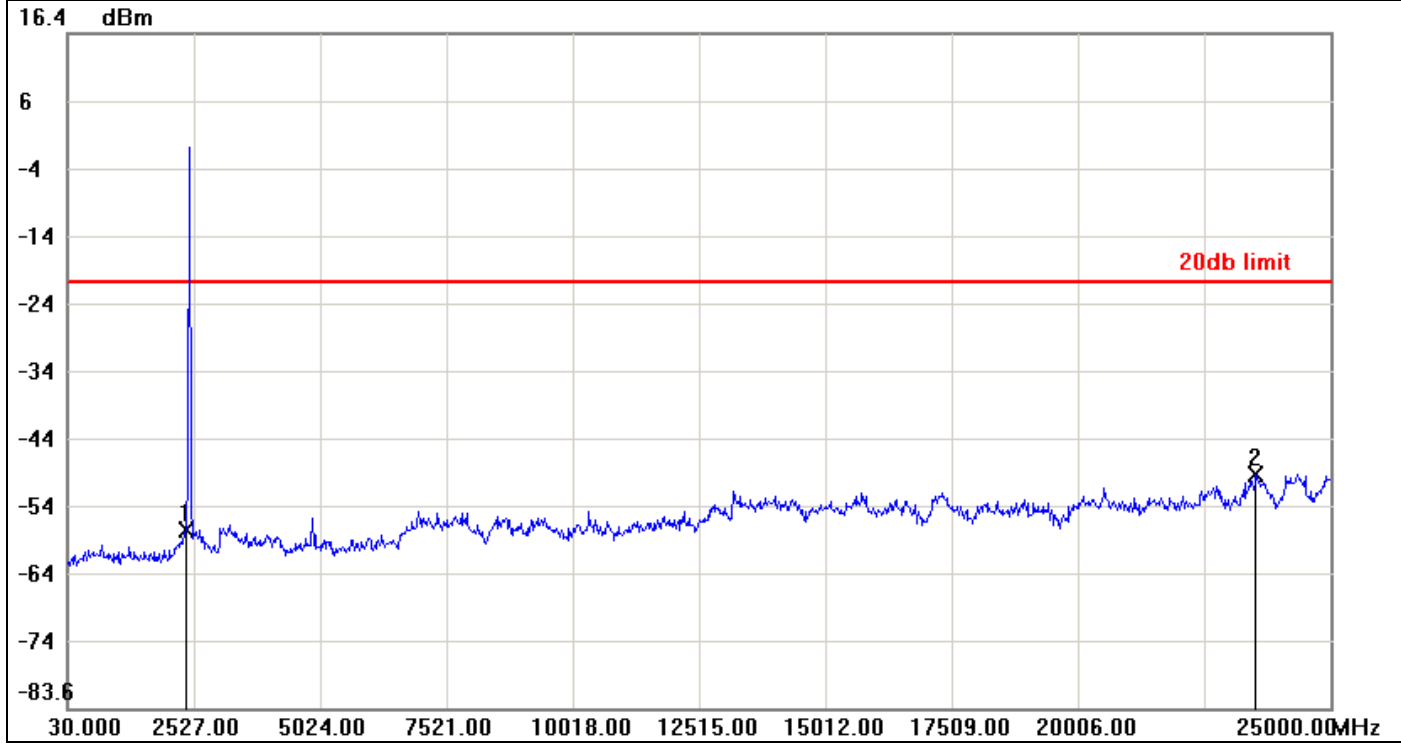

No.	Frequency(MHz)	Result(dBm)	Limit(dBm)	Margin(dBm)
1	2377.1800	-57.29	-20.36	-36.93
2	23526.7700	-48.95	-20.36	-28.59

CH High

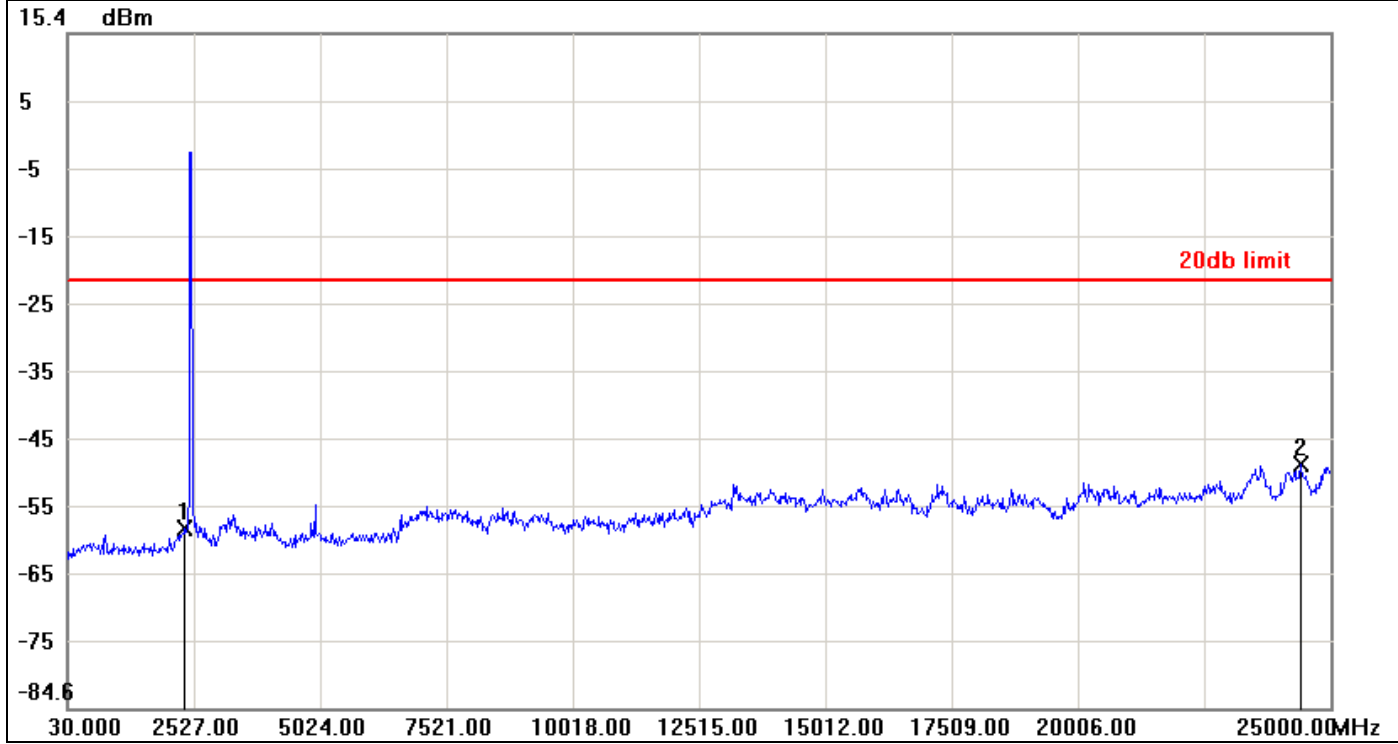

No.	Frequency(MHz)	Result(dBm)	Limit(dBm)	Margin(dBm)
1	2352.2100	-58.09	-21.22	-36.87
2	24400.7200	-48.36	-21.22	-27.14

IEEE 802.11n HT 40 MHz mode / Chain 0

CH Low

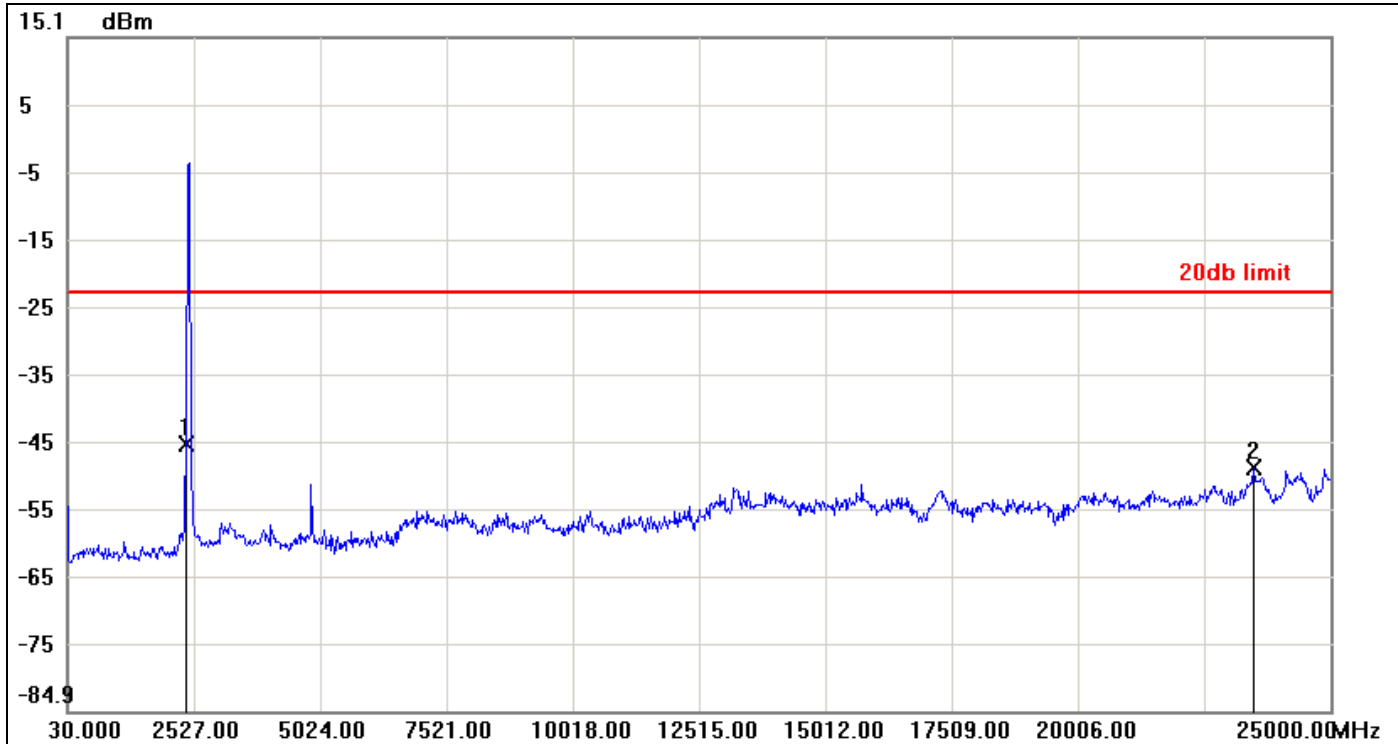

No.	Frequency(MHz)	Result(dBm)	Limit(dBm)	Margin(dBm)
1	2377.1800	-45.25	-22.80	-22.45
2	23476.8300	-48.61	-22.80	-25.81

CH Mid

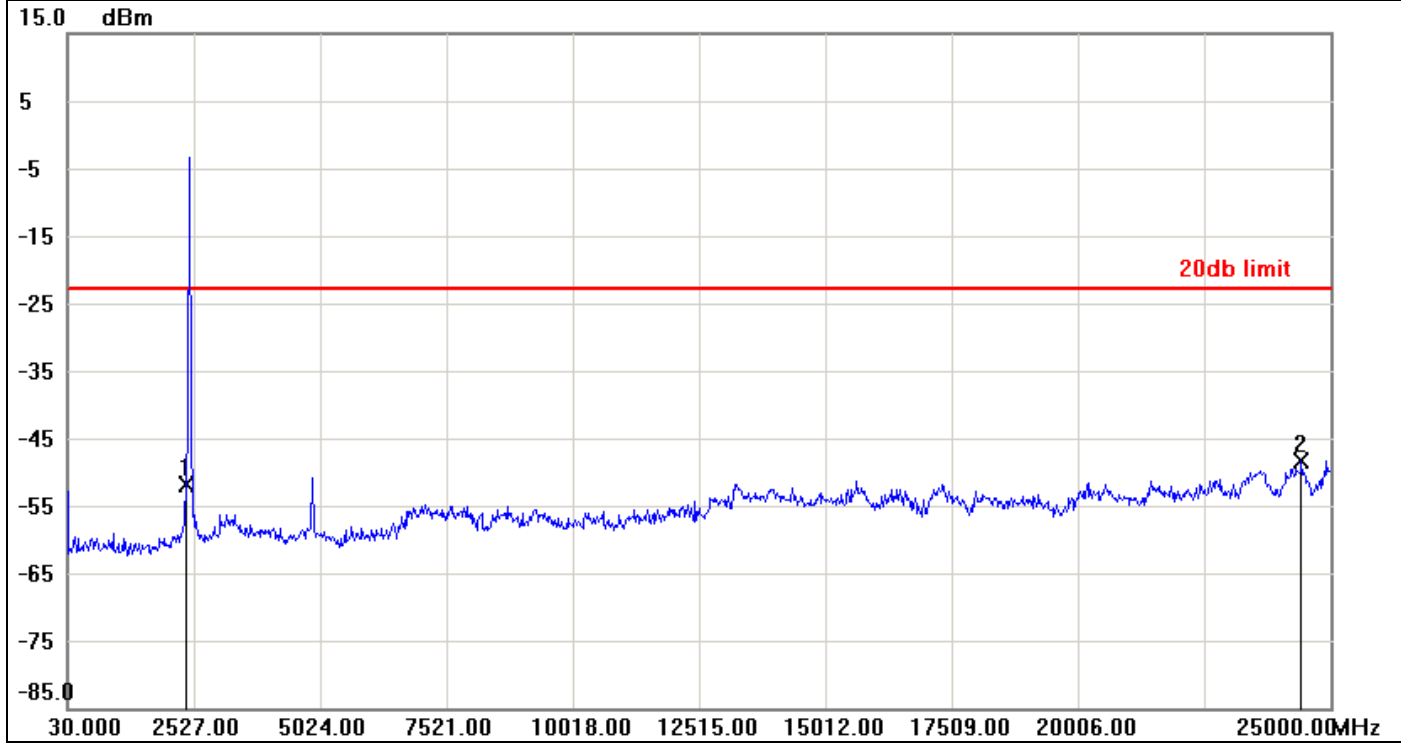

No.	Frequency(MHz)	Result(dBm)	Limit(dBm)	Margin(dBm)
1	2377.1800	-51.98	-22.83	-29.15
2	24425.6900	-48.26	-22.83	-25.43

CH High

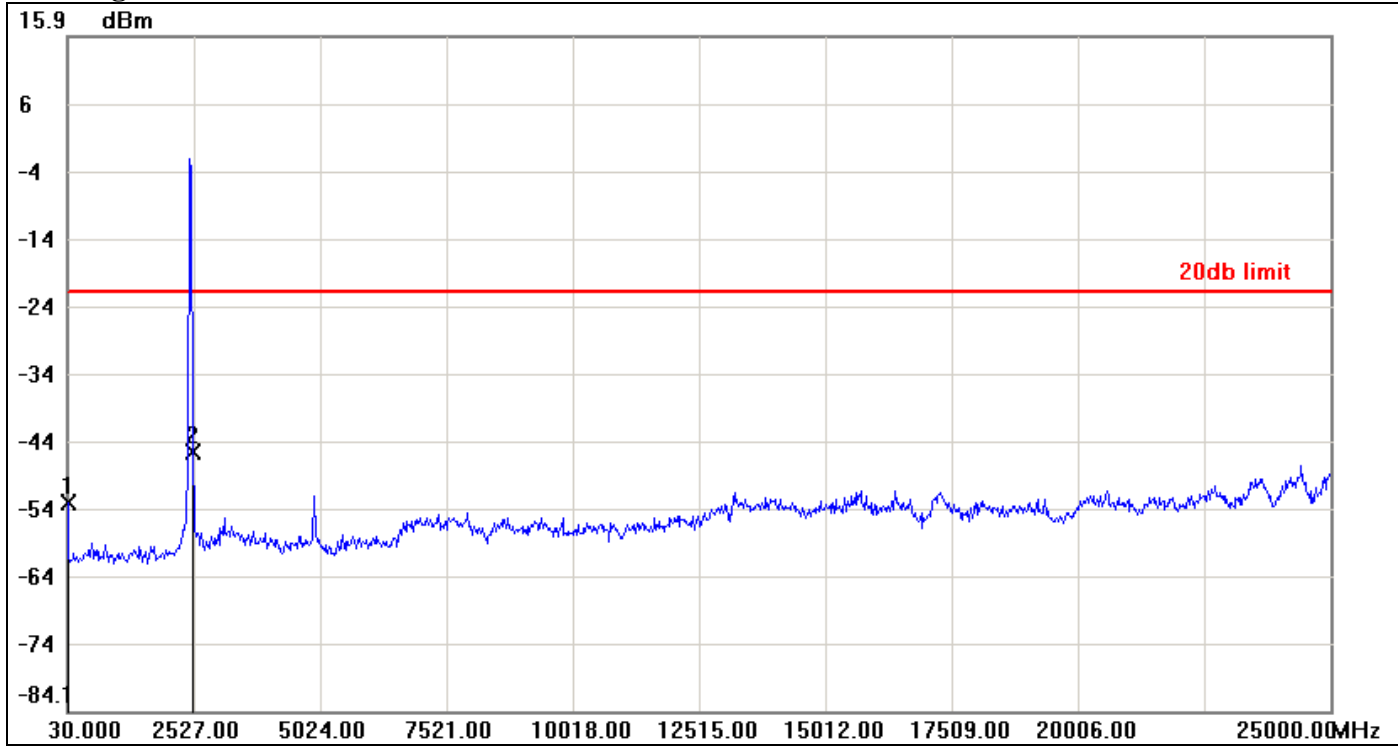

No.	Frequency(MHz)	Result(dBm)	Limit(dBm)	Margin(dBm)
1	30.0000	-53.31	-21.95	-31.36
2	2502.0300	-45.82	-21.95	-23.87

IEEE 802.11n HT 40 MHz mode / Chain 1

CH Low

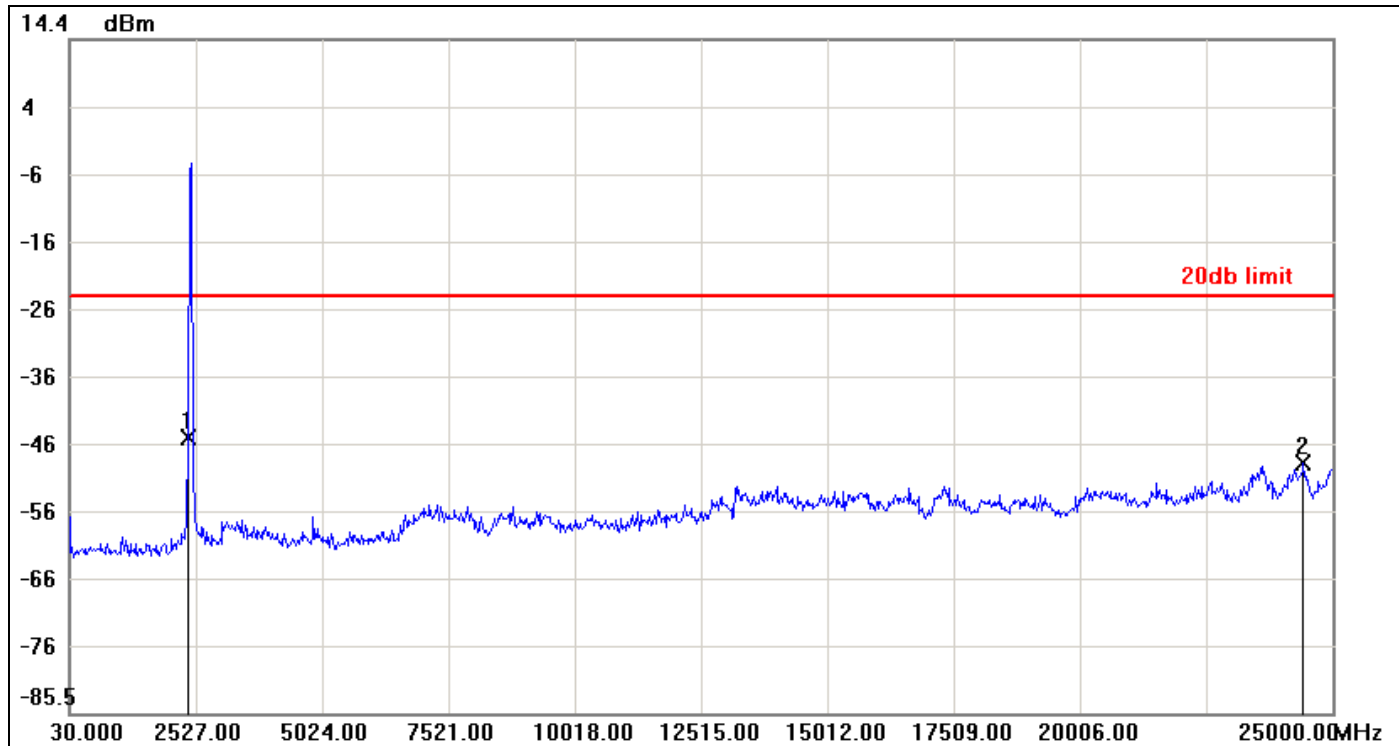

No.	Frequency(MHz)	Result(dBm)	Limit(dBm)	Margin(dBm)
1	2377.1800	-44.57	-23.55	-21.02
2	24425.6900	-48.34	-23.55	-24.79

CH Mid

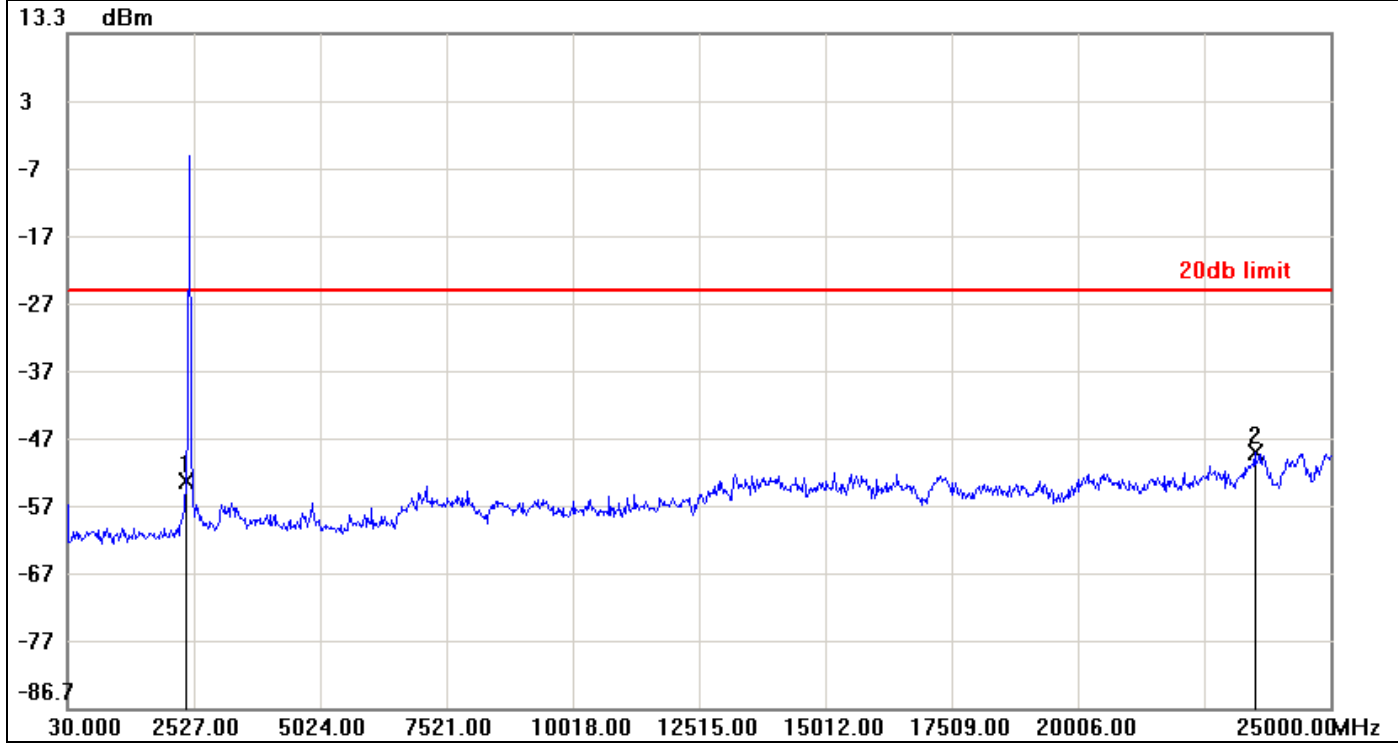

No.	Frequency(MHz)	Result(dBm)	Limit(dBm)	Margin(dBm)
1	2377.1800	-53.08	-24.70	-28.38
2	23501.8000	-48.70	-24.70	-24.00

CH High

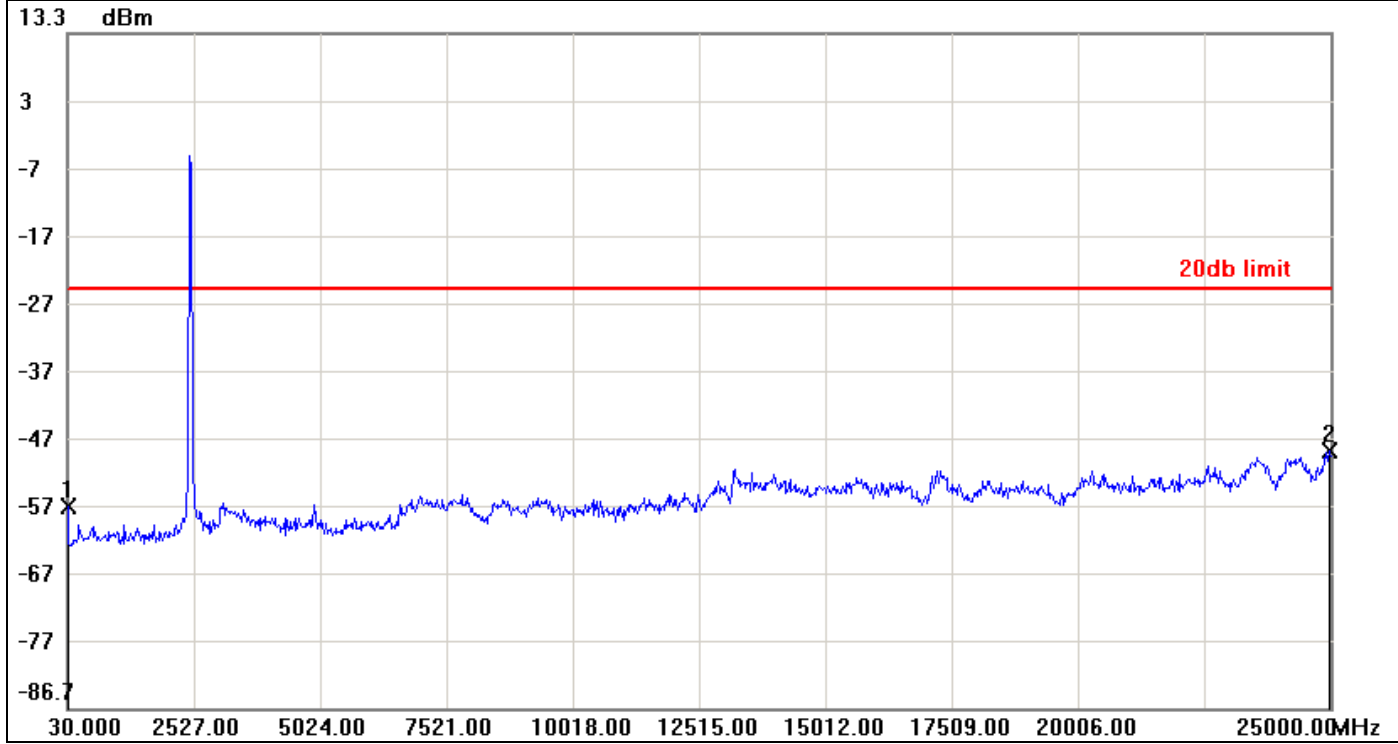

No.	Frequency(MHz)	Result(dBm)	Limit(dBm)	Margin(dBm)
1	30.0000	-56.76	-24.65	-32.11
2	24975.0300	-48.61	-24.65	-23.96

7.7 RADIATED EMISSIONS

LIMIT

1. According to §15.209(a), except as provided elsewhere in this Subpart, the emissions from an intentional radiator shall not exceed the field strength levels specified in the following table:

Frequency (MHz)	Field Strength ($\mu\text{V}/\text{m}$)	Measurement Distance (m)
30-88	100*	3
88-216	150*	3
216-960	200*	3
Above 960	500	3

Remark: Except as provided in paragraph (g), fundamental emissions from intentional radiators operating under this Section shall not be located in the frequency bands 54-72 MHz, 76-88 MHz, 174-216 MHz or 470-806 MHz. However, operation within these frequency bands is permitted under other sections of this Part, e.g., Sections 15.231 and 15.241.

2. In the emission table above, the tighter limit applies at the band edges.

Frequency (MHz)	Field Strength ($\mu\text{V}/\text{m}$ at 3-meter)	Field Strength (dB $\mu\text{V}/\text{m}$ at 3-meter)
30-88	100	40
88-216	150	43.5
216-960	200	46
Above 960	500	54

Test Configuration

9kHz ~ 30MHz

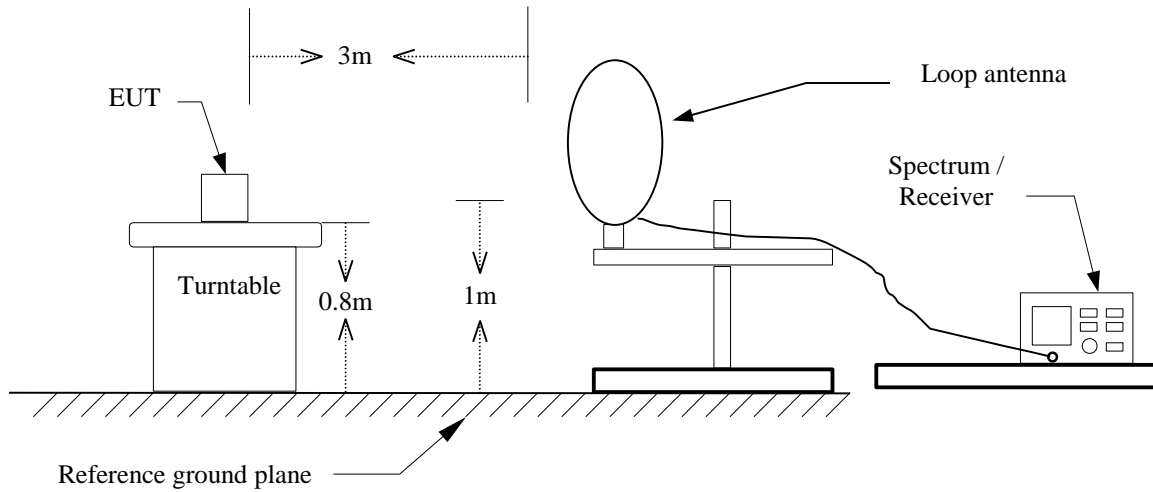

30MHz ~ 1GHz

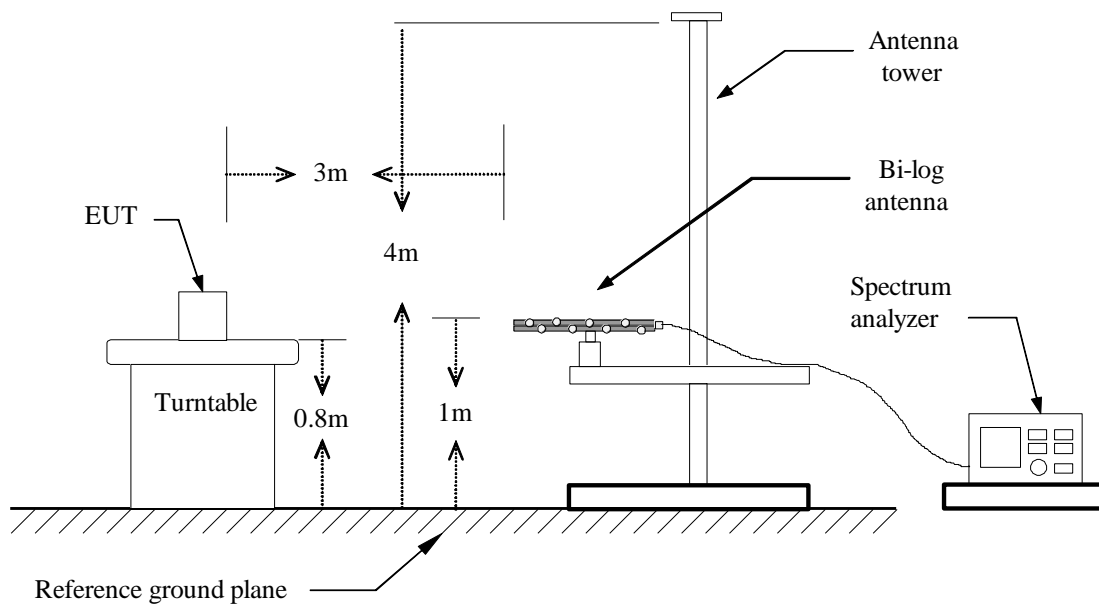

Above 1 GHz

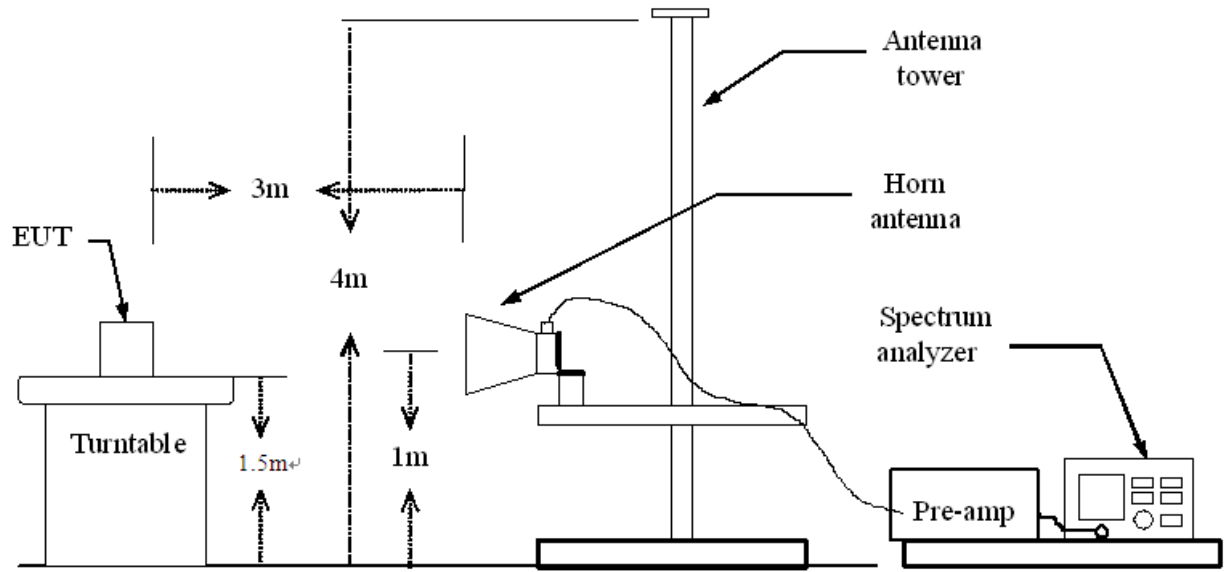

TEST PROCEDURE

1. The EUT is placed on a turntable, which is 1.5m above ground plane.
2. The turntable shall be rotated for 360 degrees to determine the position of maximum emission level.
3. EUT is set 3m away from the receiving antenna, which is varied from 1m to 4m to find out the highest emissions.
4. Maximum procedure was performed on the six highest emissions to ensure EUT compliance.
5. And also, each emission was to be maximized by changing the polarization of receiving antenna both horizontal and vertical.
6. Set the spectrum analyzer in the following setting as:

Below 1GHz:

RBW=100kHz / VBW=300kHz / Sweep=AUTO

Above 1GHz:

(a) PEAK: RBW=VBW=10MHz / Sweep=AUTO

(b) AVERAGE: RBW=10Hz,
if duty cycle \geq 98%, VBW=1Hz.
if duty cycle < 98% VBW=1/T.

IEEE 802.11b mode: \geq 98%, VBW=10Hz

IEEE 802.11g mode: \geq 98%, VBW=10Hz

IEEE 802.11n HT 20 MHz mode: \geq 98%, VBW=10Hz

IEEE 802.11n HT 40 MHz mode: \geq 98%, VBW=10Hz

7. Repeat above procedures until the measurements for all frequencies are complete.

TEST RESULTS

No non-compliance noted.

Below 1GHz

Operation Mode: Normal Link

Test Date: May 28, 2015

Temperature: 27°C

Tested by: David Shu

Humidity: 53% RH

Polarity: Ver. / Hor.

Frequency (MHz)	Reading (dBuV)	Correction Factor (dB/m)	Result (dBuV/m)	Limit (dBuV/m)	Margin (dB)	Remark	Ant. Pol. (H/V)
250.1900	50.68	-16.27	34.41	46.00	-11.59	Peak	V
450.0100	47.20	-10.19	37.01	46.00	-8.99	Peak	V
570.2900	46.14	-8.19	37.95	46.00	-8.05	Peak	V
798.2400	41.61	-4.51	37.10	46.00	-8.90	Peak	V
888.4500	34.45	-3.33	31.12	46.00	-14.88	Peak	V
960.2300	37.71	-2.23	35.48	54.00	-18.52	Peak	V
206.5400	47.87	-16.01	31.86	43.50	-11.64	peak	H
275.4100	52.03	-14.70	37.33	46.00	-8.67	peak	H
431.5800	42.14	-10.75	31.39	46.00	-14.61	peak	H
570.2900	45.70	-8.19	37.51	46.00	-8.49	peak	H
792.4200	41.36	-4.56	36.80	46.00	-9.20	peak	H
849.6500	39.66	-3.79	35.87	46.00	-10.13	peak	H

Remark:

1. *Measuring frequencies from 30 MHz to the 1GHz.*
2. *Radiated emissions measured in frequency range from 30 MHz to 1000MHz were made with an instrument using peak/quasi-peak detector mode.*
3. *Quasi-peak test would be performed if the peak result were greater than the quasi-peak limit or as required by the applicant.*
4. *Measurements above show only up to 6 maximum emissions noted, or would be lesser, with " N/A " remark, if no specific emissions from the EUT are recorded (ie: margin>20dB from the applicable limit) and considered that's already beyond the background noise floor.*
5. *Margin (dB) = Result (dBuV/m) – Limit (dBuV/m).*

Above 1 GHz

Operation Mode: TX / IEEE 802.11b / CH Low

Test Date: May 28, 2015

Temperature: 27°C

Tested by: David Shu

Humidity: 53 % RH

Polarity: Ver. / Hor.

Frequency (MHz)	Reading (dBuV)	Correction Factor (dB/m)	Result (dBuV/m)	Limit (dBuV/m)	Margin (dB)	Remark	Ant. Pol. (H/V)
1966.000	49.89	-5.06	44.83	74.00	-29.17	peak	V
4105.000	45.08	1.63	46.71	74.00	-27.29	peak	V
N/A							
1920.000	51.95	-5.30	46.65	74.00	-27.35	peak	H
3900.000	46.61	0.80	47.41	74.00	-26.59	peak	H
4105.000	45.67	1.63	47.30	74.00	-26.70	peak	H
N/A							

Remark:

1. Measuring frequencies from 1 GHz to the 10th harmonic of highest fundamental frequency.
2. Radiated emissions measured in frequency above 1000MHz were made with an instrument using peak/average detector mode.
3. Average test would be performed if the peak result were greater than the average limit or as required by the applicant.
4. Data of measurement within this frequency range shown “ --- ” in the table above means the reading of emissions are attenuated more than 20dB below the permissible limits or the field strength is too small to be measured.
5. Measurements above show only up to 6 maximum emissions noted, or would be lesser, with “ N/A ” remark, if no specific emissions from the EUT are recorded (ie: margin>20dB from the applicable limit) and considered that's already beyond the background noise floor.
6. Margin (dB) = Remark result (dBuV/m) – Average limit (dBuV/m).

Operation Mode: TX / IEEE 802.11b / CH Mid

Test Date: May 28, 2015

Temperature: 27°C

Tested by: David Shu

Humidity: 53 % RH

Polarity: Ver. / Hor.

Frequency (MHz)	Reading (dBuV)	Correction Factor (dB/m)	Result (dBuV/m)	Limit (dBuV/m)	Margin (dB)	Remark	Ant. Pol. (H/V)
2150.000	51.20	-4.71	46.49	74.00	-27.51	peak	V
4985.000	46.73	3.95	50.68	74.00	-23.32	peak	V
N/A							
1920.000	53.26	-5.30	47.96	74.00	-26.04	peak	H
4105.000	46.42	1.63	48.05	74.00	-25.95	peak	H
N/A							

Remark:

1. Measuring frequencies from 1 GHz to the 10th harmonic of highest fundamental frequency.
2. Radiated emissions measured in frequency above 1000MHz were made with an instrument using peak/average detector mode.
3. Average test would be performed if the peak result were greater than the average limit or as required by the applicant.
4. Data of measurement within this frequency range shown “ --- ” in the table above means the reading of emissions are attenuated more than 20dB below the permissible limits or the field strength is too small to be measured.
5. Measurements above show only up to 6 maximum emissions noted, or would be lesser, with “ N/A ” remark, if no specific emissions from the EUT are recorded (ie: margin>20dB from the applicable limit) and considered that's already beyond the background noise floor.
6. Margin (dB) = Remark result (dBuV/m) – Average limit (dBuV/m).

Operation Mode: TX / IEEE 802.11b / CH High

Test Date: May 28, 2015

Temperature: 27°C

Tested by: David Shu

Humidity: 53 % RH

Polarity: Ver. / Hor.

Frequency (MHz)	Reading (dBuV)	Correction Factor (dB/m)	Result (dBuV/m)	Limit (dBuV/m)	Margin (dB)	Remark	Ant. Pol. (H/V)
1824.000	52.53	-5.81	46.72	74.00	-27.28	peak	V
4500.000	45.04	3.12	48.16	74.00	-25.84	peak	V
N/A							
1554.000	55.55	-7.24	48.31	74.00	-25.69	peak	H
4105.000	48.29	1.63	49.92	74.00	-24.08	peak	H
N/A							

Remark:

1. Measuring frequencies from 1 GHz to the 10th harmonic of highest fundamental frequency.
2. Radiated emissions measured in frequency above 1000MHz were made with an instrument using peak/average detector mode.
3. Average test would be performed if the peak result were greater than the average limit or as required by the applicant.
4. Data of measurement within this frequency range shown “ --- ” in the table above means the reading of emissions are attenuated more than 20dB below the permissible limits or the field strength is too small to be measured.
5. Measurements above show only up to 6 maximum emissions noted, or would be lesser, with “ N/A ” remark, if no specific emissions from the EUT are recorded (ie: margin>20dB from the applicable limit) and considered that's already beyond the background noise floor.
6. Margin (dB) = Remark result (dBuV/m) – Average limit (dBuV/m).

Operation Mode: TX / IEEE 802.11g / CH Low

Test Date: May 28, 2015

Temperature: 27°C

Tested by: David Shu

Humidity: 53 % RH

Polarity: Ver. / Hor.

Frequency (MHz)	Reading (dBuV)	Correction Factor (dB/m)	Result (dBuV/m)	Limit (dBuV/m)	Margin (dB)	Remark	Ant. Pol. (H/V)
1554.000	53.09	-7.24	45.85	74.00	-28.15	peak	V
3900.000	45.89	0.80	46.69	74.00	-27.31	peak	V
N/A							
1554.000	53.96	-7.24	46.72	74.00	-27.28	peak	H
4105.000	42.85	1.63	44.48	74.00	-29.52	peak	H
N/A							

Remark:

1. Measuring frequencies from 1 GHz to the 10th harmonic of highest fundamental frequency.
2. Radiated emissions measured in frequency above 1000MHz were made with an instrument using peak/average detector mode.
3. Average test would be performed if the peak result were greater than the average limit or as required by the applicant.
4. Data of measurement within this frequency range shown “ --- ” in the table above means the reading of emissions are attenuated more than 20dB below the permissible limits or the field strength is too small to be measured.
5. Measurements above show only up to 6 maximum emissions noted, or would be lesser, with “ N/A ” remark, if no specific emissions from the EUT are recorded (ie: margin>20dB from the applicable limit) and considered that's already beyond the background noise floor.
6. Margin (dB) = Remark result (dBuV/m) – Average limit (dBuV/m).

Operation Mode: TX / IEEE 802.11g / CH Mid

Test Date: May 28, 2015

Temperature: 27°C

Tested by: David Shu

Humidity: 53 % RH

Polarity: Ver. / Hor.

Frequency (MHz)	Reading (dBuV)	Correction Factor (dB/m)	Result (dBuV/m)	Limit (dBuV/m)	Margin (dB)	Remark	Ant. Pol. (H/V)
1554.000	51.74	-7.24	44.50	74.00	-29.50	peak	V
4500.000	43.90	3.12	47.02	74.00	-26.98	peak	V
N/A							
1554.000	55.03	-7.24	47.79	74.00	-26.21	peak	H
3900.000	47.12	0.80	47.92	74.00	-26.08	peak	H
N/A							

Remark:

1. Measuring frequencies from 1 GHz to the 10th harmonic of highest fundamental frequency.
2. Radiated emissions measured in frequency above 1000MHz were made with an instrument using peak/average detector mode.
3. Average test would be performed if the peak result were greater than the average limit or as required by the applicant.
4. Data of measurement within this frequency range shown “ --- ” in the table above means the reading of emissions are attenuated more than 20dB below the permissible limits or the field strength is too small to be measured.
5. Measurements above show only up to 6 maximum emissions noted, or would be lesser, with “ N/A ” remark, if no specific emissions from the EUT are recorded (ie: margin>20dB from the applicable limit) and considered that's already beyond the background noise floor.
6. Margin (dB) = Remark result (dBuV/m) – Average limit (dBuV/m).

Operation Mode: TX / IEEE 802.11g / CH High

Test Date: May 28, 2015

Temperature: 27°C

Tested by: David Shu

Humidity: 53 % RH

Polarity: Ver. / Hor.

Frequency (MHz)	Reading (dBuV)	Correction Factor (dB/m)	Result (dBuV/m)	Limit (dBuV/m)	Margin (dB)	Remark	Ant. Pol. (H/V)
1172.000	55.79	-8.97	46.82	74.00	-27.18	peak	V
4105.000	43.86	1.63	45.49	74.00	-28.51	peak	V
N/A							
1800.000	53.32	-5.94	47.38	74.00	-26.62	peak	H
4105.000	46.23	1.63	47.86	74.00	-26.14	peak	H
N/A							

Remark:

1. Measuring frequencies from 1 GHz to the 10th harmonic of highest fundamental frequency.
2. Radiated emissions measured in frequency above 1000MHz were made with an instrument using peak/average detector mode.
3. Average test would be performed if the peak result were greater than the average limit or as required by the applicant.
4. Data of measurement within this frequency range shown “ --- ” in the table above means the reading of emissions are attenuated more than 20dB below the permissible limits or the field strength is too small to be measured.
5. Measurements above show only up to 6 maximum emissions noted, or would be lesser, with “ N/A ” remark, if no specific emissions from the EUT are recorded (ie: margin>20dB from the applicable limit) and considered that's already beyond the background noise floor.
6. Margin (dB) = Remark result (dBuV/m) – Average limit (dBuV/m).

Operation Mode: TX / IEEE 802.11n HT 20 MHz mode / CH Low **Test Date:** May 28, 2015

Temperature: 27°C

Tested by: David Shu

Humidity: 53 % RH

Polarity: Ver. / Hor.

Frequency (MHz)	Reading (dBuV)	Correction Factor (dB/m)	Result (dBuV/m)	Limit (dBuV/m)	Margin (dB)	Remark	Ant. Pol. (H/V)
1574.000	54.62	-7.14	47.48	74.00	-26.52	peak	V
5215.000	41.55	4.54	46.09	74.00	-27.91	peak	V
N/A							
2094.000	52.27	-4.97	47.30	74.00	-26.70	peak	H
4105.000	45.45	1.63	47.08	74.00	-26.92	peak	H
N/A							

Remark:

1. Measuring frequencies from 1 GHz to the 10th harmonic of highest fundamental frequency.
2. Radiated emissions measured in frequency above 1000MHz were made with an instrument using peak/average detector mode.
3. Average test would be performed if the peak result were greater than the average limit or as required by the applicant.
4. Data of measurement within this frequency range shown “ --- ” in the table above means the reading of emissions are attenuated more than 20dB below the permissible limits or the field strength is too small to be measured.
5. Measurements above show only up to 6 maximum emissions noted, or would be lesser, with “ N/A ” remark, if no specific emissions from the EUT are recorded (ie: margin>20dB from the applicable limit) and considered that's already beyond the background noise floor.
6. Margin (dB) = Remark result (dBuV/m) – Average limit (dBuV/m).

Operation Mode: TX / IEEE 802.11n HT 20 MHz mode / CH Mid **Test Date:** May 28, 2015

Temperature: 27°C

Tested by: David Shu

Humidity: 53 % RH

Polarity: Ver. / Hor.

Frequency (MHz)	Reading (dBuV)	Correction Factor (dB/m)	Result (dBuV/m)	Limit (dBuV/m)	Margin (dB)	Remark	Ant. Pol. (H/V)
1580.000	54.10	-7.11	46.99	74.00	-27.01	peak	V
4200.000	45.67	1.99	47.66	74.00	-26.34	peak	V
N/A							
1766.000	53.49	-6.12	47.37	74.00	-26.63	peak	H
4105.000	47.48	1.63	49.11	74.00	-24.89	peak	H
N/A							

Remark:

1. Measuring frequencies from 1 GHz to the 10th harmonic of highest fundamental frequency.
2. Radiated emissions measured in frequency above 1000MHz were made with an instrument using peak/average detector mode.
3. Average test would be performed if the peak result were greater than the average limit or as required by the applicant.
4. Data of measurement within this frequency range shown “ --- ” in the table above means the reading of emissions are attenuated more than 20dB below the permissible limits or the field strength is too small to be measured.
5. Measurements above show only up to 6 maximum emissions noted, or would be lesser, with “ N/A ” remark, if no specific emissions from the EUT are recorded (ie: margin>20dB from the applicable limit) and considered that's already beyond the background noise floor.
6. Margin (dB) = Remark result (dBuV/m) – Average limit (dBuV/m).

Operation Mode: TX / IEEE 802.11n HT 20 MHz mode / CH High **Test Date:** May 28, 2015

Temperature: 27°C

Tested by: David Shu

Humidity: 53 % RH

Polarity: Ver. / Hor.

Frequency (MHz)	Reading (dBuV)	Correction Factor (dB/m)	Result (dBuV/m)	Limit (dBuV/m)	Margin (dB)	Remark	Ant. Pol. (H/V)
1562.000	54.50	-7.20	47.30	74.00	-26.70	peak	V
3900.000	47.51	0.80	48.31	74.00	-25.69	peak	V
N/A							
2094.000	52.98	-4.97	48.01	74.00	-25.99	peak	H
4105.000	45.95	1.63	47.58	74.00	-26.42	peak	H
N/A							

Remark:

1. *Measuring frequencies from 1 GHz to the 10th harmonic of highest fundamental frequency.*
2. *Radiated emissions measured in frequency above 1000MHz were made with an instrument using peak/average detector mode.*
3. *Average test would be performed if the peak result were greater than the average limit or as required by the applicant.*
4. *Data of measurement within this frequency range shown “ --- ” in the table above means the reading of emissions are attenuated more than 20dB below the permissible limits or the field strength is too small to be measured.*
5. *Measurements above show only up to 6 maximum emissions noted, or would be lesser, with “ N/A ” remark, if no specific emissions from the EUT are recorded (ie: margin>20dB from the applicable limit) and considered that's already beyond the background noise floor.*
6. *Margin (dB) = Remark result (dBuV/m) – Average limit (dBuV/m).*

Operation Mode: TX / IEEE 802.11n HT 40 MHz mode / CH Low **Test Date:** May 28, 2015

Temperature: 27°C

Tested by: David Shu

Humidity: 53 % RH

Polarity: Ver. / Hor.

Frequency (MHz)	Reading (dBuV)	Correction Factor (dB/m)	Result (dBuV/m)	Limit (dBuV/m)	Margin (dB)	Remark	Ant. Pol. (H/V)
1938.000	55.78	-5.21	50.57	74.00	-23.43	peak	V
4105.000	44.48	1.63	46.11	74.00	-27.89	peak	V
N/A							
1554.000	53.58	-7.24	46.34	74.00	-27.66	peak	H
4105.000	47.55	1.63	49.18	74.00	-24.82	peak	H
N/A							

Remark:

1. Measuring frequencies from 1 GHz to the 10th harmonic of highest fundamental frequency.
2. Radiated emissions measured in frequency above 1000MHz were made with an instrument using peak/average detector mode.
3. Average test would be performed if the peak result were greater than the average limit or as required by the applicant.
4. Data of measurement within this frequency range shown “ --- ” in the table above means the reading of emissions are attenuated more than 20dB below the permissible limits or the field strength is too small to be measured.
5. Measurements above show only up to 6 maximum emissions noted, or would be lesser, with “ N/A ” remark, if no specific emissions from the EUT are recorded (ie: margin>20dB from the applicable limit) and considered that's already beyond the background noise floor.
6. Margin (dB) = Remark result (dBuV/m) – Average limit (dBuV/m).

Operation Mode: TX / IEEE 802.11n HT 40 MHz mode / CH Mid **Test Date:** May 28, 2015

Temperature: 27°C **Tested by:** David Shu

Humidity: 53 % RH **Polarity:** Ver. / Hor.

Frequency (MHz)	Reading (dBuV)	Correction Factor (dB/m)	Result (dBuV/m)	Limit (dBuV/m)	Margin (dB)	Remark	Ant. Pol. (H/V)
1938.000	54.63	-5.21	49.42	74.00	-24.58	peak	V
4105.000	44.19	1.63	45.82	74.00	-28.18	peak	V
N/A							
1554.000	54.26	-7.24	47.02	74.00	-26.98	peak	H
4105.000	47.61	1.63	49.24	74.00	-24.76	peak	H
N/A							

Remark:

1. Measuring frequencies from 1 GHz to the 10th harmonic of highest fundamental frequency.
2. Radiated emissions measured in frequency above 1000MHz were made with an instrument using peak/average detector mode.
3. Average test would be performed if the peak result were greater than the average limit or as required by the applicant.
4. Data of measurement within this frequency range shown “ --- ” in the table above means the reading of emissions are attenuated more than 20dB below the permissible limits or the field strength is too small to be measured.
5. Measurements above show only up to 6 maximum emissions noted, or would be lesser, with “ N/A ” remark, if no specific emissions from the EUT are recorded (ie: margin>20dB from the applicable limit) and considered that's already beyond the background noise floor.
6. Margin (dB) = Remark result (dBuV/m) – Average limit (dBuV/m).

Operation Mode: TX / IEEE 802.11n HT 40 MHz mode / CH High **Test Date:** May 28, 2015

Temperature: 27°C

Tested by: David Shu

Humidity: 53 % RH

Polarity: Ver. / Hor.

Frequency (MHz)	Reading (dBuV)	Correction Factor (dB/m)	Result (dBuV/m)	Limit (dBuV/m)	Margin (dB)	Remark	Ant. Pol. (H/V)
1942.000	53.25	-5.19	48.06	74.00	-25.94	peak	V
4105.000	45.13	1.63	46.76	74.00	-27.24	peak	V
N/A							
1554.000	53.89	-7.24	46.65	74.00	-27.35	peak	H
4105.000	47.71	1.63	49.34	74.00	-24.66	peak	H
N/A							

Remark:

1. Measuring frequencies from 1 GHz to the 10th harmonic of highest fundamental frequency.
2. Radiated emissions measured in frequency above 1000MHz were made with an instrument using peak/average detector mode.
3. Average test would be performed if the peak result were greater than the average limit or as required by the applicant.
4. Data of measurement within this frequency range shown " --- " in the table above means the reading of emissions are attenuated more than 20dB below the permissible limits or the field strength is too small to be measured.
5. Measurements above show only up to 6 maximum emissions noted, or would be lesser, with " N/A " remark, if no specific emissions from the EUT are recorded (ie: margin > 20dB from the applicable limit) and considered that's already beyond the background noise floor.
6. Margin (dB) = Remark result (dBuV/m) – Average limit (dBuV/m).

7.8 POWERLINE CONDUCTED EMISSIONS

LIMIT

According to §15.207(a), except as shown in paragraphs (b) and (c) of this section, for an intentional radiator that is designed to be connected to the public utility (AC) power line, the radio frequency voltage that is conducted back onto the AC power line on any frequency or frequencies within the band 150 kHz to 30 MHz shall not exceed the limits in the following table, as measured using a 50 μ H/50 ohms line impedance stabilization network (LISN). Compliance with the provisions of this paragraph shall be based on the measurement of the radio frequency voltage between each power line and ground at the power terminal. The lower limit applies at the boundary between the frequency ranges.

Frequency Range (MHz)	Limits (dB μ V)	
	Quasi-peak	Average
0.15 to 0.50	66 to 56*	56 to 46*
0.50 to 5	56	46
5 to 30	60	50

* Decreases with the logarithm of the frequency.

Test Configuration

See test photographs attached in Appendix II for the actual connections between EUT and support equipment.

TEST PROCEDURE

1. The EUT was placed on a table, which is 0.8m above ground plane.
2. Maximum procedure was performed on the six highest emissions to ensure EUT compliance.
3. Repeat above procedures until all frequency measured were complete.

TEST RESULTS

The initial step in collecting conducted data is a spectrum analyzer peak scan of the measurement range. Significant peaks are then marked as shown on the following data page, and these signals are then quasi-peaked.

Test Data

Operation Mode: Normal Link **Test Date:** June 3, 2015
Temperature: 25°C **Tested by:** Alee Shen
Humidity: 58% RH

Freq (MHz)	Reading (dBuV)	Corr. factor (dB/m)	Result (dBuV/m)	Limit (dBuV)	Margin (dB)	Note
0.2860	38.99	10.01	49.00	60.64	-11.64	L1
0.2980	36.02	10.01	46.03	60.30	-14.27	L1
2.7420	24.70	10.30	35.00	56.00	-21.00	L1
4.4859	26.04	10.37	36.41	56.00	-19.59	L1
13.3579	30.53	10.70	41.23	60.00	-18.77	L1
16.2299	30.64	10.80	41.44	60.00	-18.56	L1
0.1660	33.62	10.01	43.63	65.16	-21.53	L2
0.2860	38.20	10.01	48.21	60.64	-12.43	L2
0.5940	24.68	10.07	34.75	56.00	-21.25	L2
2.8500	25.30	10.32	35.62	56.00	-20.38	L2
13.3580	30.81	10.70	41.51	60.00	-18.49	L2
16.2300	30.80	10.80	41.60	60.00	-18.40	L2

Remark:

1. *Measuring frequencies from 0.15 MHz to 30MHz.*
2. *The emissions measured in frequency range from 0.15 MHz to 30MHz were made with an instrument using Quasi-peak detector and average detector.*
3. *The IF bandwidth of SPA between 0.15MHz and 30MHz was 10 kHz; the IF bandwidth of Test Receiver between 0.15MHz and 30MHz was 9 kHz;*
4. *L1 = Line One (Live Line) / L2 = Line Two (Neutral Line)*

Test Plots

Conducted emissions (Line 1)

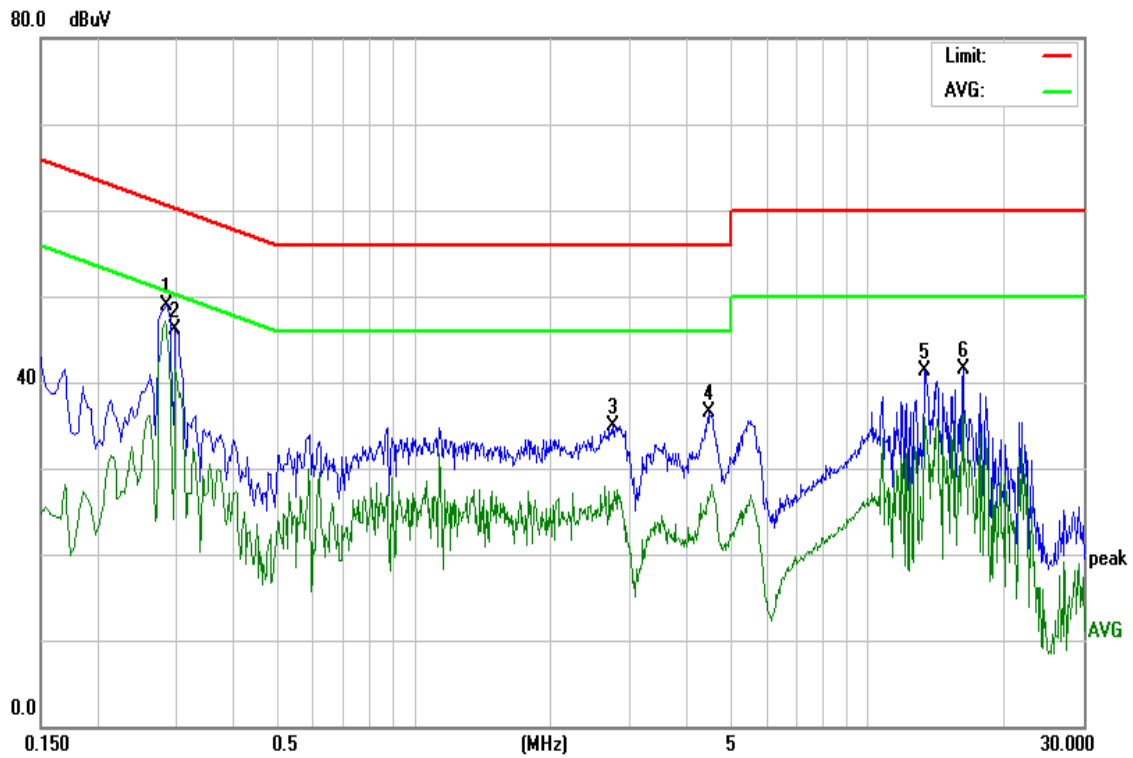

Conducted emissions (Line 2)

