



**FCC 47 CFR PART 15 SUBPART C  
(Class II Permissive Change)**

**TEST REPORT**

**For**

**Wireless Camera**

**Model:**

**OC810xxxxx (X= 0~9, A~Z, Blank or any Character), OC810-ADT,  
IPCAM-WO, ISEE-WOCAM, OC810V, WCO100**

**Trade Name: SerComm**

*Issued to*

**SerComm Corporation  
8F, No. 3-1, YuanQu St., NanKang, Taipei 115, Taiwan, R.O.C.**

*Issued by*

**Compliance Certification Services Inc.  
No.11, Wu-Gong 6th Rd., Wugu Industrial Park,  
New Taipei City 248, Taiwan (R.O.C.)  
<http://www.ccsrf.com>  
[service@ccsrf.com](mailto:service@ccsrf.com)  
Issued Date: November 29, 2012**



*Note: This report shall not be reproduced except in full, without the written approval of Compliance Certification Services Inc. This document may be altered or revised by Compliance Certification Services Inc. personnel only, and shall be noted in the revision section of the document.*



**Revision History**

Rev.	Issue Date	Revisions	Effect Page	Revised By
00	July 20, 2011	Initial Issue	ALL	Sandy Lin
01	January 17, 2012	See the following Note Rev. (01)	P1-P5	Sandy Lin
02	November 29, 2012	See the following Note Rev. (02)	ALL	Rachel Wu

*Note: Rev. (01):*

- 1. Add Model Numbers. (OC810-ADT, IPCAM-WO, ISEE-WOCAM, OC810V, WCO100)*
- 2. Other information, please refer to the T110622201 and this test report.*

*Rev. (02):*

- 1. Change Adapter (Brand: Universal Input / Model: XY-1201000UO / Input: 120V, 0.5A Max, 50~60Hz / Output: 12V, 1.0A). And Re-test power line conducted emissions.*
- 2. Other information, please refer to the T120113D01 and this test report.*



## TABLE OF CONTENTS

<b>1. TEST RESULT CERTIFICATION.....</b>	<b>4</b>
<b>2. EUT DESCRIPTION .....</b>	<b>5</b>
<b>3. TEST METHODOLOGY .....</b>	<b>6</b>
3.1 EUT CONFIGURATION .....	6
3.2 EUT EXERCISE.....	6
3.3 GENERAL TEST PROCEDURES.....	6
3.4 FCC PART 15.205 RESTRICTED BANDS OF OPERATIONS.....	7
3.5 DESCRIPTION OF TEST MODES .....	8
<b>4. INSTRUMENT CALIBRATION.....</b>	<b>9</b>
4.1 MEASURING INSTRUMENT CALIBRATION .....	9
4.2 MEASUREMENT EQUIPMENT USED .....	10
4.3 MEASUREMENT UNCERTAINTY .....	11
<b>5. FACILITIES AND ACCREDITATIONS .....</b>	<b>12</b>
5.1 FACILITIES .....	12
5.2 EQUIPMENT.....	12
5.3 TABLE OF ACCREDITATIONS AND LISTINGS.....	13
<b>6. SETUP OF EQUIPMENT UNDER TEST .....</b>	<b>14</b>
6.1 SETUP CONFIGURATION OF EUT.....	14
6.2 SUPPORT EQUIPMENT .....	14
<b>7. FCC PART 15.247 REQUIREMENTS.....</b>	<b>15</b>
7.1 6DB BANDWIDTH.....	15
7.2 PEAK POWER.....	29
7.3 AVERAGE POWER .....	31
7.4 BAND EDGES MEASUREMENT .....	33
7.5 PEAK POWER SPECTRAL DENSITY.....	50
7.6 SPURIOUS EMISSIONS.....	64
7.7 RADIATED EMISSIONS .....	77
7.8 POWERLINE CONDUCTED EMISSIONS.....	94
<b>APPENDIX I RADIO FREQUENCY EXPOSURE.....</b>	<b>97</b>
<b>APPENDIX II PHOTOGRAPHS OF TEST SETUP.....</b>	<b>100</b>
<b>APPENDIX 1 - PHOTOGRAPHS OF EUT</b>	



# 1. TEST RESULT CERTIFICATION

**Applicant:** SerComm Corporation  
8F, No. 3-1, YuanQu St., NanKang, Taipei 115, Taiwan, R.O.C.

**Equipment Under Test:** Wireless Camera

**Trade Name:** SerComm

**Model:** OC810xxxxx (X= 0~9, A~Z, Blank or any Character), OC810-ADT, IPCAM-WO, ISEE-WOCAM, OC810V, WCO100

**Date of Test:** June 23, 2011 ~ November 27, 2012

APPLICABLE STANDARDS	
STANDARD	TEST RESULT
FCC 47 CFR Part 15 Subpart C	No non-compliance noted

## We hereby certify that:

The above equipment was tested by Compliance Certification Services Inc. The test data, data evaluation, test procedures, and equipment configurations shown in this report were made in accordance with the procedures given in ANSI C63.4: 2009 and the energy emitted by the sample EUT tested as described in this report is in compliance with the requirements of FCC Rules Part 15.207, 15.209, 15.247.

The test results of this report relate only to the tested sample EUT identified in this report.

Approved by:

Reviewed by:

---

Miller Lee  
Section Manager  
Compliance Certification Services Inc.

---

Gina Lo  
Section Manager  
Compliance Certification Services Inc.



## 2. EUT DESCRIPTION

<b>Product</b>	Wireless Camera
<b>Trade Name</b>	SerComm
<b>Model Number</b>	OC810xxxxx (X= 0~9, A~Z, Blank or any Character), OC810-ADT, IPCAM-WO, ISEE-WOCAM, OC810V, WCO100
<b>Model Discrepancy</b>	All the specification and layout are identical except they come with different model numbers for marketing purposes.
<b>Received Date</b>	November 26, 2012
<b>Power Rating</b>	Universal Input / Model: XY-1201000UO I/P: 120V-0.5A, Max 50-60Hz O/P: 12V, 1.0A
<b>Frequency Range</b>	2412 ~ 2462 MHz
<b>Transmit Power</b>	IEEE 802.11b mode: 20.17 dBm IEEE 802.11g mode: 18.59 dBm IEEE 802.11n HT 20 MHz mode: 22.76 dBm IEEE 802.11n HT 40 MHz mode: 21.71 dBm
<b>Modulation Technique</b>	IEEE 802.11b mode: DSSS (1, 2, 5.5 and 11 Mbps) IEEE 802.11g mode: OFDM (6, 9, 12, 18, 24, 36, 48 and 54 Mbps) IEEE 802.11n HT 20 MHz mode: OFDM (6.5, 13, 19.5, 26, 39, 52, 58.5, 65.0Mbps) IEEE 802.11n HT 40 MHz mode: OFDM (13.5, 27, 40.5, 54, 81, 108, 121.5, 135Mbps)
<b>Number of Channels</b>	IEEE 802.11b/g mode: 11 Channels IEEE 802.11n HT 20 MHz mode: 11 Channels IEEE 802.11n HT 40 MHz mode: 7 Channels
<b>Antenna Specification</b>	Dipole Antenna / Gain: 4.2dBi
<b>Class II Permissive Change</b>	Change Adapter (Brand: Universal Input / Model: XY-1201000UO / Input: 120V, 0.5A Max, 50~60Hz / Output: 12V, 1.0A). And Re-test power line conducted emissions.

**Remark:**

1. The sample selected for test was engineering sample that approximated to production product and was provided by manufacturer.
2. This submittal(s) (test report) is intended for FCC ID: **P27OC810X** filing to comply with Section 15.207, 15.209 and 15.247 of the FCC Part 15, Subpart C Rules.



### **3. TEST METHODOLOGY**

The tests documented in this report were performed in accordance with ANSI C63.4 and FCC CFR 47 2.1046, 2.1047, 2.1049, 2.1051, 2.1053, 2.1055, 2.1057, 15.207, 15.209 and 15.247.

#### **3.1 EUT CONFIGURATION**

The EUT configuration for testing is installed on RF field strength measurement to meet the Commissions requirement and operating in a manner that intends to maximize its emission characteristics in a continuous normal application.

#### **3.2 EUT EXERCISE**

The EUT was operated in the engineering mode to fix the TX frequency that was for the purpose of the measurements.

According to its specifications, the EUT must comply with the requirements of the Section 15.207, 15.209 and 15.247 under the FCC Rules Part 15 Subpart C.

#### **3.3 GENERAL TEST PROCEDURES**

##### **Conducted Emissions**

The EUT is placed on the turntable, which is 0.8 m above ground plane. According to the requirements in Section 13.1.4.1 of ANSI C63.4 Conducted emissions from the EUT measured in the frequency range between 0.15 MHz and 30MHz using CISPR Quasi-peak and average detector modes.

##### **Radiated Emissions**

The EUT is placed on a turn table, which is 0.8 m above ground plane. The turntable shall rotate 360 degrees to determine the position of maximum emission level. EUT is set 3m away from the receiving antenna, which varied from 1m to 4m to find out the highest emission. And also, each emission was to be maximized by changing the polarization of receiving antenna both horizontal and vertical. In order to find out the maximum emissions, exploratory radiated emission measurements were made according to the requirements in Section 13.1.4.1 of ANSI C63.4.



### 3.4 FCC PART 15.205 RESTRICTED BANDS OF OPERATIONS

- (a) Except as shown in paragraph (d) of this section, only spurious emissions are permitted in any of the frequency bands listed below:

MHz	MHz	MHz	GHz
0.090 - 0.110	16.42 - 16.423	399.9 - 410	4.5 - 5.15
<sup>1</sup> 0.495 - 0.505	16.69475 - 16.69525	608 - 614	5.35 - 5.46
2.1735 - 2.1905	16.80425 - 16.80475	960 - 1240	7.25 - 7.75
4.125 - 4.128	25.5 - 25.67	1300 - 1427	8.025 - 8.5
4.17725 - 4.17775	37.5 - 38.25	1435 - 1626.5	9.0 - 9.2
4.20725 - 4.20775	73 - 74.6	1645.5 - 1646.5	9.3 - 9.5
6.215 - 6.218	74.8 - 75.2	1660 - 1710	10.6 - 12.7
6.26775 - 6.26825	108 - 121.94	1718.8 - 1722.2	13.25 - 13.4
6.31175 - 6.31225	123 - 138	2200 - 2300	14.47 - 14.5
8.291 - 8.294	149.9 - 150.05	2310 - 2390	15.35 - 16.2
8.362 - 8.366	156.52475 -	2483.5 - 2500	17.7 - 21.4
8.37625 - 8.38675	156.52525	2655 - 2900	22.01 - 23.12
8.41425 - 8.41475	156.7 - 156.9	3260 - 3267	23.6 - 24.0
12.29 - 12.293	162.0125 - 167.17	3332 - 3339	31.2 - 31.8
12.51975 - 12.52025	167.72 - 173.2	3345.8 - 3358	36.43 - 36.5
12.57675 - 12.57725	240 - 285	3600 - 4400	( <sup>2</sup> )
13.36 - 13.41	322 - 335.4		

<sup>1</sup> Until February 1, 1999, this restricted band shall be 0.490-0.510 MHz.

<sup>2</sup> Above 38.6

- (b) Except as provided in paragraphs (d) and (e), the field strength of emissions appearing within these frequency bands shall not exceed the limits shown in Section 15.209. At frequencies equal to or less than 1000 MHz, compliance with the limits in Section 15.209 shall be demonstrated using measurement instrumentation employing a CISPR quasi-peak detector. Above 1000 MHz, compliance with the emission limits in Section 15.209 shall be demonstrated based on the average value of the measured emissions. The provisions in Section 15.35 apply to these measurements.



### **3.5 DESCRIPTION OF TEST MODES**

The EUT (model: OC810) had been tested under operating condition.

Software used to control the EUT for staying in continuous transmitting mode was programmed.

After verification, all tests were carried out with the worst case test modes as shown below except radiated spurious emission below 1GHz and power line conducted emissions below 30MHz, which worst case was in normal link mode only.

#### **IEEE 802.11b mode:**

Channel Low (2412MHz), Channel Mid (2442MHz) and Channel High (2462MHz) with 1Mbps data rate were chosen for full testing.

#### **IEEE 802.11g mode:**

Channel Low (2412MHz), Channel Mid (2442MHz) and Channel High (2462MHz) with 6Mbps data rate were chosen for full testing.

#### **IEEE 802.11n HT 20 MHz mode:**

Channel Low (2412MHz), Channel Mid (2442MHz) and Channel High (2462MHz) with 6.5Mbps data rate were chosen for full testing.

#### **IEEE 802.11n HT 40 MHz mode:**

Channel Low (2422MHz), Channel Mid (2442MHz) and Channel High (2452MHz) with 13.5Mbps data rate were chosen for full testing.





## **4. INSTRUMENT CALIBRATION**

### **4.1 MEASURING INSTRUMENT CALIBRATION**

The measuring equipment, which was utilized in performing the tests documented herein, has been calibrated in accordance with the manufacturer's recommendations for utilizing calibration equipment, which is traceable to recognized national standards.



## 4.2 MEASUREMENT EQUIPMENT USED

### Equipment Used for Emissions Measurement

*Remark: Each piece of equipment is scheduled for calibration once a year and Loop Antenna is scheduled for calibration once three years.*

Conducted Emissions Test Site				
Name of Equipment	Manufacturer	Model	Serial Number	Calibration Due
Spectrum Analyzer	Agilent	E4446A	MY43360131	03/21/2013
Power Meter	Anritsu	ML2495A	1012009	06/05/2013
Power Sensor	Anritsu	MA2411B	0917072	06/05/2013

Wugu 966 Chamber A				
Name of Equipment	Manufacturer	Model	Serial Number	Calibration Due
Spectrum Analyzer	Agilent	E4446A	US42510268	11/06/2013
EMI Test Receiver	R&S	ESCI	100064	03/01/2013
Pre-Amplifier	Mini-Circuits	ZFL-1000LN	SF350700823	01/13/2013
Pre-Amplifier	MITEQ	AFS44-00102650-42-10P-44	1415367	11/20/2012
Bilog Antenna	Sunol Sciences	JB3	A030105	10/02/2013
Horn Antenna	EMCO	3117	00055165	02/14/2013
Loop Antenna	EMCO	6502	8905/2356	06/10/2013
Turn Table	CCS	CC-T-1F	N/A	N.C.R
Antenna Tower	CCS	CC-A-1F	N/A	N.C.R
Controller	CCS	CC-C-1F	N/A	N.C.R
Site NSA	CCS	N/A	N/A	12/23/2012
Test S/W	EZ-EMC (CCS-3A1RE)			

Conducted Emission room # A				
Name of Equipment	Manufacturer	Model	Serial Number	Calibration Due
TEST RECEIVER	R&S	ESHS20	840455/006	09/10/2013
LISN (EUT)	SCHWARZBECK	NSLK 8127	8127527	12/13/2012
LISN	SCHWARZBECK	NSLK 8127	8127526	12/13/2012
BNC CABLE	MIYAZAKI	5D-FB	BNC A5	12/07/2012
Pulse Limiter	R&S	ESH3-Z2	C3010026-2	09/07/2013
THERMO-HYGRO METER	TECPEL	DTM-303	NO.3	05/14/2013
Test S/W	EZ-EMC			



### 4.3 MEASUREMENT UNCERTAINTY

PARAMETER	UNCERTAINTY
Powerline Conducted Emission	+/- 1.0717
3M Semi Anechoic Chamber / 30M~200M	+/- 4.0606
3M Semi Anechoic Chamber / 200M~1000M	+/- 3.9979
3M Semi Anechoic Chamber / 1G~8G	+/- 2.5790
3M Semi Anechoic Chamber / 8G~18G	+/- 2.5928
3M Semi Anechoic Chamber / 18G~26G	+/- 2.7212
3M Semi Anechoic Chamber / 26G~40G	+/- 2.9520

**Remark:** This uncertainty represents an expanded uncertainty expressed at approximately the 95% confidence level using a coverage factor of  $k=2$ .



## 5. FACILITIES AND ACCREDITATIONS

### 5.1 FACILITIES

All measurement facilities used to collect the measurement data are located at

No.199, Chungshen Road, Hsintien City, Taipei Hsien, Taiwan, R.O.C.

Tel: 886-2-2217-0894 / Fax: 886-2-2217-1029

*Remark: The powerline conducted emissions test items was tested at Compliance Certification Services Inc. (Hsintien Lab.) The test equipments were listed in page 10 and the test data, please refer page 95-96.*

No.11, Wu-Gong 6th Rd., Wugu Industrial Park, New Taipei City 248, Taiwan (R.O.C.)

Tel: 886-2-2299-9720 / Fax: 886-2-2298-4045

No.81-1, Lane 210, Bade 2nd Rd., Lujhu Township, Taoyuan County 33841, TAIWAN, R.O.C.

Tel: 886-3-324-0332 / Fax: 886-3-324-5235

The sites are constructed in conformance with the requirements of ANSI C63.7, ANSI C63.4 and CISPR Publication 22.

### 5.2 EQUIPMENT

Radiated emissions are measured with one or more of the following types of linearly polarized antennas: tuned dipole, biconical, log periodic, bi-log, and/or ridged waveguide, horn. Spectrum analyzers with pre-selectors and quasi-peak detectors are used to perform radiated measurements.



Conducted emissions are measured with Line Impedance Stabilization Networks and EMI Test Receivers.

Calibrated wideband preamplifiers, coaxial cables, and coaxial attenuators are also used for making measurements.

All receiving equipment conforms to CISPR Publication 16-1, "Radio Interference Measuring Apparatus and Measurement Methods."



### 5.3 TABLE OF ACCREDITATIONS AND LISTINGS

Country	Agency	Scope of Accreditation	Logo
USA	FCC	3M Semi Anechoic Chamber (FCC MRA: TW1039) to perform FCC Part 15 measurements	 FCC MRA: TW1039
Taiwan	TAF	LP0002, RTTE01, FCC Method-47 CFR Part 15 Subpart C, D, E, RSS-210, RSS-310 IDA TS SRD, AS/NZS 4268, AS/NZS 4771, TS 12.1 & 12.2, ETSI EN 300 440-1, ETSI EN 300 440-2, ETSI EN 300 328, ETSI EN 300 220-1, ETSI EN 300 220-2, ETSI EN 301 893, ETSI EN 301 489-1/3/7/17 FCC OET Bulletin 65 + Supplement C, EN 50360, EN 50361, EN 50371, RSS 102, EN 50383, EN 50385, EN 50392, IEC 62209, CNS 14958-1, CNS 14959 FCC Method -47 CFR Part 15 Subpart B IEC / EN 61000-3-2, IEC / EN 61000-3-3, IEC / EN 61000-4-2/3/4/5/6/8/11	
Canada	Industry Canada	3M Semi Anechoic Chamber (IC 2324G-1 / IC 2324G-2) to perform	 IC 2324G-1 IC 2324G-2

\* No part of this report may be used to claim or imply product endorsement by A2LA or any agency of the US Government.



## 6. SETUP OF EQUIPMENT UNDER TEST

### 6.1 SETUP CONFIGURATION OF EUT

See test photographs attached in Appendix II for the actual connections between EUT and support equipment.

### 6.2 SUPPORT EQUIPMENT

No	Equipment	Model No.	Serial No.	FCC ID / BSMI ID	Brand Name	Data Cable	Power Cord
1	PS/2 Mouse	M-SBF96	FATSQ0C5BYJQKZ	DOC BSMI: R41126	hp	Shielded, 1.8m	N/A
2	PS/2 Keyboard	SK-2880	BAUEL0HCPY76G7	DOC BSMI: T3A002	hp	Shielded, 1.8m	N/A
3.	Printer	Deskjet D2360	TH73C1492F	DOC BSMI: R33001	HP	Shielded, 1.8m	Unshielded, 1.8m
4	Monitor	933SN+	N/A	DOC BSMI: R33475	SAMSUNG	Shielded, 1.8m with two cores	Unshielded, 1.8m
5	Host PC	T3500	FX36VBX	DOC BSMI: R33002	DELL	Unshielded, 1.5m	Unshielded, 1.8m
6	Modem	AL-56ERM	0MERM04A0212	DOC	GALILEO	Shielded, 1.0m	Unshielded, 1.8m with a core

**Remark:**

1. All the equipment/cables were placed in the worst-case configuration to maximize the emission during the test.
2. Grounding was established in accordance with the manufacturer's requirements and conditions for the intended use.



## 7. FCC PART 15.247 REQUIREMENTS

### 7.1 6DB BANDWIDTH

#### LIMIT

According to §15.247(a)(2), systems using digital modulation techniques may operate in the 902 - 928 MHz, 2400 - 2483.5 MHz, and 5725 - 5850 MHz bands. The minimum 6dB bandwidth shall be at least 500 kHz.

#### Test Configuration

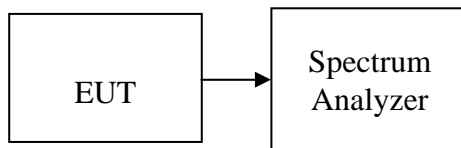

#### TEST PROCEDURE

1. Place the EUT on the table and set it in the transmitting mode.
2. Remove the antenna from the EUT and then connect a low loss RF cable from the antenna port to the spectrum analyzer.
3. Set the spectrum analyzer as RBW = 100 kHz, VBW = 300 kHz, Span = 50 MHz, Sweep = auto.
4. Mark the peak frequency and -6dB (upper and lower) frequency.
5. Repeat until all the rest channels are investigated.

#### TEST RESULTS

*No non-compliance noted*



### Test Data

#### **Test mode: IEEE 802.11b mode**

Channel	Frequency (MHz)	6dB Bandwidth (MHz)	Limit (kHz)	Result
Low	2412	12.1666	>500	PASS
Mid	2442	12.1666		PASS
High	2462	12.1666		PASS

#### **Test mode: IEEE 802.11g mode**

Channel	Frequency (MHz)	6dB Bandwidth (MHz)	Limit (kHz)	Result
Low	2412	16.25	>500	PASS
Mid	2442	16.25		PASS
High	2462	16.25		PASS

#### **Test mode: IEEE 802.11n HT 20 MHz mode**

Channel	Frequency (MHz)	6dB Bandwidth (MHz)	Limit (kHz)	Result
Low	2412	17.3333	>500	PASS
Mid	2442	17.0833		PASS
High	2462	16.1667		PASS

#### **Test mode: IEEE 802.11n HT 40 MHz mode**

Channel	Frequency (MHz)	6dB Bandwidth (MHz)	Limit (kHz)	Result
Low	2422	35.3334	>500	PASS
Mid	2442	35.3334		PASS
High	2452	35.3334		PASS





IEEE 802.11b mode

6dB Bandwidth (CH Low)

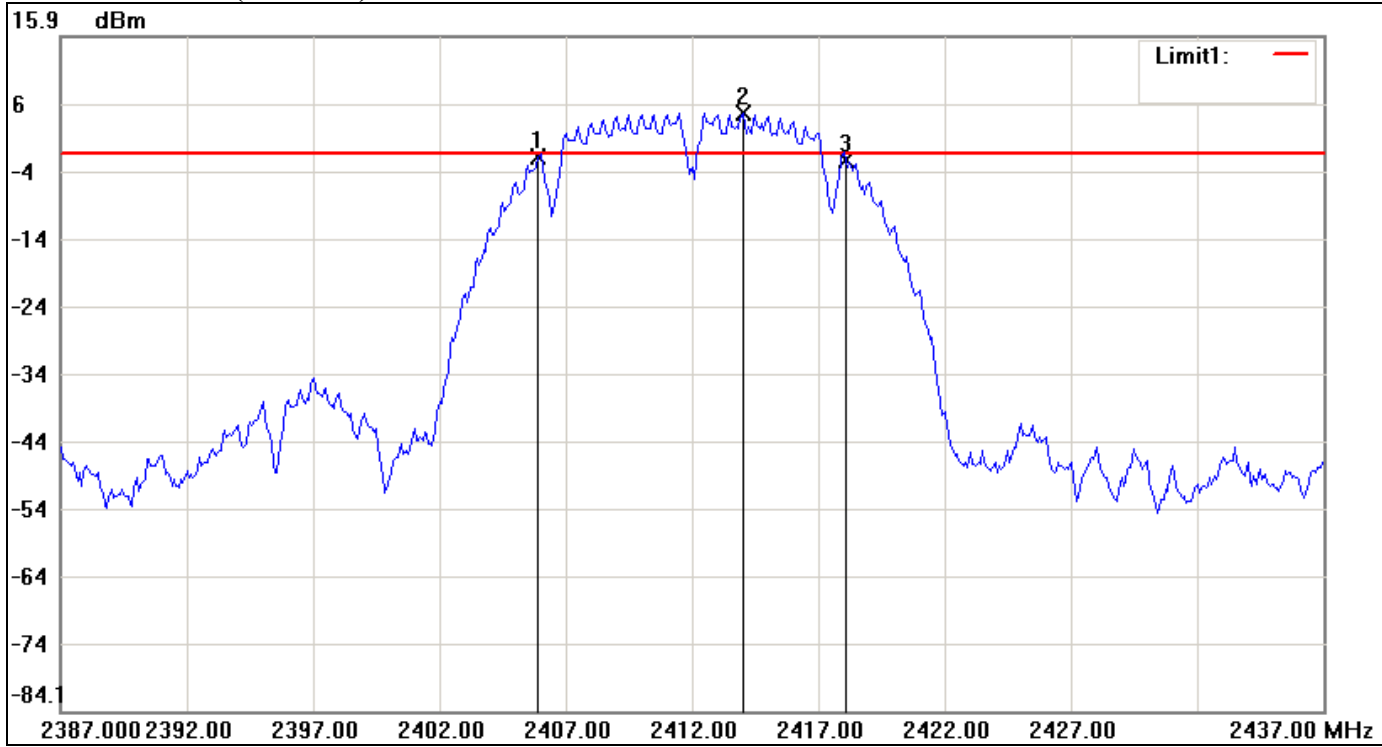

No.	Frequency(MHz)	Level(dBm)	Limit(dBm)	Margin(dBm)
1	2405.9167	-1.97	-1.47	-0.50
2	2414.0000	4.53	-1.47	6.00
3	2418.0833	-2.54	-1.47	-1.07

No.		$\Delta$ Frequency(MHz)	$\Delta$ Level(dB)
1	mk3-mk1	12.1666	-0.57



### 6dB Bandwidth (CH Mid)

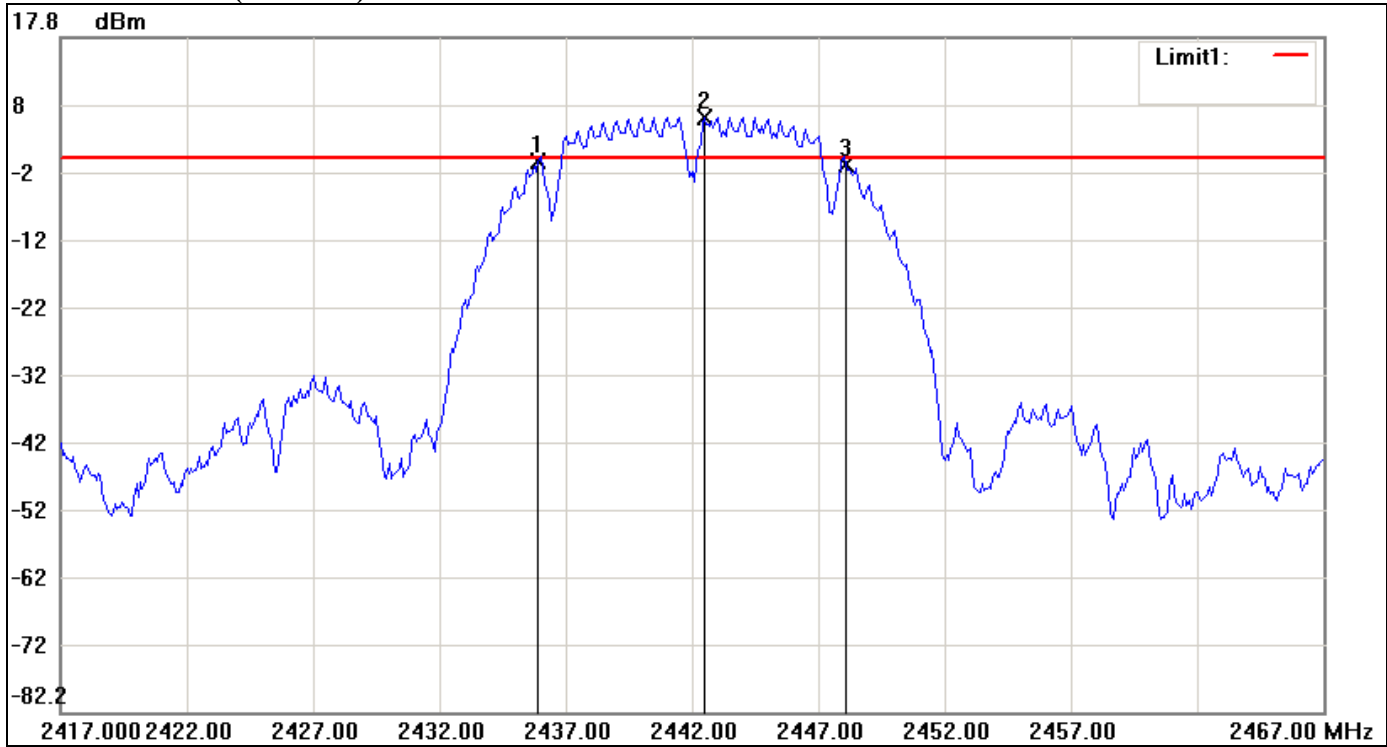

No.	Frequency(MHz)	Level(dBm)	Limit(dBm)	Margin(dBm)
1	2435.9167	-0.51	0.07	-0.58
2	2442.5000	6.07	0.07	6.00
3	2448.0833	-0.94	0.07	-1.01

No.		$\Delta$ Frequency(MHz)	$\Delta$ Level(dB)
1	mk3-mk1	12.1666	-0.43



### 6dB Bandwidth (CH High)

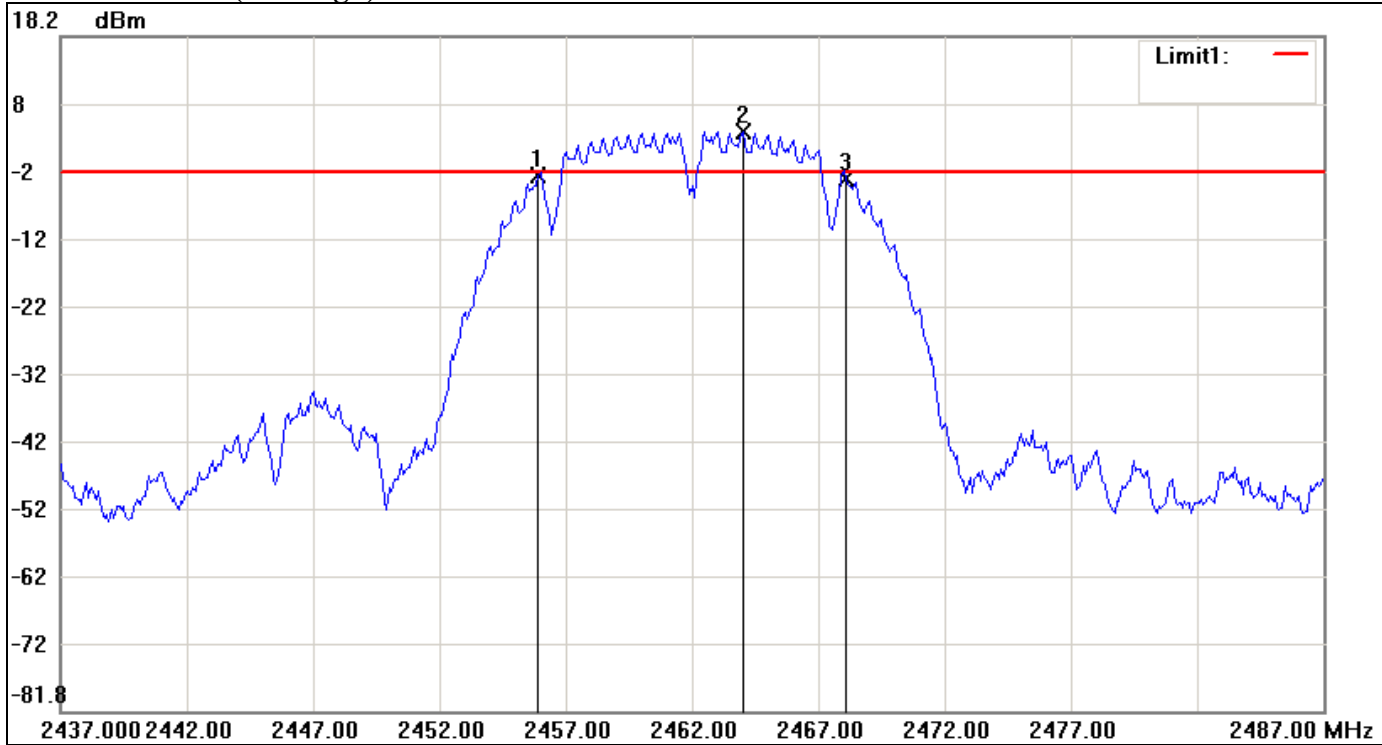

No.	Frequency(MHz)	Level(dBm)	Limit(dBm)	Margin(dBm)
1	2455.9167	-2.47	-1.98	-0.49
2	2464.0000	4.02	-1.98	6.00
3	2468.0833	-2.91	-1.98	-0.93

No.		$\Delta$ Frequency(MHz)	$\Delta$ Level(dB)
1	mk3-mk1	12.1666	-0.44



### IEEE 802.11g mode

### 6dB Bandwidth (CH Low)

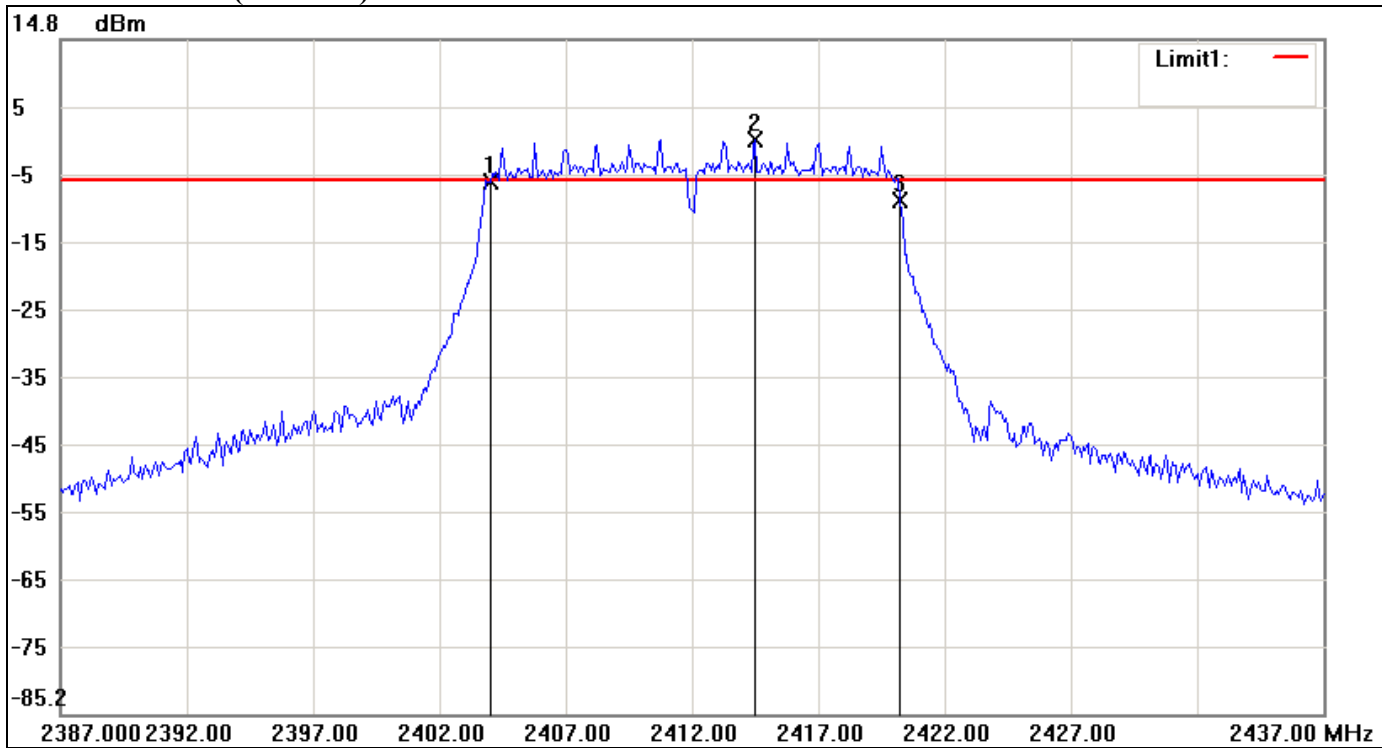

No.	Frequency(MHz)	Level(dBm)	Limit(dBm)	Margin(dBm)
1	2404.0000	-6.45	-6.02	-0.43
2	2414.5000	-0.02	-6.02	6.00
3	2420.2500	-9.07	-6.02	-3.05

No.		$\Delta$ Frequency(MHz)	$\Delta$ Level(dB)
1	mk3-mk1	16.25	-2.62



**6dB Bandwidth (CH Mid)**

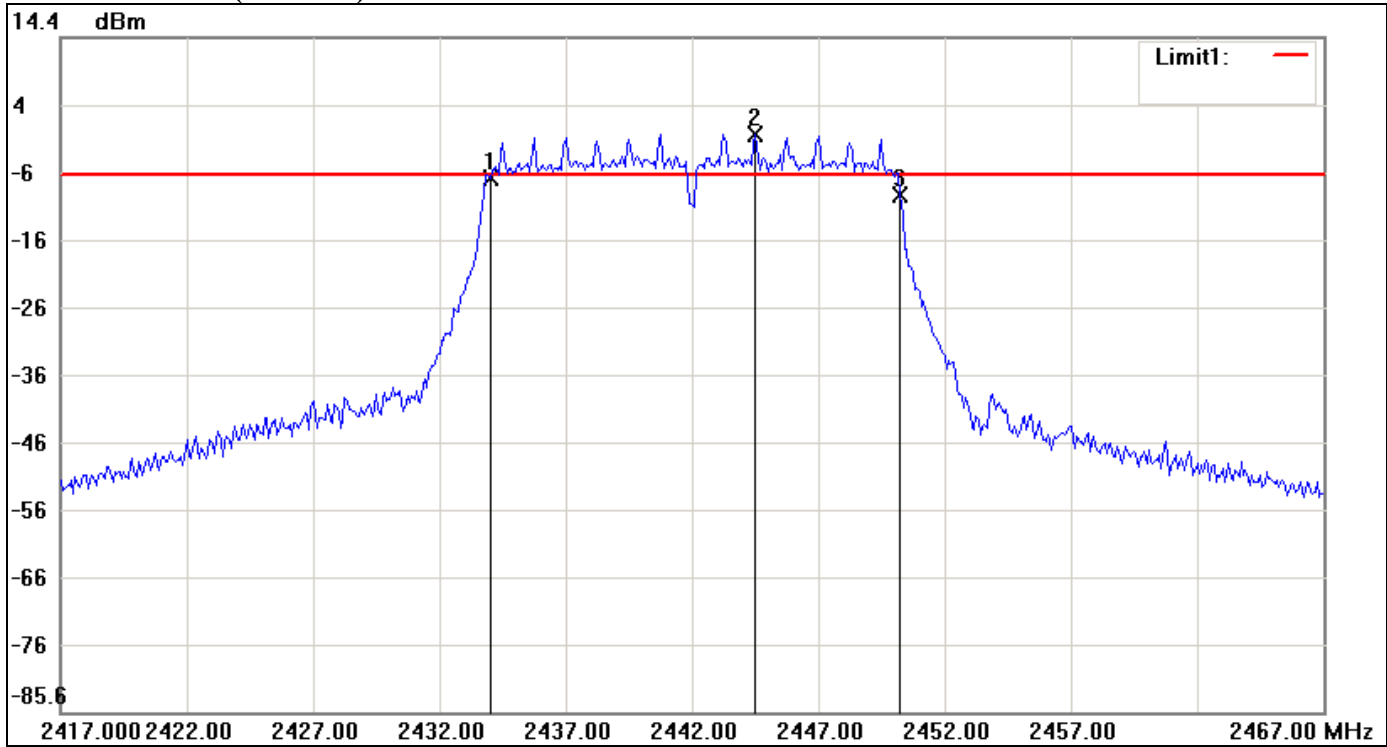

No.	Frequency(MHz)	Level(dBm)	Limit(dBm)	Margin(dBm)
1	2434.0000	-6.50	-5.99	-0.51
2	2444.5000	0.01	-5.99	6.00
3	2450.2500	-9.06	-5.99	-3.07

No.		$\Delta$ Frequency(MHz)	$\Delta$ Level(dB)
1	mk3-mk1	16.25	-2.56



**6dB Bandwidth (CH High)**

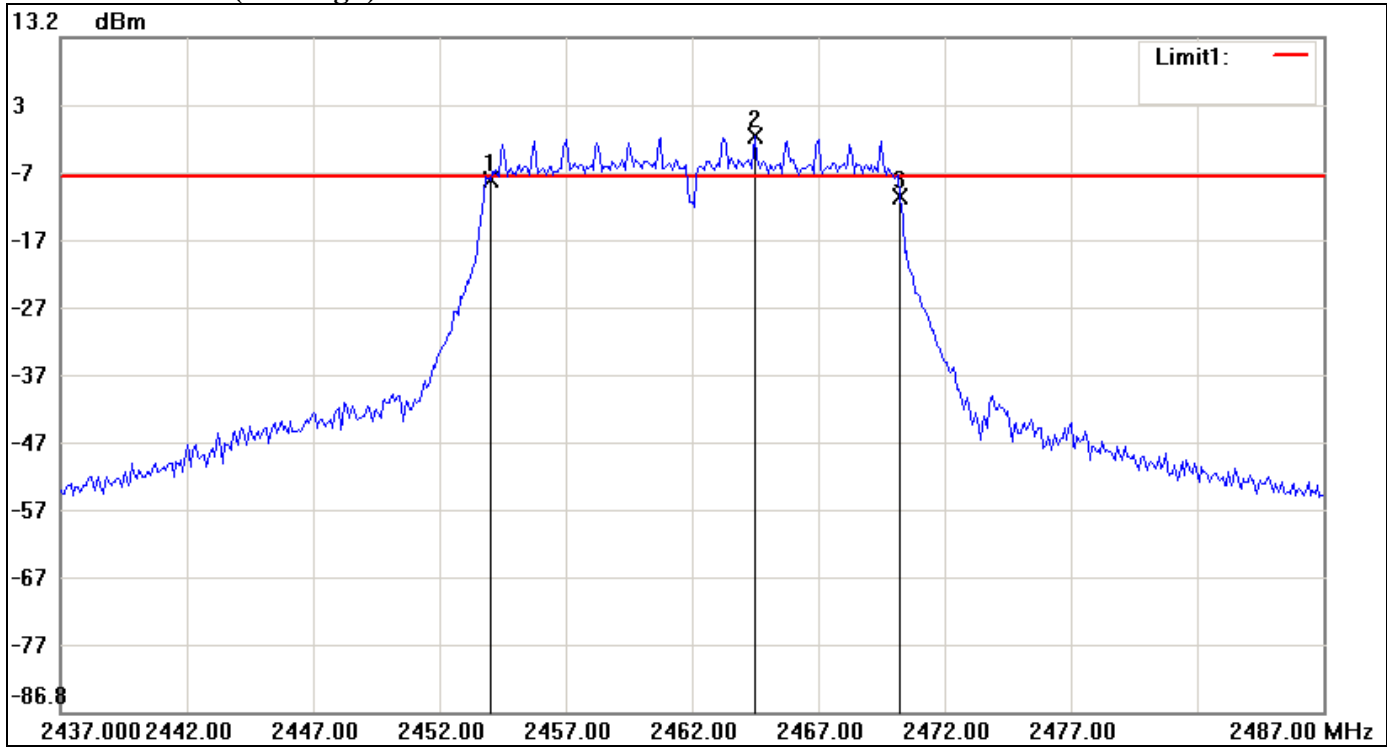

No.	Frequency(MHz)	Level(dBm)	Limit(dBm)	Margin(dBm)
1	2454.0000	-8.09	-7.54	-0.55
2	2464.5000	-1.54	-7.54	6.00
3	2470.2500	-10.43	-7.54	-2.89

No.		$\Delta$ Frequency(MHz)	$\Delta$ Level(dB)
1	mk3-mk1	16.25	-2.34



IEEE 802.11n HT 20 MHz mode

6dB Bandwidth (CH Low)

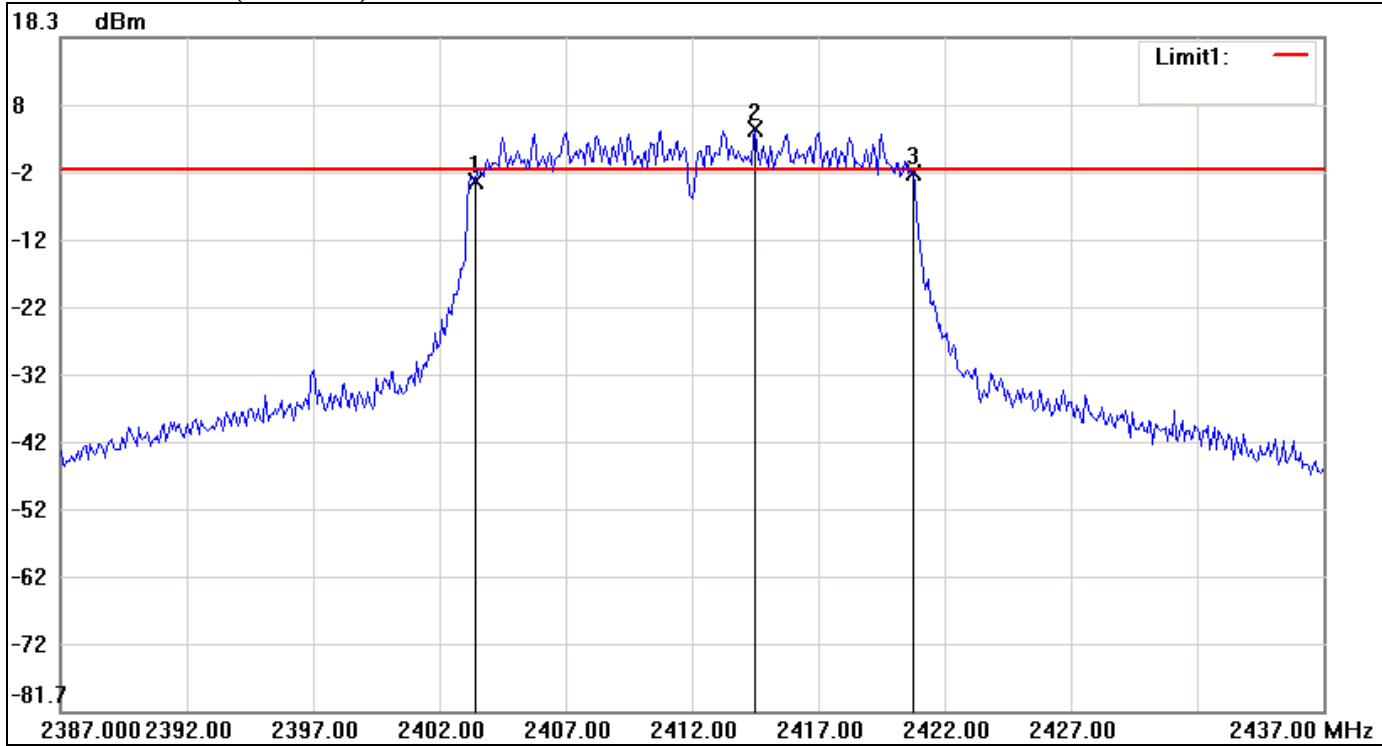

No.	Frequency(MHz)	Level(dBm)	Limit(dBm)	Margin(dBm)
1	2403.4167	-2.96	-1.43	-1.53
2	2414.5000	4.57	-1.43	6.00
3	2420.7500	-1.87	-1.43	-0.44

No.		$\Delta$ Frequency(MHz)	$\Delta$ Level(dB)
1	mk3-mk1	17.3333	1.09



**6dB Bandwidth (CH Mid)**

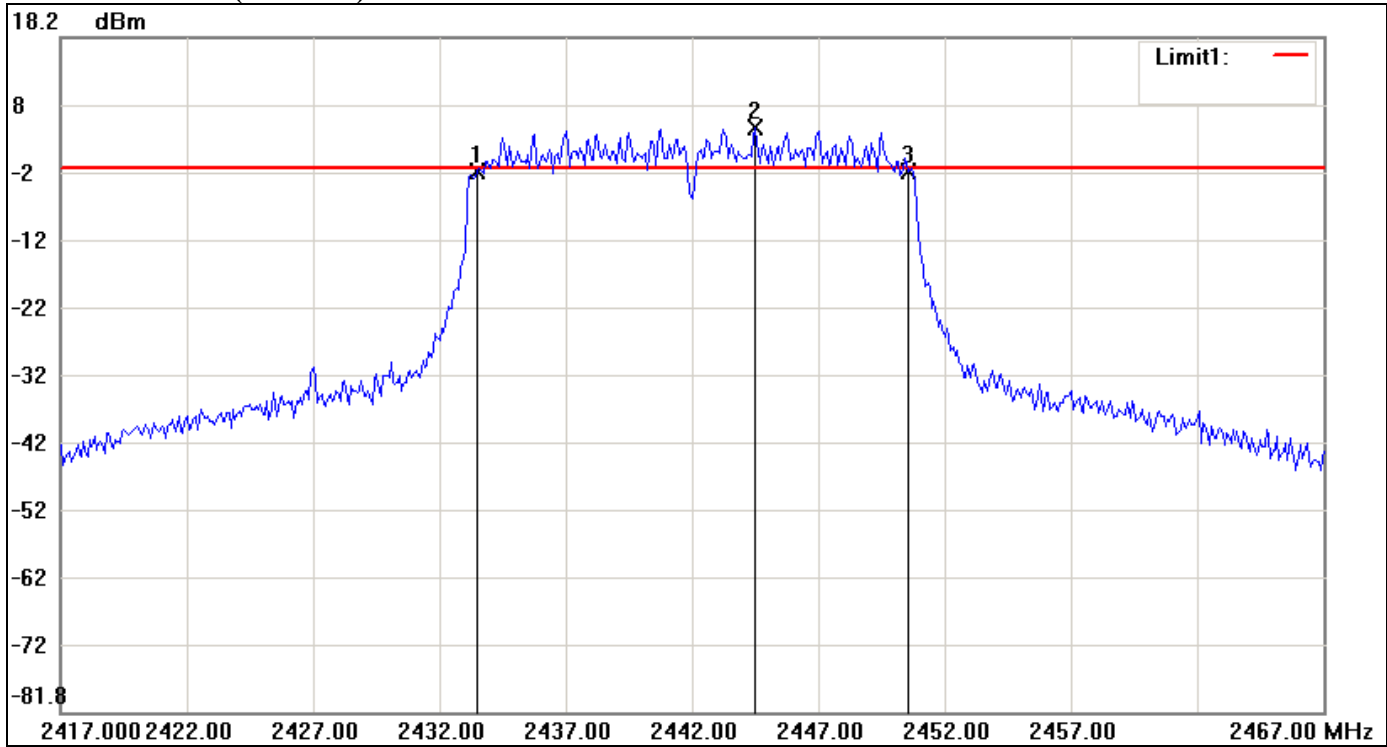

No.	Frequency(MHz)	Level(dBm)	Limit(dBm)	Margin(dBm)
1	2433.5000	-1.79	-1.21	-0.58
2	2444.5000	4.79	-1.21	6.00
3	2450.5833	-1.59	-1.21	-0.38

No.		$\Delta$ Frequency(MHz)	$\Delta$ Level(dB)
1	mk3-mk1	17.0833	0.2





**6dB Bandwidth (CH High)**

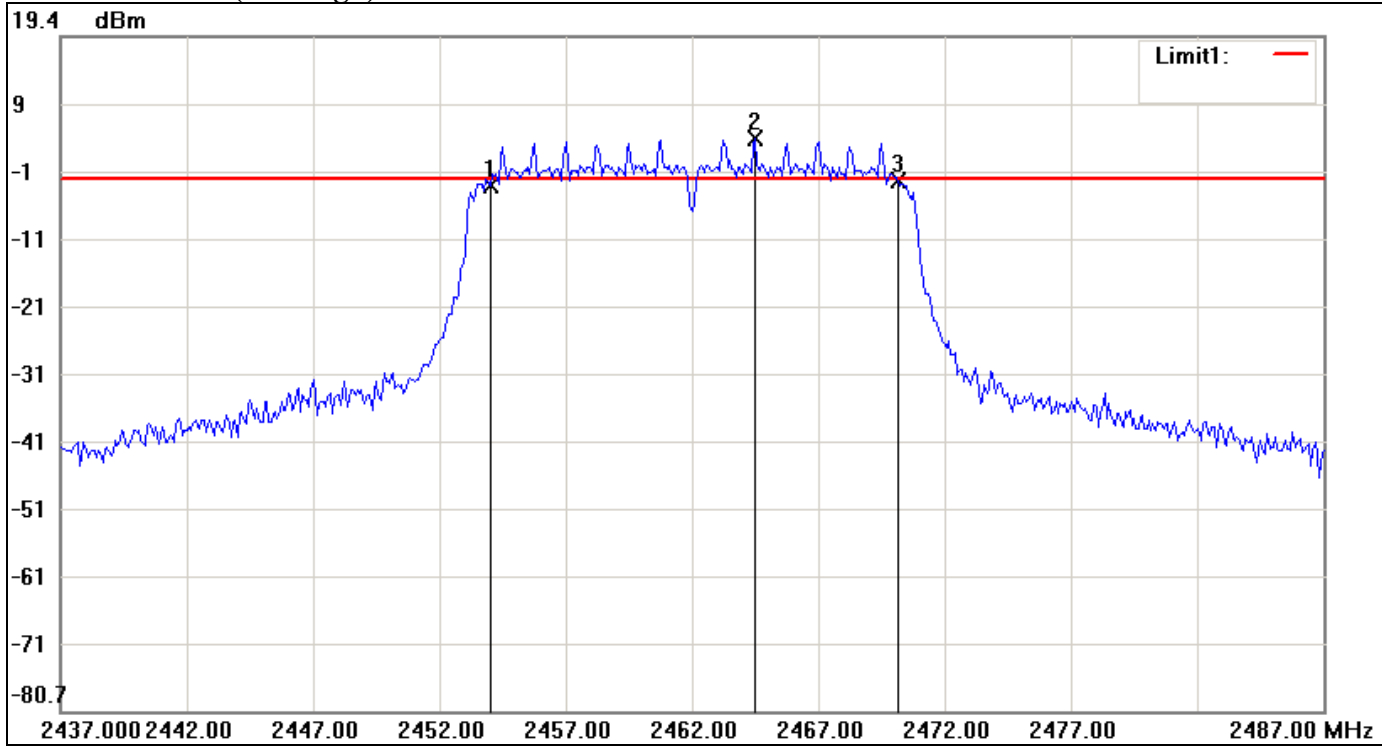

No.	Frequency(MHz)	Level(dBm)	Limit(dBm)	Margin(dBm)
1	2454.0000	-2.88	-1.84	-1.04
2	2464.5000	4.16	-1.84	6.00
3	2470.1667	-1.93	-1.84	-0.09

No.		$\Delta$ Frequency(MHz)	$\Delta$ Level(dB)
1	mk3-mk1	16.1667	0.95



IEEE 802.11n HT 40 MHz mode

6dB Bandwidth (CH Low)

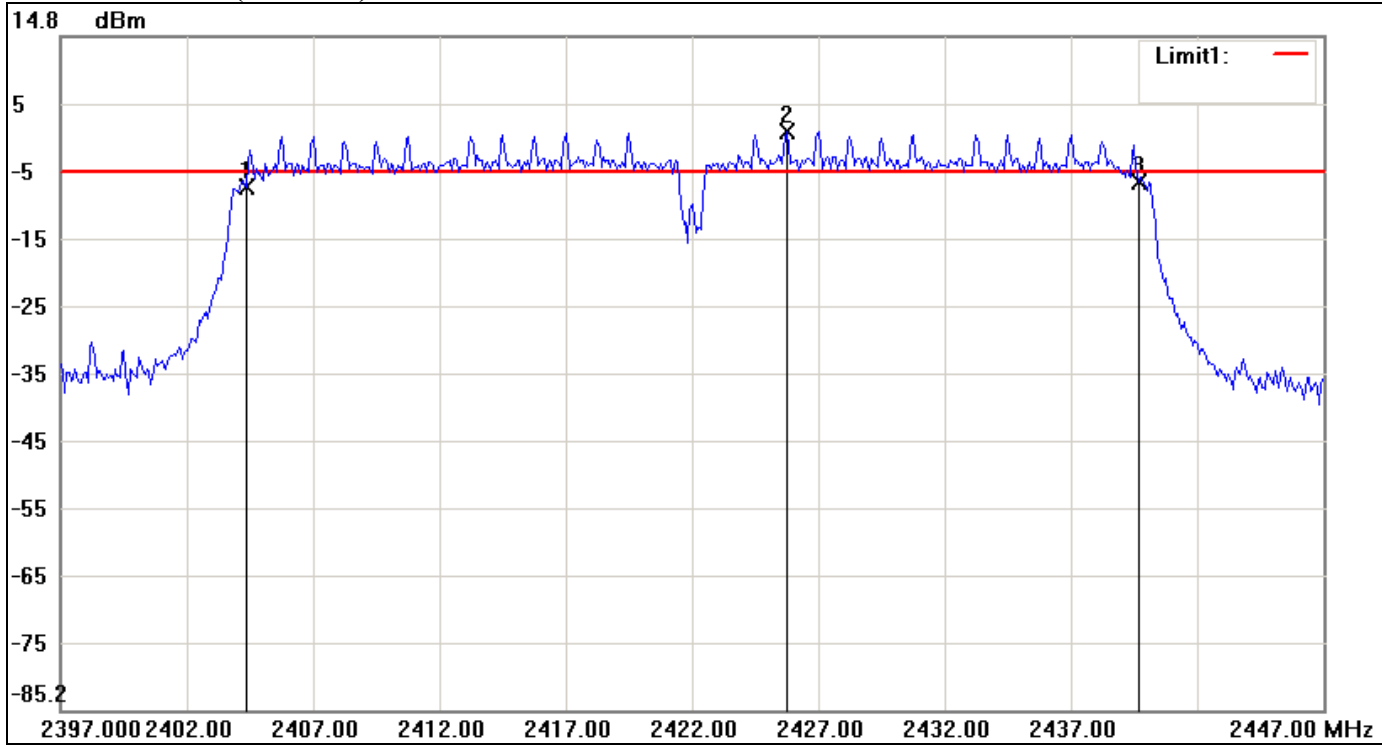

No.	Frequency(MHz)	Level(dBm)	Limit(dBm)	Margin(dBm)
1	2404.3333	-7.58	-5.21	-2.37
2	2425.7500	0.79	-5.21	6.00
3	2439.6667	-6.79	-5.21	-1.58

No.		$\Delta$ Frequency(MHz)	$\Delta$ Level(dB)
1	mk3-mk1	35.3334	0.79



**6dB Bandwidth (CH Mid)**

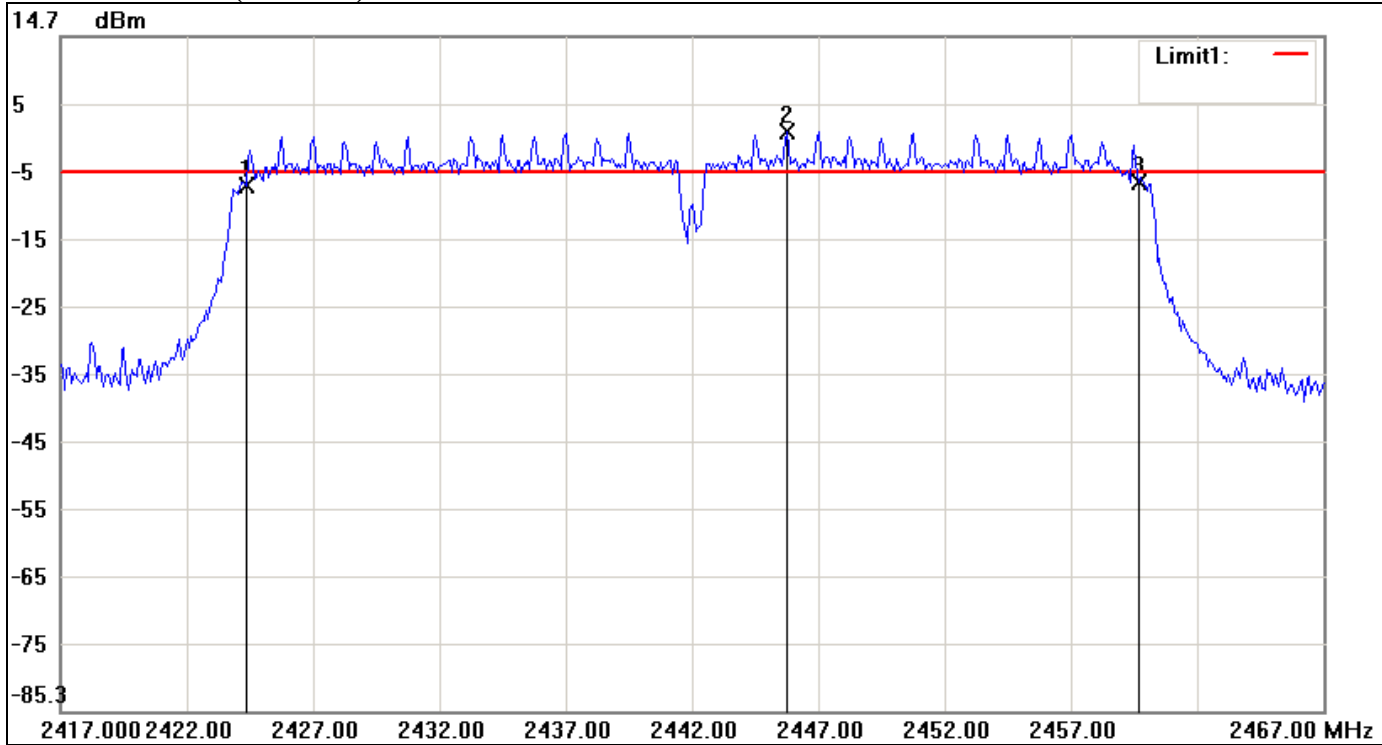

No.	Frequency(MHz)	Level(dBm)	Limit(dBm)	Margin(dBm)
1	2424.3333	-7.56	-5.35	-2.21
2	2445.7500	0.65	-5.35	6.00
3	2459.6667	-6.87	-5.35	-1.52

No.		$\Delta$ Frequency(MHz)	$\Delta$ Level(dB)
1	mk3-mk1	35.3334	0.69



**6dB Bandwidth (CH High)**

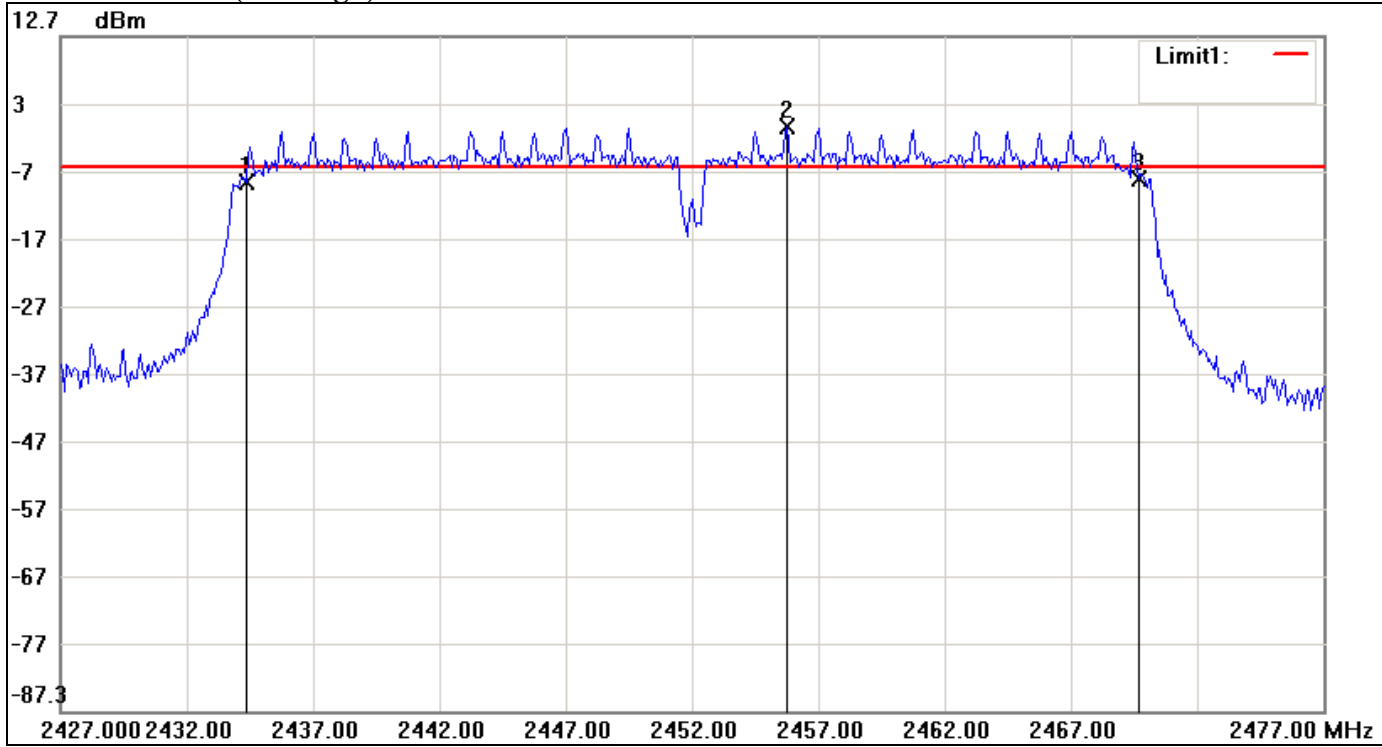

No.	Frequency(MHz)	Level(dBm)	Limit(dBm)	Margin(dBm)
1	2434.3333	-8.98	-6.75	-2.23
2	2455.7500	-0.75	-6.75	6.00
3	2469.6667	-8.52	-6.75	-1.77

No.		$\Delta$ Frequency(MHz)	$\Delta$ Level(dB)
1	mk3-mk1	35.3334	0.46



## 7.2 PEAK POWER

### LIMIT

The maximum peak output power of the intentional radiator shall not exceed the following:

1. According to §15.247(b)(3), for systems using digital modulation in the bands of 902-928 MHz, 2400-2483.5 MHz, and 5725-5850 MHz: 1 Watt.
2. According to §15.247(b)(4), the conducted output power limit specified in paragraph (b) of this section is based on the use of antennas with directional gains that do not exceed 6 dBi. Except as shown in paragraph (c) of this section, if transmitting antennas of directional gain greater than 6 dBi are used, the conducted output power from the intentional radiator shall be reduced below the stated values in paragraphs (b)(1), (b)(2), and (b)(3) of this section, as appropriate, by the amount in dB that the directional gain of the antenna exceeds 6 dBi.

### Test Configuration

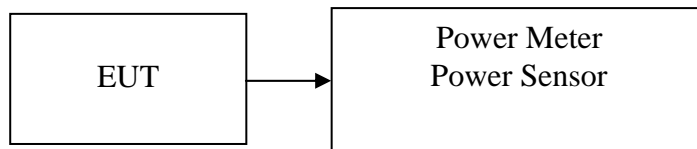

### TEST PROCEDURE

The transmitter output is connected to the Power Meter. The Power Meter is set to the peak power detection.

### TEST RESULTS

*No non-compliance noted*



## Test Data

### Test mode: IEEE 802.11b mode

Channel	Frequency (MHz)	Output Power (dBm)	Output Power (W)	Limit (W)	Result
Low	2412	19.01	0.07962	1.00	PASS
Mid	2442	20.17	0.10399		PASS
High	2462	17.71	0.05902		PASS

### Test mode: IEEE 802.11g mode

Channel	Frequency (MHz)	Output Power (dBm)	Output Power (W)	Limit (W)	Result
Low	2412	18.39	0.06902	1.00	PASS
Mid	2442	18.59	0.07228		PASS
High	2462	16.51	0.04477		PASS

### Test mode: IEEE 802.11n HT 20 MHz mode

Channel	Frequency (MHz)	Output Power (dBm)	Output Power (W)	Limit (W)	Result
Low	2412	22.76	0.18880	1.00	PASS
Mid	2442	22.34	0.17140		PASS
High	2462	22.42	0.17458		PASS

### Test mode: IEEE 802.11n HT 40 MHz mode

Channel	Frequency (MHz)	Output Power (dBm)	Output Power (W)	Limit (W)	Result
Low	2422	21.71	0.14825	1.00	PASS
Mid	2442	21.62	0.14521		PASS
High	2452	19.21	0.08337		PASS



### **7.3 AVERAGE POWER**

#### **LIMIT**

None; for reporting purposes only.

#### **Test Configuration**

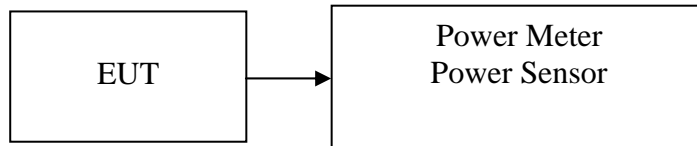

#### **TEST PROCEDURE**

The transmitter output is connected to the Power Meter. The Power Meter is set to the peak power detection.



## **TEST RESULTS**

*No non-compliance noted*

### **Test Data**

#### **Test mode: IEEE 802.11b mode**

Channel	Frequency (MHz)	Output Power (dBm)	Output Power (W)
Low	2412	15.94	0.03926
Mid	2442	17.24	0.05297
High	2462	15.53	0.03573

#### **Test mode: IEEE 802.11g mode**

Channel	Frequency (MHz)	Output Power (dBm)	Output Power (W)
Low	2412	10.72	0.01180
Mid	2442	10.69	0.01172
High	2462	8.85	0.00767

#### **Test mode: IEEE 802.11n HT 20 MHz mode**

Channel	Frequency (MHz)	Output Power (dBm)	Output Power (W)
Low	2412	14.42	0.02767
Mid	2442	14.37	0.02735
High	2462	14.26	0.02667

#### **Test mode: IEEE 802.11n HT 40 MHz mode**

Channel	Frequency (MHz)	Output Power (dBm)	Output Power (W)
Low	2422	13.56	0.02270
Mid	2442	13.62	0.02301
High	2452	11.01	0.01262





## 7.4 BAND EDGES MEASUREMENT

### LIMIT

According to §15.247(d), in any 100 kHz bandwidth outside the frequency bands in which the spread spectrum intentional radiator is operating, the radio frequency power that is produced by the intentional radiator shall be at least 20 dB below that in the 100 kHz bandwidth within the band that contains the highest level of the desired power, based on either an RF conducted or a radiated measurement, provided the transmitter demonstrates compliance with the peak conducted power limits. In addition, radiated emissions which fall in the restricted bands, as defined in §15.205(a), must also comply with the radiated emission limits specified in 15.209(a) (see Section 15.205(c)).

### Test Configuration

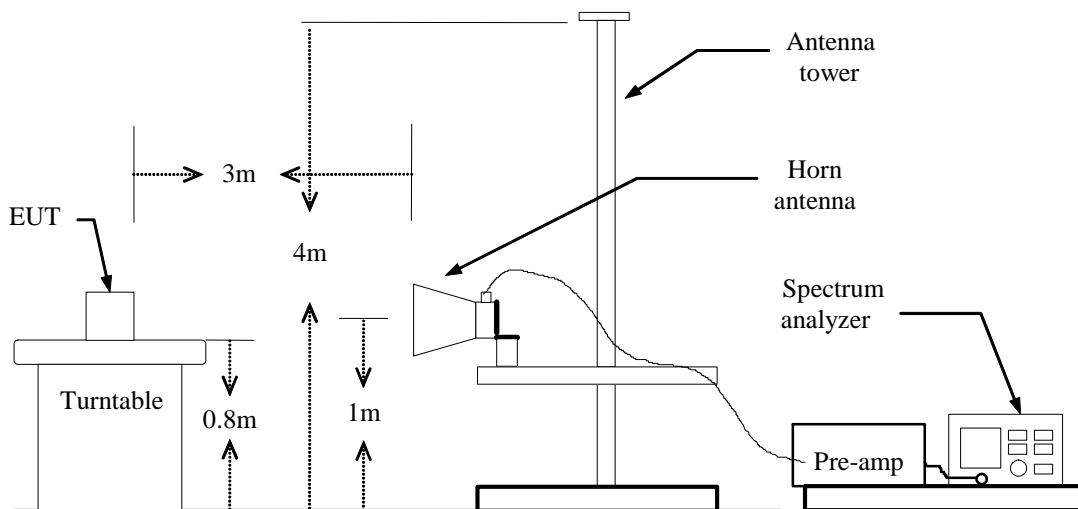

### TEST PROCEDURE

1. The EUT is placed on a turntable, which is 0.8m above the ground plane.
2. The turntable shall be rotated for 360 degrees to determine the position of maximum emission level.
3. EUT is set 3m away from the receiving antenna, which is varied from 1m to 4m to find out the highest emission.
4. Set the spectrum analyzer in the following setting in order to capture the lower and upper band-edges of the emission:
  - (a) PEAK: RBW=VBW=1MHz / Sweep=AUTO
  - (b) AVERAGE: RBW=1MHz / VBW=10Hz / Sweep=AUTO
5. Repeat the procedures until all the PEAK and AVERAGE versus POLARIZATION are measured.

### TEST RESULTS

Refer to attach spectrum analyzer data chart.



### Band Edges (IEEE 802.11b mode / CH Low)

Detector mode: Peak

Polarity: Vertical

Agilent 16:25:01 Jul 14, 2011

R T

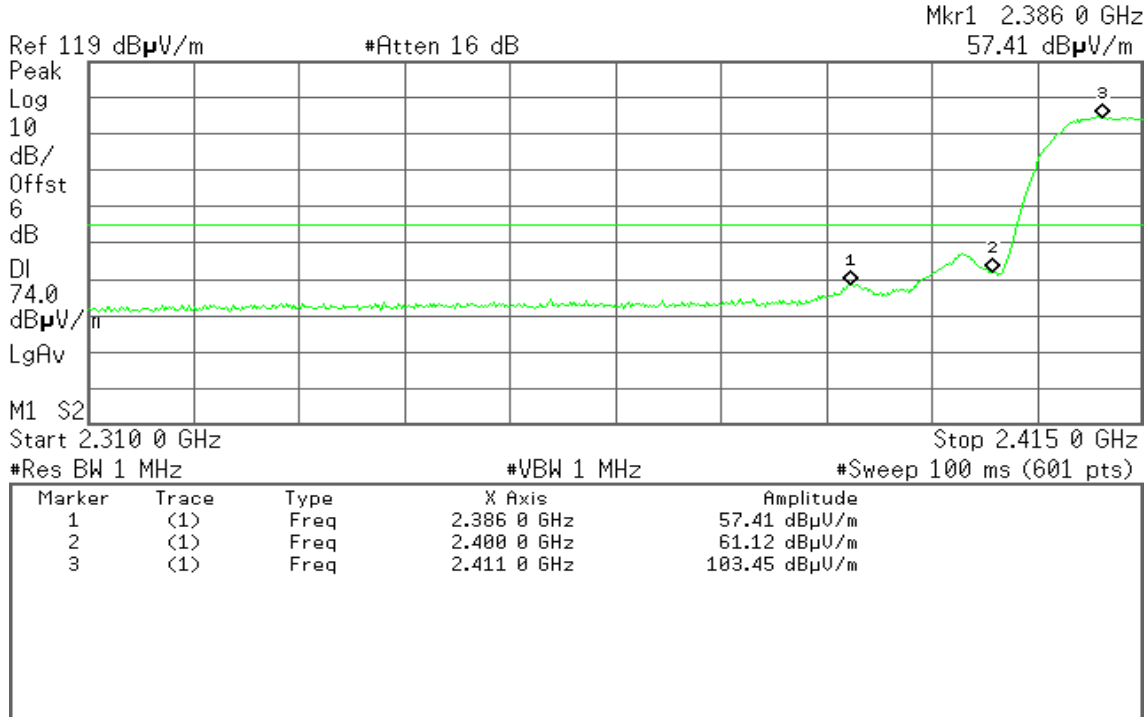

Detector mode: Average

Polarity: Vertical

Agilent 16:25:57 Jul 14, 2011

R T

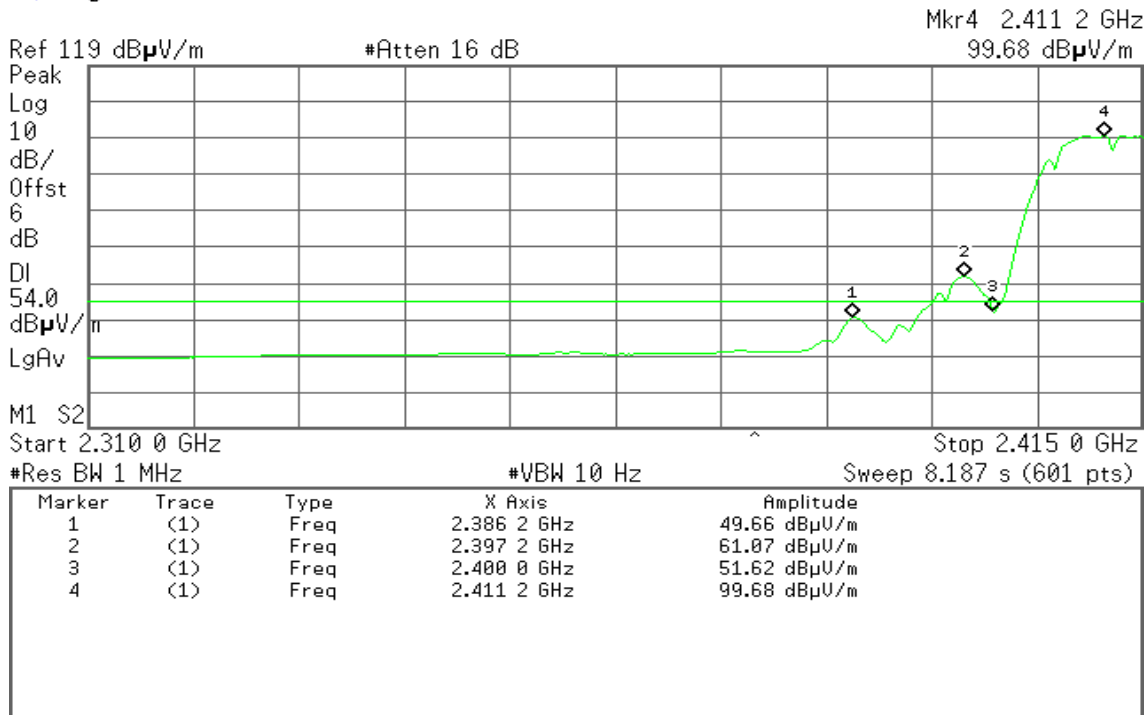



Detector mode: Peak

Polarity: Horizontal

Agilent 16:16:17 Jul 14, 2011

R T

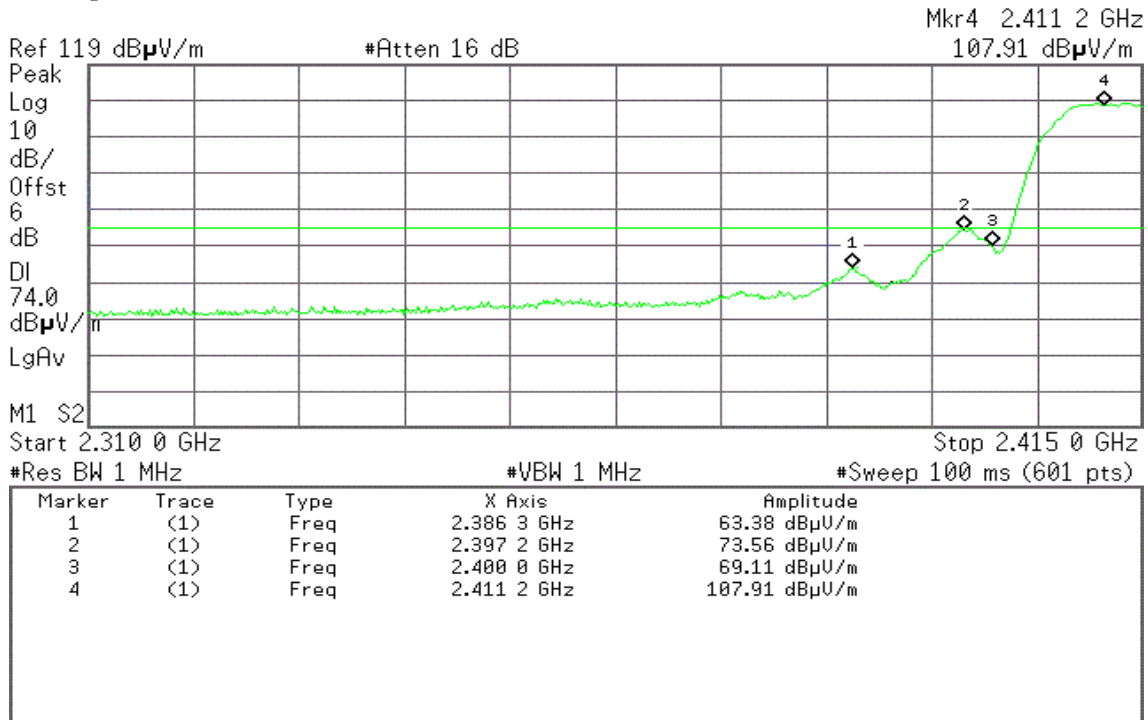

Detector mode: Average

Polarity: Horizontal

Agilent 16:19:30 Jul 14, 2011

R T

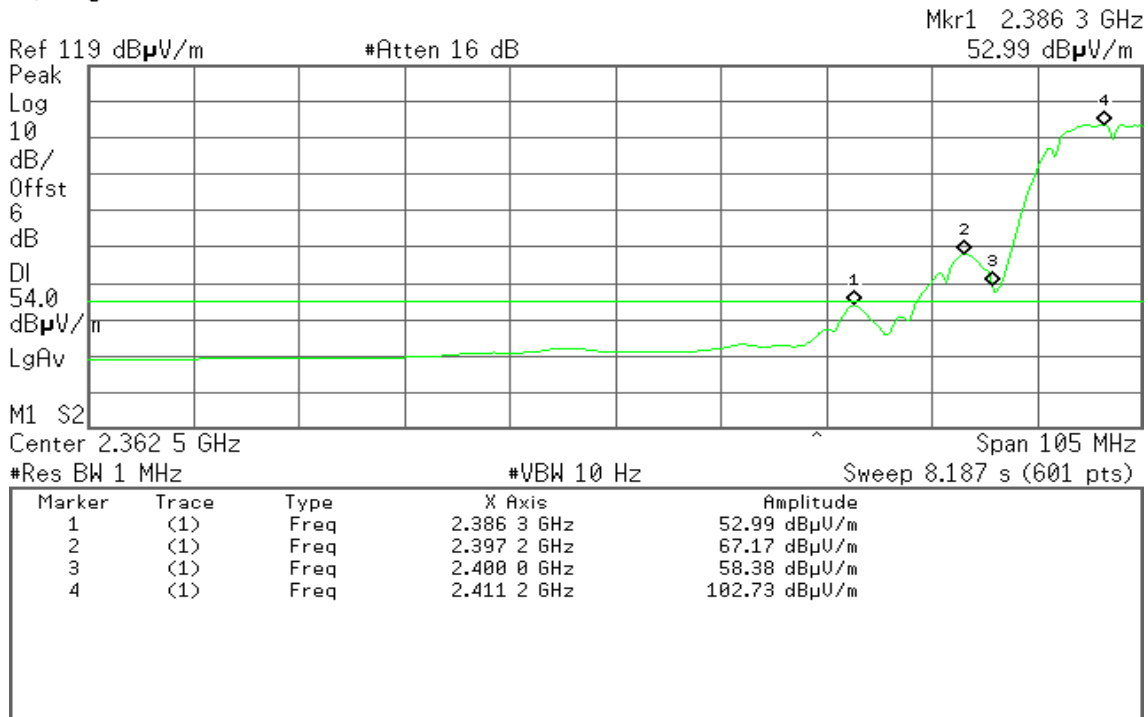



### Band Edges (IEEE 802.11b mode / CH High)

Detector mode: Peak

Polarity: Vertical

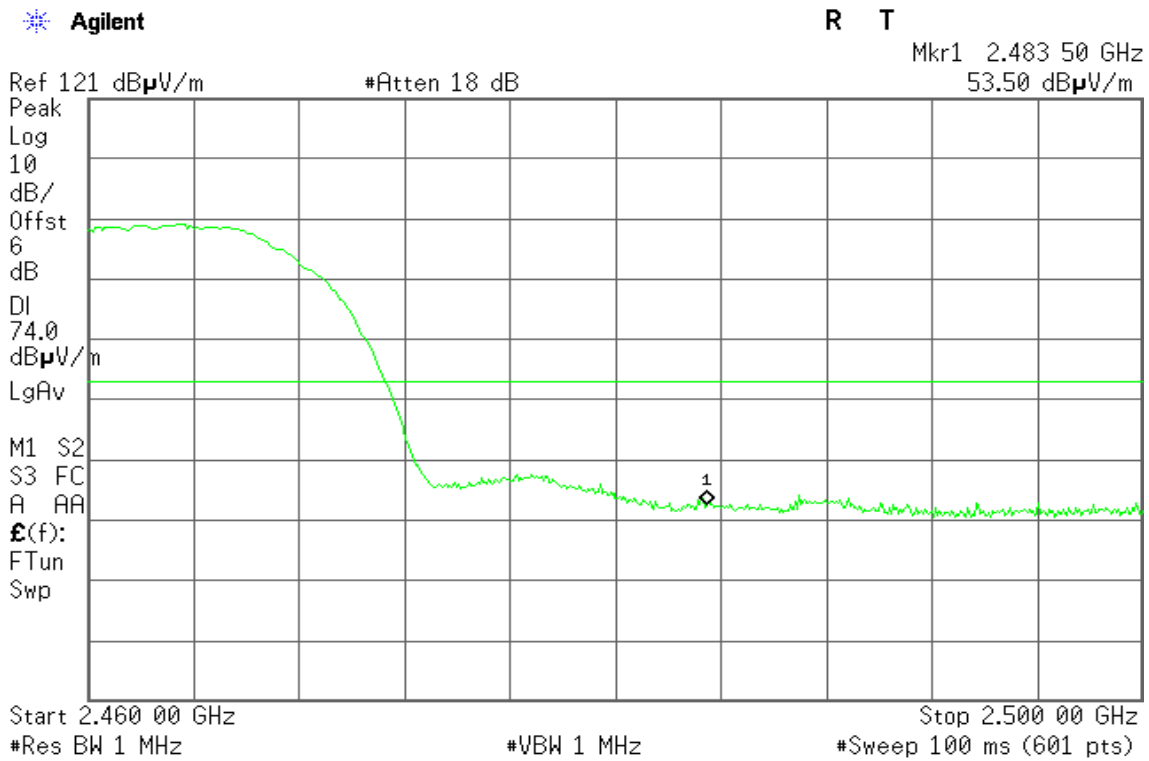

Detector mode: Average

Polarity: Vertical

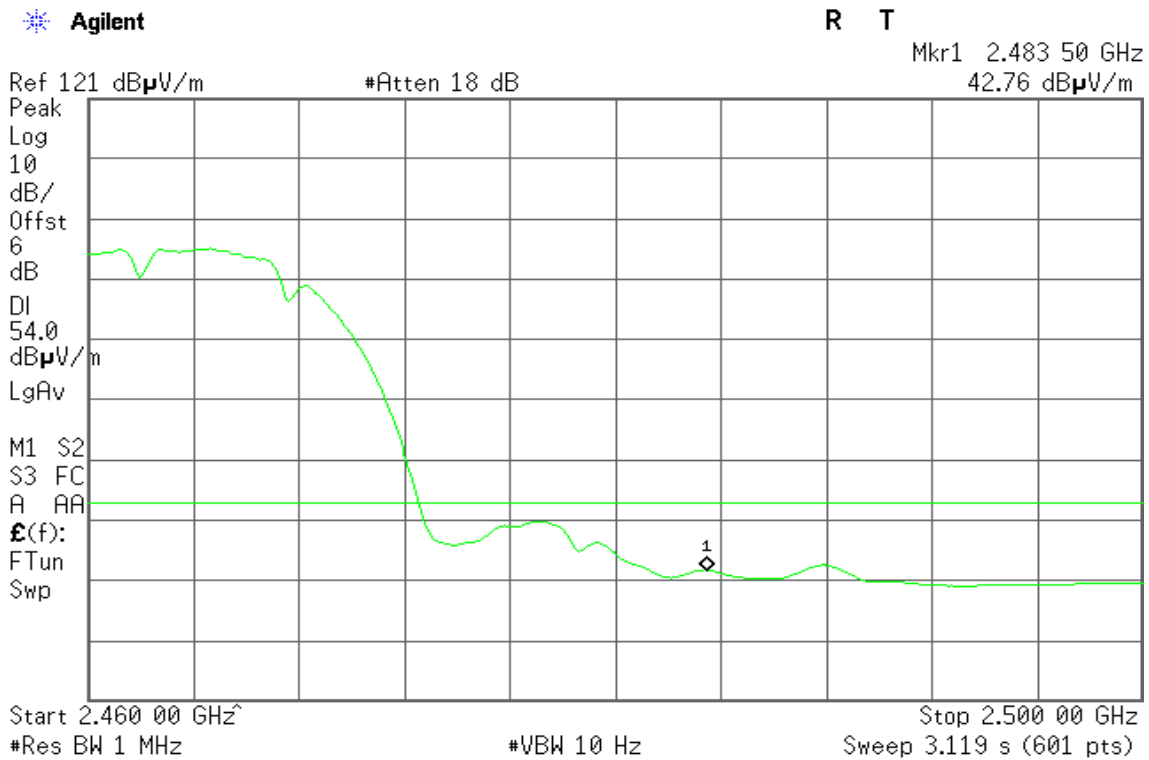



**Detector mode: Peak**

**Polarity: Horizontal**

Agilent

R T

Mkr1 2.487 77 GHz  
61.79 dB $\mu$ V/m

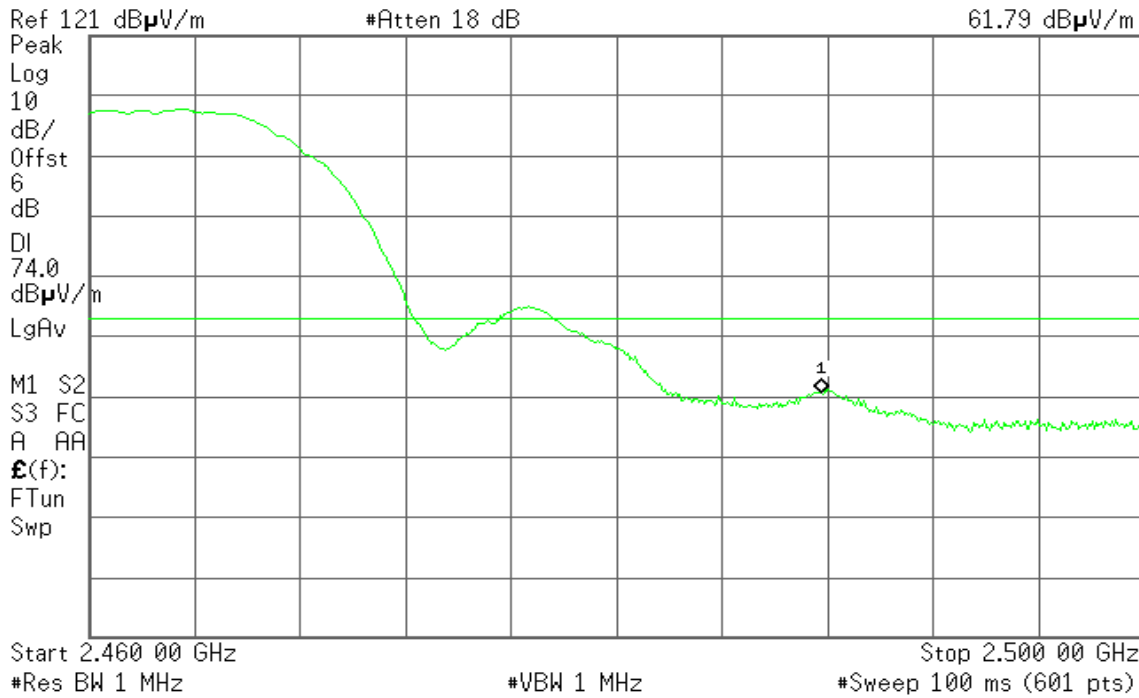

**Detector mode: Average**

**Polarity: Horizontal**

Agilent

R T

Mkr1 2.487 77 GHz  
53.76 dB $\mu$ V/m

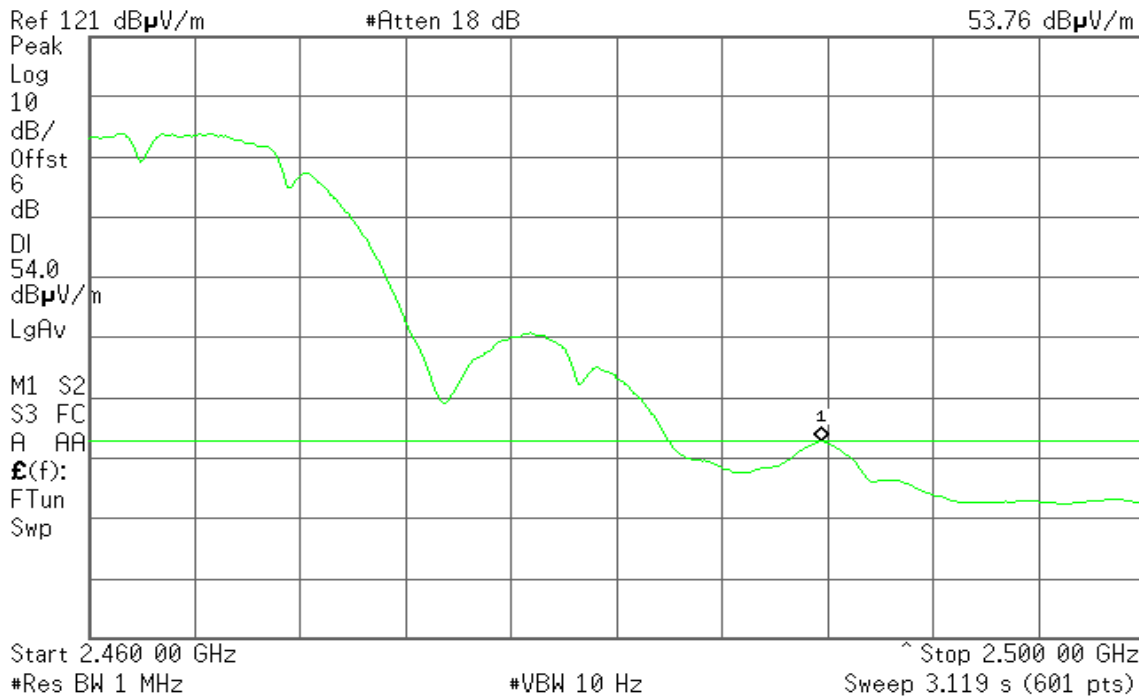



**Band Edges (IEEE 802.11g mode / CH Low)**

**Detector mode: Peak**

**Polarity: Vertical**

Agilent 19:26:23 Jul 15, 2011

R T

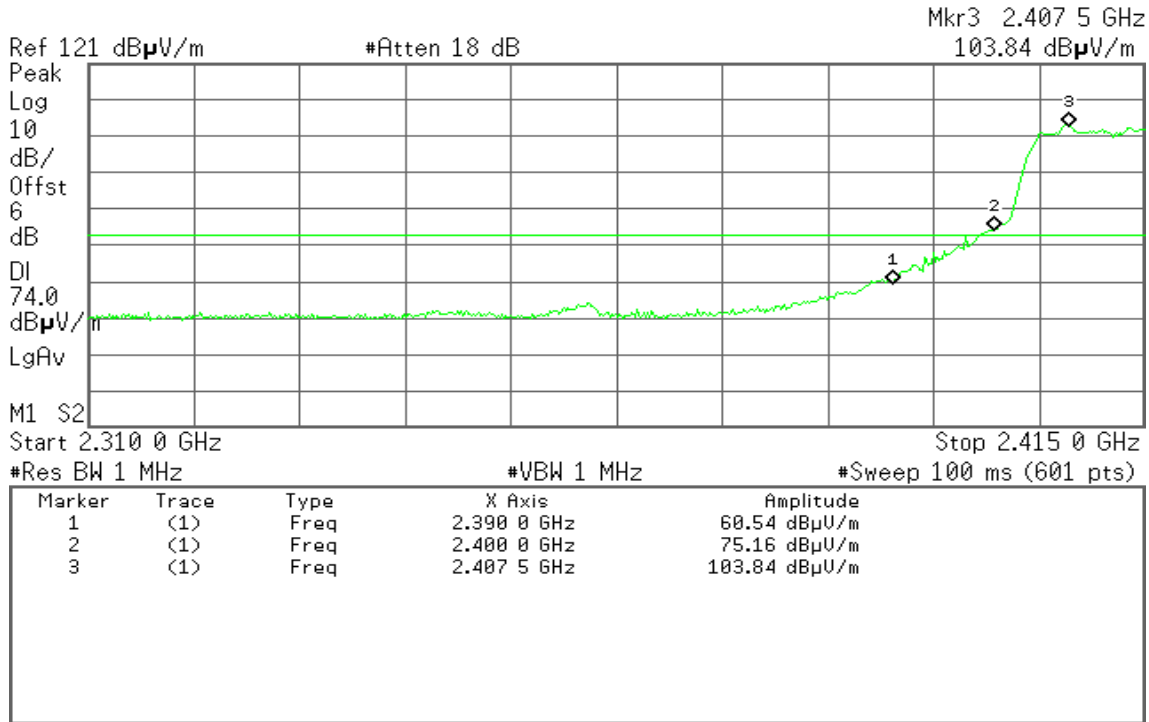

**Detector mode: Average**

**Polarity: Vertical**

Agilent 19:26:55 Jul 15, 2011

R T

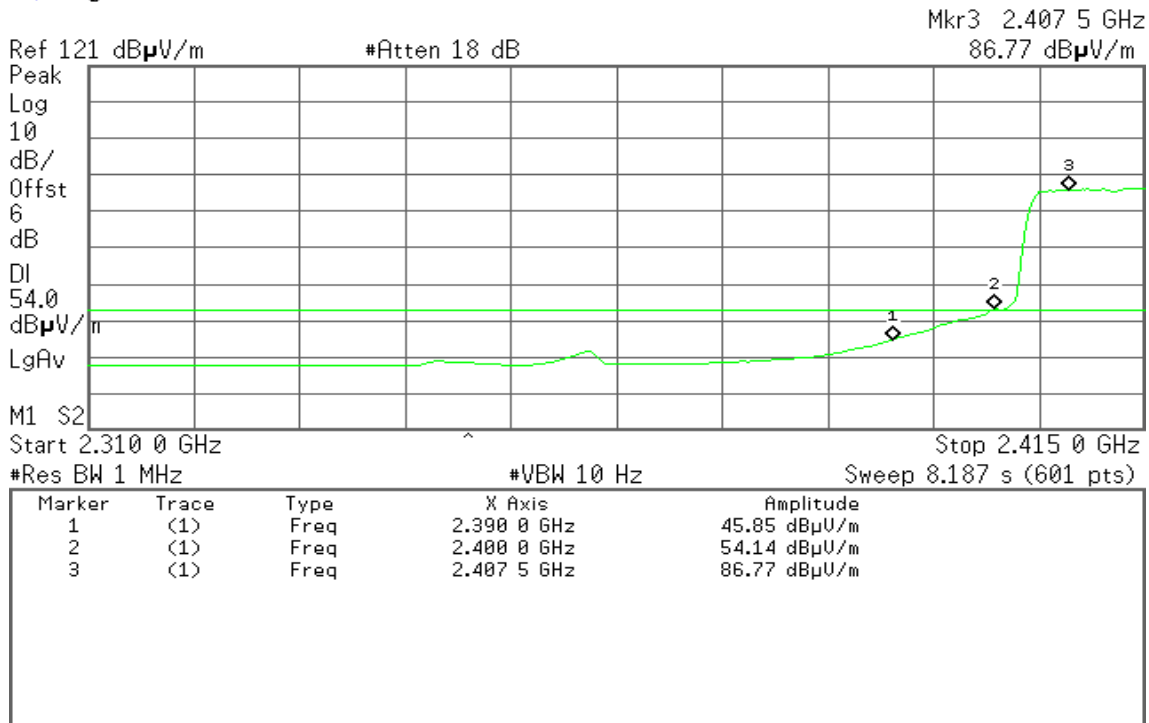



Detector mode: Peak

Polarity: Horizontal

Agilent 17:00:58 Jul 14, 2011

R T

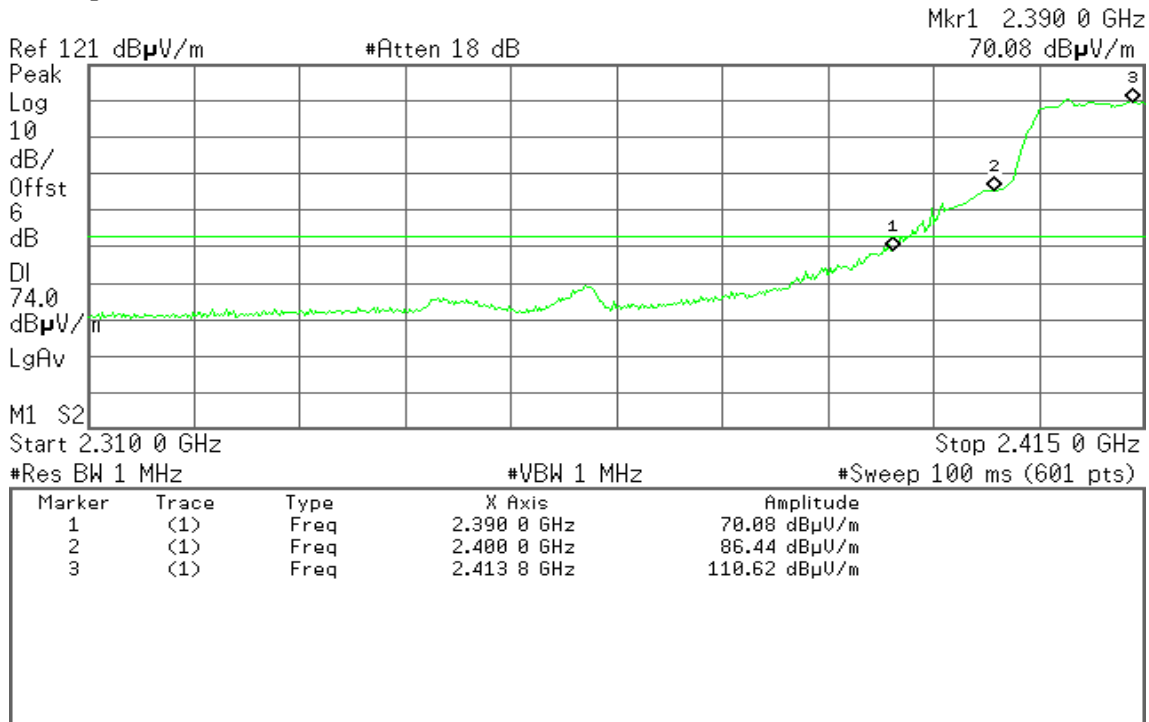

Detector mode: Average

Polarity: Horizontal

Agilent 17:00:00 Jul 14, 2011

R T

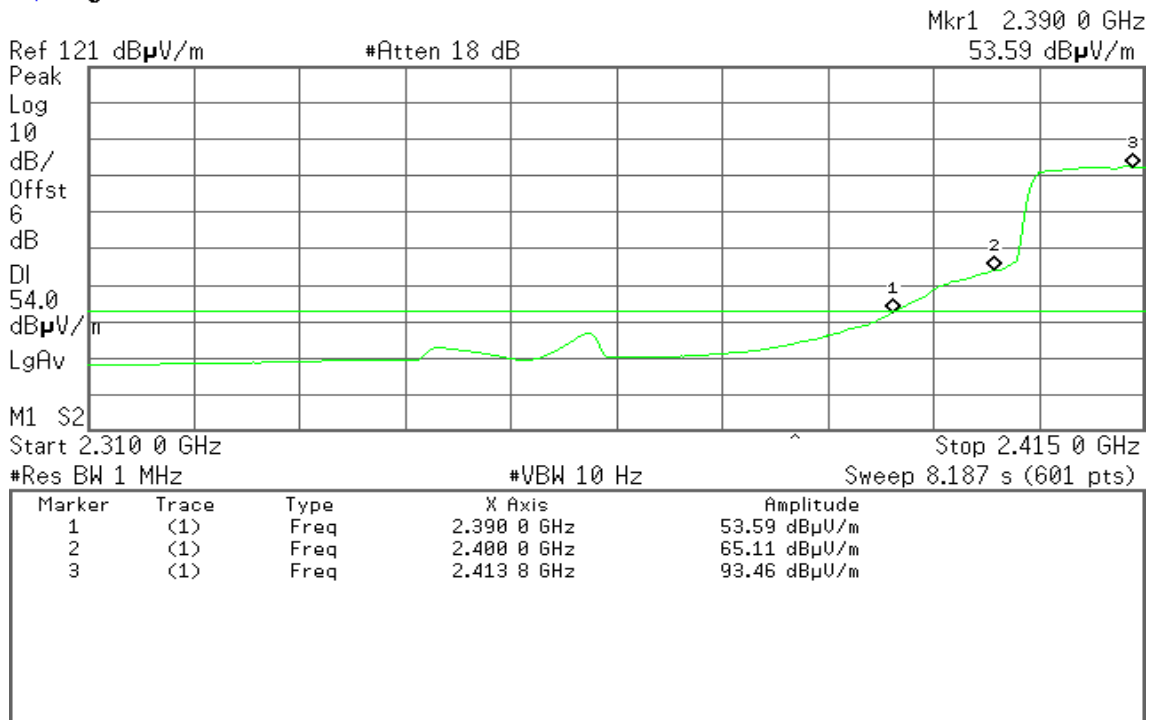



**Band Edges (IEEE 802.11g mode / CH High)**

**Detector mode: Peak**

**Polarity: Vertical**

Agilent

R T

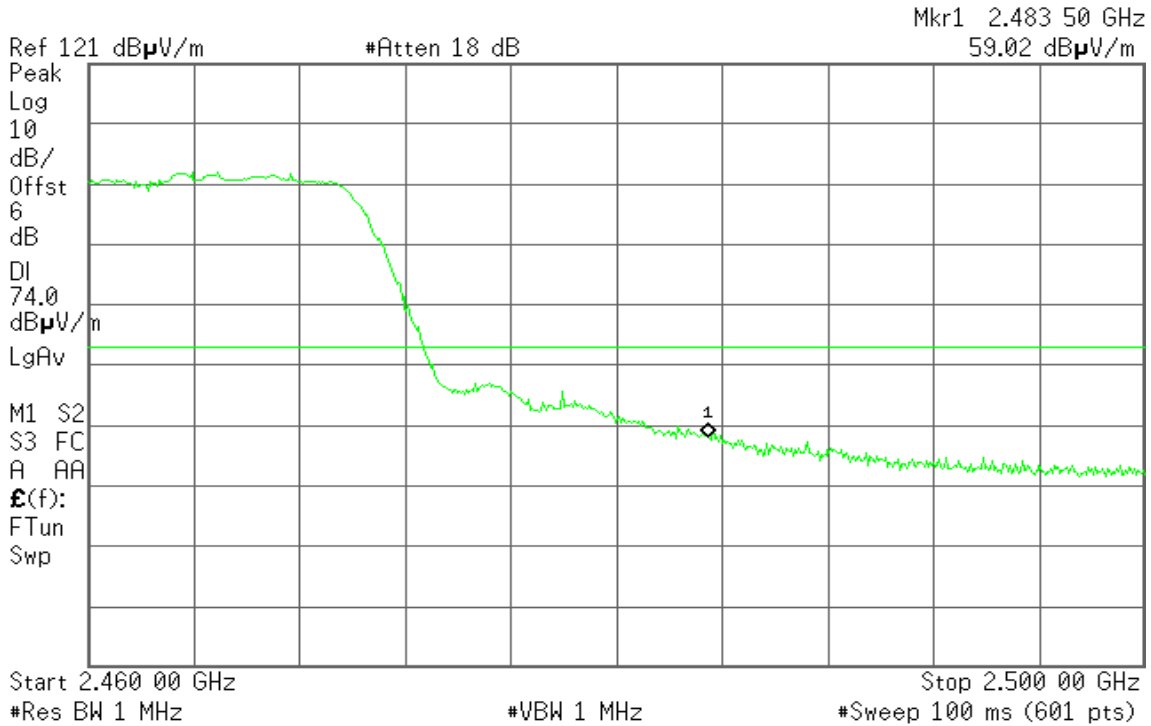

**Detector mode: Average**

**Polarity: Vertical**

Agilent

R T

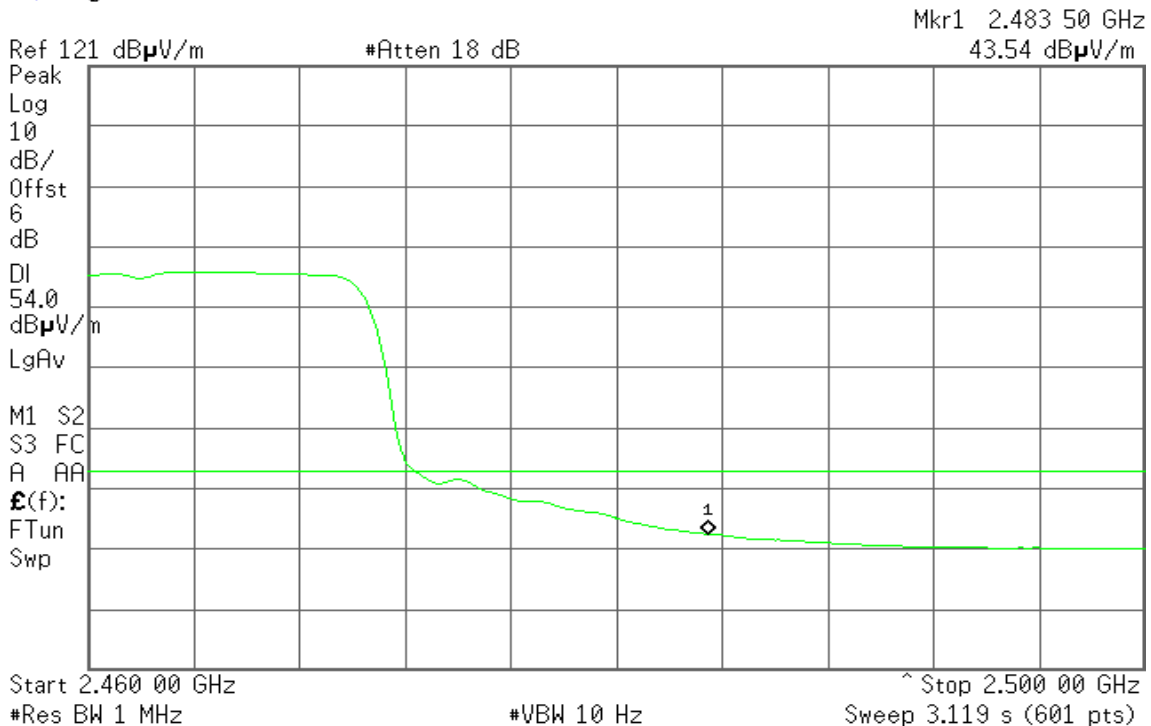





Detector mode: Peak

Polarity: Horizontal

Agilent

R T

Mkr1 2.484 43 GHz  
72.08 dB $\mu$ V/m

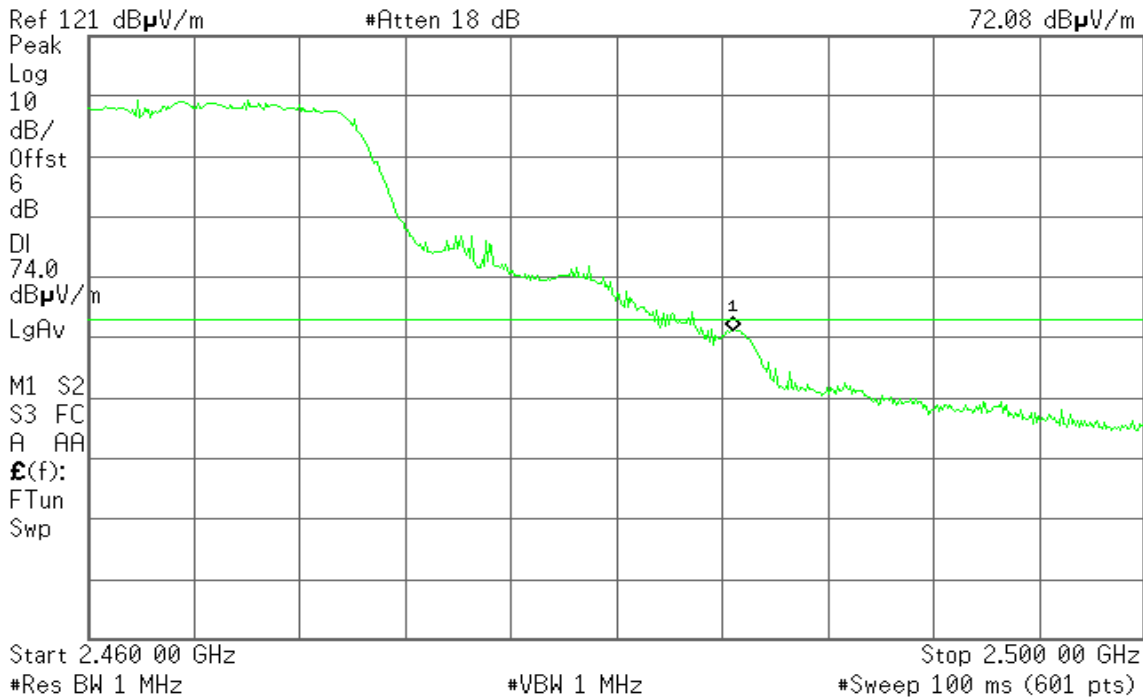

Detector mode: Average

Polarity: Horizontal

Agilent

R T

Mkr1 2.483 50 GHz  
52.47 dB $\mu$ V/m

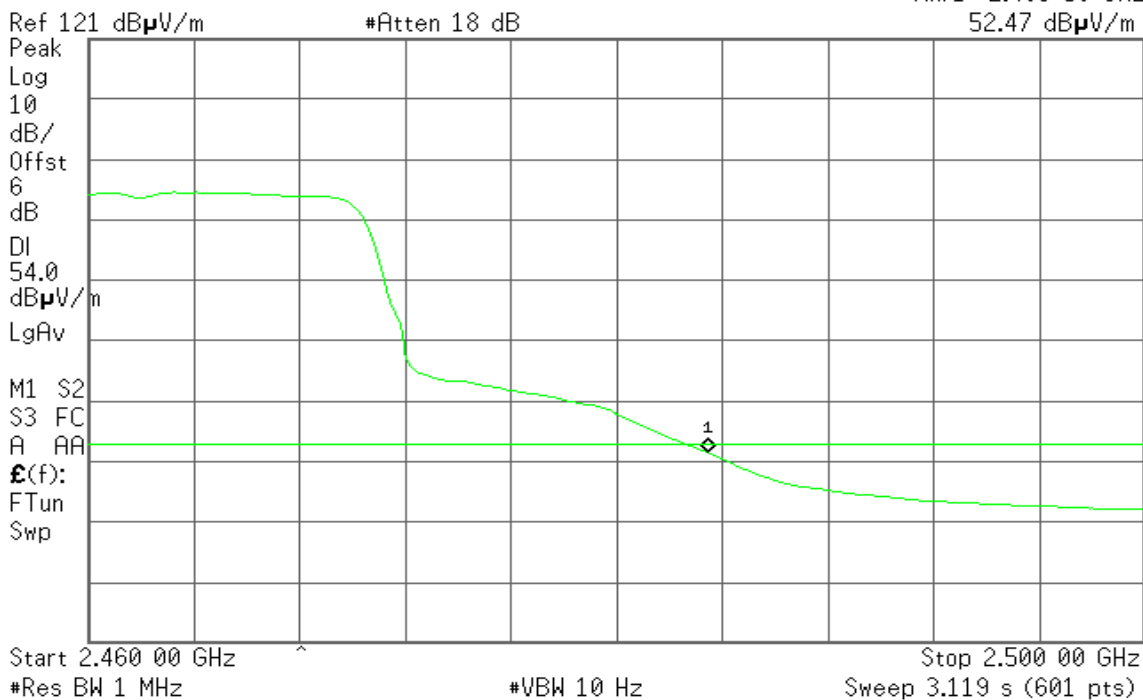



**Band Edges (IEEE 802.11n HT 20 MHz mode / CH Low)**

**Detector mode: Peak**

**Polarity: Vertical**

Agilent 20:03:06 Jul 15, 2011

T

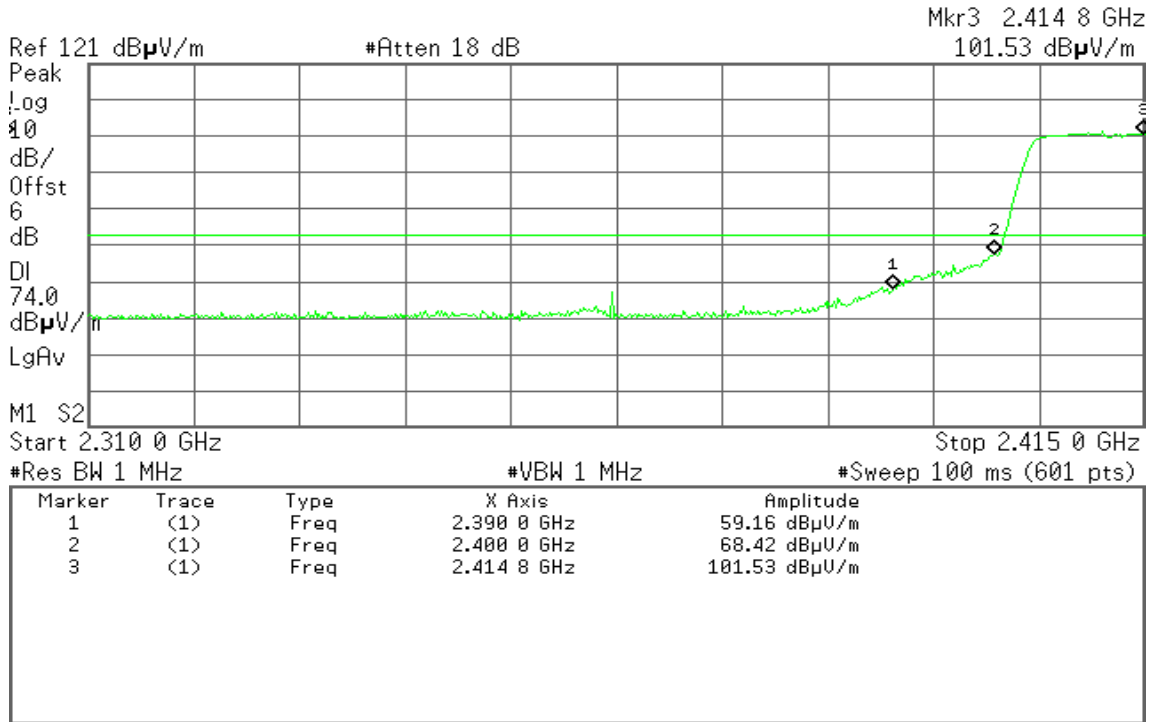

**Detector mode: Average**

**Polarity: Vertical**

Agilent 20:03:38 Jul 15, 2011

T

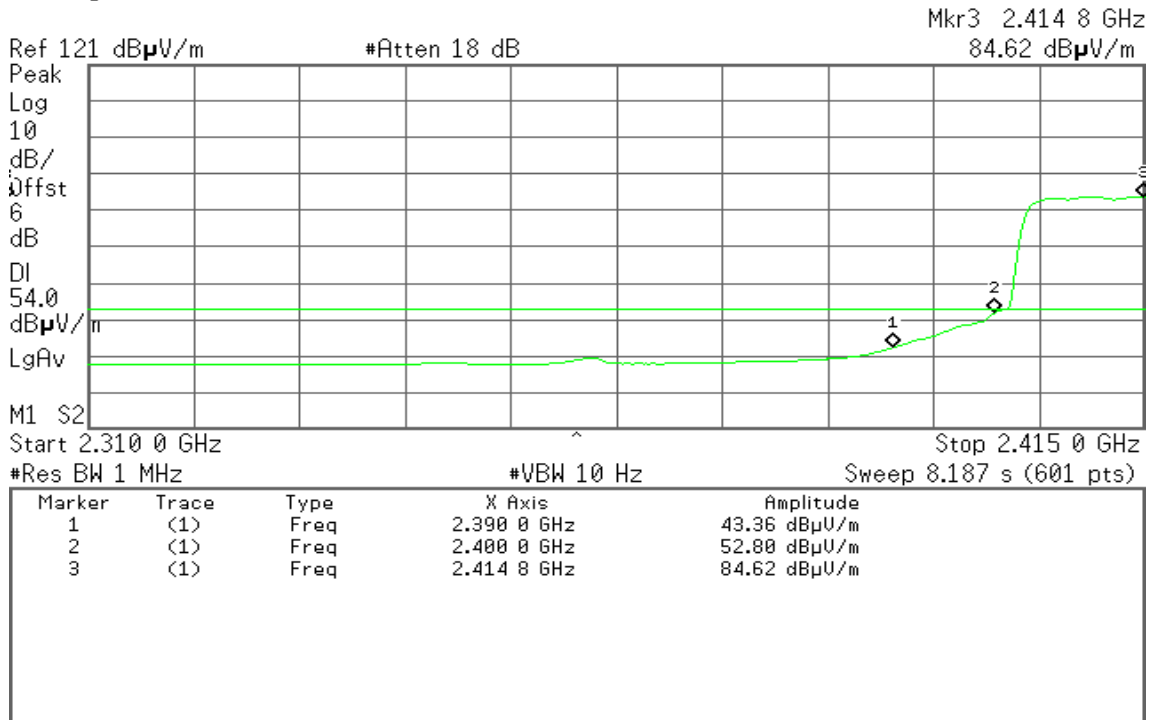



Detector mode: Peak

Polarity: Horizontal

Agilent 17:14:52 Jul 14, 2011

R T

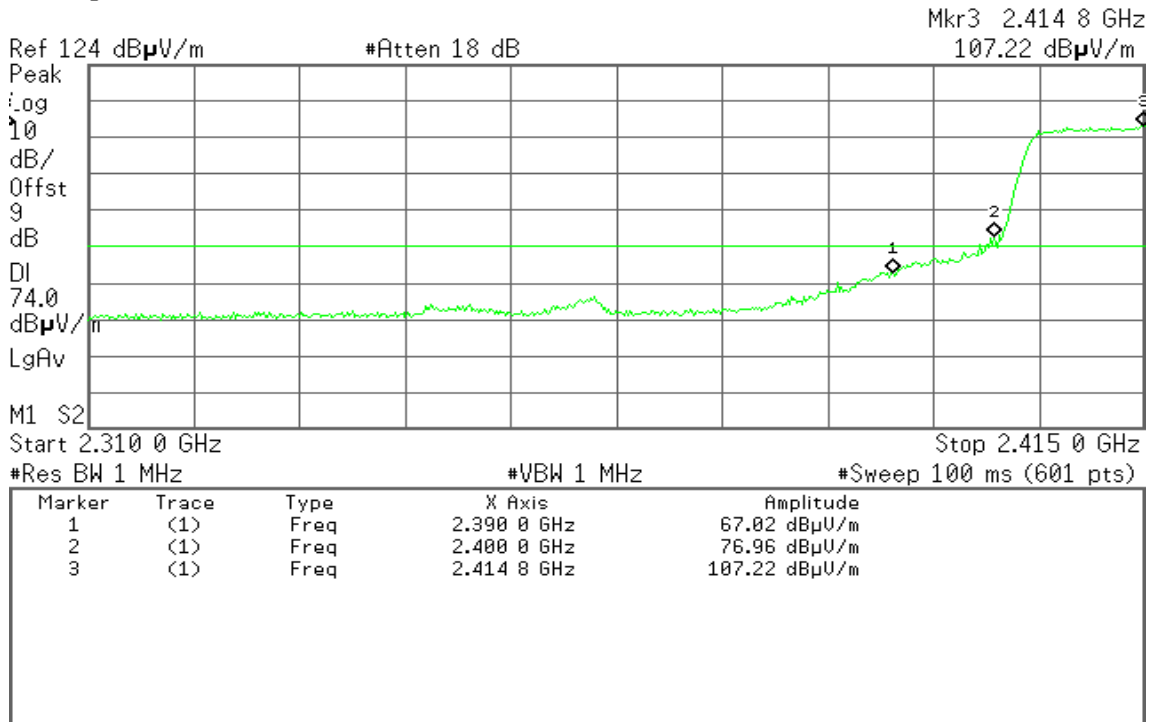

Detector mode: Average

Polarity: Horizontal

Agilent 17:15:29 Jul 14, 2011

R T

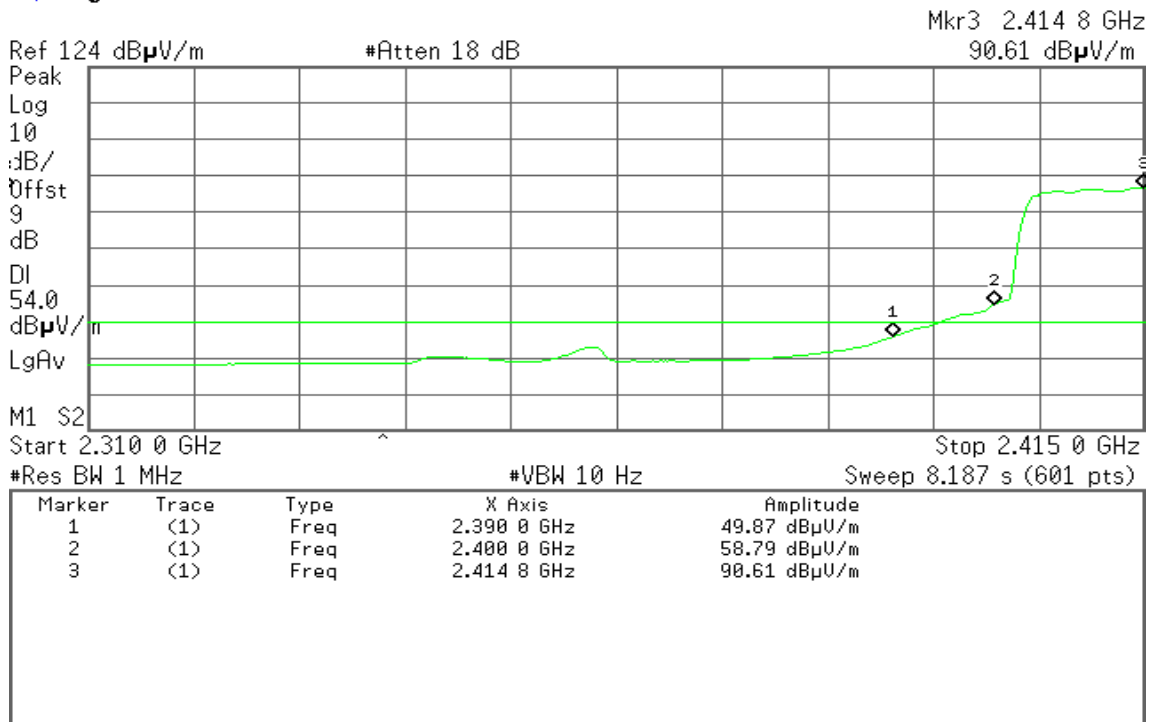



**Band Edges (IEEE 802.11n HT 20 MHz mode / CH High)**

**Detector mode: Peak**

**Polarity: Vertical**

Agilent 20:33:40 Jul 15, 2011

R T

Mkr1 2.483 50 GHz  
59.91 dB $\mu$ V/m

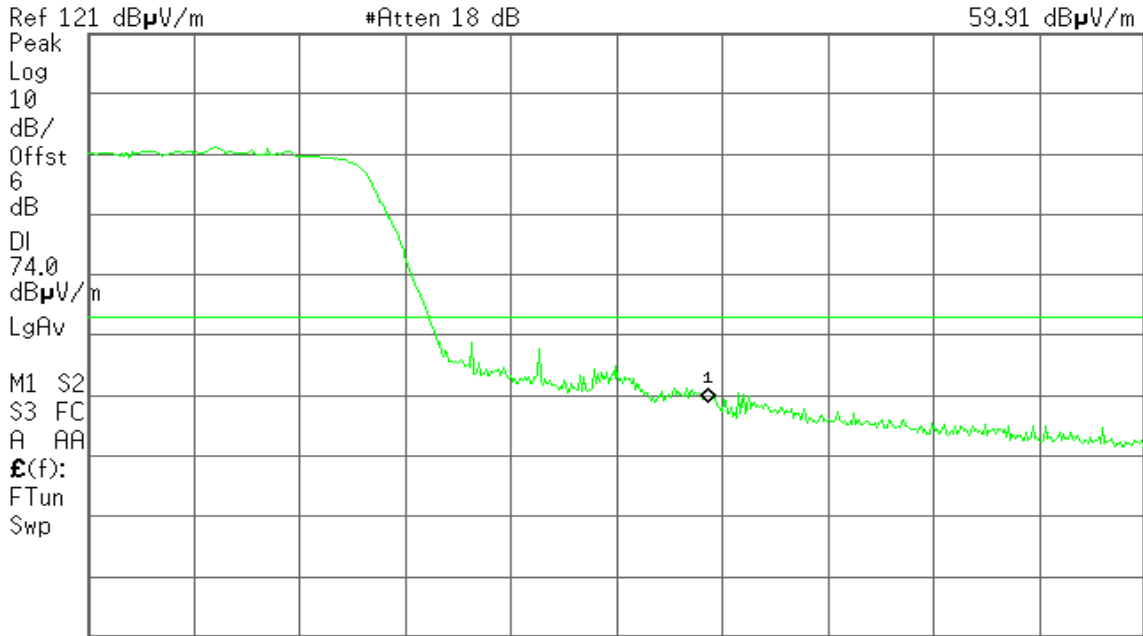

Start 2.460 00 GHz Stop 2.500 00 GHz  
#Res BW 1 MHz #VBW 1 MHz #Sweep 100 ms (601 pts)

**Detector mode: Average**

**Polarity: Vertical**

Agilent 17:21:27 Jul 14, 2011

R T

Mkr1 2.483 50 GHz  
45.45 dB $\mu$ V/m

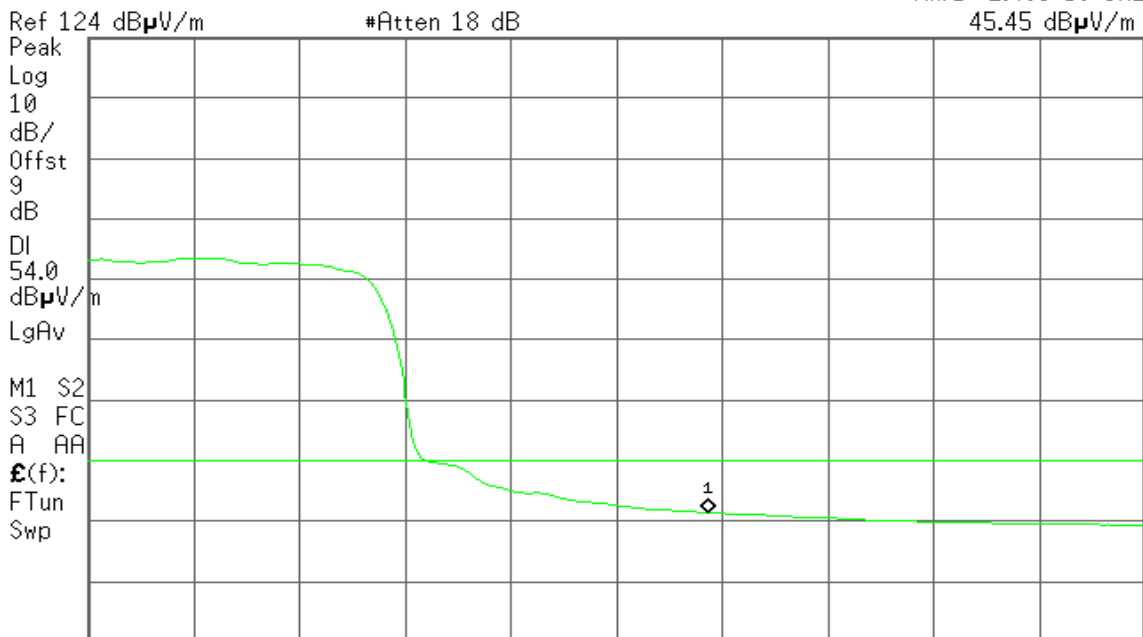

Start 2.460 00 GHz Stop 2.500 00 GHz  
#Res BW 1 MHz #VBW 10 Hz Sweep 3.119 s (601 pts)



Detector mode: Peak

Polarity: Horizontal

Agilent 17:34:56 Jul 14, 2011

R T

Mkr1 2.483 50 GHz  
66.62 dB $\mu$ V/m

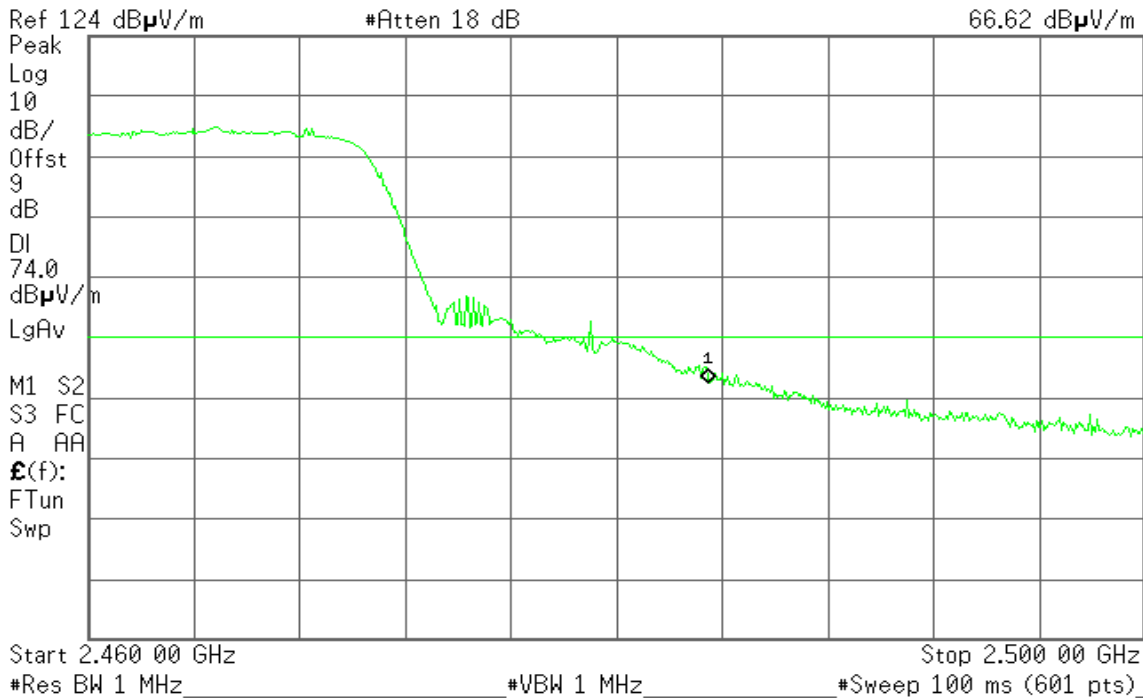

Detector mode: Average

Polarity: Horizontal

Agilent 17:35:24 Jul 14, 2011

R T

Mkr1 2.483 50 GHz  
50.42 dB $\mu$ V/m

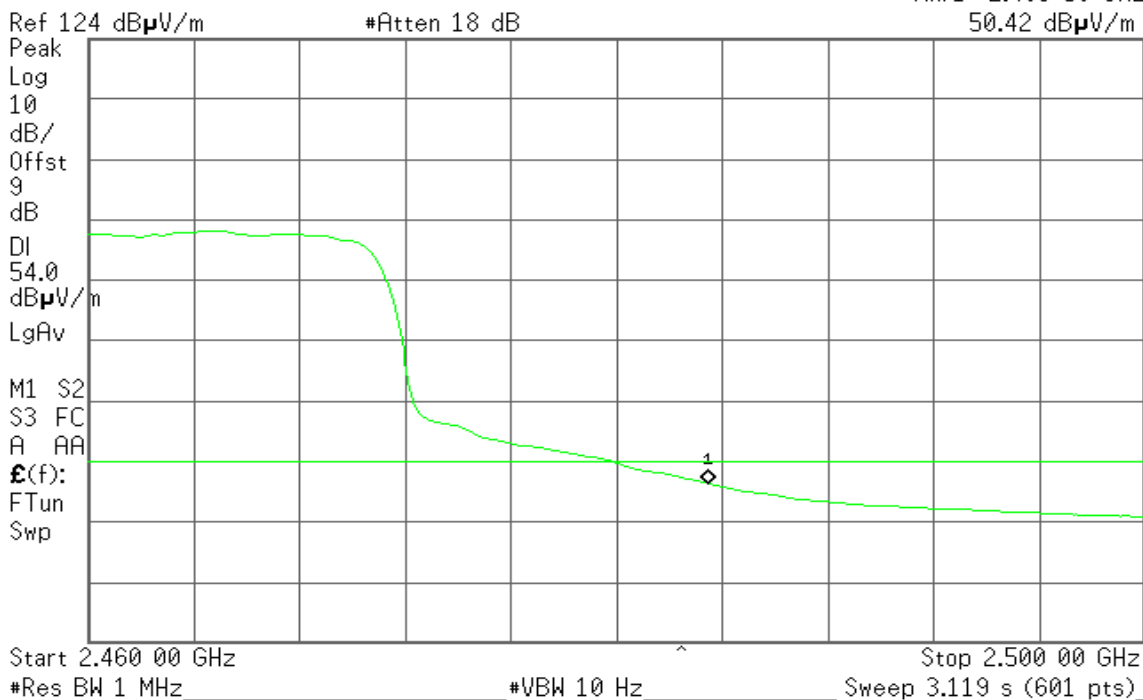



**Band Edges (IEEE 802.11n HT 40 MHz mode / CH Low)**

**Detector mode: Peak**

**Polarity: Vertical**

Agilent 11:00:46 Jul 14, 2011

R T

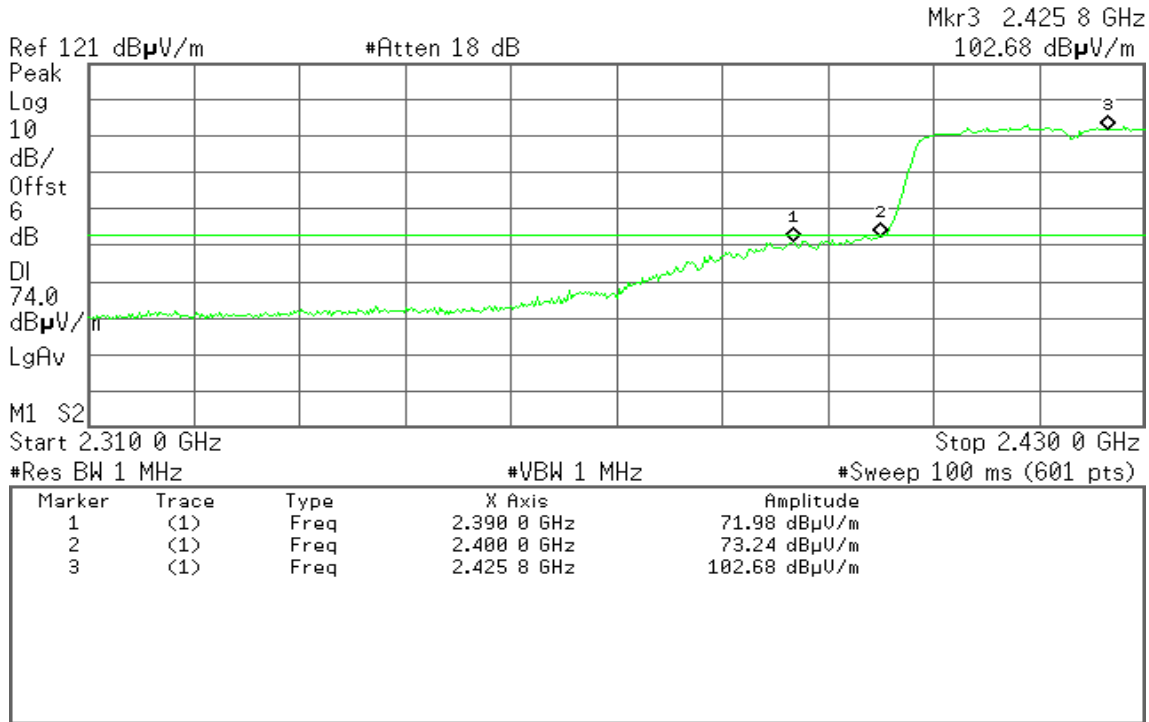

**Detector mode: Average**

**Polarity: Vertical**

Agilent 11:01:31 Jul 14, 2011

R T

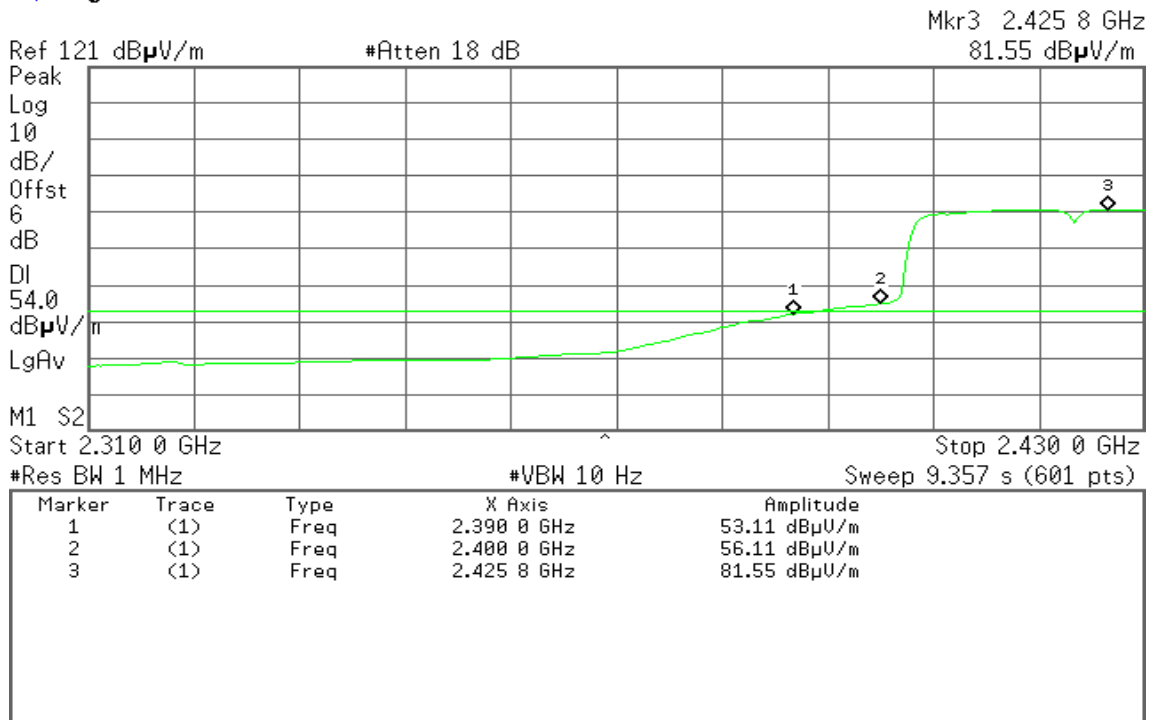



Detector mode: Peak

Polarity: Horizontal

Agilent 10:55:07 Jul 14, 2011

R T

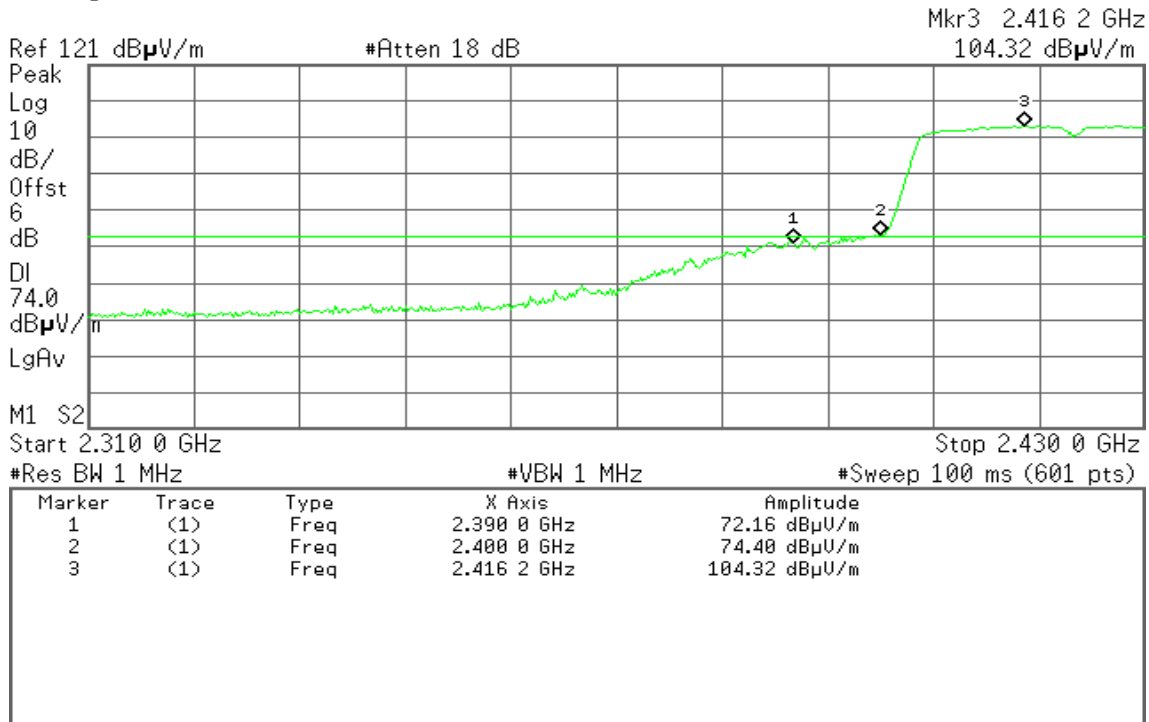

Detector mode: Average

Polarity: Horizontal

Agilent 10:53:18 Jul 14, 2011

R T

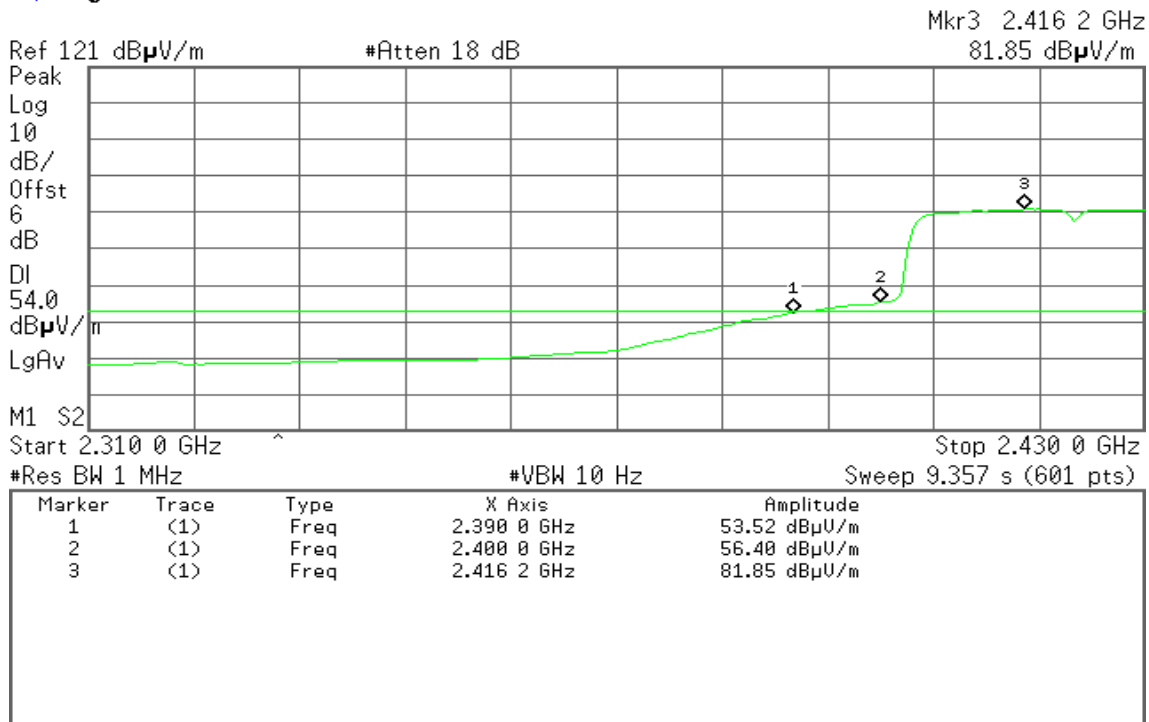



**Band Edges (IEEE 802.11n HT 40 MHz mode / CH High)**

**Detector mode: Peak**

**Polarity: Vertical**

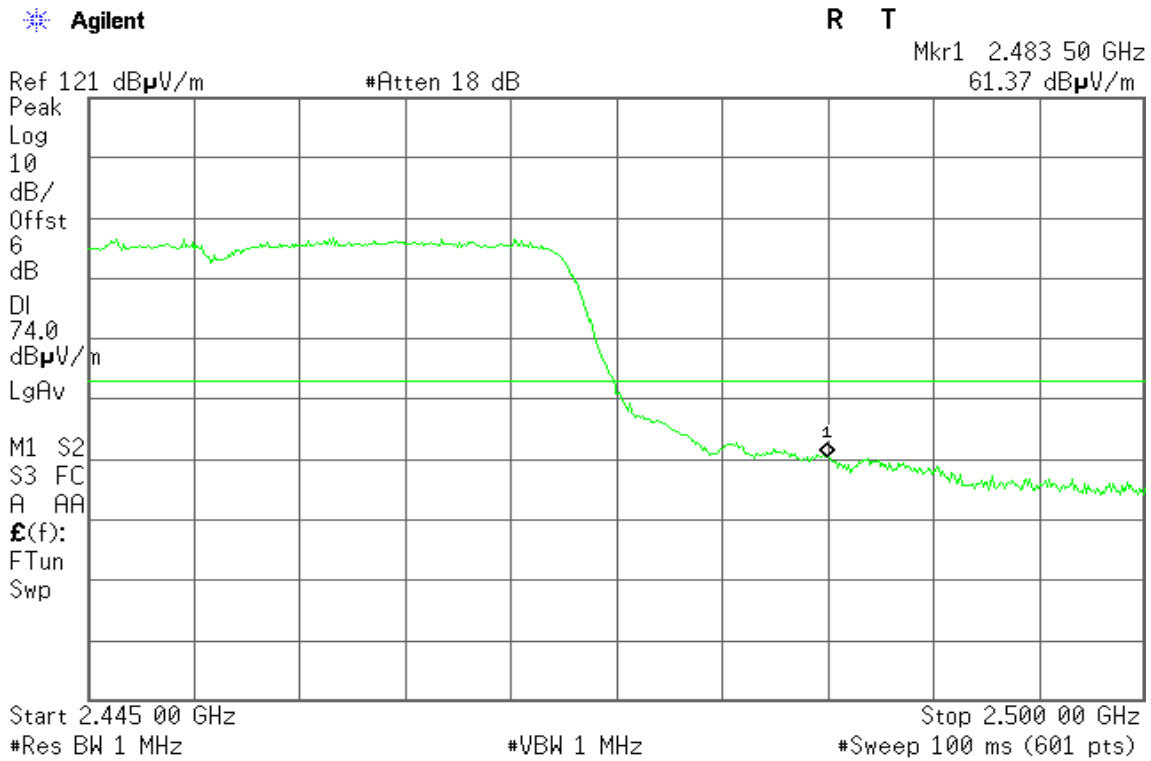

**Detector mode: Average**

**Polarity: Vertical**

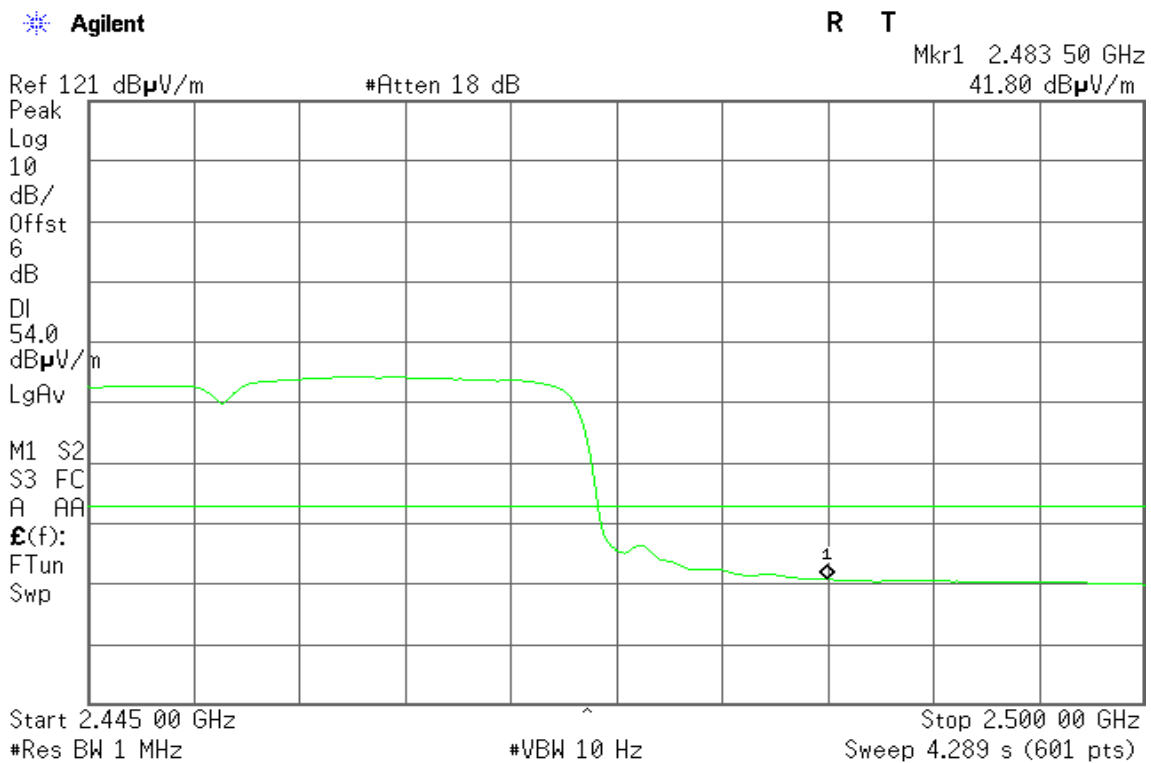





Detector mode: Peak

Polarity: Horizontal

Agilent

R T

Mkr1 2.484 51 GHz  
72.50 dB $\mu$ V/m

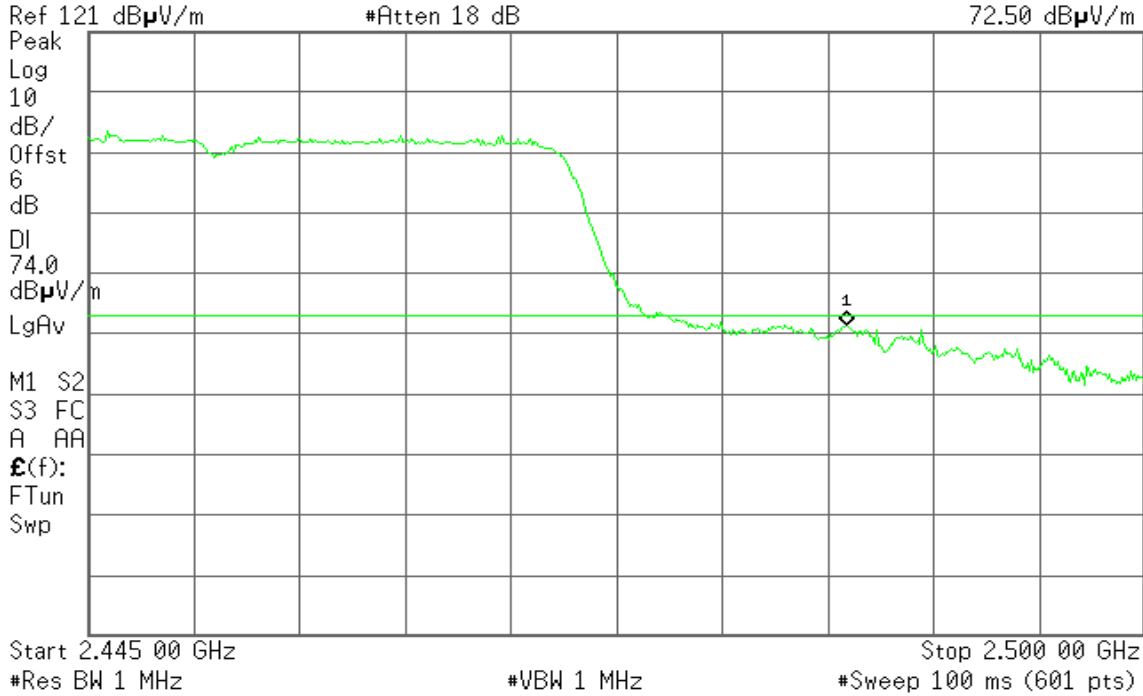

Detector mode: Average

Polarity: Horizontal

Agilent

R T

Mkr1 2.483 50 GHz  
53.01 dB $\mu$ V/m

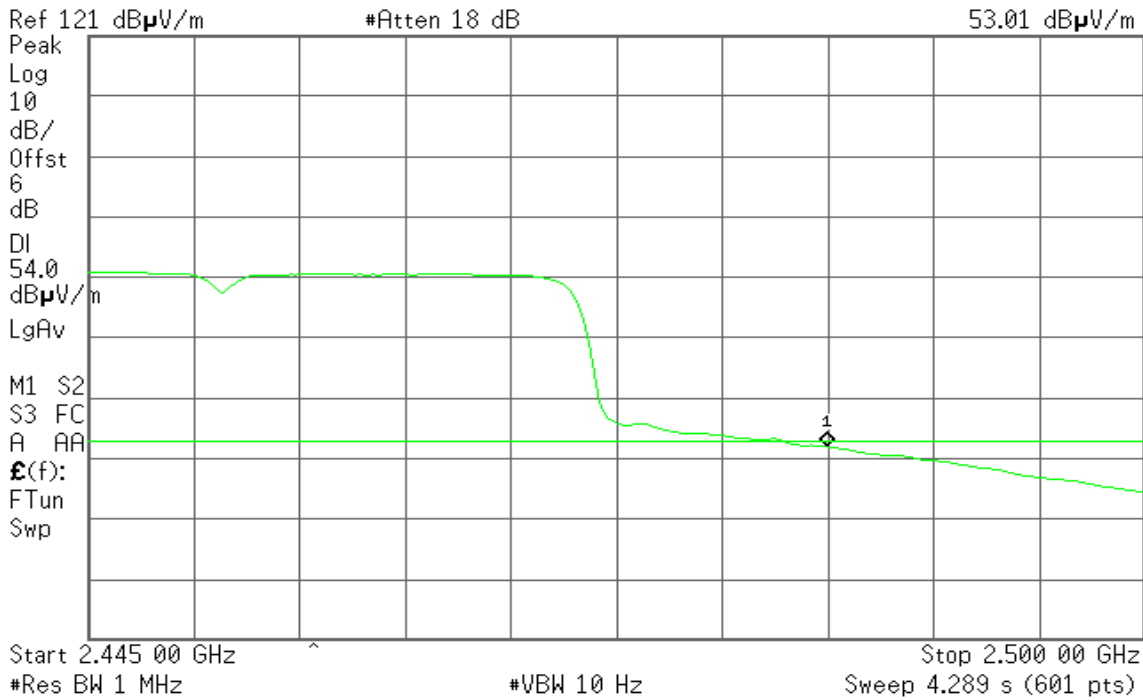



## 7.5 PEAK POWER SPECTRAL DENSITY

### LIMIT

1. According to §15.247(e), for digitally modulated systems, the power spectral density conducted from the intentional radiator to the antenna shall not be greater than 8 dBm in any 3 kHz band during any time interval of continuous transmission.
2. According to §15.247(f), the digital modulation operation of the hybrid system, with the frequency hopping turned off, shall comply with the power density requirements of paragraph (d) of this section.

### Test Configuration

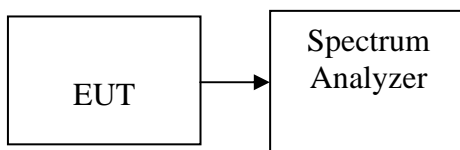

### TEST PROCEDURE

1. Place the EUT on the table and set it in transmitting mode.  
Remove the antenna from the EUT and then connect a low loss RF cable from the antenna port to the spectrum analyzer.
2. Set the spectrum analyzer as RBW = 3 kHz, VBW = 10 kHz, Span = 300 kHz, Sweep time = 100 s
3. Record the max reading.
4. Repeat the above procedure until the measurements for all frequencies are completed.



## **TEST RESULTS**

*No non-compliance noted*

### **Test Data**

#### **Test mode: IEEE 802.11b mode**

Channel	Frequency (MHz)	PPSD (dBm)	Limit (dBm)	Result
Low	2412	0.73	8.00	PASS
Mid	2442	4.36		PASS
High	2462	1.06		PASS

#### **Test mode: IEEE 802.11g mode**

Channel	Frequency (MHz)	PPSD (dBm)	Limit (dBm)	Result
Low	2412	-15.07	8.00	PASS
Mid	2442	-15.35		PASS
High	2462	-19.09		PASS

#### **Test mode: IEEE 802.11n HT 20 MHz mode**

Channel	Frequency (MHz)	PPSD (dBm)	Limit (dBm)	Result
Low	2412	-12.34	8.00	PASS
Mid	2442	-11.22		PASS
High	2462	-11.94		PASS

#### **Test mode: IEEE 802.11n HT 40 MHz mode**

Channel	Frequency (MHz)	PPSD (dBm)	Limit (dBm)	Result
Low	2422	-16.04	8.00	PASS
Mid	2442	-15.85		PASS
High	2452	-17.22		PASS



### Test Plot

IEEE 802.11b mode

PPSD (CH Low)



No.	Frequency(MHz)	Level(dBm)	Limit(dBm)	Margin(dBm)
1	2411.2461	0.73	8.00	-7.27



PPSD (CH Mid)

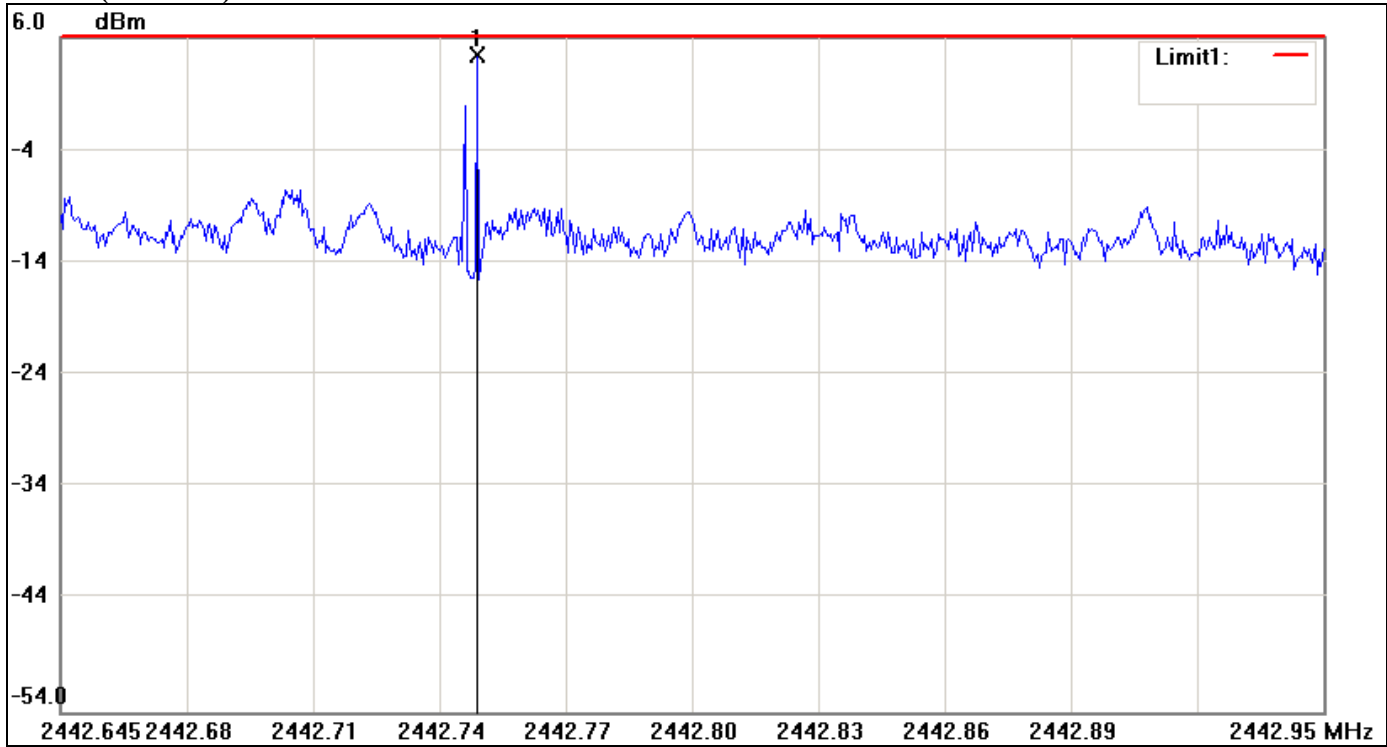

No.	Frequency(MHz)	Level(dBm)	Limit(dBm)	Margin(dBm)
1	2442.7442	4.36	8.00	-3.64



**PPSD (CH High)**

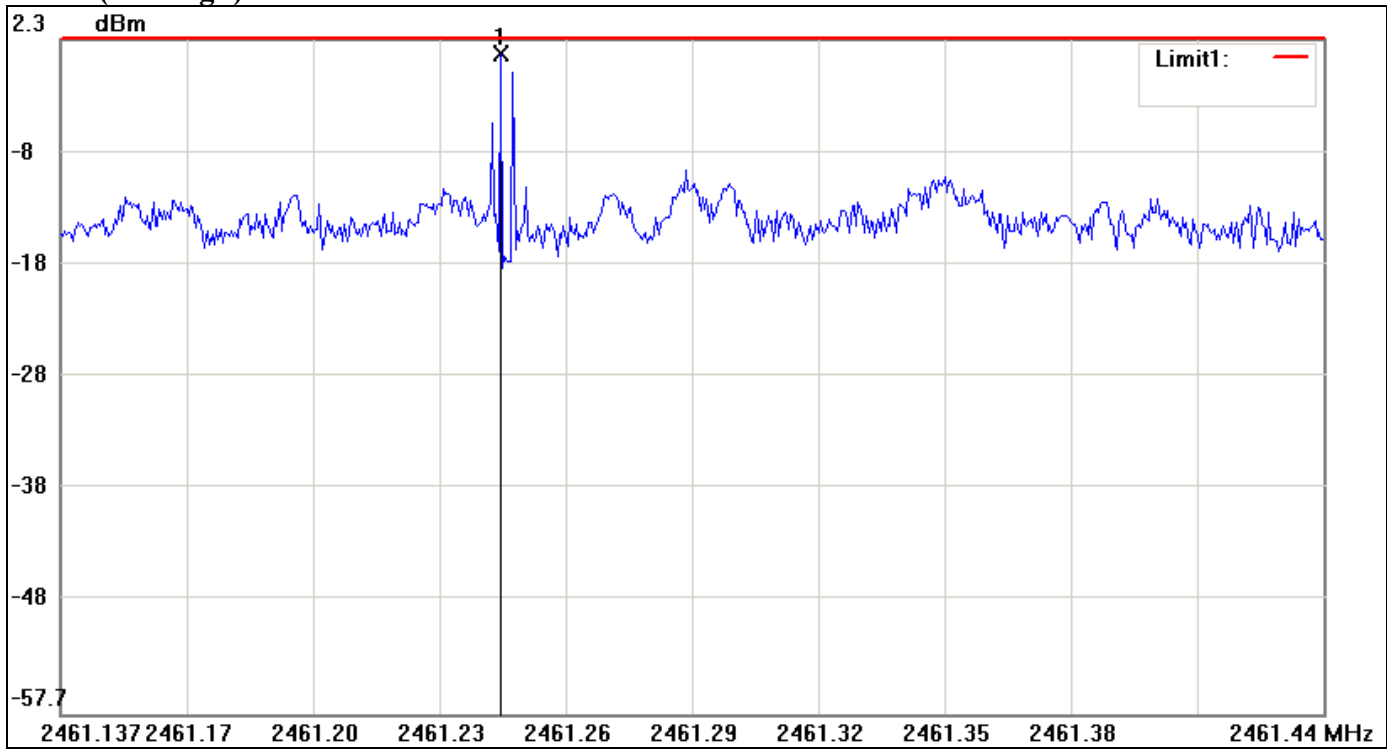

No.	Frequency(MHz)	Level(dBm)	Limit(dBm)	Margin(dBm)
1	2461.2416	1.06	8.00	-6.94



IEEE 802.11g mode

PPSD (CH Low)

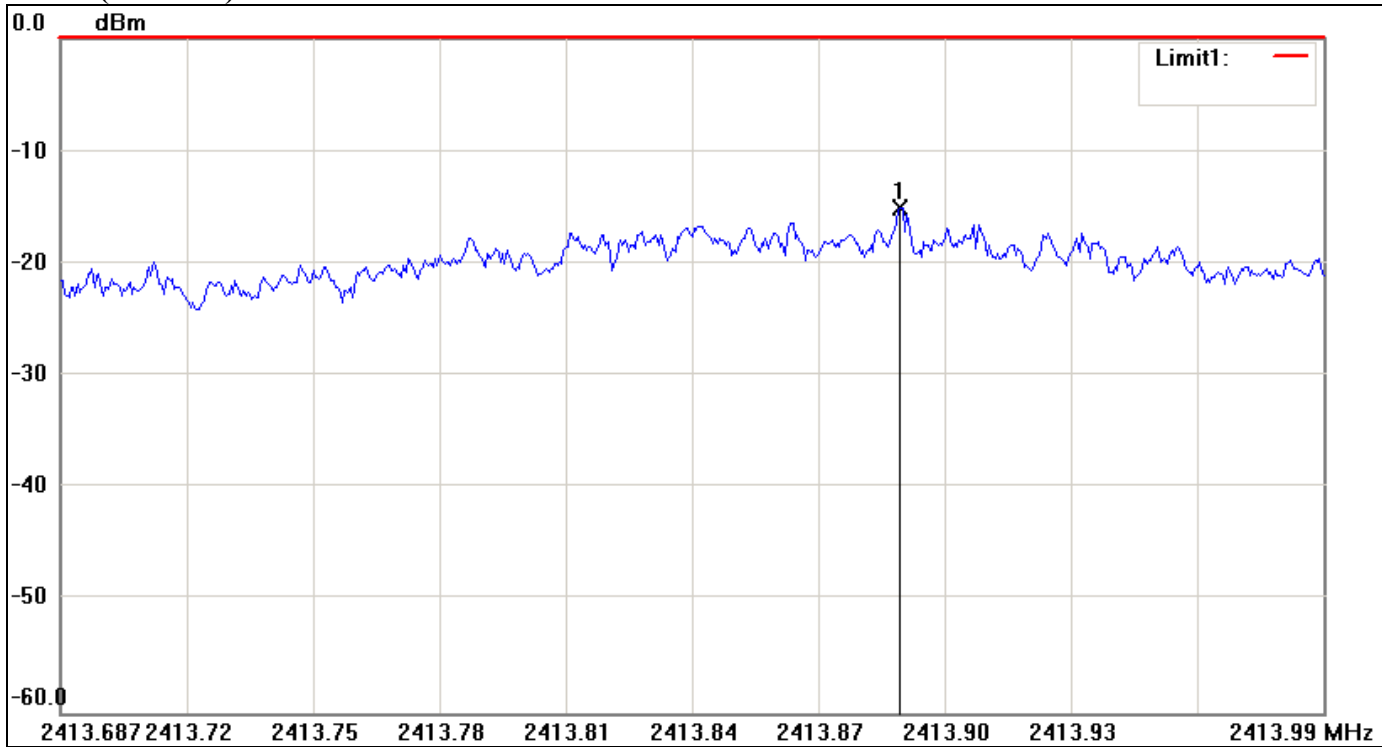

No.	Frequency(MHz)	Level(dBm)	Limit(dBm)	Margin(dBm)
1	2413.8863	-15.07	8.00	-23.07



**PPSD (CH Mid)**

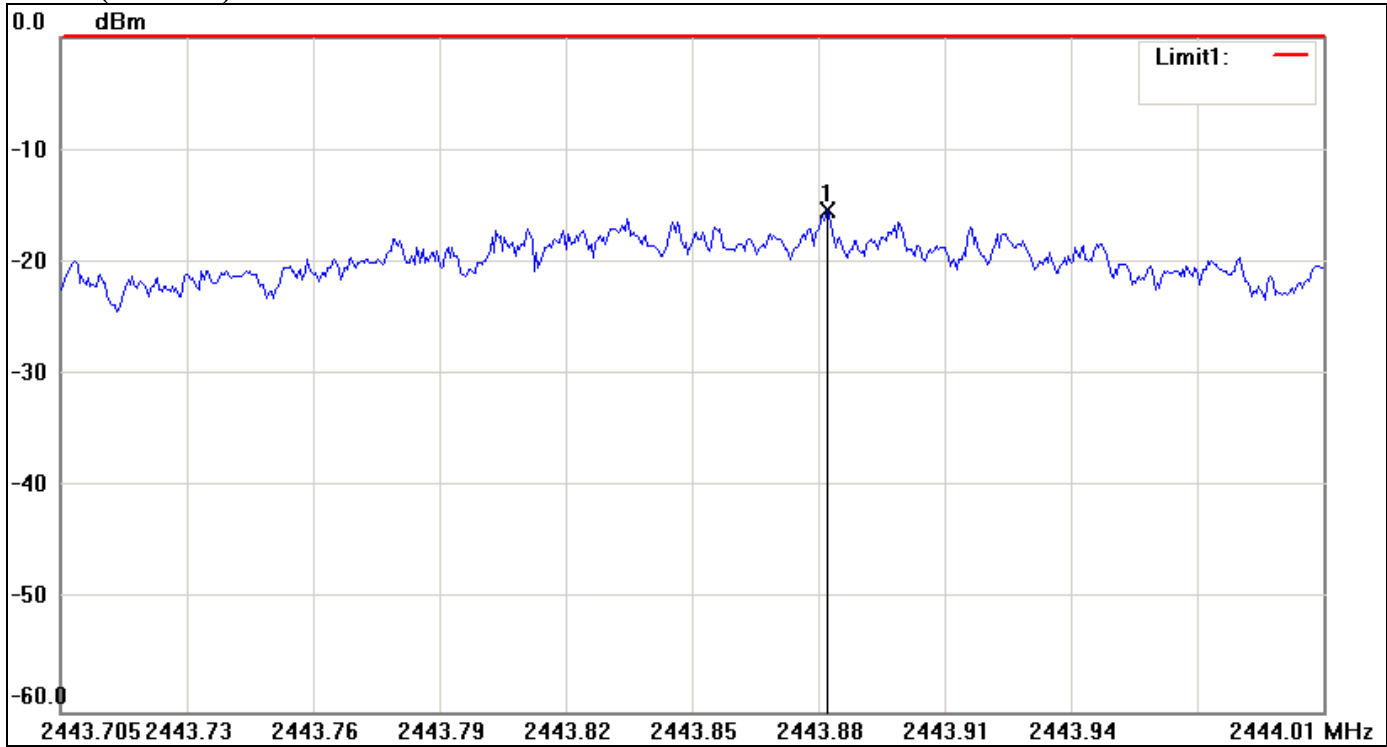

No.	Frequency(MHz)	Level(dBm)	Limit(dBm)	Margin(dBm)
1	2443.8866	-15.35	8.00	-23.35





### PPSD (CH High)

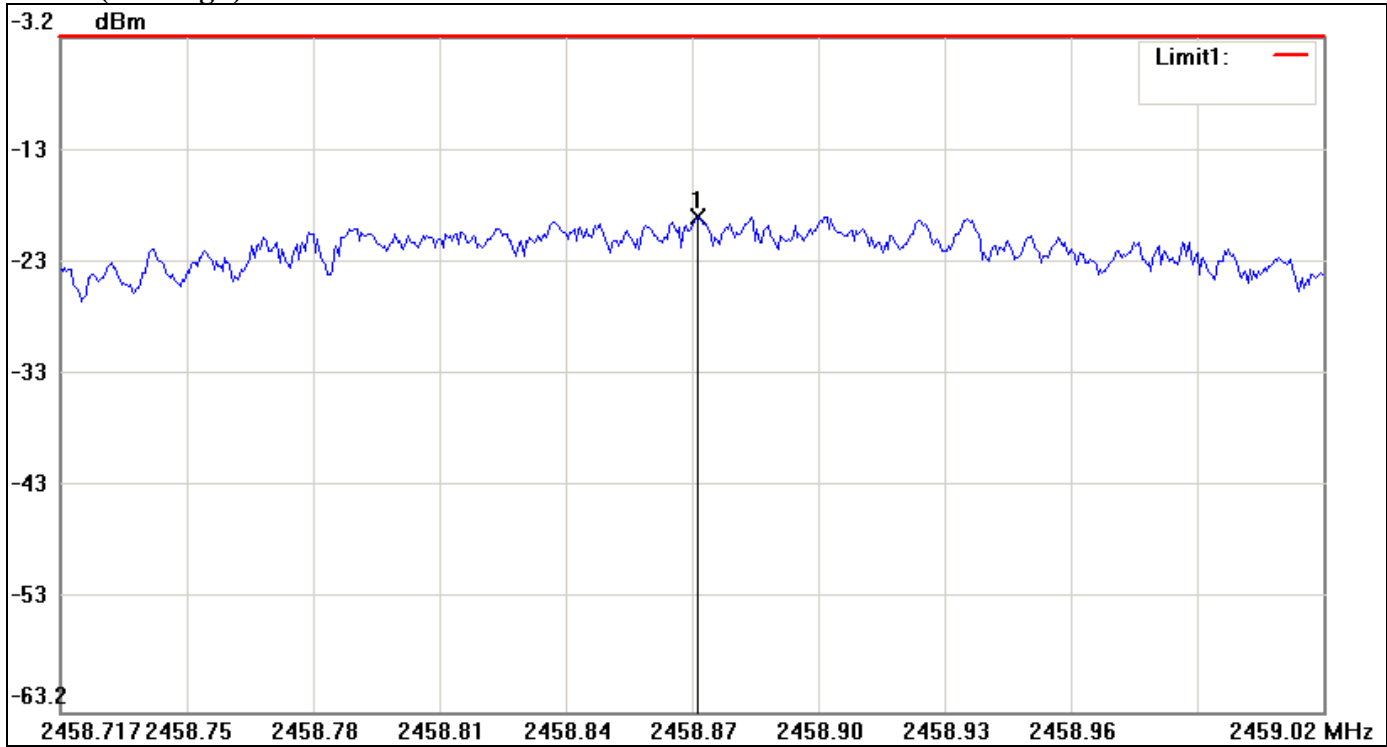

No.	Frequency(MHz)	Level(dBm)	Limit(dBm)	Margin(dBm)
1	2458.8680	-19.09	8.00	-27.09



### IEEE 802.11n HT 20 MHz mode

#### PPSD (CH Low)



No.	Frequency(MHz)	Level(dBm)	Limit(dBm)	Margin(dBm)
1	2408.2885	-12.34	8.00	-20.34



**PPSD (CH Mid)**

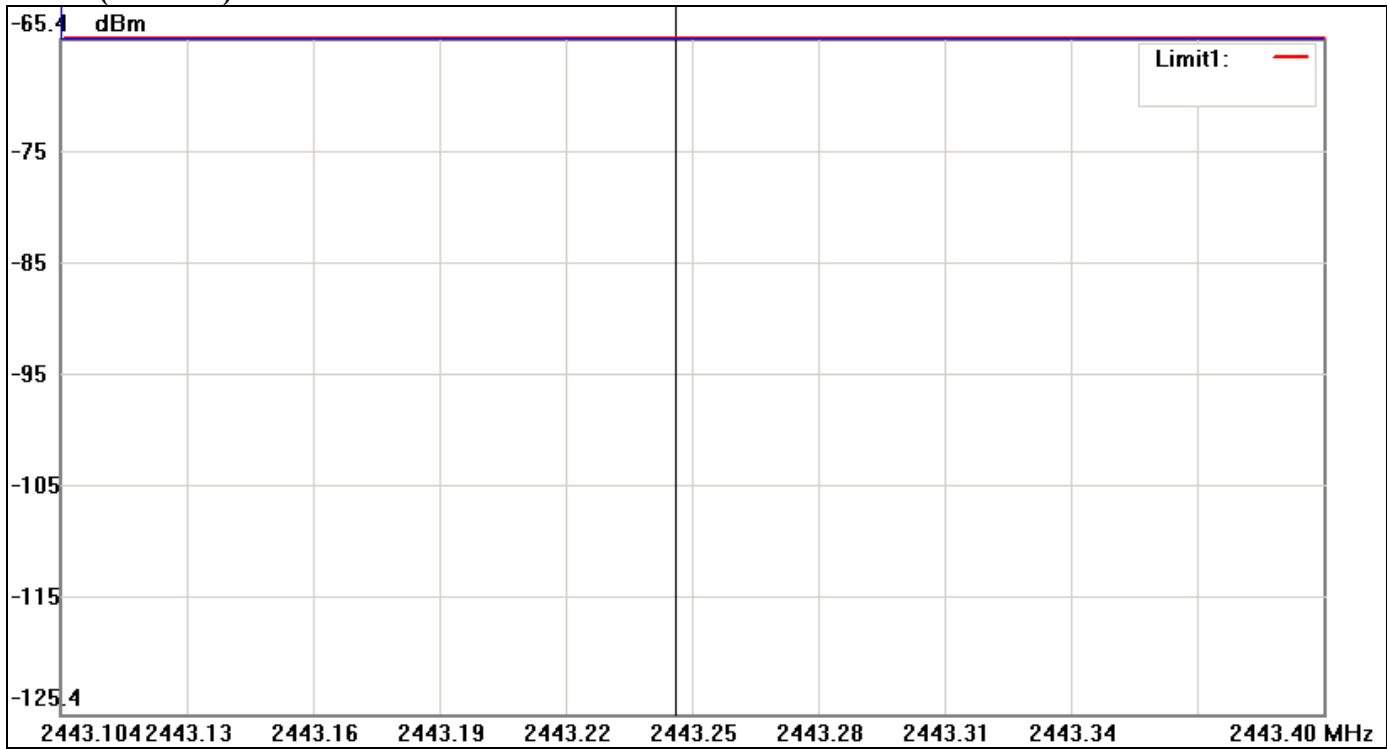

No.	Frequency(MHz)	Level(dBm)	Limit(dBm)	Margin(dBm)
1	2443.2500	-11.22	8.00	-19.22



**PPSD (CH High)**

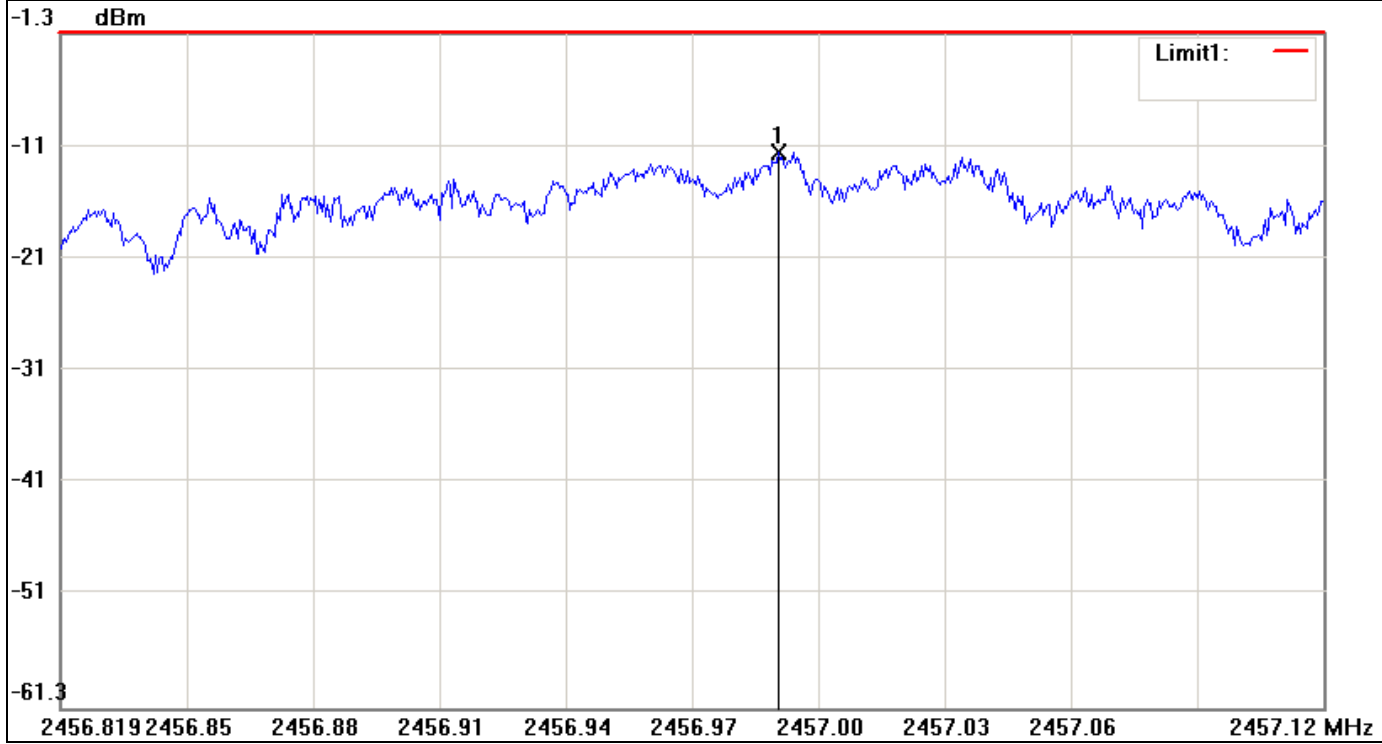

No.	Frequency(MHz)	Level(dBm)	Limit(dBm)	Margin(dBm)
1	2456.9893	-11.94	8.00	-19.94



IEEE 802.11n HT 40 MHz mode

PPSD (CH Low)

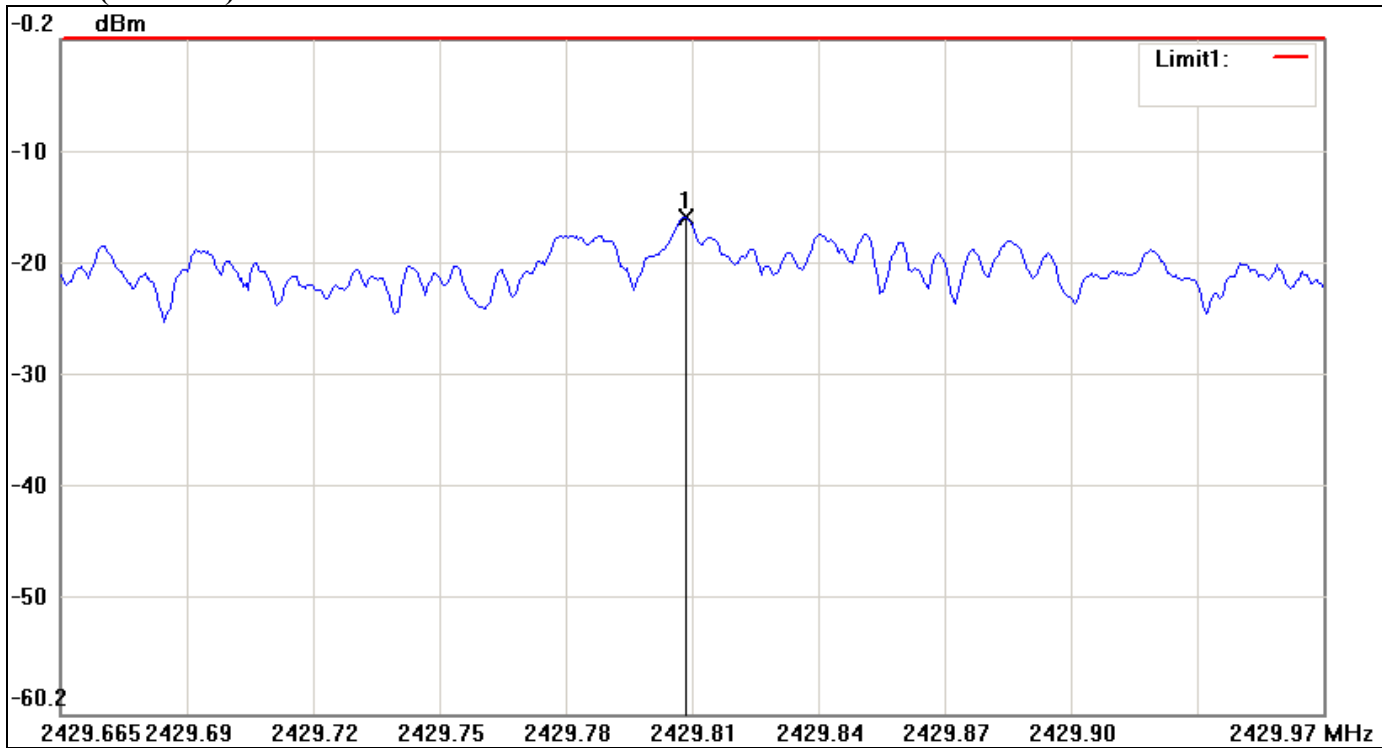

No.	Frequency(MHz)	Level(dBm)	Limit(dBm)	Margin(dBm)
1	2429.8132	-16.04	8.00	-24.04



### PPSD (CH Mid)

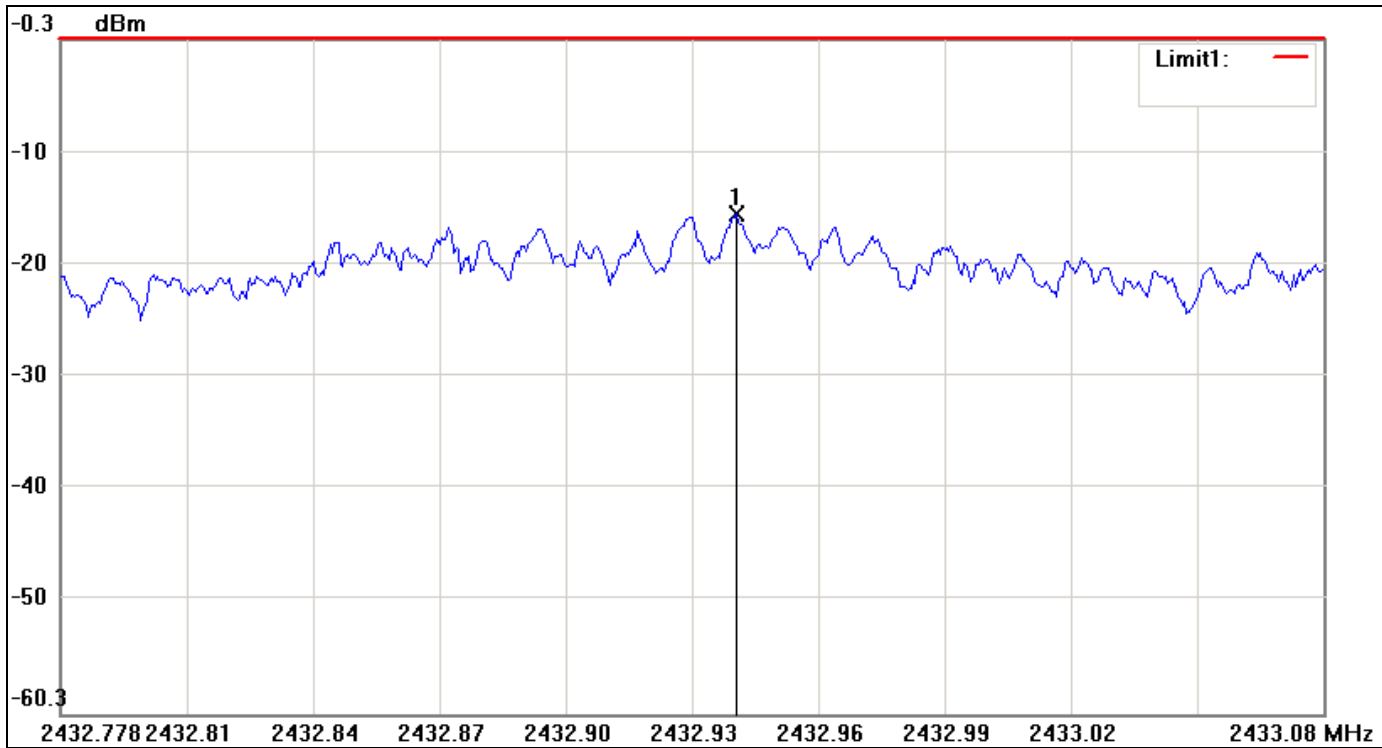

No.	Frequency(MHz)	Level(dBm)	Limit(dBm)	Margin(dBm)
1	2432.9384	-15.85	8.00	-23.85



### PPSD (CH High)

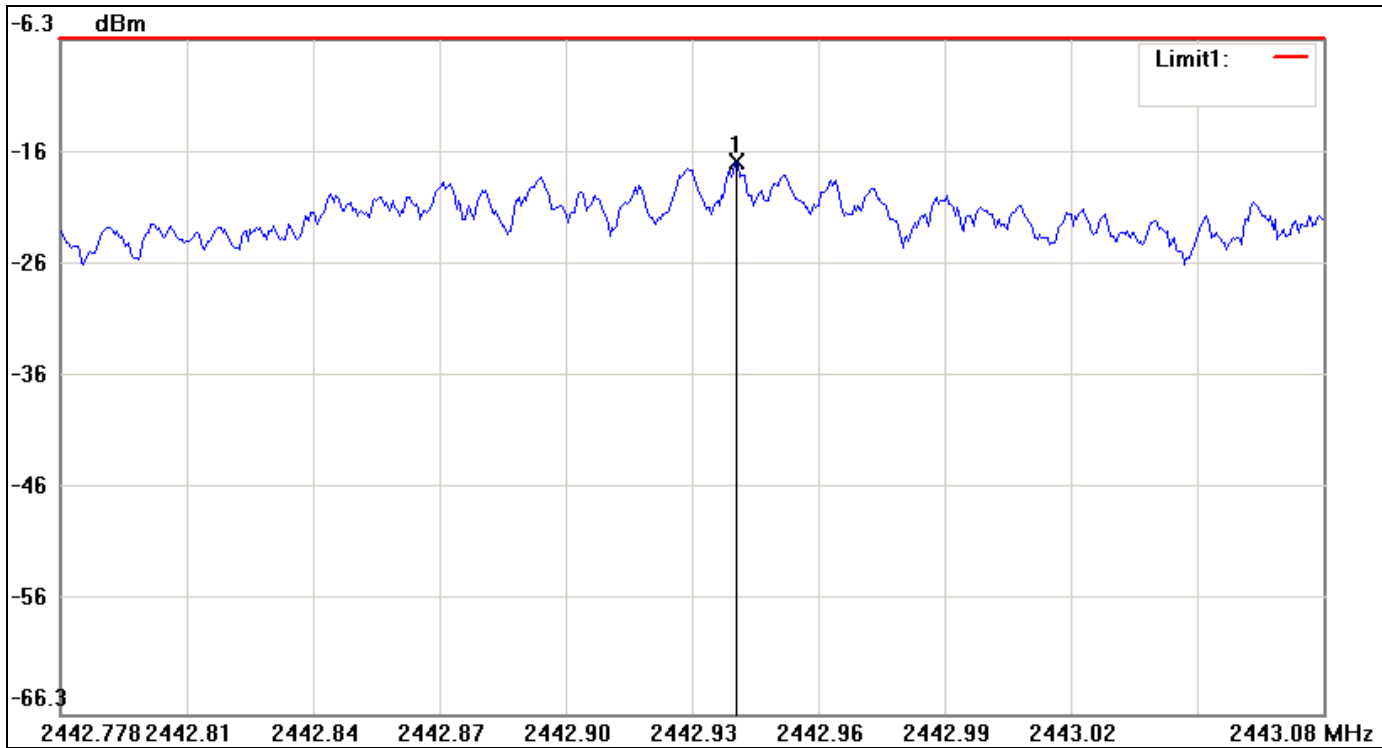

No.	Frequency(MHz)	Level(dBm)	Limit(dBm)	Margin(dBm)
1	2442.9385	-17.22	8.00	-25.22



## 7.6 SPURIOUS EMISSIONS

### 7.6.1 Conducted Measurement

#### LIMIT

According to §15.247(d), in any 100 kHz bandwidth outside the frequency bands in which the spread spectrum intentional radiator is operating, the radio frequency power that is produced by the intentional radiator shall be at least 20 dB below that in the 100 kHz bandwidth within the band that contains the highest level of the desired power, based on either an RF conducted or a radiated measurement, provided the transmitter demonstrates compliance with the peak conducted power limits. In addition, radiated emissions which fall in the restricted bands, as defined in §15.205(a), must also comply with the radiated emission limits specified in 15.209(a) (see Section 15.205(c)).

#### Test Configuration

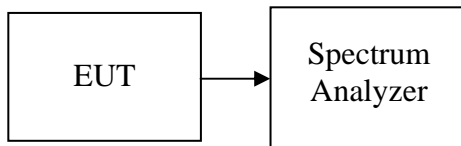

#### TEST PROCEDURE

Conducted RF measurements of the transmitter output were made to confirm that the EUT antenna port conducted emissions meet the specified limit and to identify any spurious signals that require further investigation or measurements on the radiated emissions site.

The transmitter output is connected to the spectrum analyzer. The resolution bandwidth is set to 100 kHz. The video bandwidth is set to 100 kHz.

Measurements are made over the 30MHz to 26GHz range with the transmitter set to the lowest, middle, and highest channels.

#### TEST RESULTS

*No non-compliance noted*





**Test Plot**

**IEEE 802.11b mode**

**CH Low**

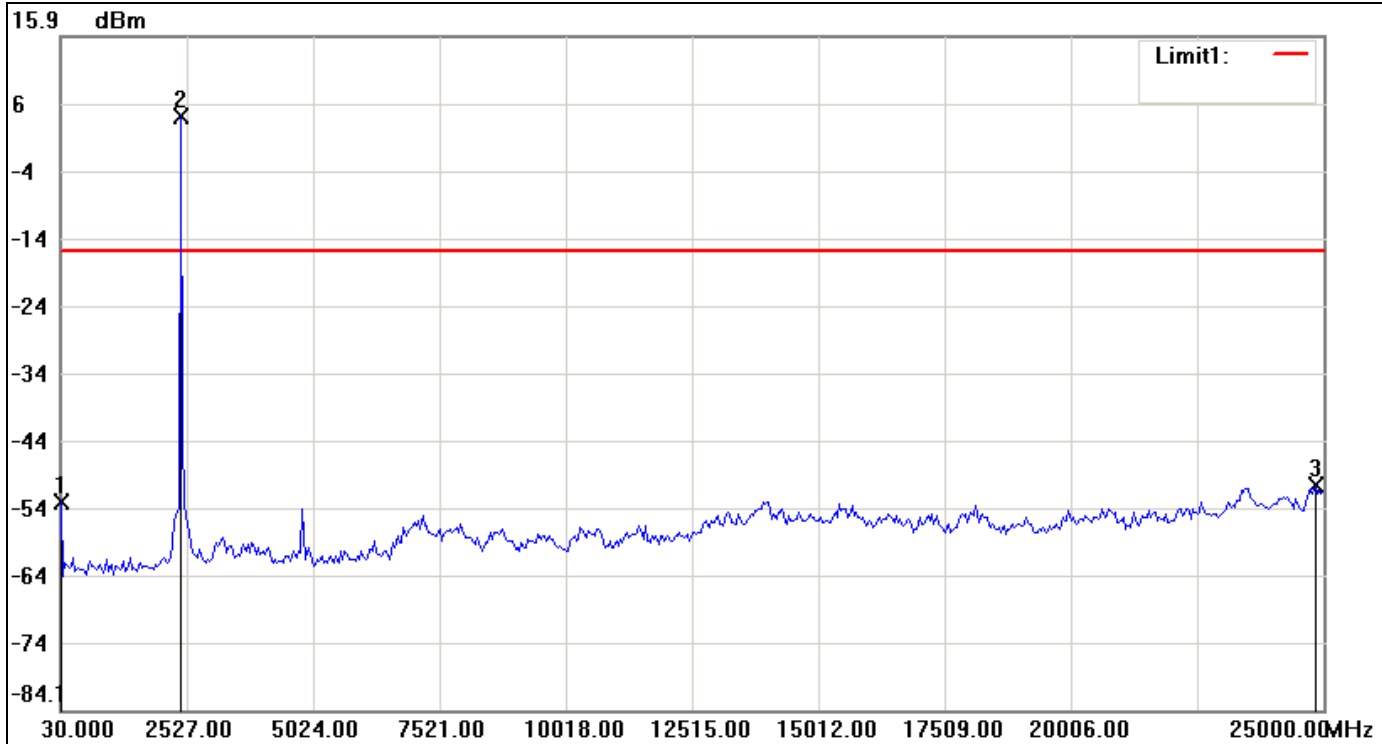

No.	Frequency(MHz)	Level(dBm)	Limit(dBm)	Margin(dBm)
1	30.0000	-53.20	-15.99	-37.21
2	2402.1500	4.01	-15.99	20.00
3	24833.5333	-50.79	-15.99	-34.80



### CH Mid



No.	Frequency(MHz)	Level(dBm)	Limit(dBm)	Margin(dBm)
1	30.0000	-50.40	-13.42	-36.98
2	2443.7667	6.58	-13.42	20.00
3	23460.1833	-49.95	-13.42	-36.53



### CH High

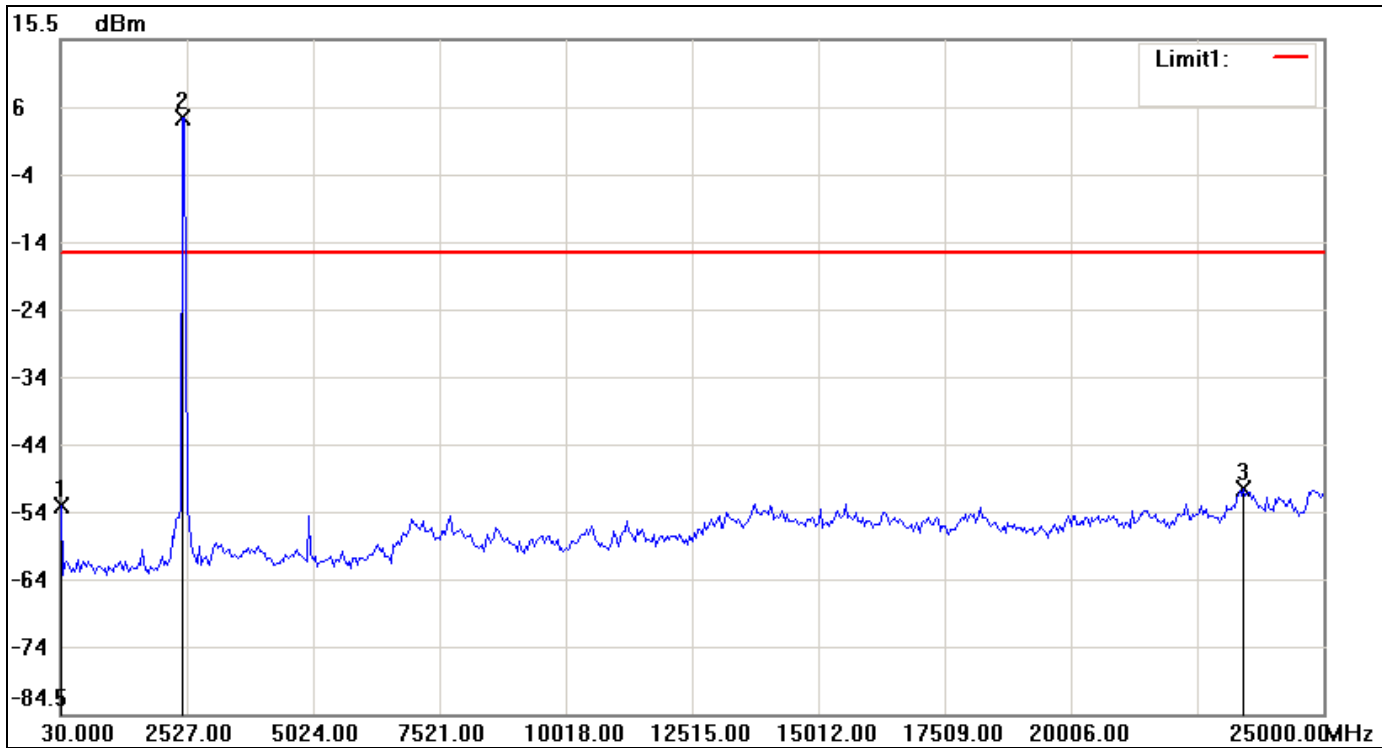

No.	Frequency(MHz)	Level(dBm)	Limit(dBm)	Margin(dBm)
1	30.0000	-53.49	-16.02	-37.47
2	2443.7667	3.98	-16.02	20.00
3	23418.5667	-51.19	-16.02	-35.17



### IEEE 802.11g mode

#### CH Low

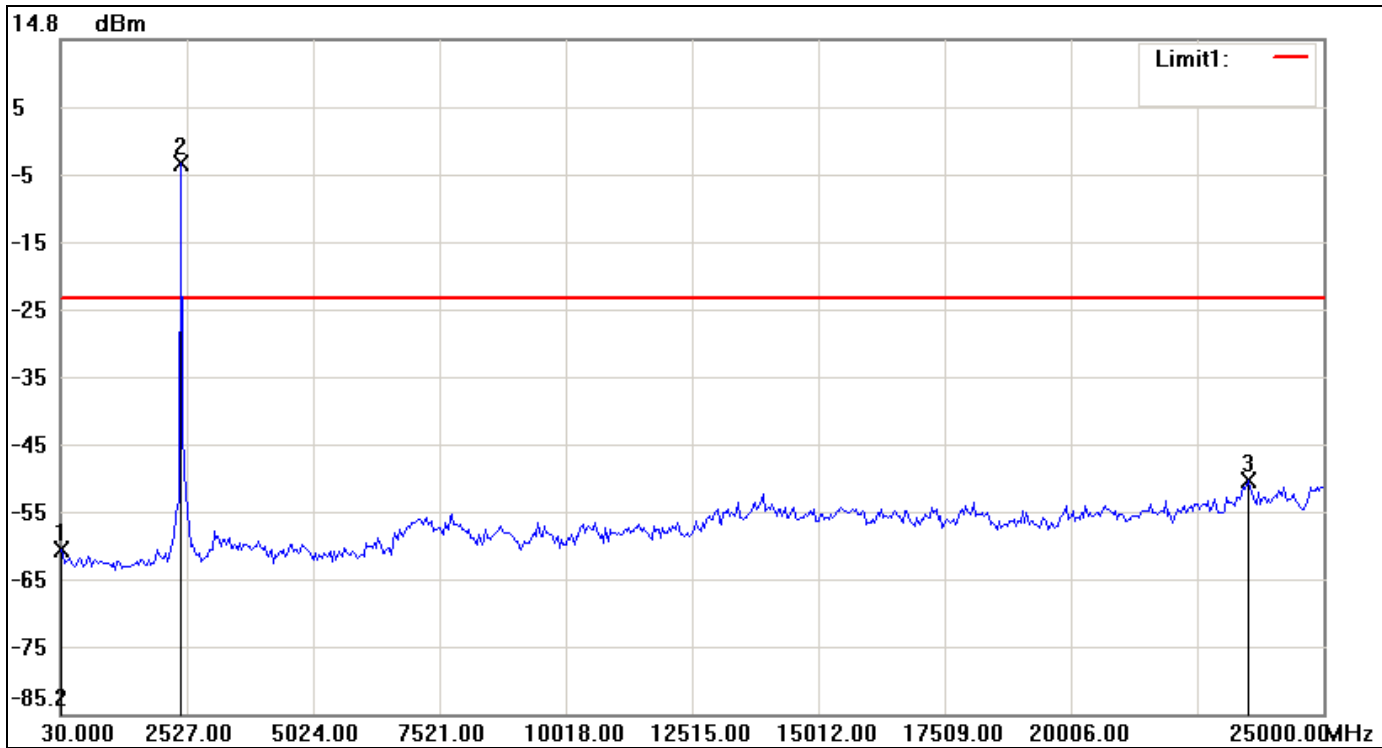

No.	Frequency(MHz)	Level(dBm)	Limit(dBm)	Margin(dBm)
1	30.0000	-60.90	-23.55	-37.35
2	2402.1500	-3.55	-23.55	20.00
3	23501.8000	-50.62	-23.55	-27.07



### CH Mid

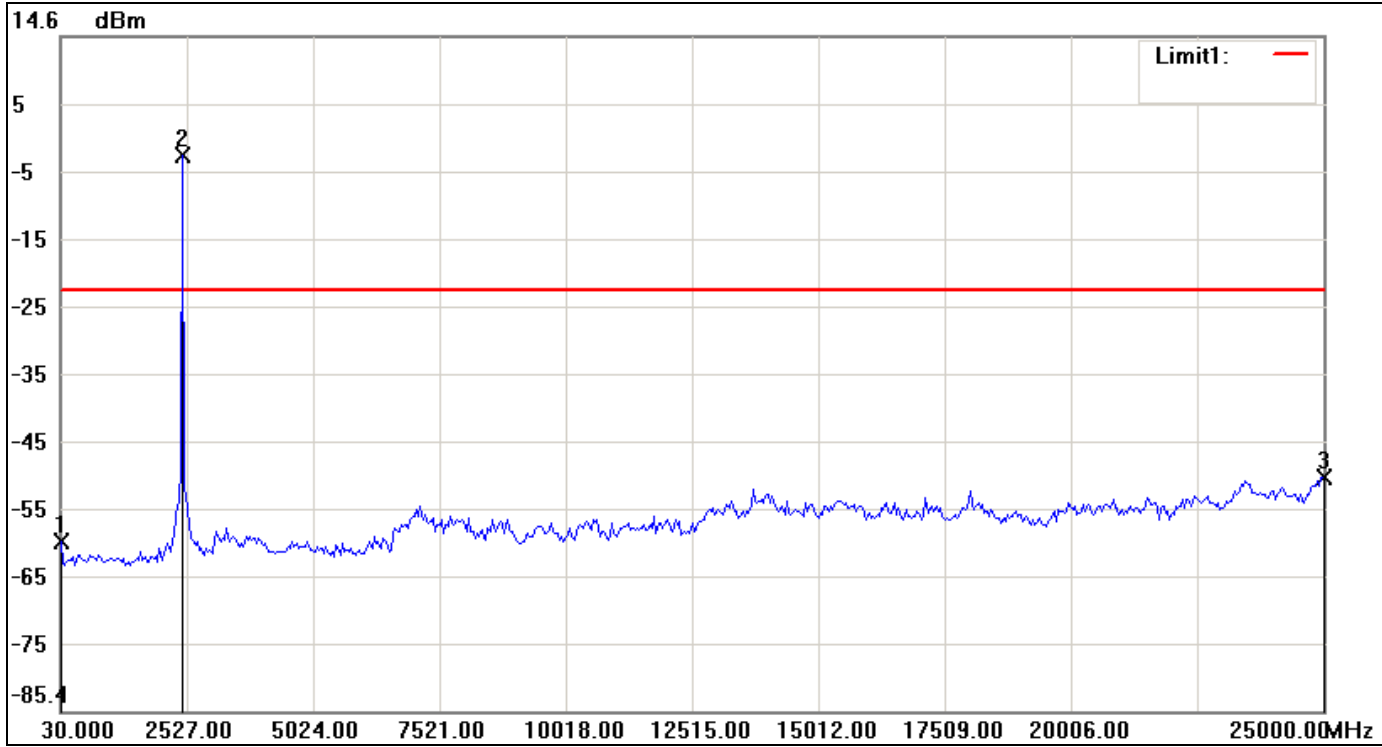

No.	Frequency(MHz)	Level(dBm)	Limit(dBm)	Margin(dBm)
1	30.0000	-60.21	-23.11	-37.10
2	2443.7667	-3.11	-23.11	20.00
3	25000.0000	-50.73	-23.11	-27.62



### CH High

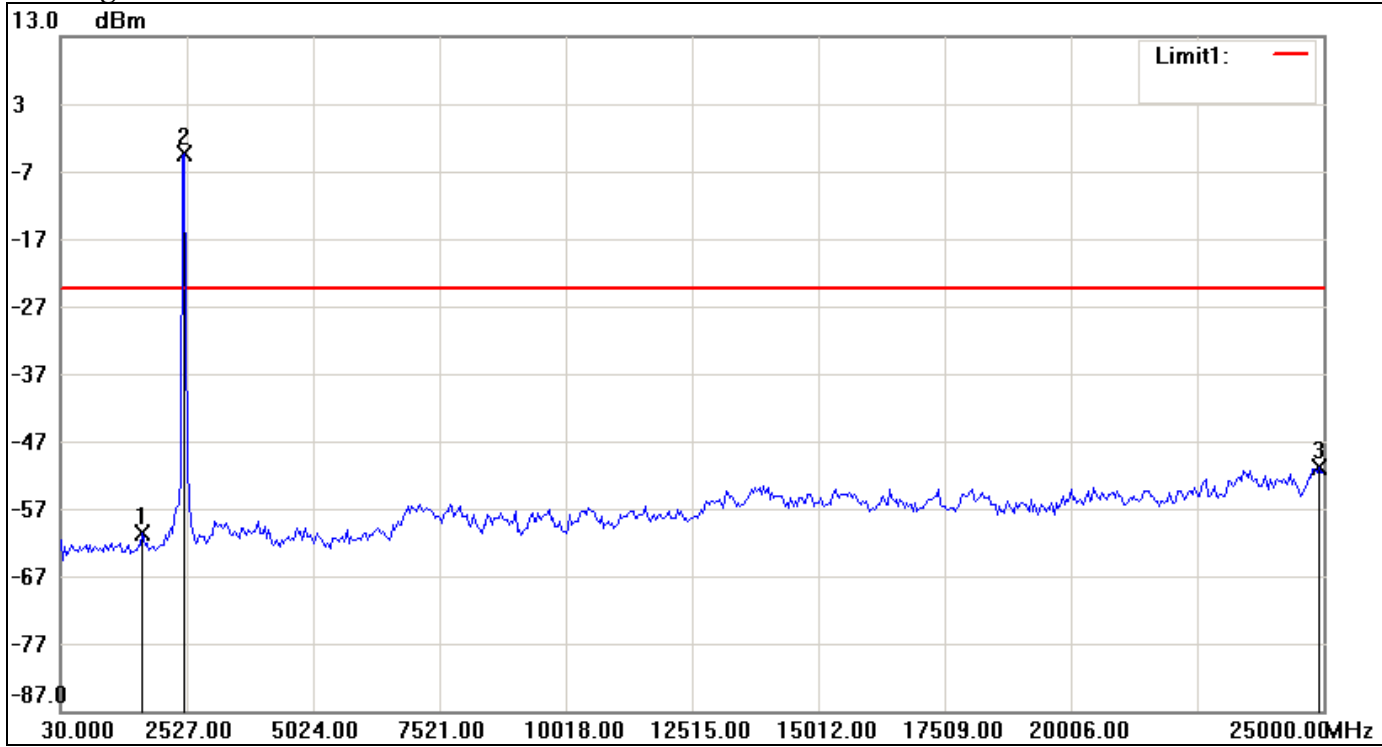

No.	Frequency(MHz)	Level(dBm)	Limit(dBm)	Margin(dBm)
1	1653.0500	-60.69	-24.47	-36.22
2	2485.3833	-4.47	-24.47	20.00
3	24916.7667	-50.79	-24.47	-26.32



### IEEE 802.11n HT 20 MHz mode

#### CH Low

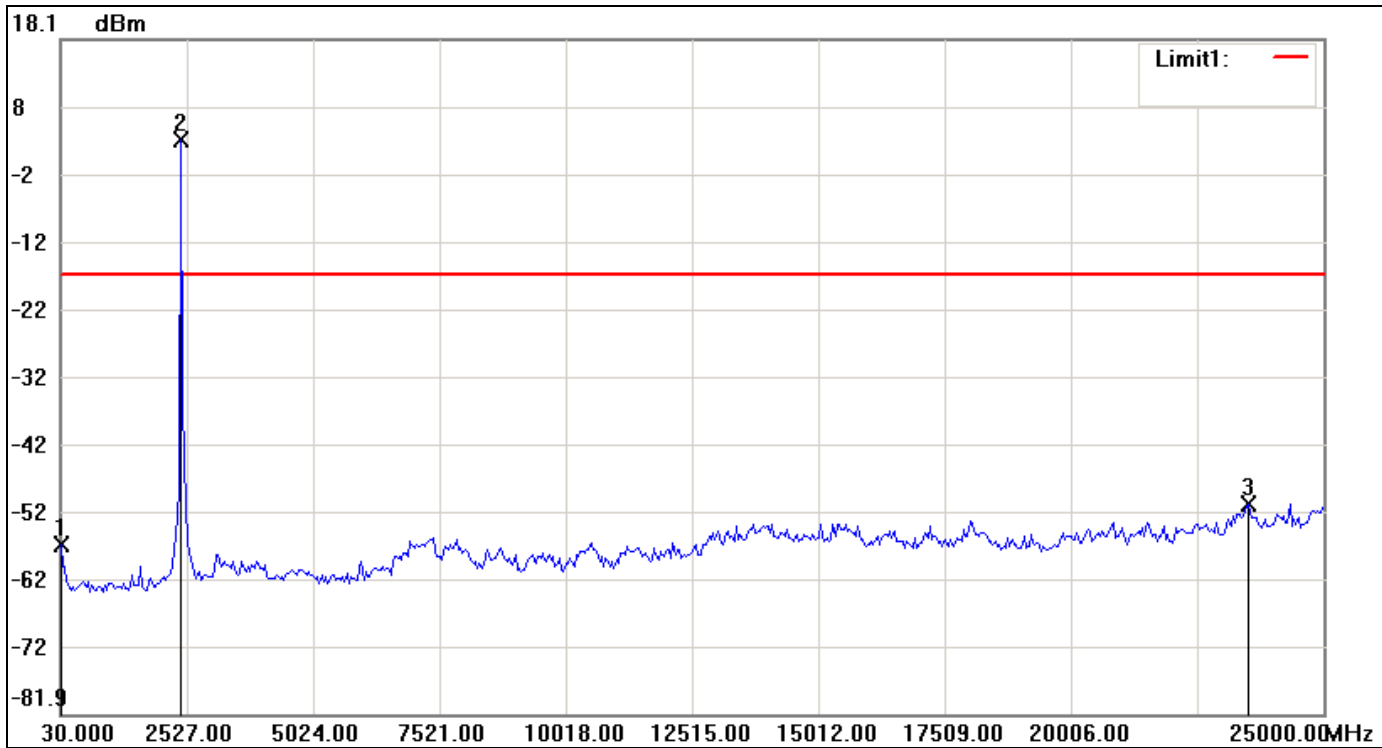

No.	Frequency(MHz)	Level(dBm)	Limit(dBm)	Margin(dBm)
1	30.0000	-56.83	-16.79	-40.04
2	2402.1500	3.21	-16.79	20.00
3	23501.8000	-50.82	-16.79	-34.03



### CH Mid

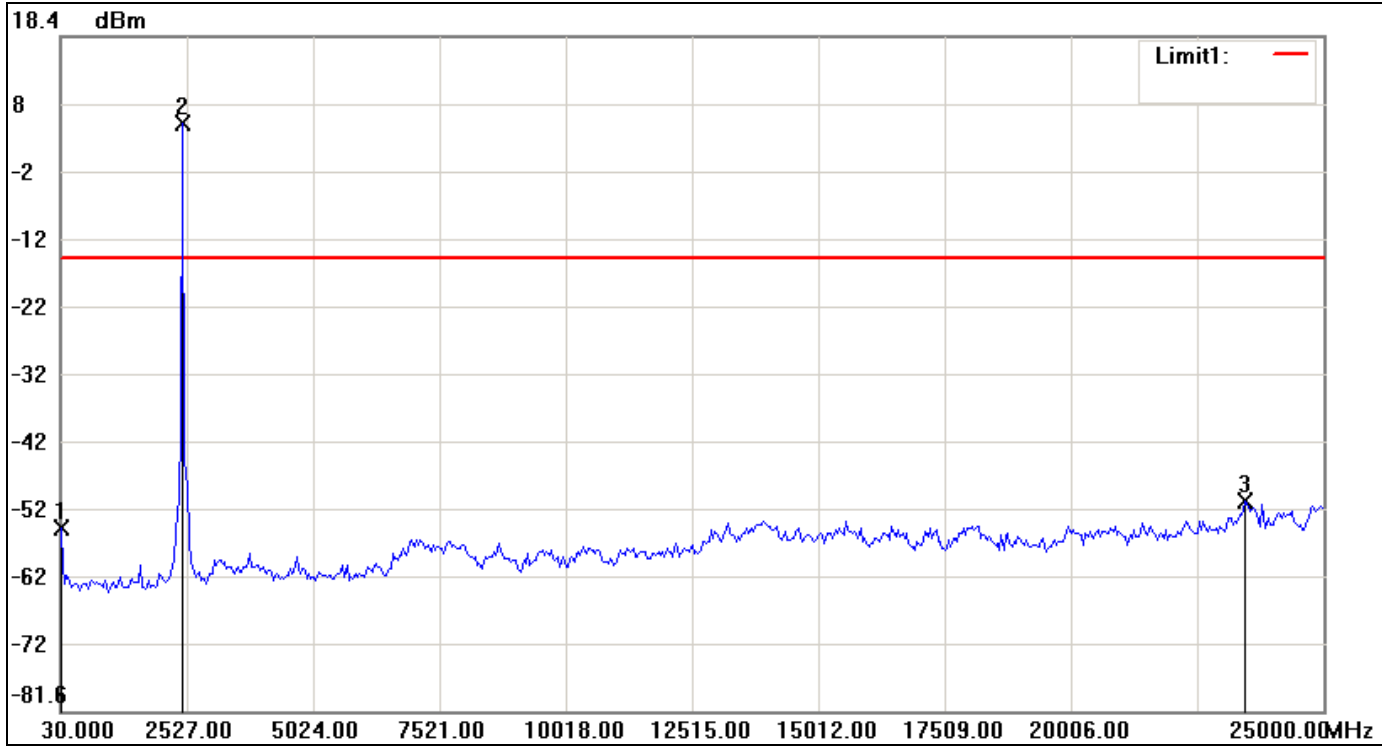

No.	Frequency(MHz)	Level(dBm)	Limit(dBm)	Margin(dBm)
1	30.0000	-54.55	-14.46	-40.09
2	2443.7667	5.54	-14.46	20.00
3	23460.1833	-50.50	-14.46	-36.04





### CH High



No.	Frequency(MHz)	Level(dBm)	Limit(dBm)	Margin(dBm)
1	30.0000	-56.53	-15.71	-40.82
2	2443.7667	4.29	-15.71	20.00
3	24334.1333	-50.32	-15.71	-34.61



### IEEE 802.11n HT 40 MHz mode

#### CH Low

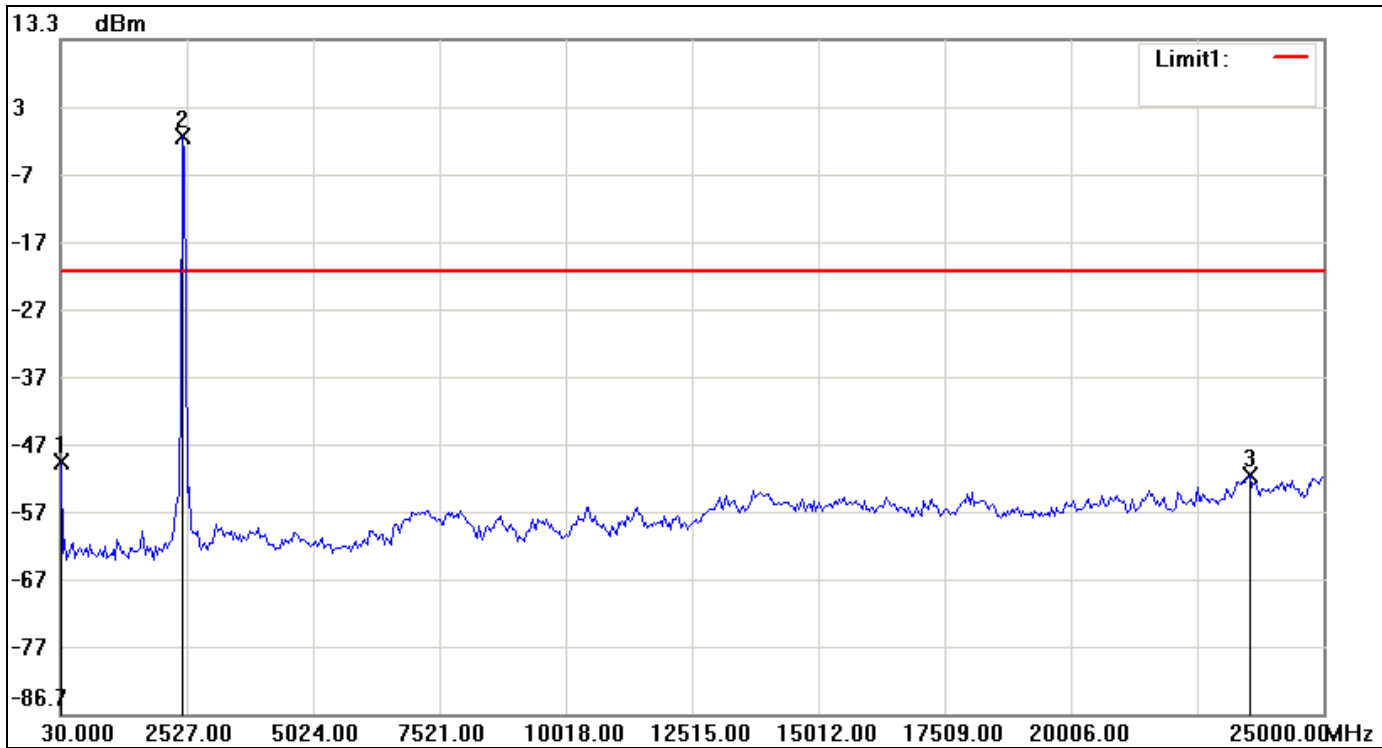

No.	Frequency(MHz)	Level(dBm)	Limit(dBm)	Margin(dBm)
1	30.0000	-49.40	-21.21	-28.19
2	2443.7667	-1.21	-21.21	20.00
3	23543.4167	-51.23	-21.21	-30.02



### CH Mid

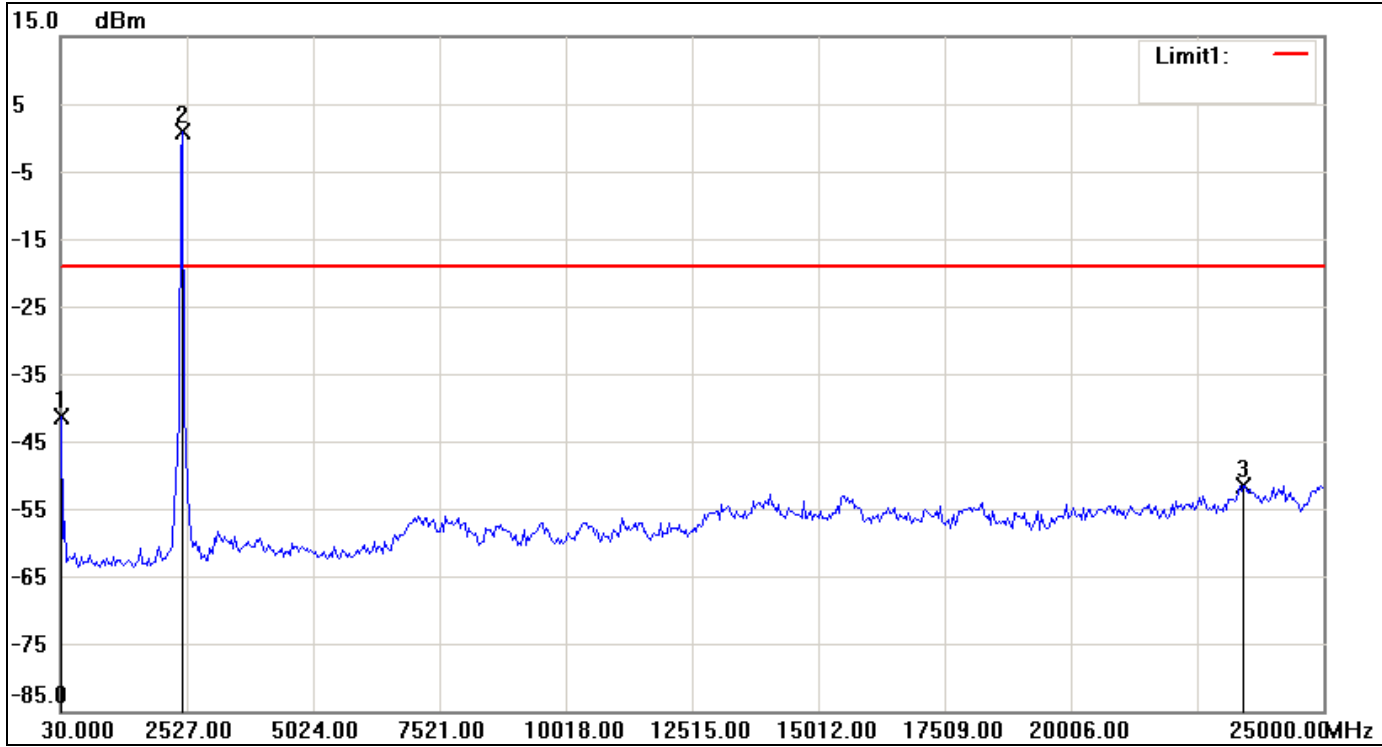

No.	Frequency(MHz)	Level(dBm)	Limit(dBm)	Margin(dBm)
1	30.0000	-41.34	-19.21	-22.13
2	2443.7667	0.79	-19.21	20.00
3	23418.5667	-51.59	-19.21	-32.38



### CH High

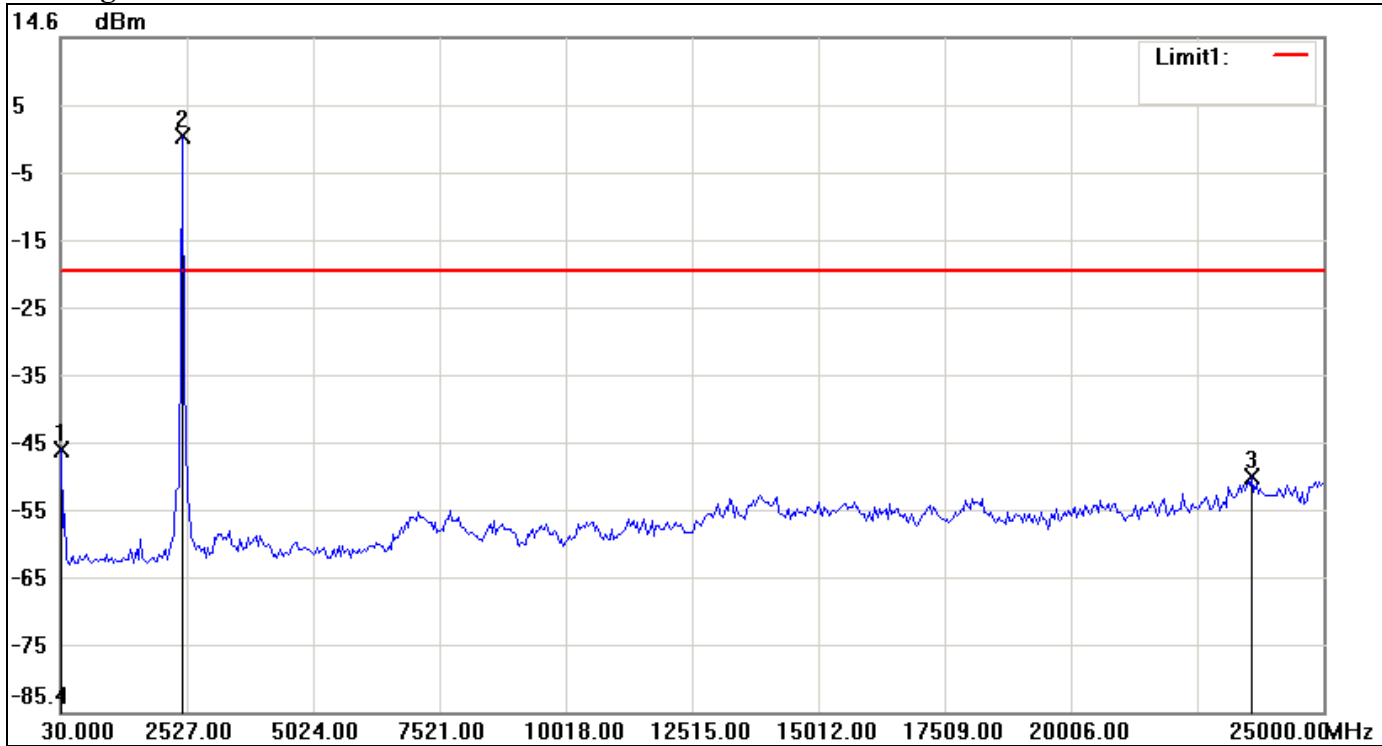

No.	Frequency(MHz)	Level(dBm)	Limit(dBm)	Margin(dBm)
1	30.0000	-46.62	-19.96	-26.66
2	2443.7667	0.04	-19.96	20.00
3	23585.0333	-50.59	-19.96	-30.63



## 7.7 RADIATED EMISSIONS

### LIMIT

1. According to §15.209(a), except as provided elsewhere in this Subpart, the emissions from an intentional radiator shall not exceed the field strength levels specified in the following table:

Frequency (MHz)	Field Strength ( $\mu\text{V}/\text{m}$ )	Measurement Distance (m)
30-88	100*	3
88-216	150*	3
216-960	200*	3
Above 960	500	3

**Remark:** Except as provided in paragraph (g), fundamental emissions from intentional radiators operating under this Section shall not be located in the frequency bands 54-72 MHz, 76-88 MHz, 174-216 MHz or 470-806 MHz. However, operation within these frequency bands is permitted under other sections of this Part, e.g., Sections 15.231 and 15.241.

2. In the emission table above, the tighter limit applies at the band edges.

Frequency (MHz)	Field Strength ( $\mu\text{V}/\text{m}$ at 3-meter)	Field Strength (dB $\mu\text{V}/\text{m}$ at 3-meter)
30-88	100	40
88-216	150	43.5
216-960	200	46
Above 960	500	54



### Test Configuration

9kHz ~ 30MHz

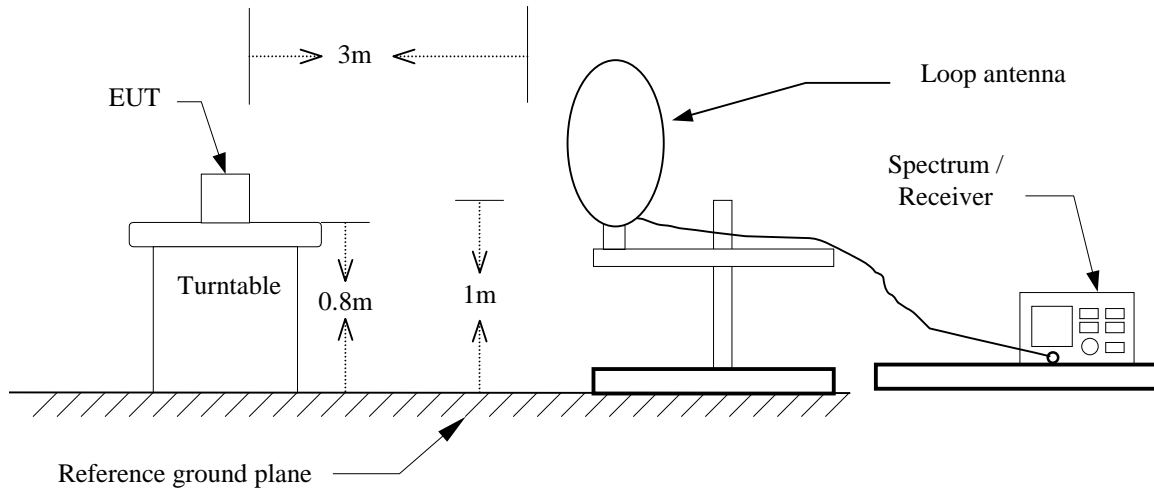

30MHz ~ 1GHz

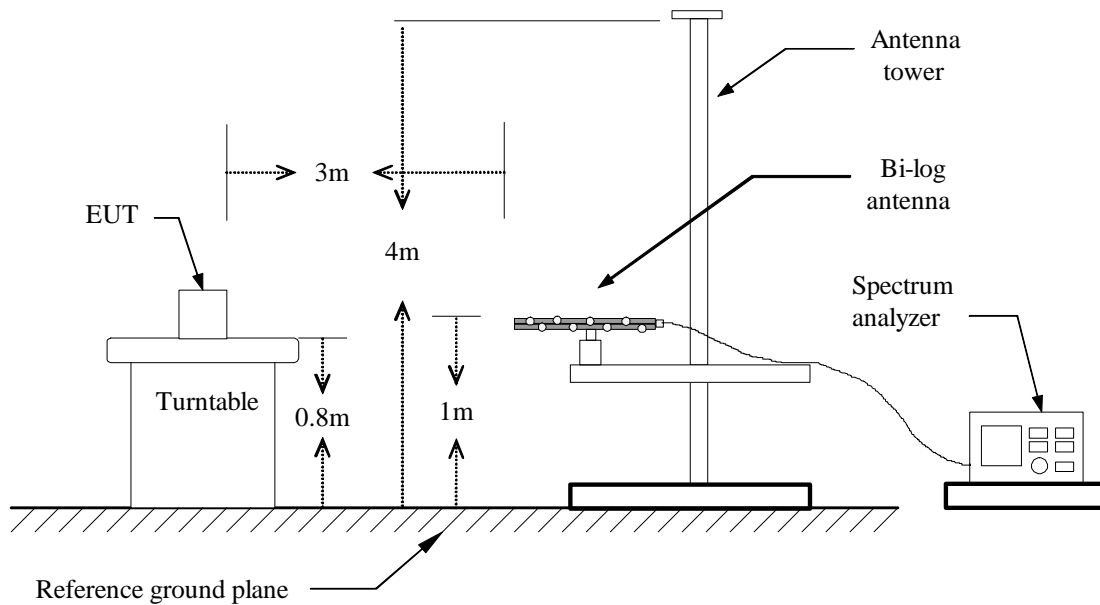



Above 1 GHz

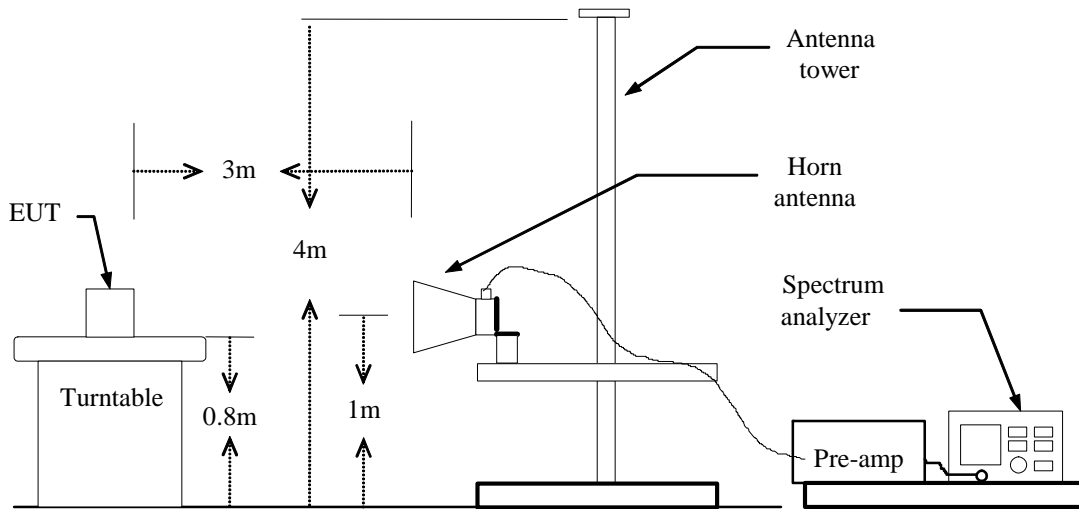



## **TEST PROCEDURE**

1. The EUT is placed on a turntable, which is 0.8m above ground plane.
2. The turntable shall be rotated for 360 degrees to determine the position of maximum emission level.
3. EUT is set 3m away from the receiving antenna, which is varied from 1m to 4m to find out the highest emissions.
4. Maximum procedure was performed on the six highest emissions to ensure EUT compliance.
5. And also, each emission was to be maximized by changing the polarization of receiving antenna both horizontal and vertical.
6. Set the spectrum analyzer in the following setting as:  
Below 1GHz:  
RBW=100kHz / VBW=300kHz / Sweep=AUTO  
Above 1GHz:  
(a) PEAK: RBW=VBW=1MHz / Sweep=AUTO  
(b) AVERAGE: RBW=1MHz / VBW=10Hz / Sweep=AUTO
7. Repeat above procedures until the measurements for all frequencies are complete.





## TEST RESULTS

### Below 1GHz

**Operation Mode:** Normal Link

**Test Date:** July 15, 2011

**Temperature:** 24°C

**Tested by:** Ali Shu

**Humidity:** 40% RH

**Polarity:** Ver. / Hor.

Frequency (MHz)	Reading (dBuV)	Correction Factor (dB/m)	Result (dBuV/m)	Limit (dBuV/m)	Margin (dB)	Remark	Ant. Pol. (H/V)
65.57	53.44	-15.21	38.23	40.00	-1.77	QP	V
159.33	49.89	-10.53	39.36	43.50	-4.14	Peak	V
277.35	51.20	-9.48	41.72	46.00	-4.28	QP	V
363.03	49.02	-7.80	41.22	46.00	-4.78	QP	V
479.43	47.13	-5.44	41.69	46.00	-4.31	Peak	V
959.58	40.76	0.44	41.20	46.00	-4.80	Peak	V
277.35	53.13	-9.48	43.65	46.00	-2.35	QP	H
363.03	49.24	-7.80	41.44	46.00	-4.56	Peak	H
479.43	41.74	-5.44	36.30	46.00	-9.70	Peak	H
720.32	46.34	-2.25	44.09	46.00	-1.91	QP	H
799.53	43.20	-1.34	41.86	46.00	-4.14	Peak	H
959.58	41.30	0.44	41.74	46.00	-4.26	QP	H

### **Remark:**

1. No emission found between lowest internal used/generated frequency to 30MHz (9kHz~30MHz)
2. Radiated emissions measured in frequency range from 30 MHz to 1000MHz were made with an instrument using peak/quasi-peak detector mode.
3. Quasi-peak test would be performed if the peak result were greater than the quasi-peak limit or as required by the applicant.
4. Measurements above show only up to 6 maximum emissions noted, or would be lesser, with " N/A " remark, if no specific emissions from the EUT are recorded (ie: margin>20dB from the applicable limit) and considered that's already beyond the background noise floor.
5.  $Margin (dB) = Result (dBuV/m) - Limit (dBuV/m)$ .



**Above 1 GHz**

**Operation Mode:** TX / IEEE 802.11b / CH Low

**Test Date:** July 15, 2011

**Temperature:** 24°C

**Tested by:** Ali Shu

**Humidity:** 40 % RH

**Polarity:** Ver. / Hor.

Frequency (MHz)	Reading (Peak) (dBuV)	Reading (Average) (dBuV)	Correction Factor (dB/m)	Result (Peak) (dBuV/m)	Result (Average) (dBuV/m)	Limit (Peak) (dBuV/m)	Limit (Average) (dBuV/m)	Margin (dB)	Remark	Ant. Pol. (H/V)
1440.00	56.73	---	-10.61	46.11	---	74.00	54.00	-7.89	Peak	V
4825.00	48.93	---	2.61	51.54	---	74.00	54.00	-2.46	Peak	V
7233.33	48.89	45.70	7.26	56.15	52.96	74.00	54.00	-1.04	AVG	V
N/A										
1283.33	64.80	53.63	-10.78	54.02	42.85	74.00	54.00	-11.15	AVG	H
4825.00	49.14	---	2.61	51.75	---	74.00	54.00	-2.25	Peak	H
7233.33	47.25	45.61	7.26	54.51	52.87	74.00	54.00	-1.13	AVG	H
N/A										

**Remark:**

1. Measuring frequencies from 1 GHz to the 10th harmonic of highest fundamental frequency.
2. Radiated emissions measured in frequency above 1000MHz were made with an instrument using peak/average detector mode.
3. Average test would be performed if the peak result were greater than the average limit or as required by the applicant.
4. Data of measurement within this frequency range shown “ --- ” in the table above means the reading of emissions are attenuated more than 20dB below the permissible limits or the field strength is too small to be measured.
5. Measurements above show only up to 6 maximum emissions noted, or would be lesser, with “ N/A ” remark, if no specific emissions from the EUT are recorded (ie: margin>20dB from the applicable limit) and considered that's already beyond the background noise floor.
6. Margin (dB) = Remark result (dBuV/m) – Average limit (dBuV/m).



**Operation Mode:** TX / IEEE 802.11b / CH Mid

**Test Date:** July 15, 2011

**Temperature:** 24°C

**Tested by:** Ali Shu

**Humidity:** 40 % RH

**Polarity:** Ver. / Hor.

Frequency (MHz)	Reading (Peak) (dBuV)	Reading (Average) (dBuV)	Correction Factor (dB/m)	Result (Peak) (dBuV/m)	Result (Average) (dBuV/m)	Limit (Peak) (dBuV/m)	Limit (Average) (dBuV/m)	Margin (dB)	Remark	Ant. Pol. (H/V)
1440.00	56.32	---	-10.61	45.71	---	74.00	54.00	-8.29	Peak	V
4883.33	49.39	46.60	2.73	52.12	49.33	74.00	54.00	-4.67	AVG	V
N/A										
1280.00	62.25	---	-10.78	51.47	---	74.00	54.00	-2.53	Peak	H
4883.33	53.62	49.78	2.73	56.35	52.51	74.00	54.00	-1.49	AVG	H
N/A										

**Remark:**

1. Measuring frequencies from 1 GHz to the 10th harmonic of highest fundamental frequency.
2. Radiated emissions measured in frequency above 1000MHz were made with an instrument using peak/average detector mode.
3. Average test would be performed if the peak result were greater than the average limit or as required by the applicant.
4. Data of measurement within this frequency range shown “ --- ” in the table above means the reading of emissions are attenuated more than 20dB below the permissible limits or the field strength is too small to be measured.
5. Measurements above show only up to 6 maximum emissions noted, or would be lesser, with “ N/A ” remark, if no specific emissions from the EUT are recorded (ie: margin > 20dB from the applicable limit) and considered that's already beyond the background noise floor.
6. Margin (dB) = Remark result (dBuV/m) – Average limit (dBuV/m).



**Operation Mode:** TX / IEEE 802.11b / CH High

**Test Date:** July 15, 2011

**Temperature:** 24°C

**Tested by:** Ali Shu

**Humidity:** 40 % RH

**Polarity:** Ver. / Hor.

Frequency (MHz)	Reading (Peak) (dBuV)	Reading (Average) (dBuV)	Correction Factor (dB/m)	Result (Peak) (dBuV/m)	Result (Average) (dBuV/m)	Limit (Peak) (dBuV/m)	Limit (Average) (dBuV/m)	Margin (dB)	Remark	Ant. Pol. (H/V)
1280.00	61.17	---	-10.78	50.40	---	74.00	54.00	-3.60	Peak	V
4925.00	47.82	---	2.81	50.63	---	74.00	54.00	-3.37	Peak	V
7391.67	47.76	40.23	7.20	54.96	47.43	74.00	54.00	-6.57	AVG	V
N/A										
1440.00	58.60	---	-10.61	47.98	---	74.00	54.00	-6.02	Peak	H
4925.00	49.12	---	2.81	51.93	---	74.00	54.00	-2.07	Peak	H
7383.33	46.42	39.43	7.20	53.63	46.63	74.00	54.00	-7.37	AVG	H
N/A										

**Remark:**

1. Measuring frequencies from 1 GHz to the 10th harmonic of highest fundamental frequency.
2. Radiated emissions measured in frequency above 1000MHz were made with an instrument using peak/average detector mode.
3. Average test would be performed if the peak result were greater than the average limit or as required by the applicant.
4. Data of measurement within this frequency range shown " --- " in the table above means the reading of emissions are attenuated more than 20dB below the permissible limits or the field strength is too small to be measured.
5. Measurements above show only up to 6 maximum emissions noted, or would be lesser, with " N/A " remark, if no specific emissions from the EUT are recorded (ie: margin > 20dB from the applicable limit) and considered that's already beyond the background noise floor.
6. Margin (dB) = Remark result (dBuV/m) – Average limit (dBuV/m).



**Operation Mode:** TX / IEEE 802.11g / CH Low

**Test Date:** July 15, 2011

**Temperature:** 24°C

**Tested by:** Ali Shu

**Humidity:** 40 % RH

**Polarity:** Ver. / Hor.

Frequency (MHz)	Reading (Peak) (dBuV)	Reading (Average) (dBuV)	Correction Factor (dB/m)	Result (Peak) (dBuV/m)	Result (Average) (dBuV/m)	Limit (Peak) (dBuV/m)	Limit (Average) (dBuV/m)	Margin (dB)	Remark	Ant. Pol. (H/V)
1280.00	62.17	---	-10.78	51.39	---	74.00	54.00	-2.61	Peak	V
4816.67	48.73	---	2.59	51.32	---	74.00	54.00	-2.68	Peak	V
7233.33	51.09	42.01	7.26	58.35	49.27	74.00	54.00	-4.73	AVG	V
N/A										
1280.00	63.11	54.09	-10.78	52.33	43.31	74.00	54.00	-10.69	AVG	H
2360.00	61.97	51.09	-4.44	57.53	46.65	74.00	54.00	-7.35	AVG	H
7233.33	47.97	39.00	7.26	55.23	46.26	74.00	54.00	-7.74	AVG	H
N/A										

**Remark:**

1. Measuring frequencies from 1 GHz to the 10th harmonic of highest fundamental frequency.
2. Radiated emissions measured in frequency above 1000MHz were made with an instrument using peak/average detector mode.
3. Average test would be performed if the peak result were greater than the average limit or as required by the applicant.
4. Data of measurement within this frequency range shown “ --- ” in the table above means the reading of emissions are attenuated more than 20dB below the permissible limits or the field strength is too small to be measured.
5. Measurements above show only up to 6 maximum emissions noted, or would be lesser, with “ N/A ” remark, if no specific emissions from the EUT are recorded (ie: margin > 20dB from the applicable limit) and considered that's already beyond the background noise floor.
6. Margin (dB) = Remark result (dBuV/m) – Average limit (dBuV/m).



**Operation Mode:** TX / IEEE 802.11g / CH Mid

**Test Date:** July 15, 2011

**Temperature:** 24°C

**Tested by:** Ali Shu

**Humidity:** 40 % RH

**Polarity:** Ver. / Hor.

Frequency (MHz)	Reading (Peak) (dBuV)	Reading (Average) (dBuV)	Correction Factor (dB/m)	Result (Peak) (dBuV/m)	Result (Average) (dBuV/m)	Limit (Peak) (dBuV/m)	Limit (Average) (dBuV/m)	Margin (dB)	Remark	Ant. Pol. (H/V)
1280.00	61.95	---	-10.78	51.17	---	74.00	54.00	-2.83	Peak	V
2493.33	59.65	50.34	-3.90	55.76	46.44	74.00	54.00	-7.56	AVG	V
7325.00	48.71	37.07	7.23	55.94	44.30	74.00	54.00	-9.70	AVG	V
N/A										
1283.33	62.37	---	-10.78	51.60	---	74.00	54.00	-2.40	Peak	H
2390.00	63.93	54.31	-4.32	59.61	49.99	74.00	54.00	-4.01	AVG	H
2493.33	64.68	55.74	-3.90	60.79	51.84	74.00	54.00	-2.16	AVG	H
7333.33	46.91	37.23	7.22	54.13	44.45	74.00	54.00	-9.55	AVG	H
N/A										

**Remark:**

1. Measuring frequencies from 1 GHz to the 10th harmonic of highest fundamental frequency.
2. Radiated emissions measured in frequency above 1000MHz were made with an instrument using peak/average detector mode.
3. Average test would be performed if the peak result were greater than the average limit or as required by the applicant.
4. Data of measurement within this frequency range shown " --- " in the table above means the reading of emissions are attenuated more than 20dB below the permissible limits or the field strength is too small to be measured.
5. Measurements above show only up to 6 maximum emissions noted, or would be lesser, with " N/A " remark, if no specific emissions from the EUT are recorded (ie: margin > 20dB from the applicable limit) and considered that's already beyond the background noise floor.
6. Margin (dB) = Remark result (dBuV/m) – Average limit (dBuV/m).



**Operation Mode:** TX / IEEE 802.11g / CH High

**Test Date:** July 15, 2011

**Temperature:** 24°C

**Tested by:** Ali Shu

**Humidity:** 40 % RH

**Polarity:** Ver. / Hor.

Frequency (MHz)	Reading (Peak) (dBuV)	Reading (Average) (dBuV)	Correction Factor (dB/m)	Result (Peak) (dBuV/m)	Result (Average) (dBuV/m)	Limit (Peak) (dBuV/m)	Limit (Average) (dBuV/m)	Margin (dB)	Remark	Ant. Pol. (H/V)
1280.00	61.10	---	-10.78	50.32	---	74.00	54.00	-3.68	Peak	V
7391.67	51.59	38.85	7.20	58.80	46.05	74.00	54.00	-7.95	AVG	V
N/A										
1280.00	60.92	---	-10.78	50.15	---	74.00	54.00	-3.85	Peak	H
2513.33	64.17	54.64	-3.82	60.34	50.82	74.00	54.00	-3.18	AVG	H
7391.67	50.37	39.58	7.20	57.57	46.78	74.00	54.00	-7.22	AVG	H
N/A										

**Remark:**

1. Measuring frequencies from 1 GHz to the 10th harmonic of highest fundamental frequency.
2. Radiated emissions measured in frequency above 1000MHz were made with an instrument using peak/average detector mode.
3. Average test would be performed if the peak result were greater than the average limit or as required by the applicant.
4. Data of measurement within this frequency range shown “ --- ” in the table above means the reading of emissions are attenuated more than 20dB below the permissible limits or the field strength is too small to be measured.
5. Measurements above show only up to 6 maximum emissions noted, or would be lesser, with “ N/A ” remark, if no specific emissions from the EUT are recorded (ie: margin > 20dB from the applicable limit) and considered that's already beyond the background noise floor.
6. Margin (dB) = Remark result (dBuV/m) – Average limit (dBuV/m).



**Operation Mode:** TX / IEEE 802.11n HT 20 MHz mode / CH Low **Test Date:** July 15, 2011

**Temperature:** 24°C

**Tested by:** Ali Shu

**Humidity:** 40 % RH

**Polarity:** Ver. / Hor.

Frequency (MHz)	Reading (Peak) (dBuV)	Reading (Average) (dBuV)	Correction Factor (dB/m)	Result (Peak) (dBuV/m)	Result (Average) (dBuV/m)	Limit (Peak) (dBuV/m)	Limit (Average) (dBuV/m)	Margin (dB)	Remark	Ant. Pol. (H/V)
1280.00	62.16	---	-10.78	51.38	---	74.00	54.00	-2.62	Peak	V
N/A										
1280.00	63.92	56.30	-10.78	53.14	45.52	74.00	54.00	-8.48	AVG	H
2360.00	62.35	51.76	-4.44	57.90	47.32	74.00	54.00	-6.68	AVG	H
N/A										

**Remark:**

1. Measuring frequencies from 1 GHz to the 10th harmonic of highest fundamental frequency.
2. Radiated emissions measured in frequency above 1000MHz were made with an instrument using peak/average detector mode.
3. Average test would be performed if the peak result were greater than the average limit or as required by the applicant.
4. Data of measurement within this frequency range shown “ --- ” in the table above means the reading of emissions are attenuated more than 20dB below the permissible limits or the field strength is too small to be measured.
5. Measurements above show only up to 6 maximum emissions noted, or would be lesser, with “ N/A ” remark, if no specific emissions from the EUT are recorded (ie: margin>20dB from the applicable limit) and considered that's already beyond the background noise floor.
6. Margin (dB) = Remark result (dBuV/m) – Average limit (dBuV/m).





**Operation Mode:** TX / IEEE 802.11n HT 20 MHz mode / CH Mid **Test Date:** July 15, 2011

**Temperature:** 24°C

**Tested by:** Ali Shu

**Humidity:** 40 % RH

**Polarity:** Ver. / Hor.

Frequency (MHz)	Reading (Peak) (dBuV)	Reading (Average) (dBuV)	Correction Factor (dB/m)	Result (Peak) (dBuV/m)	Result (Average) (dBuV/m)	Limit (Peak) (dBuV/m)	Limit (Average) (dBuV/m)	Margin (dB)	Remark	Ant. Pol. (H/V)
1280.00	58.65	---	-10.78	47.87	---	74.00	54.00	-6.13	Peak	V
2493.33	59.47	49.59	-3.90	55.57	45.69	74.00	54.00	-8.31	AVG	V
N/A										
1280.00	62.51	---	-10.78	51.73	---	74.00	54.00	-2.27	Peak	H
2493.33	63.48	54.03	-3.90	59.58	50.13	74.00	54.00	-3.87	AVG	H
2510.00	61.57	50.08	-3.84	57.74	46.24	74.00	54.00	-7.76	AVG	H
N/A										

**Remark:**

1. Measuring frequencies from 1 GHz to the 10th harmonic of highest fundamental frequency.
2. Radiated emissions measured in frequency above 1000MHz were made with an instrument using peak/average detector mode.
3. Average test would be performed if the peak result were greater than the average limit or as required by the applicant.
4. Data of measurement within this frequency range shown “ --- ” in the table above means the reading of emissions are attenuated more than 20dB below the permissible limits or the field strength is too small to be measured.
5. Measurements above show only up to 6 maximum emissions noted, or would be lesser, with “ N/A ” remark, if no specific emissions from the EUT are recorded (ie: margin > 20dB from the applicable limit) and considered that's already beyond the background noise floor.
6. Margin (dB) = Remark result (dBuV/m) – Average limit (dBuV/m).



**Operation Mode:** TX / IEEE 802.11n HT 20 MHz mode / CH High **Test Date:** July 15, 2011

**Temperature:** 24°C

**Tested by:** Ali Shu

**Humidity:** 40 % RH

**Polarity:** Ver. / Hor.

Frequency (MHz)	Reading (Peak) (dBuV)	Reading (Average) (dBuV)	Correction Factor (dB/m)	Result (Peak) (dBuV/m)	Result (Average) (dBuV/m)	Limit (Peak) (dBuV/m)	Limit (Average) (dBuV/m)	Margin (dB)	Remark	Ant. Pol. (H/V)
1490.00	56.68	---	-10.56	46.12	---	74.00	54.00	-7.88	Peak	V
N/A										
1280.00	62.34	---	-10.78	51.57	---	74.00	54.00	-2.43	Peak	H
2516.67	62.74	52.59	-3.81	58.93	48.78	74.00	54.00	-5.22	AVG	H
N/A										

**Remark:**

1. Measuring frequencies from 1 GHz to the 10th harmonic of highest fundamental frequency.
2. Radiated emissions measured in frequency above 1000MHz were made with an instrument using peak/average detector mode.
3. Average test would be performed if the peak result were greater than the average limit or as required by the applicant.
4. Data of measurement within this frequency range shown “ --- ” in the table above means the reading of emissions are attenuated more than 20dB below the permissible limits or the field strength is too small to be measured.
5. Measurements above show only up to 6 maximum emissions noted, or would be lesser, with “ N/A ” remark, if no specific emissions from the EUT are recorded (ie: margin > 20dB from the applicable limit) and considered that's already beyond the background noise floor.
6. Margin (dB) = Remark result (dBuV/m) – Average limit (dBuV/m).



**Operation Mode:** TX / IEEE 802.11n HT 40 MHz mode  
/ CH Low  
**Temperature:** 24°C  
**Humidity:** 40 % RH

**Test Date:** July 15, 2011  
**Tested by:** Ali Shu  
**Polarity:** Ver. / Hor.

Frequency (MHz)	Reading (Peak) (dBuV)	Reading (Average) (dBuV)	Correction Factor (dB/m)	Result (Peak) (dBuV/m)	Result (Average) (dBuV/m)	Limit (Peak) (dBuV/m)	Limit (Average) (dBuV/m)	Margin (dB)	Remark	Ant. Pol. (H/V)
1280.00	59.13	---	-10.78	48.35	---	74.00	54.00	-5.65	Peak	V
N/A										
1440.00	61.41	---	-10.61	50.79	---	74.00	54.00	-3.21	Peak	H
2526.67	61.29	49.89	-3.78	57.51	46.11	74.00	54.00	-7.89	AVG	H
N/A										

**Remark:**

1. Measuring frequencies from 1 GHz to the 10th harmonic of highest fundamental frequency.
2. Radiated emissions measured in frequency above 1000MHz were made with an instrument using peak/average detector mode.
3. Average test would be performed if the peak result were greater than the average limit or as required by the applicant.
4. Data of measurement within this frequency range shown " --- " in the table above means the reading of emissions are attenuated more than 20dB below the permissible limits or the field strength is too small to be measured.
5. Measurements above show only up to 6 maximum emissions noted, or would be lesser, with " N/A " remark, if no specific emissions from the EUT are recorded (ie: margin > 20dB from the applicable limit) and considered that's already beyond the background noise floor.
6. Margin (dB) = Remark result (dBuV/m) – Average limit (dBuV/m).



**Operation Mode:** TX / IEEE 802.11n HT 40 MHz mode  
/ CH Mid  
**Temperature:** 24°C  
**Humidity:** 40 % RH

**Test Date:** July 15, 2011  
**Tested by:** Ali Shu  
**Polarity:** Ver. / Hor.

Frequency (MHz)	Reading (Peak) (dBuV)	Reading (Average) (dBuV)	Correction Factor (dB/m)	Result (Peak) (dBuV/m)	Result (Average) (dBuV/m)	Limit (Peak) (dBuV/m)	Limit (Average) (dBuV/m)	Margin (dB)	Remark	Ant. Pol. (H/V)
1280.00	60.57	---	-10.78	49.79	---	74.00	54.00	-4.21	Peak	V
N/A										
1280.00	61.54	---	-10.78	50.77	---	74.00	54.00	-3.23	Peak	H
N/A										

**Remark:**

1. Measuring frequencies from 1 GHz to the 10th harmonic of highest fundamental frequency.
2. Radiated emissions measured in frequency above 1000MHz were made with an instrument using peak/average detector mode.
3. Average test would be performed if the peak result were greater than the average limit or as required by the applicant.
4. Data of measurement within this frequency range shown " --- " in the table above means the reading of emissions are attenuated more than 20dB below the permissible limits or the field strength is too small to be measured.
5. Measurements above show only up to 6 maximum emissions noted, or would be lesser, with " N/A " remark, if no specific emissions from the EUT are recorded (ie: margin > 20dB from the applicable limit) and considered that's already beyond the background noise floor.
6. Margin (dB) = Remark result (dBuV/m) – Average limit (dBuV/m).



**Operation Mode:** TX / IEEE 802.11n HT 40 MHz mode  
/ CH High  
**Temperature:** 24°C  
**Humidity:** 40 % RH

**Test Date:** July 15, 2011  
**Tested by:** Ali Shu  
**Polarity:** Ver. / Hor.

Frequency (MHz)	Reading (Peak) (dBuV)	Reading (Average) (dBuV)	Correction Factor (dB/m)	Result (Peak) (dBuV/m)	Result (Average) (dBuV/m)	Limit (Peak) (dBuV/m)	Limit (Average) (dBuV/m)	Margin (dB)	Remark	Ant. Pol. (H/V)
1280.00	60.13	---	-10.78	49.35	---	74.00	54.00	-4.65	Peak	V
N/A										
1280.00	61.19	---	-10.78	50.41	---	74.00	54.00	-3.59	Peak	H
2346.67	58.41	48.17	-4.50	53.91	43.67	74.00	54.00	-10.33	AVG	H
2556.67	58.39	47.71	-3.68	54.72	44.03	74.00	54.00	-9.97	AVG	H
N/A										

**Remark:**

1. Measuring frequencies from 1 GHz to the 10th harmonic of highest fundamental frequency.
2. Radiated emissions measured in frequency above 1000MHz were made with an instrument using peak/average detector mode.
3. Average test would be performed if the peak result were greater than the average limit or as required by the applicant.
4. Data of measurement within this frequency range shown " --- " in the table above means the reading of emissions are attenuated more than 20dB below the permissible limits or the field strength is too small to be measured.
5. Measurements above show only up to 6 maximum emissions noted, or would be lesser, with " N/A " remark, if no specific emissions from the EUT are recorded (ie: margin > 20dB from the applicable limit) and considered that's already beyond the background noise floor.
6. Margin (dB) = Remark result (dBuV/m) – Average limit (dBuV/m).



## 7.8 POWERLINE CONDUCTED EMISSIONS

### LIMIT

According to §15.207(a), except as shown in paragraphs (b) and (c) of this section, for an intentional radiator that is designed to be connected to the public utility (AC) power line, the radio frequency voltage that is conducted back onto the AC power line on any frequency or frequencies within the band 150 kHz to 30 MHz shall not exceed the limits in the following table, as measured using a 50  $\mu$ H/50 ohms line impedance stabilization network (LISN). Compliance with the provisions of this paragraph shall be based on the measurement of the radio frequency voltage between each power line and ground at the power terminal. The lower limit applies at the boundary between the frequency ranges.

Frequency Range (MHz)	Limits (dB $\mu$ V)	
	Quasi-peak	Average
0.15 to 0.50	66 to 56*	56 to 46*
0.50 to 5	56	46
5 to 30	60	50

\* Decreases with the logarithm of the frequency.

### Test Configuration

See test photographs attached in Appendix 1 for the actual connections between EUT and support equipment.

### TEST PROCEDURE

1. The EUT was placed on a table, which is 0.8m above ground plane.
2. Maximum procedure was performed on the six highest emissions to ensure EUT compliance.
3. Repeat above procedures until all frequency measured were complete.



## TEST RESULTS

The initial step in collecting conducted data is a spectrum analyzer peak scan of the measurement range. Significant peaks are then marked as shown on the following data page, and these signals are then quasi-peaked.

### Test Data

**Operation Mode:** Normal Link                      **Test Date:** November 27, 2012  
**Temperature:** 22°C                                      **Tested by:** Andy Lin  
**Humidity:** 55% RH

Frequency (MHz)	Reading (dBuV)	Factor (dB)	Result (dBuV)	Limit (dBuV)	Margin (dB)	Detector	Note
0.1882	38.90	10.04	48.94	64.11	-15.17	QP	L1
0.1882	33.70	10.04	43.74	54.11	-10.37	AVG	L1
0.2540	34.32	10.03	44.35	61.62	-17.27	QP	L1
0.2540	32.52	10.03	42.55	51.62	-9.07	AVG	L1
0.3830	33.28	10.04	43.32	58.21	-14.89	QP	L1
0.3830	31.04	10.04	41.08	48.21	-7.13	AVG	L1
0.9260	28.47	10.08	38.55	56.00	-17.45	QP	L1
0.9260	21.32	10.08	31.40	46.00	-14.60	AVG	L1
16.1659	38.60	10.72	49.32	60.00	-10.68	QP	L1
16.1659	33.23	10.72	43.95	50.00	-6.05	AVG	L1
26.6099	30.86	11.08	41.94	60.00	-18.06	QP	L1
26.6099	26.76	11.08	37.84	50.00	-12.16	AVG	L1
0.1873	39.15	10.04	49.19	64.15	-14.96	QP	L2
0.1873	33.54	10.04	43.58	54.15	-10.57	AVG	L2
0.2460	34.37	10.03	44.40	61.89	-17.49	QP	L2
0.2460	31.59	10.03	41.62	51.89	-10.27	AVG	L2
0.3820	33.08	10.04	43.12	58.23	-15.11	QP	L2
0.3820	32.67	10.04	42.71	48.23	-5.52	AVG	L2
0.8700	28.62	10.07	38.69	56.00	-17.31	QP	L2
0.8700	22.86	10.07	32.93	46.00	-13.07	AVG	L2
16.2259	39.14	10.72	49.86	60.00	-10.14	QP	L2
16.2259	34.32	10.72	45.04	50.00	-4.96	AVG	L2
26.6100	30.73	11.08	41.81	60.00	-18.19	QP	L2
26.6100	27.35	11.08	38.43	50.00	-11.57	AVG	L2

### **Remark:**

1. Measuring frequencies from 0.15 MHz to 30MHz.
2. The emissions measured in frequency range from 0.15 MHz to 30MHz were made with an instrument using Quasi-peak detector and average detector.
3. The IF bandwidth of SPA between 0.15MHz and 30MHz was 10 kHz; the IF bandwidth of Test Receiver between 0.15MHz and 30MHz was 9 kHz;
4. L1 = Line One (Live Line) / L2 = Line Two (Neutral Line)



### Test Plots

#### Conducted emissions (Line 1)

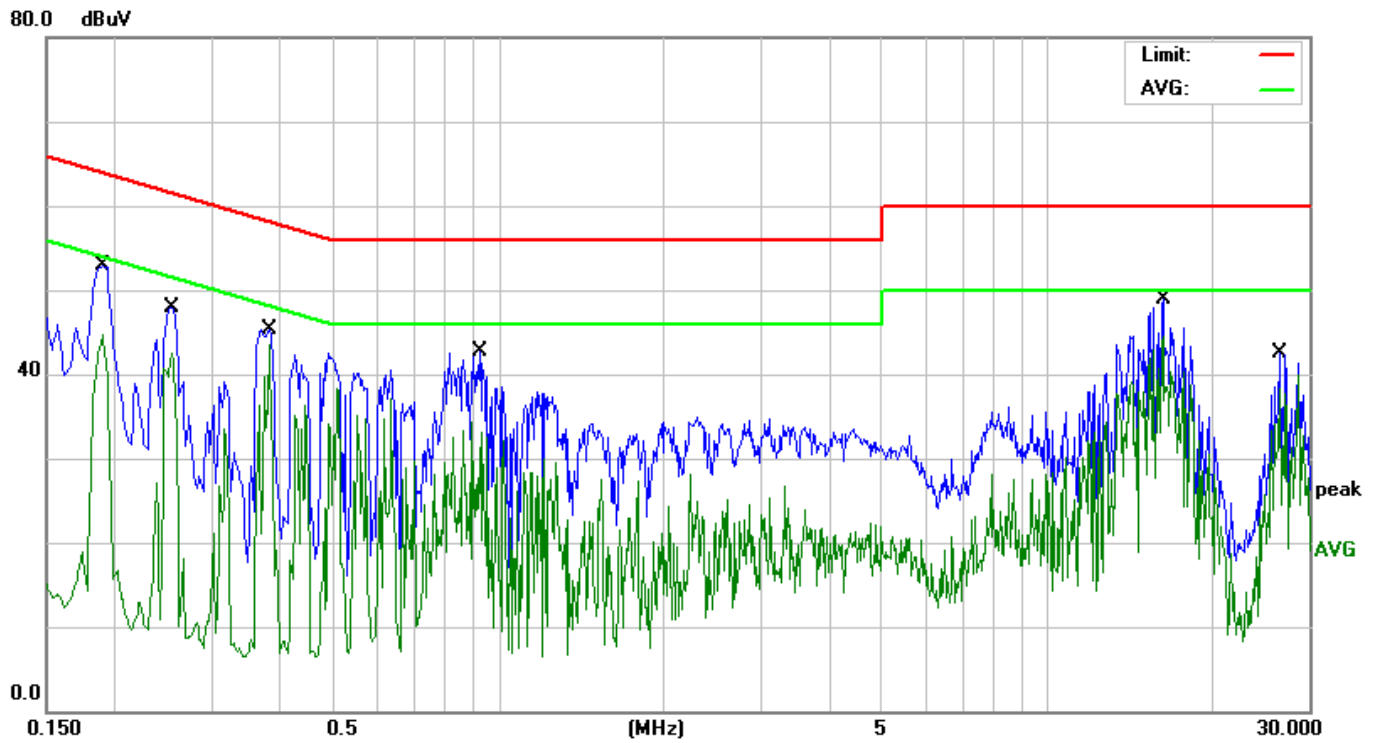

#### Conducted emissions (Line 2)

