



FCC 47 CFR PART 15 SUBPART C

TEST REPORT

For

Home Monitoring Gateway

Model: NA900

Trade Name: SerComm

Issued to

SerComm Corporation
8F, No.3-1, YuanQu St., NanKang,
Taipei 115, Taiwan, R.O.C.

Issued by

Compliance Certification Services Inc.
No. 11, Wu-Gong 6th Rd., Wugu Industrial Park,
Taipei Hsien 248, Taiwan (R.O.C.)
<http://www.ccsrf.com>
service@ccsrf.com
Issued Date: June 14, 2011



Note: This report shall not be reproduced except in full, without the written approval of Compliance Certification Services Inc. This document may be altered or revised by Compliance Certification Services Inc. personnel only, and shall be noted in the revision section of the document.



Revision History

Rev.	Issue Date	Revisions	Effect Page	Revised By
00	June 14, 2011	Initial Issue	ALL	Jessica Ho



TABLE OF CONTENTS

1. TEST RESULT CERTIFICATION.....	4
2. EUT DESCRIPTION	5
3. TEST METHODOLOGY	6
3.1 EUT CONFIGURATION	6
3.2 EUT EXERCISE.....	6
3.3 GENERAL TEST PROCEDURES.....	6
3.4 FCC PART 15.205 RESTRICTED BANDS OF OPERATIONS.....	7
3.5 DESCRIPTION OF TEST MODES	8
4. INSTRUMENT CALIBRATION.....	9
4.1 MEASURING INSTRUMENT CALIBRATION	9
4.2 MEASUREMENT EQUIPMENT USED	9
4.3 MEASUREMENT UNCERTAINTY	10
5. FACILITIES AND ACCREDITATIONS	11
5.1 FACILITIES	11
5.2 EQUIPMENT.....	11
5.3 TABLE OF ACCREDITATIONS AND LISTINGS.....	12
6. SETUP OF EQUIPMENT UNDER TEST	13
6.1 SETUP CONFIGURATION OF EUT.....	13
6.2 SUPPORT EQUIPMENT	13
7. FCC PART 15.247 REQUIREMENTS.....	14
7.1 6DB BANDWIDTH.....	14
7.2 PEAK POWER.....	34
7.3 AVERAGE POWER	36
7.4 BAND EDGES MEASUREMENT	38
7.5 PEAK POWER SPECTRAL DENSITY.....	55
7.6 SPURIOUS EMISSIONS.....	75
7.7 RADIATED EMISSIONS	94
7.8 POWERLINE CONDUCTED EMISSIONS.....	111
APPENDIX I RADIO FREQUENCY EXPOSURE.....	114
APPENDIX II PHOTOGRAPHS OF TEST SETUP.....	117
APPENDIX 1 - PHOTOGRAPHS OF EUT	



1. TEST RESULT CERTIFICATION

Applicant: SerComm Corporation
8F, No.3-1, YuanQu St., NanKang,
Taipei 115, Taiwan, R.O.C.

Equipment Under Test: Home Monitoring Gateway

Trade Name: SerComm

Model Number: NA900

Date of Test: May 27 ~ June 14, 2011

APPLICABLE STANDARDS	
STANDARD	TEST RESULT
FCC 47 CFR Part 15 Subpart C	No non-compliance noted

We hereby certify that:

The above equipment was tested by Compliance Certification Services Inc. The test data, data evaluation, test procedures, and equipment configurations shown in this report were made in accordance with the procedures given in ANSI C63.4: 2003 and the energy emitted by the sample EUT tested as described in this report is in compliance with the requirements of FCC Rules Part 15.207, 15.209, 15.247.

The test results of this report relate only to the tested sample EUT identified in this report.

Approved by:

Rex Lai
Section Manager
Compliance Certification Services Inc.

Reviewed by:

Gina Lo
Section Manager
Compliance Certification Services Inc.



2. EUT DESCRIPTION

Product	Home Monitoring Gateway	
Trade Name	SerComm	
Model Number	NA900	
Model Discrepancy	N/A	
Received Date	May 5, 2011	
Power Adapter	1. LEADER / MU12-G120100-A1 I/P: 100-240V, 50-60Hz, 0.5A O/P: 12V, 1 A 2. Sunny / SYS1381-1212-W2 I/P: 100-240V, 50-60Hz, 0.5A O/P: 12V, 1 A	
Frequency Range	2412 ~ 2462 MHz	
Transmit Power	IEEE 802.11b mode: 21.03dBm IEEE 802.11g mode: 25.68 dBm IEEE 802.11n HT 20 MHz mode: 26.71 dBm IEEE 802.11n HT 40 MHz mode: 26.94 dBm	
Modulation Technique	IEEE 802.11b mode: DSSS IEEE 802.11g mode: OFDM IEEE 802.11n HT 20 MHz mode: OFDM IEEE 802.11n HT 40 MHz mode: OFDM	
Number of Channels	IEEE 802.11b/g mode: 11 Channels IEEE 802.11n HT 20 MHz mode: 11 Channels IEEE 802.11n HT 40 MHz mode: 7 Channels	
Antenna Specification	PIFA Antenna:	
	Right	Gain: 3.3 dBi
	Left	Gain: 3.8 dBi
	MIMO Mode: 3.8 dBi + 10 log (2) = 6.81 dBi (Numeric gain: 4.79)	

Remark:

1. The sample selected for test was engineering sample that approximated to production product and was provided by manufacturer.
2. This submittal(s) (test report) is intended for FCC ID: **P27NA900B** filing to comply with Section 15.207, 15.209 and 15.247 of the FCC Part 15, Subpart C Rules.



3. TEST METHODOLOGY

The tests documented in this report were performed in accordance with ANSI C63.4 and FCC CFR 47 2.1046, 2.1047, 2.1049, 2.1051, 2.1053, 2.1055, 2.1057, 15.207, 15.209 and 15.247.

3.1 EUT CONFIGURATION

The EUT configuration for testing is installed on RF field strength measurement to meet the Commissions requirement and operating in a manner that intends to maximize its emission characteristics in a continuous normal application.

3.2 EUT EXERCISE

The EUT was operated in the engineering mode to fix the TX frequency that was for the purpose of the measurements.

According to its specifications, the EUT must comply with the requirements of the Section 15.207, 15.209 and 15.247 under the FCC Rules Part 15 Subpart C.

3.3 GENERAL TEST PROCEDURES

Conducted Emissions

The EUT is placed on the turntable, which is 0.8 m above ground plane. According to the requirements in Section 13.1.4.1 of ANSI C63.4 Conducted emissions from the EUT measured in the frequency range between 0.15 MHz and 30MHz using CISPR Quasi-peak and average detector modes.

Radiated Emissions

The EUT is placed on a turn table, which is 0.8 m above ground plane. The turntable shall rotate 360 degrees to determine the position of maximum emission level. EUT is set 3m away from the receiving antenna, which varied from 1m to 4m to find out the highest emission. And also, each emission was to be maximized by changing the polarization of receiving antenna both horizontal and vertical. In order to find out the maximum emissions, exploratory radiated emission measurements were made according to the requirements in Section 13.1.4.1 of ANSI C63.4.



3.4 FCC PART 15.205 RESTRICTED BANDS OF OPERATIONS

- (a) Except as shown in paragraph (d) of this section, only spurious emissions are permitted in any of the frequency bands listed below:

MHz	MHz	MHz	GHz
0.090 - 0.110	16.42 - 16.423	399.9 - 410	4.5 - 5.15
¹ 0.495 - 0.505	16.69475 - 16.69525	608 - 614	5.35 - 5.46
2.1735 - 2.1905	16.80425 - 16.80475	960 - 1240	7.25 - 7.75
4.125 - 4.128	25.5 - 25.67	1300 - 1427	8.025 - 8.5
4.17725 - 4.17775	37.5 - 38.25	1435 - 1626.5	9.0 - 9.2
4.20725 - 4.20775	73 - 74.6	1645.5 - 1646.5	9.3 - 9.5
6.215 - 6.218	74.8 - 75.2	1660 - 1710	10.6 - 12.7
6.26775 - 6.26825	108 - 121.94	1718.8 - 1722.2	13.25 - 13.4
6.31175 - 6.31225	123 - 138	2200 - 2300	14.47 - 14.5
8.291 - 8.294	149.9 - 150.05	2310 - 2390	15.35 - 16.2
8.362 - 8.366	156.52475 -	2483.5 - 2500	17.7 - 21.4
8.37625 - 8.38675	156.52525	2655 - 2900	22.01 - 23.12
8.41425 - 8.41475	156.7 - 156.9	3260 - 3267	23.6 - 24.0
12.29 - 12.293	162.0125 - 167.17	3332 - 3339	31.2 - 31.8
12.51975 - 12.52025	167.72 - 173.2	3345.8 - 3358	36.43 - 36.5
12.57675 - 12.57725	240 - 285	3600 - 4400	(²)
13.36 - 13.41	322 - 335.4		

¹ Until February 1, 1999, this restricted band shall be 0.490-0.510 MHz.

² Above 38.6

- (b) Except as provided in paragraphs (d) and (e), the field strength of emissions appearing within these frequency bands shall not exceed the limits shown in Section 15.209. At frequencies equal to or less than 1000 MHz, compliance with the limits in Section 15.209 shall be demonstrated using measurement instrumentation employing a CISPR quasi-peak detector. Above 1000 MHz, compliance with the emission limits in Section 15.209 shall be demonstrated based on the average value of the measured emissions. The provisions in Section 15.35 apply to these measurements.



3.5 DESCRIPTION OF TEST MODES

The EUT (model: NA900) comes with two types of power adapter (LEADER & Sunny) for sale. After the preliminary test, the EUT with power adapter (Model: MU12-G120100-A1) was found to emit the worst emissions and therefore had been tested under operating condition.

The EUT is a 2x2 configuration spatial MIMO (2Tx & 2Rx) without beam forming function that operate in double TX chains and double RX chains. The 2x2 configuration is implemented with two outside TX & RX chains (Chain 0 and 1).

Software used to control the EUT for staying in continuous transmitting mode was programmed.

After verification, all tests were carried out with the worst case test modes as shown below except radiated spurious emission below 1GHz and power line conducted emissions below 30MHz, which worst case was in normal link mode only.

IEEE 802.11b mode:

Channel Low (2412MHz), Channel Mid (2437MHz) and Channel High (2462MHz) with 1Mbps data rate and cyclic delay diversity were chosen for full testing.

IEEE 802.11g mode:

Channel Low (2412MHz), Channel Mid (2437MHz) and Channel High (2462MHz) with 6Mbps data rate and cyclic delay diversity were chosen for full testing.

IEEE 802.11n HT 20 MHz mode:

Channel Low (2412MHz), Channel Mid (2437MHz) and Channel High (2462MHz) with 6.5Mbps data rate were chosen for full testing.

IEEE 802.11n HT 40 MHz mode:

Channel Low (2422MHz), Channel Mid (2437MHz) and Channel High (2452MHz) with 13.5Mbps data rate were chosen for full testing.

The field strength of spurious emission was measured in the following position: EUT stand-up position (Z axis), lie-down position (X, Y axis). The worst emission was found lie-down position (X axis) and the worst case was recorded.



4. INSTRUMENT CALIBRATION

4.1 MEASURING INSTRUMENT CALIBRATION

The measuring equipment, which was utilized in performing the tests documented herein, has been calibrated in accordance with the manufacturer's recommendations for utilizing calibration equipment, which is traceable to recognized national standards.

4.2 MEASUREMENT EQUIPMENT USED

Equipment Used for Emissions Measurement

Remark: Each piece of equipment is scheduled for calibration once a year and Loop Antenna is scheduled for calibration once three years.

Conducted Emissions Test Site				
Name of Equipment	Manufacturer	Model	Serial Number	Calibration Due
Spectrum Analyzer	Agilent	E4446A	MY43360131	03/02/2012
Power Meter	Anritsu	ML2495A	1012009	03/27/2012
Power Sensor	Anritsu	MA2411B	0917072	03/08/2012

Wugu 966 Chamber A				
Name of Equipment	Manufacturer	Model	Serial Number	Calibration Due
Spectrum Analyzer	Agilent	E4446A	US42510252	11/03/2011
EMI Test Receiver	R&S	ESCI	100064	02/03/2012
Pre-Amplifier	Mini-Circuits	ZFL-1000LN	SF350700823	01/12/2012
Pre-Amplifier	MITEQ	AFS44-00102650-42-10P-44	1415367	11/19/2011
Bilog Antenna	Sunol Sciences	JB3	A030105	10/06/2011
Horn Antenna	EMCO	3117	00055165	01/12/2012
Loop Antenna	EMCO	6502	8905/2356	06/10/2013
Turn Table	CCS	CC-T-1F	N/A	N.C.R
Antenna Tower	CCS	CC-A-1F	N/A	N.C.R
Controller	CCS	CC-C-1F	N/A	N.C.R
Site NSA	CCS	N/A	N/A	12/26/2011
Test S/W	EZ-EMC (CCS-3A1RE)			

Conducted Emission room # B				
Name of Equipment	Manufacturer	Model	Serial Number	Calibration Due
TEST RECEIVER	R&S	ESCI	100234	06/12/2012
LISN (EUT)	FCC	FCC-LISN-50-32-2	08009	03/27/2012
LISN	SCHWARZBECK	NSLK 8127	8127382	01/02/2012
BNC CABLE	MIYAZAKI	5D-FB	BNC B3	08/10/2011
Pulse Limiter	R&S	ESH3-Z2	100374	01/09/2012
THERMO-HYGRO METER	WISEWIND	201A	1006	05/23/2012
LISN	SCHAFFNER	NNB 41	03/10013	N.C.R.
Test S/W	EZ-EMC			



4.3 MEASUREMENT UNCERTAINTY

PARAMETER	UNCERTAINTY
Powerline Conducted Emission	+/- 1.1089
3M Semi Anechoic Chamber / 30M~200M	+/- 4.0606
3M Semi Anechoic Chamber / 200M~1000M	+/- 3.9979
3M Semi Anechoic Chamber / 1G~8G	+/- 2.5790
3M Semi Anechoic Chamber / 8G~18G	+/- 2.5928
3M Semi Anechoic Chamber / 18G~26G	+/- 2.7212
3M Semi Anechoic Chamber / 26G~40G	+/- 2.9520

Remark: This uncertainty represents an expanded uncertainty expressed at approximately the 95% confidence level using a coverage factor of $k=2$.



5. FACILITIES AND ACCREDITATIONS

5.1 FACILITIES

All measurement facilities used to collect the measurement data are located at

No.199, Chunghsen Road, Hsintien City, Taipei Hsien, Taiwan, R.O.C.

Tel: 886-2-2217-0894 / Fax: 886-2-2217-1029

Remark: The radiated emissions test items was tested at Compliance Certification Services Inc. (Hsintien Lab.) The test equipments were listed in page 9 and the test data, please refer page 112-113

No.11, Wugong 6th Rd., Wugu Industrial Park, Taipei Hsien 248, Taiwan

Tel: 886-2-2299-9720 / Fax: 886-2-2298-4045

No.81-1, Lane 210, Bade 2nd Rd., Luchu Hsiang, Taoyuan Hsien 338, Taiwan

Tel: 886-3-324-0332 / Fax: 886-3-324-5235

The sites are constructed in conformance with the requirements of ANSI C63.7, ANSI C63.4 and CISPR Publication 22.

5.2 EQUIPMENT

Radiated emissions are measured with one or more of the following types of linearly polarized antennas: tuned dipole, biconical, log periodic, bi-log, and/or ridged waveguide, horn. Spectrum analyzers with pre-selectors and quasi-peak detectors are used to perform radiated measurements.



Conducted emissions are measured with Line Impedance Stabilization Networks and EMI Test Receivers.

Calibrated wideband preamplifiers, coaxial cables, and coaxial attenuators are also used for making measurements.

All receiving equipment conforms to CISPR Publication 16-1, "Radio Interference Measuring Apparatus and Measurement Methods."



5.3 TABLE OF ACCREDITATIONS AND LISTINGS

Country	Agency	Scope of Accreditation	Logo
USA	FCC	3M Semi Anechoic Chamber (FCC MRA: TW1039) to perform FCC Part 15 measurements	 FCC MRA: TW1039
Taiwan	TAF	LP0002, RTTE01, FCC Method-47 CFR Part 15 Subpart C, D, E, RSS-210, RSS-310 IDA TS SRD, AS/NZS 4268, AS/NZS 4771, TS 12.1 & 12.2, ETSI EN 300 440-1, ETSI EN 300 440-2, ETSI EN 300 328, ETSI EN 300 220-1, ETSI EN 300 220-2, ETSI EN 301 893, ETSI EN 301 489-1/3/7/17 FCC OET Bulletin 65 + Supplement C, EN 50360, EN 50361, EN 50371, RSS 102, EN 50383, EN 50385, EN 50392, IEC 62209, CNS 14958-1, CNS 14959 FCC Method -47 CFR Part 15 Subpart B IEC / EN 61000-3-2, IEC / EN 61000-3-3, IEC / EN 61000-4-2/3/4/5/6/8/11	
Canada	Industry Canada	3M Semi Anechoic Chamber (IC 2324G-1 / IC 2324G-2) to perform	 IC 2324G-1 IC 2324G-2

* No part of this report may be used to claim or imply product endorsement by A2LA or any agency of the US Government.



6. SETUP OF EQUIPMENT UNDER TEST

6.1 SETUP CONFIGURATION OF EUT

See test photographs attached in Appendix II for the actual connections between EUT and support equipment.

6.2 SUPPORT EQUIPMENT

No	Equipment	Brand	Model	Series No.	FCC ID	Data Cable	Power Cord
1.	USB 2.0 HDD	TeraSys	F12-U	N/A	BSMI ID: 4912A002	Shielded, 1.8m	N/A
2.	USB 2.0 HDD	TeraSys	F12-U	N/A	BSMI ID: 4912A002	Shielded, 1.8m	N/A
3.	USB Mouse	hp	M-UAE96	F93A90A5BU90L 20	DOC BSMI: T41126	Shielded, 1.8m	N/A
4.	USB Keyboard	hp	KU-0316	BC3870FVBWH0 79	DOC BSMI: R33001	Shielded, 1.8m	N/A
5.	Printer	HP	Deskjet D2360	TH73C1492F	DOC BSMI: R33001	Shielded, 1.8m	Unshielded, 1.8m
6.	Monitor	SAMSUNG	933SN+	N/A	DOC BSMI: R33475	Shielded, 1.8m with two cores	Unshielded, 1.8m
7.	Host PC	HP	HD075AV	SGH948QGVX	DOC BSMI: R33001	Unshielded, 1.0m	Unshielded, 1.8m
8.	Modem	GALILEO	AL-56ERM	0MERM04A0212	DOC	Shielded, 1.0m	Unshielded, 1.8m
9.	Server PC	HP	HD075AV	SGH948QGVW	DOC BSMI: R33001	Unshielded, 20m	Unshielded, 1.8m
10.	LAN Cable	N/A	N/A	N/A	N/A	Unshielded, 3.0m X3	N/A
11.	Notebook PC (Remote)	DELL	PP19L	GK102 A00	QDS-BRCM1021	N/A	AC I/P: Unshielded, 1.8m DC O/P: Unshielded, 1.8m with a core

Remark:

1. All the equipment/cables were placed in the worst-case configuration to maximize the emission during the test.
2. Grounding was established in accordance with the manufacturer's requirements and conditions for the intended use.



7. FCC PART 15.247 REQUIREMENTS

7.1 6DB BANDWIDTH

LIMIT

According to §15.247(a)(2), systems using digital modulation techniques may operate in the 902 - 928 MHz, 2400 - 2483.5 MHz, and 5725 - 5850 MHz bands. The minimum 6dB bandwidth shall be at least 500 kHz.

Test Configuration

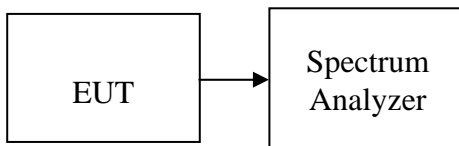

TEST PROCEDURE

1. Place the EUT on the table and set it in the transmitting mode.
2. Remove the antenna from the EUT and then connect a low loss RF cable from the antenna port to the spectrum analyzer.
3. Set the spectrum analyzer as RBW = 100 kHz, VBW = RBW, Span = 50 MHz, Sweep = auto.
4. Mark the peak frequency and -6dB (upper and lower) frequency.
5. Repeat until all the rest channels are investigated.

TEST RESULTS

No non-compliance noted



Test Data

Test mode: IEEE 802.11b mode

Channel	Frequency (MHz)	6dB Bandwidth (MHz)	Limit (kHz)	Result
Low	2412	12.3333	>500	PASS
Mid	2437	12.3333		PASS
High	2462	12.3333		PASS

Test mode: IEEE 802.11g mode

Channel	Frequency (MHz)	6dB Bandwidth (MHz)	Limit (kHz)	Result
Low	2412	16.6667	>500	PASS
Mid	2437	16.5834		PASS
High	2462	16.5834		PASS

Test mode: IEEE 802.11n HT 20 MHz mode / Chain 0

Channel	Frequency (MHz)	6dB Bandwidth (MHz)	Limit (kHz)	Result
Low	2412	17.75	>500	PASS
Mid	2437	17.75		PASS
High	2462	17.75		PASS

Test mode: IEEE 802.11n HT 20 MHz mode / Chain 1

Channel	Frequency (MHz)	6dB Bandwidth (MHz)	Limit (kHz)	Result
Low	2412	17.75	>500	PASS
Mid	2437	17.75		PASS
High	2462	17.75		PASS

Test mode: IEEE 802.11n HT 40 MHz mode / Chain 0

Channel	Frequency (MHz)	6dB Bandwidth (MHz)	Limit (kHz)	Result
Low	2422	36.25	>500	PASS
Mid	2437	36.25		PASS
High	2452	36.25		PASS

Test mode: IEEE 802.11n HT 40 MHz mode / Chain 1

Channel	Frequency (MHz)	6dB Bandwidth (MHz)	Limit (kHz)	Result
Low	2422	35.8333	>500	PASS
Mid	2437	35.8333		PASS
High	2452	35.8333		PASS

Remark: Total Output Power (w) = Chain 0 (10^(Output Power /10)/1000)+ Chain 1 (10^(Output Power /10)/1000)



IEEE 802.11b mode

6dB Bandwidth (CH Low)

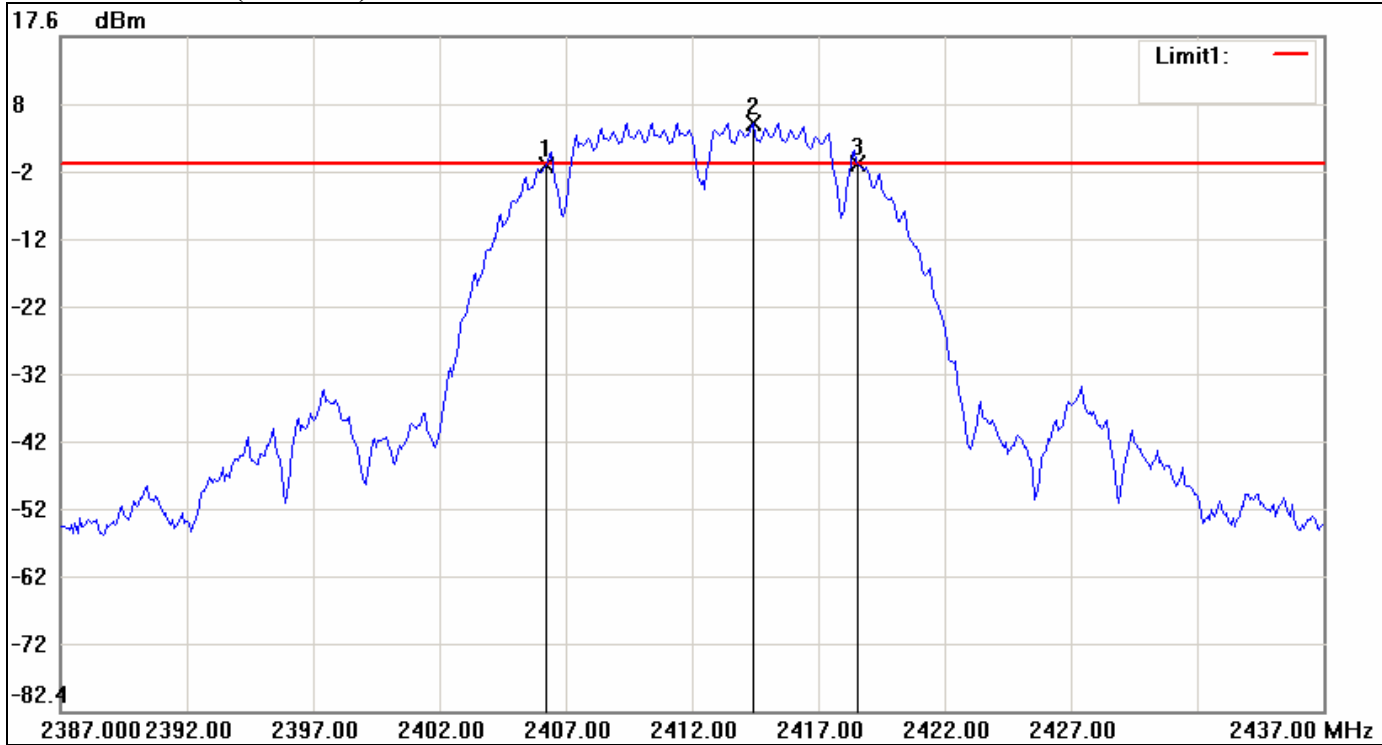

No.	Frequency(MHz)	Level(dBm)	Limit(dBm)	Margin(dBm)
1	2406.2500	-1.61	-1.20	-0.41
2	2414.4167	4.80	-1.20	6.00
3	2418.5833	-1.29	-1.20	-0.09

No.		Δ Frequency(MHz)	Δ Level(dB)
1	mk3-mk1	12.3333	0.32



6dB Bandwidth (CH Mid)

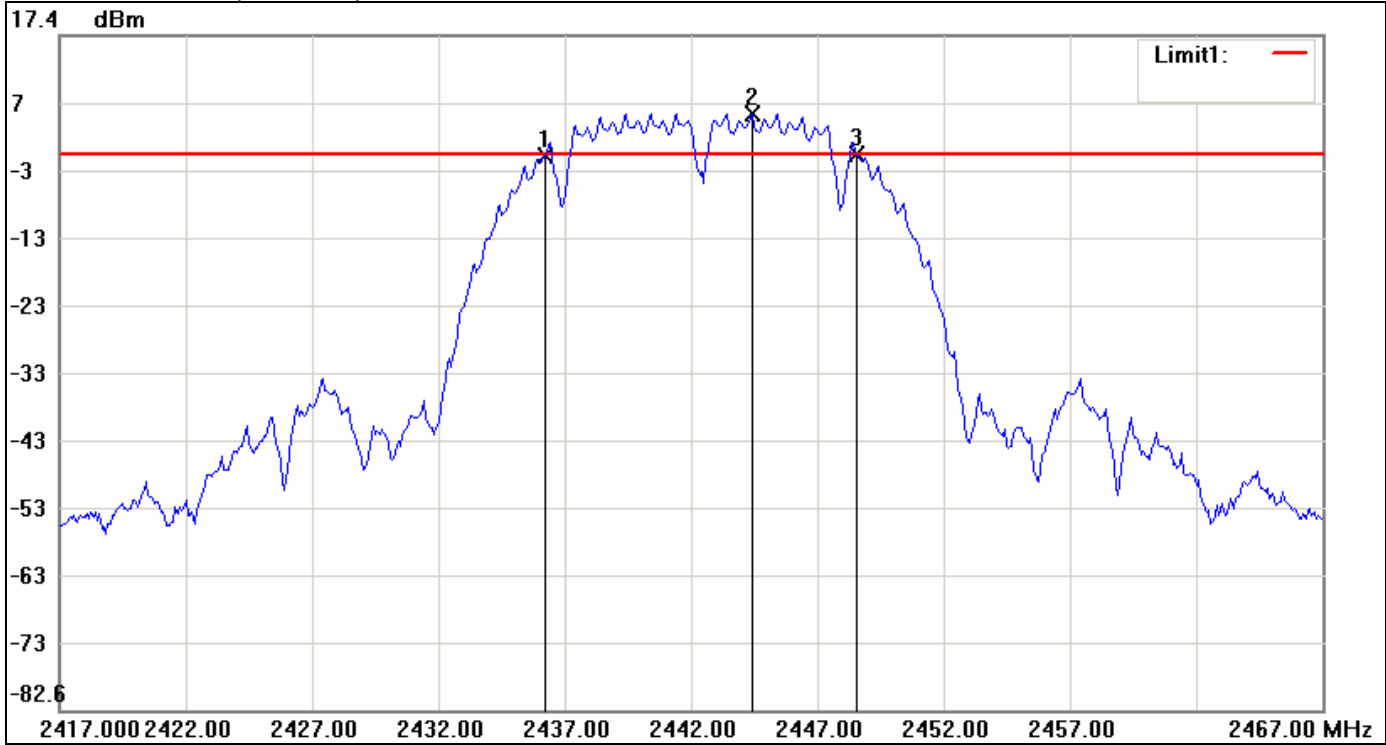

No.	Frequency(MHz)	Level(dBm)	Limit(dBm)	Margin(dBm)
1	2436.2500	-0.45	-0.13	-0.32
2	2444.4167	5.87	-0.13	6.00
3	2448.5833	-0.32	-0.13	-0.19

No.		Δ Frequency(MHz)	Δ Level(dB)
1	mk3-mk1	12.3333	0.13



6dB Bandwidth (CH High)

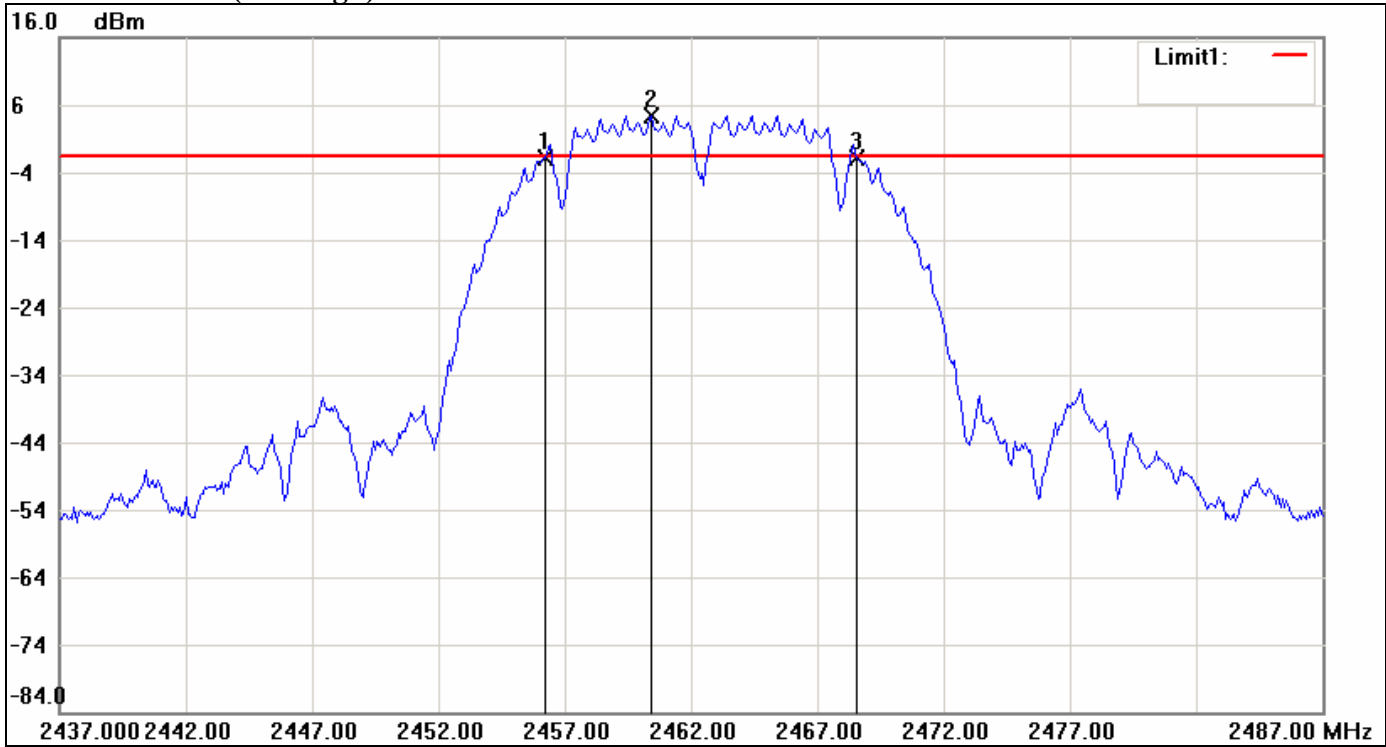

No.	Frequency(MHz)	Level(dBm)	Limit(dBm)	Margin(dBm)
1	2456.2500	-1.81	-1.61	-0.20
2	2460.4167	4.39	-1.61	6.00
3	2468.5833	-1.81	-1.61	-0.20

No.		Δ Frequency(MHz)	Δ Level(dB)
1	mk3-mk1	12.3333	0



IEEE 802.11g mode

6dB Bandwidth (CH Low)

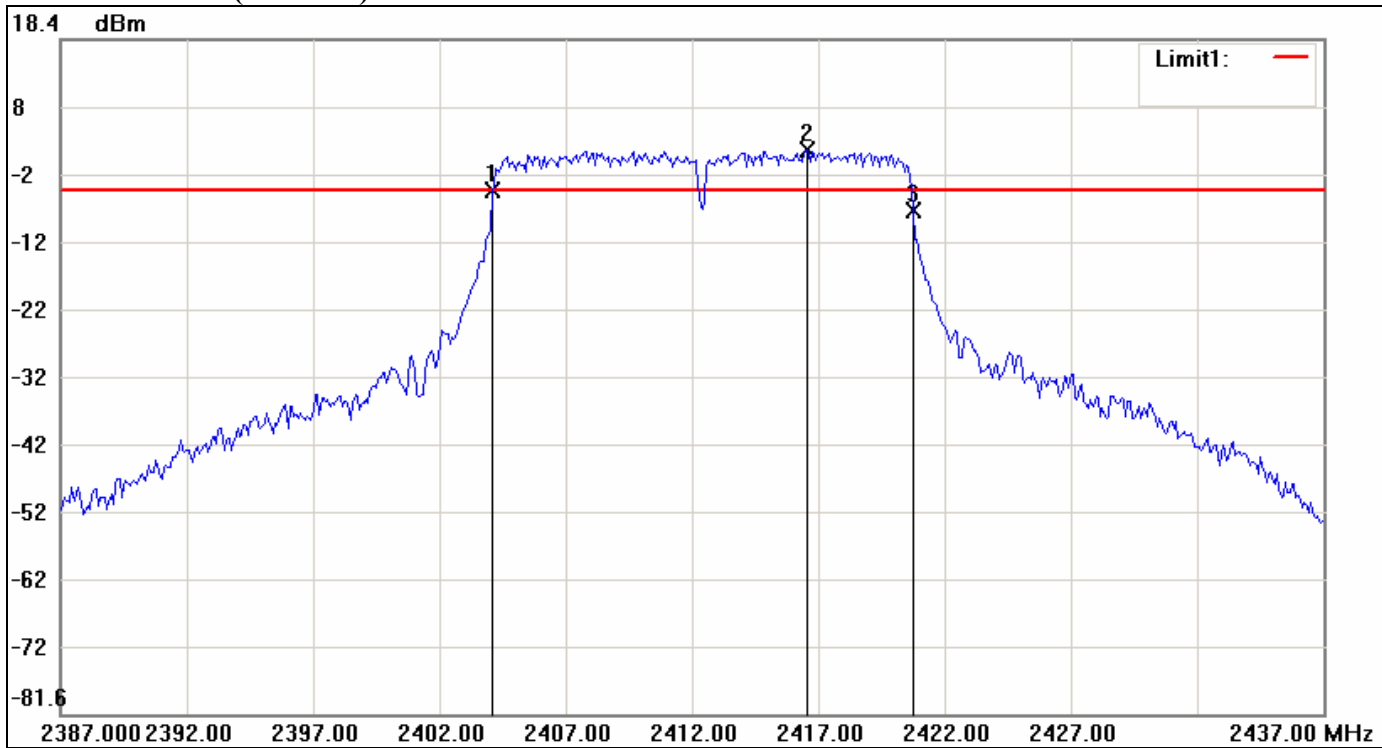

No.	Frequency(MHz)	Level(dBm)	Limit(dBm)	Margin(dBm)
1	2404.0833	-3.99	-3.85	-0.14
2	2416.5833	2.15	-3.85	6.00
3	2420.7500	-7.00	-3.85	-3.15

No.		Δ Frequency(MHz)	Δ Level(dB)
1	mk3-mk1	16.6667	-3.01



6dB Bandwidth (CH Mid)

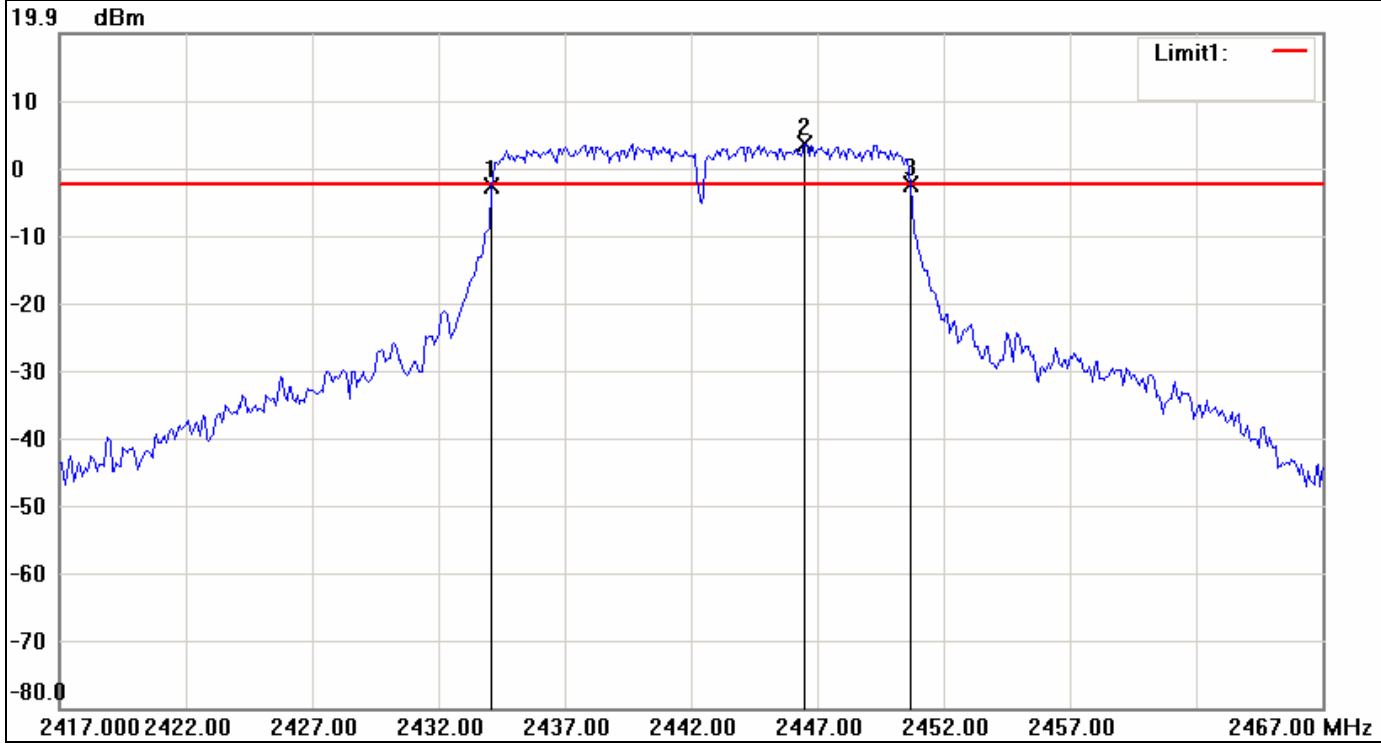

No.	Frequency(MHz)	Level(dBm)	Limit(dBm)	Margin(dBm)
1	2434.0833	-2.75	-2.35	-0.40
2	2446.5000	3.65	-2.35	6.00
3	2450.6667	-2.38	-2.35	-0.03

No.		Δ Frequency(MHz)	Δ Level(dB)
1	mk3-mk1	16.5834	0.37



6dB Bandwidth (CH High)

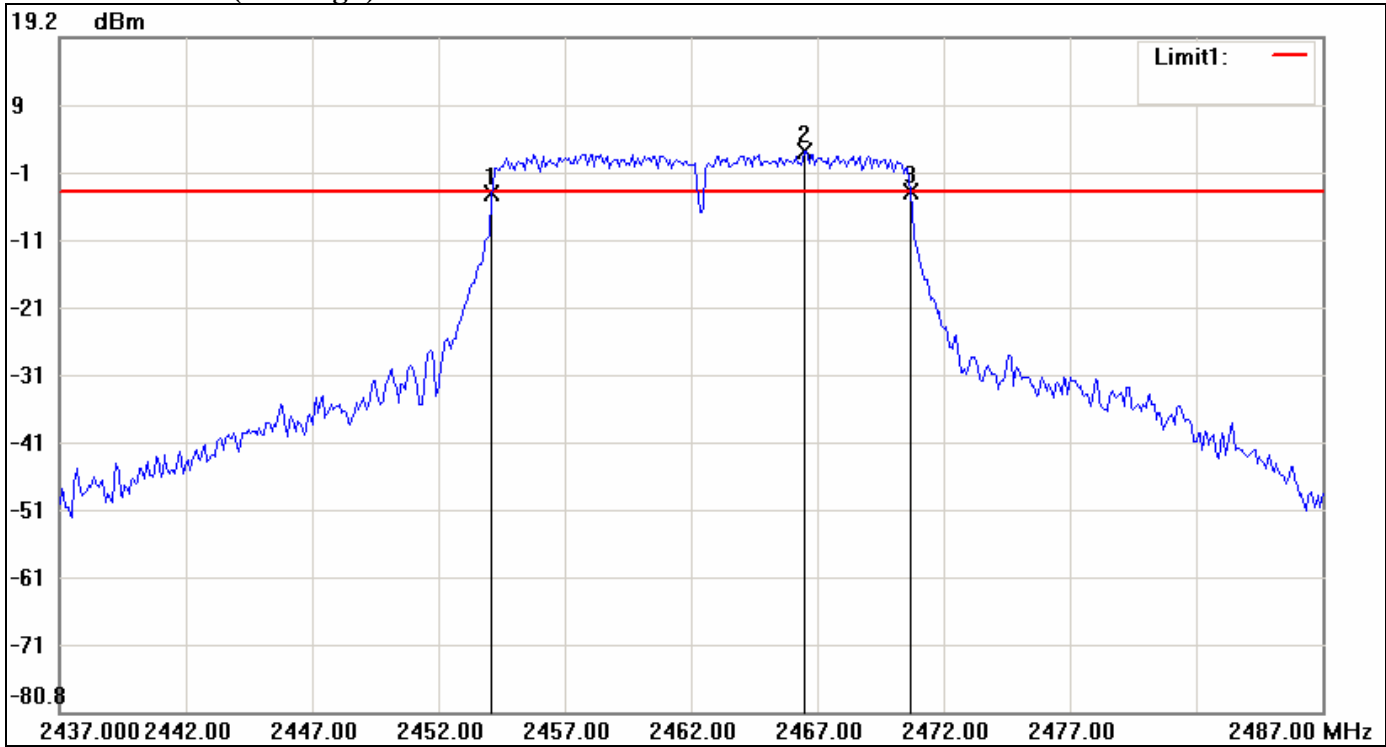

No.	Frequency(MHz)	Level(dBm)	Limit(dBm)	Margin(dBm)
1	2454.0833	-3.99	-3.58	-0.41
2	2466.5000	2.42	-3.58	6.00
3	2470.6667	-3.77	-3.58	-0.19

No.		Δ Frequency(MHz)	Δ Level(dB)
1	mk3-mk1	16.5834	0.22



IEEE 802.11n HT 20 MHz mode / Chain 0

6dB Bandwidth (CH Low)

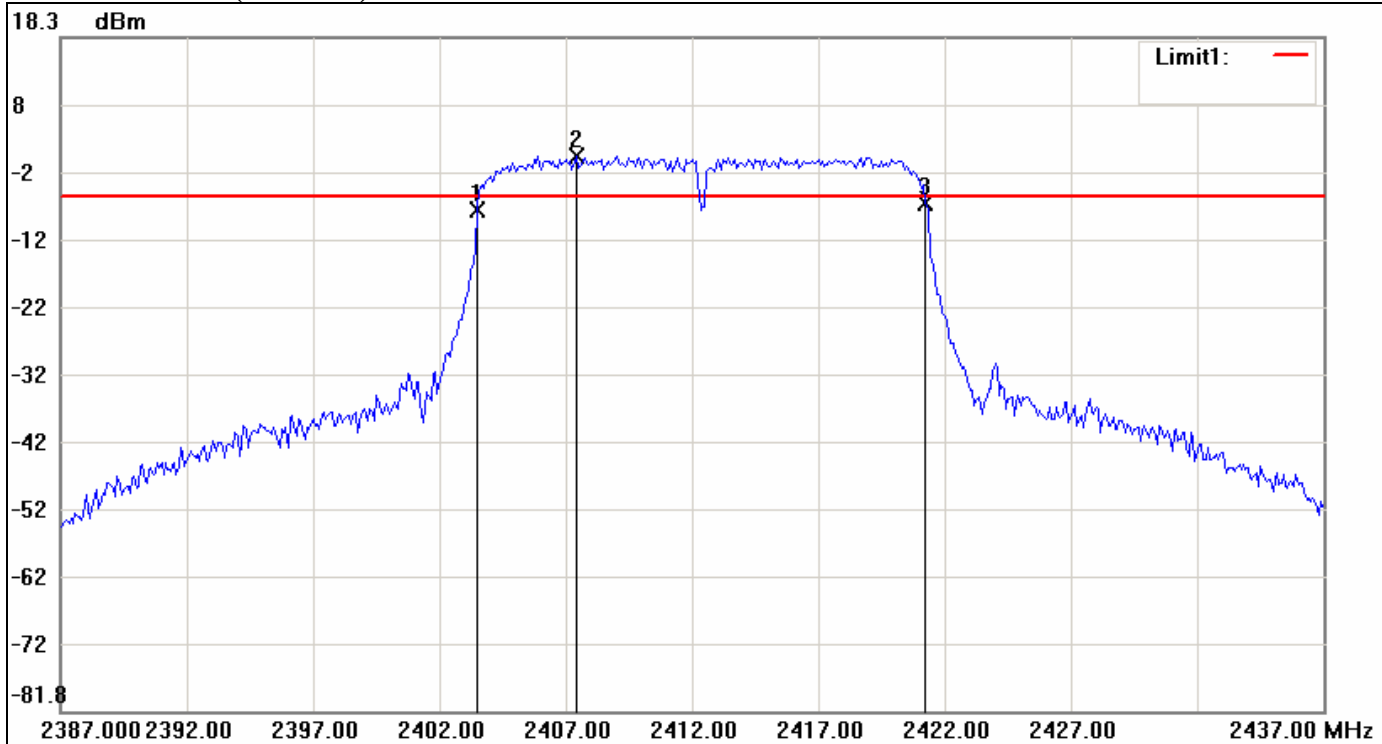

No.	Frequency(MHz)	Level(dBm)	Limit(dBm)	Margin(dBm)
1	2403.5000	-7.36	-5.26	-2.10
2	2407.4167	0.74	-5.26	6.00
3	2421.2500	-6.25	-5.26	-0.99

No.		Δ Frequency(MHz)	Δ Level(dB)
1	mk3-mk1	17.75	1.11



6dB Bandwidth (CH Mid)

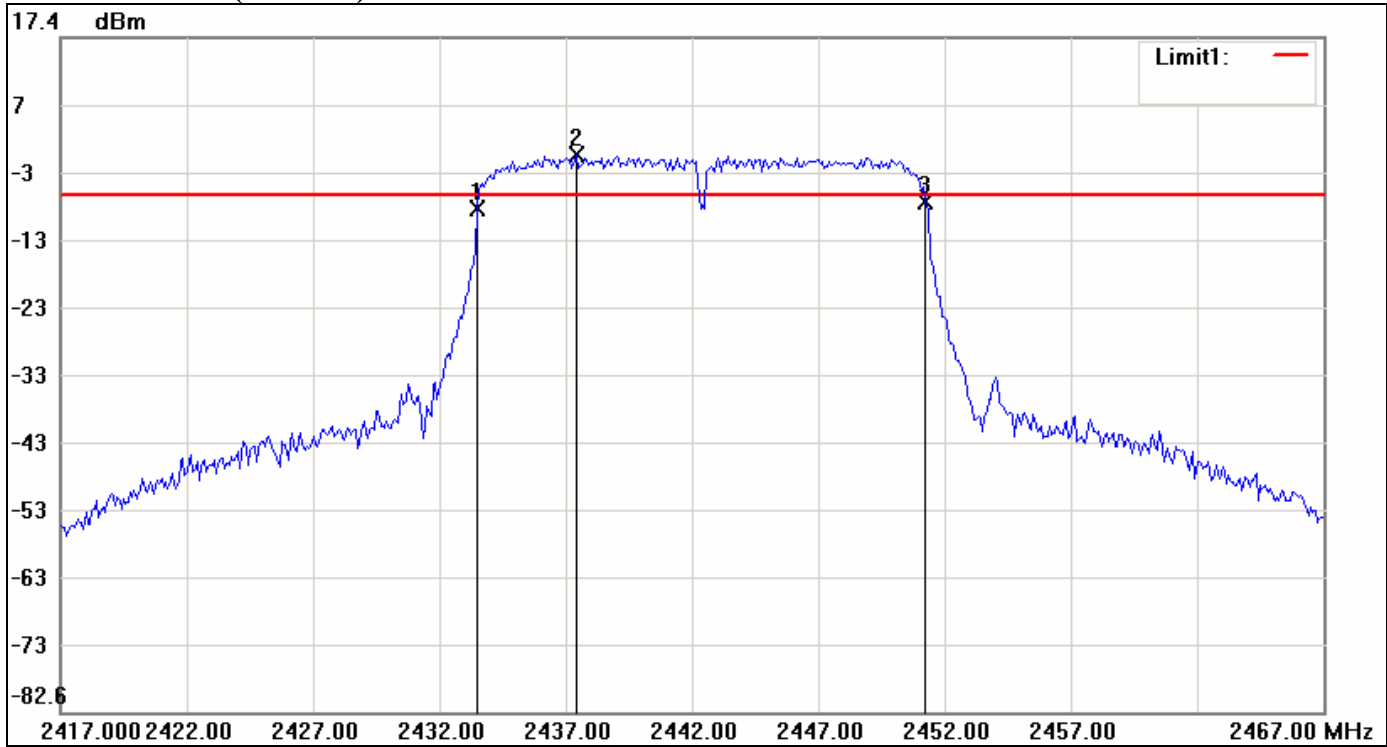

No.	Frequency(MHz)	Level(dBm)	Limit(dBm)	Margin(dBm)
1	2433.5000	-7.93	-5.89	-2.04
2	2437.4167	0.11	-5.89	6.00
3	2451.2500	-6.97	-5.89	-1.08

No.		Δ Frequency(MHz)	Δ Level(dB)
1	mk3-mk1	17.75	0.96



6dB Bandwidth (CH High)

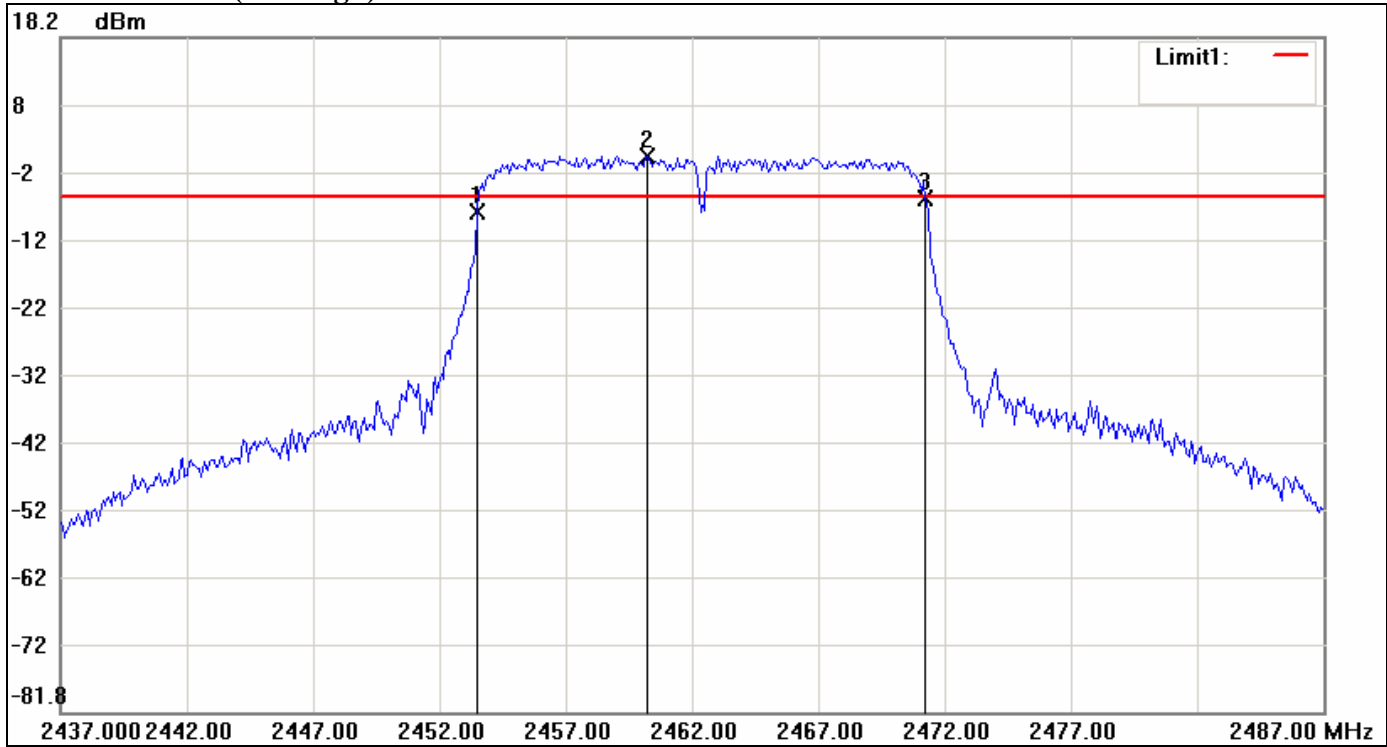

No.	Frequency(MHz)	Level(dBm)	Limit(dBm)	Margin(dBm)
1	2453.5000	-7.61	-5.42	-2.19
2	2460.2500	0.58	-5.42	6.00
3	2471.2500	-5.66	-5.42	-0.24

No.		Δ Frequency(MHz)	Δ Level(dB)
1	mk3-mk1	17.75	1.95



IEEE 802.11n HT 20 MHz mode / Chain 1

6dB Bandwidth (CH Low)

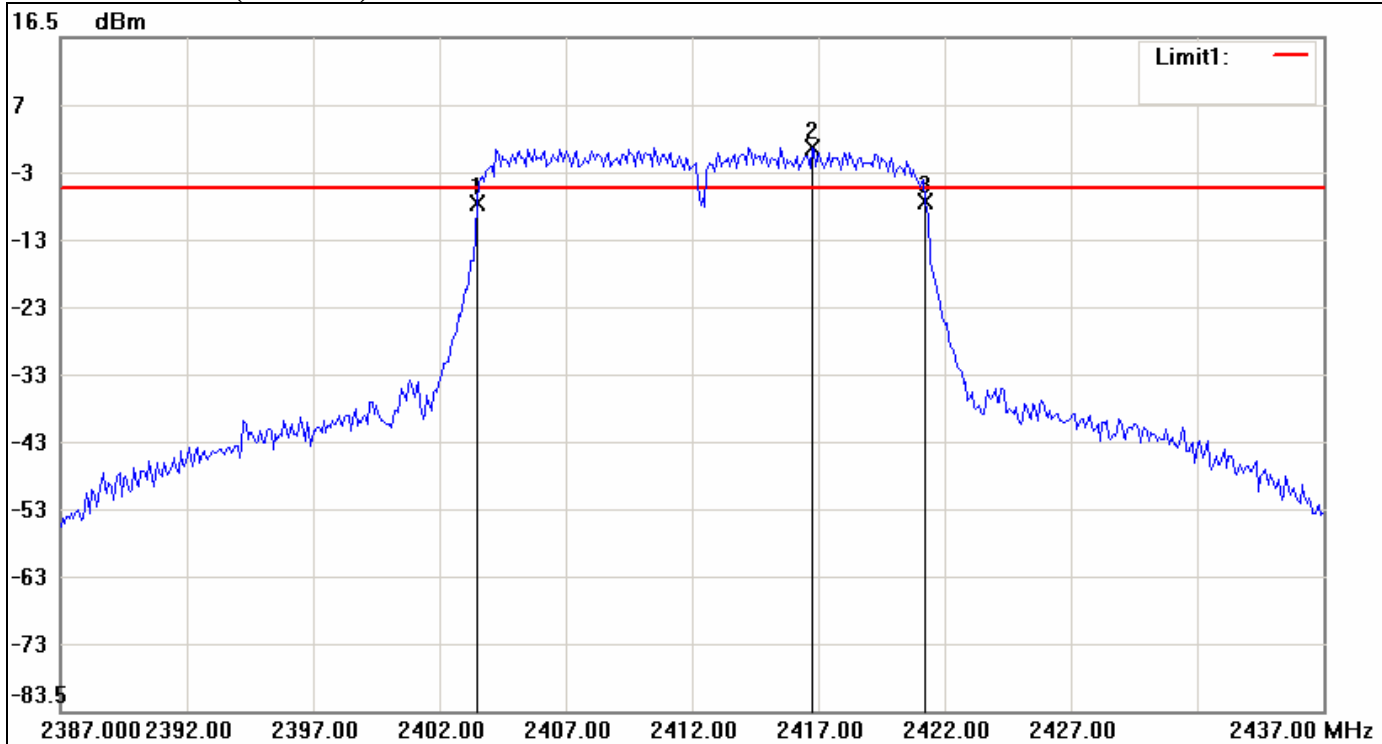

No.	Frequency(MHz)	Level(dBm)	Limit(dBm)	Margin(dBm)
1	2403.5000	-8.07	-5.80	-2.27
2	2416.7500	0.20	-5.80	6.00
3	2421.2500	-7.74	-5.80	-1.94

No.		Δ Frequency(MHz)	Δ Level(dB)
1	mk3-mk1	17.75	0.33



6dB Bandwidth (CH Mid)

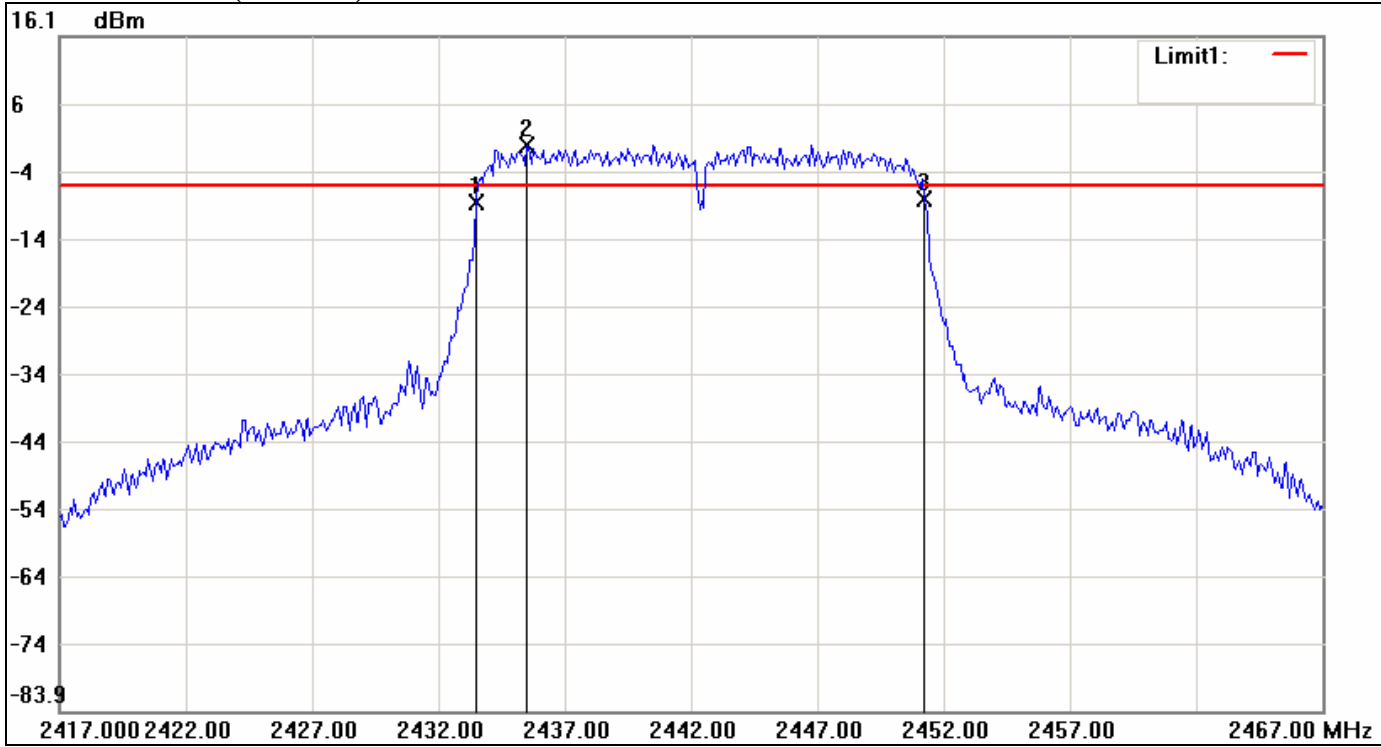

No.	Frequency(MHz)	Level(dBm)	Limit(dBm)	Margin(dBm)
1	2433.5000	-8.46	-5.98	-2.48
2	2435.5000	0.02	-5.98	6.00
3	2451.2500	-7.92	-5.98	-1.94

No.		Δ Frequency(MHz)	Δ Level(dB)
1	mk3-mk1	17.75	0.54



6dB Bandwidth (CH High)

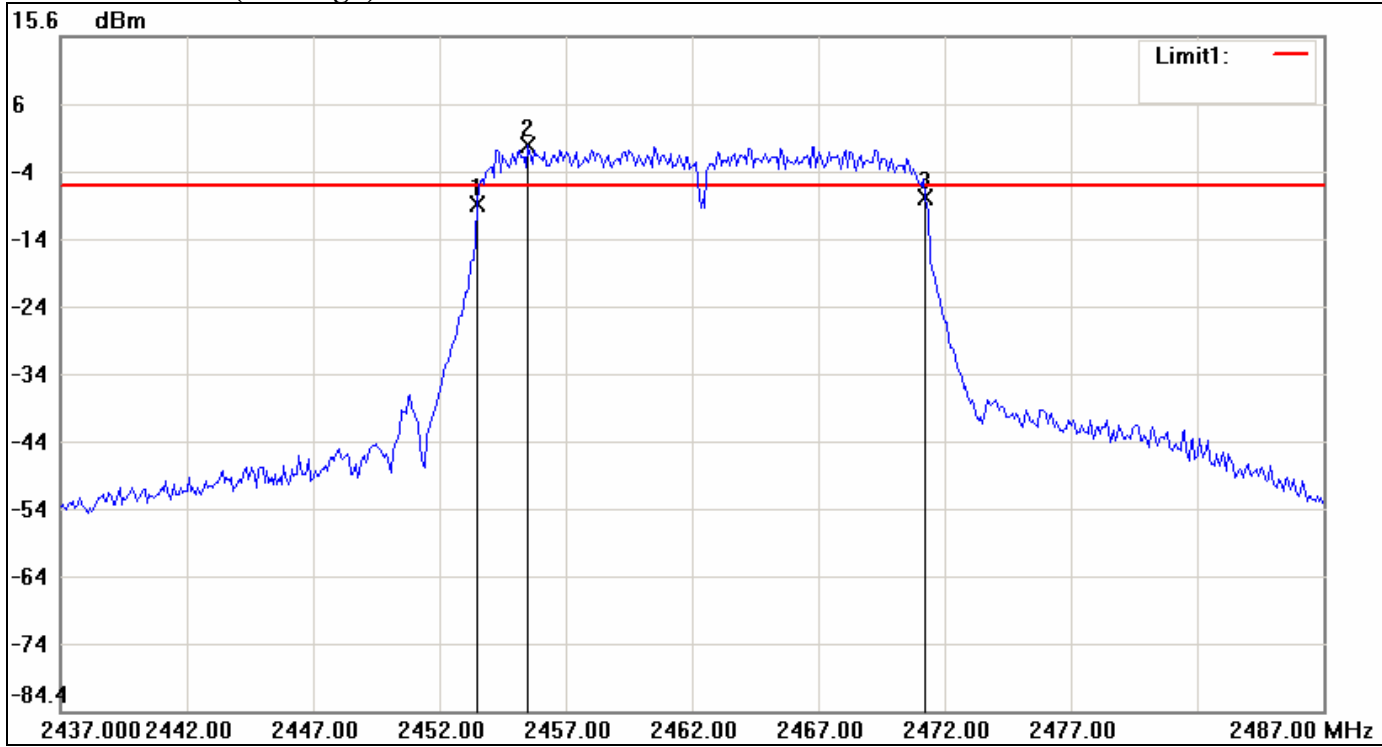

No.	Frequency(MHz)	Level(dBm)	Limit(dBm)	Margin(dBm)
1	2453.5000	-9.38	-6.55	-2.83
2	2455.5000	-0.55	-6.55	6.00
3	2471.2500	-8.18	-6.55	-1.63

No.		Δ Frequency(MHz)	Δ Level(dB)
1	mk3-mk1	17.75	1.2



IEEE 802.11n HT 40 MHz mode / Chain 0

6dB Bandwidth (CH Low)

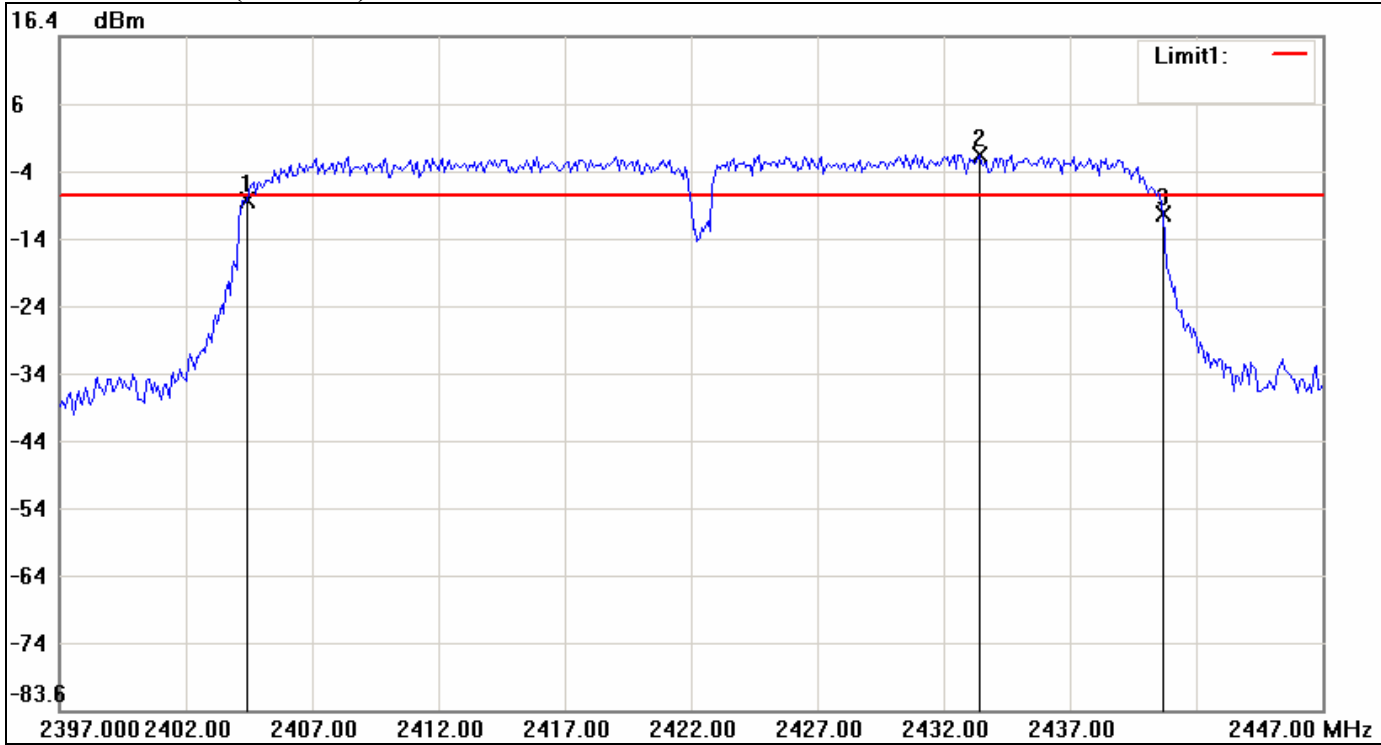

No.	Frequency(MHz)	Level(dBm)	Limit(dBm)	Margin(dBm)
1	2404.4167	-8.07	-7.27	-0.80
2	2433.4167	-1.27	-7.27	6.00
3	2440.6667	-10.03	-7.27	-2.76

No.		Δ Frequency(MHz)	Δ Level(dB)
1	mk3-mk1	36.25	-1.96



6dB Bandwidth (CH Mid)

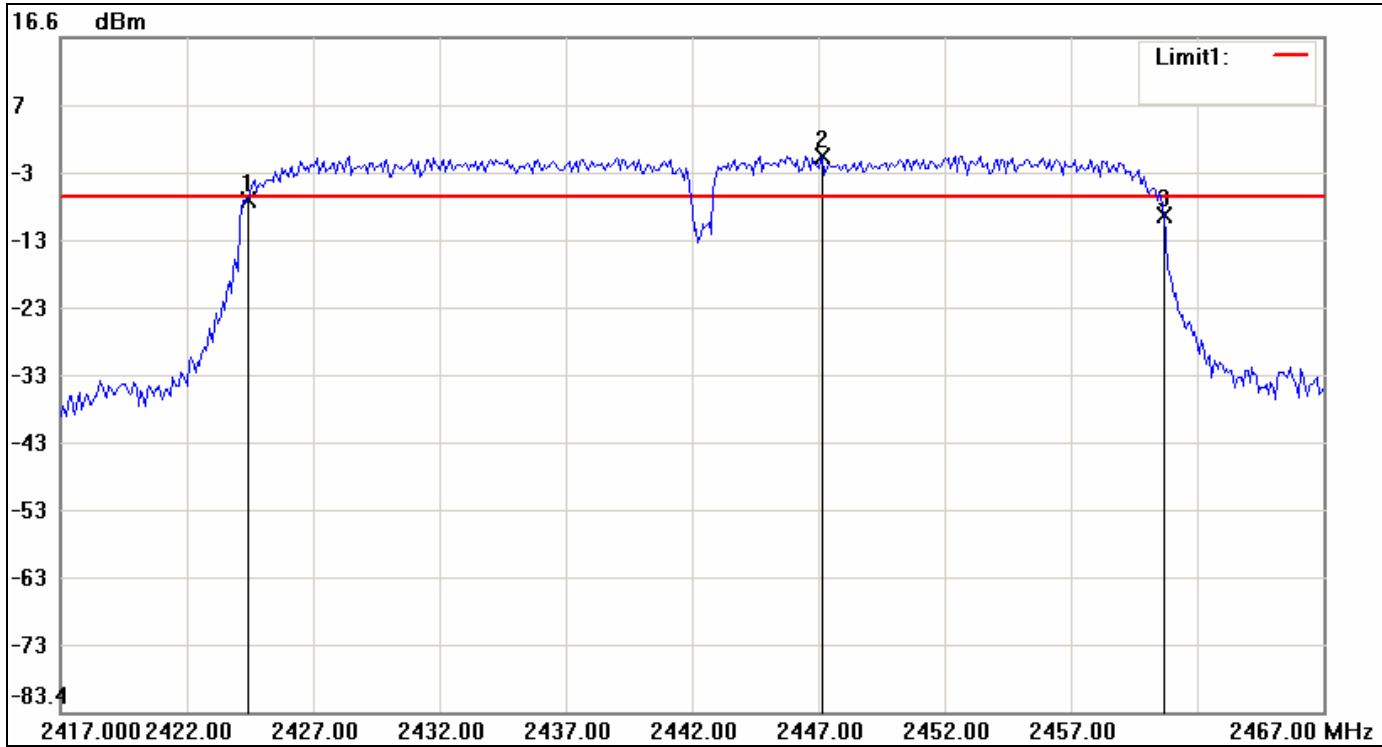

No.	Frequency(MHz)	Level(dBm)	Limit(dBm)	Margin(dBm)
1	2424.4167	-7.55	-6.89	-0.66
2	2447.1667	-0.89	-6.89	6.00
3	2460.6667	-9.74	-6.89	-2.85

No.		Δ Frequency(MHz)	Δ Level(dB)
1	mk3-mk1	36.25	-2.19



6dB Bandwidth (CH High)

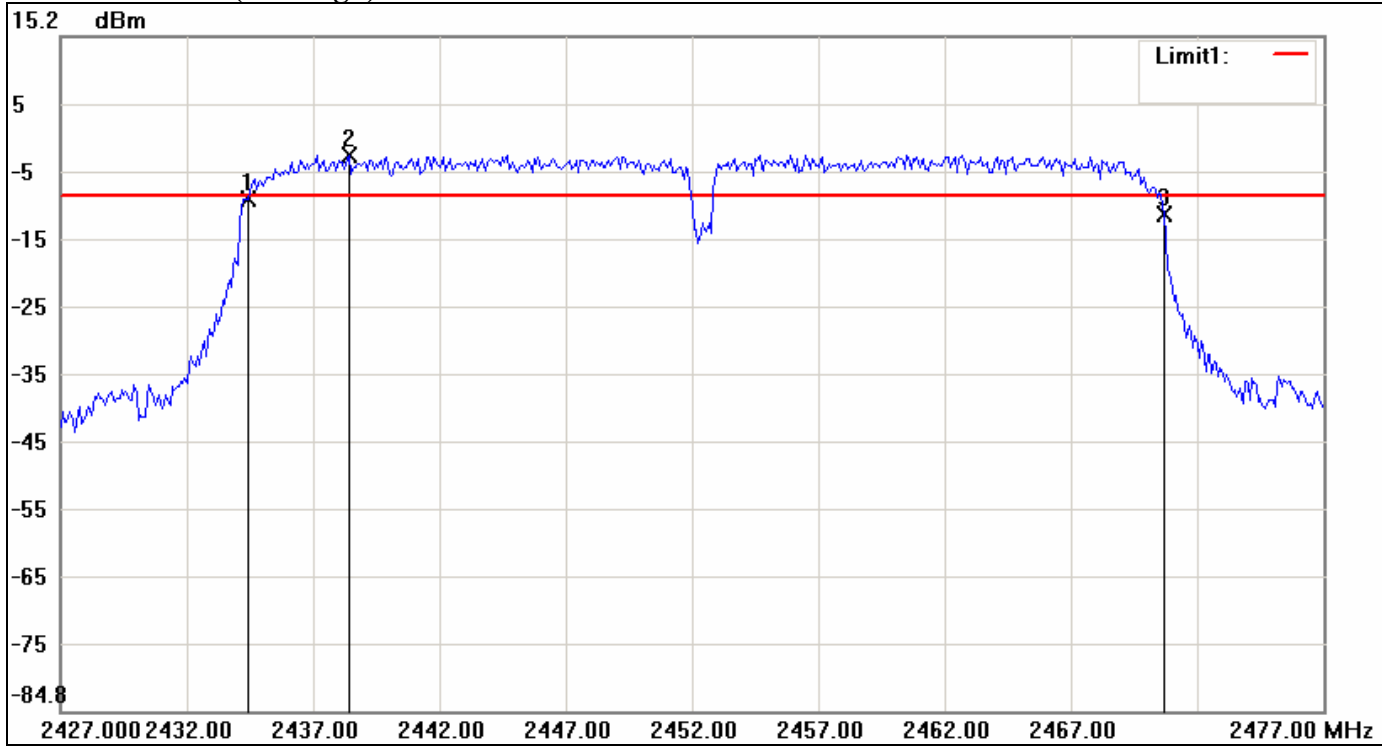

No.	Frequency(MHz)	Level(dBm)	Limit(dBm)	Margin(dBm)
1	2434.4167	-8.87	-8.30	-0.57
2	2438.4167	-2.30	-8.30	6.00
3	2470.6667	-11.24	-8.30	-2.94

No.	Δ Frequency(MHz)	Δ Level(dB)
1	mk3-mk1	36.25



IEEE 802.11n HT 40 MHz mode / Chain 1

6dB Bandwidth (CH Low)

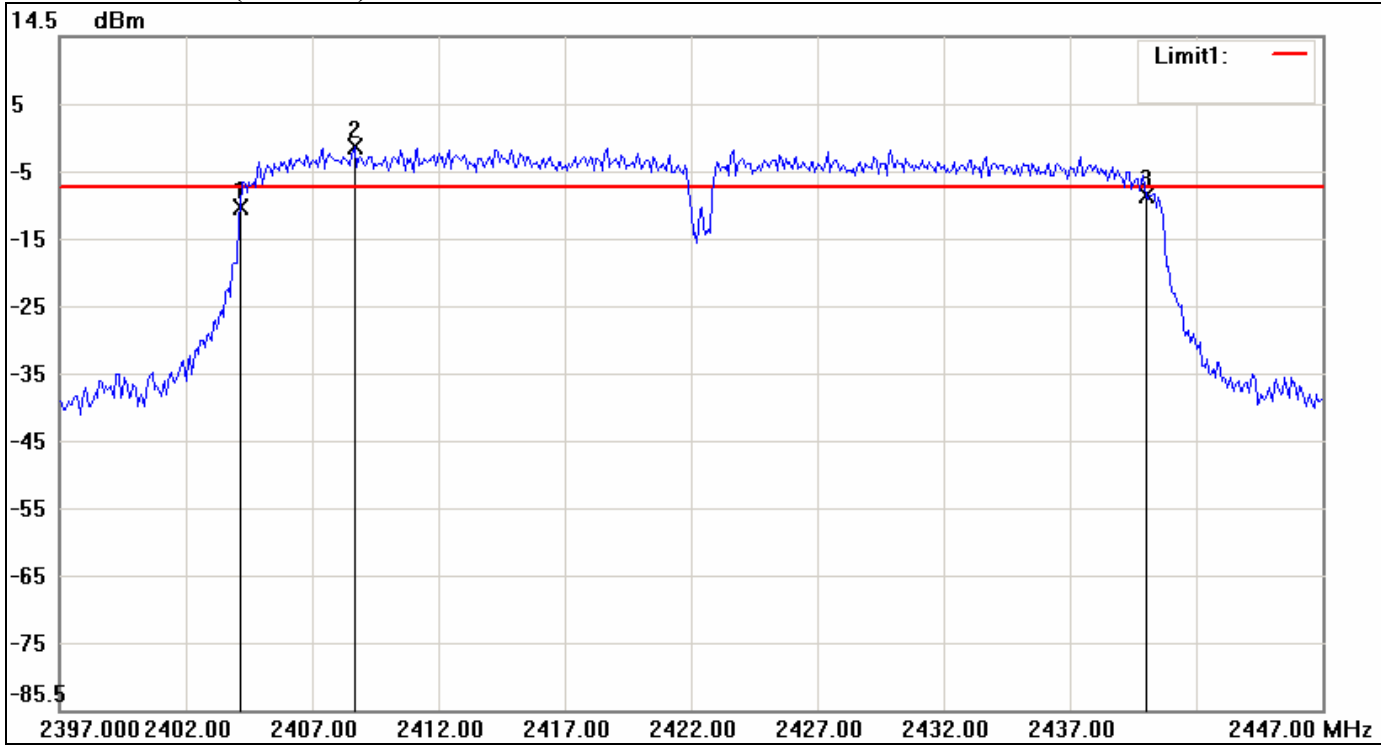

No.	Frequency(MHz)	Level(dBm)	Limit(dBm)	Margin(dBm)
1	2404.1667	-10.93	-7.83	-3.10
2	2408.6667	-1.83	-7.83	6.00
3	2440.0000	-9.00	-7.83	-1.17

No.		Δ Frequency(MHz)	Δ Level(dB)
1	mk3-mk1	35.8333	1.93



6dB Bandwidth (CH Mid)

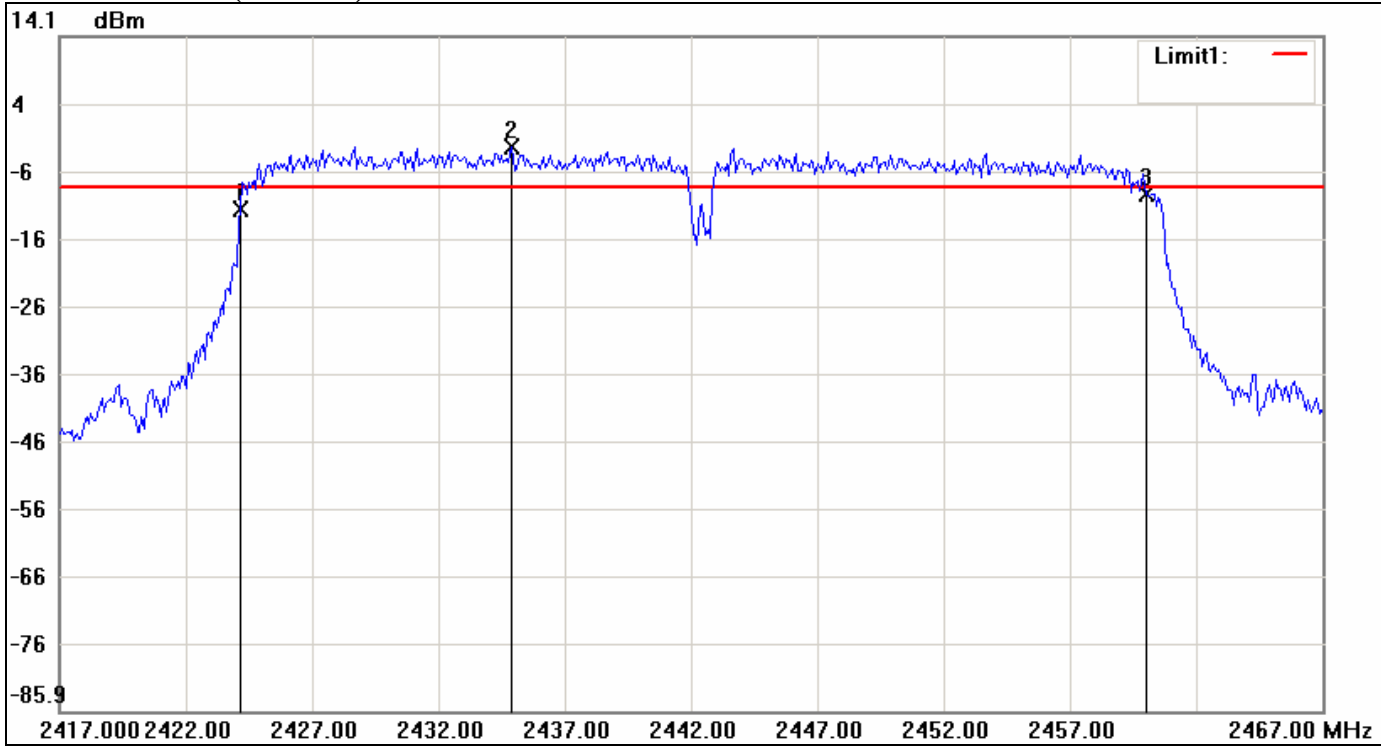

No.	Frequency(MHz)	Level(dBm)	Limit(dBm)	Margin(dBm)
1	2424.1667	-11.55	-8.30	-3.25
2	2434.9167	-2.30	-8.30	6.00
3	2460.0000	-9.32	-8.30	-1.02

No.		Δ Frequency(MHz)	Δ Level(dB)
1	mk3-mk1	35.8333	2.23



6dB Bandwidth (CH High)

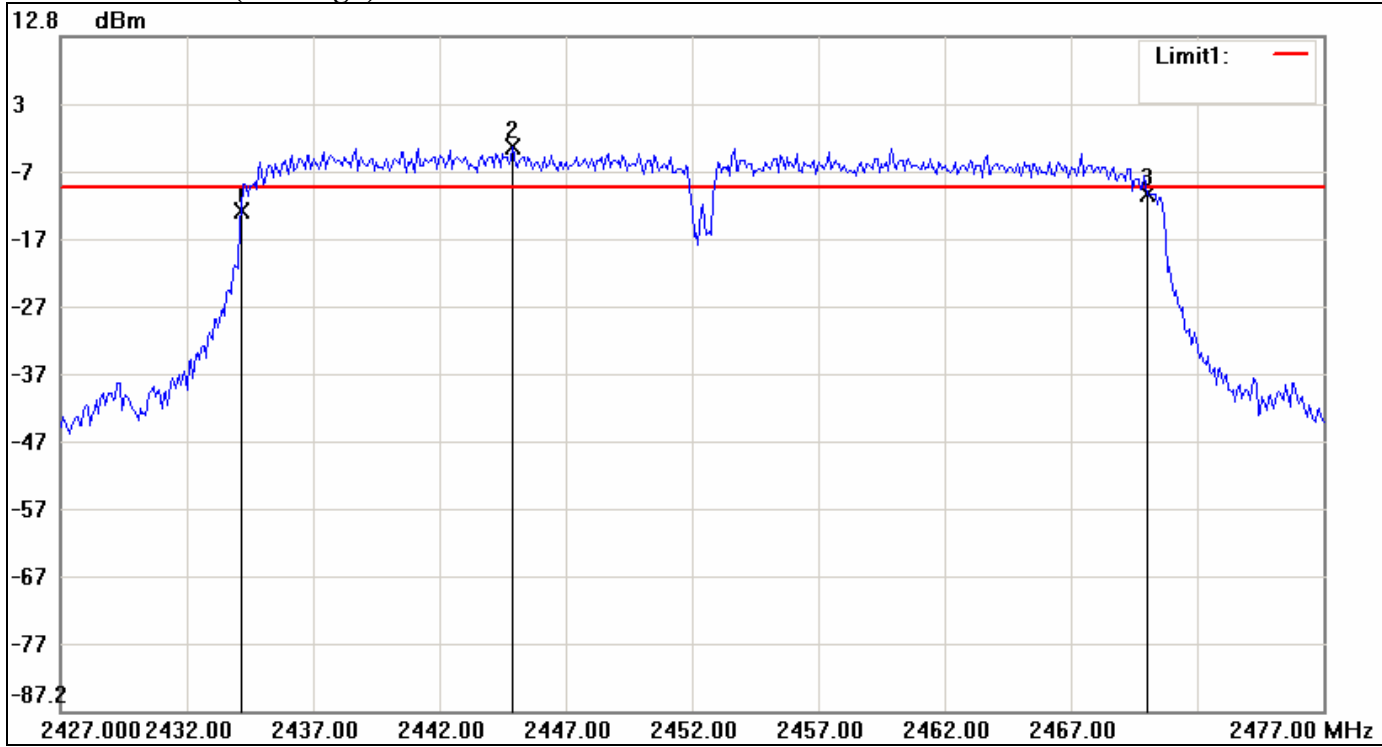

No.	Frequency(MHz)	Level(dBm)	Limit(dBm)	Margin(dBm)
1	2434.1667	-13.08	-9.61	-3.47
2	2444.9167	-3.61	-9.61	6.00
3	2470.0000	-10.44	-9.61	-0.83

No.		Δ Frequency(MHz)	Δ Level(dB)
1	mk3-mk1	35.8333	2.64



7.2 PEAK POWER

LIMIT

The maximum peak output power of the intentional radiator shall not exceed the following:

1. According to §15.247(b)(3), for systems using digital modulation in the bands of 902-928 MHz, 2400-2483.5 MHz, and 5725-5850 MHz: 1 Watt.
2. According to §15.247(b)(4), the conducted output power limit specified in paragraph (b) of this section is based on the use of antennas with directional gains that do not exceed 6 dBi. Except as shown in paragraph (c) of this section, if transmitting antennas of directional gain greater than 6 dBi are used, the conducted output power from the intentional radiator shall be reduced below the stated values in paragraphs (b)(1), (b)(2), and (b)(3) of this section, as appropriate, by the amount in dB that the directional gain of the antenna exceeds 6 dBi.

Test Configuration

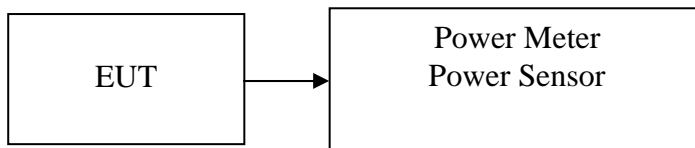

TEST PROCEDURE

The transmitter output is connected to the Power Meter. The Power Meter is set to the peak power detection.



Test Data

Test mode: IEEE 802.11b mode

Channel	Frequency (MHz)	Output Power (dBm)	Output Power (W)	Limit (W)	Result
Low	2412	19.46	0.0883	1.00	PASS
Mid	2437	21.03	0.1268		PASS
High	2462	19.48	0.0887		PASS

Test mode: IEEE 802.11g mode

Channel	Frequency (MHz)	Output Power (dBm)	Output Power (W)	Limit (W)	Result
Low	2412	25.31	0.3396	1.00	PASS
Mid	2437	25.68	0.3698		PASS
High	2462	25.16	0.3281		PASS

Test mode: IEEE 802.11n HT 20 MHz mode

Channel	Frequency (MHz)	Chain 0 Output Power (dBm)	Chain 1 Output Power (dBm)	Total Output Power (dBm)	Output Power (W)	Limit (W)	Result
Low	2412	24.51	22.7	26.71	0.4687	0.794	PASS
Mid	2437	23.75	21.88	25.93	0.3913		PASS
High	2462	24.51	22.31	26.56	0.4527		PASS

Test mode: IEEE 802.11n HT 40 MHz mode

Channel	Frequency (MHz)	Chain 0 Output Power (dBm)	Chain 1 Output Power (dBm)	Total Output Power (dBm)	Output Power (W)	Limit (W)	Result
Low	2422	24.24	22.28	26.38	0.4345	0.794	PASS
Mid	2437	24.85	22.77	26.94	0.4947		PASS
High	2452	23.66	20.71	25.44	0.3500		PASS

Remark:

1. Total Output Power (w) = Chain 0 (10^(Output Power /10)/1000)+ Chain 2 (10^(Output Power /10)/1000)
2. The maximum antenna gain is 6.81dBi; therefore the reduction due to antenna gain is 1dB, so the limit is 29dBm.



7.3 AVERAGE POWER

LIMIT

None; for reporting purposes only.

TEST PROCEDURE

The transmitter output is connected to the Spectrum analyzer. The Spectrum analyzer is set to the average power detection.

Test Configuration

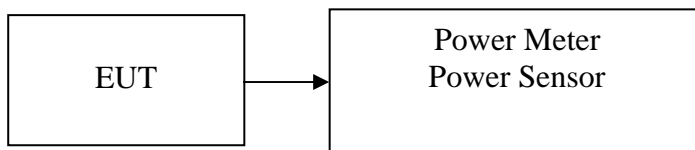

TEST PROCEDURE

The transmitter output is connected to the Power Meter. The Power Meter is set to the peak power detection.



TEST RESULTS

No non-compliance noted

Test Data

Test mode: IEEE 802.11b mode

Channel	Frequency (MHz)	Output Power (dBm)	Output Power (W)
Low	2412	16.64	0.0461
Mid	2437	18.13	0.0650
High	2462	16.63	0.0460

Test mode: IEEE 802.11g mode

Channel	Frequency (MHz)	Output Power (dBm)	Output Power (W)
Low	2412	16.84	0.0483
Mid	2437	18.27	0.0671
High	2462	16.79	0.0478

Test mode: IEEE 802.11n HT 20 MHz mode

Channel	Frequency (MHz)	Chain 0 Output Power (dBm)	Chain 1 Output Power (dBm)	Total Output Power (dBm)	Output Power (W)
Low	2412	15.67	14.21	18.01	0.0633
Mid	2437	14.80	13.10	17.04	0.0506
High	2462	15.68	13.49	17.73	0.0593

Test mode: IEEE 802.11n HT 40 MHz mode

Channel	Frequency (MHz)	Chain 0 Output Power (dBm)	Chain 1 Output Power (dBm)	Total Output Power (dBm)	Output Power (W)
Low	2422	15.58	13.67	17.74	0.0594
Mid	2437	16.87	14.21	18.75	0.0750
High	2452	14.73	12.23	16.67	0.0464

Remark: Total Output Power (w) = Chain 0 ($10^{(Output Power / 10) / 1000}$) + Chain 1 ($10^{(Output Power / 10) / 1000}$)



7.4 BAND EDGES MEASUREMENT

LIMIT

According to §15.247(d), in any 100 kHz bandwidth outside the frequency bands in which the spread spectrum intentional radiator is operating, the radio frequency power that is produced by the intentional radiator shall be at least 20 dB below that in the 100 kHz bandwidth within the band that contains the highest level of the desired power, based on either an RF conducted or a radiated measurement, provided the transmitter demonstrates compliance with the peak conducted power limits. In addition, radiated emissions which fall in the restricted bands, as defined in §15.205(a), must also comply with the radiated emission limits specified in 15.209(a) (see Section 15.205(c)).

Test Configuration

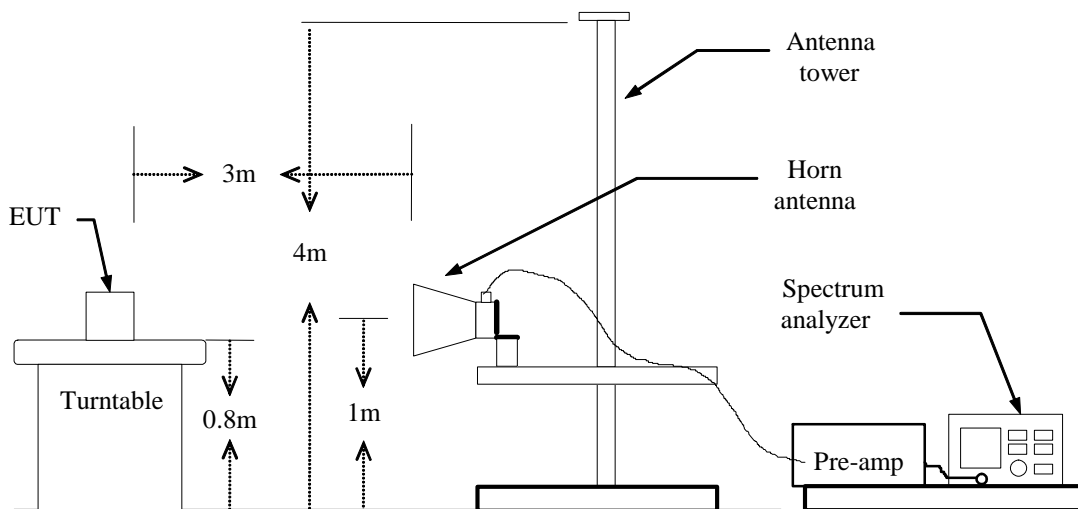

TEST PROCEDURE

1. The EUT is placed on a turntable, which is 0.8m above the ground plane.
2. The turntable shall be rotated for 360 degrees to determine the position of maximum emission level.
3. EUT is set 3m away from the receiving antenna, which is varied from 1m to 4m to find out the highest emission.
4. Set the spectrum analyzer in the following setting in order to capture the lower and upper band-edges of the emission:
 - (a) PEAK: RBW=VBW=1MHz / Sweep=AUTO
 - (b) AVERAGE: RBW=1MHz / VBW=10Hz / Sweep=AUTO
5. Repeat the procedures until all the PEAK and AVERAGE versus POLARIZATION are measured.

TEST RESULTS

Refer to attach spectrum analyzer data chart.



Band Edges (IEEE 802.11b mode / CH Low)

Detector mode: Peak

Polarity: Vertical

Agilent 18:22:00 Jun 14, 2011

R T

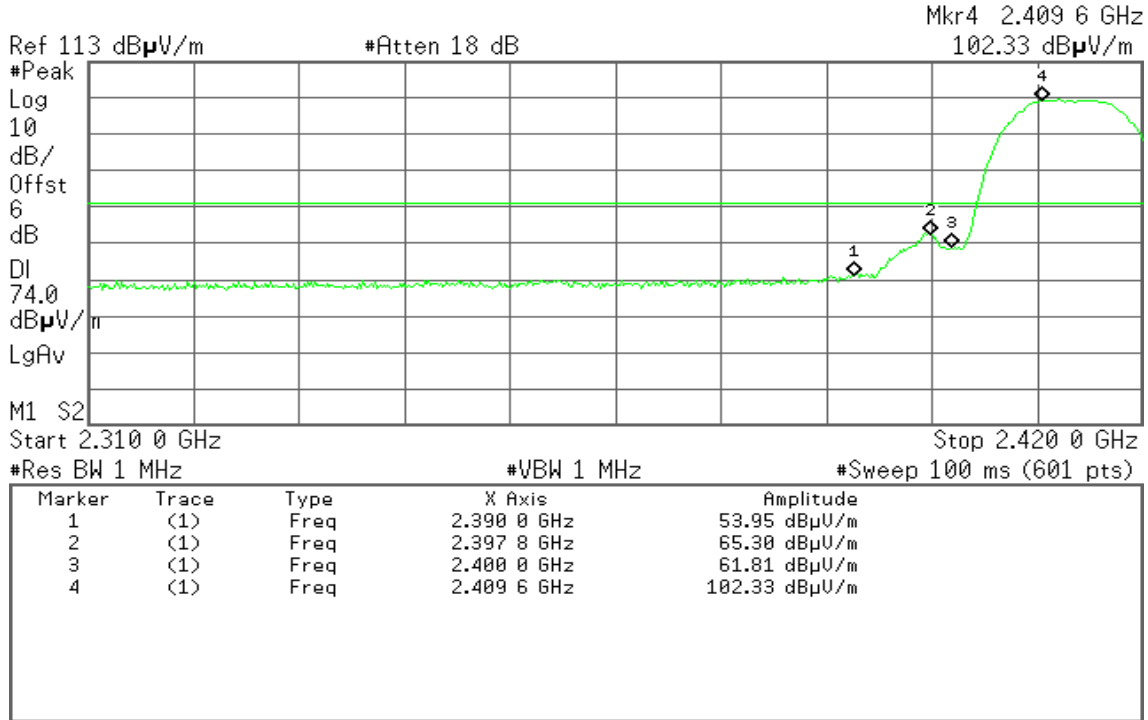

Detector mode: Average

Polarity: Vertical

Agilent 18:21:13 Jun 14, 2011

R T

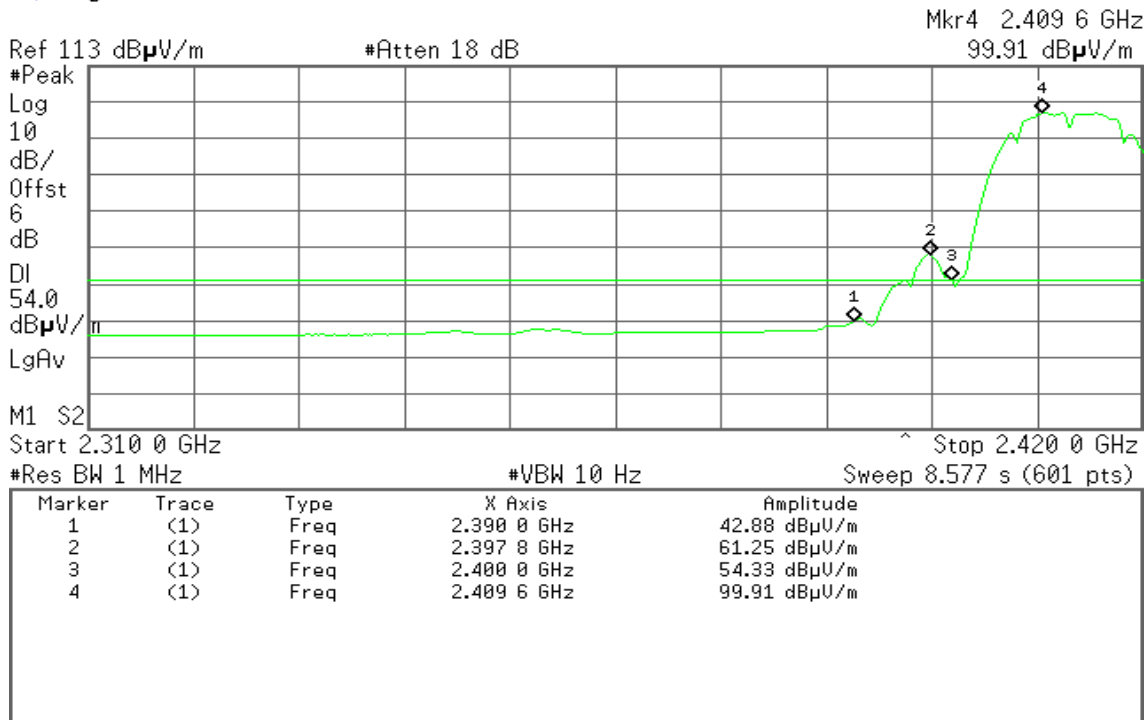



Detector mode: Peak

Polarity: Horizontal

Agilent 18:28:00 Jun 14, 2011

R T

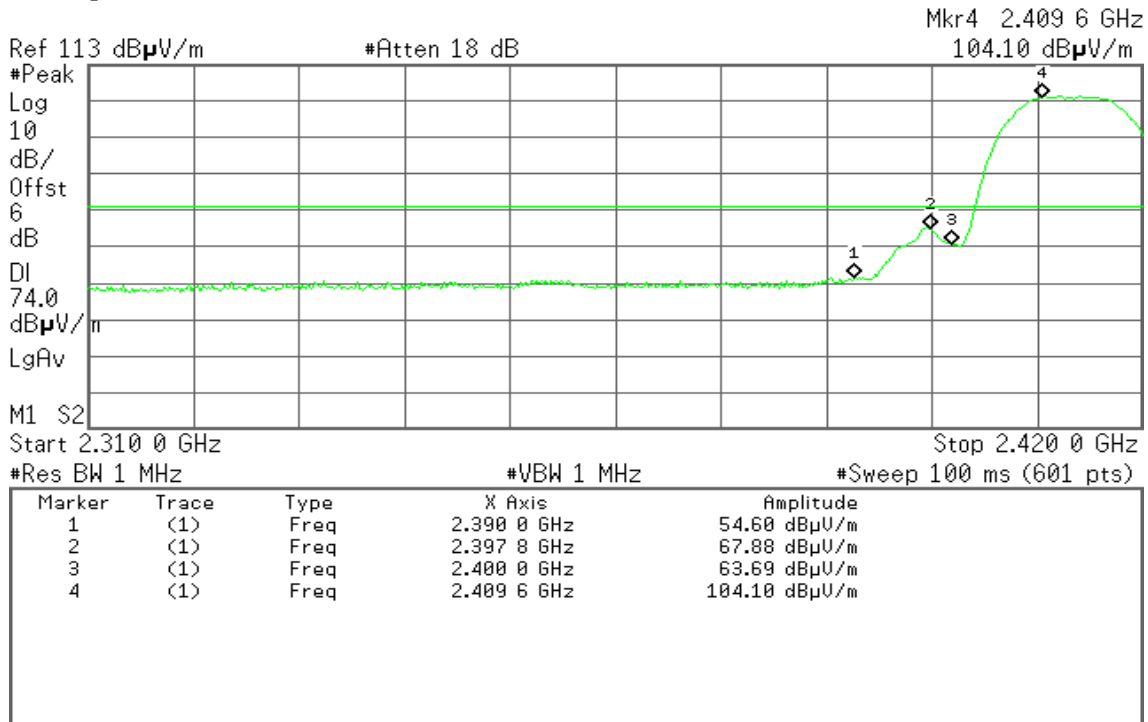

Detector mode: Average

Polarity: Horizontal

Agilent 18:27:06 Jun 14, 2011

R T

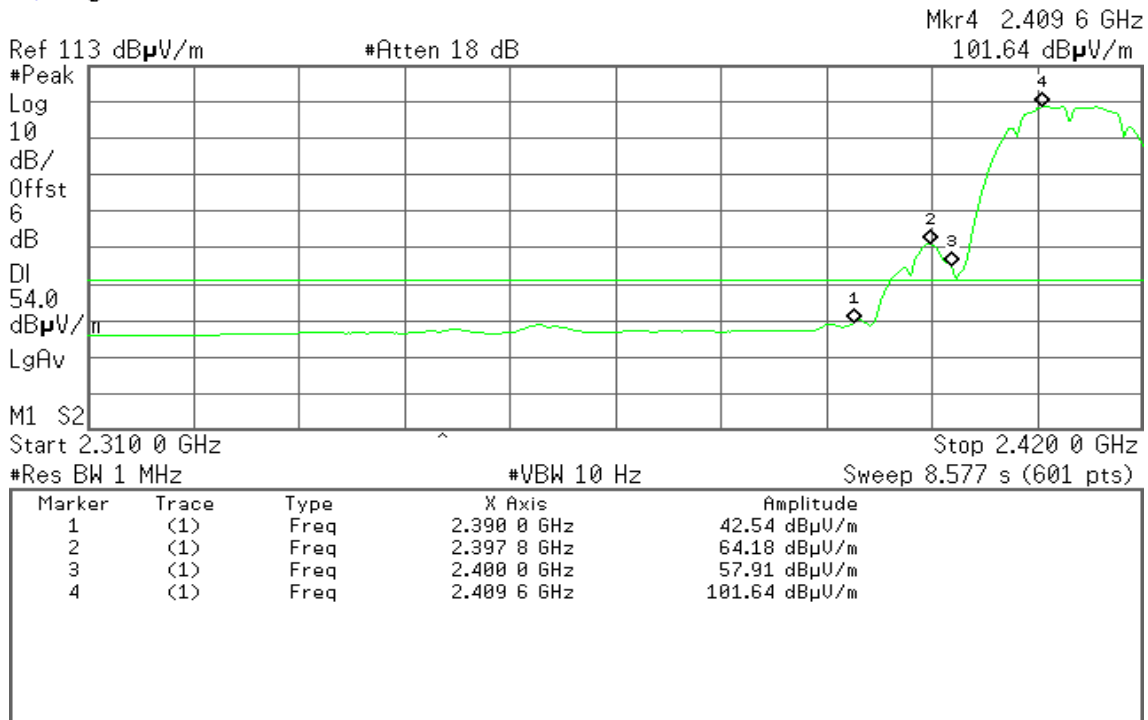



Band Edges (IEEE 802.11b mode / CH High)

Detector mode: Peak

Polarity: Vertical

Agilent 20:29:59 Jun 14, 2011

R T

Mkr1 2.483 50 GHz
54.50 dB μ V/m

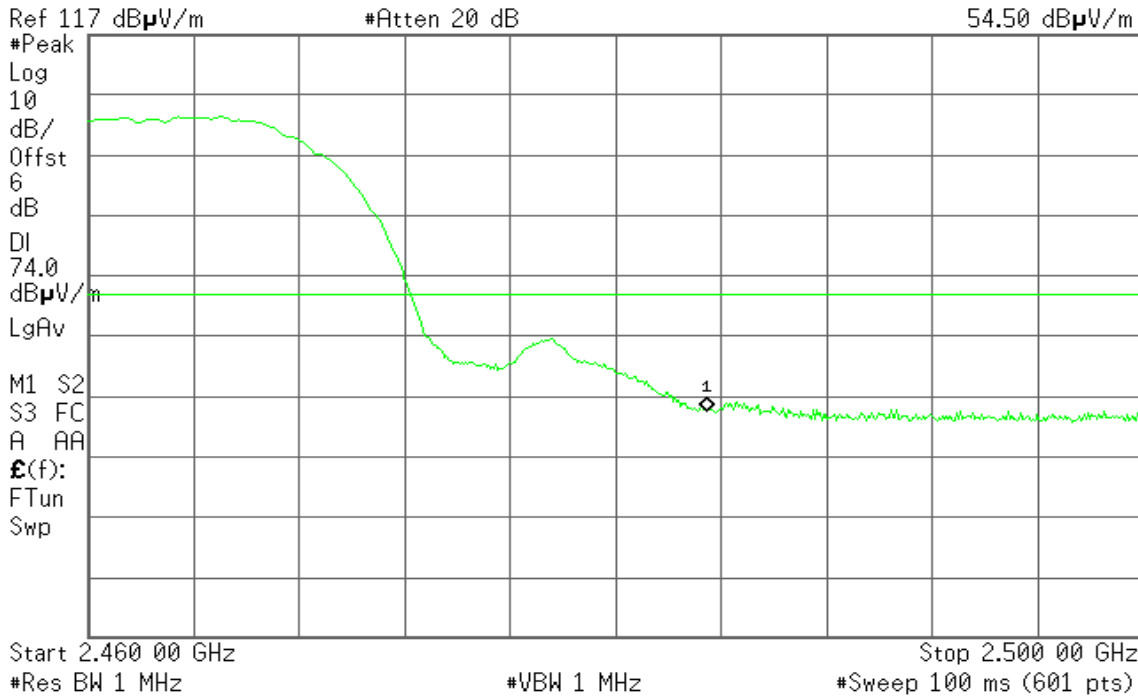

Detector mode: Average

Polarity: Vertical

Agilent 20:30:56 Jun 14, 2011

R T

Mkr1 2.483 50 GHz
42.83 dB μ V/m

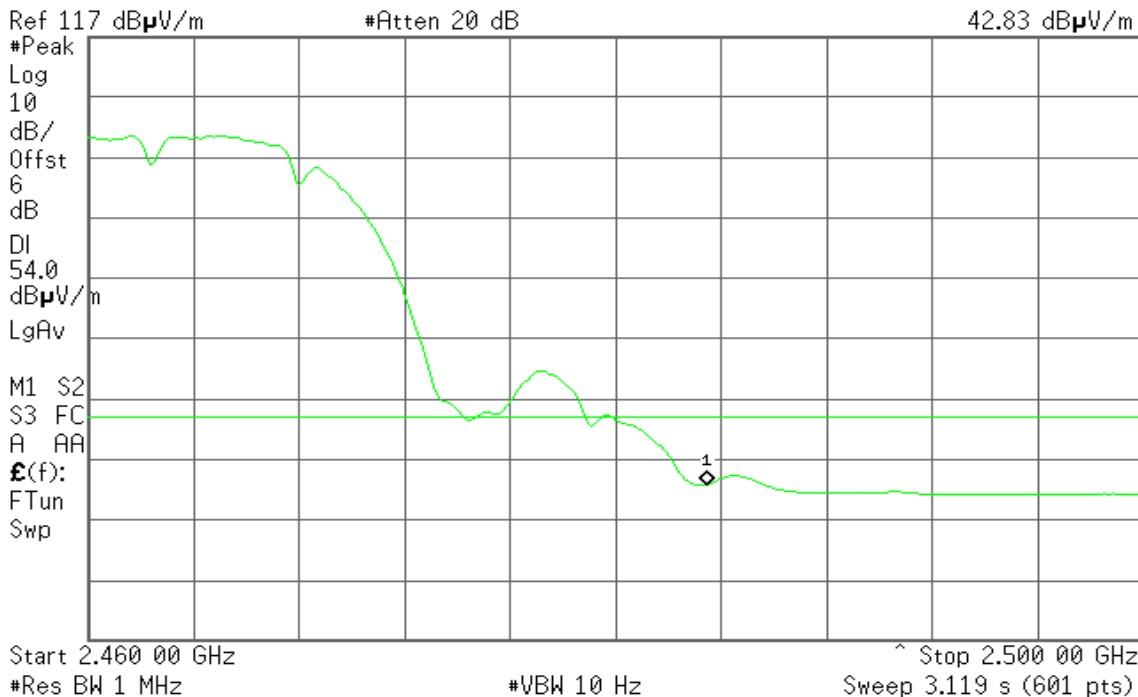



Detector mode: Peak

Polarity: Horizontal

Agilent 20:26:59 Jun 14, 2011

R T

Mkr1 2.483 50 GHz
55.28 dB μ V/m

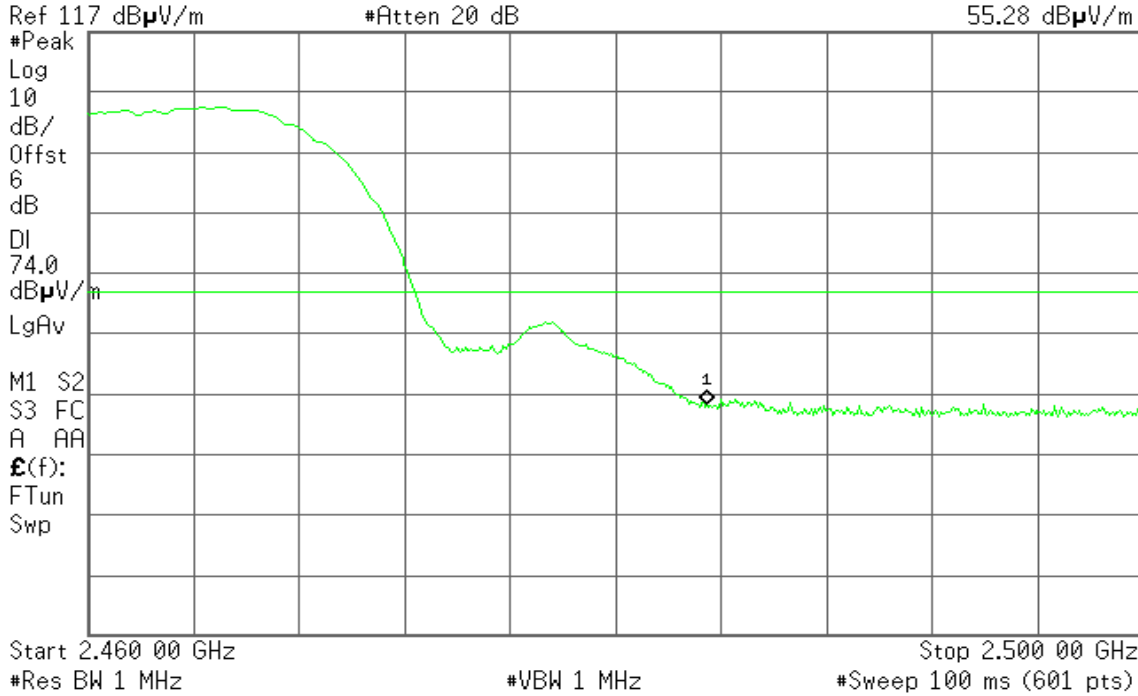

Detector mode: Average

Polarity: Horizontal

Agilent 20:25:51 Jun 14, 2011

R T

Mkr1 2.483 50 GHz
42.94 dB μ V/m

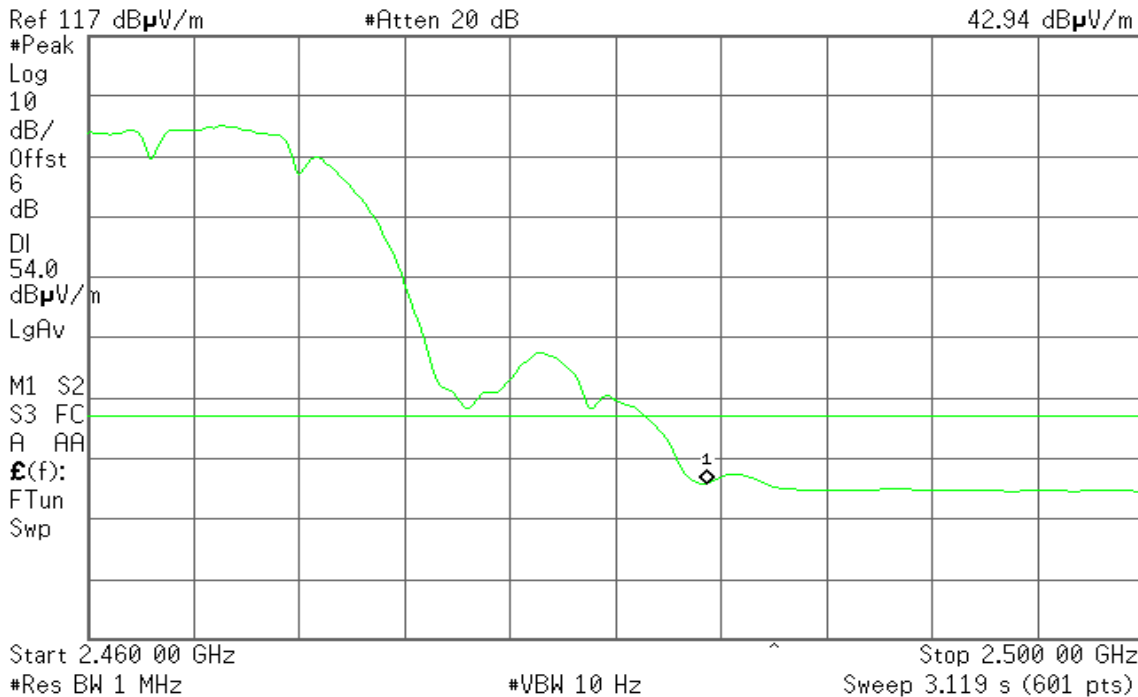



Band Edges (IEEE 802.11g mode / CH Low)

Detector mode: Peak

Polarity: Vertical

Agilent 18:17:16 Jun 14, 2011

R T

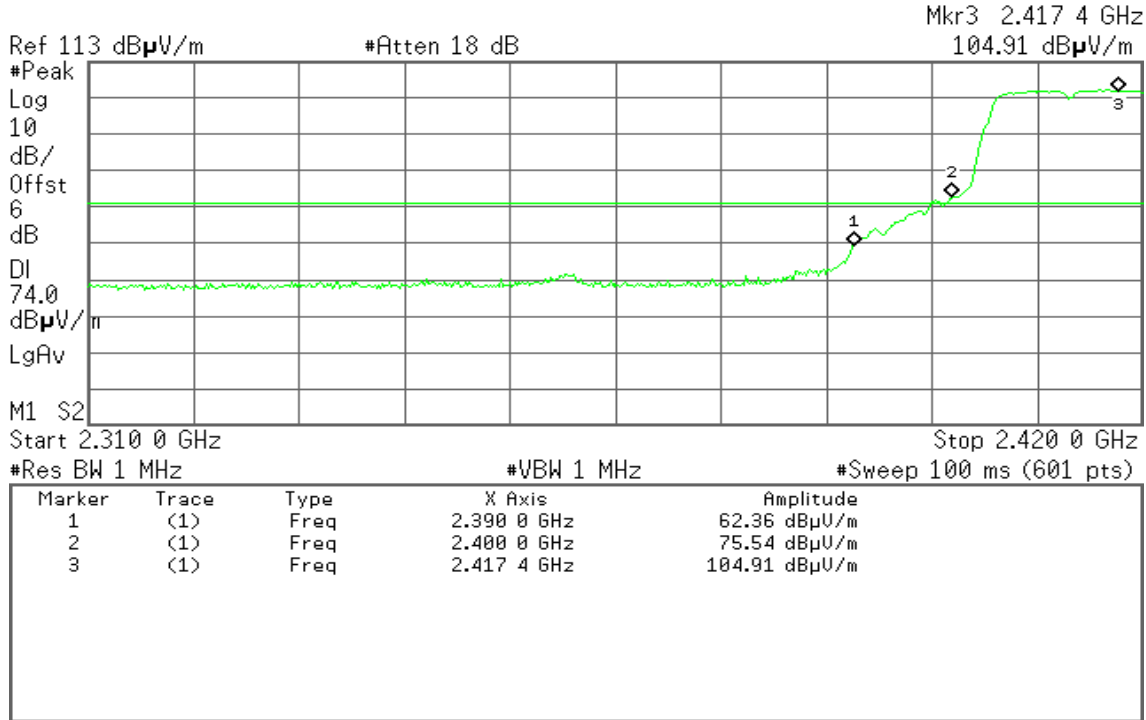

Detector mode: Average

Polarity: Vertical

Agilent 18:16:26 Jun 14, 2011

R T

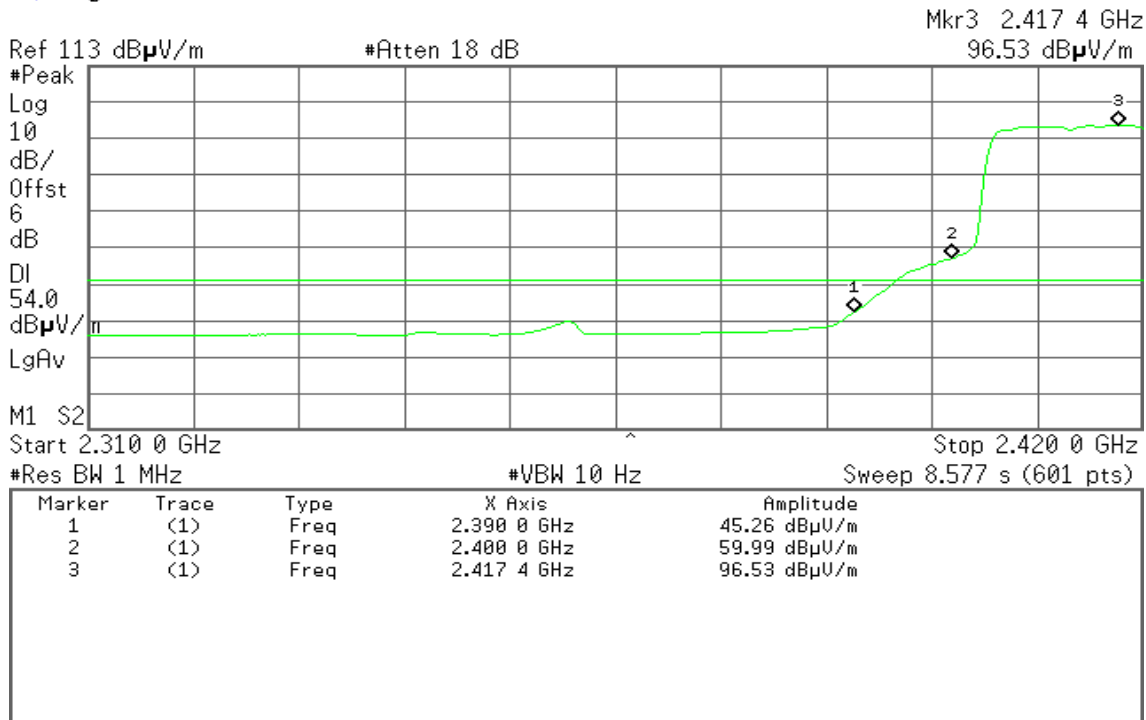



Detector mode: Peak

Polarity: Horizontal

Agilent 18:09:45 Jun 14, 2011

R T

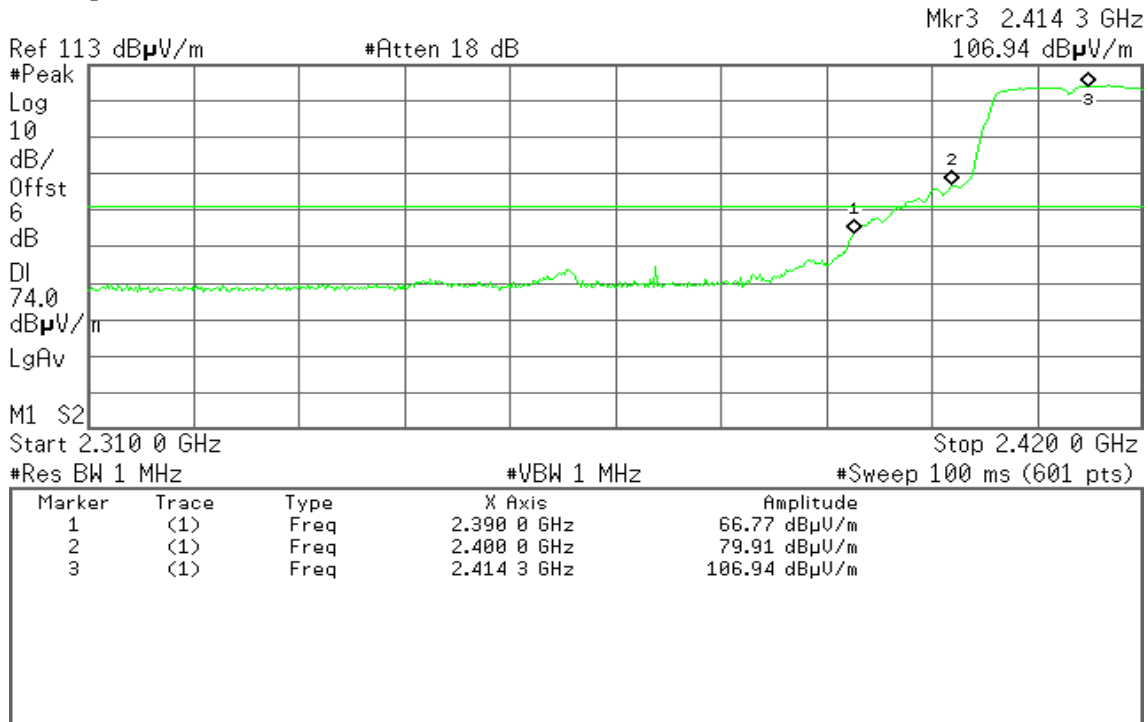

Detector mode: Average

Polarity: Horizontal

Agilent 18:08:04 Jun 14, 2011

R T

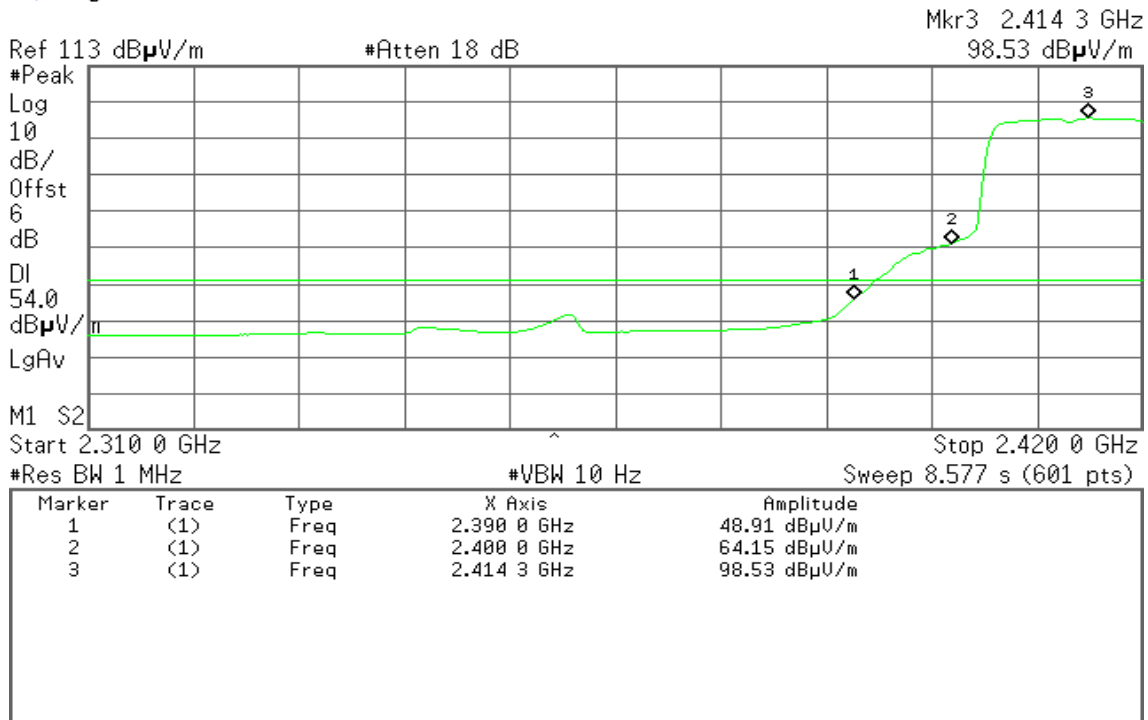



Band Edges (IEEE 802.11g mode / CH High)

Detector mode: Peak

Polarity: Vertical

Agilent 20:11:25 Jun 14, 2011

R T

Mkr1 2.483 50 GHz
69.05 dB μ V/m

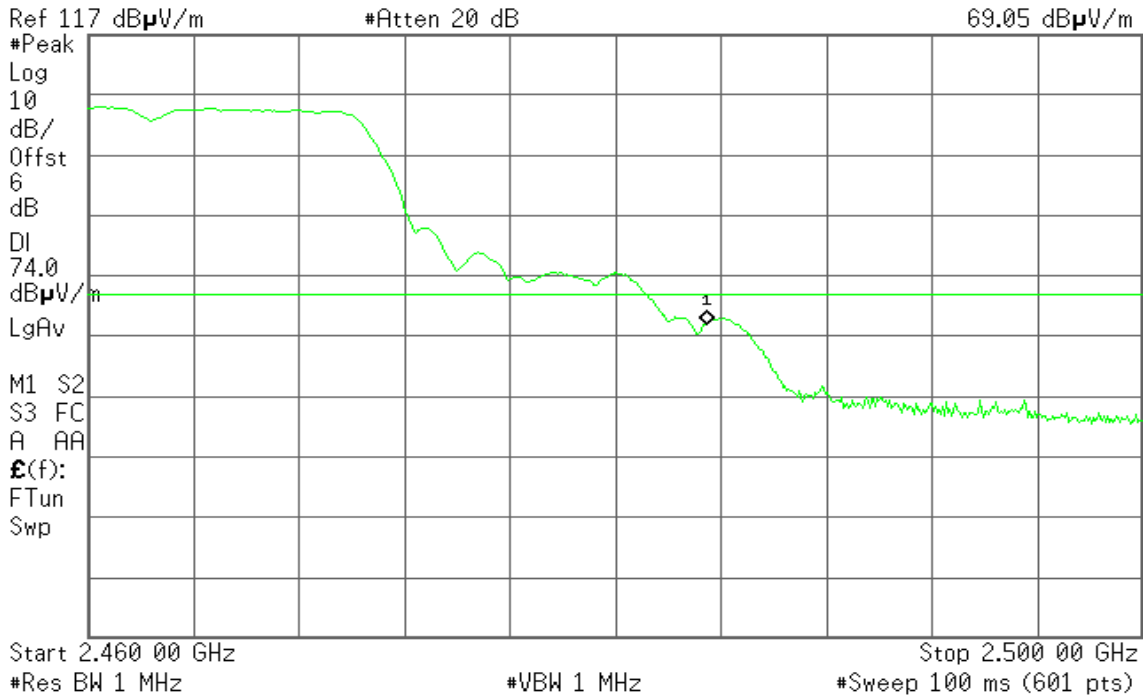

Detector mode: Average

Polarity: Vertical

Agilent 20:10:52 Jun 14, 2011

R T

Mkr1 2.483 50 GHz
52.28 dB μ V/m

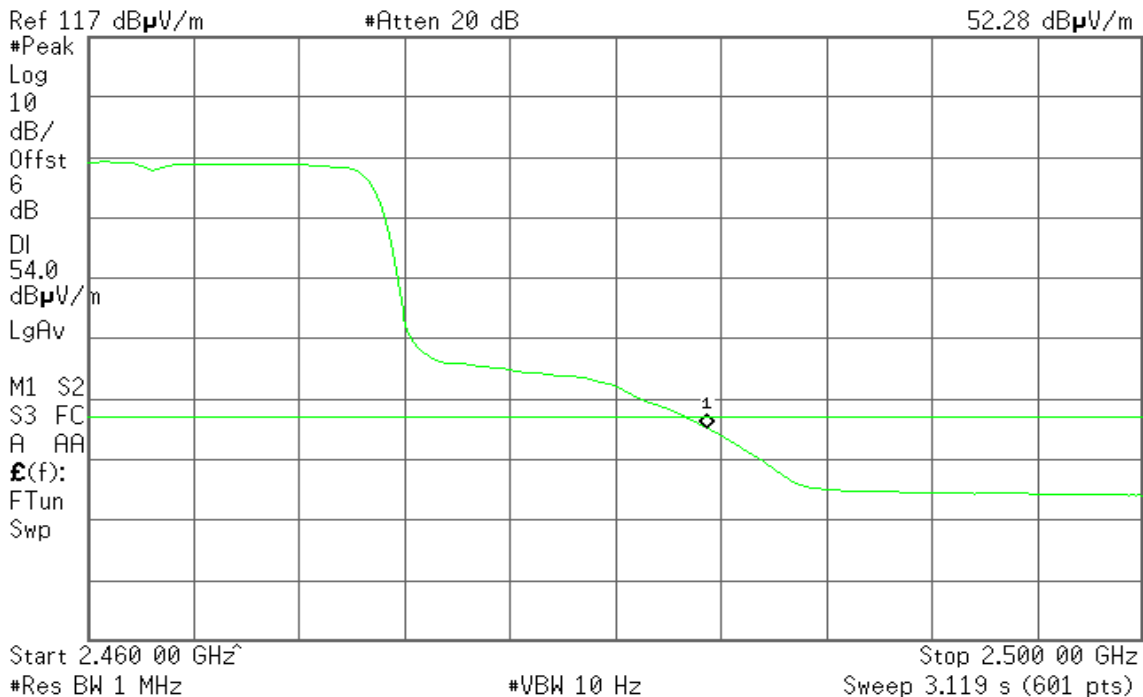



Detector mode: Peak

Polarity: Horizontal

Agilent 20:20:43 Jun 14, 2011

R T

Mkr1 2.483 50 GHz
68.61 dB μ V/m

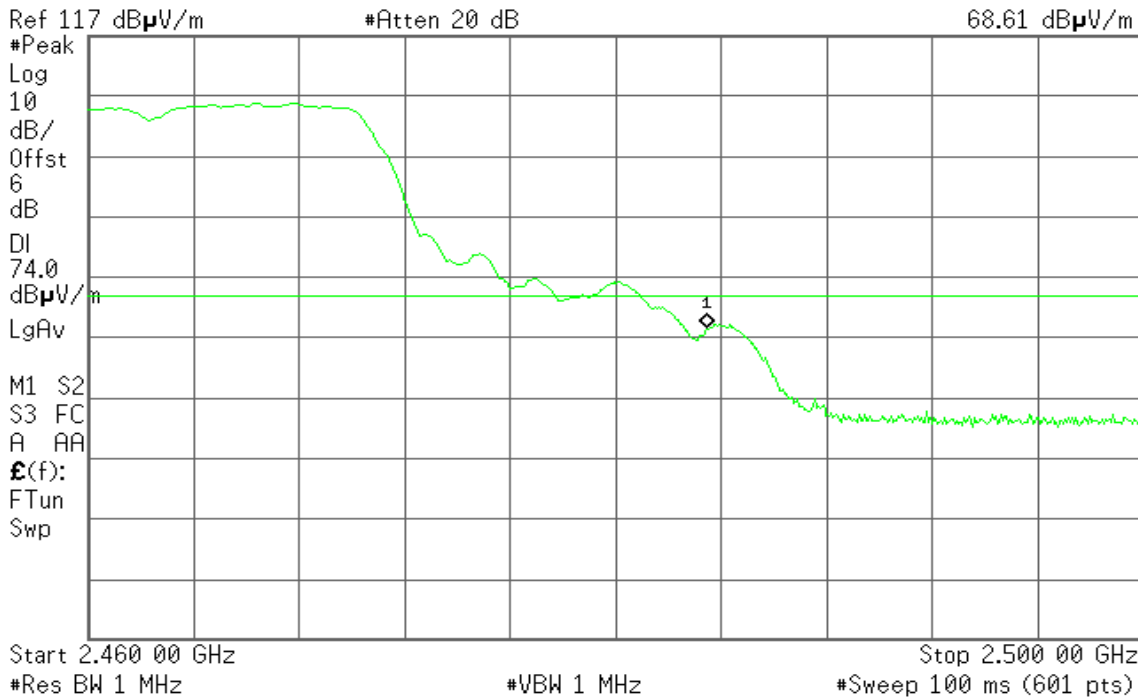

Detector mode: Average

Polarity: Horizontal

Agilent 20:20:09 Jun 14, 2011

R T

Mkr1 2.483 50 GHz
50.88 dB μ V/m

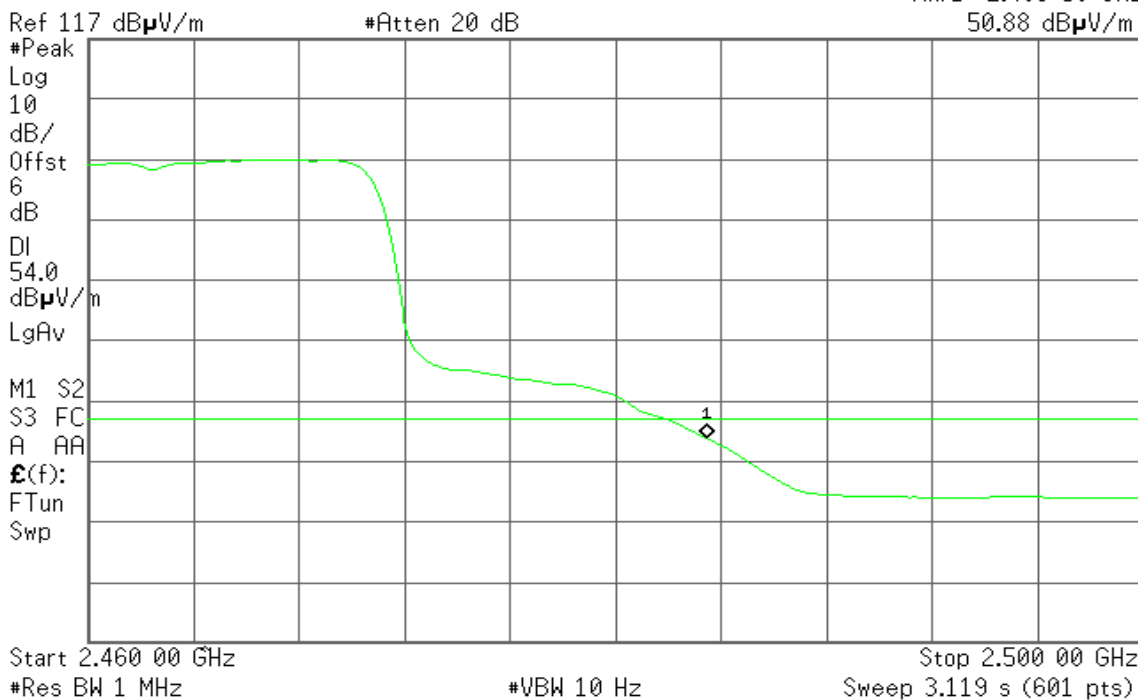



Band Edges (IEEE 802.11n HT 20 MHz mode / CH Low)

Detector mode: Peak

Polarity: Vertical

Agilent 19:09:26 Jun 14, 2011

R T

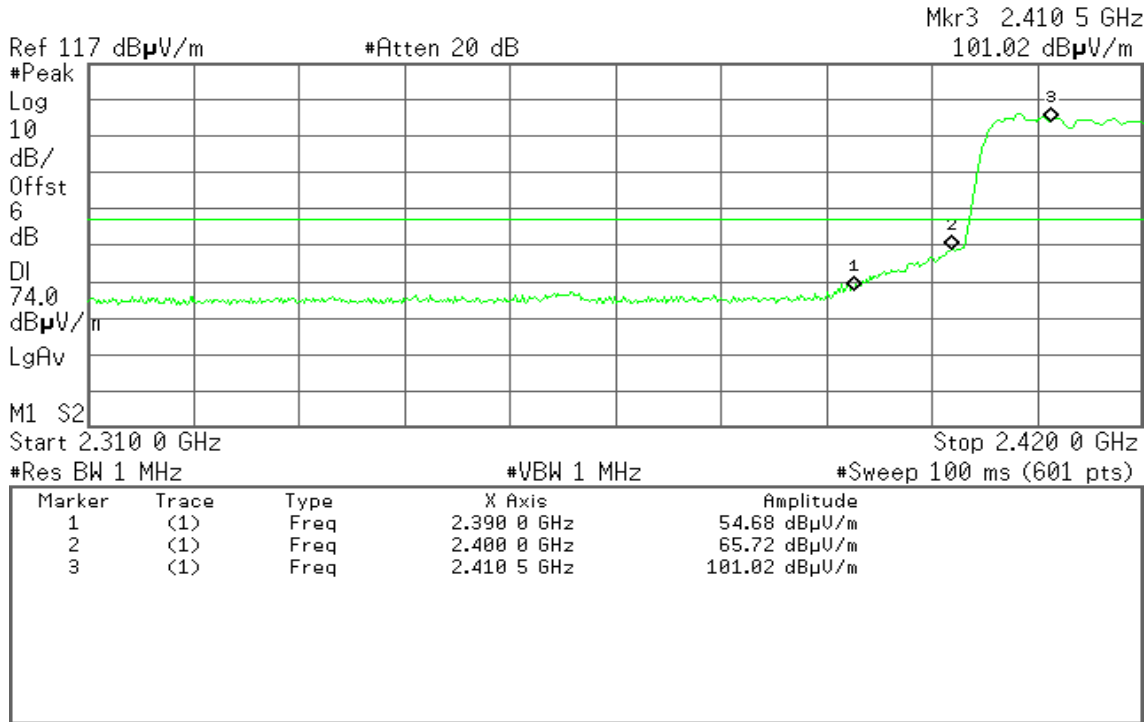

Detector mode: Average

Polarity: Vertical

Agilent 19:08:48 Jun 14, 2011

R T

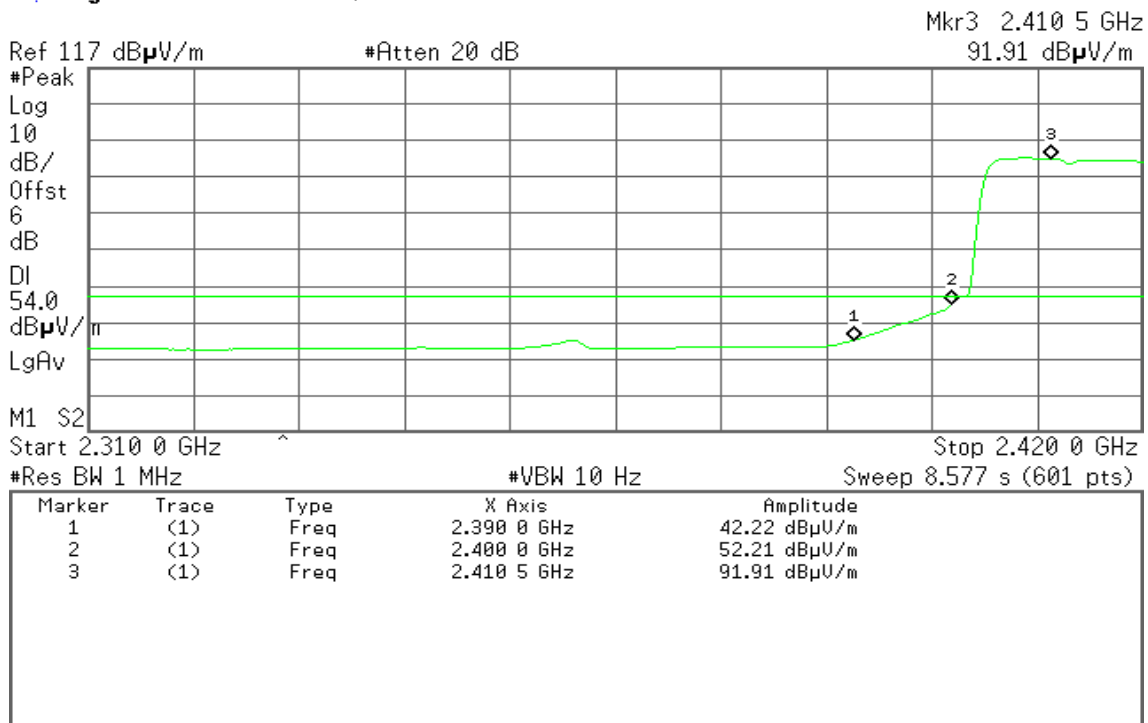



Detector mode: Peak

Polarity: Horizontal

Agilent 18:55:59 Jun 14, 2011

R T

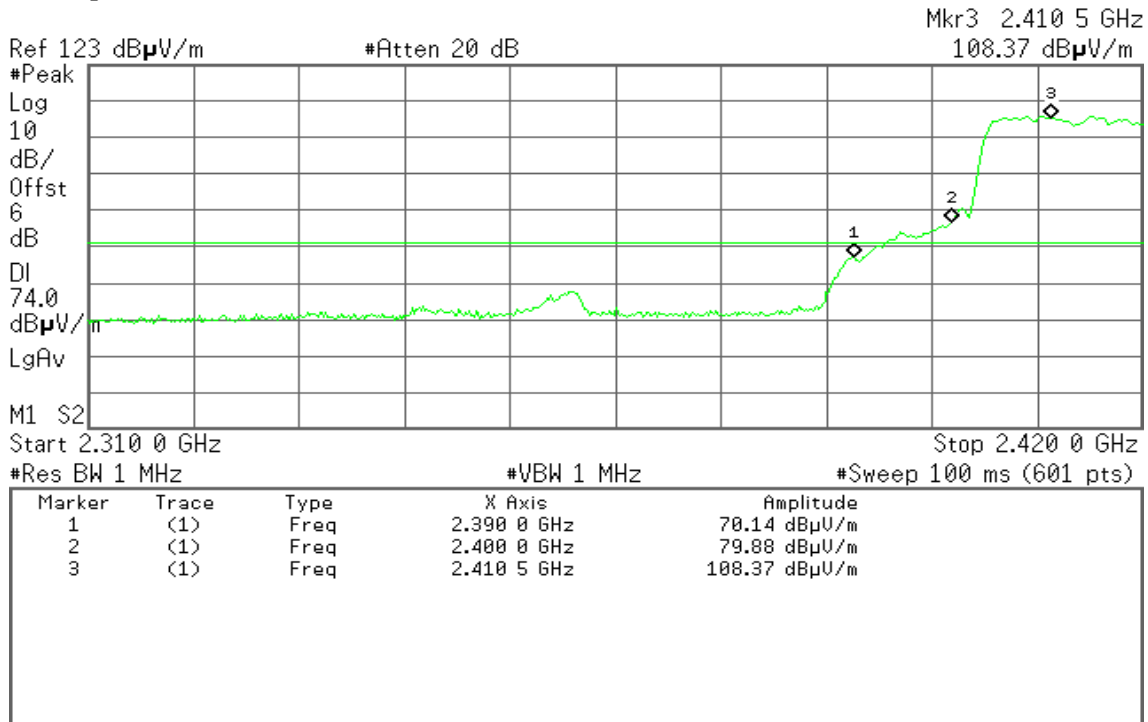

Detector mode: Average

Polarity: Horizontal

Agilent 18:55:07 Jun 14, 2011

R T

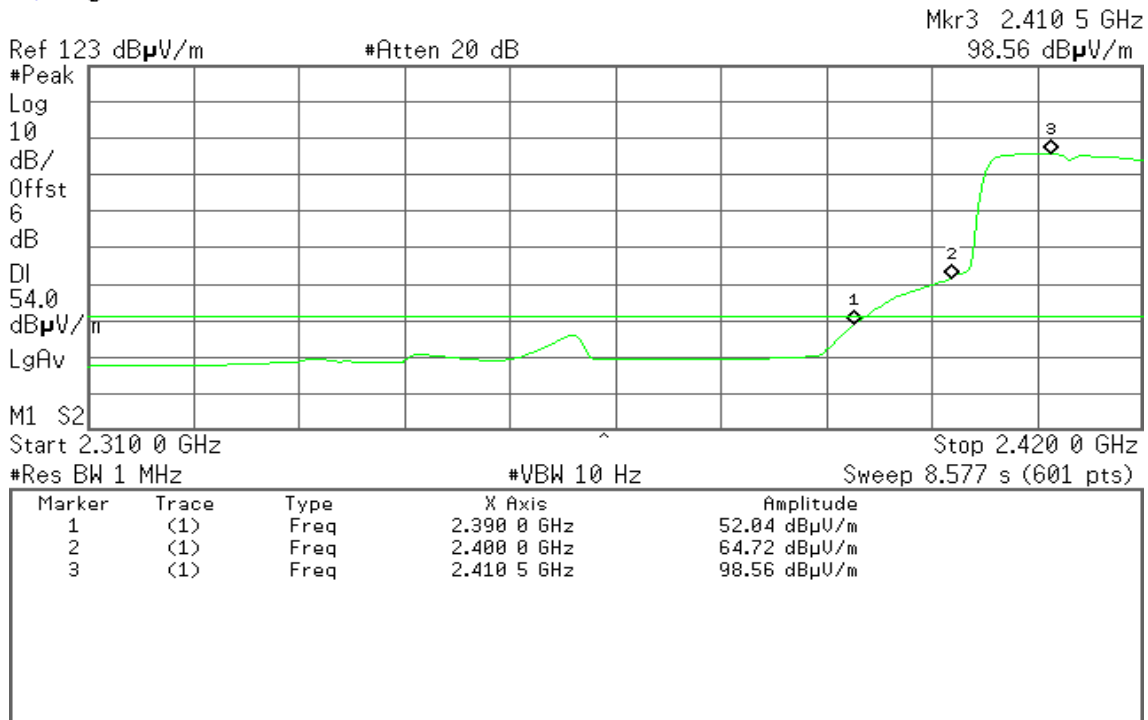



Band Edges (IEEE 802.11n HT 20 MHz mode / CH High)

Detector mode: Peak

Polarity: Vertical

Agilent 20:00:04 Jun 14, 2011

R T

Mkr1 2.483 50 GHz
64.87 dB μ V/m

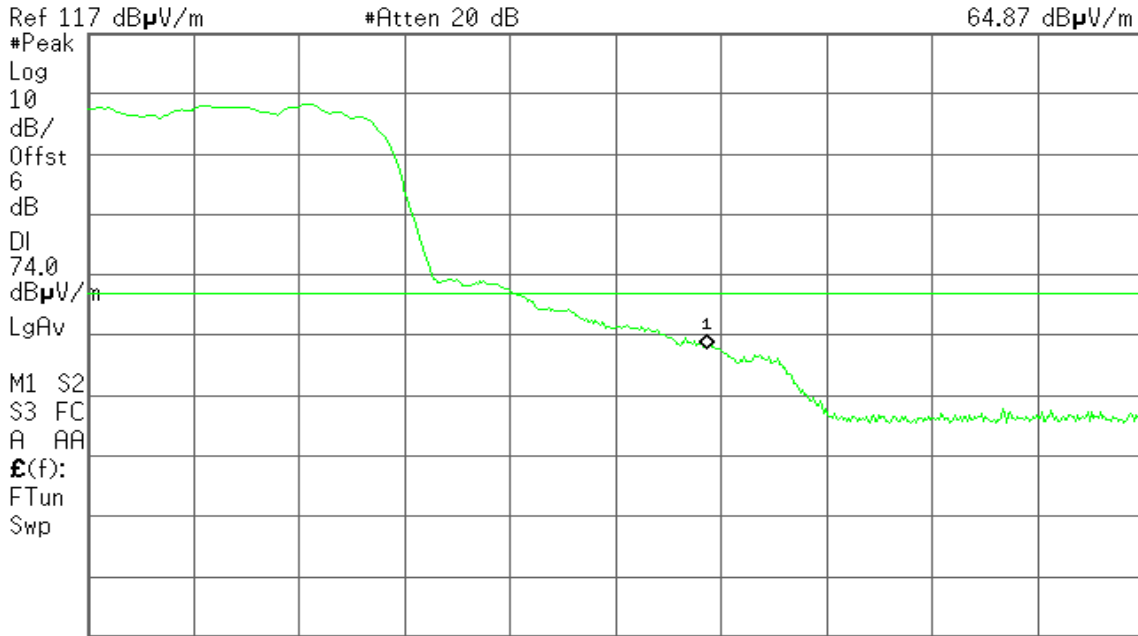

Start 2.460 00 GHz

Stop 2.500 00 GHz

#Res BW 1 MHz

#VBW 1 MHz

#Sweep 100 ms (601 pts)

Detector mode: Average

Polarity: Vertical

Agilent 19:59:32 Jun 14, 2011

R T

Mkr1 2.483 50 GHz
48.40 dB μ V/m

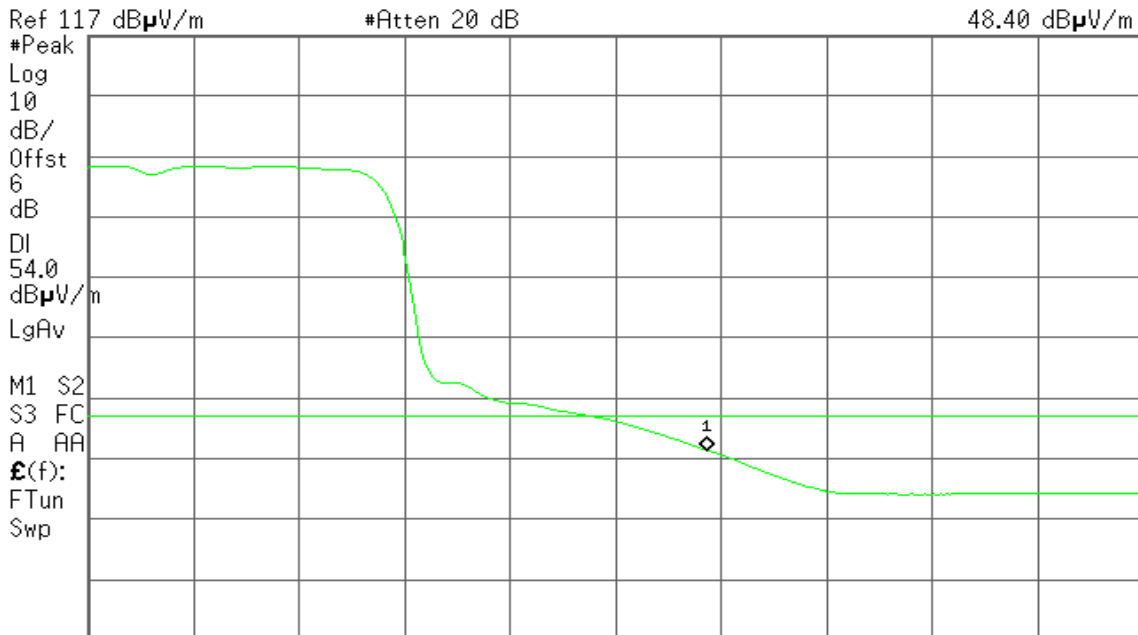

Start 2.460 00 GHz

Stop 2.500 00 GHz

#Res BW 1 MHz

#VBW 10 Hz

Sweep 3.119 s (601 pts)



Detector mode: Peak

Polarity: Horizontal

Agilent 19:54:29 Jun 14, 2011

R T

Mkr1 2.483 50 GHz
69.70 dB μ V/m

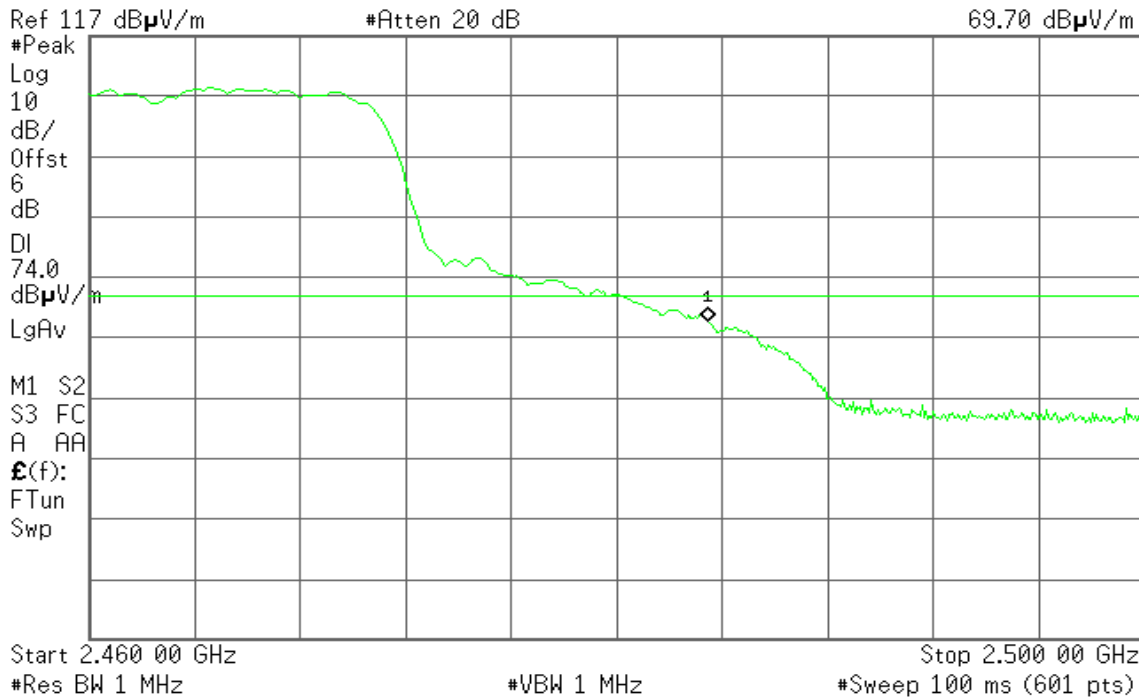

Detector mode: Average

Polarity: Horizontal

Agilent 19:53:49 Jun 14, 2011

R T

Mkr1 2.483 50 GHz
53.73 dB μ V/m

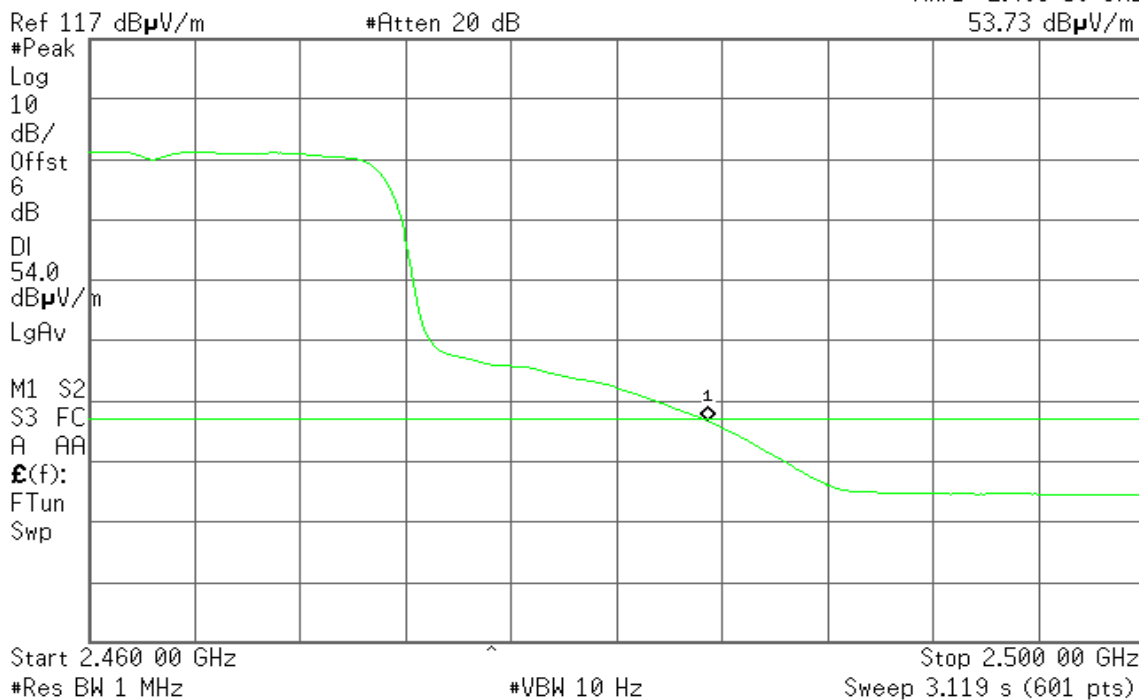



Band Edges (IEEE 802.11n HT 40 MHz mode / CH Low)

Detector mode: Peak

Polarity: Vertical

Agilent 19:17:34 Jun 14, 2011

R T

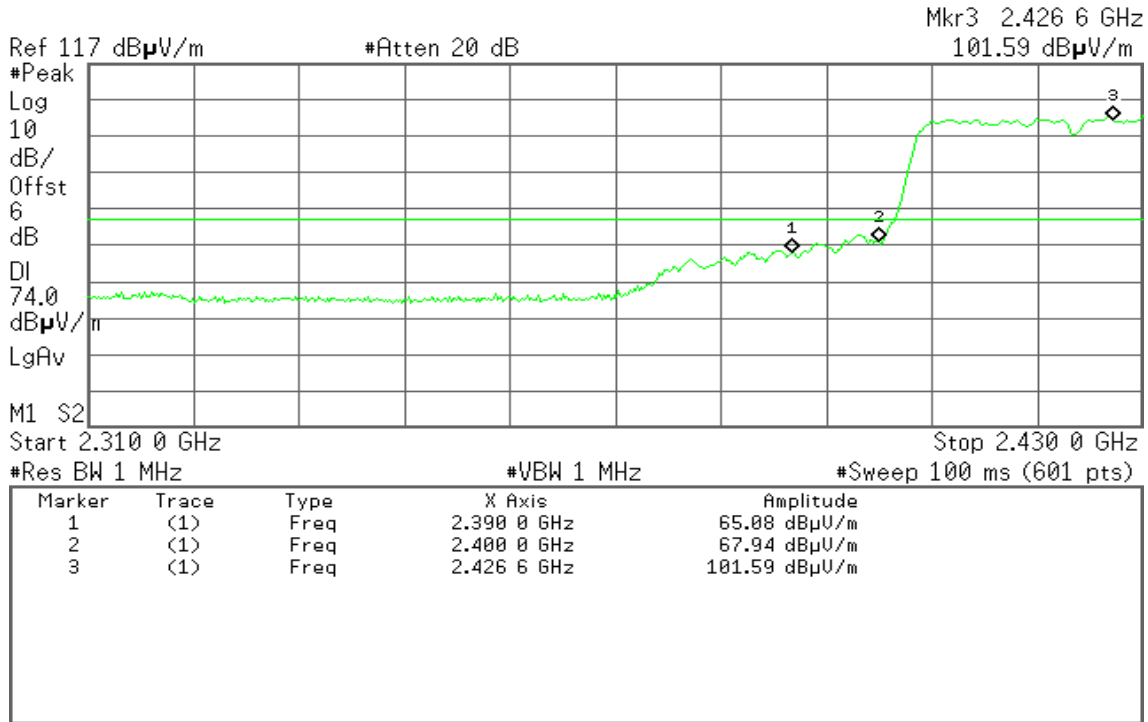

Detector mode: Average

Polarity: Vertical

Agilent 19:15:57 Jun 14, 2011

R T

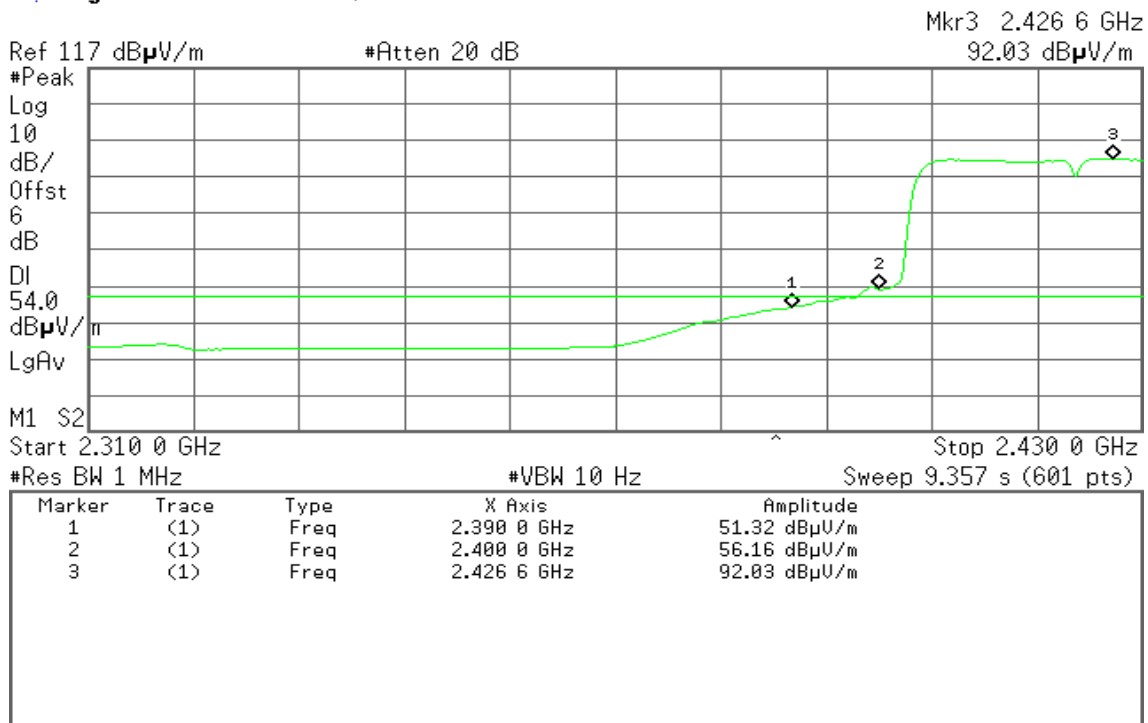



Detector mode: Peak

Polarity: Horizontal

Agilent 19:27:30 Jun 14, 2011

R T

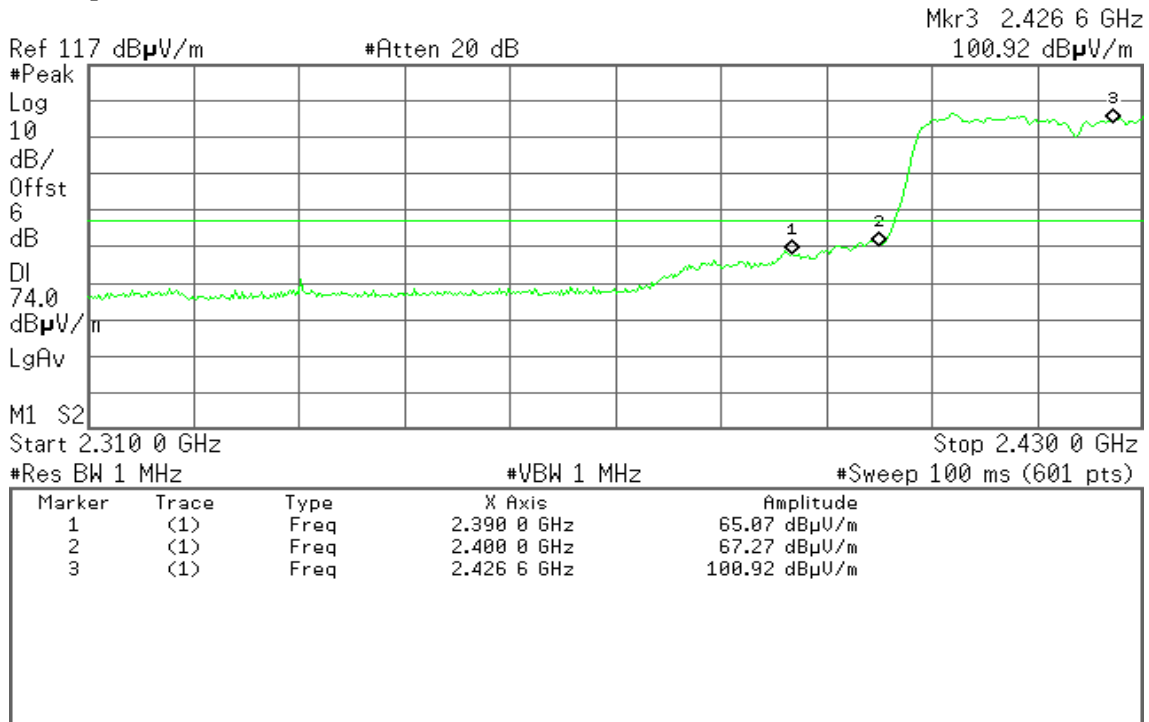

Detector mode: Average

Polarity: Horizontal

Agilent 19:26:48 Jun 14, 2011

R T

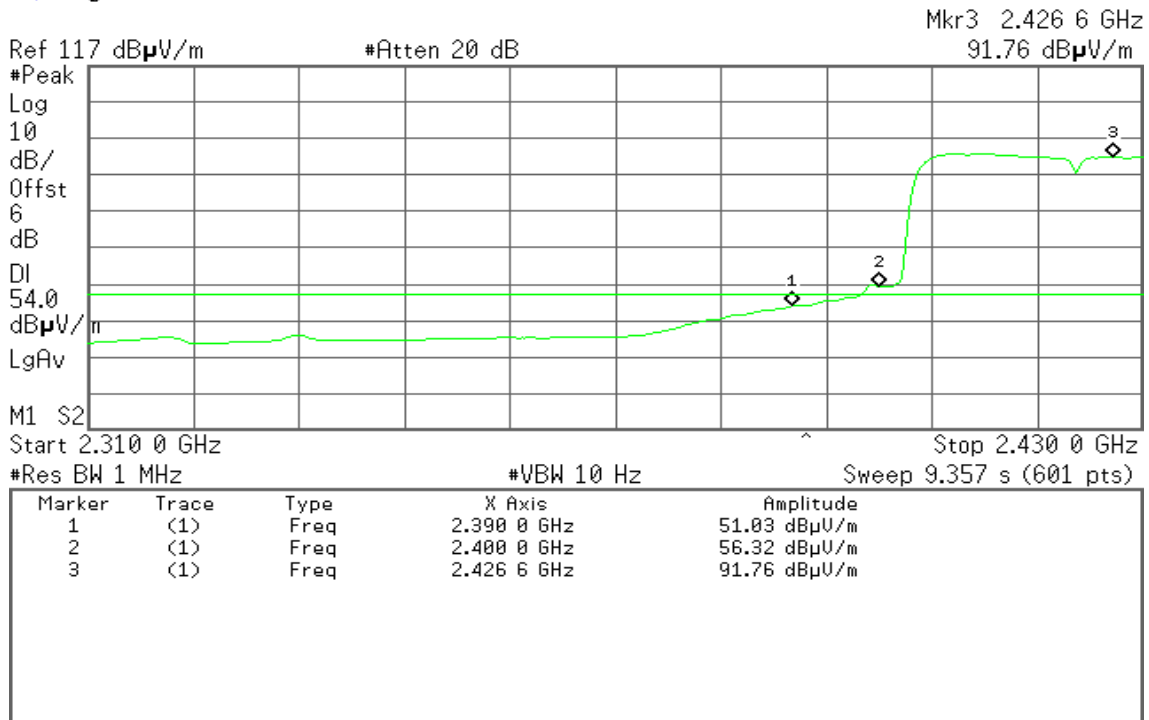



Band Edges (IEEE 802.11n HT 40 MHz mode / CH High)

Detector mode: Peak

Polarity: Vertical

Agilent 19:42:27 Jun 14, 2011

R T

Mkr1 2.483 50 GHz
63.17 dB μ V/m

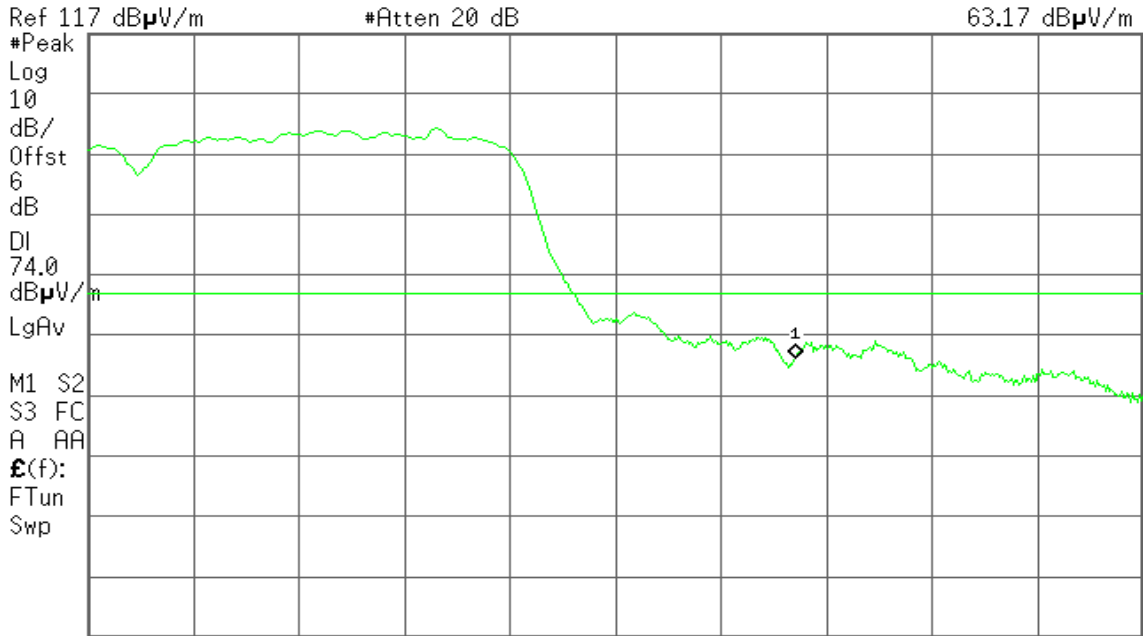

Start 2.450 00 GHz Stop 2.500 00 GHz
#Res BW 1 MHz #VBW 1 MHz #Sweep 100 ms (601 pts)

Detector mode: Average

Polarity: Vertical

Agilent 19:41:59 Jun 14, 2011

R L

Mkr1 2.483 50 GHz
49.63 dB μ V/m

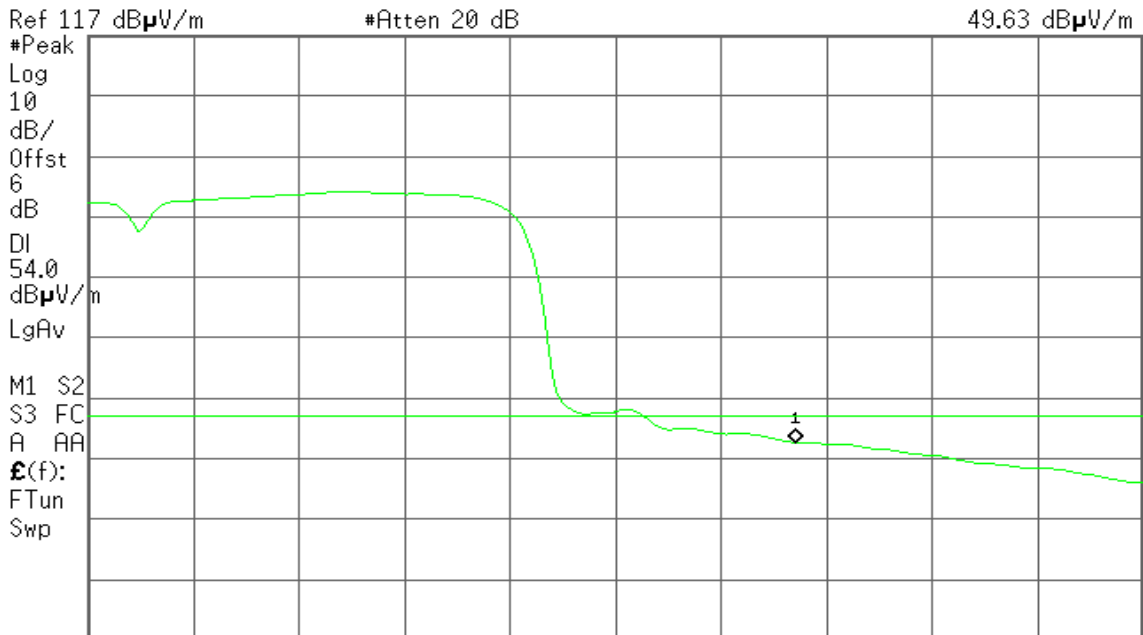

Start 2.450 00 GHz Stop 2.500 00 GHz
#Res BW 1 MHz #VBW 10 Hz Sweep 3.899 s (601 pts)



Detector mode: Peak

Polarity: Horizontal

Agilent 19:38:17 Jun 14, 2011

R T

Mkr1 2.483 50 GHz
68.96 dB μ V/m

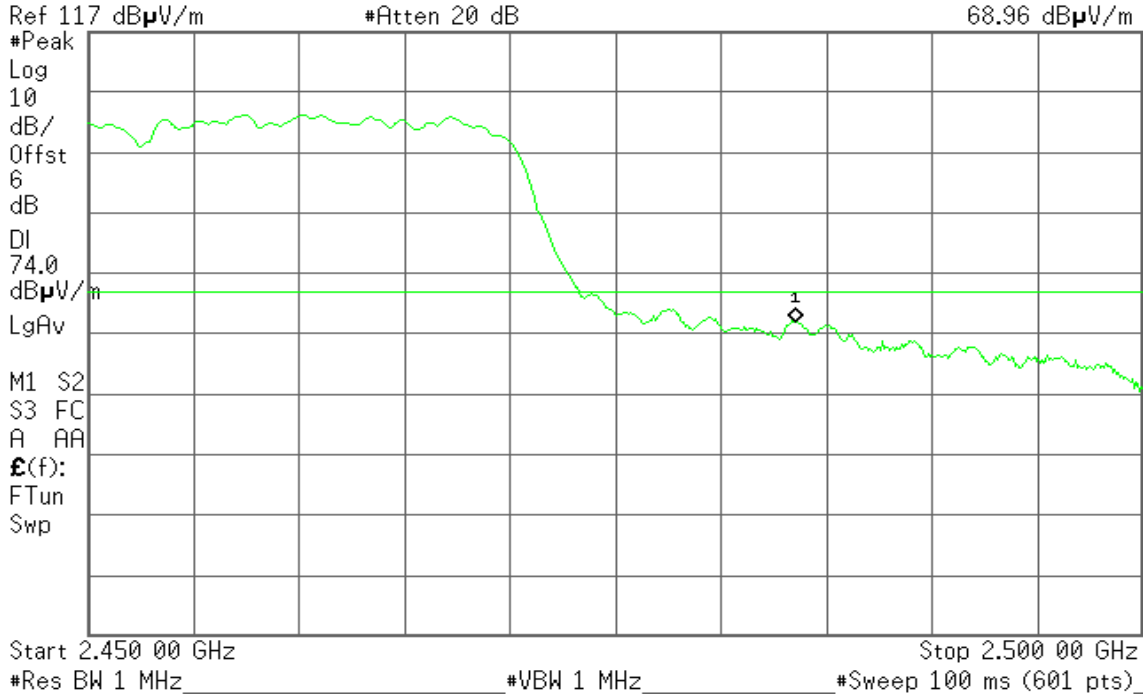

Detector mode: Average

Polarity: Horizontal

Agilent 19:37:35 Jun 14, 2011

R T

Mkr1 2.483 50 GHz
53.49 dB μ V/m

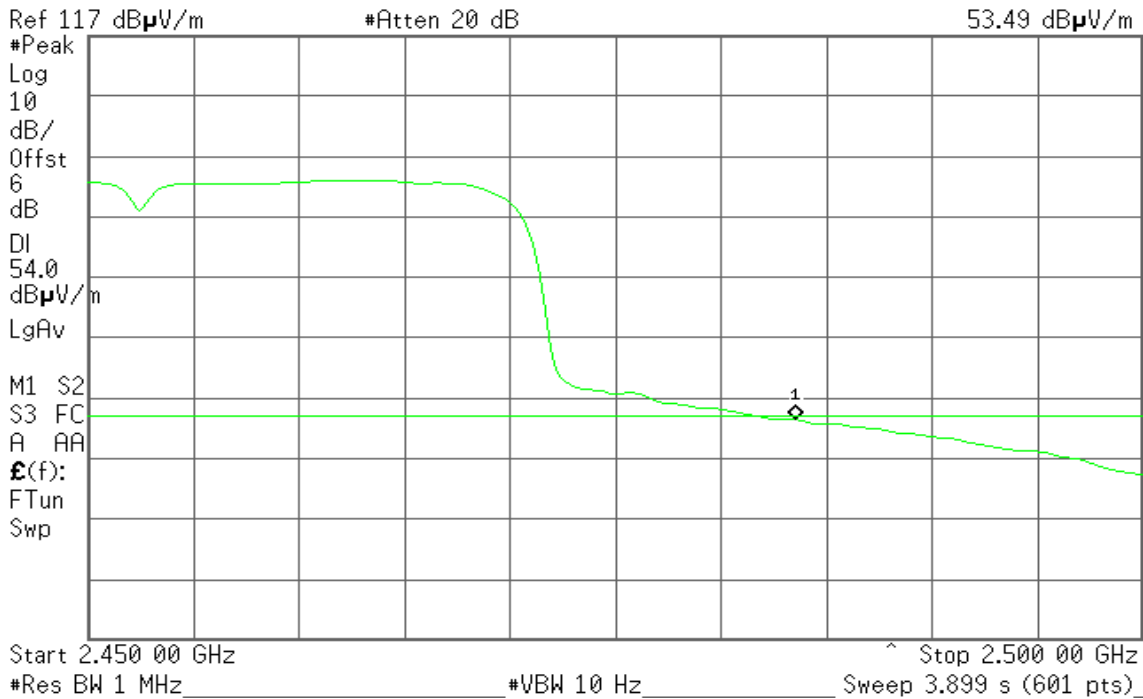



7.5 PEAK POWER SPECTRAL DENSITY

LIMIT

1. According to §15.247(e), for digitally modulated systems, the power spectral density conducted from the intentional radiator to the antenna shall not be greater than 8 dBm in any 3 kHz band during any time interval of continuous transmission.
2. According to §15.247(f), the digital modulation operation of the hybrid system, with the frequency hopping turned off, shall comply with the power density requirements of paragraph (d) of this section.

Test Configuration

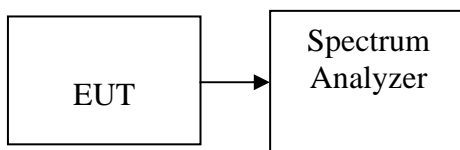

TEST PROCEDURE

1. Place the EUT on the table and set it in transmitting mode.
Remove the antenna from the EUT and then connect a low loss RF cable from the antenna port to the spectrum analyzer.
2. Set the spectrum analyzer as RBW = 3 kHz, VBW = 10 kHz, Span = 300 kHz, Sweep time = 100 s
3. Record the max reading.
4. Repeat the above procedure until the measurements for all frequencies are completed.



TEST RESULTS

No non-compliance noted

Test Data

Test mode: IEEE 802.11b mode

Channel	Frequency (MHz)	PPSD (dBm)	Limit (dBm)	Result
Low	2412	-13.88	8.00	PASS
Mid	2437	-12.45		PASS
High	2462	-13.95		PASS

Test mode: IEEE 802.11g mode

Channel	Frequency (MHz)	PPSD (dBm)	Limit (dBm)	Result
Low	2412	-12.51	8.00	PASS
Mid	2437	-12.17		PASS
High	2462	-13.20		PASS

Test mode: IEEE 802.11n HT 20 MHz mode

Channel	Frequency (MHz)	Chain 0 PPSD (dBm)	Chain 1 PPSD (dBm)	PPSD (dBm)	Limit (dBm)	Result
Low	2412	-14.72	-15.94	-12.28	7.00	PASS
Mid	2437	-13.78	-16.28	-11.84		PASS
High	2462	-14.80	-14.92	-11.85		PASS

Test mode: IEEE 802.11n HT 40 MHz mode

Channel	Frequency (MHz)	Chain 0 PPSD (dBm)	Chain 1 PPSD (dBm)	PPSD (dBm)	Limit (dBm)	Result
Low	2422	-15.35	-17.89	-13.43	7.00	PASS
Mid	2437	-15.57	-18.40	-13.75		PASS
High	2452	-15.13	-17.74	-13.23		PASS

Remark:

1. $Total\ PPSD\ (dBm) = 10 * LOG(10^{Chain\ 0\ PPSD / 10} + 10^{Chain\ 1\ PPSD / 10})$
2. The maximum antenna gain is 6.81 dBi; therefore the reduction due to antenna gain is 1dB, so the limit is 7dBm.



Test Plot

IEEE 802.11b mode

PPSD (CH Low)

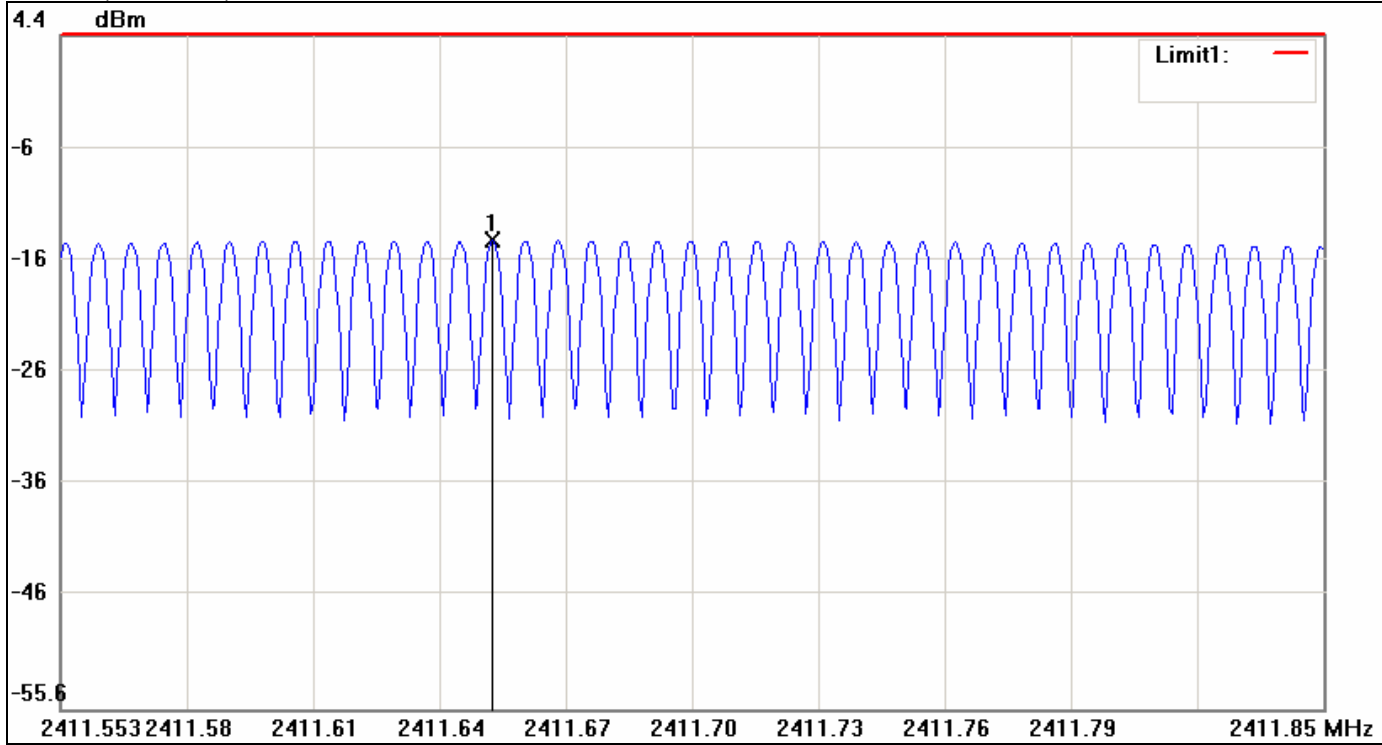

No.	Frequency(MHz)	Level(dBm)	Limit(dBm)	Margin(dBm)
1	2411.6557	-13.88	8.00	-21.88



PPSD (CH Mid)

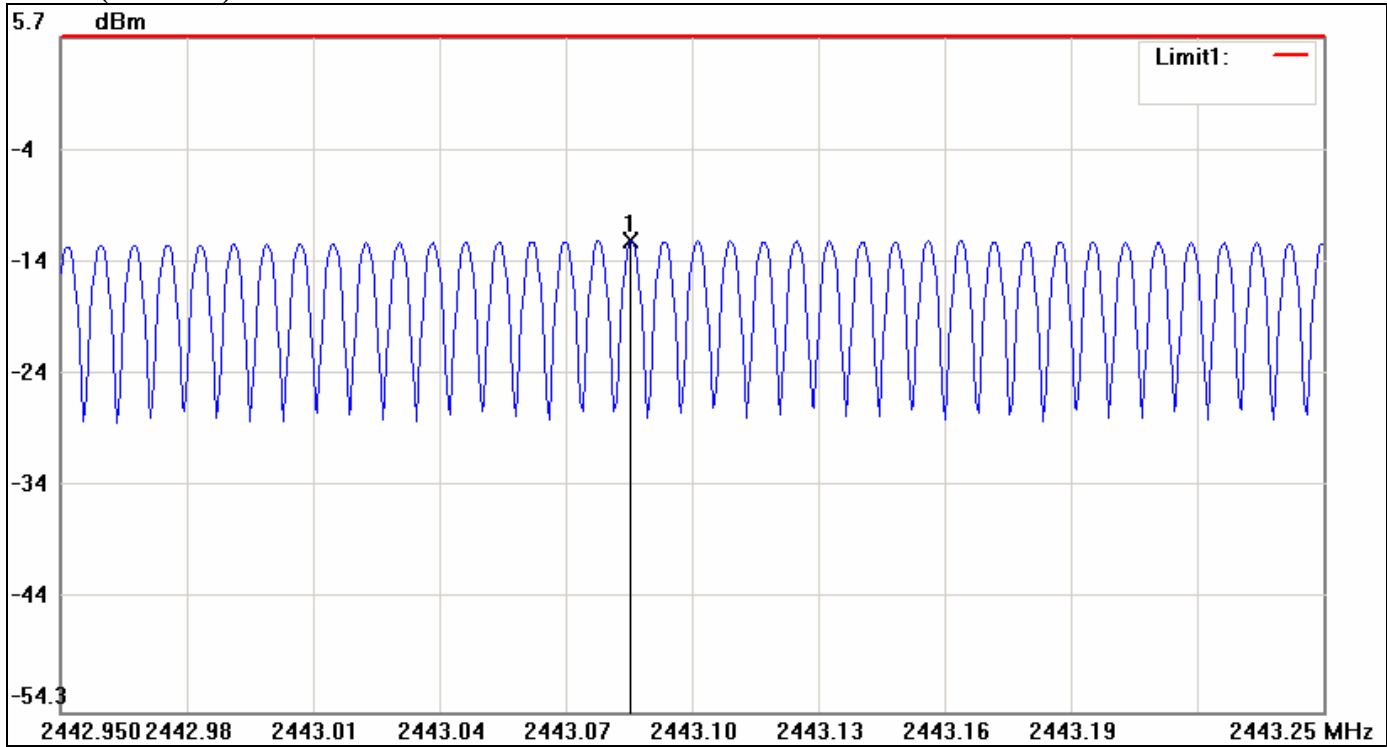

No.	Frequency(MHz)	Level(dBm)	Limit(dBm)	Margin(dBm)
1	2443.0860	-12.45	8.00	-20.45



PPSD (CH High)

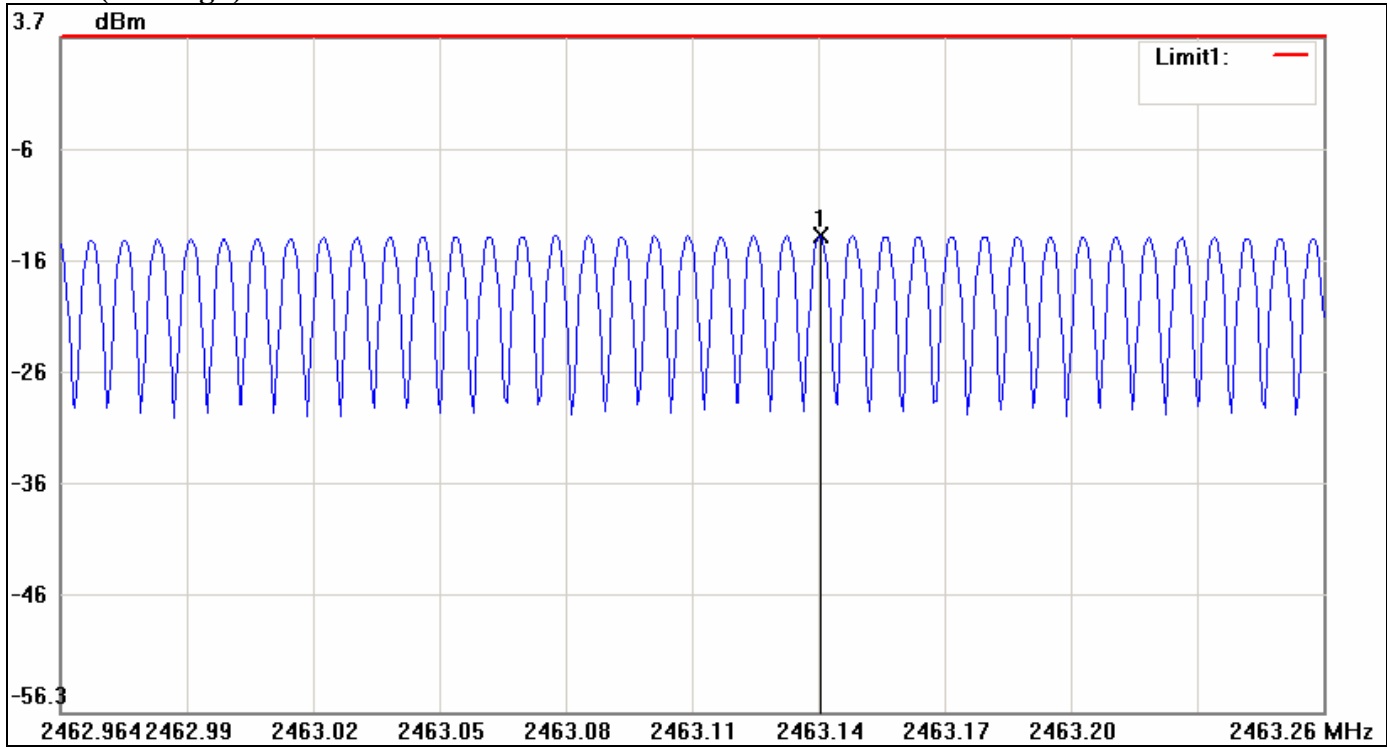

No.	Frequency(MHz)	Level(dBm)	Limit(dBm)	Margin(dBm)
1	2463.1445	-13.95	8.00	-21.95



IEEE 802.11g mode

PPSD (CH Low)

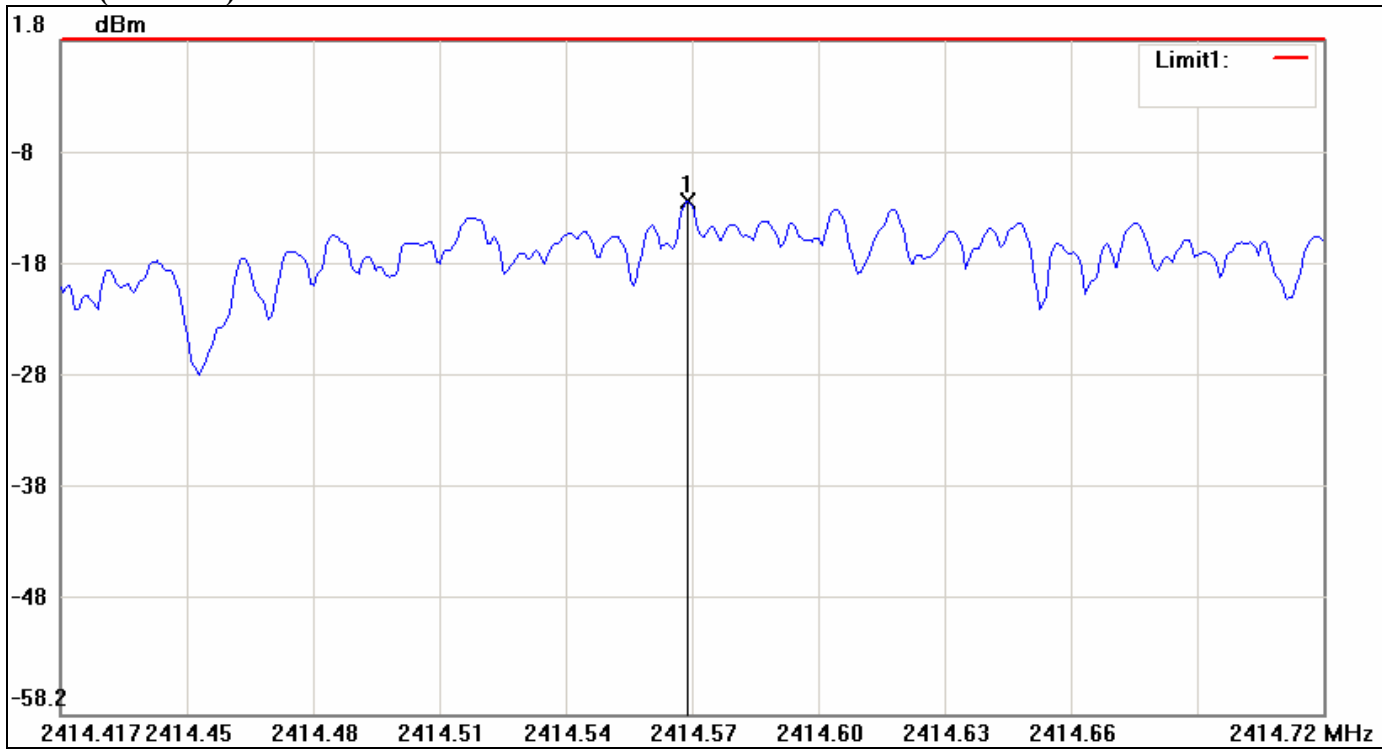

No.	Frequency(MHz)	Level(dBm)	Limit(dBm)	Margin(dBm)
1	2414.5661	-12.51	8.00	-20.51



PPSD (CH Mid)

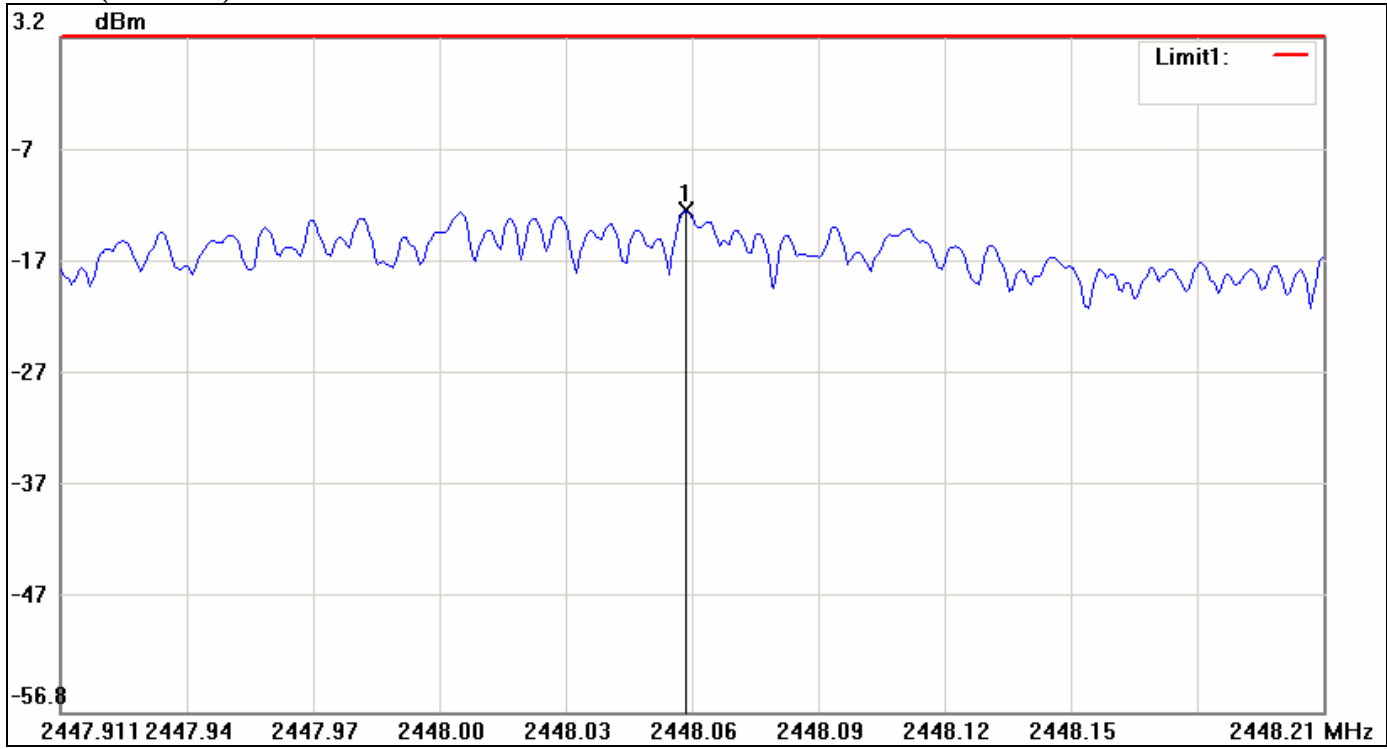

No.	Frequency(MHz)	Level(dBm)	Limit(dBm)	Margin(dBm)
1	2448.0598	-12.17	8.00	-20.17



PPSD (CH High)

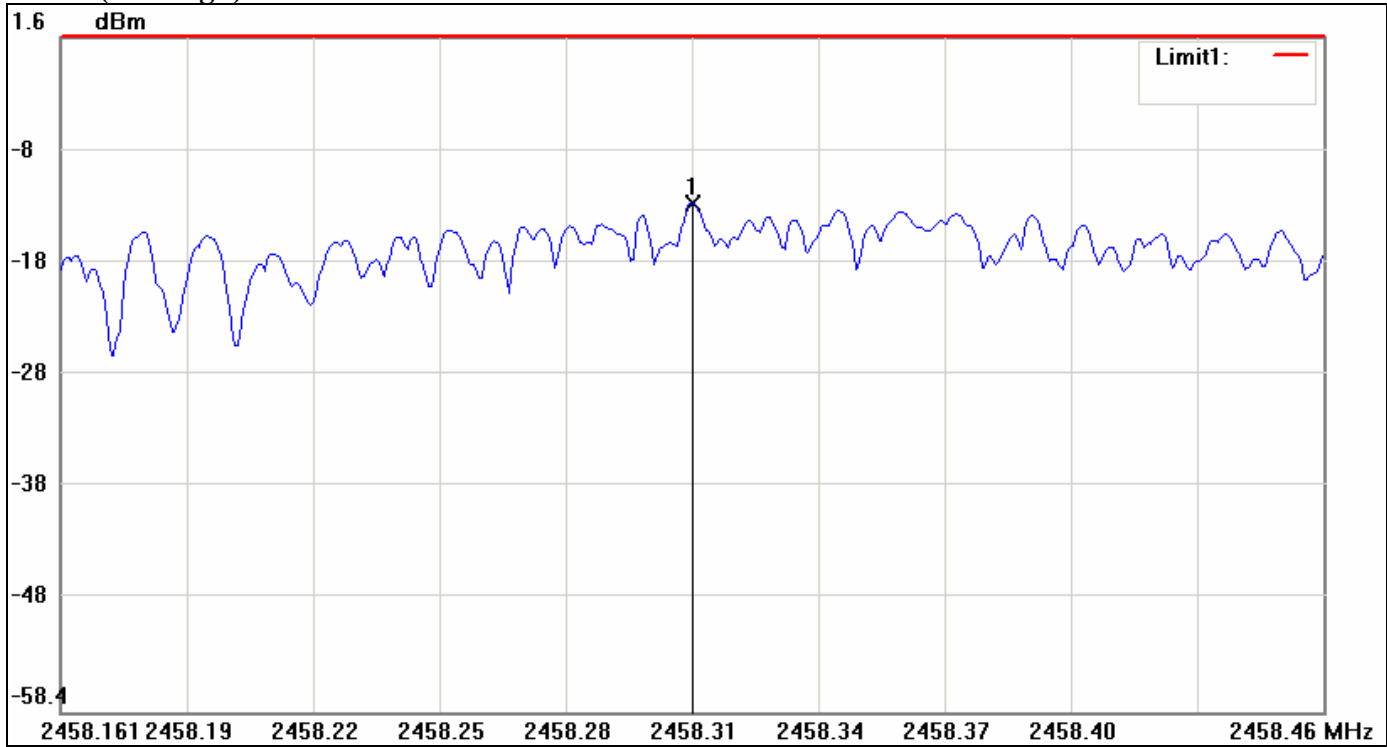

No.	Frequency(MHz)	Level(dBm)	Limit(dBm)	Margin(dBm)
1	2458.3111	-13.20	8.00	-21.20



IEEE 802.11n HT 20 MHz mode / Chain 0

PPSD (CH Low)

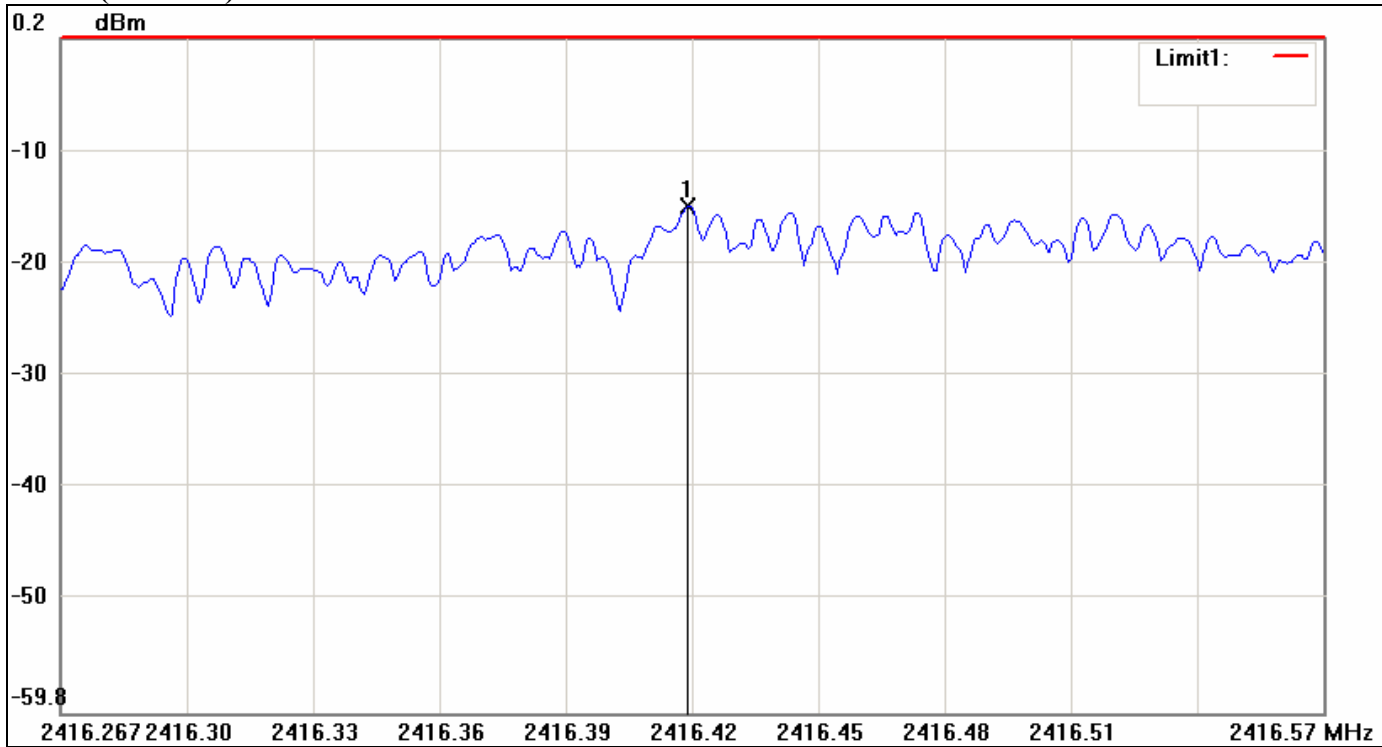

No.	Frequency(MHz)	Level(dBm)	Limit(dBm)	Margin(dBm)
1	2416.4162	-14.72	8.00	-22.72



PPSD (CH Mid)

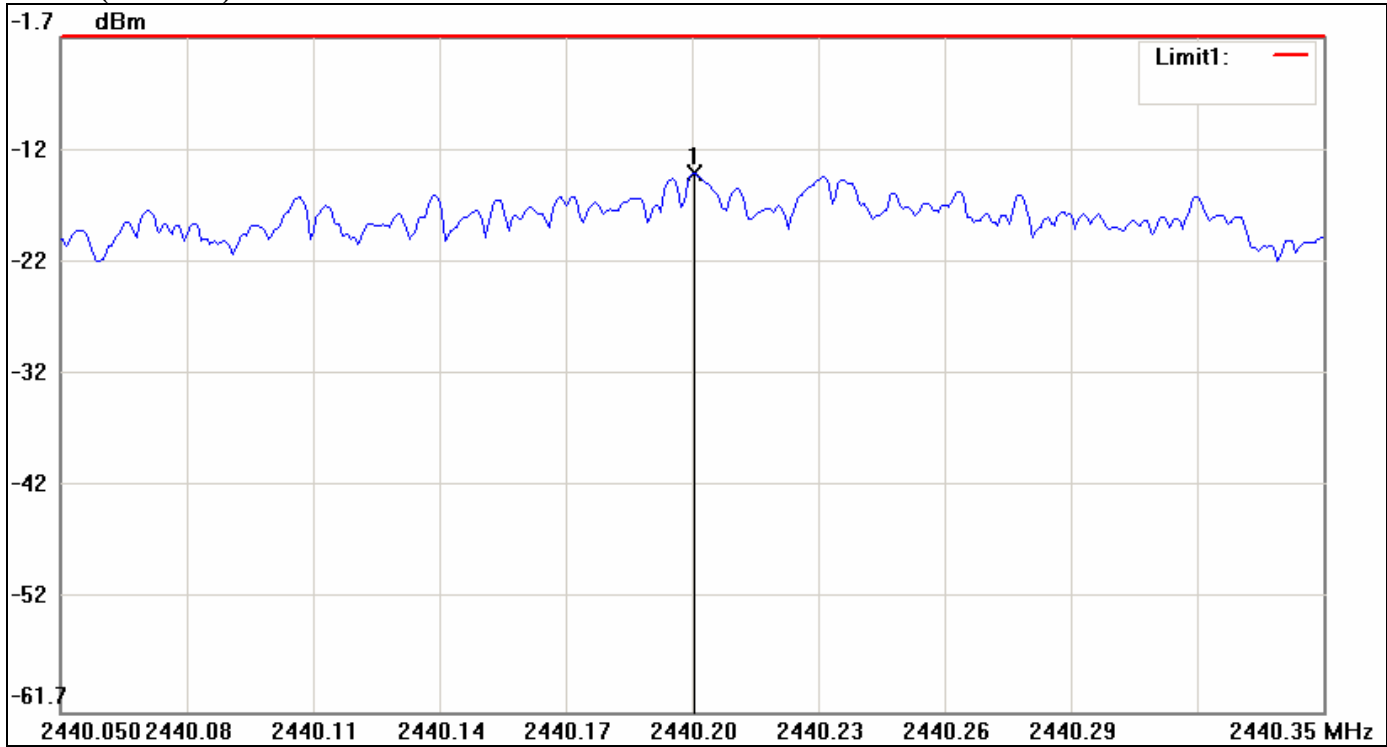

No.	Frequency(MHz)	Level(dBm)	Limit(dBm)	Margin(dBm)
1	2440.2010	-13.78	8.00	-21.78



PPSD (CH High)

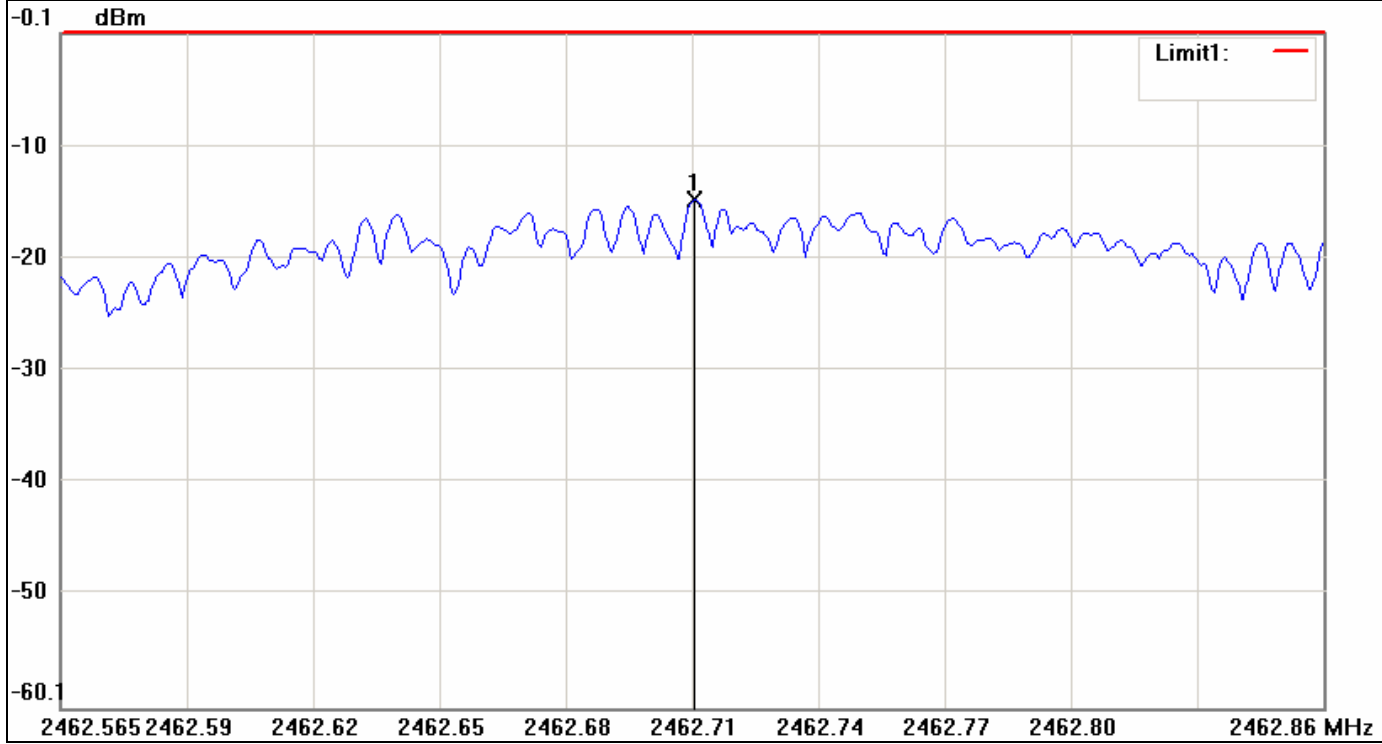

No.	Frequency(MHz)	Level(dBm)	Limit(dBm)	Margin(dBm)
1	2462.7152	-14.80	8.00	-22.80



IEEE 802.11n HT 20 MHz mode / Chain 1

PPSD (CH Low)

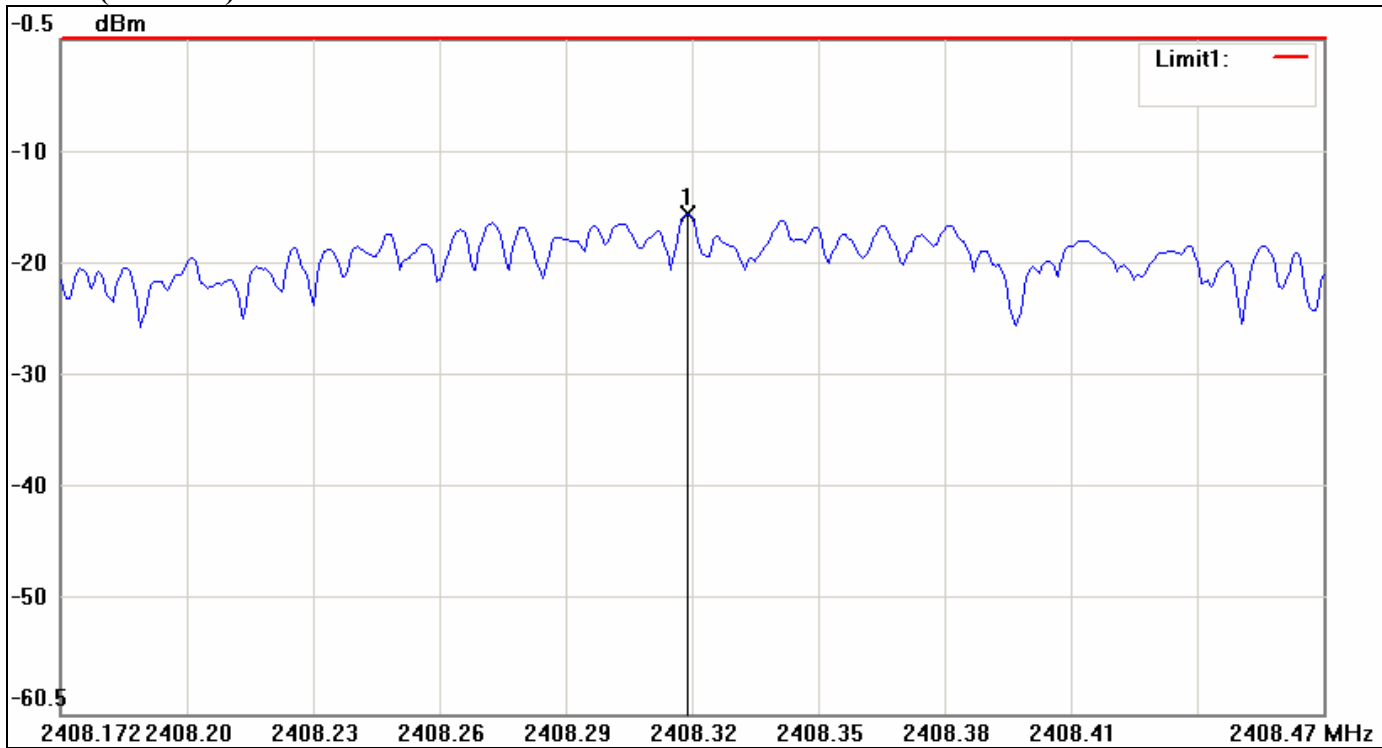

No.	Frequency(MHz)	Level(dBm)	Limit(dBm)	Margin(dBm)
1	2408.3210	-15.94	8.00	-23.94



PPSD (CH Mid)

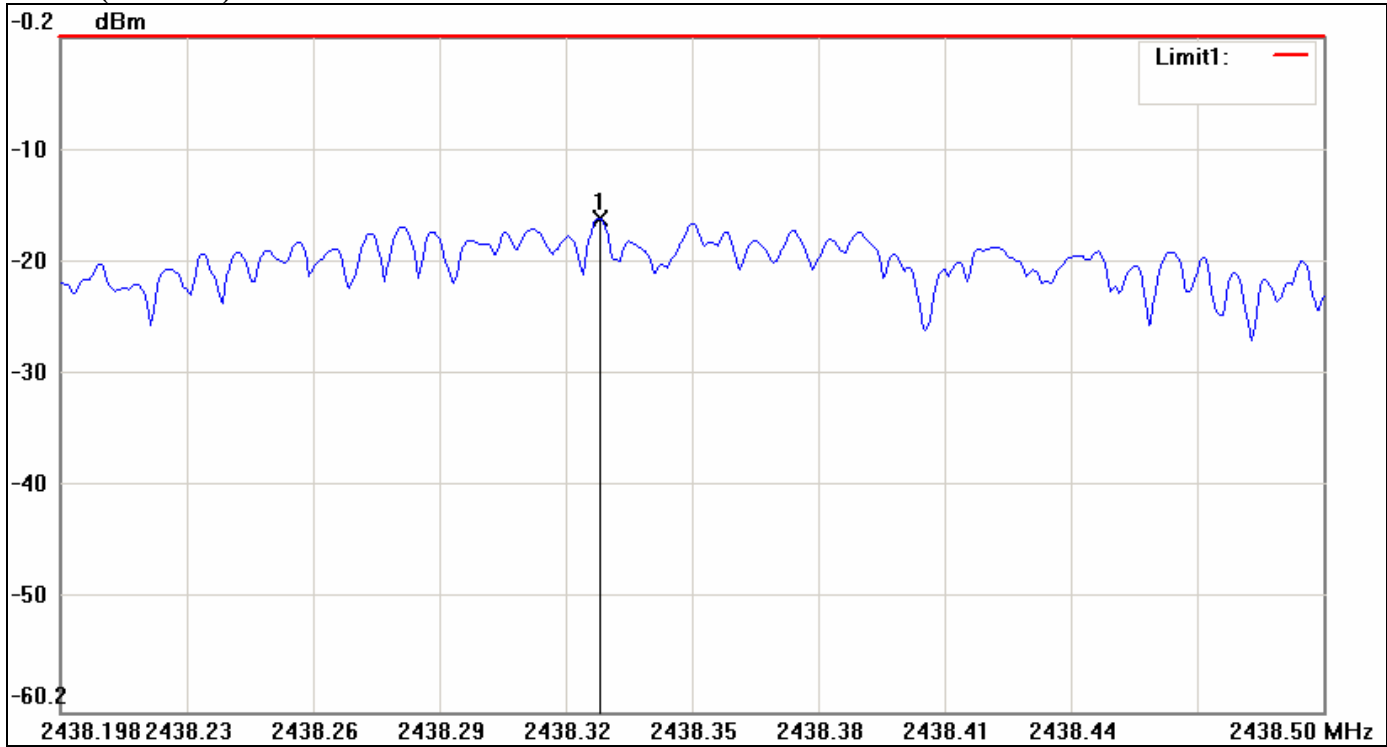

No.	Frequency(MHz)	Level(dBm)	Limit(dBm)	Margin(dBm)
1	2438.3260	-16.28	8.00	-24.28



PPSD (CH High)

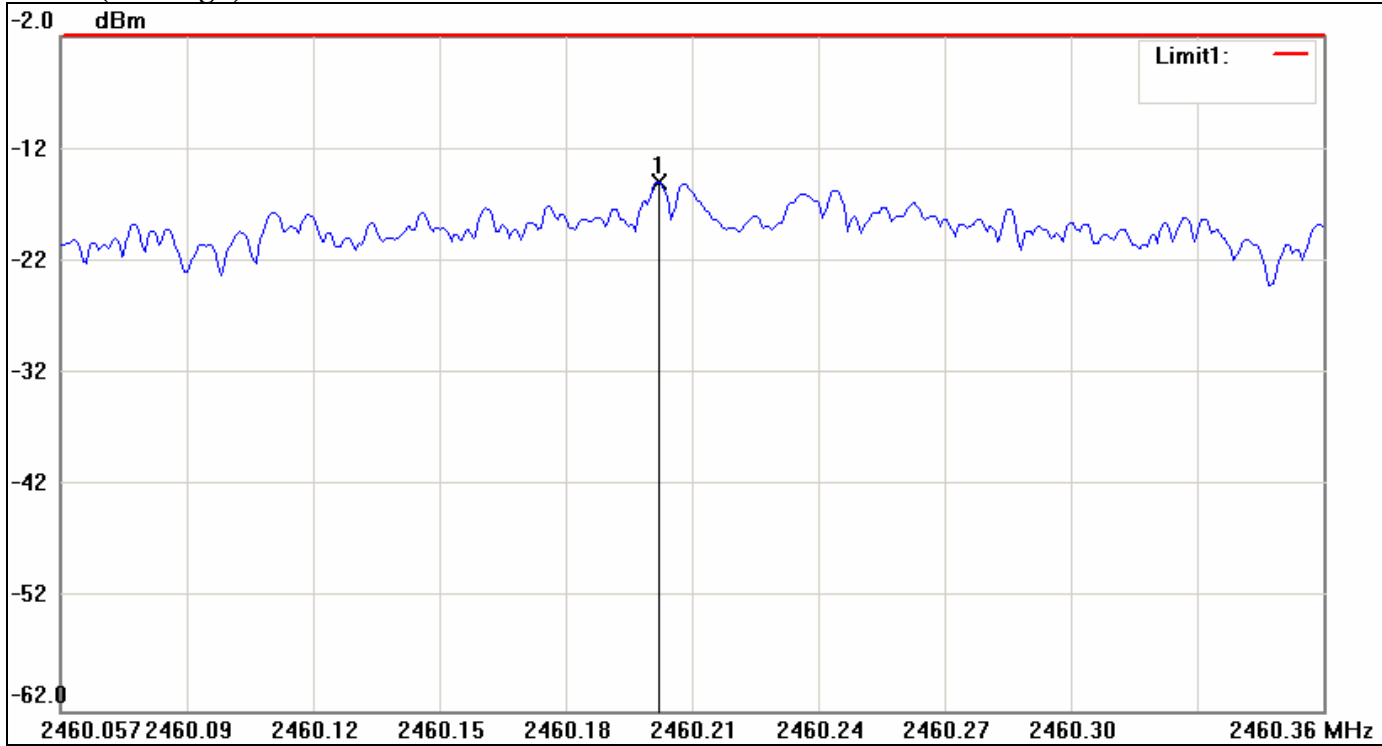

No.	Frequency(MHz)	Level(dBm)	Limit(dBm)	Margin(dBm)
1	2460.1990	-14.92	8.00	-22.92



IEEE 802.11n HT 40 MHz mode / Chain 0

PPSD (CH Low)

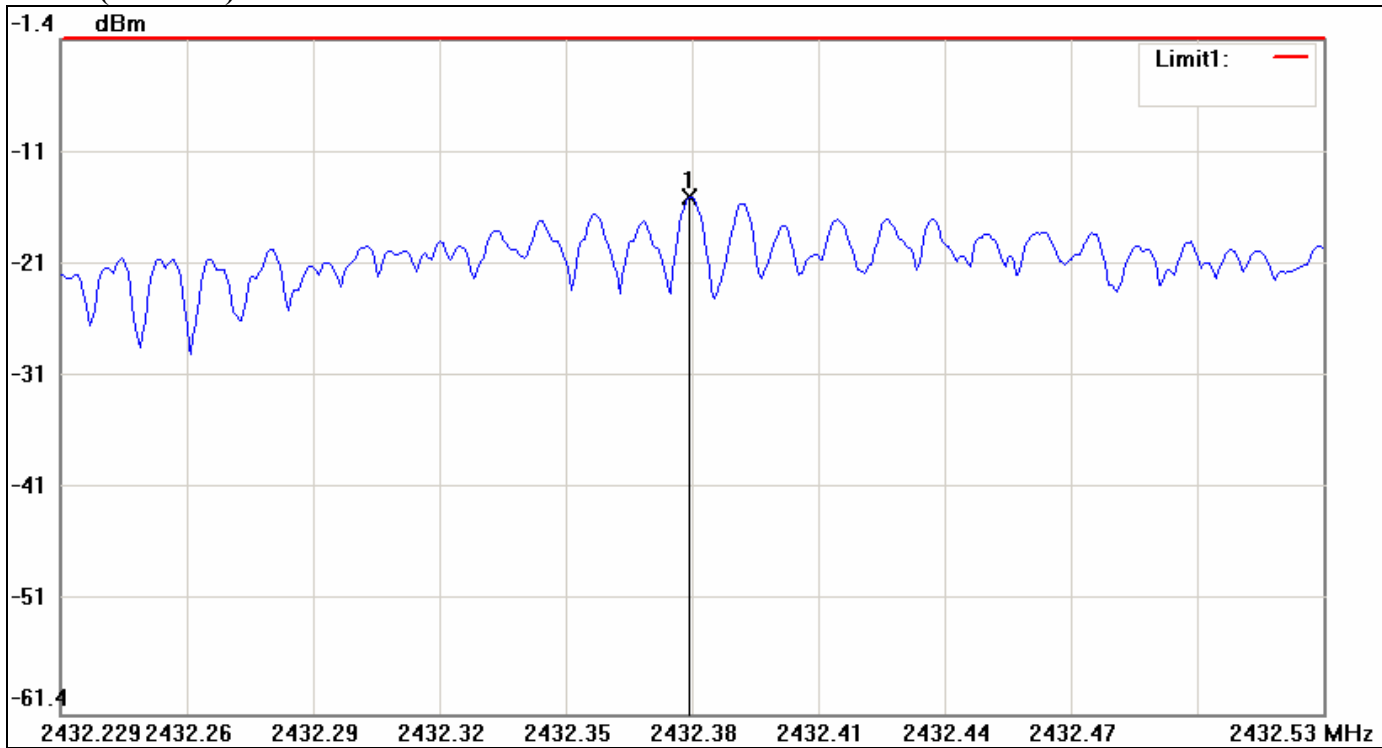

No.	Frequency(MHz)	Level(dBm)	Limit(dBm)	Margin(dBm)
1	2432.3782	-15.35	8.00	-23.35



PPSD (CH Mid)

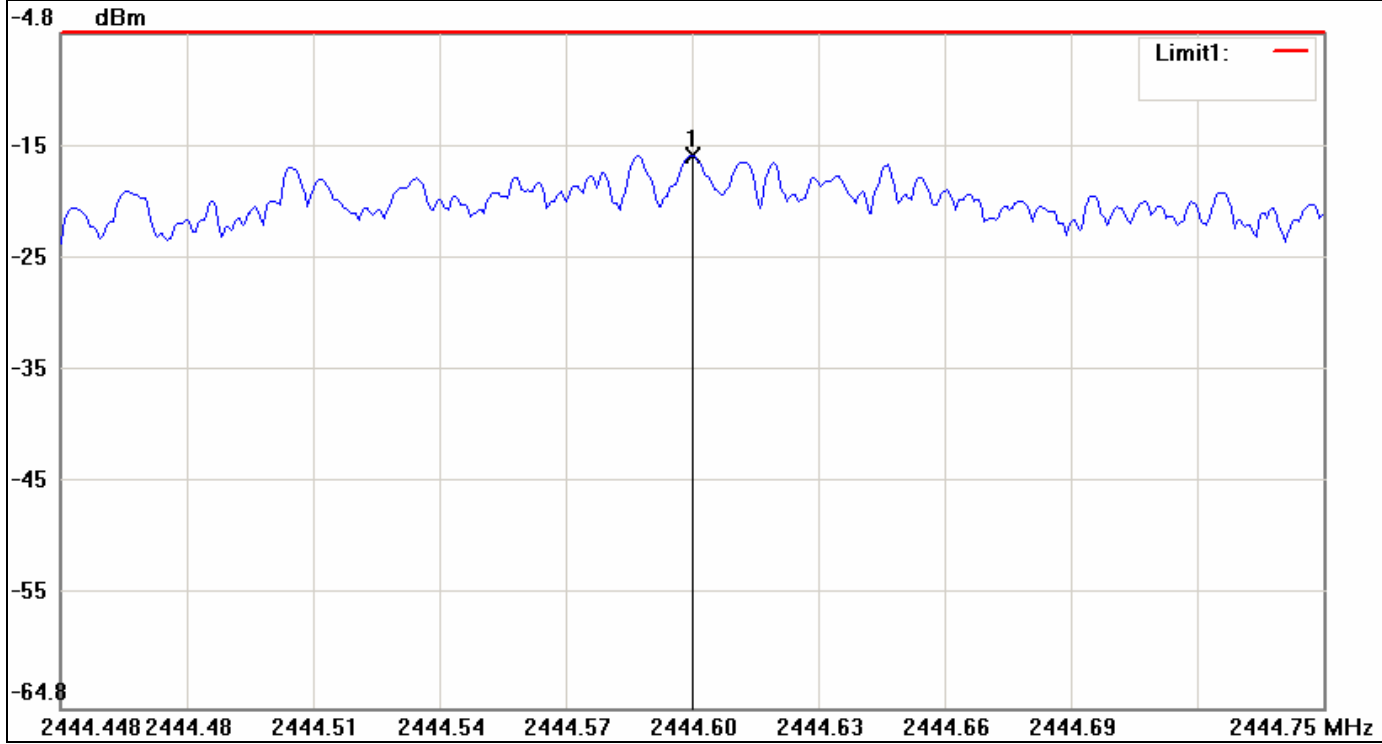

No.	Frequency(MHz)	Level(dBm)	Limit(dBm)	Margin(dBm)
1	2444.5983	-15.57	8.00	-23.57



PPSD (CH High)

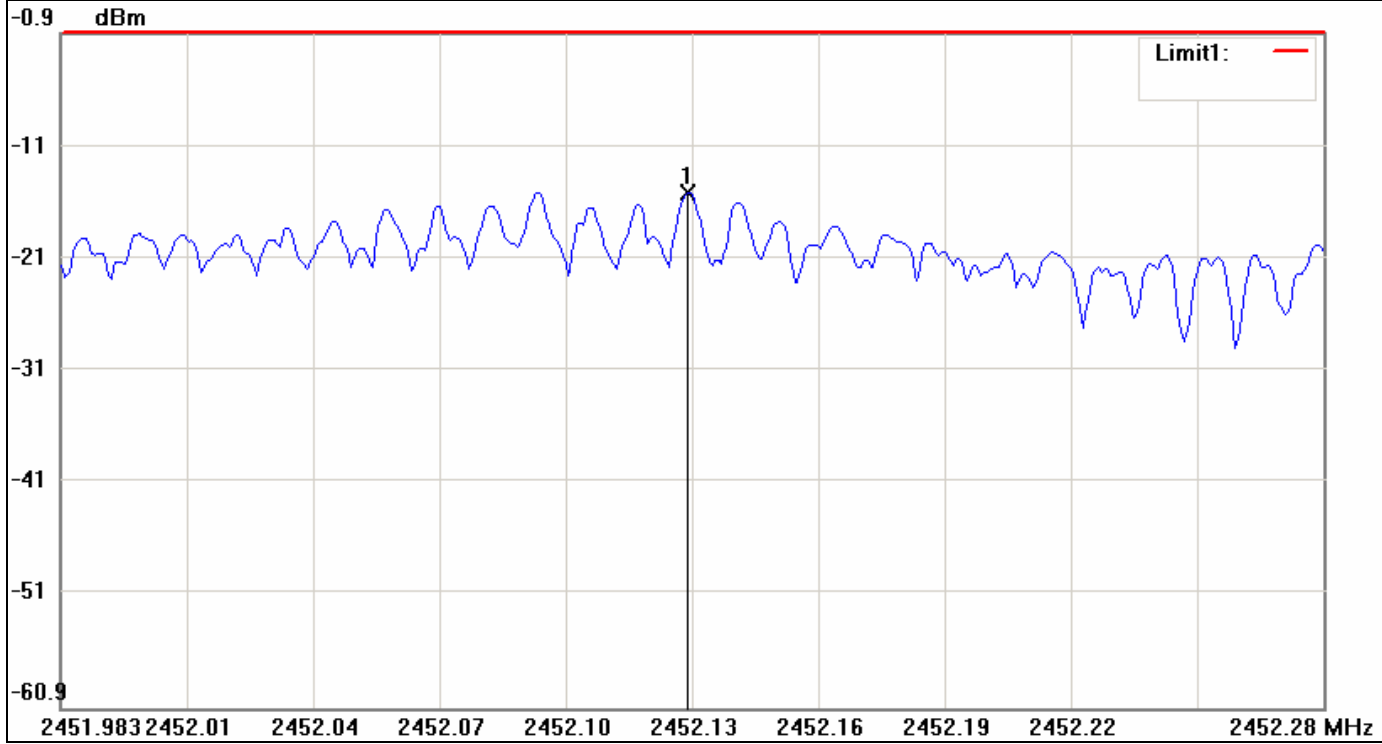

No.	Frequency(MHz)	Level(dBm)	Limit(dBm)	Margin(dBm)
1	2452.1319	-15.13	8.00	-23.13



IEEE 802.11n HT 40 MHz mode / Chain 1

PPSD (CH Low)

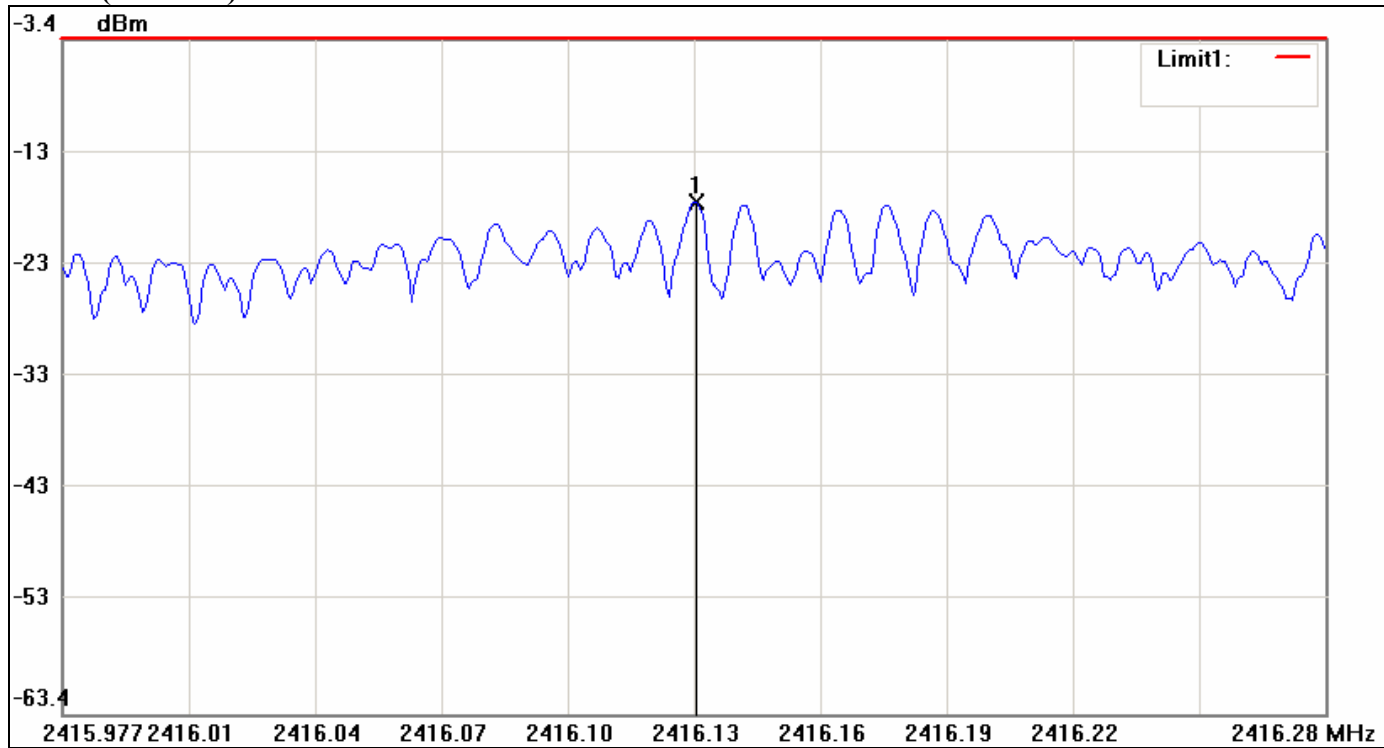

No.	Frequency(MHz)	Level(dBm)	Limit(dBm)	Margin(dBm)
1	2416.1275	-17.89	8.00	-25.89



PPSD (CH Mid)

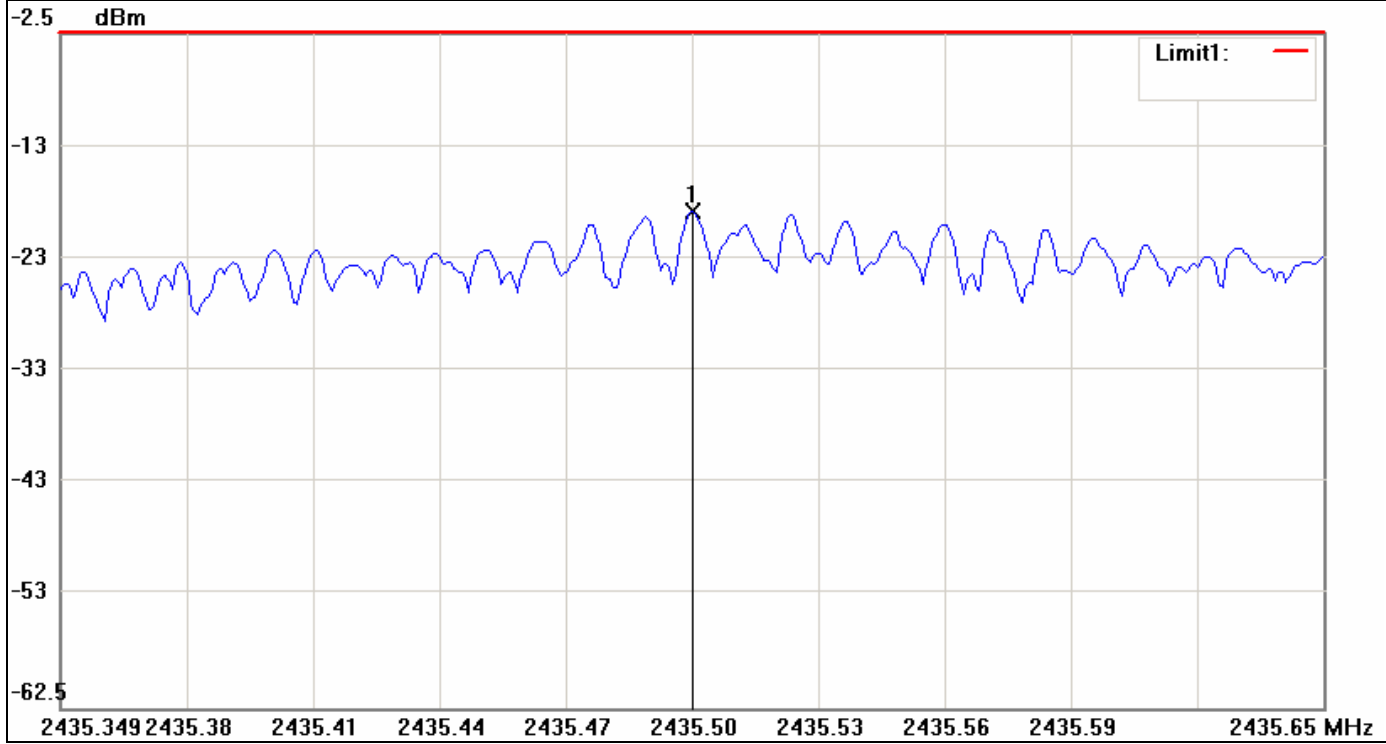

No.	Frequency(MHz)	Level(dBm)	Limit(dBm)	Margin(dBm)
1	2435.4987	-18.40	8.00	-26.40



PPSD (CH High)

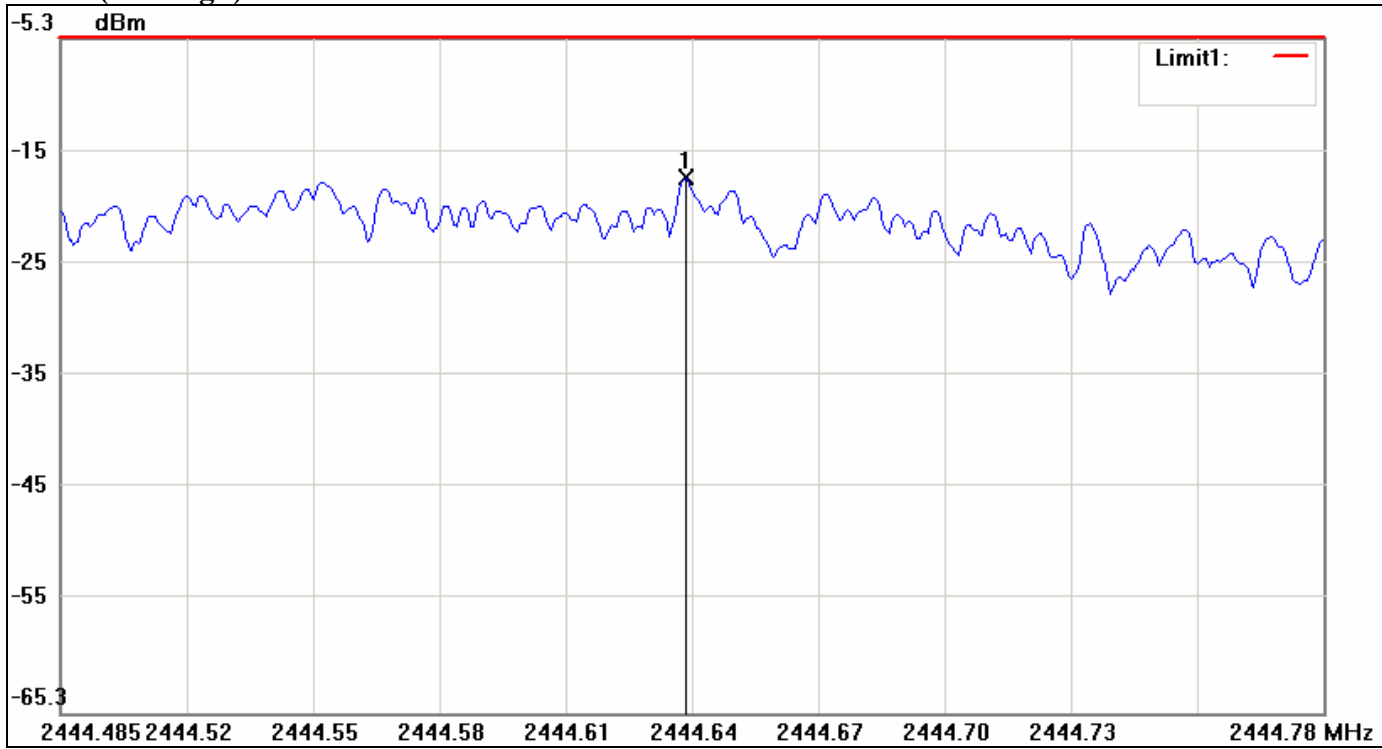

No.	Frequency(MHz)	Level(dBm)	Limit(dBm)	Margin(dBm)
1	2444.6335	-17.74	8.00	-25.74



7.6 SPURIOUS EMISSIONS

7.6.1 Conducted Measurement

LIMIT

According to §15.247(d), in any 100 kHz bandwidth outside the frequency bands in which the spread spectrum intentional radiator is operating, the radio frequency power that is produced by the intentional radiator shall be at least 20 dB below that in the 100 kHz bandwidth within the band that contains the highest level of the desired power, based on either an RF conducted or a radiated measurement, provided the transmitter demonstrates compliance with the peak conducted power limits. In addition, radiated emissions which fall in the restricted bands, as defined in §15.205(a), must also comply with the radiated emission limits specified in 15.209(a) (see Section 15.205(c)).

Test Configuration

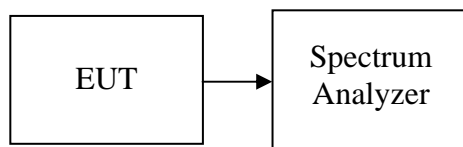

TEST PROCEDURE

Conducted RF measurements of the transmitter output were made to confirm that the EUT antenna port conducted emissions meet the specified limit and to identify any spurious signals that require further investigation or measurements on the radiated emissions site.

The transmitter output is connected to the spectrum analyzer. The resolution bandwidth is set to 100 kHz. The video bandwidth is set to 100 kHz.

Measurements are made over the 30MHz to 26GHz range with the transmitter set to the lowest, middle, and highest channels.

TEST RESULTS

No non-compliance noted



Test Plot

IEEE 802.11b mode

CH Low

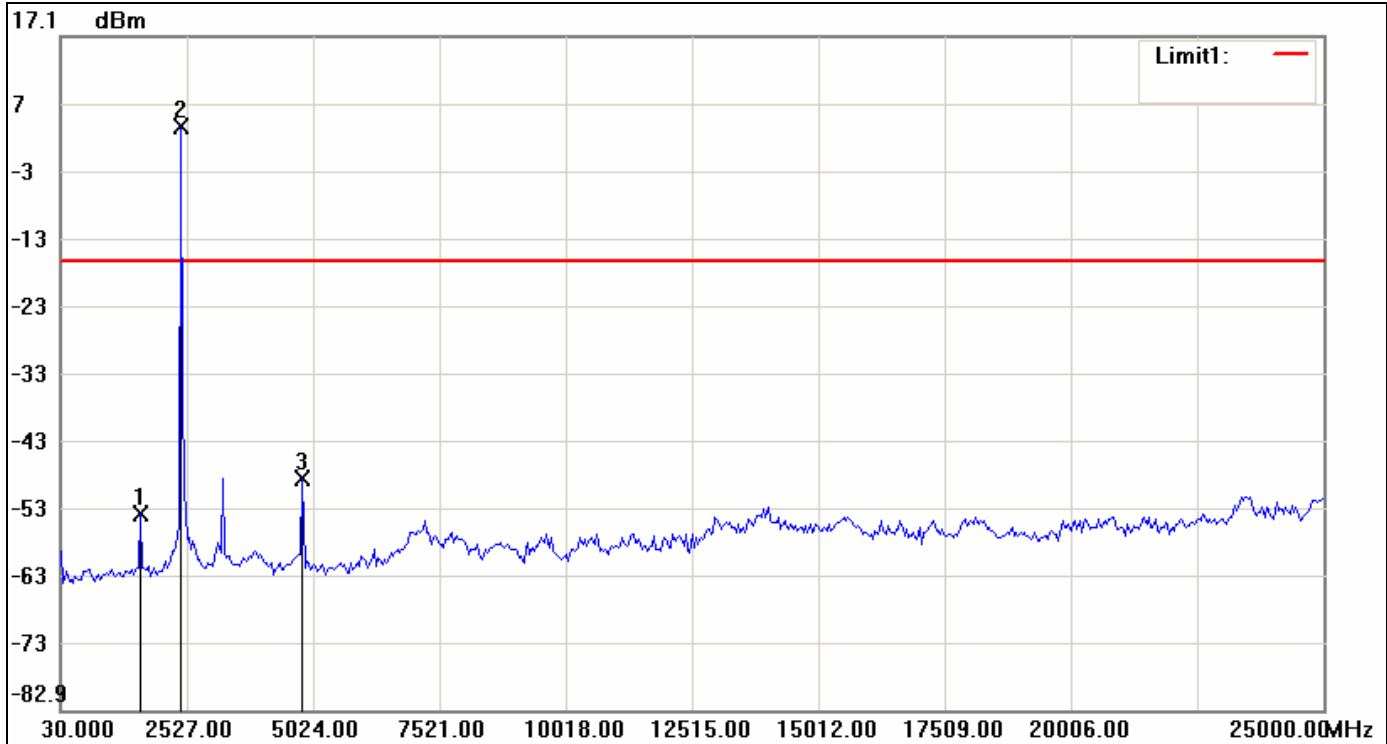

No.	Frequency(MHz)	Level(dBm)	Limit(dBm)	Margin(dBm)
1	1611.4333	-53.83	-16.27	-37.56
2	2402.1500	3.73	-16.27	20.00
3	4815.9167	-48.49	-16.27	-32.22



CH Mid

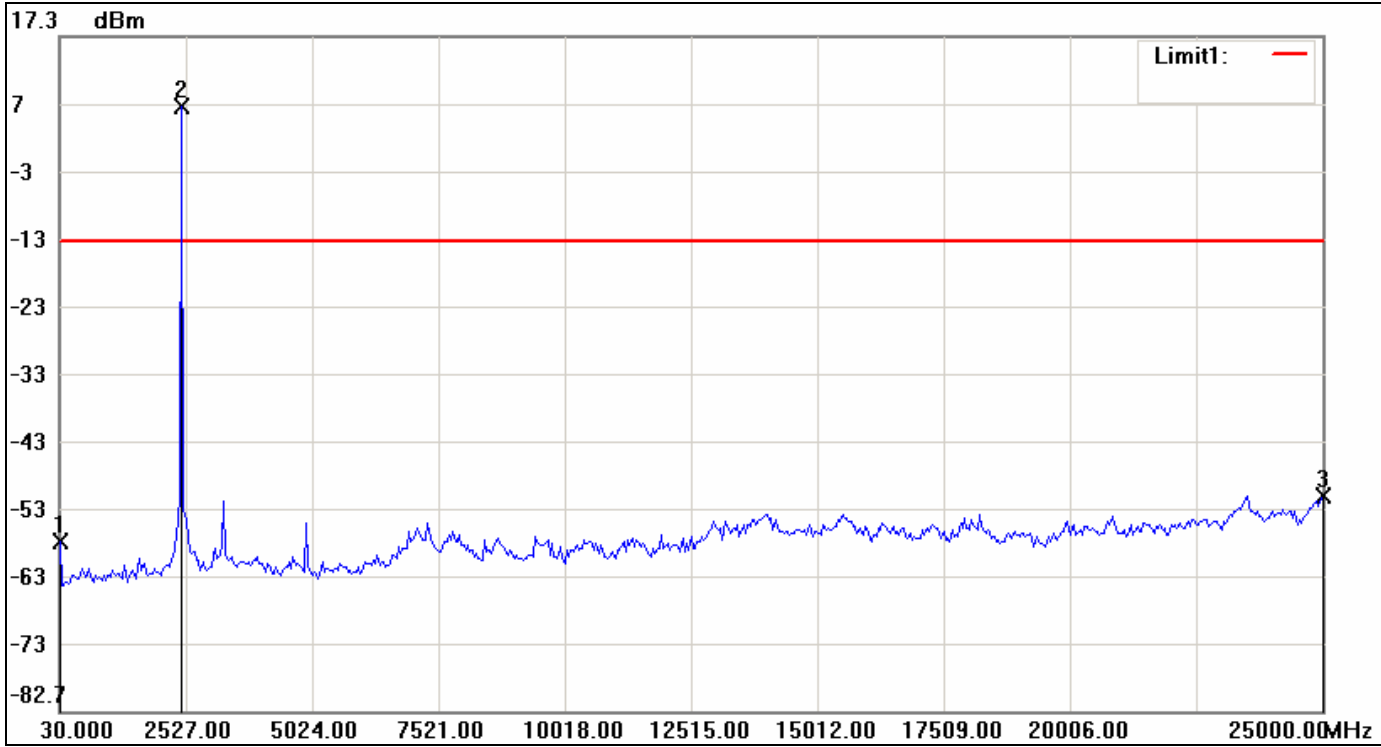

No.	Frequency(MHz)	Level(dBm)	Limit(dBm)	Margin(dBm)
1	30.0000	-57.51	-13.10	-44.41
2	2443.7667	6.90	-13.10	20.00
3	25000.0000	-50.83	-13.10	-37.73



CH High



No.	Frequency(MHz)	Level(dBm)	Limit(dBm)	Margin(dBm)
1	2235.6833	-60.15	-15.97	-44.18
2	2443.7667	4.03	-15.97	20.00
3	24875.1500	-50.34	-15.97	-34.37



IEEE 802.11g mode

CH Low

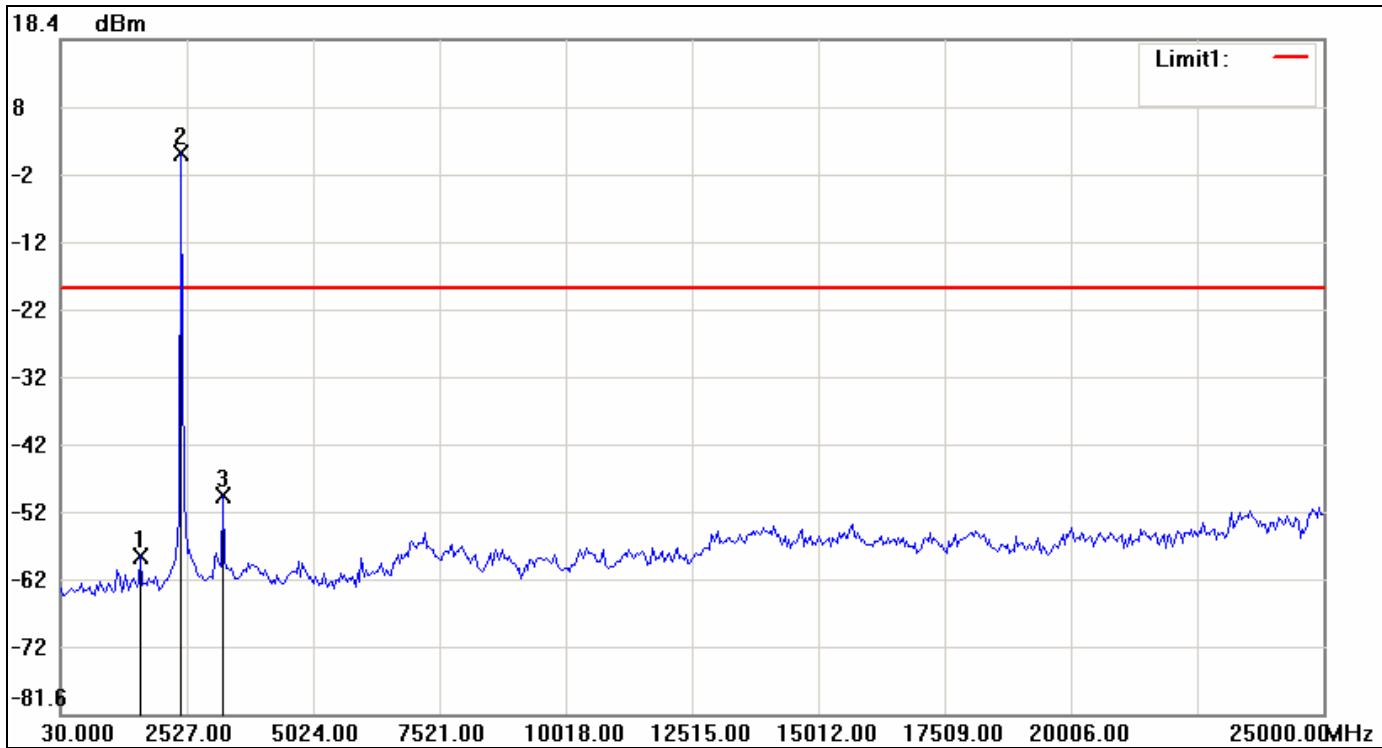

No.	Frequency(MHz)	Level(dBm)	Limit(dBm)	Margin(dBm)
1	1611.4333	-58.17	-18.46	-39.71
2	2402.1500	1.54	-18.46	20.00
3	3234.4833	-49.25	-18.46	-30.79



CH Mid

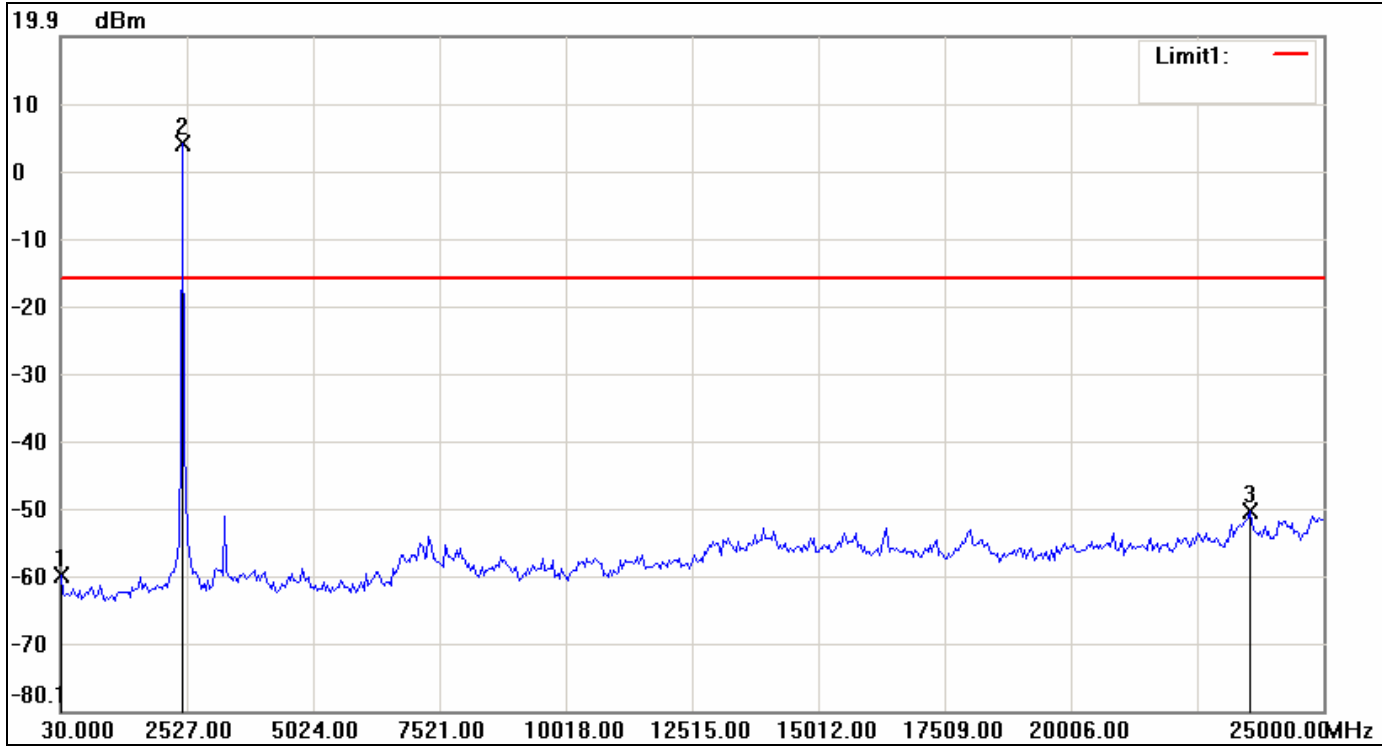

No.	Frequency(MHz)	Level(dBm)	Limit(dBm)	Margin(dBm)
1	30.0000	-60.04	-16.08	-43.96
2	2443.7667	3.92	-16.08	20.00
3	23543.4167	-50.51	-16.08	-34.43



CH High



No.	Frequency(MHz)	Level(dBm)	Limit(dBm)	Margin(dBm)
1	30.0000	-60.46	-17.28	-43.18
2	2443.7667	2.72	-17.28	20.00
3	24250.9000	-51.25	-17.28	-33.97



IEEE 802.11n HT 20 MHz mode / Chain 0

CH Low

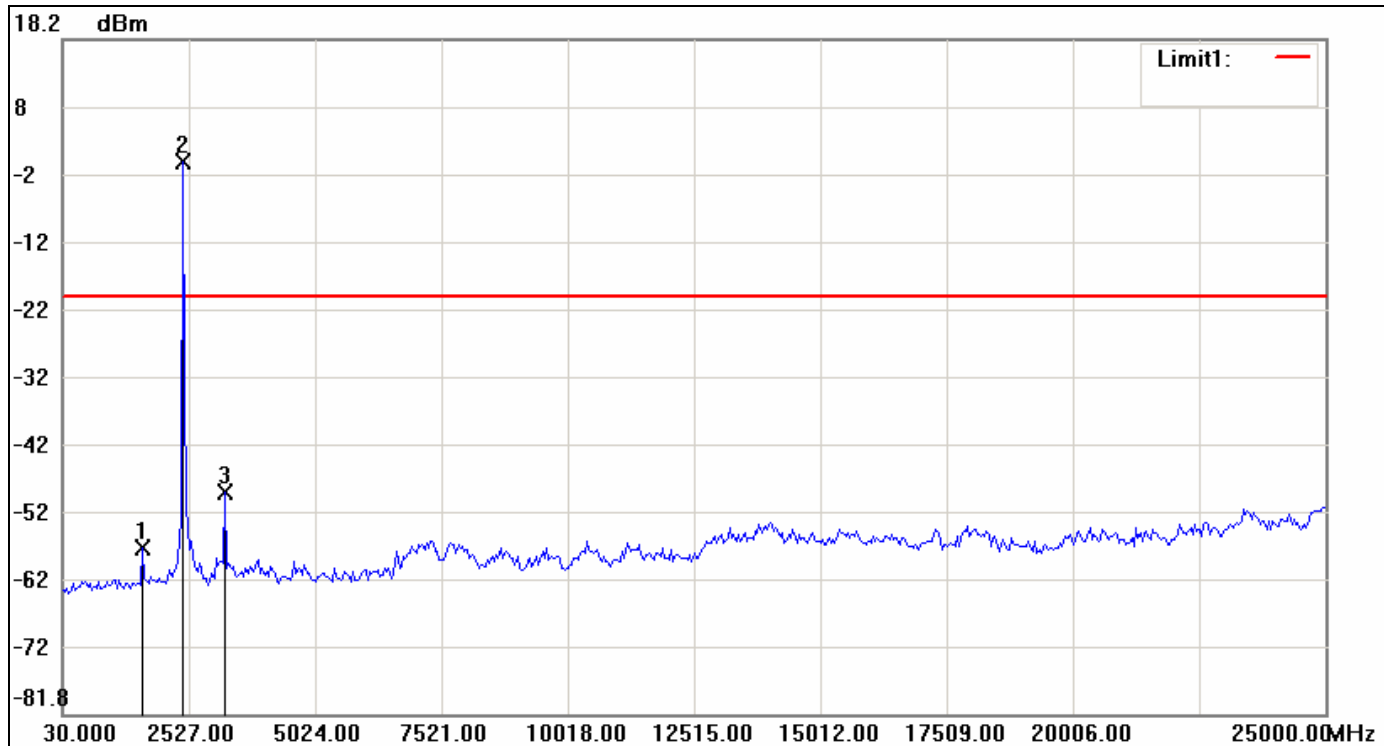

No.	Frequency(MHz)	Level(dBm)	Limit(dBm)	Margin(dBm)
1	1611.4333	-57.19	-19.96	-37.23
2	2402.1500	0.04	-19.96	20.00
3	3234.4833	-49.05	-19.96	-29.09



CH Mid



No.	Frequency(MHz)	Level(dBm)	Limit(dBm)	Margin(dBm)
1	1611.4333	-59.92	-19.86	-40.06
2	2443.7667	0.14	-19.86	20.00
3	23460.1833	-49.50	-19.86	-29.64



CH High



No.	Frequency(MHz)	Level(dBm)	Limit(dBm)	Margin(dBm)
1	1153.6500	-61.06	-18.61	-42.45
2	2443.7667	1.39	-18.61	20.00
3	24833.5333	-50.67	-18.61	-32.06



IEEE 802.11n HT 20 MHz mode / Chain 1

CH Low



No.	Frequency(MHz)	Level(dBm)	Limit(dBm)	Margin(dBm)
1	1569.8167	-61.37	-20.60	-40.77
2	2402.1500	-0.60	-20.60	20.00
3	24958.3833	-50.72	-20.60	-30.12



CH Mid

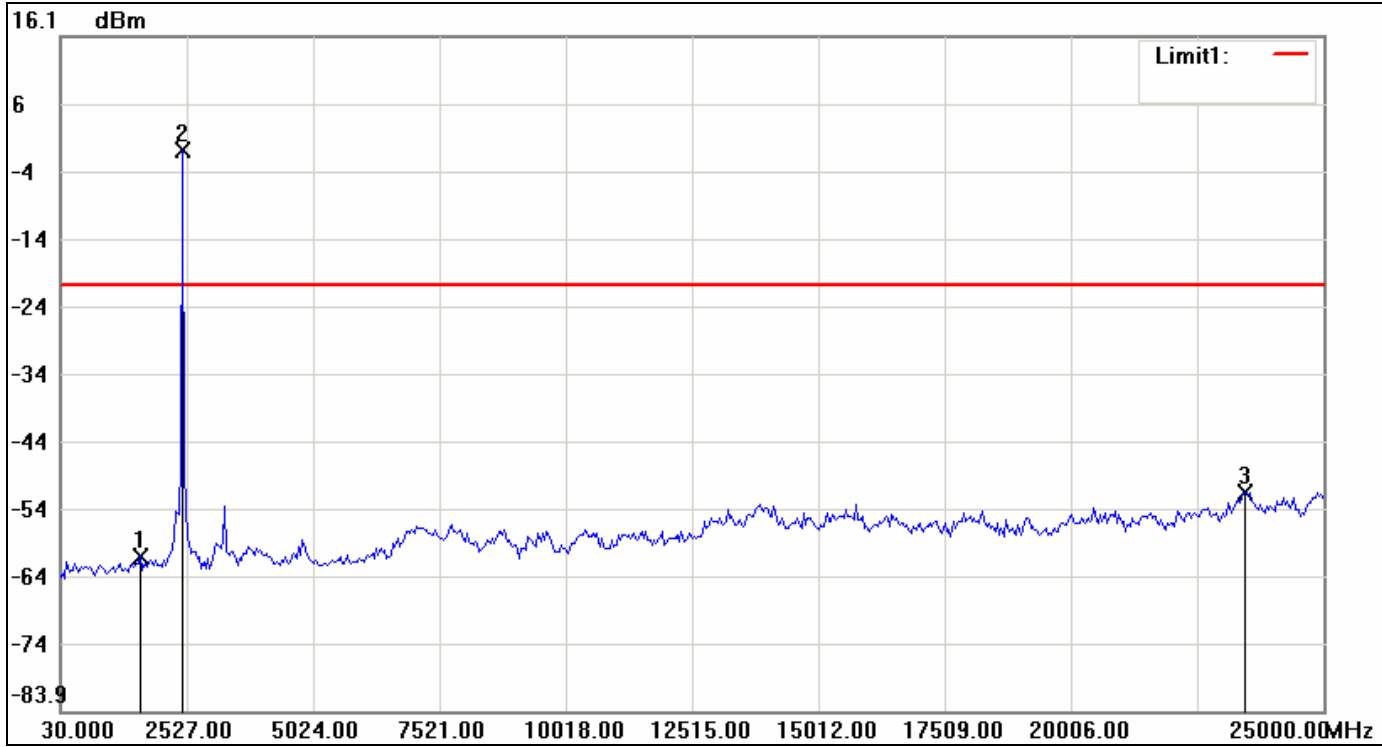

No.	Frequency(MHz)	Level(dBm)	Limit(dBm)	Margin(dBm)
1	1611.4333	-60.86	-20.63	-40.23
2	2443.7667	-0.63	-20.63	20.00
3	23460.1833	-51.39	-20.63	-30.76



CH High

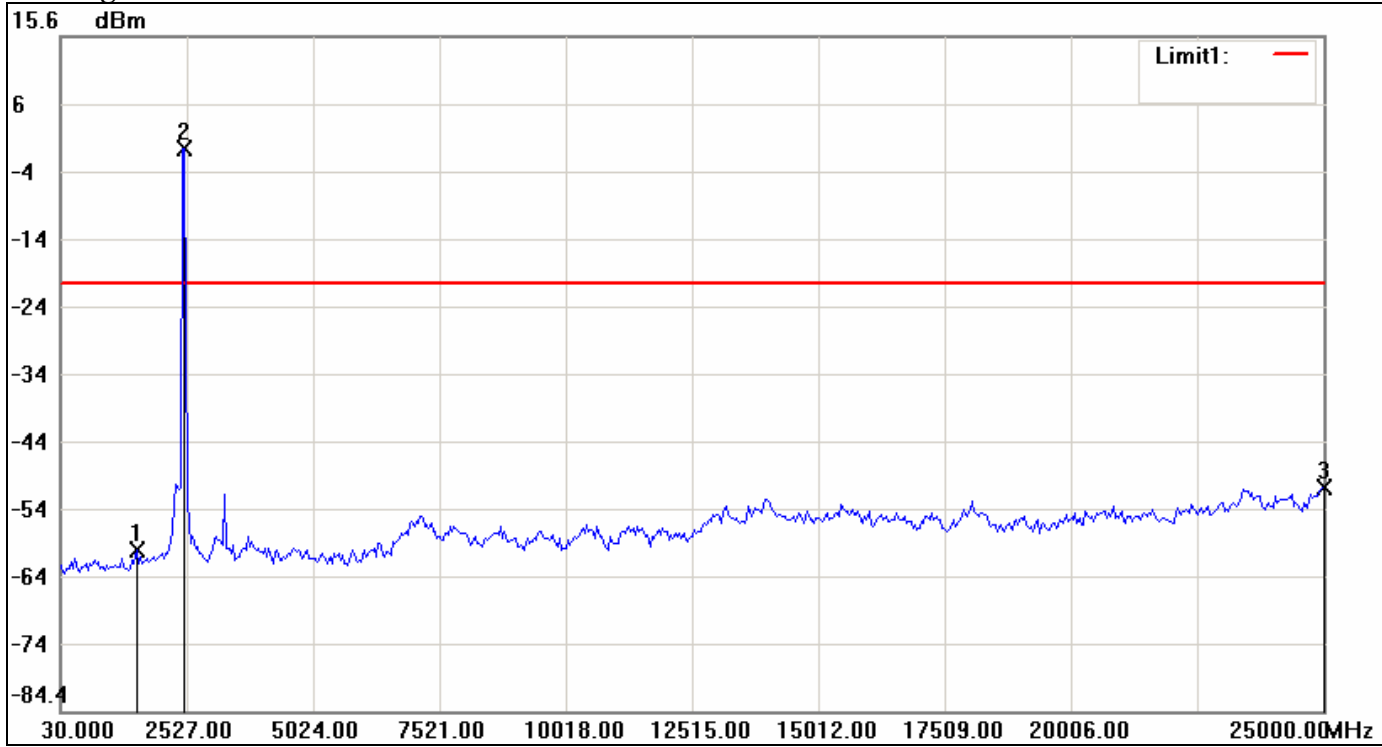

No.	Frequency(MHz)	Level(dBm)	Limit(dBm)	Margin(dBm)
1	1528.2000	-60.63	-20.96	-39.67
2	2485.3833	-0.96	-20.96	20.00
3	25000.0000	-51.19	-20.96	-30.23



IEEE 802.11n HT 40 MHz mode / Chain 0

CH Low

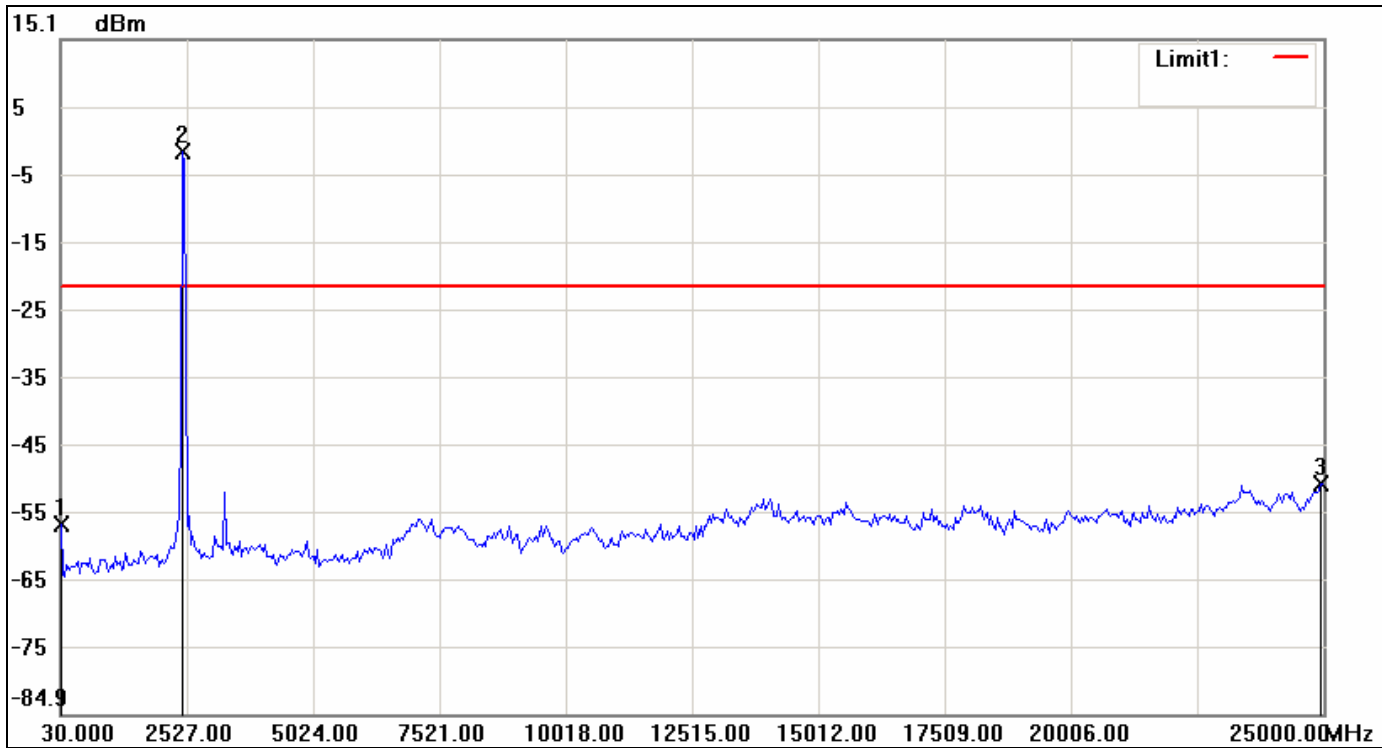

No.	Frequency(MHz)	Level(dBm)	Limit(dBm)	Margin(dBm)
1	30.0000	-56.83	-21.40	-35.43
2	2443.7667	-1.40	-21.40	20.00
3	24958.3833	-50.66	-21.40	-29.26



CH Mid

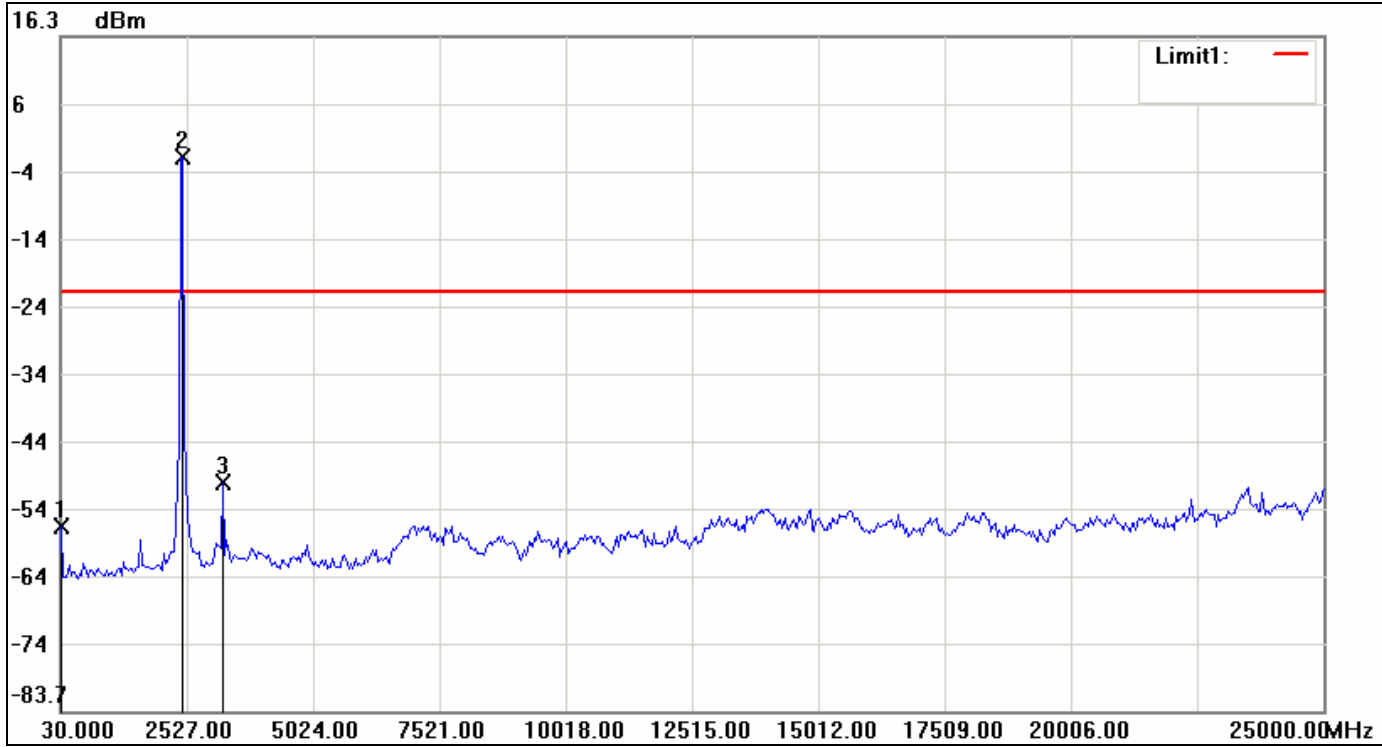

No.	Frequency(MHz)	Level(dBm)	Limit(dBm)	Margin(dBm)
1	30.0000	-56.24	-21.44	-34.80
2	2443.7667	-1.44	-21.44	20.00
3	3234.4833	-49.82	-21.44	-28.38



CH High

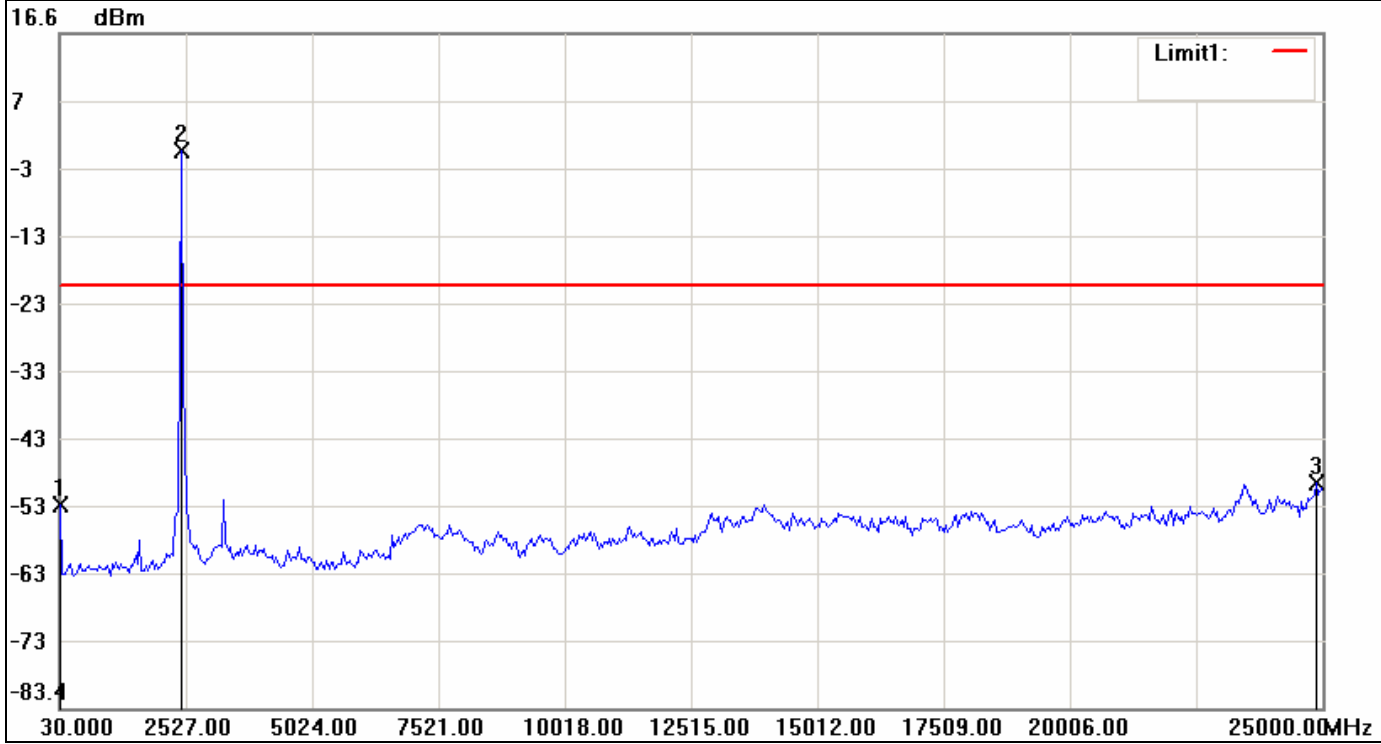

No.	Frequency(MHz)	Level(dBm)	Limit(dBm)	Margin(dBm)
1	30.0000	-53.34	-20.82	-32.52
2	2443.7667	-0.82	-20.82	20.00
3	24875.1500	-49.98	-20.82	-29.16



IEEE 802.11n HT 40 MHz mode / Chain 1

CH Low

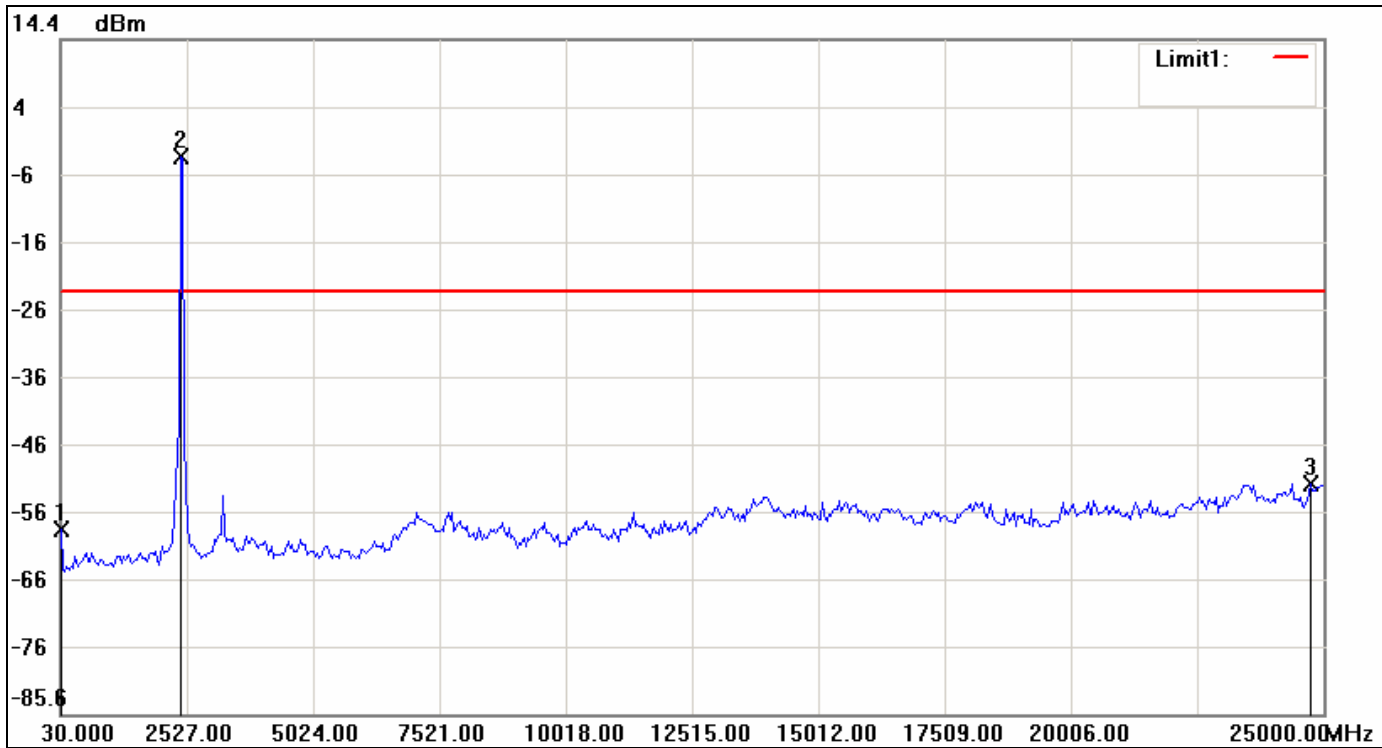

No.	Frequency(MHz)	Level(dBm)	Limit(dBm)	Margin(dBm)
1	30.0000	-58.13	-22.92	-35.21
2	2402.1500	-2.92	-22.92	20.00
3	24750.3000	-51.46	-22.92	-28.54



CH Mid



No.	Frequency(MHz)	Level(dBm)	Limit(dBm)	Margin(dBm)
1	30.0000	-60.39	-24.29	-36.10
2	2443.7667	-4.29	-24.29	20.00
3	24958.3833	-51.10	-24.29	-26.81



CH High



No.	Frequency(MHz)	Level(dBm)	Limit(dBm)	Margin(dBm)
1	30.0000	-56.61	-22.49	-34.12
2	2443.7667	-2.49	-22.49	20.00
3	25000.0000	-51.09	-22.49	-28.60



7.7 RADIATED EMISSIONS

LIMIT

1. According to §15.209(a), except as provided elsewhere in this Subpart, the emissions from an intentional radiator shall not exceed the field strength levels specified in the following table:

Frequency (MHz)	Field Strength ($\mu\text{V/m}$)	Measurement Distance (m)
30-88	100*	3
88-216	150*	3
216-960	200*	3
Above 960	500	3

Remark: Except as provided in paragraph (g), fundamental emissions from intentional radiators operating under this Section shall not be located in the frequency bands 54-72 MHz, 76-88 MHz, 174-216 MHz or 470-806 MHz. However, operation within these frequency bands is permitted under other sections of this Part, e.g., Sections 15.231 and 15.241.

2. In the emission table above, the tighter limit applies at the band edges.

Frequency (MHz)	Field Strength ($\mu\text{V/m}$ at 3-meter)	Field Strength (dB $\mu\text{V/m}$ at 3-meter)
30-88	100	40
88-216	150	43.5
216-960	200	46
Above 960	500	54



Test Configuration

9kHz ~ 30MHz

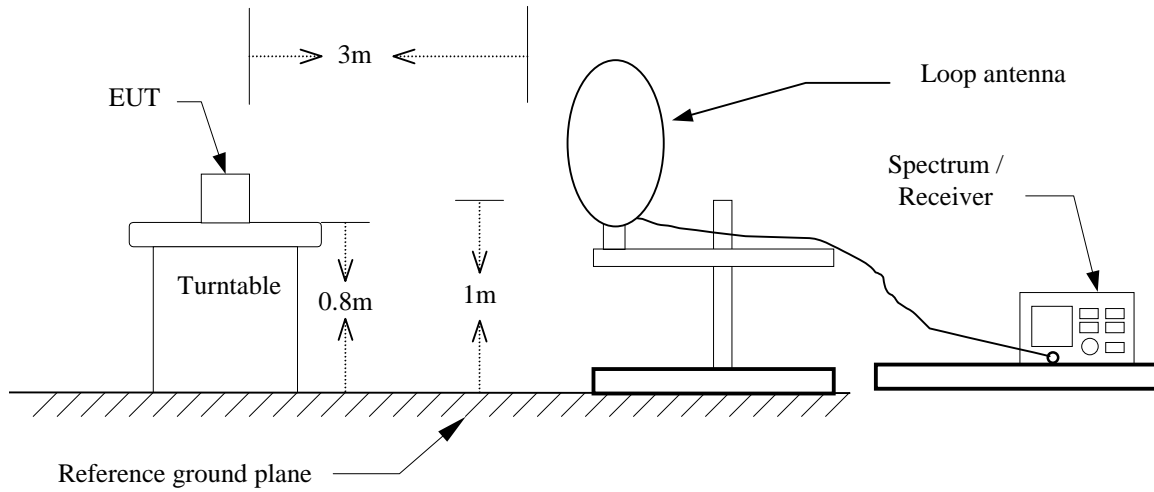

30MHz ~ 1GHz

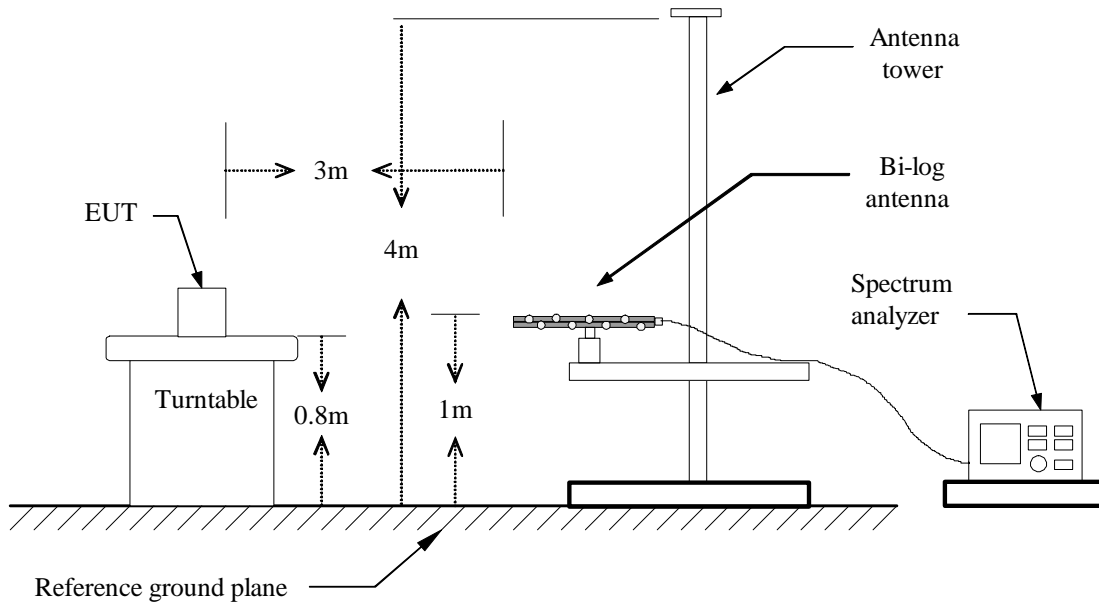



Above 1 GHz

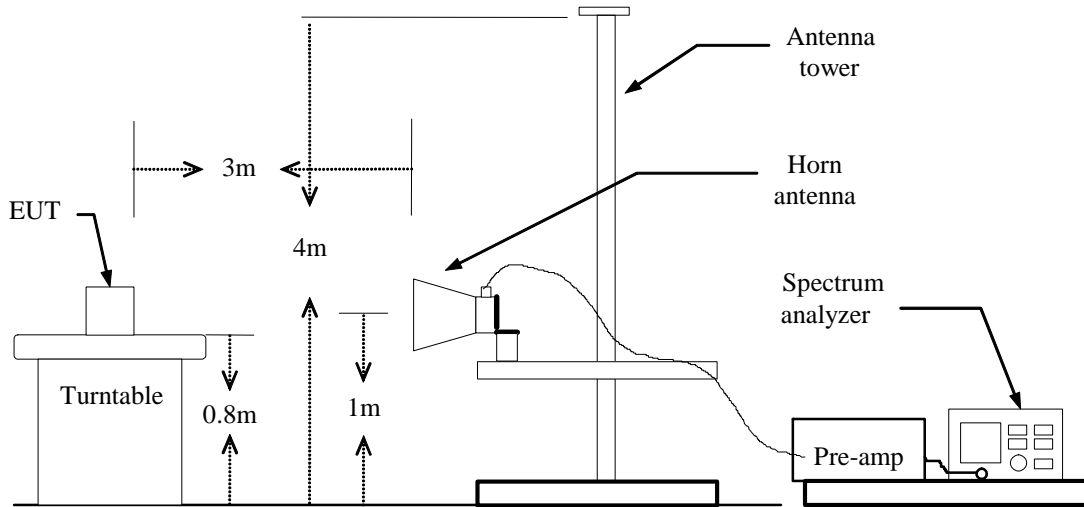



TEST PROCEDURE

1. The EUT is placed on a turntable, which is 0.8m above ground plane.
2. The turntable shall be rotated for 360 degrees to determine the position of maximum emission level.
3. EUT is set 3m away from the receiving antenna, which is varied from 1m to 4m to find out the highest emissions.
4. Maximum procedure was performed on the six highest emissions to ensure EUT compliance.
5. And also, each emission was to be maximized by changing the polarization of receiving antenna both horizontal and vertical.
6. Set the spectrum analyzer in the following setting as:
Below 1GHz:
RBW=100kHz / VBW=300kHz / Sweep=AUTO
Above 1GHz:
(a) PEAK: RBW=VBW=1MHz / Sweep=AUTO
(b) AVERAGE: RBW=1MHz / VBW=10Hz / Sweep=AUTO
7. Repeat above procedures until the measurements for all frequencies are complete.



TEST RESULTS

Below 1GHz

Operation Mode: Normal Link

Test Date: June 2, 2011

Temperature: 24°C

Tested by: Ali Shu

Humidity: 52% RH

Polarity: Ver. / Hor.

Frequency (MHz)	Reading (dBuV)	Correction Factor (dB/m)	Result (dBuV/m)	Limit (dBuV/m)	Margin (dB)	Remark	Ant. Pol. (H/V)
51.02	47.05	-15.07	31.98	40.00	-8.02	Peak	V
148.02	41.56	-10.16	31.40	43.50	-12.10	Peak	V
303.22	41.40	-9.16	32.24	46.00	-13.76	Peak	V
414.77	37.22	-6.73	30.49	46.00	-15.51	Peak	V
624.93	33.36	-3.48	29.88	46.00	-16.12	Peak	V
749.42	32.45	-1.83	30.62	46.00	-15.38	Peak	V
183.58	40.13	-11.32	28.80	43.50	-14.70	Peak	H
303.22	50.90	-9.16	41.74	46.00	-4.26	Peak	H
414.77	41.94	-6.73	35.21	46.00	-10.79	Peak	H
624.93	37.01	-3.48	33.53	46.00	-12.47	Peak	H
749.42	40.74	-1.83	38.91	46.00	-7.09	Peak	H
875.52	38.79	-0.73	38.05	46.00	-7.95	Peak	H

Remark:

1. No emission found between lowest internal used/generated frequency to 30MHz (9kHz~30MHz)
2. Radiated emissions measured in frequency range from 30 MHz to 1000MHz were made with an instrument using peak/quasi-peak detector mode.
3. Quasi-peak test would be performed if the peak result were greater than the quasi-peak limit or as required by the applicant.
4. Measurements above show only up to 6 maximum emissions noted, or would be lesser, with " N/A " remark, if no specific emissions from the EUT are recorded (ie: margin>20dB from the applicable limit) and considered that's already beyond the background noise floor.
5. $Margin (dB) = Result (dBuV/m) - Limit (dBuV/m)$.



Above 1 GHz

Operation Mode: TX / IEEE 802.11b / CH Low

Test Date: June 2, 2011

Temperature: 20°C

Tested by: Ali Shu

Humidity: 52% RH

Polarity: Ver. / Hor.

Frequency (MHz)	Reading (Peak) (dBuV)	Reading (Average) (dBuV)	Correction Factor (dB/m)	Result (Peak) (dBuV/m)	Result (Average) (dBuV/m)	Limit (Peak) (dBuV/m)	Limit (Average) (dBuV/m)	Margin (dB)	Remark	Ant. Pol. (H/V)
1496.67	57.18	---	-10.55	46.63	---	74.00	54.00	-7.37	Peak	V
3216.67	51.73	---	-1.60	50.13	---	74.00	54.00	-3.87	Peak	V
4825.00	51.56	49.13	2.61	54.17	51.74	74.00	54.00	-2.26	AVG	V
7233.33	46.82	41.85	7.26	54.09	49.11	74.00	54.00	-4.89	AVG	V
N/A										
1486.67	57.88	---	-10.56	47.32	---	74.00	54.00	-6.68	Peak	H
3216.67	55.18	53.32	-1.60	53.58	51.72	74.00	54.00	-2.28	AVG	H
4825.00	54.95	50.27	2.61	57.56	52.88	74.00	54.00	-1.12	AVG	H
7233.33	46.92	38.71	7.26	54.18	45.97	74.00	54.00	-8.03	AVG	H
N/A										

Remark:

1. Measuring frequencies from 1 GHz to the 10th harmonic of highest fundamental frequency.
2. Radiated emissions measured in frequency above 1000MHz were made with an instrument using peak/average detector mode.
3. Average test would be performed if the peak result were greater than the average limit or as required by the applicant.
4. Data of measurement within this frequency range shown " --- " in the table above means the reading of emissions are attenuated more than 20dB below the permissible limits or the field strength is too small to be measured.
5. Measurements above show only up to 6 maximum emissions noted, or would be lesser, with " N/A " remark, if no specific emissions from the EUT are recorded (ie: margin>20dB from the applicable limit) and considered that's already beyond the background noise floor.
6. Margin (dB) = Remark result (dBuV/m) – Average limit (dBuV/m).



Operation Mode: TX / IEEE 802.11b / CH Mid

Test Date: June 2, 2011

Temperature: 24°C

Tested by: Ali Shu

Humidity: 52% RH

Polarity: Ver. / Hor.

Frequency (MHz)	Reading (Peak) (dBuV)	Reading (Average) (dBuV)	Correction Factor (dB/m)	Result (Peak) (dBuV/m)	Result (Average) (dBuV/m)	Limit (Peak) (dBuV/m)	Limit (Average) (dBuV/m)	Margin (dB)	Remark	Ant. Pol. (H/V)
1680.00	57.32	---	-8.72	48.60	---	74.00	54.00	-5.40	Peak	V
4883.33	53.21	47.80	2.73	55.94	50.53	74.00	54.00	-3.47	AVG	V
7325.00	49.64	44.62	7.23	56.87	51.85	74.00	54.00	-2.15	AVG	V
N/A										
1526.67	57.97	---	-10.28	47.69	---	74.00	54.00	-6.31	Peak	H
2500.00	58.35	51.52	-3.87	54.48	47.65	74.00	54.00	-6.35	AVG	H
3258.33	51.41	---	-1.49	49.93	---	74.00	54.00	-4.07	Peak	H
4883.33	49.89	45.88	2.73	52.62	48.61	74.00	54.00	-5.39	AVG	H
N/A										

Remark:

1. Measuring frequencies from 1 GHz to the 10th harmonic of highest fundamental frequency.
2. Radiated emissions measured in frequency above 1000MHz were made with an instrument using peak/average detector mode.
3. Average test would be performed if the peak result were greater than the average limit or as required by the applicant.
4. Data of measurement within this frequency range shown " --- " in the table above means the reading of emissions are attenuated more than 20dB below the permissible limits or the field strength is too small to be measured.
5. Measurements above show only up to 6 maximum emissions noted, or would be lesser, with " N/A " remark, if no specific emissions from the EUT are recorded (ie: margin > 20dB from the applicable limit) and considered that's already beyond the background noise floor.
6. Margin (dB) = Remark result (dBuV/m) – Average limit (dBuV/m).



Operation Mode: TX / IEEE 802.11b / CH High

Test Date: June 2, 2011

Temperature: 24°C

Tested by: Ali Shu

Humidity: 52% RH

Polarity: Ver. / Hor.

Frequency (MHz)	Reading (Peak) (dBuV)	Reading (Average) (dBuV)	Correction Factor (dB/m)	Result (Peak) (dBuV/m)	Result (Average) (dBuV/m)	Limit (Peak) (dBuV/m)	Limit (Average) (dBuV/m)	Margin (dB)	Remark	Ant. Pol. (H/V)
1673.33	56.90	---	-8.79	48.11	---	74.00	54.00	-5.89	Peak	V
4925.00	53.41	49.47	2.81	56.22	52.28	74.00	54.00	-1.72	AVG	V
7391.67	49.12	37.97	7.20	56.32	45.17	74.00	54.00	-8.83	AVG	V
N/A										
1726.67	57.02	---	-8.25	48.77	---	74.00	54.00	-5.23	Peak	H
4925.00	51.74	47.41	2.81	54.55	50.22	74.00	54.00	-3.78	AVG	H
7383.33	47.95	40.85	7.20	55.16	48.05	74.00	54.00	-5.95	AVG	H
N/A										

Remark:

1. Measuring frequencies from 1 GHz to the 10th harmonic of highest fundamental frequency.
2. Radiated emissions measured in frequency above 1000MHz were made with an instrument using peak/average detector mode.
3. Average test would be performed if the peak result were greater than the average limit or as required by the applicant.
4. Data of measurement within this frequency range shown “ --- ” in the table above means the reading of emissions are attenuated more than 20dB below the permissible limits or the field strength is too small to be measured.
5. Measurements above show only up to 6 maximum emissions noted, or would be lesser, with “ N/A ” remark, if no specific emissions from the EUT are recorded (ie: margin>20dB from the applicable limit) and considered that's already beyond the background noise floor.
6. Margin (dB) = Remark result (dBuV/m) – Average limit (dBuV/m).



Operation Mode: TX / IEEE 802.11g / CH Low

Test Date: June 2, 2011

Temperature: 24°C

Tested by: Ali Shu

Humidity: 52% RH

Polarity: Ver. / Hor.

Frequency (MHz)	Reading (Peak) (dBuV)	Reading (Average) (dBuV)	Correction Factor (dB/m)	Result (Peak) (dBuV/m)	Result (Average) (dBuV/m)	Limit (Peak) (dBuV/m)	Limit (Average) (dBuV/m)	Margin (dB)	Remark	Ant. Pol. (H/V)
1466.67	57.61	---	-10.58	47.03	---	74.00	54.00	-6.97	Peak	V
2360.00	59.20	51.34	-4.44	54.75	46.90	74.00	54.00	-7.10	AVG	V
2806.67	57.23	42.63	-2.83	54.40	39.80	74.00	54.00	-14.20	AVG	V
3216.67	50.97	---	-1.60	49.37	---	74.00	54.00	-4.63	Peak	V
4816.67	50.69	40.45	2.59	53.28	43.04	74.00	54.00	-10.96	AVG	V
7225.00	51.64	42.39	7.26	58.91	49.65	74.00	54.00	-4.35	AVG	V
2463.33	62.46	54.42	-4.02	58.44	50.40	74.00	54.00	-3.60	AVG	H
3216.67	55.88	52.99	-1.60	54.29	51.39	74.00	54.00	-2.61	AVG	H
4816.67	50.53	41.24	2.59	53.13	43.83	74.00	54.00	-10.17	AVG	H
7241.67	47.03	36.53	7.26	54.28	43.79	74.00	54.00	-10.21	AVG	H
N/A										

Remark:

1. Measuring frequencies from 1 GHz to the 10th harmonic of highest fundamental frequency.
2. Radiated emissions measured in frequency above 1000MHz were made with an instrument using peak/average detector mode.
3. Average test would be performed if the peak result were greater than the average limit or as required by the applicant.
4. Data of measurement within this frequency range shown " --- " in the table above means the reading of emissions are attenuated more than 20dB below the permissible limits or the field strength is too small to be measured.
5. Measurements above show only up to 6 maximum emissions noted, or would be lesser, with " N/A " remark, if no specific emissions from the EUT are recorded (ie: margin > 20dB from the applicable limit) and considered that's already beyond the background noise floor.
6. Margin (dB) = Remark result (dBuV/m) – Average limit (dBuV/m).



Operation Mode: TX / IEEE 802.11g / CH Mid

Test Date: June 2, 2011

Temperature: 24°C

Tested by: Ali Shu

Humidity: 52% RH

Polarity: Ver. / Hor.

Frequency (MHz)	Reading (Peak) (dBuV)	Reading (Average) (dBuV)	Correction Factor (dB/m)	Result (Peak) (dBuV/m)	Result (Average) (dBuV/m)	Limit (Peak) (dBuV/m)	Limit (Average) (dBuV/m)	Margin (dB)	Remark	Ant. Pol. (H/V)
1070.00	59.55	---	-11.00	48.55	---	74.00	54.00	-5.45	Peak	V
2390.00	61.00	53.54	-4.32	56.68	49.22	74.00	54.00	-4.78	AVG	V
2496.67	58.39	53.87	-3.88	54.51	49.99	74.00	54.00	-4.01	AVG	V
4883.33	51.05	42.53	2.73	53.77	45.26	74.00	54.00	-8.74	AVG	V
7325.00	56.79	45.42	7.23	64.02	52.65	74.00	54.00	-1.35	AVG	V
N/A										
1463.33	57.76	---	-10.59	47.17	---	74.00	54.00	-6.83	Peak	H
2496.67	63.17	55.07	-3.88	59.29	51.19	74.00	54.00	-2.81	AVG	H
3258.33	51.65	---	-1.49	50.16	---	74.00	54.00	-3.84	Peak	H
4891.67	48.93	---	2.74	51.67	---	74.00	54.00	-2.33	Peak	H
7325.00	54.12	41.23	7.23	61.35	48.46	74.00	54.00	-5.54	AVG	H
N/A										

Remark:

1. Measuring frequencies from 1 GHz to the 10th harmonic of highest fundamental frequency.
2. Radiated emissions measured in frequency above 1000MHz were made with an instrument using peak/average detector mode.
3. Average test would be performed if the peak result were greater than the average limit or as required by the applicant.
4. Data of measurement within this frequency range shown " --- " in the table above means the reading of emissions are attenuated more than 20dB below the permissible limits or the field strength is too small to be measured.
5. Measurements above show only up to 6 maximum emissions noted, or would be lesser, with " N/A " remark, if no specific emissions from the EUT are recorded (ie: margin > 20dB from the applicable limit) and considered that's already beyond the background noise floor.
6. Margin (dB) = Remark result (dBuV/m) – Average limit (dBuV/m).



Operation Mode: TX / IEEE 802.11g / CH High

Test Date: June 2, 2011

Temperature: 24°C

Tested by: Ali Shu

Humidity: 52% RH

Polarity: Ver. / Hor.

Frequency (MHz)	Reading (Peak) (dBuV)	Reading (Average) (dBuV)	Correction Factor (dB/m)	Result (Peak) (dBuV/m)	Result (Average) (dBuV/m)	Limit (Peak) (dBuV/m)	Limit (Average) (dBuV/m)	Margin (dB)	Remark	Ant. Pol. (H/V)
1550.00	57.83	---	-10.04	47.79	---	74.00	54.00	-6.21	Peak	V
2516.67	57.73	52.70	-3.81	53.91	48.89	74.00	54.00	-5.11	AVG	V
4933.33	49.50	43.01	2.83	52.32	45.84	74.00	54.00	-8.16	AVG	V
7383.33	50.35	40.37	7.20	57.56	47.57	74.00	54.00	-6.43	AVG	V
N/A										
1513.33	57.32	---	-10.41	46.90	---	74.00	54.00	-7.10	Peak	H
2513.33	61.39	53.83	-3.82	57.56	50.01	74.00	54.00	-3.99	AVG	H
2963.33	56.49	42.34	-2.29	54.19	40.05	74.00	54.00	-13.95	AVG	H
3283.33	50.67	---	-1.42	49.25	---	74.00	54.00	-4.75	Peak	H
4858.33	49.68	37.22	2.68	52.36	39.90	74.00	54.00	-14.10	AVG	H
7391.67	49.94	36.14	7.20	57.14	43.34	74.00	54.00	-10.66	AVG	H

Remark:

1. Measuring frequencies from 1 GHz to the 10th harmonic of highest fundamental frequency.
2. Radiated emissions measured in frequency above 1000MHz were made with an instrument using peak/average detector mode.
3. Average test would be performed if the peak result were greater than the average limit or as required by the applicant.
4. Data of measurement within this frequency range shown " --- " in the table above means the reading of emissions are attenuated more than 20dB below the permissible limits or the field strength is too small to be measured.
5. Measurements above show only up to 6 maximum emissions noted, or would be lesser, with " N/A " remark, if no specific emissions from the EUT are recorded (ie: margin > 20dB from the applicable limit) and considered that's already beyond the background noise floor.
6. Margin (dB) = Remark result (dBuV/m) – Average limit (dBuV/m).



Operation Mode: TX / IEEE 802.11n HT 20 MHz mode / CH Low **Test Date:** June 2, 2011

Temperature: 24°C

Tested by: Ali Shu

Humidity: 52% RH

Polarity: Ver. / Hor.

Frequency (MHz)	Reading (Peak) (dBuV)	Reading (Average) (dBuV)	Correction Factor (dB/m)	Result (Peak) (dBuV/m)	Result (Average) (dBuV/m)	Limit (Peak) (dBuV/m)	Limit (Average) (dBuV/m)	Margin (dB)	Remark	Ant. Pol. (H/V)
1626.67	57.25	---	-9.26	47.98	---	74.00	54.00	-6.02	Peak	V
2360.00	61.16	51.38	-4.44	56.71	46.94	74.00	54.00	-7.06	AVG	V
3216.67	52.52	---	-1.60	50.93	---	74.00	54.00	-3.07	Peak	V
4825.00	50.26	41.65	2.61	52.87	44.26	74.00	54.00	-9.74	AVG	V
7241.67	48.82	39.67	7.26	56.08	46.93	74.00	54.00	-7.07	AVG	V
N/A										
1323.33	57.02	---	-10.73	46.29	---	74.00	54.00	-7.71	Peak	H
2360.00	64.10	56.12	-4.44	59.65	51.68	74.00	54.00	-2.32	AVG	H
2463.33	63.34	54.29	-4.02	59.32	50.27	74.00	54.00	-3.73	AVG	H
3216.67	57.29	53.60	-1.60	55.70	52.00	74.00	54.00	-2.00	AVG	H
4816.67	54.14	43.08	2.59	56.73	45.67	74.00	54.00	-8.33	AVG	H
N/A										

Remark:

1. Measuring frequencies from 1 GHz to the 10th harmonic of highest fundamental frequency.
2. Radiated emissions measured in frequency above 1000MHz were made with an instrument using peak/average detector mode.
3. Average test would be performed if the peak result were greater than the average limit or as required by the applicant.
4. Data of measurement within this frequency range shown " --- " in the table above means the reading of emissions are attenuated more than 20dB below the permissible limits or the field strength is too small to be measured.
5. Measurements above show only up to 6 maximum emissions noted, or would be lesser, with " N/A " remark, if no specific emissions from the EUT are recorded (ie: margin > 20dB from the applicable limit) and considered that's already beyond the background noise floor.
6. Margin (dB) = Remark result (dBuV/m) – Average limit (dBuV/m).



Operation Mode: TX / IEEE 802.11n HT 20 MHz mode / CH Mid **Test Date:** June 2, 2011

Temperature: 24°C

Tested by: Ali Shu

Humidity: 52% RH

Polarity: Ver. / Hor.

Frequency (MHz)	Reading (Peak) (dBuV)	Reading (Average) (dBuV)	Correction Factor (dB/m)	Result (Peak) (dBuV/m)	Result (Average) (dBuV/m)	Limit (Peak) (dBuV/m)	Limit (Average) (dBuV/m)	Margin (dB)	Remark	Ant. Pol. (H/V)
2390.00	58.79	49.38	-4.32	54.46	45.06	74.00	54.00	-8.94	AVG	V
3258.33	53.07	---	-1.49	51.58	---	74.00	54.00	-2.42	Peak	V
4883.33	50.49	41.35	2.73	53.22	44.08	74.00	54.00	-9.92	AVG	V
7333.33	50.93	42.42	7.22	58.15	49.64	74.00	54.00	-4.36	AVG	V
N/A										
2390.00	62.70	56.23	-4.32	58.37	51.91	74.00	54.00	-2.09	AVG	H
2493.33	62.39	52.56	-3.90	58.50	48.66	74.00	54.00	-5.34	AVG	H
3258.33	55.44	52.41	-1.49	53.95	50.92	74.00	54.00	-3.08	AVG	H
4883.33	51.29	42.52	2.73	54.02	45.25	74.00	54.00	-8.75	AVG	H
7333.33	49.04	38.01	7.22	56.27	45.23	74.00	54.00	-8.77	AVG	H
N/A										

Remark:

1. Measuring frequencies from 1 GHz to the 10th harmonic of highest fundamental frequency.
2. Radiated emissions measured in frequency above 1000MHz were made with an instrument using peak/average detector mode.
3. Average test would be performed if the peak result were greater than the average limit or as required by the applicant.
4. Data of measurement within this frequency range shown " --- " in the table above means the reading of emissions are attenuated more than 20dB below the permissible limits or the field strength is too small to be measured.
5. Measurements above show only up to 6 maximum emissions noted, or would be lesser, with " N/A " remark, if no specific emissions from the EUT are recorded (ie: margin > 20dB from the applicable limit) and considered that's already beyond the background noise floor.
6. Margin (dB) = Remark result (dBuV/m) – Average limit (dBuV/m).



Operation Mode: TX / IEEE 802.11n HT 20 MHz mode / CH High **Test Date:** June 2, 2011

Temperature: 20°C

Tested by: Ali Shu

Humidity: 52% RH

Polarity: Ver. / Hor.

Frequency (MHz)	Reading (Peak) (dBuV)	Reading (Average) (dBuV)	Correction Factor (dB/m)	Result (Peak) (dBuV/m)	Result (Average) (dBuV/m)	Limit (Peak) (dBuV/m)	Limit (Average) (dBuV/m)	Margin (dB)	Remark	Ant. Pol. (H/V)
2320.00	59.31	46.87	-4.61	54.70	42.26	74.00	54.00	-11.74	AVG	V
2410.00	60.90	52.18	-4.24	56.66	47.94	74.00	54.00	-6.06	AVG	V
2513.33	58.12	51.69	-3.82	54.30	47.87	74.00	54.00	-6.13	AVG	V
3283.33	50.60	---	-1.42	49.18	---	74.00	54.00	-4.82	Peak	V
4925.00	48.83	---	2.81	51.64	---	74.00	54.00	-2.36	Peak	V
7383.33	47.85	38.83	7.20	55.06	46.03	74.00	54.00	-7.97	AVG	V
2320.00	60.67	51.26	-4.61	56.06	46.65	74.00	54.00	-7.35	AVG	H
2410.00	64.93	56.99	-4.24	60.69	52.75	74.00	54.00	-1.25	AVG	H
2516.67	62.99	54.56	-3.81	59.17	50.75	74.00	54.00	-3.25	AVG	H
3283.33	53.63	51.04	-1.42	52.21	49.62	74.00	54.00	-4.38	AVG	H
N/A										

Remark:

1. Measuring frequencies from 1 GHz to the 10th harmonic of highest fundamental frequency.
2. Radiated emissions measured in frequency above 1000MHz were made with an instrument using peak/average detector mode.
3. Average test would be performed if the peak result were greater than the average limit or as required by the applicant.
4. Data of measurement within this frequency range shown " --- " in the table above means the reading of emissions are attenuated more than 20dB below the permissible limits or the field strength is too small to be measured.
5. Measurements above show only up to 6 maximum emissions noted, or would be lesser, with " N/A " remark, if no specific emissions from the EUT are recorded (ie: margin > 20dB from the applicable limit) and considered that's already beyond the background noise floor.
6. Margin (dB) = Remark result (dBuV/m) – Average limit (dBuV/m).



Operation Mode: TX / IEEE 802.11n HT 40 MHz mode
/ CH Low
Temperature: 24°C
Humidity: 52% RH

Test Date: June 2, 2011
Tested by: Ali Shu
Polarity: Ver. / Hor.

Frequency (MHz)	Reading (Peak) (dBuV)	Reading (Average) (dBuV)	Correction Factor (dB/m)	Result (Peak) (dBuV/m)	Result (Average) (dBuV/m)	Limit (Peak) (dBuV/m)	Limit (Average) (dBuV/m)	Margin (dB)	Remark	Ant. Pol. (H/V)
1476.67	58.33	---	-10.57	47.76	---	74.00	54.00	-6.24	Peak	V
2316.67	60.16	50.78	-4.62	55.54	46.16	74.00	54.00	-7.84	AVG	V
2526.67	57.59	49.83	-3.78	53.81	46.05	74.00	54.00	-7.95	AVG	V
3233.33	52.07	---	-1.55	50.51	---	74.00	54.00	-3.49	Peak	V
7258.33	48.61	38.16	7.25	55.87	45.41	74.00	54.00	-8.59	AVG	V
N/A										
1456.67	57.65	---	-10.60	47.05	---	74.00	54.00	-6.95	Peak	H
2320.00	61.87	52.99	-4.61	57.27	48.38	74.00	54.00	-5.62	AVG	H
2526.67	60.54	49.97	-3.78	56.76	46.19	74.00	54.00	-7.81	AVG	H
3233.33	55.65	53.30	-1.55	54.09	51.75	74.00	54.00	-2.25	AVG	H
N/A										

Remark:

1. Measuring frequencies from 1 GHz to the 10th harmonic of highest fundamental frequency.
2. Radiated emissions measured in frequency above 1000MHz were made with an instrument using peak/average detector mode.
3. Average test would be performed if the peak result were greater than the average limit or as required by the applicant.
4. Data of measurement within this frequency range shown " --- " in the table above means the reading of emissions are attenuated more than 20dB below the permissible limits or the field strength is too small to be measured.
5. Measurements above show only up to 6 maximum emissions noted, or would be lesser, with " N/A " remark, if no specific emissions from the EUT are recorded (ie: margin > 20dB from the applicable limit) and considered that's already beyond the background noise floor.
6. Margin (dB) = Remark result (dBuV/m) – Average limit (dBuV/m).



Operation Mode: TX / IEEE 802.11n HT 40 MHz mode
/ CH Mid

Test Date: June 2, 2011

Temperature: 24°C

Tested by: Ali Shu

Humidity: 52% RH

Polarity: Ver. / Hor.

Frequency (MHz)	Reading (Peak) (dBuV)	Reading (Average) (dBuV)	Correction Factor (dB/m)	Result (Peak) (dBuV/m)	Result (Average) (dBuV/m)	Limit (Peak) (dBuV/m)	Limit (Average) (dBuV/m)	Margin (dB)	Remark	Ant. Pol. (H/V)
1543.33	57.19	---	-10.11	47.08	---	74.00	54.00	-6.92	Peak	V
2306.67	59.54	48.59	-4.66	54.87	43.93	74.00	54.00	-10.07	AVG	V
2340.00	61.25	51.05	-4.53	56.72	46.52	74.00	54.00	-7.48	AVG	V
3258.33	52.58	---	-1.49	51.09	---	74.00	54.00	-2.91	Peak	V
7333.33	47.94	40.90	7.22	55.16	48.12	74.00	54.00	-5.88	AVG	V
N/A										
1276.67	58.24	---	-10.78	47.46	---	74.00	54.00	-6.54	Peak	H
2340.00	63.65	54.45	-4.53	59.13	49.92	74.00	54.00	-4.08	AVG	H
2543.33	60.53	49.79	-3.72	56.81	46.07	74.00	54.00	-7.93	AVG	H
3258.33	54.92	50.60	-1.49	53.44	49.11	74.00	54.00	-4.89	AVG	H
4875.00	50.64	40.49	2.71	53.35	43.20	74.00	54.00	-10.80	AVG	H
N/A										

Remark:

1. Measuring frequencies from 1 GHz to the 10th harmonic of highest fundamental frequency.
2. Radiated emissions measured in frequency above 1000MHz were made with an instrument using peak/average detector mode.
3. Average test would be performed if the peak result were greater than the average limit or as required by the applicant.
4. Data of measurement within this frequency range shown " --- " in the table above means the reading of emissions are attenuated more than 20dB below the permissible limits or the field strength is too small to be measured.
5. Measurements above show only up to 6 maximum emissions noted, or would be lesser, with " N/A " remark, if no specific emissions from the EUT are recorded (ie: margin > 20dB from the applicable limit) and considered that's already beyond the background noise floor.
6. Margin (dB) = Remark result (dBuV/m) – Average limit (dBuV/m).



Operation Mode: TX / IEEE 802.11n HT 40 MHz mode
/ CH High
Temperature: 24°C
Humidity: 52% RH

Test Date: June 2, 2011
Tested by: Ali Shu
Polarity: Ver. / Hor.

Frequency (MHz)	Reading (Peak) (dBuV)	Reading (Average) (dBuV)	Correction Factor (dB/m)	Result (Peak) (dBuV/m)	Result (Average) (dBuV/m)	Limit (Peak) (dBuV/m)	Limit (Average) (dBuV/m)	Margin (dB)	Remark	Ant. Pol. (H/V)
2346.67	58.78	52.62	-4.50	54.28	48.12	74.00	54.00	-5.88	AVG	V
2553.33	57.13	47.04	-3.69	53.44	43.35	74.00	54.00	-10.65	AVG	V
3266.67	50.93	---	-1.47	49.46	---	74.00	54.00	-4.54	Peak	V
4900.00	48.85	---	2.76	51.61	---	74.00	54.00	-2.39	Peak	V
N/A										
1526.67	56.78	---	-10.28	46.50	---	74.00	54.00	-7.50	Peak	H
2316.67	59.77	48.45	-4.62	55.15	43.83	74.00	54.00	-10.17	AVG	H
2350.00	62.12	53.13	-4.49	57.63	48.64	74.00	54.00	-5.36	AVG	H
2556.67	59.37	49.54	-3.68	55.69	45.86	74.00	54.00	-8.14	AVG	H
3266.67	53.29	---	-1.47	51.82	---	74.00	54.00	-2.18	Peak	H
4875.00	49.60	34.65	2.71	52.31	37.36	74.00	54.00	-16.64	AVG	H

Remark:

1. Measuring frequencies from 1 GHz to the 10th harmonic of highest fundamental frequency.
2. Radiated emissions measured in frequency above 1000MHz were made with an instrument using peak/average detector mode.
3. Average test would be performed if the peak result were greater than the average limit or as required by the applicant.
4. Data of measurement within this frequency range shown " --- " in the table above means the reading of emissions are attenuated more than 20dB below the permissible limits or the field strength is too small to be measured.
5. Measurements above show only up to 6 maximum emissions noted, or would be lesser, with " N/A " remark, if no specific emissions from the EUT are recorded (ie: margin > 20dB from the applicable limit) and considered that's already beyond the background noise floor.
6. Margin (dB) = Remark result (dBuV/m) – Average limit (dBuV/m).



7.8 POWERLINE CONDUCTED EMISSIONS

LIMIT

According to §15.207(a), except as shown in paragraphs (b) and (c) of this section, for an intentional radiator that is designed to be connected to the public utility (AC) power line, the radio frequency voltage that is conducted back onto the AC power line on any frequency or frequencies within the band 150 kHz to 30 MHz shall not exceed the limits in the following table, as measured using a 50 μ H/50 ohms line impedance stabilization network (LISN). Compliance with the provisions of this paragraph shall be based on the measurement of the radio frequency voltage between each power line and ground at the power terminal. The lower limit applies at the boundary between the frequency ranges.

Frequency Range (MHz)	Limits (dB μ V)	
	Quasi-peak	Average
0.15 to 0.50	66 to 56*	56 to 46*
0.50 to 5	56	46
5 to 30	60	50

* Decreases with the logarithm of the frequency.

Test Configuration

See test photographs attached in Appendix 1 for the actual connections between EUT and support equipment.

TEST PROCEDURE

1. The EUT was placed on a table, which is 0.8m above ground plane.
2. Maximum procedure was performed on the six highest emissions to ensure EUT compliance.
3. Repeat above procedures until all frequency measured were complete.



TEST RESULTS

The initial step in collecting conducted data is a spectrum analyzer peak scan of the measurement range. Significant peaks are then marked as shown on the following data page, and these signals are then quasi-peaked.

Test Data

Operation Mode: Normal Link **Test Date:** 2011/5/27
Temperature: 24°C **Tested by:** Leon Yu
Humidity: 60% RH

Freq. (MHz)	QP Reading (dBuV)	AV Reading (dBuV)	Corr. factor (dB/m)	QP Result (dBuV/m)	AV Result (dBuV/m)	QP Limit (dBuV)	AV Limit (dBuV)	QP Margin (dB)	AV Margin (dB)	Note
0.1500	44.38	27.95	10.26	54.64	38.21	65.99	55.99	-11.35	-17.78	L1
0.1620	42.85	33.16	10.23	53.08	43.39	65.36	55.34	-12.28	-11.97	L1
0.3100	32.59	22.02	10.06	42.65	32.08	59.97	49.97	-17.32	-17.89	L1
2.5100	27.52	14.50	10.04	37.56	24.54	56.00	46.00	-18.44	-21.46	L1
6.5900	30.18	21.19	10.12	40.30	31.31	60.00	50.00	-19.70	-18.69	L1
13.0100	33.47	26.29	10.29	43.76	36.58	60.00	50.00	-16.24	-13.42	L1
0.1539	43.21	29.36	10.25	53.46	39.61	65.78	55.78	-12.32	-16.17	L2
0.2300	30.25	16.50	10.12	40.37	26.62	62.45	52.45	-22.08	-25.83	L2
0.7060	28.53	12.30	10.02	38.55	22.32	56.00	46.00	-17.45	-23.68	L2
2.4820	27.59	15.70	10.04	37.63	25.74	56.00	46.00	-18.37	-20.26	L2
6.5780	28.63	20.79	10.12	38.75	30.91	60.00	50.00	-21.25	-19.09	L2
13.0100	34.82	26.64	10.29	45.11	36.93	60.00	50.00	-14.89	-13.07	L2

Remark:

1. Measuring frequencies from 0.15 MHz to 30MHz.
2. The emissions measured in frequency range from 0.15 MHz to 30MHz were made with an instrument using Quasi-peak detector and average detector.
3. The IF bandwidth of SPA between 0.15MHz and 30MHz was 10 kHz; the IF bandwidth of Test Receiver between 0.15MHz and 30MHz was 9 kHz;
4. L1 = Line One (Live Line) / L2 = Line Two (Neutral Line)



Test Plots

Conducted emissions (Line 1)

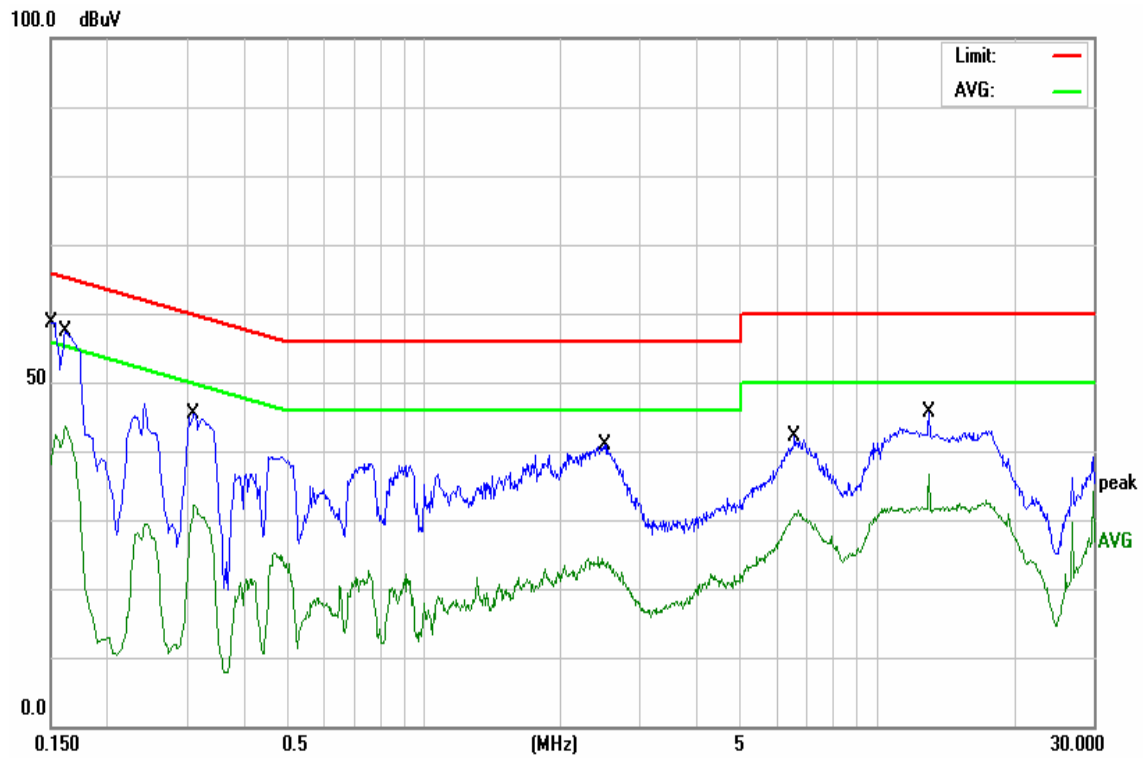

Conducted emissions (Line 2)

