





FCC 47 CFR PART 15 SUBPART C

TEST REPORT

For

Smart Home Gateway

Model Name	Trade Mark
NA301-ZBxxxxxxx (the 1st x should be "blank" or "-"; the rest x could be 0 to 9, A to Z, "blank" or "-" for marketing purpose)	
G150-ZBxxxxx (the 1st x should be "blank" or "-"; the rest x could be 0 to 9, A to Z, "blank" or "-" for marketing purpose)	
VeraEdge-ZBxxxxx (the 1st x should be "blank" or "-"; the rest x could be 0 to 9, A to Z, "blank" or "-" for marketing purpose)	
F2-ZB	
	

Issued to

Sercomm Corporation

8F, No. 3-1, YuanQu St., NanKang, Taipei 115, Taiwan, R.O.C.

Issued by

Compliance Certification Services Inc.

**No.11, Wugong 6th Rd., Wugu Dist.,
New Taipei City 24891, Taiwan. (R.O.C.)**

<http://www.ccsrf.com>

service@ccsrf.com

Issued Date: July 19, 2016



Note: This report shall not be reproduced except in full, without the written approval of Compliance Certification Services Inc. This document may be altered or revised by Compliance Certification Services Inc. personnel only, and shall be noted in the revision section of the document.

Revision History

Rev.	Issue Date	Revisions	Effect Page	Revised By
00	July 19, 2016	Initial Issue	ALL	Angel Cheng

TABLE OF CONTENTS





1. TEST RESULT CERTIFICATION.....	4
2. EUT DESCRIPTION.....	6
3. TEST METHODOLOGY.....	8
3.1 EUT CONFIGURATION	8
3.2 EUT EXERCISE	8
3.3 GENERAL TEST PROCEDURES	8
3.4 FCC PART 15.205 RESTRICTED BANDS OF OPERATIONS.....	9
3.5 DESCRIPTION OF TEST MODES	10
4 INSTRUMENT CALIBRATION.....	11
4.1 MEASURING INSTRUMENT CALIBRATION	11
4.2 MEASUREMENT EQUIPMENT USED	11
4.3 MEASUREMENT UNCERTAINTY	12
5 FACILITIES AND ACCREDITATIONS.....	13
5.1 FACILITIES.....	13
5.2 EQUIPMENT	13
5.3 TABLE OF ACCREDITATIONS AND LISTINGS.....	14
6 SETUP OF EQUIPMENT UNDER TEST.....	15
6.1 SETUP CONFIGURATION OF EUT	15
6.2 SUPPORT EQUIPMENT	15
7 FCC PART 15.247 REQUIREMENTS.....	16
7.1 6DB BANDWIDTH.....	16
7.2 PEAK POWER	19
7.3 AVERAGE POWER.....	20
7.4 BAND EDGES MEASUREMENT.....	21
7.5 PEAK POWER SPECTRAL DENSITY.....	39
7.6 RADIATED EMISSIONS.....	42
7.7 POWERLINE CONDUCTED EMISSIONS.....	54
APPENDIX I PHOTOGRAPHS OF TEST SETUP.....	57
APPENDIX 1 - PHOTOGRAPHS OF EUT	

1. TEST RESULT CERTIFICATION

Applicant: Sercomm Corporation
8F, No. 3-1, YuanQu St., NanKang, Taipei 115, Taiwan, R.O.C.

Equipment Under Test: Smart Home Gateway

Model Name / Trade Name:

Model Name	Trade Mark
NA301-ZBxxxxxxxx (the 1st x should be "blank" or "-"; the rest x could be 0 to 9, A to Z, "blank" or "-" for marketing purpose)	
G150-ZBxxxxx (the 1st x should be "blank" or "-"; the rest x could be 0 to 9, A to Z, "blank" or "-" for marketing purpose)	
VeraEdge-ZBxxxxx (the 1st x should be "blank" or "-"; the rest x could be 0 to 9, A to Z, "blank" or "-" for marketing purpose)	
F2-ZB	
	

Date of Test: June 27 ~ July 7, 2016

APPLICABLE STANDARDS	
STANDARD	TEST RESULT
FCC 47 CFR Part 15 Subpart C	No non-compliance noted
Deviation from Applicable Standard	
N/A	

We hereby certify that:

The above equipment was tested by Compliance Certification Services Inc. The test data, data evaluation, test procedures, and equipment configurations shown in this report were made in accordance with the procedures given in ANSI C63.10: 2013 and the energy emitted by the sample EUT tested as described in this report is in compliance with the requirements of FCC Rules Part 15.207, 15.209, 15.247.



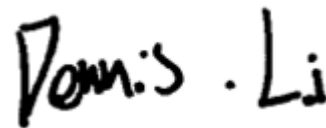

The test results of this report relate only to the tested sample EUT identified in this report.

*Approved by:**Tested by:*

Miller Lee
Manager
Compliance Certification Services Inc.

Dennis Li
Engineer
Compliance Certification Services Inc.

2. EUT DESCRIPTION

Product	Smart Home Gateway	
Trade Name / Model Name	Model Name	Trade Mark
	NA301-ZBxxxxxxxx (the 1st x should be "blank" or "-"; the rest x could be 0 to 9, A to Z, "blank" or "-" for marketing purpose)	
	G150-ZBxxxxx (the 1st x should be "blank" or "-"; the rest x could be 0 to 9, A to Z, "blank" or "-" for marketing purpose)	
	VeraEdge-ZBxxxxx (the 1st x should be "blank" or "-"; the rest x could be 0 to 9, A to Z, "blank" or "-" for marketing purpose)	
	F2-ZB	
Model Discrepancy	All the specification and layout are identical except they come with different model numbers for marketing purposes.	
Received Date	June 16, 2016	
Power Adapter	Power form power adapter. APD / WA-12M12FU I/P: 100-240V, 50-60Hz, 0.5A MAX O/P: 12V, 1A	
Frequency Range	Zigbee: 2405~2480MHz	
Transmit Power	16.08 dBm	
Modulation Technique	Zigbee: OPQSK (Offset Quadrature Phase Shift Keyed)	
Number of Channels	14 Channels	
Antenna Specification	Zigbee: Gain: 4.92 dBi	
Antenna Designation	Zigbee: PIFA Antenna	

Remark:

1. *The sample selected for test was production product and was provided by manufacturer.*
2. *This submittal(s) (test report) is intended for FCC ID: **P27NA301ZB** filing to comply with Section 15.207, 15.209 and 15.247 of the FCC Part 15, Subpart C Rules.*

3. TEST METHODOLOGY

The tests documented in this report were performed in accordance with ANSI C63.10: 2013 and FCC CFR 47 Part 15.207, 15.209, 15.247, KDB 558074 D01 DTS Meas Guidance v03r05

3.1 EUT CONFIGURATION

The EUT configuration for testing is installed on RF field strength measurement to meet the Commissions requirement and operating in a manner that intends to maximize its emission characteristics in a continuous normal application.

3.2 EUT EXERCISE

The EUT was operated in the engineering mode to fix the TX frequency that was for the purpose of the measurements.

According to its specifications, the EUT must comply with the requirements of the Section 15.207, 15.209 and 15.247 under the FCC Rules Part 15 Subpart C.

3.3 GENERAL TEST PROCEDURES

Conducted Emissions

According to the requirements in ANSI C63.10: 2013 Conducted emissions from the EUT measured in the frequency range between 0.15 MHz and 30MHz using CISPR Quasi-peak and average detector modes.

Radiated Emissions

The EUT is placed on a turn table, which is 1.5 m above ground plane. The turntable shall rotate 360 degrees to determine the position of maximum emission level. EUT is set 3m away from the receiving antenna, which varied from 1m to 4m to find out the highest emission. And also, each emission was to be maximized by changing the polarization of receiving antenna both horizontal and vertical. In order to find out the maximum emissions, exploratory radiated emission measurements were made according to the requirements in ANSI C63.10: 2013.

3.4 FCC PART 15.205 RESTRICTED BANDS OF OPERATIONS

(a) Except as shown in paragraph (d) of this section, only spurious emissions are permitted in any of the frequency bands listed below:

MHz	MHz	MHz	GHz
0.090 - 0.110	16.42 - 16.423	399.9 - 410	4.5 - 5.15
¹ 0.495 - 0.505	16.69475 - 16.69525	608 - 614	5.35 - 5.46
2.1735 - 2.1905	16.80425 - 16.80475	960 - 1240	7.25 - 7.75
4.125 - 4.128	25.5 - 25.67	1300 - 1427	8.025 - 8.5
4.17725 - 4.17775	37.5 - 38.25	1435 - 1626.5	9.0 - 9.2
4.20725 - 4.20775	73 - 74.6	1645.5 - 1646.5	9.3 - 9.5
6.215 - 6.218	74.8 - 75.2	1660 - 1710	10.6 - 12.7
6.26775 - 6.26825	108 - 121.94	1718.8 - 1722.2	13.25 - 13.4
6.31175 - 6.31225	123 - 138	2200 - 2300	14.47 - 14.5
8.291 - 8.294	149.9 - 150.05	2310 - 2390	15.35 - 16.2
8.362 - 8.366	156.52475 -	2483.5 - 2500	17.7 - 21.4
8.37625 - 8.38675	156.52525	2655 - 2900	22.01 - 23.12
8.41425 - 8.41475	156.7 - 156.9	3260 - 3267	23.6 - 24.0
12.29 - 12.293	162.0125 - 167.17	3332 - 3339	31.2 - 31.8
12.51975 - 12.52025	167.72 - 173.2	3345.8 - 3358	36.43 - 36.5
12.57675 - 12.57725	240 - 285	3600 - 4400	(²)
13.36 - 13.41	322 - 335.4		

¹ Until February 1, 1999, this restricted band shall be 0.490-0.510 MHz.

² Above 38.6

(b) Except as provided in paragraphs (d) and (e), the field strength of emissions appearing within these frequency bands shall not exceed the limits shown in Section 15.209. At frequencies equal to or less than 1000 MHz, compliance with the limits in Section 15.209 shall be demonstrated using measurement instrumentation employing a CISPR quasi-peak detector. Above 1000 MHz, compliance with the emission limits in Section 15.209 shall be demonstrated based on the average value of the measured emissions. The provisions in Section 15.35 apply to these measurements.

3.5 DESCRIPTION OF TEST MODES

The EUT (model: NA301-ZB-US) had been tested under operating condition.

Software used to control the EUT for staying in continuous transmitting mode was programmed.

After verification, all tests were carried out with the worst case test modes as shown below except radiated spurious emission below 1GHz and power line conducted emissions below 30MHz, which worst case was in normal link mode only.

Zigbee:

Channel Low and Channel High were chosen for full testing.

The field strength of spurious emission was measured in the following position: EUT stand-up position (Z axis), lie-down position (X, Y axis). The worst emission was found in lie-down position (X axis) and the worst case was recorded.

4 INSTRUMENT CALIBRATION

4.1 MEASURING INSTRUMENT CALIBRATION

The measuring equipment, which was utilized in performing the tests documented herein, has been calibrated in accordance with the manufacturer's recommendations for utilizing calibration equipment, which is traceable to recognized national standards.

4.2 MEASUREMENT EQUIPMENT USED

Equipment Used for Emissions Measurement

Remark: Each piece of equipment is scheduled for calibration once a year.

Conducted Emissions Test Site					
Name of Equipment	Manufacturer	Model	Serial Number	Calibration Date	Calibration Due
DC Power Supplies	GW Instek	SPS-3610	GPE880163	01/19/2016	01/18/2017
Power Meter	Anritsu	ML2495A	1012009	07/07/2016	07/06/2017
Power Sensor	Anritsu	MA2411B	917072	07/07/2016	07/06/2017
Signal Analyzer	R&S	FSV 40	101073	07/20/2015	07/19/2016
Spectrum Analyzer	Agilent	E4446A	US42510268	02/15/2016	02/14/2017
Thermostatic/Hrgrosatic Chamber	TAICHY	MHG-150LF	930619	10/08/2015	10/07/2016
Vector Signal Generator	R&S	SMU 200A	102239	03/10/2016	03/09/2017
AC Power Source	EXTECH	6205	1140845	N.C.R	N.C.R

Wugu 966 Chamber A					
Name of Equipment	Manufacturer	Model	Serial Number	Calibration Date	Calibration Due
Bilog Antenna	Sunol Sciences	JB3	A030105	08/06/2015	08/05/2016
EMI Test Receiver	R&S	ESCI	100064	06/03/2016	06/02/2017
Horn Antenna	EMCO	3117	55165	02/24/2016	02/23/2017
Horn Antenna	EMCO	3116	26370	01/15/2016	01/14/2017
K Type Cable	Huber+Suhner	SUCOFLEX 102	29406/2	01/12/2016	01/11/2017
K Type Cable	Huber+Suhner	SUCOFLEX 102	22470/2	01/12/2016	01/11/2017
Pre-Amplifier	MITEQ	AMF-6F-260400-40-8P	985646	01/14/2016	01/13/2017
Pre-Amplifier	EMCI	EMC 012635	980151	06/04/2016	06/03/2017
Pre-Amplifier	EMCI	EM330	N/A	06/04/2016	06/03/2017
Spectrum Analyzer	Agilent	E4446A	US42510252	12/08/2015	12/07/2016
Antenna Tower	CCS	CC-A-1F	N/A	N.C.R	N.C.R
Controller	CCS	CC-C-1F	N/A	N.C.R	N.C.R
Turn Table	CCS	CC-T-1F	N/A	N.C.R	N.C.R
Software	EZ-EMC (CCS-3A1RE)				

Conducted Emission Room # B					
Name of Equipment	Manufacturer	Model	Serial Number	Calibration Date	Calibration Due
EMI Test Receiver	R&S	ESCI	101073	09/09/2015	09/08/2016
LISN	SCHWARZBECK	NSLK 8127	8127-541	11/23/2015	11/22/2016
LISN	R&S	ENV216	101054	05/06/2016	05/05/2017
Capacitive Voltage Probe	FCC	F-CVP-1	100185	03/09/2016	03/08/2017
Test S/W	CCS-3A1-CE				

4.3 MEASUREMENT UNCERTAINTY

PARAMETER	UNCERTAINTY
Powerline Conducted Emission	+/- 1.2575
3M Semi Anechoic Chamber / <200M	+/- 4.0138
3M Semi Anechoic Chamber / 200M~1000M	+/- 3.9483
3M Semi Anechoic Chamber / 1G~8G	+/- 2.5975
3M Semi Anechoic Chamber / 8G~18G	+/- 2.6112
3M Semi Anechoic Chamber / 18G~26G	+/- 2.7389
3M Semi Anechoic Chamber / 26G~40G	+/- 2.9683

Remark: This uncertainty represents an expanded uncertainty expressed at approximately the 95% confidence level using a coverage factor of $k=2$.

5 FACILITIES AND ACCREDITATIONS

5.1 FACILITIES

All measurement facilities used to collect the measurement data are located at

- No.199, Chunghsen Road, Hsintien City, Taipei Hsien, Taiwan, R.O.C.
Tel: 886-2-2217-0894 / Fax: 886-2-2217-1029
- No.11, Wugong 6th Rd., Wugu Dist., New Taipei City 24891, Taiwan. (R.O.C.)
Tel: 886-2-2299-9720 / Fax: 886-2-2298-4045
- No.81-1, Lane 210, Bade 2nd Rd., Lujhu Township, Taoyuan County 33841, TAIWAN, R.O.C.
Tel: 886-3-324-0332 / Fax: 886-3-324-5235

The sites are constructed in conformance with the requirements of ANSI C63.7, ANSI C63.10: 2013 and CISPR Publication 22.

5.2 EQUIPMENT



Radiated emissions are measured with one or more of the following types of linearly polarized antennas: tuned dipole, biconical, log periodic, bi-log, and/or ridged waveguide, horn. Spectrum analyzers with pre-selectors and quasi-peak detectors are used to perform radiated measurements.

Conducted emissions are measured with Line Impedance Stabilization Networks and EMI Test Receivers.

Calibrated wideband preamplifiers, coaxial cables, and coaxial attenuators are also used for making measurements.

All receiving equipment conforms to CISPR Publication 16-1, "Radio Interference Measuring Apparatus and Measurement Methods."

5.3 TABLE OF ACCREDITATIONS AND LISTINGS

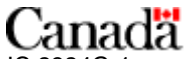
Country	Agency	Scope of Accreditation	Logo
USA	FCC	3M Semi Anechoic Chamber (FCC MRA: TW1039) to perform FCC Part 15 measurements	 FCC MRA: TW1039
Taiwan	TAF	LP0002, RTTE01, FCC Method-47 CFR Part 15 Subpart C, D, E, RSS-210, RSS-310 IDA TS SRD, AS/NZS 4268, AS/NZS 4771, TS 12.1 & 12.2, ETSI EN 300 440-1, ETSI EN 300 440-2, ETSI EN 300 328, ETSI EN 300 220-1, ETSI EN 300 220-2, ETSI EN 301 893, ETSI EN 301 489-1/3/7/17 FCC OET Bulletin 65 + Supplement C, EN 50360, EN 50361, EN 50371, RSS 102, EN 50383, EN 50385, EN 50392, IEC 62209, CNS 14958-1, CNS 14959 FCC Method -47 CFR Part 15 Subpart B IEC / EN 61000-3-2, IEC / EN 61000-3-3, IEC / EN 61000-4-2/3/4/5/6/8/11	 Testing Laboratory 1309
Canada	Industry Canada	3M Semi Anechoic Chamber (IC 2324G-1 / IC 2324G-2) to perform	 IC 2324G-1 IC 2324G-2

** No part of this report may be used to claim or imply product endorsement by A2LA or any agency of the US Government.*

6 SETUP OF EQUIPMENT UNDER TEST

6.1 SETUP CONFIGURATION OF EUT

See test photographs attached in Appendix II for the actual connections between EUT and support equipment.

6.2 SUPPORT EQUIPMENT

No.	Device Type	Brand	Model	Series No.	FCC ID	Data Cable	Power Cord
1.	Notebook PC	DELL	PP19L	7B3ZP1S	N/A	N/A	AC I/P: Unshielded, 1.8m DC O/P: Unshielded, 1.8m with a core

Remark:

1. *All the equipment/cables were placed in the worst-case configuration to maximize the emission during the test.*
2. *Grounding was established in accordance with the manufacturer's requirements and conditions for the intended use.*

7 FCC PART 15.247 REQUIREMENTS

7.1 6DB BANDWIDTH

LIMIT

According to §15.247(a)(2), systems using digital modulation techniques may operate in the 902 - 928 MHz, 2400 - 2483.5 MHz, and 5725 - 5850 MHz bands. The minimum 6 dB bandwidth shall be at least 500 kHz.

Test Configuration

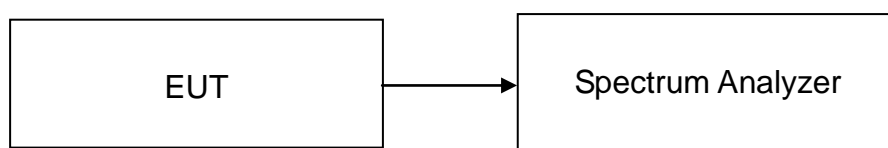

TEST PROCEDURE

1. Place the EUT on the table and set it in the transmitting mode.
2. Remove the antenna from the EUT and then connect a low loss RF cable from the antenna port to the spectrum analyzer.
3. Set the spectrum analyzer as RBW = 100 kHz, VBW= 300kHz, Span = 50 MHz, Sweep = auto.
4. Mark the peak frequency and –6dB (upper and lower) frequency.
5. Repeat until all the rest channels are investigated.

TEST RESULTS

No non-compliance noted

Test Data

Channel	Frequency (MHz)	6dB Bandwidth (MHz)	Limit (kHz)	Test Result
Low	2405	1.6060	>500	PASS
Mid	2440	1.6060		PASS
High	2480	1.5920		PASS

Test Plot

6dB Bandwidth (CH Low)

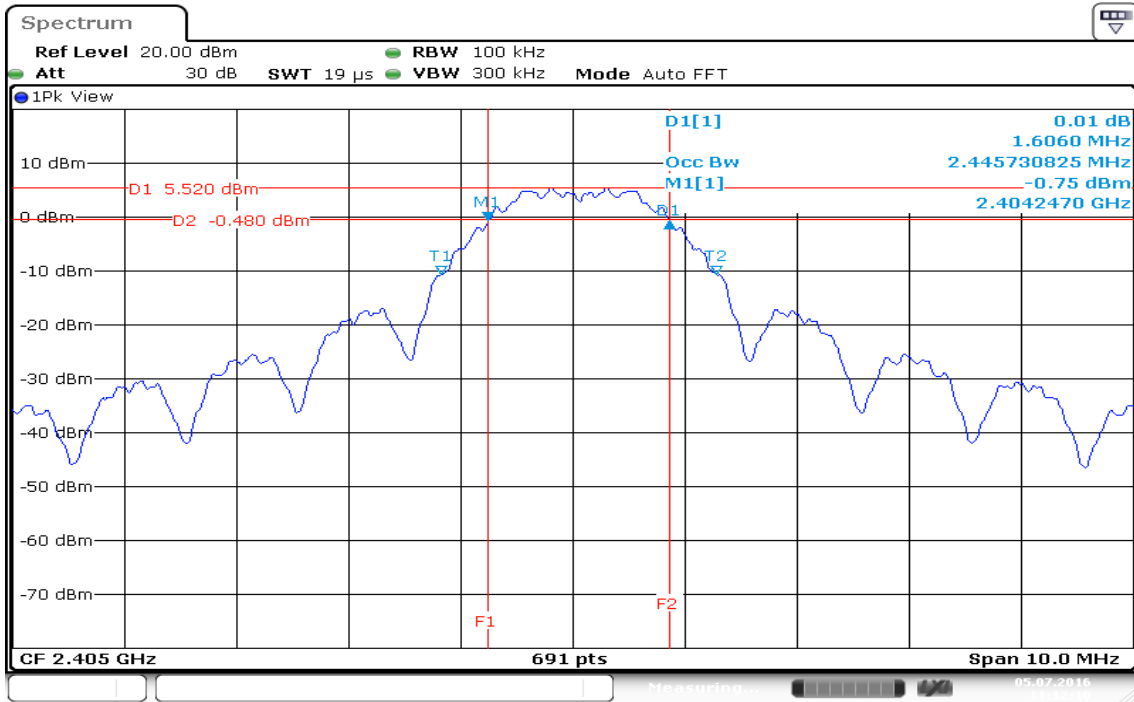

6dB Bandwidth (CH Mid)

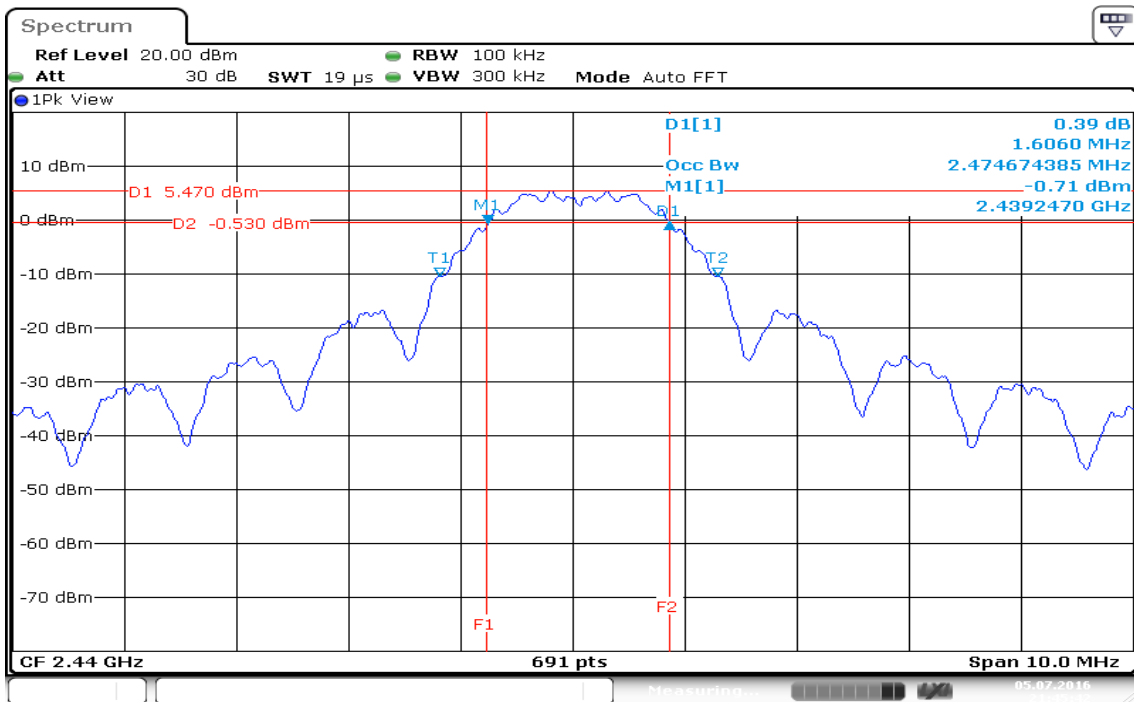

6dB Bandwidth (CH High)

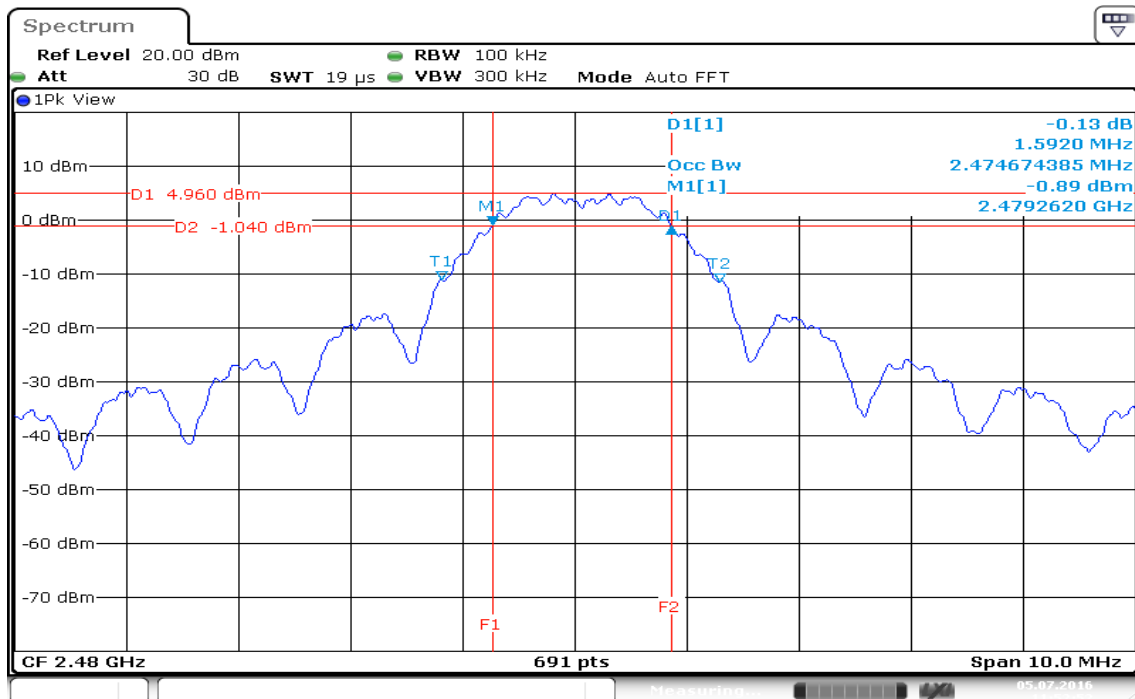

7.2 PEAK POWER

LIMIT

The maximum peak output power of the intentional radiator shall not exceed the following:

1. According to §15.247(b)(3), for systems using digital modulation in the bands of 902-928 MHz, 2400-2483.5 MHz, and 5725-5850 MHz: 1 Watt.
2. According to §15.247(b)(4), the conducted output power limit specified in paragraph (b) of this section is based on the use of antennas with directional gains that do not exceed 6 dBi. Except as shown in paragraph (c) of this section, if transmitting antennas of directional gain greater than 6 dBi are used, the conducted output power from the intentional radiator shall be reduced below the stated values in paragraphs (b)(1), (b)(2), and (b)(3) of this section, as appropriate, by the amount in dB that the directional gain of the antenna exceeds 6 dBi.

Test Configuration

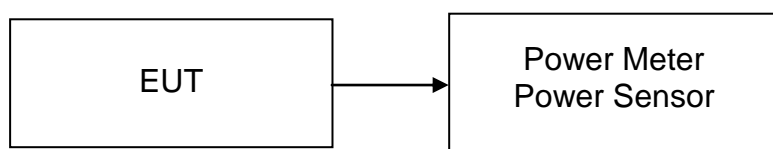

TEST PROCEDURE

The transmitter output is connected to the Power Meter. The Power Meter is set to the peak power detection.

TEST RESULTS

No non-compliance noted

Test Data

Channel	Frequency (MHz)	Output Power (dBm)	Output Power (W)	Limit (W)	Test Result
Low	2405	16.01	0.0399	1	PASS
Mid	2440	*16.08	0.0406		PASS
High	2480	15.22	0.0333		PASS

7.3 AVERAGE POWER

LIMIT

None; for reporting purposes only.

Test Configuration

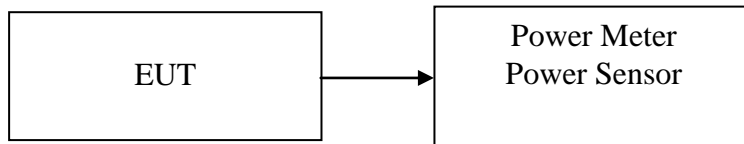

TEST PROCEDURE

The transmitter output is connected to the Power Meter. The Power Meter is set to the avg power detection.

TEST RESULTS

No non-compliance noted.

Test Data

Channel	Frequency (MHz)	Output Power (dBm)	Output Power (W)
Low	2405	15.94	0.0393
Mid	2440	16.01	0.0399
High	2480	15.14	0.0327

7.4 BAND EDGES MEASUREMENT

LIMIT

According to §15.247(d), in any 100 kHz bandwidth outside the frequency bands in which the spread spectrum intentional radiator is operating, the radio frequency power that is produced by the intentional radiator shall be at least 20 dB below that in the 100 kHz bandwidth within the band that contains the highest level of the desired power, based on either an RF conducted or a radiated measurement, provided the transmitter demonstrates compliance with the peak conducted power limits. In addition, radiated emissions which fall in the restricted bands, as defined in §15.205(a), must also comply with the radiated emission limits specified in 15.209(a) (see Section 15.205(c)).

Test Configuration

For Radiated

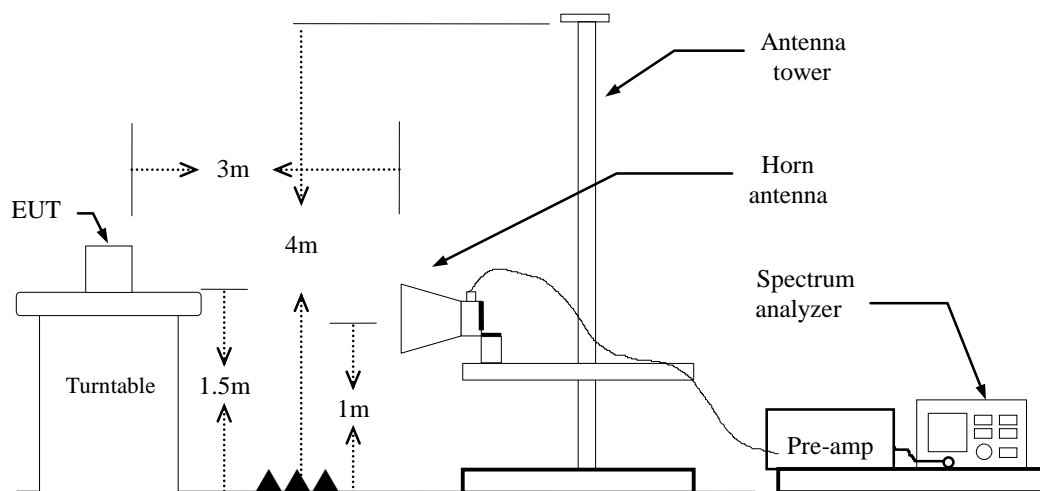

TEST PROCEDURE

For Radiated

1. The EUT is placed on a turntable, which is 1.5m above the ground plane.
2. The turntable shall be rotated for 360 degrees to determine the position of maximum emission level.
3. EUT is set 3m away from the receiving antenna, which is varied from 1m to 4m to find out the highest emission.
4. Set the spectrum analyzer in the following setting in order to capture the lower and upper band-edges of the emission:
 - (a) PEAK: RBW=1MHz / VBW=3MHz / Sweep=AUTO
 - (b) AVERAGE: RBW=1MHz,
if duty cycle $\geq 98\%$, VBW=10Hz.
if duty cycle $< 98\%$ VBW=1/T.
Zigbee: $\geq 98\%$, VBW=10Hz
5. Repeat the procedures until all the PEAK and AVERAGE versus POLARIZATION are measured.
6. Result = Spectrum Reading + cable loss(spectrum to Amp) - Amp Gain + Cable loss(Amp to receive Ant)+ Receive Ant

For Un-restricted Band Emissions

The peak output power procedure is used to measure the fundamental emission power to demonstrate compliance to requirements, then the peak conducted output power measured within any 100 kHz outside the authorized frequency band shall be attenuated by at least 20 dB relative to the maximum measured in-band peak PSD level.

TEST RESULTS

Refer to attach spectrum analyzer data chart.

Band Edges (CH Low)

Detector mode: Peak

Polarity: Ver.

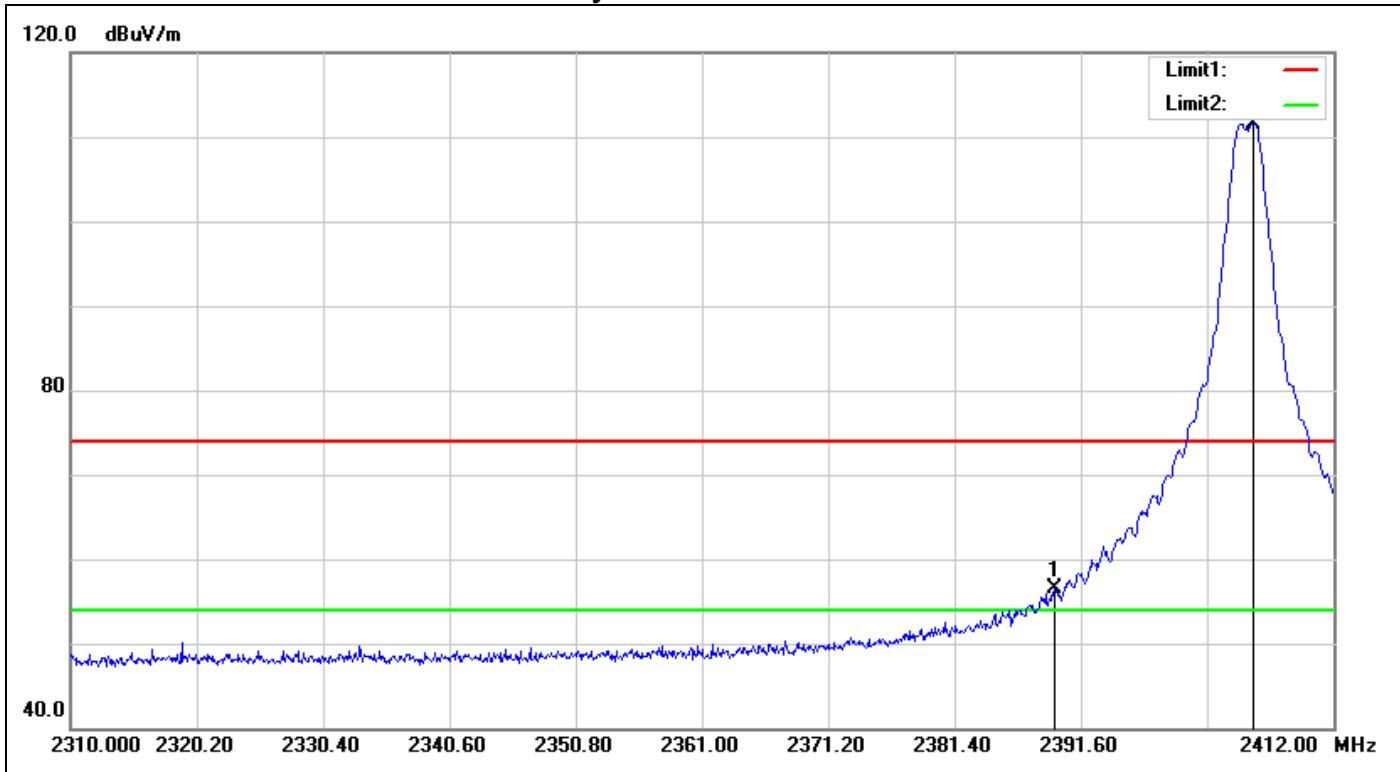

No.	Frequency (MHz)	Reading (dBuV)	Correct Factor(dB/m)	Result (dBuV/m)	Limit (dBuV/m)	Margin (dB)	Remark
1	2389.458	58.93	-2.49	56.44	74.00	-17.56	peak
2	2405.574	113.96	-2.42	111.54	-	-	peak

Detector mode: Peak Polarity: Hor.

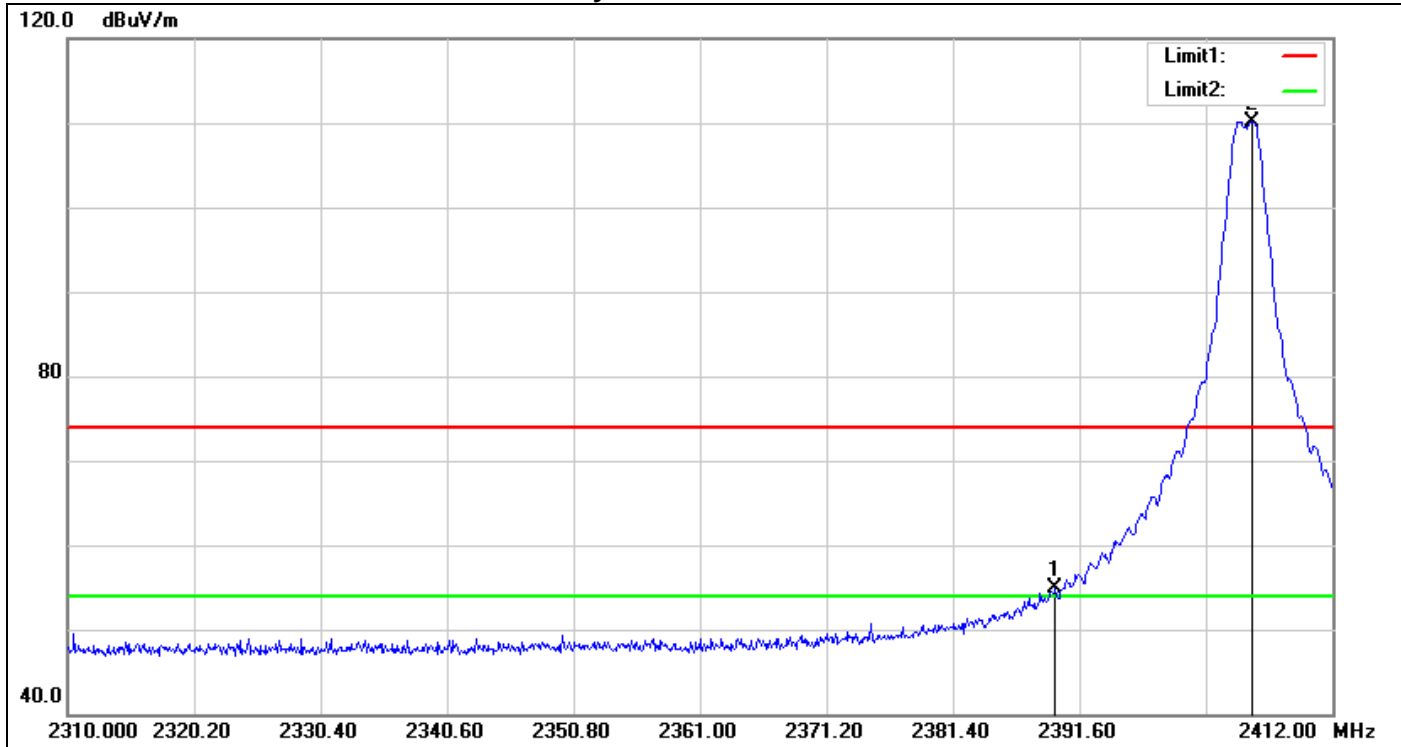

No.	Frequency (MHz)	Reading (dBuV)	Correct Factor(dB/m)	Result (dBuV/m)	Limit (dBuV/m)	Margin (dB)	Remark
1	2389.662	57.30	-2.49	54.81	74.00	-19.19	peak
2	2405.472	112.61	-2.42	110.19	-	-	peak

Detector mode: Averag Polarity: Ver.

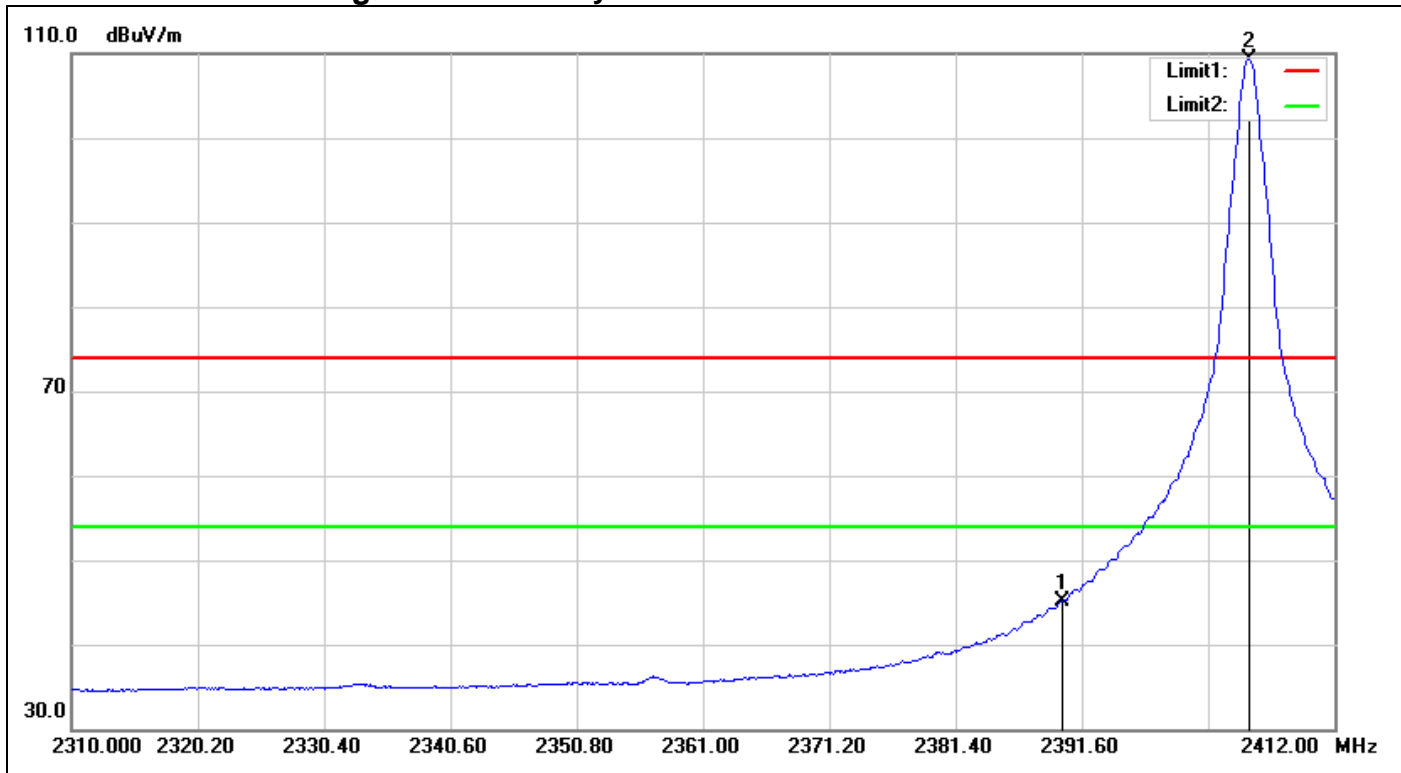

No.	Frequency (MHz)	Reading (dBuV)	Correct Factor(dB/m)	Result (dBuV/m)	Limit (dBuV/m)	Margin (dB)	Remark
1	2390.000	47.66	-2.49	45.17	54.00	-8.83	AVG
2	2405.064	111.71	-2.42	109.29	-	-	AVG

Detector mode: Averag Polarity: Hor.

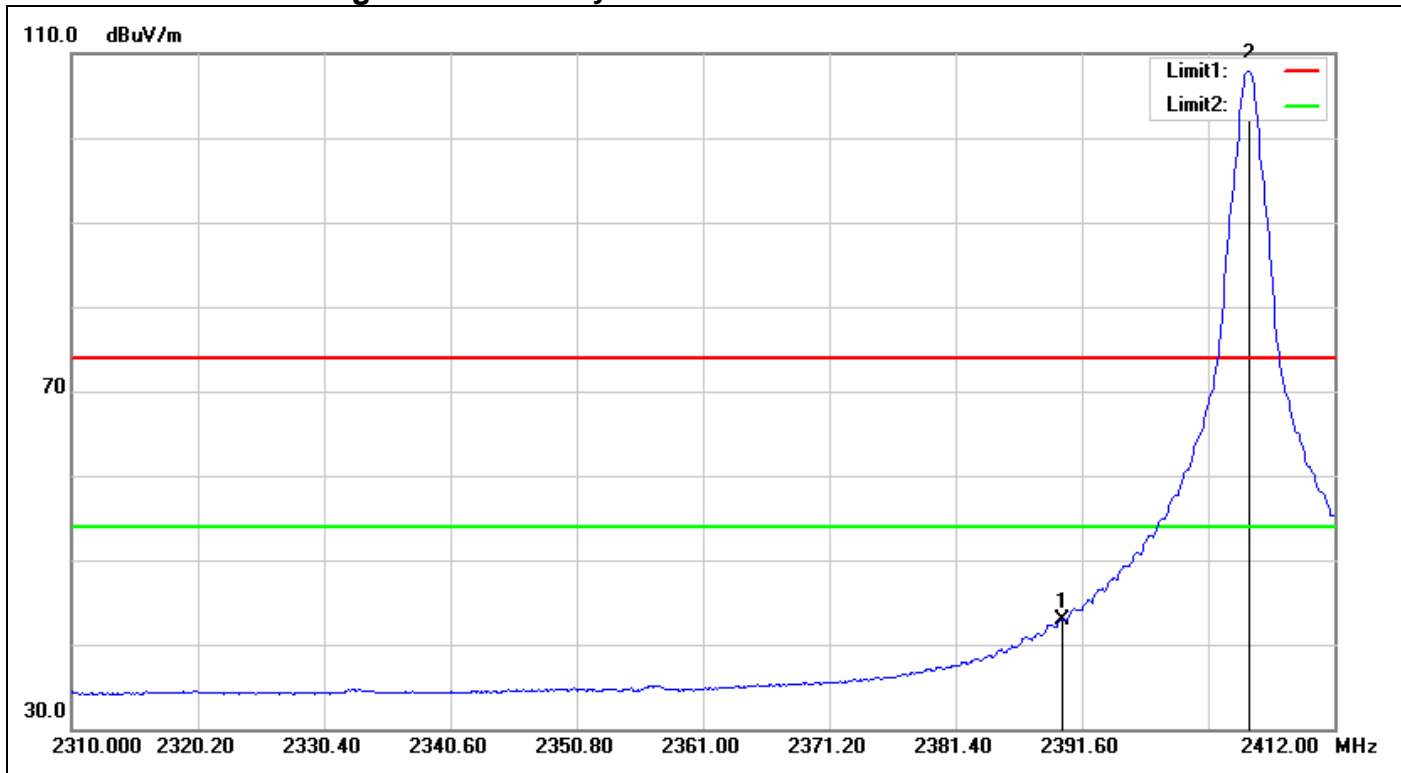

No.	Frequency (MHz)	Reading (dBuV)	Correct Factor(dB/m)	Result (dBuV/m)	Limit (dBuV/m)	Margin (dB)	Remark
1	2390.000	45.47	-2.49	42.98	74.00	-31.02	AVG
2	2405.064	110.40	-2.42	107.98	-	-	AVG

Band Edges (CH Mid)

Detector mode: Peak

Polarity: Ver.

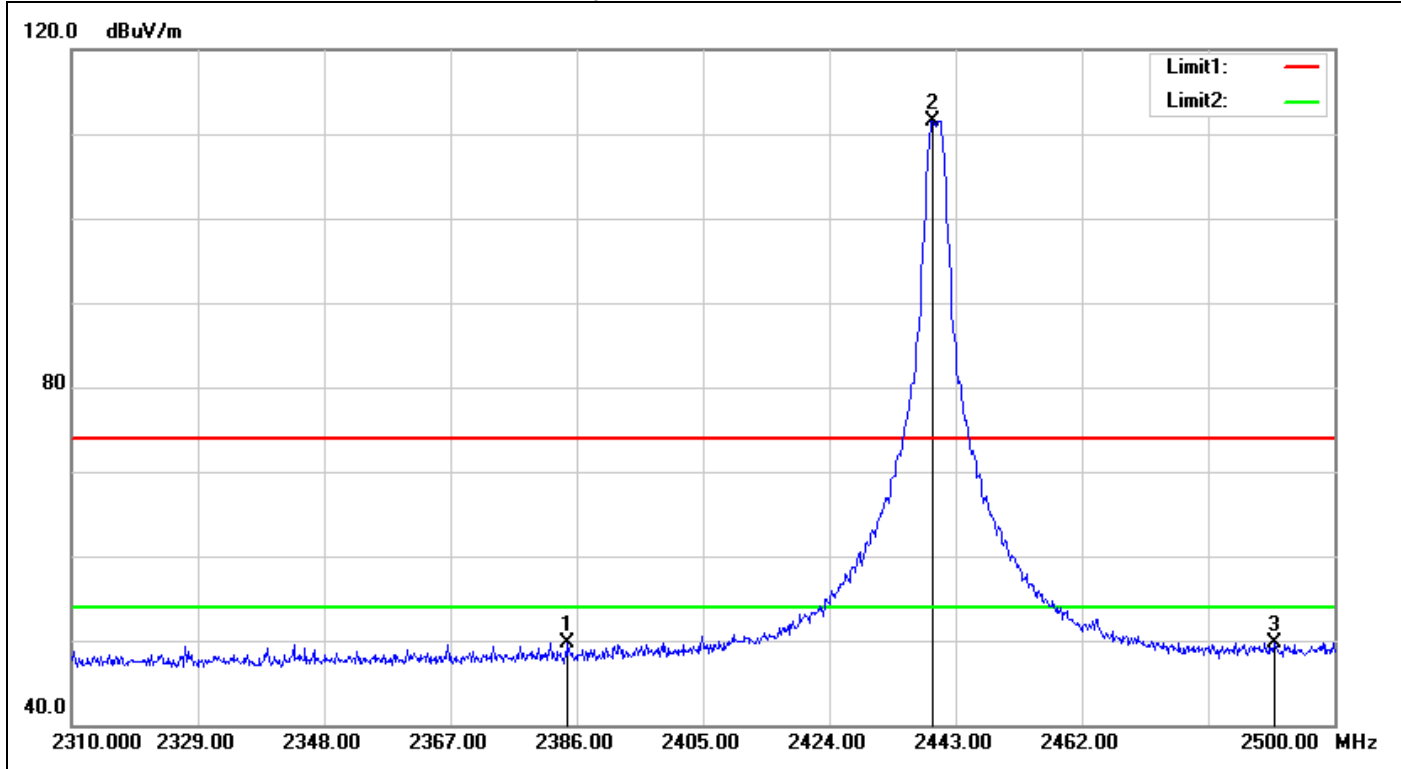

No.	Frequency (MHz)	Reading (dBuV)	Correct Factor(dB/m)	Result (dBuV/m)	Limit (dBuV/m)	Margin (dB)	Remark
1	2384.670	52.27	-2.54	49.73	74.00	-24.27	peak
2	2439.580	113.73	-2.22	111.51	-	-	peak
3	2490.880	51.70	-1.92	49.78	74.00	-24.22	peak

Detector mode: Peak Polarity: Hor.

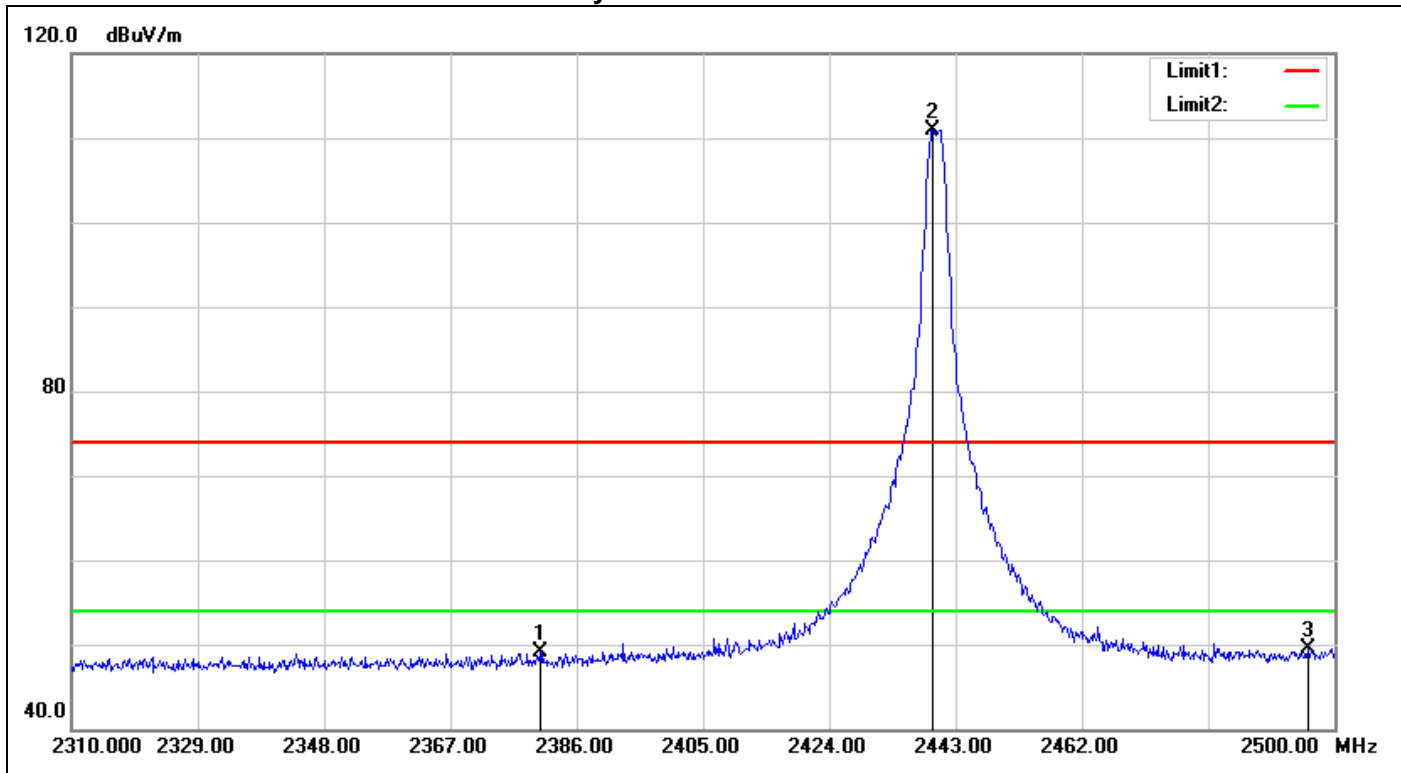

No.	Frequency (MHz)	Reading (dBuV)	Correct Factor(dB/m)	Result (dBuV/m)	Limit (dBuV/m)	Margin (dB)	Remark
1	2380.490	51.69	-2.58	49.11	74.00	-24.89	peak
2	2439.580	113.16	-2.22	110.94	-	-	peak
3	2496.010	51.33	-1.89	49.44	74.00	-24.56	peak

Detector mode: Averag Polarity: Ver.

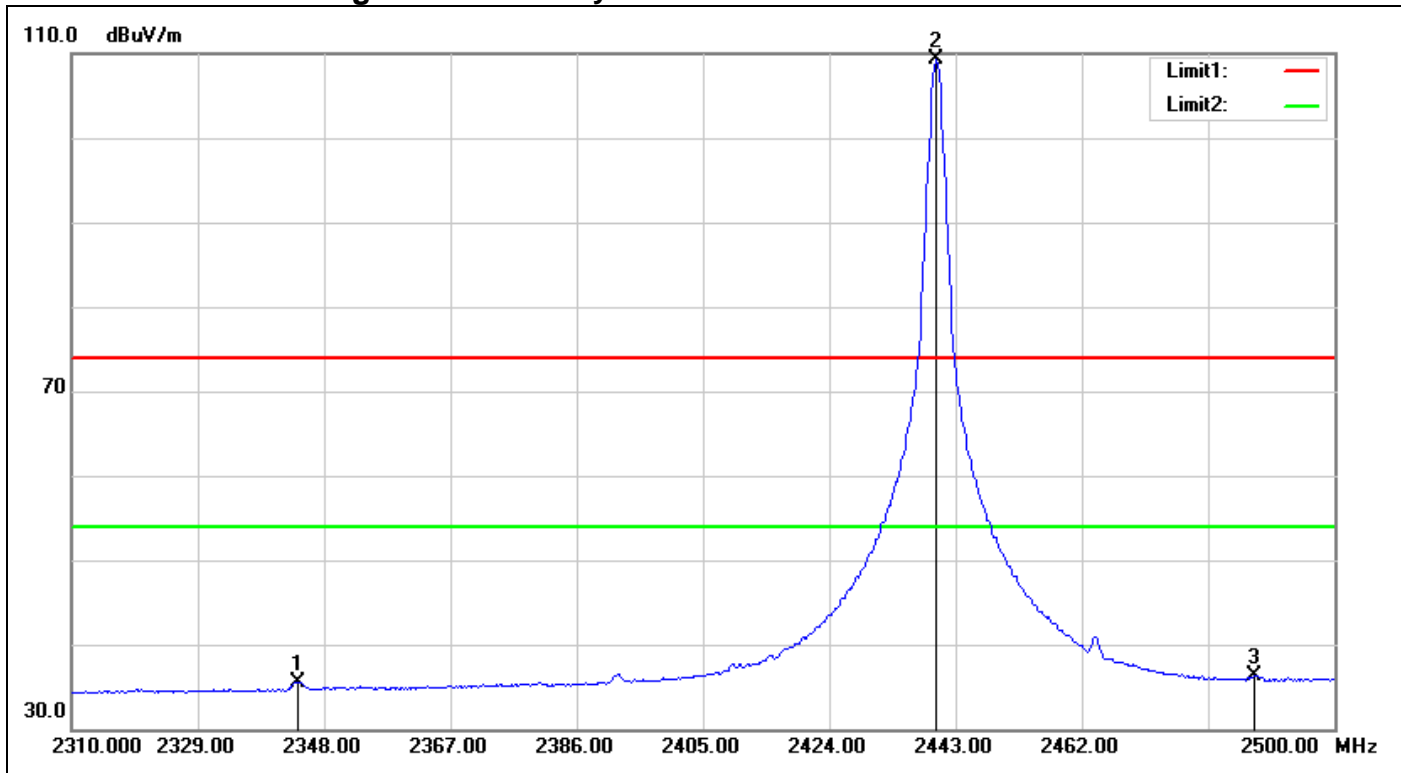

No.	Frequency (MHz)	Reading (dBuV)	Correct Factor(dB/m)	Result (dBuV/m)	Limit (dBuV/m)	Margin (dB)	Remark
1	2344.010	38.41	-2.90	35.51	54.00	-18.49	AVG
2	2440.150	111.42	-2.21	109.21	-	-	AVG
3	2487.840	38.22	-1.95	36.27	54.00	-17.73	AVG

Detector mode: Averag Polarity: Hor.

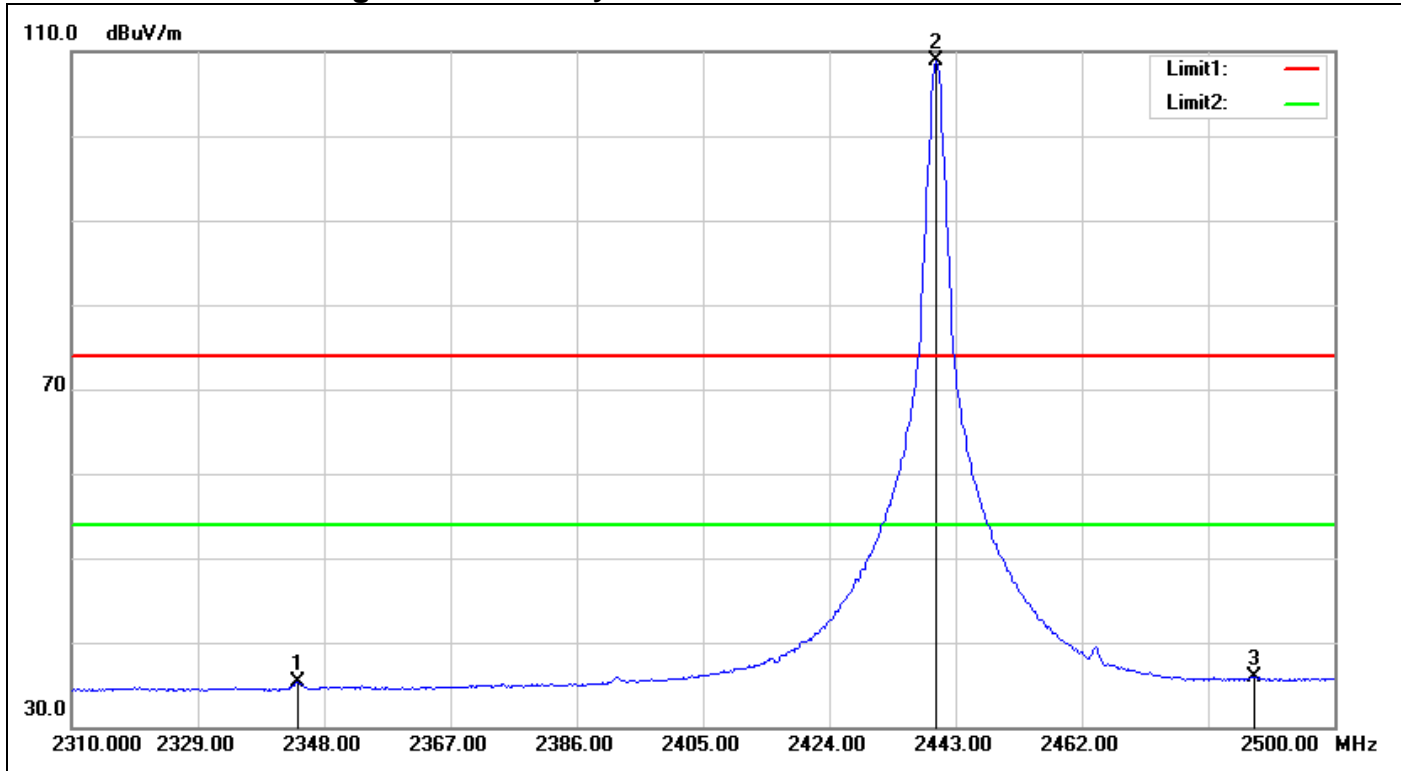

No.	Frequency (MHz)	Reading (dBuV)	Correct Factor(dB/m)	Result (dBuV/m)	Limit (dBuV/m)	Margin (dB)	Remark
1	2344.010	38.23	-2.90	35.33	54.00	-18.67	AVG
2	2440.150	111.07	-2.21	108.86	-	-	AVG
3	2487.840	37.92	-1.95	35.97	54.00	-18.03	AVG

Band Edges (CH High)

Detector mode: Peak

Polarity: Ver.

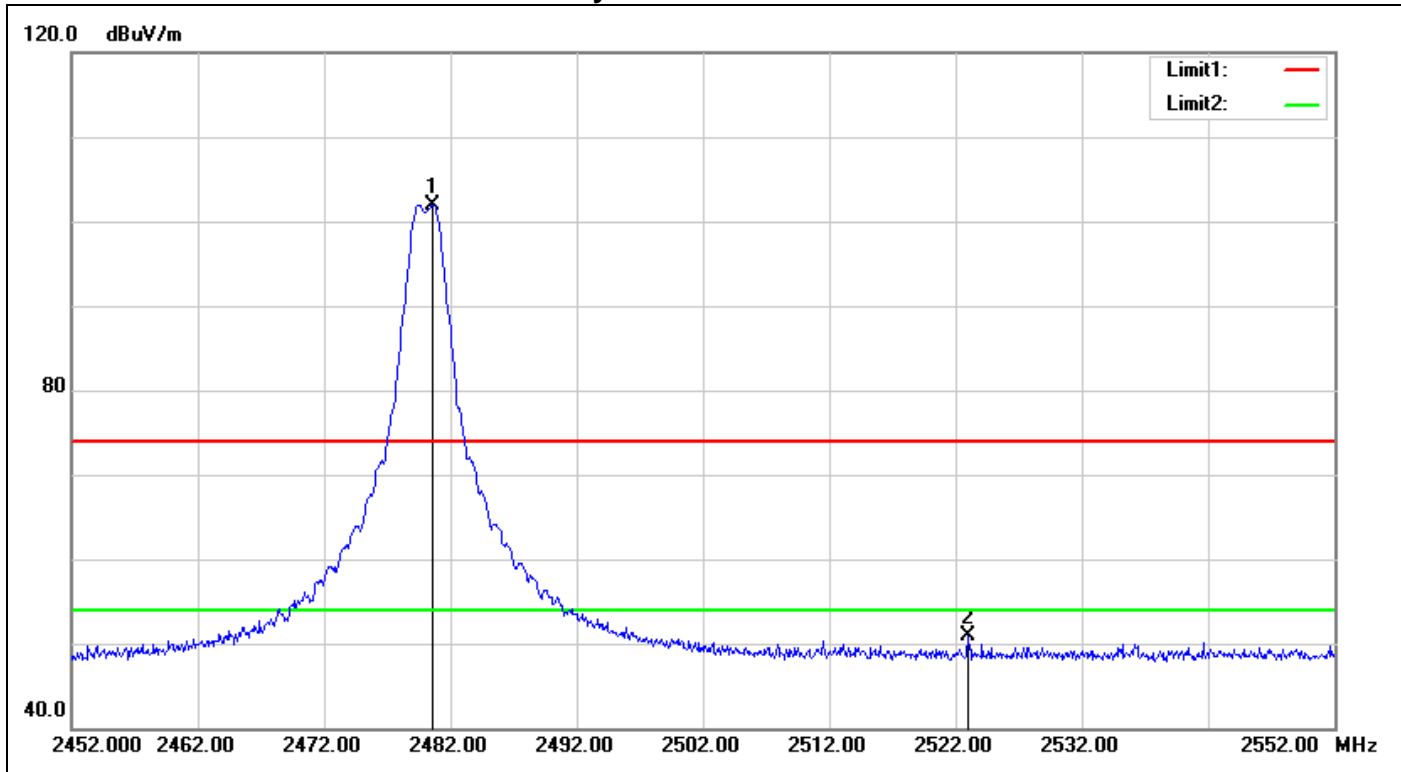

No.	Frequency (MHz)	Reading (dBuV)	Correct Factor(dB/m)	Result (dBuV/m)	Limit (dBuV/m)	Margin (dB)	Remark
1	2480.600	103.97	-2.02	101.95	-	-	peak
2	2523.000	52.63	-1.80	50.83	74.00	-23.17	peak

Detector mode: Peak Polarity: Hor.

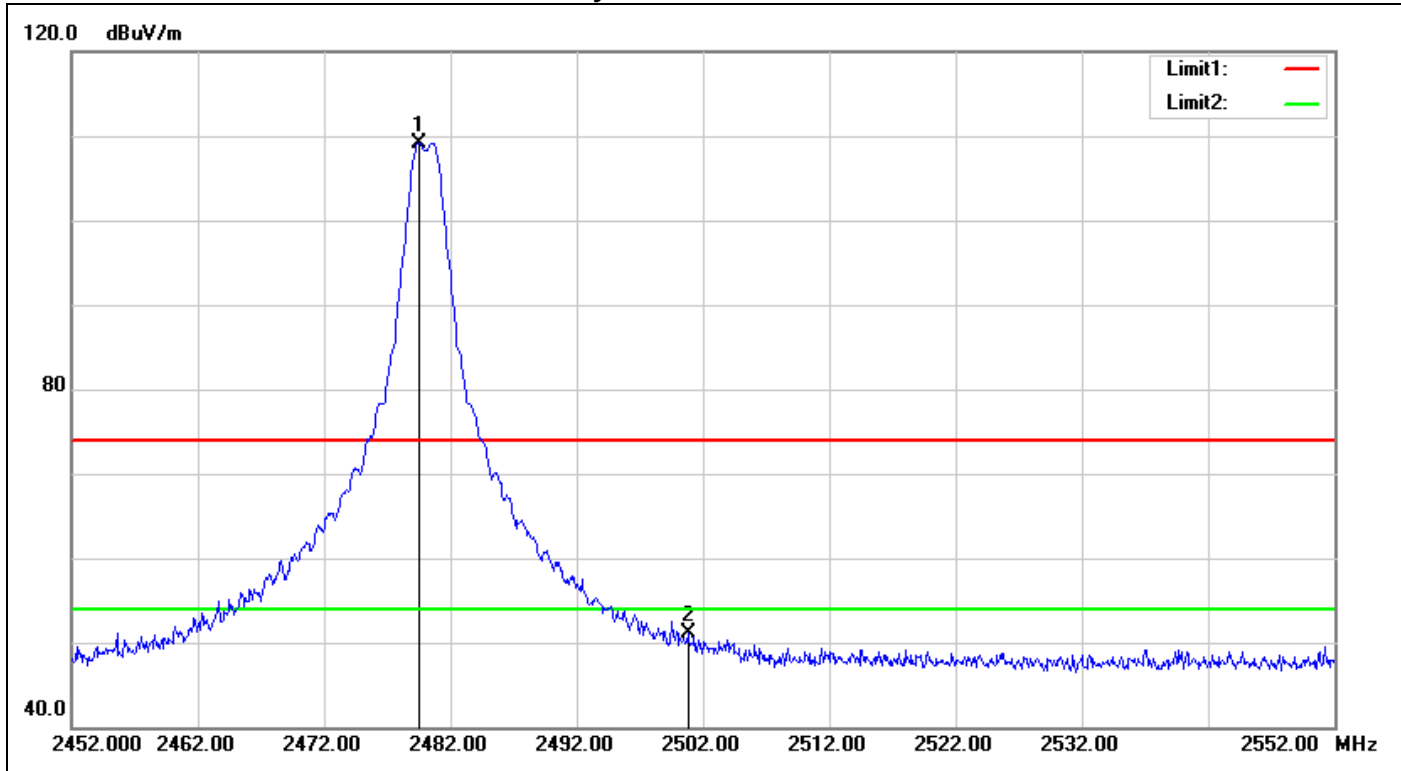

No.	Frequency (MHz)	Reading (dBuV)	Correct Factor(dB/m)	Result (dBuV/m)	Limit (dBuV/m)	Margin (dB)	Remark
1	2479.500	111.15	-2.03	109.12	-	-	peak
2	2500.800	52.87	-1.86	51.01	74.00	-22.99	peak

Detector mode: Averag Polarity: Ver.

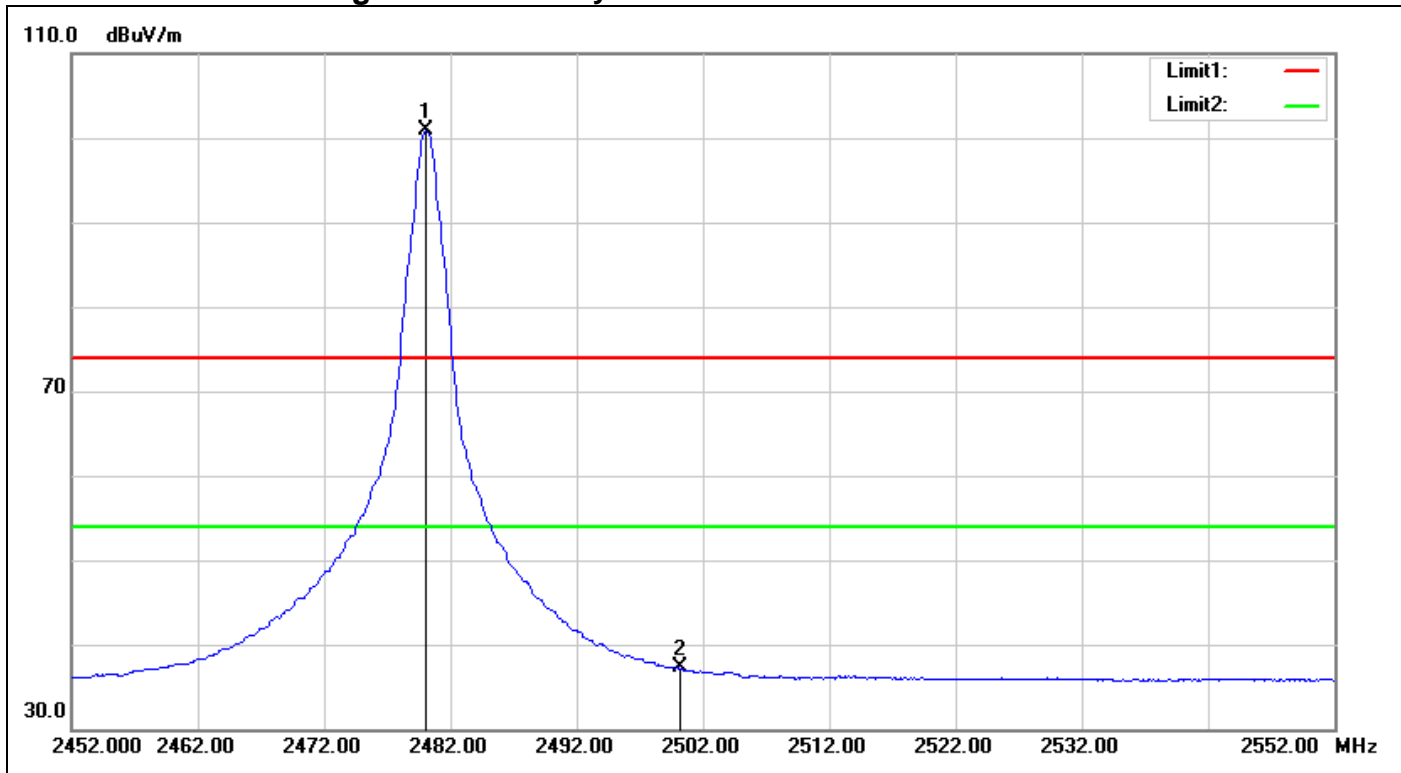

No.	Frequency (MHz)	Reading (dBuV)	Correct Factor(dB/m)	Result (dBuV/m)	Limit (dBuV/m)	Margin (dB)	Remark
1	2480.100	102.84	-2.03	100.81	-	-	AVG
2	2500.200	39.06	-1.86	37.20	54.00	-16.80	AVG

Detector mode: Averag Polarity: Hor.

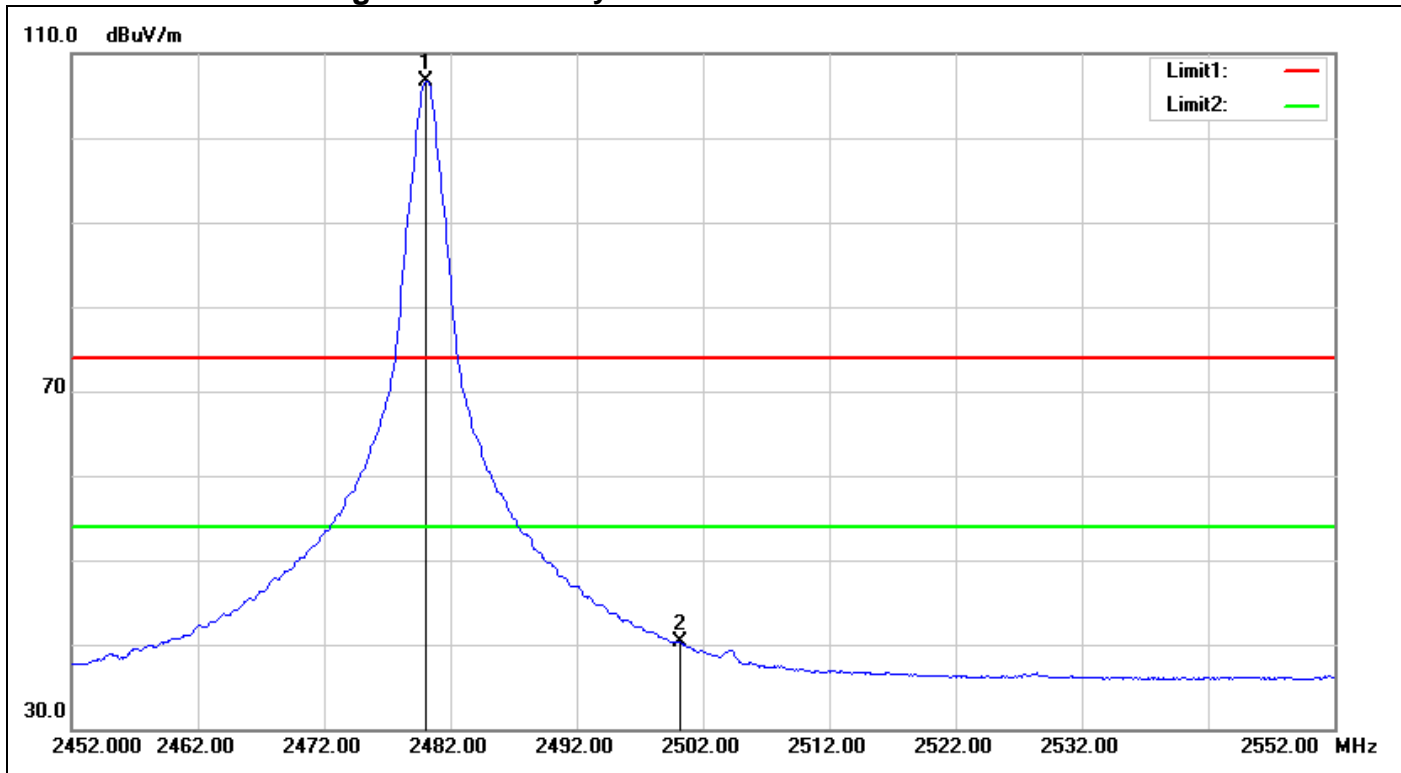

No.	Frequency (MHz)	Reading (dBuV)	Correct Factor(dB/m)	Result (dBuV/m)	Limit (dBuV/m)	Margin (dB)	Remark
1	2480.100	108.73	-2.03	106.70	-	-	AVG
2	2500.200	42.16	-1.86	40.30	54.00	-13.70	AVG

Test Plot

Un-restricted Band Emissions / CH Low Polarity: Ver.

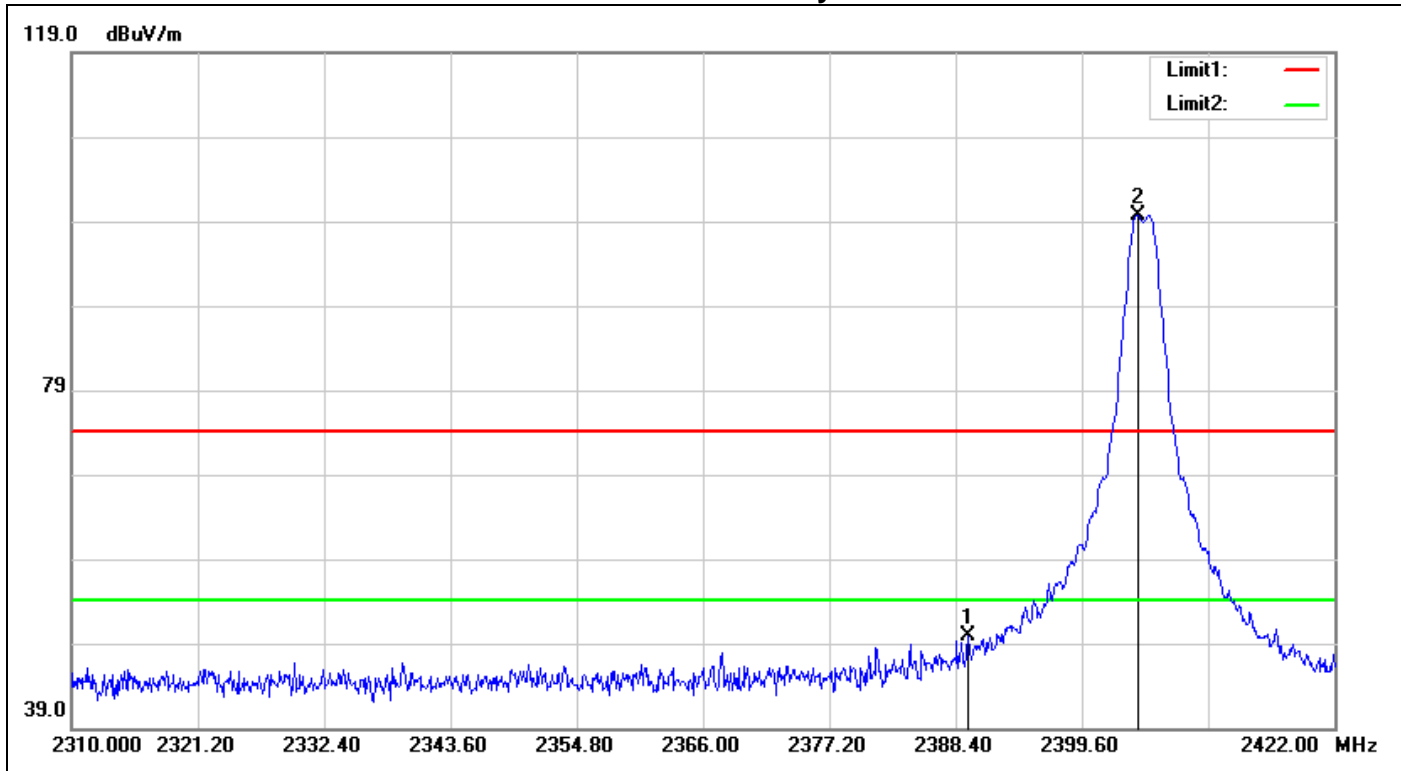

No.	Frequency (MHz)	Reading (dBuV)	Correct Factor(dB/m)	Result (dBuV/m)	Limit (dBuV/m)	Margin (dB)	Remark
1	2389.520	52.36	-2.49	49.87	74.00	-24.13	peak
2	2404.528	102.13	-2.42	99.71	74.00	25.71	peak

Note: Spurious emission levels that exceed the level of 20 dB below the applicable limit.

Un-restricted Band Emissions / CH Low Polarity: Hor.

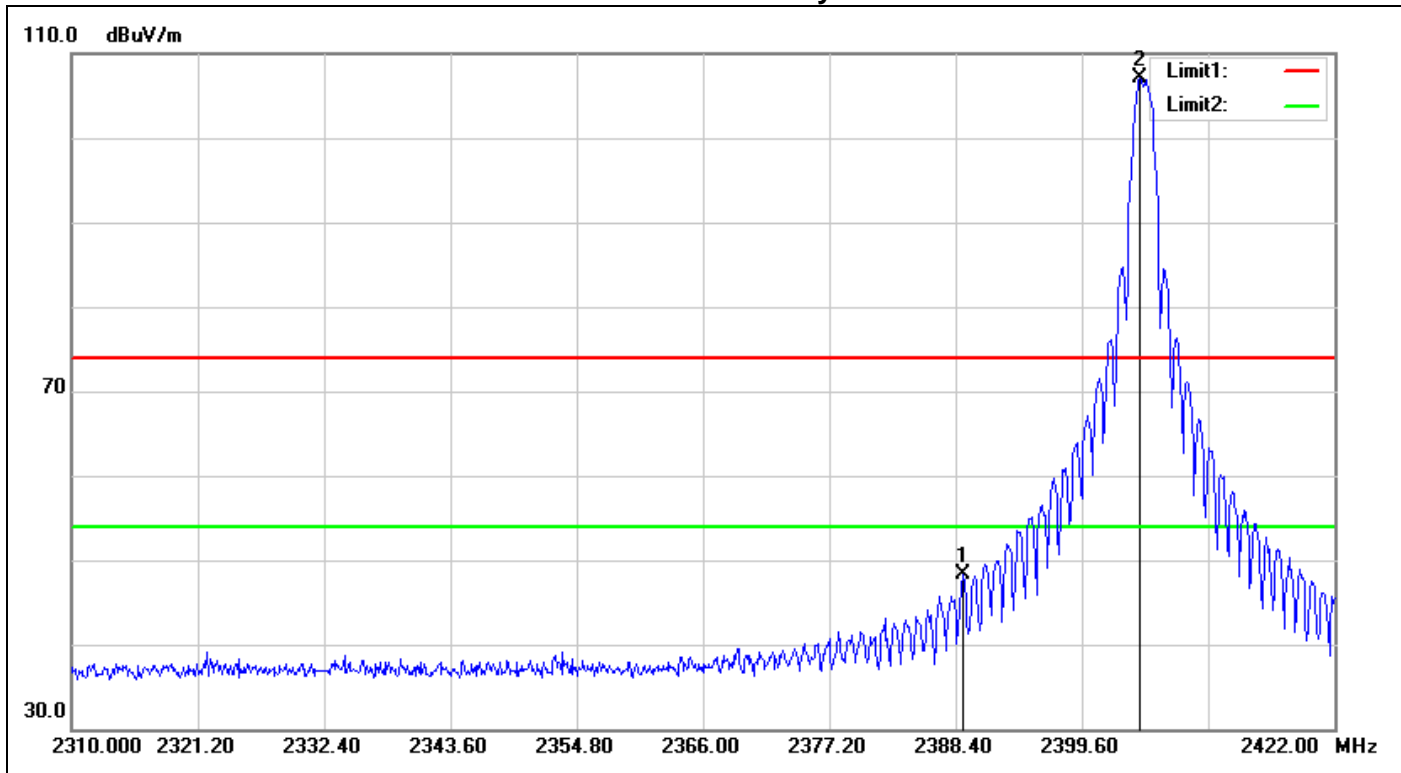

No.	Frequency (MHz)	Reading (dBuV)	Correct Factor(dB/m)	Result (dBuV/m)	Limit (dBuV/m)	Margin (dB)	Remark
1	2389.072	50.70	-2.50	48.20	74.00	-25.80	peak
2	2404.752	109.56	-2.42	107.14	74.00	33.14	peak

Note: Spurious emission levels that exceed the level of 20 dB below the applicable limit.

Un-restricted Band Emissions / CH Low Polarity: Ver.

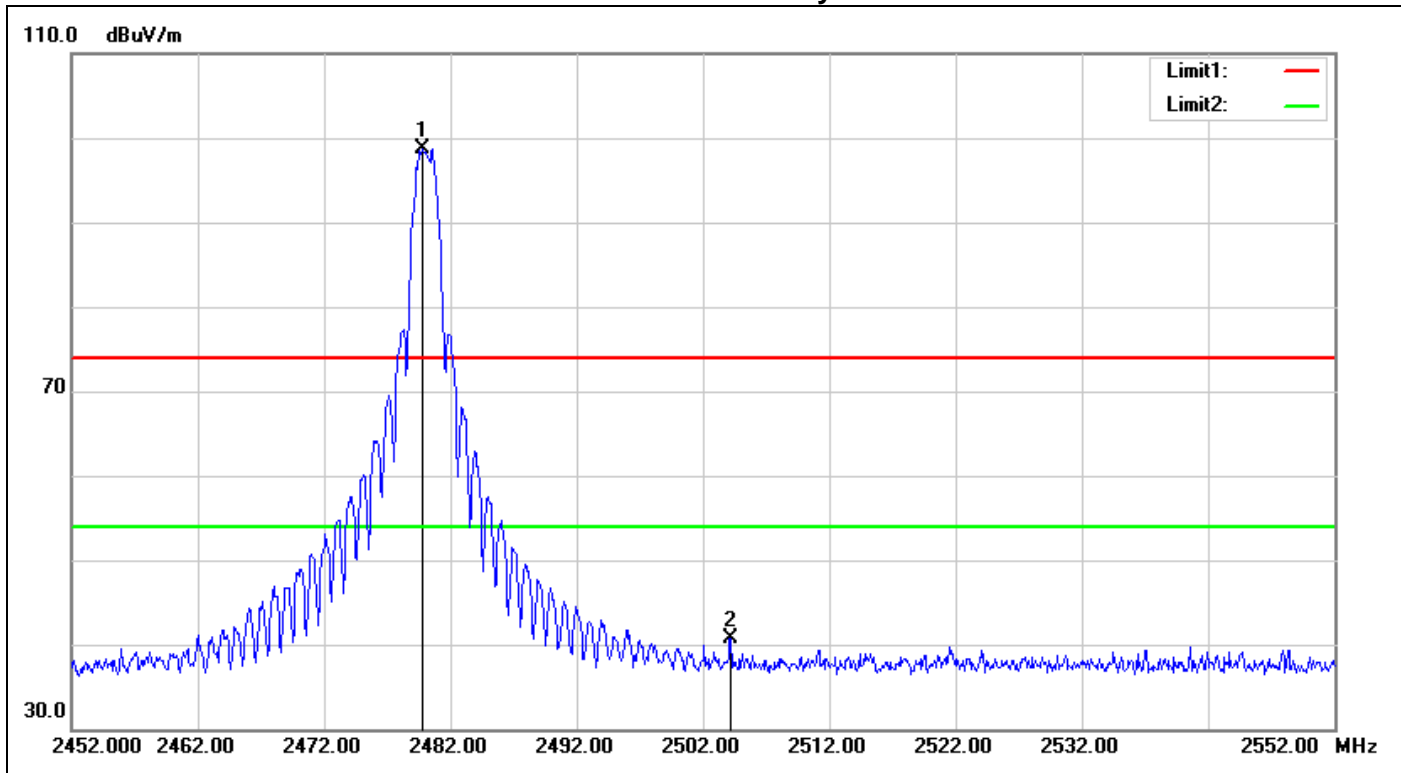

No.	Frequency (MHz)	Reading (dBuV)	Correct Factor(dB/m)	Result (dBuV/m)	Limit (dBuV/m)	Margin (dB)	Remark
1	2479.800	100.80	-2.03	98.77	74.00	24.77	peak
2	2504.200	42.57	-1.85	40.72	74.00	-33.28	peak

Note: Spurious emission levels that exceed the level of 20 dB below the applicable limit.

Un-restricted Band Emissions / CH Low Polarity: Hor.

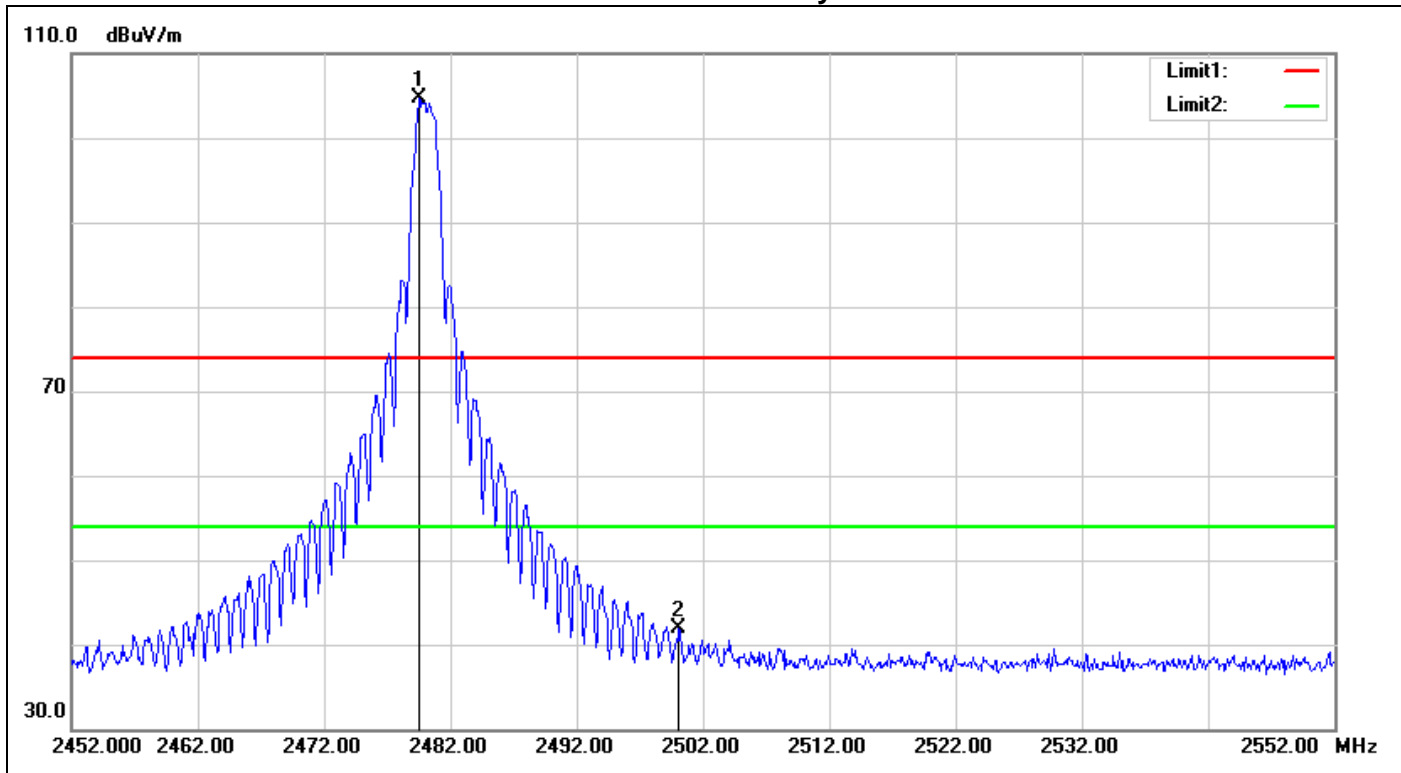

No.	Frequency (MHz)	Reading (dBuV)	Correct Factor(dB/m)	Result (dBuV/m)	Limit (dBuV/m)	Margin (dB)	Remark
1	2479.500	106.76	-2.03	104.73	74.00	30.73	peak
2	2500.100	43.67	-1.86	41.81	74.00	-32.19	peak

Note: Spurious emission levels that exceed the level of 20 dB below the applicable limit.

7.5 PEAK POWER SPECTRAL DENSITY

LIMIT

1. According to §15.247(e), for digitally modulated systems, the power spectral density conducted from the intentional radiator to the antenna shall not be greater than 8 dBm in any 3 kHz band during any time interval of continuous transmission.
2. According to §15.247(f), the digital modulation operation of the hybrid system, with the frequency hopping turned off, shall comply with the power density requirements of paragraph (d) of this section.

Test Configuration

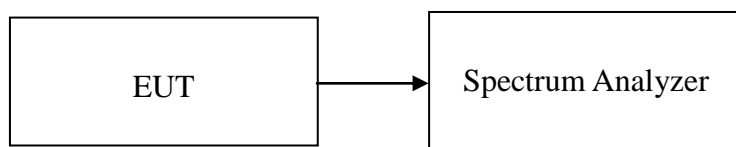

TEST PROCEDURE

1. Place the EUT on the table and set it in transmitting mode.
Remove the antenna from the EUT and then connect a low loss RF cable from the antenna port to the spectrum analyzer.
2. Set the spectrum analyzer as RBW = 3 kHz, VBW = 30 kHz, Span = 1.5 times the bandwidth , Sweep time = auto
3. Record the max reading.
4. Repeat the above procedure until the measurements for all frequencies are completed.

TEST RESULTS

No non-compliance noted

Test Data

Channel	Frequency (MHz)	PPSD (dBm)	Limit (dBm)	Test Result
Low	2405	1.52	8.00	PASS
Mid	2440	1.79		PASS
High	2480	0.03		PASS

Test Plot

PPSD (CH Low)

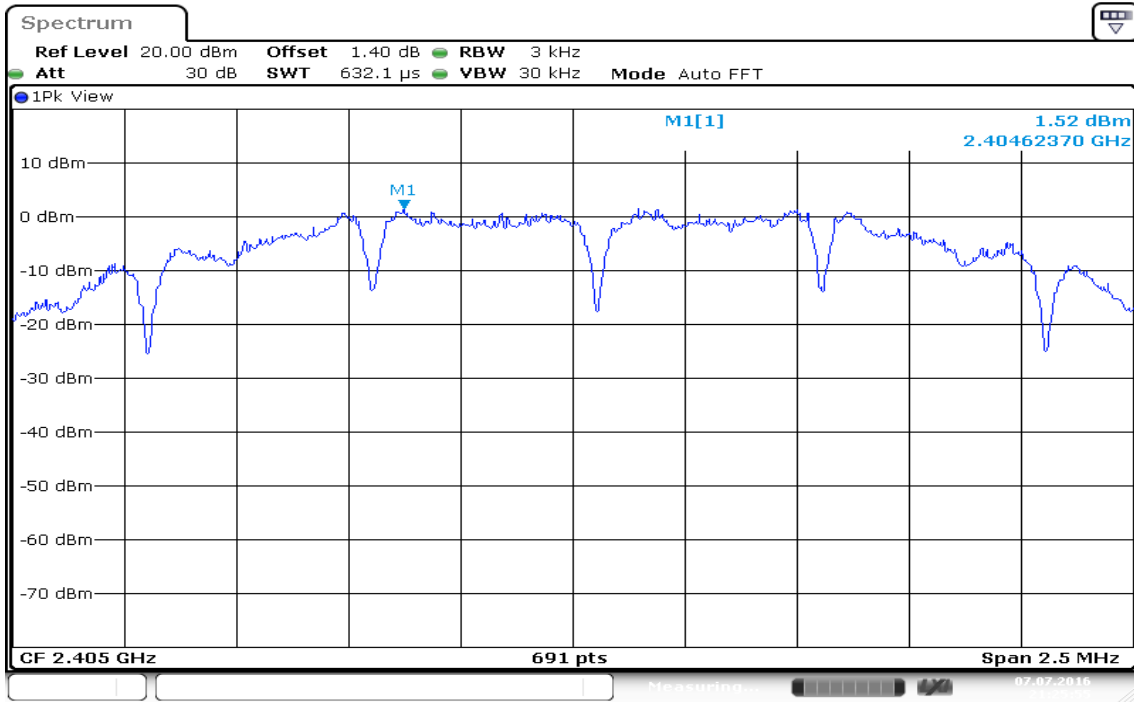

Date: 7 JUL 2016 21:25:55

PPSD (CH Mid)

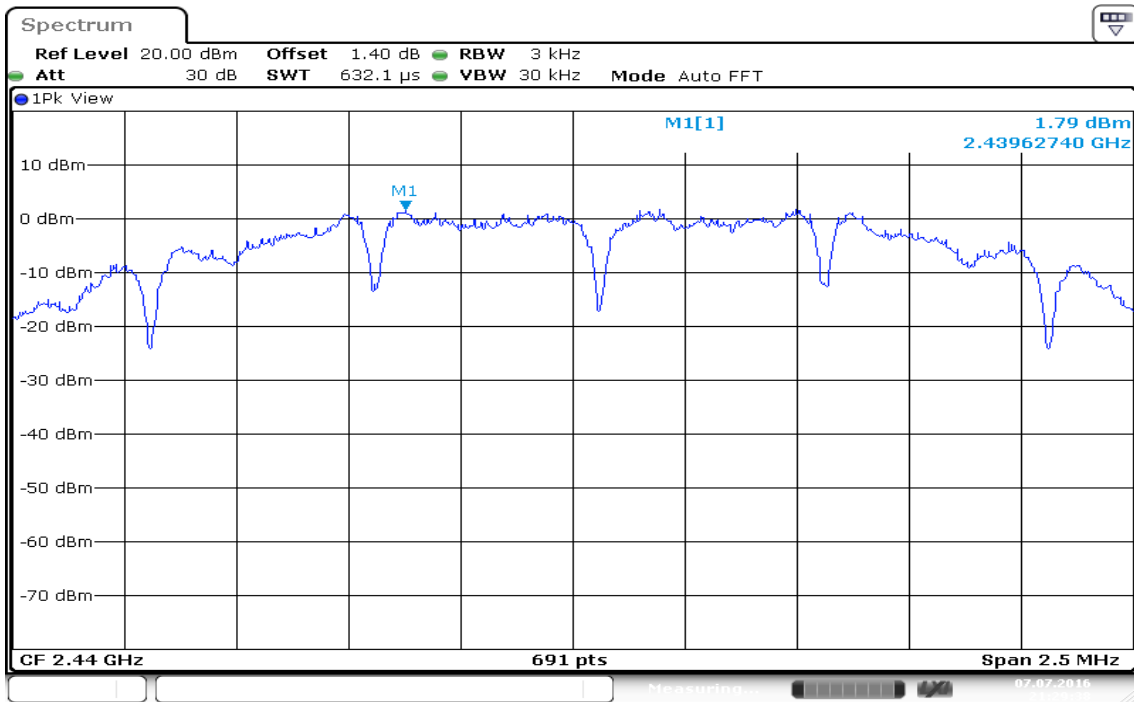

Date: 7 JUL 2016 21:29:38

PPSD (CH High)

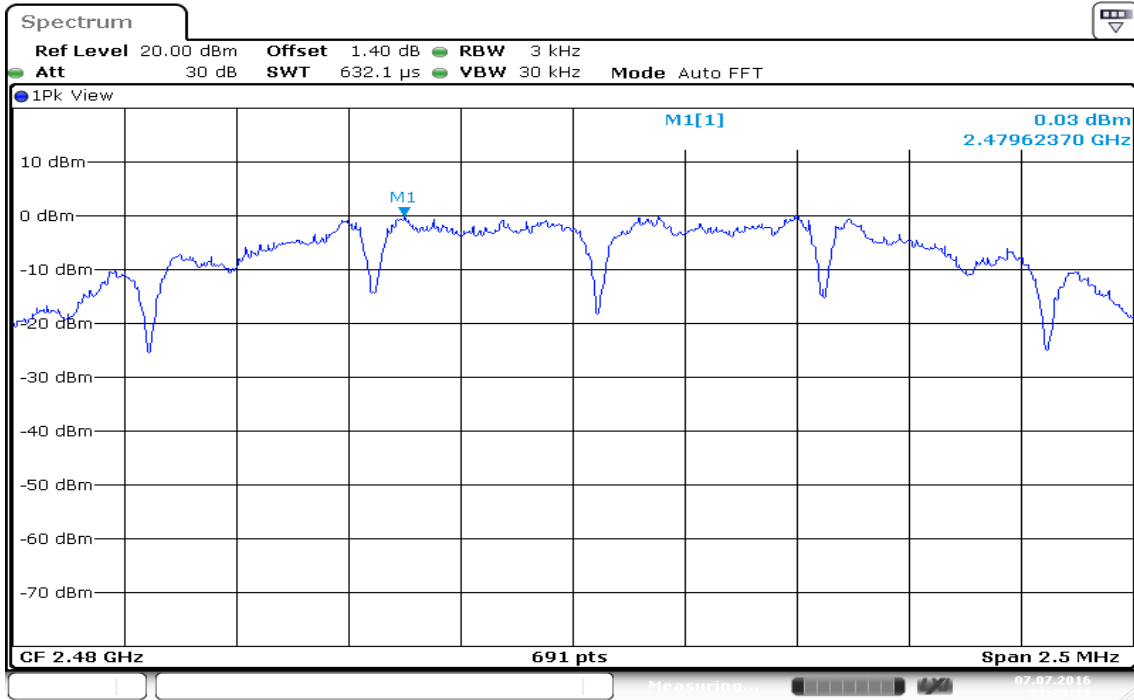

Date: 7 JUL 2016 21:33:11

7.6 RADIATED EMISSIONS

LIMIT

1. According to §15.209(a), except as provided elsewhere in this Subpart, the emissions from an intentional radiator shall not exceed the field strength levels specified in the following table:

Frequency (MHz)	Field Strength (µV/m)	Measurement Distance (m)
0.009 - 0.490	2400/F(kHz)	300
0.490 - 1.705	24000/F(kHz)	30
1.705 – 30.0	30	30
30-88	100	3
88-216	150	3
216-960	200	3
Above 960	500	3

Remark: Except as provided in paragraph (g), fundamental emissions from intentional radiators operating under this Section shall not be located in the frequency bands 54-72 MHz, 76-88 MHz, 174-216 MHz or 470-806 MHz. However, operation within these frequency bands is permitted under other sections of this Part, e.g., Sections 15.231 and 15.241.

2. In the emission table above, the tighter limit applies at the band edges.

Frequency (MHz)	Field Strength (µV/m at 3-meter)	Field Strength (dBµV/m at 3-meter)
0.009 - 0.490	2400/F(kHz) +80	20LOG((2400/F(kHz))+80)
0.490 - 1.705	24000/F(kHz) +40	20LOG((24000/F(kHz))+40)
1.705 – 30.0	30	69.54
30-88	100	40
88-216	150	43.5
216-960	200	46
Above 960	500	54

Test Configuration

9kHz ~ 30MHz

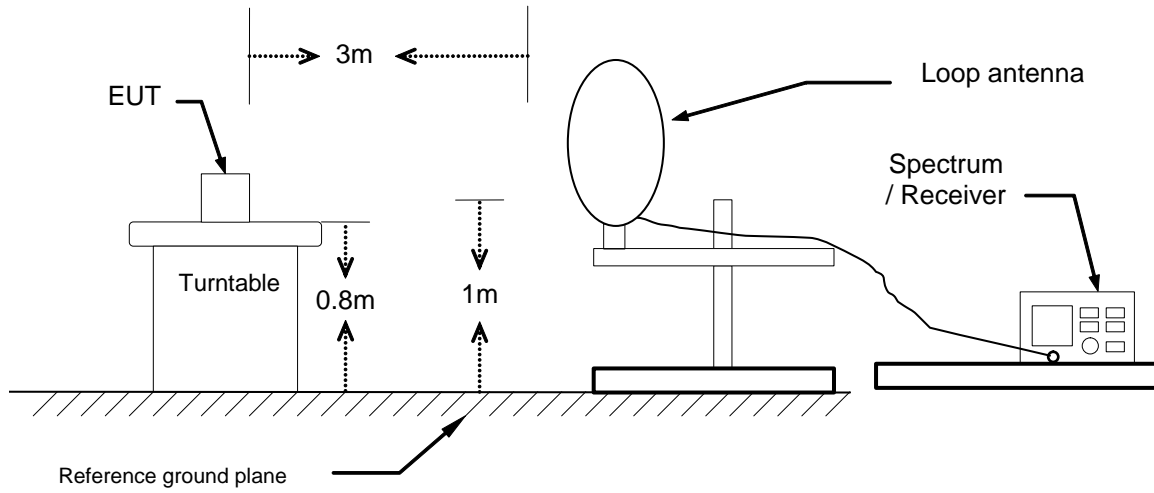

30MHz ~ 1GHz

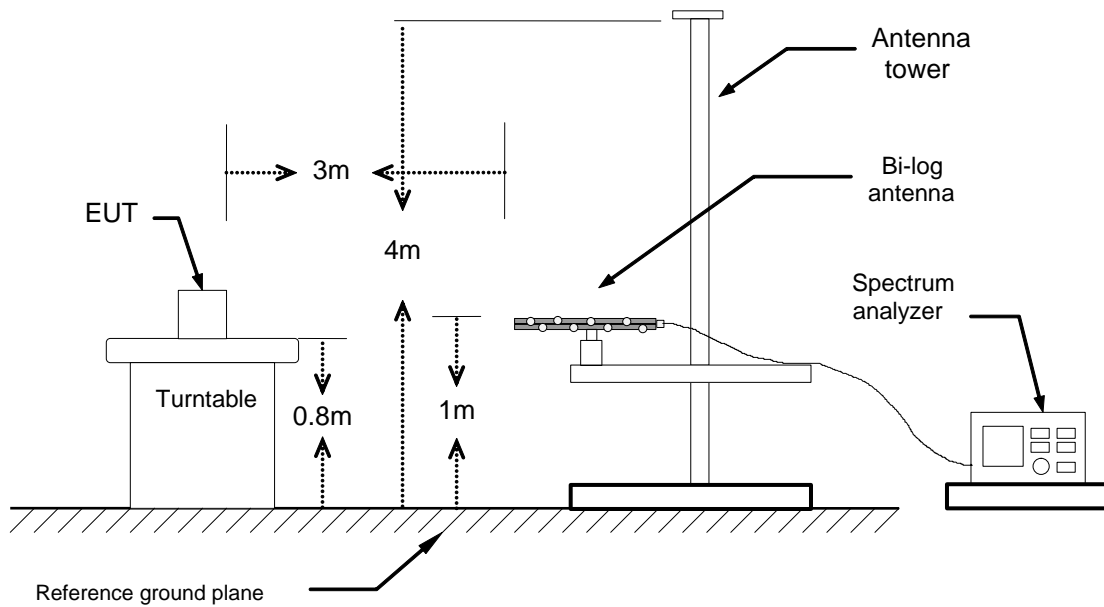

Above 1 GHz

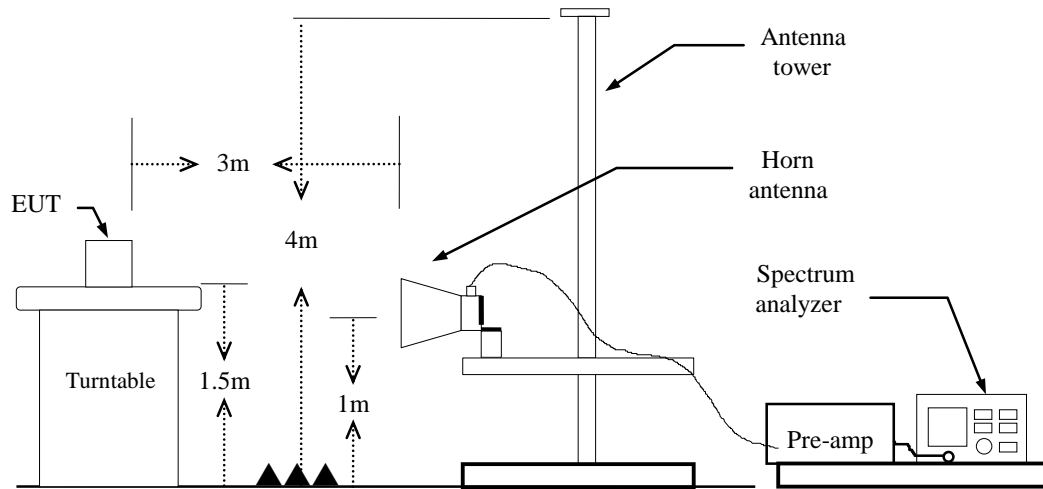

TEST PROCEDURE

1. The EUT is placed on a turntable, Above 1 GHz is 1.5m high and below 1 GHz is 0.8m high above ground plane.
2. The turntable shall be rotated for 360 degrees to determine the position of maximum emission level.
3. EUT is set 3m away from the receiving antenna, which is varied from 1m to 4m to find out the highest emissions.
4. Maximum procedure was performed on the six highest emissions to ensure EUT compliance.
5. And also, each emission was to be maximized by changing the polarization of receiving antenna both horizontal and vertical.
6. Set the spectrum analyzer in the following setting as:

Below 1GHz:

RBW=100kHz / VBW=300kHz / Sweep=AUTO

Above 1GHz:

(a) PEAK: RBW=VBW=1MHz / Sweep=AUTO

(b) AVERAGE: RBW=1MHz,
if duty cycle \geq 98%, VBW=10Hz.

if duty cycle < 98% VBW=1/T.

Zigbee: \geq 98%, VBW=10Hz

7. Repeat above procedures until the measurements for all frequencies are complete.
8. Result = Spectrum Reading + cable loss(spectrum to Amp) - Amp Gain + Cable loss(Amp to receive Ant)+ Receive Ant

Note: We checked every harmonics frequencies from Fundamental frequencies with reduced VBW, and we mark a point to prove pass or not if we find any emission. For this case, there are no emissions hidden in the noise floor.

TEST RESULTS

Below 1GHz

Operation Mode: Normal Link

Test Date: June 27, 2016

Temperature: 27°C

Tested by: Dennis Li

Humidity: 53% RH

Polarity: Ver.

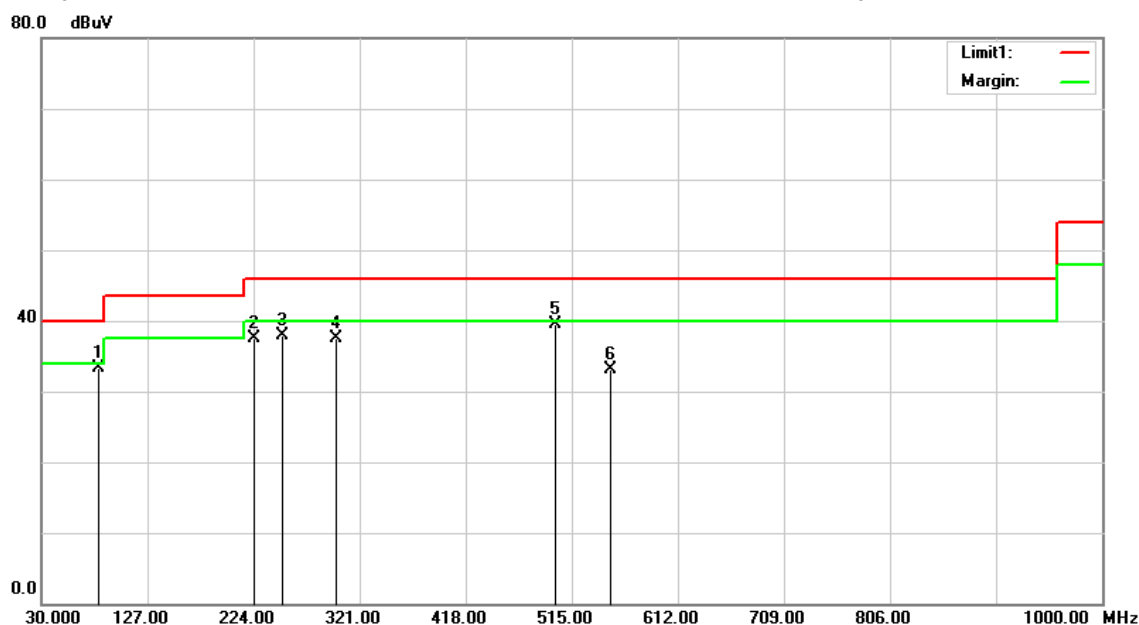

Frequency (MHz)	Reading (dBuV)	Correction Factor (dB/m)	Result (dBuV/m)	Limit (dBuV/m)	Margin (dB)	Remark	Ant. Pol. (H/V)
82.3800	54.53	-21.31	33.22	40.00	-6.78	QP	V
224.9700	54.41	-16.85	37.56	46.00	-8.44	peak	V
250.1900	54.26	-16.27	37.99	46.00	-8.01	peak	V
299.6600	51.78	-14.25	37.53	46.00	-8.47	peak	V
500.4500	48.68	-9.23	39.45	46.00	-6.55	QP	V
549.9200	41.57	-8.49	33.08	46.00	-12.92	peak	V

Remark:

1. No emission found between lowest internal used/generated frequency to 30MHz (9kHz~30MHz)
2. Radiated emissions measured in frequency range from 30 MHz to 1000MHz were made with an instrument using peak/quasi-peak detector mode.
3. Quasi-peak test would be performed if the peak result were greater than the quasi-peak limit or as required by the applicant.
4. Measurements above show only up to 6 maximum emissions noted, or would be lesser, with " N/A " remark, if no specific emissions from the EUT are recorded (ie: margin>20dB from the applicable limit) and considered that's already beyond the background noise floor.
5. Margin (dB) = Result (dBuV/m) – Limit (dBuV/m).

Operation Mode: Normal Link

Test Date: June 27, 2016

Temperature: 27°C

Tested by: Dennis Li

Humidity: 53% RH

Polarity: Hor.

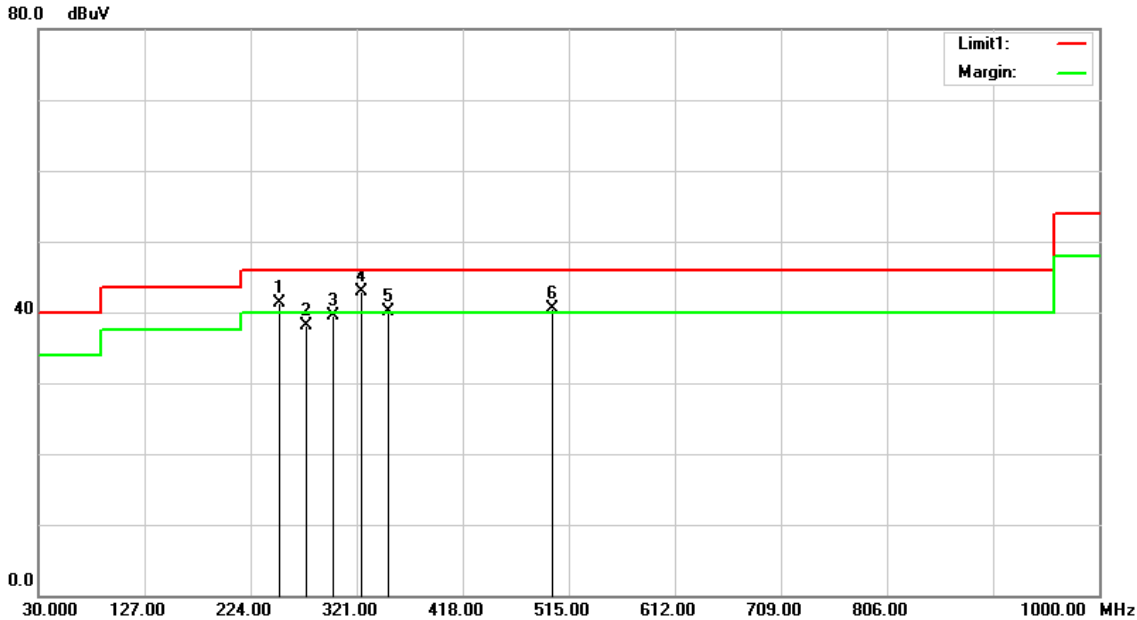

Frequency (MHz)	Reading (dBuV)	Correction Factor (dB/m)	Result (dBuV/m)	Limit (dBuV/m)	Margin (dB)	Remark	Ant. Pol. (H/V)
250.1900	57.66	-16.27	41.39	46.00	-4.61	QP	H
275.4100	52.80	-14.70	38.10	46.00	-7.90	QP	H
299.6600	53.80	-14.25	39.55	46.00	-6.45	QP	H
324.8800	56.52	-13.57	42.95	46.00	-3.05	QP	H
350.1000	53.02	-12.89	40.13	46.00	-5.87	QP	H
500.4500	49.78	-9.23	40.55	46.00	-5.45	QP	H

Remark:

1. No emission found between lowest internal used/generated frequency to 30MHz (9kHz~30MHz)
2. Radiated emissions measured in frequency range from 30 MHz to 1000MHz were made with an instrument using peak/quasi-peak detector mode.
3. Quasi-peak test would be performed if the peak result were greater than the quasi-peak limit or as required by the applicant.
4. Measurements above show only up to 6 maximum emissions noted, or would be lesser, with " N/A " remark, if no specific emissions from the EUT are recorded (ie: margin>20dB from the applicable limit) and considered that's already beyond the background noise floor.
5. Margin (dB) = Result (dBuV/m) – Limit (dBuV/m).

Above 1 GHz

Zigbee / TX / CH Low

Polarity: Vertical

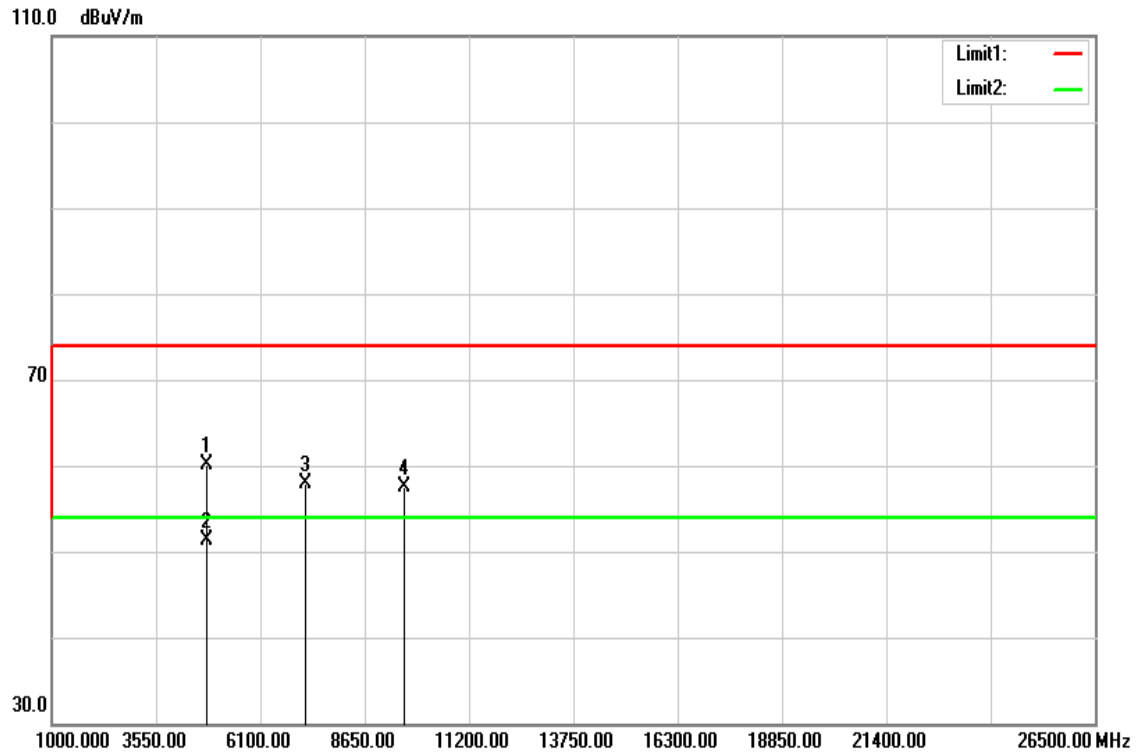

Polarity: Horizontal

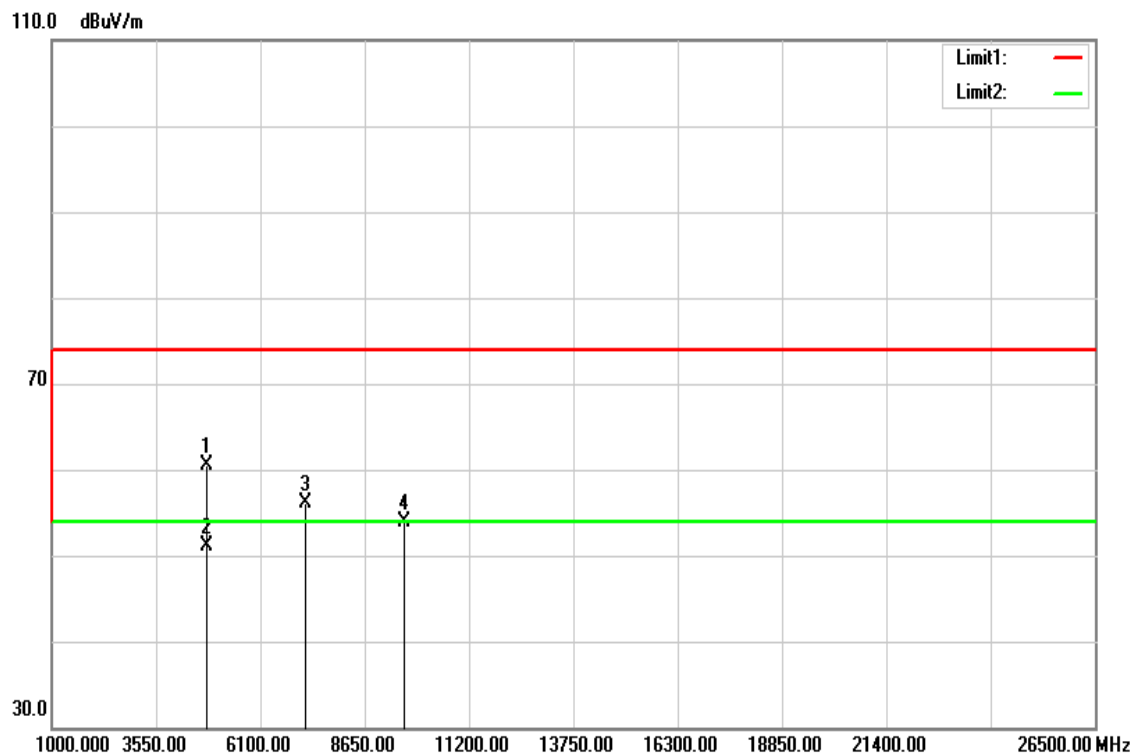

Above 1 GHz

Operation Mode: Zigbee / TX / CH Low

Test Date: July 7, 2016

Temperature: 27°C

Tested by: Dennis Li

Humidity: 53 % RH

Polarity: Ver. / Hor.

Frequency (MHz)	Reading (dBuV)	Correction (dB/m)	Result (dBuV/m)	Limit (dBuV/m)	Margin (dB)	Remark	Ant.Pol. (H/V)
4806.000	55.10	5.05	60.15	74.00	-13.85	peak	V
4806.000	46.32	5.05	51.37	54.00	-2.63	AVG	V
7214.000	45.22	12.65	57.87	74.00	-16.13	peak	V
9615.000	39.85	17.60	57.45	74.00	-16.55	peak	V
N/A							
4806.000	55.44	5.05	60.49	74.00	-13.51	peak	H
4806.000	45.97	5.05	51.02	54.00	-2.98	AVG	H
7214.000	43.55	12.65	56.20	74.00	-17.80	peak	H
9622.000	36.30	17.60	53.90	74.00	-20.10	peak	H
N/A							

Remark:

1. Measuring frequencies from 1 GHz to the 10th harmonic of highest fundamental frequency.
2. Radiated emissions measured in frequency above 1000MHz were made with an instrument using peak/average detector mode.
3. Average test would be performed if the peak result were greater than the average limit or as required by the applicant.
4. Data of measurement within this frequency range shown " --- " in the table above means the reading of emissions are attenuated more than 20dB below the permissible limits or the field strength is too small to be measured.
5. Measurements above show only up to 6 maximum emissions noted, or would be lesser, with " N/A " remark, if no specific emissions from the EUT are recorded (ie: margin>20dB from the applicable limit) and considered that's already beyond the background noise floor.
6. Margin (dB) = Remark result (dBuV/m) – Average limit (dBuV/m).

Zigbee / TX / CH Mid

Polarity: Vertical

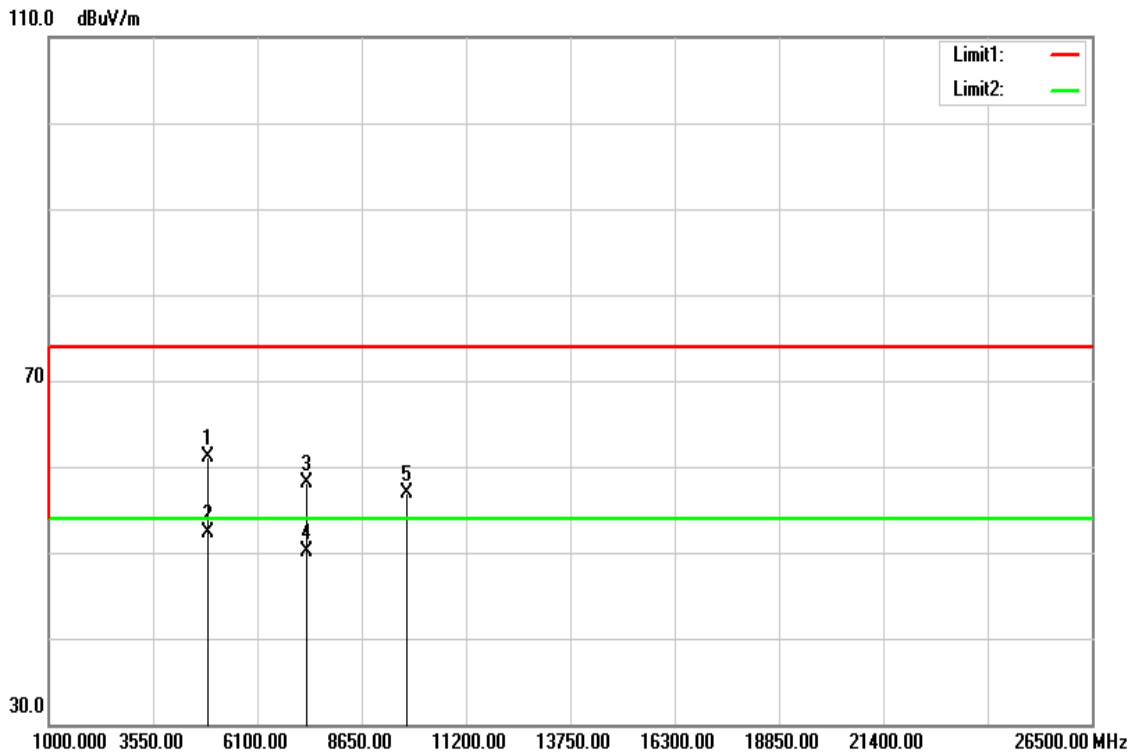

Polarity: Horizontal

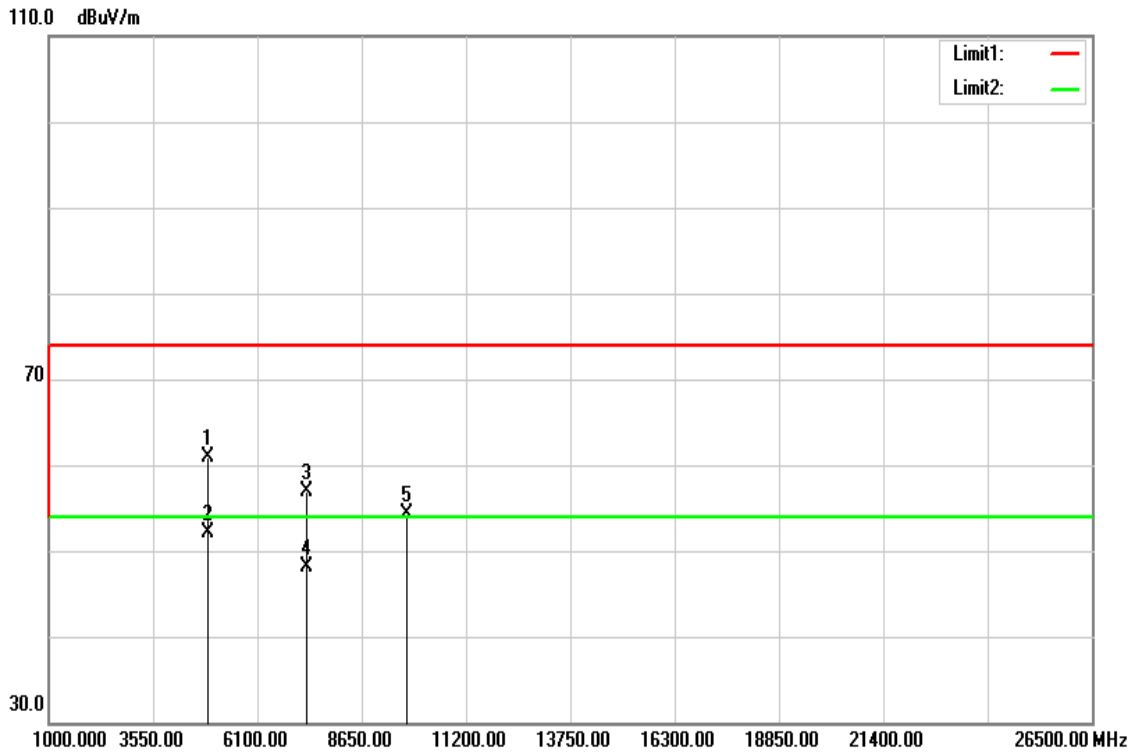

Operation Mode: Zigbee / TX / CH Mid

Test Date: July 7, 2016

Temperature: 27°C

Tested by: Dennis Li

Humidity: 53 % RH

Polarity: Ver. / Hor.

Frequency (MHz)	Reading (dBuV)	Correction (dB/m)	Result (dBuV/m)	Limit (dBuV/m)	Margin (dB)	Remark	Ant.Pol. (H/V)
4883.000	55.83	5.26	61.09	74.00	-12.91	peak	V
4883.000	47.06	5.26	52.32	54.00	-1.68	AVG	V
7319.000	45.24	12.96	58.20	74.00	-15.80	peak	V
7319.000	37.05	12.96	50.01	54.00	-3.99	AVG	V
9762.000	39.27	17.60	56.87	74.00	-17.13	peak	V
N/A							
4883.000	55.62	5.26	60.88	74.00	-13.12	peak	H
4883.000	46.92	5.26	52.18	54.00	-1.82	AVG	H
7319.000	44.04	12.96	57.00	74.00	-17.00	peak	H
7319.000	35.21	12.96	48.17	54.00	-5.83	AVG	H
9762.000	36.64	17.60	54.24	74.00	-19.76	peak	H
N/A							

Remark:

1. *Measuring frequencies from 1 GHz to the 10th harmonic of highest fundamental frequency.*
2. *Radiated emissions measured in frequency above 1000MHz were made with an instrument using peak/average detector mode.*
3. *Average test would be performed if the peak result were greater than the average limit or as required by the applicant.*
4. *Data of measurement within this frequency range shown " --- " in the table above means the reading of emissions are attenuated more than 20dB below the permissible limits or the field strength is too small to be measured.*
5. *Measurements above show only up to 6 maximum emissions noted, or would be lesser, with " N/A " remark, if no specific emissions from the EUT are recorded (ie: margin>20dB from the applicable limit) and considered that's already beyond the background noise floor.*
6. *Margin (dB) = Remark result (dBuV/m) – Average limit (dBuV/m).*

Zigbee / TX / CH High

Polarity: Vertical

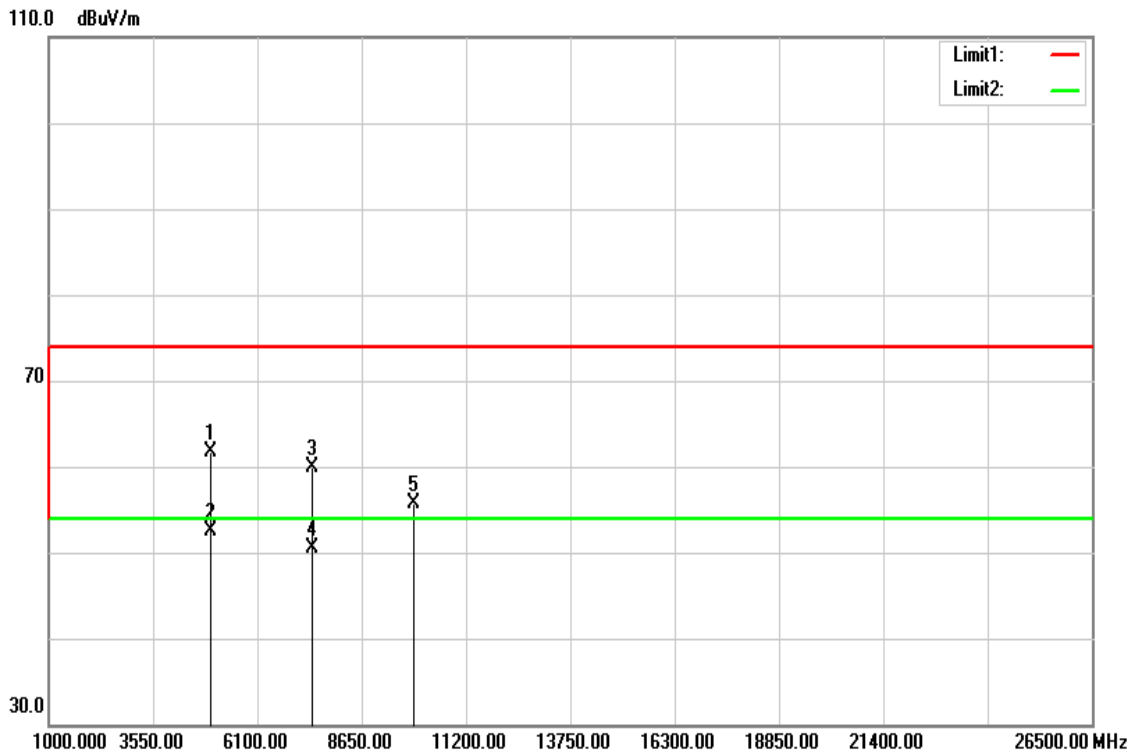

Polarity: Horizontal

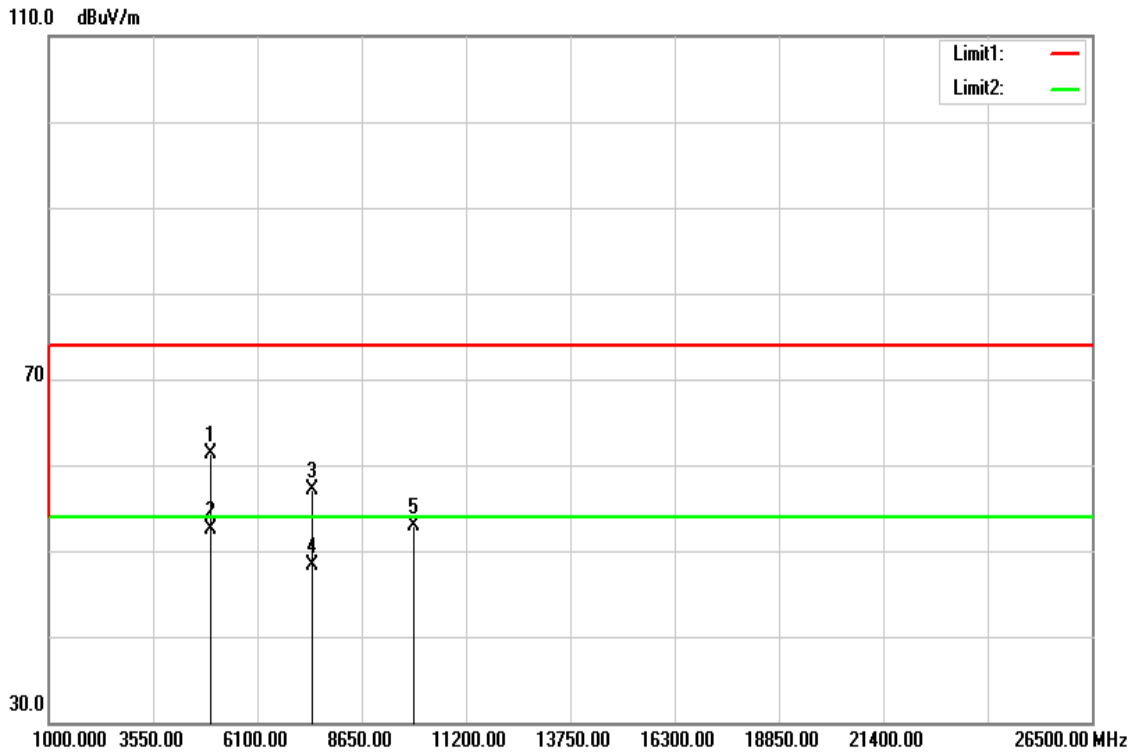

Operation Mode: Zigbee / TX / CH High

Test Date: June 27, 2016

Temperature: 27°C

Tested by: Dennis Li

Humidity: 53 % RH

Polarity: Ver. / Hor.

Frequency (MHz)	Reading (dBuV)	Correction (dB/m)	Result (dBuV/m)	Limit (dBuV/m)	Margin (dB)	Remark	Ant.Pol. (H/V)
4960.000	56.28	5.46	61.74	74.00	-12.26	peak	V
4960.000	47.10	5.46	52.56	54.00	-1.44	AVG	V
7438.000	46.55	13.32	59.87	74.00	-14.13	peak	V
7438.000	37.23	13.32	50.55	54.00	-3.45	AVG	V
9920.000	38.09	17.60	55.69	74.00	-18.31	peak	V
N/A							
4960.000	55.83	5.46	61.29	74.00	-12.71	peak	H
4960.000	46.99	5.46	52.45	54.00	-1.55	AVG	H
7445.000	43.69	13.34	57.03	74.00	-16.97	peak	H
7445.000	35.01	13.34	48.35	54.00	-5.65	AVG	H
9920.000	35.33	17.60	52.93	74.00	-21.07	peak	H
N/A							

Remark:

1. *Measuring frequencies from 1 GHz to the 10th harmonic of highest fundamental frequency.*
2. *Radiated emissions measured in frequency above 1000MHz were made with an instrument using peak/average detector mode.*
3. *Average test would be performed if the peak result were greater than the average limit or as required by the applicant.*
4. *Data of measurement within this frequency range shown " --- " in the table above means the reading of emissions are attenuated more than 20dB below the permissible limits or the field strength is too small to be measured.*
5. *Measurements above show only up to 6 maximum emissions noted, or would be lesser, with " N/A " remark, if no specific emissions from the EUT are recorded (ie: margin>20dB from the applicable limit) and considered that's already beyond the background noise floor.*
6. *Margin (dB) = Remark result (dBuV/m) – Average limit (dBuV/m).*

7.7 POWERLINE CONDUCTED EMISSIONS

LIMIT

According to §15.207(a), except as shown in paragraphs (b) and (c) of this section, for an intentional radiator that is designed to be connected to the public utility (AC) power line, the radio frequency voltage that is conducted back onto the AC power line on any frequency or frequencies within the band 150 kHz to 30 MHz shall not exceed the limits in the following table, as measured using a 50 μ H/50 ohms line impedance stabilization network (LISN). Compliance with the provisions of this paragraph shall be based on the measurement of the radio frequency voltage between each power line and ground at the power terminal. The lower limit applies at the boundary between the frequency ranges.

Frequency Range (MHz)	Limits (dB μ V)	
	Quasi-peak	Average
0.15 to 0.50	66 to 56*	56 to 46*
0.50 to 5	56	46
5 to 30	60	50

Test Configuration

See test photographs attached in Appendix II for the actual connections between EUT and support equipment.

TEST PROCEDURE

1. The EUT was placed on a table, which is 0.8m above ground plane.
2. Maximum procedure was performed on the six highest emissions to ensure EUT compliance.
3. Repeat above procedures until all frequency measured were complete.

TEST RESULTS

The initial step in collecting conducted data is a spectrum analyzer peak scan of the measurement range. Significant peaks are then marked as shown on the following data page, and these signals are then quasi-peaked.

Test Data

Operation Mode: Normal Link **Test Date:** July 6, 2016
Temperature: 24°C **Tested by:** Dennis Li
Humidity: 56% RH

Freq. (MHz)	QP Reading (dBuV)	AV Reading (dBuV)	Corr. factor (dB/m)	QP Result (dBuV/m)	AV Result (dBuV/m)	QP Limit (dBuV)	AV Limit (dBuV)	QP Margin (dB)	AV Margin (dB)	Note
0.1580	29.87	16.31	9.71	39.58	26.02	65.57	55.57	-25.99	-29.55	L1
0.2700	21.53	6.43	9.70	31.23	16.13	61.12	51.12	-29.89	-34.99	L1
0.3540	25.41	14.94	9.70	35.11	24.64	58.87	48.87	-23.76	-24.23	L1
0.4940	18.80	7.30	9.70	28.50	17.00	56.10	46.10	-27.60	-29.10	L1
0.8940	10.85	3.24	9.71	20.56	12.95	56.00	46.00	-35.44	-33.05	L1
4.9900	11.10	4.13	9.75	20.85	13.88	56.00	46.00	-35.15	-32.12	L1
0.1539	36.26	25.50	9.78	46.04	35.28	65.78	55.79	-19.74	-20.51	L2
0.1819	28.87	17.82	9.77	38.64	27.59	64.39	54.40	-25.75	-26.81	L2
0.3540	33.11	21.36	9.76	42.87	31.12	58.87	48.87	-16.00	-17.75	L2
0.5260	21.28	10.57	9.76	31.04	20.33	56.00	46.00	-24.96	-25.67	L2
0.8660	19.18	9.98	9.76	28.94	19.74	56.00	46.00	-27.06	-26.26	L2
4.9660	17.97	8.51	9.86	27.83	18.37	56.00	46.00	-28.17	-27.63	L2

Remark:

1. *Measuring frequencies from 0.15 MHz to 30MHz.*
2. *The emissions measured in frequency range from 0.15 MHz to 30MHz were made with an instrument using Quasi-peak detector and average detector.*
3. *The IF bandwidth of SPA between 0.15MHz and 30MHz was 10 kHz; the IF bandwidth of Test Receiver between 0.15MHz and 30MHz was 9 kHz;*
4. *L1 = Line One (Live Line) / L2 = Line Two (Neutral Line)*

Test Plots

Conducted emissions (Line 1)

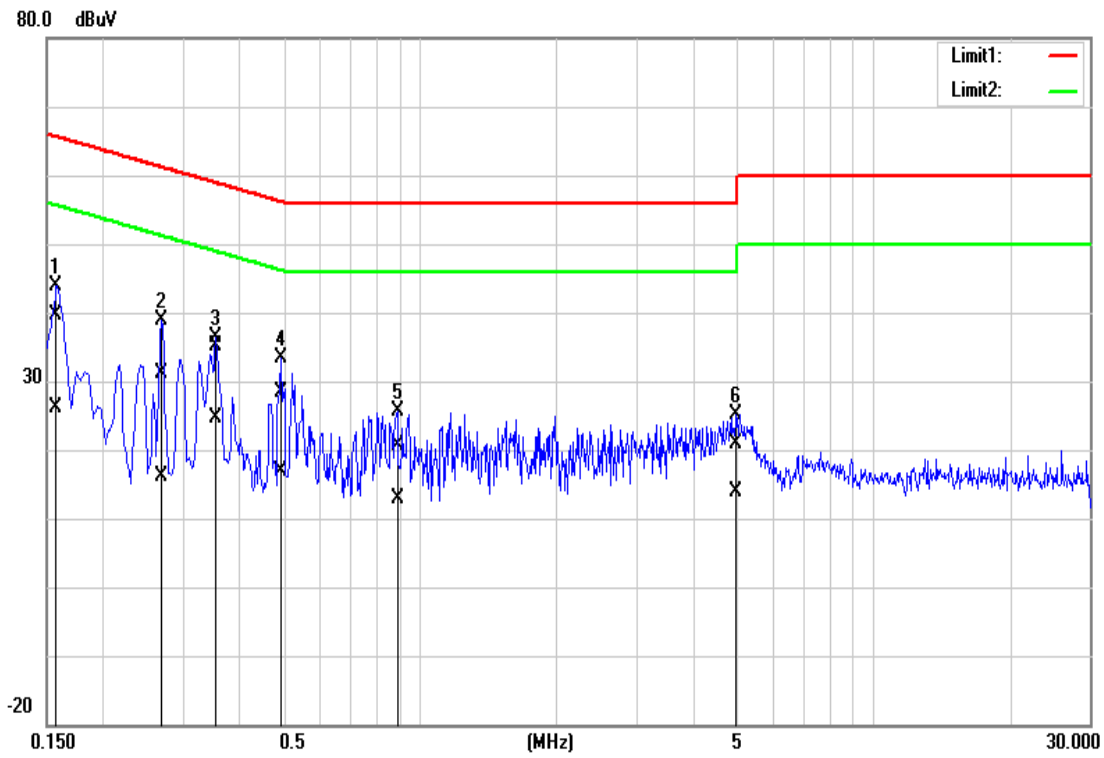

Conducted emissions (Line 2)

