

# FCC SAR Test Report

**Report No.** : SA190801D01  
**Applicant** : Sercomm Corp.  
**Address** : 8F, No. 3-1, YuanQu St., NanKang, Taipei 115, Taiwan, R.O.C. (NanKang Software Park)  
**Product** : LTE Wi-Fi Dongle  
**FCC ID** : P27LU211  
**Brand** : Sercomm  
**Model No.** : Adventure Wingle LU211  
**Standards** : FCC 47 CFR Part 2 (2.1093), IEEE C95.1:1992, IEEE Std 1528:2013  
 KDB 865664 D01 v01r04, KDB 865664 D02 v01r02  
 KDB 248227 D01 v02r02, KDB 447498 D01 v06, KDB 447498 D02 v02r01  
**Sample Received Date** : Aug. 01, 2019  
**Date of Testing** : Aug. 27, 2019 ~ Sep. 10, 2019  
**Lab Address** : No. 47-2, 14th Ling, Chia Pau Vil., Lin Kou Dist., New Taipei City, Taiwan  
**Test Location** : No. 19, Hwa Ya 2nd Rd., Wen Hwa Vil., Kwei Shan Dist., Taoyuan City, Taiwan

**CERTIFICATION:** The above equipment have been tested by **Bureau Veritas Consumer Products Services (H.K.) Ltd., Taoyuan Branch–Lin Kou Laboratories**, and found compliance with the requirement of the above standards. The test record, data evaluation & Equipment Under Test (EUT) configurations represented herein are true and accurate accounts of the measurements of the sample’s SAR characteristics under the conditions specified in this report. It should not be reproduced except in full, without the written approval of our laboratory. The client should not use it to claim product certification, approval, or endorsement by TAF or any government agencies.

**Prepared By :** Gina Liu  
 Gina Liu / Specialist  
**Approved By :** Gordon Lin  
 Gordon Lin / Manager



FCC Accredited No.: TW0003

This report is for your exclusive use. Any copying or replication of this report to or for any other person or entity, or use of our name or trademark, is permitted only with our prior written permission. This report sets forth our findings solely with respect to the test samples identified herein. The results set forth in this report are not indicative or representative of the quality or characteristics of the lot from which a test sample was taken or any similar or identical product unless specifically and expressly noted. Our report includes all of the tests requested by you and the results thereof based upon the information that you provided to us. You have 60 days from date of issuance of this report to notify us of any material error or omission caused by our negligence, provided, however, that such notice shall be in writing and shall specifically address the issue you wish to raise. A failure to raise such issue within the prescribed time shall constitute your unqualified acceptance of the completeness of this report, the tests conducted and the correctness of the report contents. Unless specific mention, the uncertainty of measurement has been explicitly taken into account to declare the compliance or non-compliance to the specification.

## Table of Contents

Release Control Record .....	3
1. Summary of Maximum SAR Value .....	4
2. Description of Equipment Under Test .....	5
3. SAR Measurement System .....	6
3.1 Definition of Specific Absorption Rate (SAR) .....	6
3.2 SPEAG DASY6 System .....	6
3.2.1 Robot .....	7
3.2.2 Probes .....	8
3.2.3 Data Acquisition Electronics (DAE) .....	8
3.2.4 Phantoms .....	8
3.2.5 Device Holder .....	9
3.2.6 System Validation Dipoles .....	9
3.2.7 Tissue Simulating Liquids .....	10
3.3 SAR System Verification .....	12
3.4 SAR Measurement Procedure .....	13
3.4.1 Area & Zoom Scan Procedure .....	13
3.4.2 Volume Scan Procedure .....	13
3.4.3 Power Drift Monitoring .....	14
3.4.4 Spatial Peak SAR Evaluation .....	14
3.4.5 SAR Averaged Methods .....	14
4. SAR Measurement Evaluation .....	15
4.1 EUT Configuration and Setting .....	15
4.2 EUT Testing Position .....	19
4.3 Tissue Verification .....	20
4.4 System Validation .....	20
4.5 System Verification .....	20
4.6 Maximum Output Power .....	21
4.6.1 Maximum Target Conducted Power .....	21
4.6.2 Measured Conducted Power Result .....	22
4.7 SAR Testing Results .....	23
4.7.1 SAR Test Reduction Considerations .....	23
4.7.2 SAR Results for Body Exposure Condition (Test Separation Distance is 5 mm) .....	24
4.7.3 SAR Measurement Variability .....	26
4.7.4 Simultaneous Multi-band Transmission Evaluation .....	26
5. Calibration of Test Equipment .....	27
6. Measurement Uncertainty .....	28
7. Information of the Testing Laboratories .....	29
Appendix A. SAR Plots of System Verification	
Appendix B. SAR Plots of SAR Measurement	
Appendix C. Calibration Certificate for Probe and Dipole	
Appendix D. Photographs of EUT and Setup	

### Release Control Record

Report No.	Reason for Change	Date Issued
SA190801D01	Initial release	Sep. 26, 2019

## 1. Summary of Maximum SAR Value

Equipment Class	Mode	Highest SAR-1g Body Tested at 5 mm (W/kg)
PCB	LTE 48	1.11
DTS	2.4G WLAN	1.11

**Note:**

1. The SAR criteria (**Head & Body: SAR-1g 1.6 W/kg, and Extremity: SAR-10g 4.0 W/kg**) for general population/uncontrolled exposure is specified in FCC 47 CFR part 2 (2.1093) and ANSI/IEEE C95.1-1992.

**2. Description of Equipment Under Test**

<b>EUT Type</b>	LTE Wi-Fi Dongle
<b>FCC ID</b>	P27LU211
<b>Brand Name</b>	Sercomm
<b>Model Name</b>	Adventure Wingle LU211
<b>Tx Frequency Bands (Unit: MHz)</b>	LTE Band 48 : 3550 ~ 3700 (BW: 5M, 10M, 15M, 20M) WLAN : 2412 ~ 2462
<b>Uplink Modulations</b>	LTE : QPSK, 16QAM 802.11b : DSSS 802.11a/g/n : OFDM
<b>Maximum Tune-up Conducted Power (Unit: dBm)</b>	Please refer to section 4.6.1 of this report
<b>Antenna Type</b>	WLAN: PIFA Antenna WWAN: Monopole Antenna
<b>EUT Stage</b>	Engineering Sample

**Note:**

1. The above EUT information is declared by manufacturer and for more detailed features description please refers to the manufacturer's specifications or User's Manual.

### **3. SAR Measurement System**

#### **3.1 Definition of Specific Absorption Rate (SAR)**

SAR is related to the rate at which energy is absorbed per unit mass in an object exposed to a radio field. The SAR distribution in a biological body is complicated and is usually carried out by experimental techniques or numerical modeling. The standard recommends limits for two tiers of groups, occupational/controlled and general population/uncontrolled, based on a person's awareness and ability to exercise control over his or her exposure. In general, occupational/controlled exposure limits are higher than the limits for general population/uncontrolled.

The SAR definition is the time derivative (rate) of the incremental energy (dW) absorbed by (dissipated in) an incremental mass (dm) contained in a volume element (dv) of a given density ( $\rho$ ). The equation description is as below:

$$\text{SAR} = \frac{d}{dt} \left( \frac{dW}{dm} \right) = \frac{d}{dt} \left( \frac{dW}{\rho dv} \right)$$

SAR is expressed in units of Watts per kilogram (W/kg)

SAR measurement can be related to the electrical field in the tissue by

$$\text{SAR} = \frac{\sigma |E|^2}{\rho}$$

Where:  $\sigma$  is the conductivity of the tissue,  $\rho$  is the mass density of the tissue and E is the RMS electrical field strength.

#### **3.2 SPEAG DASY6 System**

DASY6 system consists of high precision robot, probe alignment sensor, phantom, robot controller, controlled measurement server and near-field probe. The robot includes six axes that can move to the precision position of the DASY6 software defined. The DASY6 software can define the area that is detected by the probe. The robot is connected to controlled box. Controlled measurement server is connected to the controlled robot box. The DAE includes amplifier, signal multiplexing, AD converter, offset measurement and surface detection. It is connected to the Electro-optical coupler (ECO). The ECO performs the conversion from the optical into digital electric signal of the DAE and transfers data to the PC.

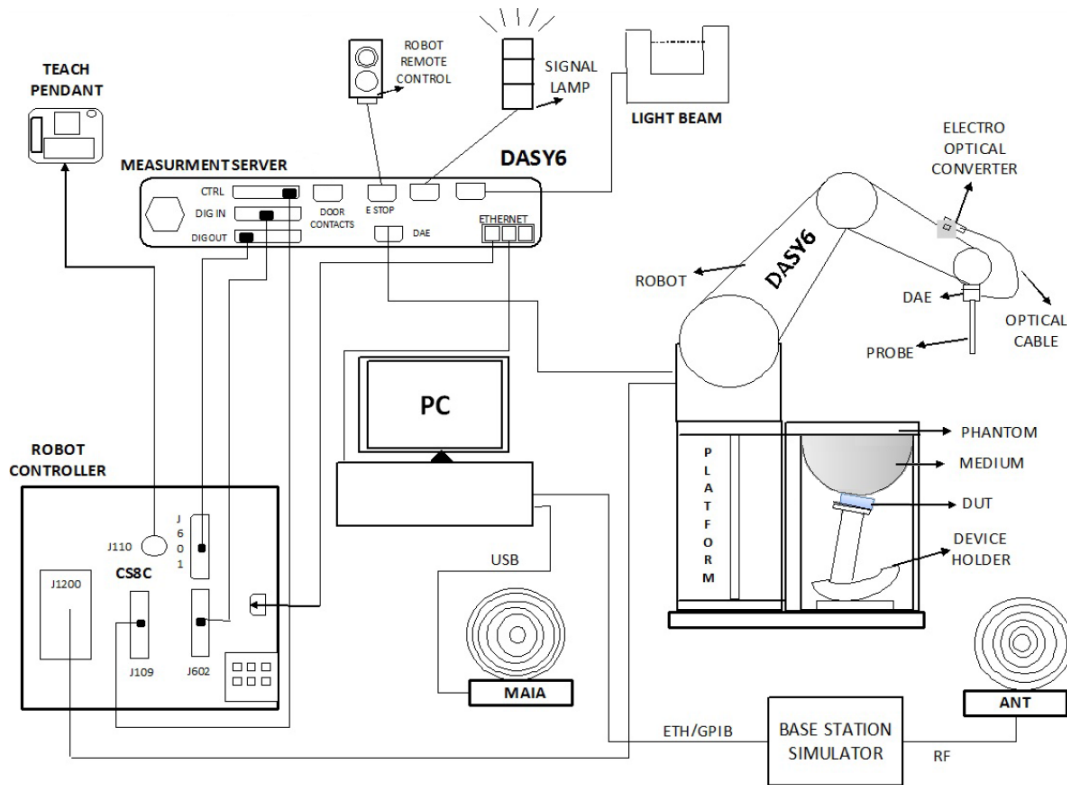

Fig-3.1 SPEAG DASY6 System Setup

### 3.2.1 Robot

The DASY6 systems use the high precision robots from Stäubli SA (France). For the 6-axis controller system, the robot controller version of CS8c from Stäubli is used. The Stäubli robot series have many features that are important for our application:

- High precision (repeatability  $\pm 0.035$  mm)
- High reliability (industrial design)
- Jerk-free straight movements
- Low ELF interference (the closed metallic construction shields against motor control fields)

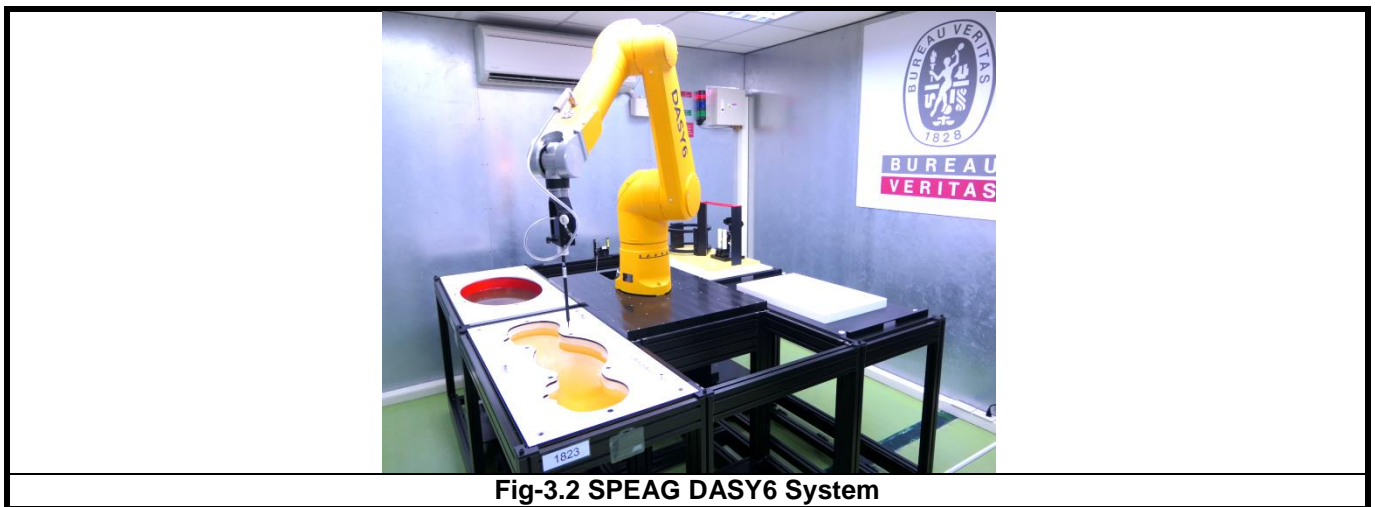



Fig-3.2 SPEAG DASY6 System

## FCC SAR Test Report

### 3.2.2 Probes

The SAR measurement is conducted with the dosimetric probe. The probe is specially designed and calibrated for use in liquid with high permittivity. The dosimetric probe has special calibration in liquid at different frequency.

<b>Model</b>	EX3DV4	
<b>Construction</b>	Symmetrical design with triangular core. Built-in shielding against static charges. PEEK enclosure material (resistant to organic solvents, e.g., DGBE).	
<b>Frequency</b>	4 MHz to 10 GHz Linearity: $\pm 0.2$ dB	
<b>Directivity</b>	$\pm 0.1$ dB in TSL (rotation around probe axis) $\pm 0.3$ dB in TSL (rotation normal to probe axis)	
<b>Dynamic Range</b>	10 $\mu$ W/g to 100 mW/g Linearity: $\pm 0.2$ dB (noise: typically $< 1$ $\mu$ W/g)	
<b>Dimensions</b>	Overall length: 337 mm (Tip: 20 mm) Tip diameter: 2.5 mm (Body: 12 mm) Typical distance from probe tip to dipole centers: 1 mm	

### 3.2.3 Data Acquisition Electronics (DAE)

<b>Model</b>	DAE3, DAE4	
<b>Construction</b>	Signal amplifier, multiplexer, A/D converter and control logic. Serial optical link for communication with DASY embedded system (fully remote controlled). Two step probe touch detector for mechanical surface detection and emergency robot stop.	
<b>Measurement Range</b>	-100 to +300 mV (16 bit resolution and two range settings: 4mV, 400mV)	
<b>Input Offset Voltage</b>	$< 5$ $\mu$ V (with auto zero)	
<b>Input Bias Current</b>	$< 50$ fA	
<b>Dimensions</b>	60 x 60 x 68 mm	

### 3.2.4 Phantoms

<b>Model</b>	Twin SAM	
<b>Construction</b>	The shell corresponds to the specifications of the Specific Anthropomorphic Mannequin (SAM) phantom defined in IEEE 1528 and IEC 62209-1. It enables the dosimetric evaluation of left and right hand phone usage as well as body mounted usage at the flat phantom region. A cover prevents evaporation of the liquid. Reference markings on the phantom allow the complete setup of all predefined phantom positions and measurement grids by teaching three points with the robot.	
<b>Material</b>	Vinylester, glass fiber reinforced (VE-GF)	
<b>Shell Thickness</b>	$2 \pm 0.2$ mm ( $6 \pm 0.2$ mm at ear point)	
<b>Dimensions</b>	Length: 1000 mm Width: 500 mm Height: adjustable feet	
<b>Filling Volume</b>	approx. 25 liters	



# FCC SAR Test Report

<b>Model</b>	ELI	
<b>Construction</b>	Phantom for compliance testing of handheld and body-mounted wireless devices in the frequency range of 30 MHz to 6 GHz. ELI is fully compatible with the IEC 62209-2 standard and all known tissue simulating liquids. ELI has been optimized regarding its performance and can be integrated into our standard phantom tables. A cover prevents evaporation of the liquid. Reference markings on the phantom allow installation of the complete setup, including all predefined phantom positions and measurement grids, by teaching three points. The phantom is compatible with all SPEAG dosimetric probes and dipoles.	
<b>Material</b>	Vinylester, glass fiber reinforced (VE-GF)	
<b>Shell Thickness</b>	2.0 ± 0.2 mm (bottom plate)	
<b>Dimensions</b>	Major axis: 600 mm Minor axis: 400 mm	
<b>Filling Volume</b>	approx. 30 liters	

## 3.2.5 Device Holder

<b>Model</b>	Mounting Device	
<b>Construction</b>	In combination with the Twin SAM Phantom or ELI4, the Mounting Device enables the rotation of the mounted transmitter device in spherical coordinates. Rotation point is the ear opening point. Transmitter devices can be easily and accurately positioned according to IEC, IEEE, FCC or other specifications. The device holder can be locked for positioning at different phantom sections (left head, right head, flat).	
<b>Material</b>	POM	

<b>Model</b>	Laptop Extensions Kit	
<b>Construction</b>	Simple but effective and easy-to-use extension for Mounting Device that facilitates the testing of larger devices according to IEC 62209-2 (e.g., laptops, cameras, etc.). It is lightweight and fits easily on the upper part of the Mounting Device in place of the phone positioner.	
<b>Material</b>	POM, Acrylic glass, Foam	

## 3.2.6 System Validation Dipoles

<b>Model</b>	D-Serial	
<b>Construction</b>	Symmetrical dipole with 1/4 balun. Enables measurement of feedpoint impedance with NWA. Matched for use near flat phantoms filled with tissue simulating solutions.	
<b>Frequency</b>	750 MHz to 5800 MHz	
<b>Return Loss</b>	> 20 dB	
<b>Power Capability</b>	> 100 W (f < 1GHz), > 40 W (f > 1GHz)	

### 3.2.7 Tissue Simulating Liquids

For SAR measurement of the field distribution inside the phantom, the phantom must be filled with homogeneous tissue simulating liquid to a depth of at least 15 cm. For head SAR testing, the liquid height from the ear reference point (ERP) of the phantom to the liquid top surface is larger than 15 cm. For body SAR testing, the liquid height from the center of the flat phantom to the liquid top surface is larger than 15 cm. The nominal dielectric values of the tissue simulating liquids in the phantom and the tolerance of 5% are listed in Table-3.1.

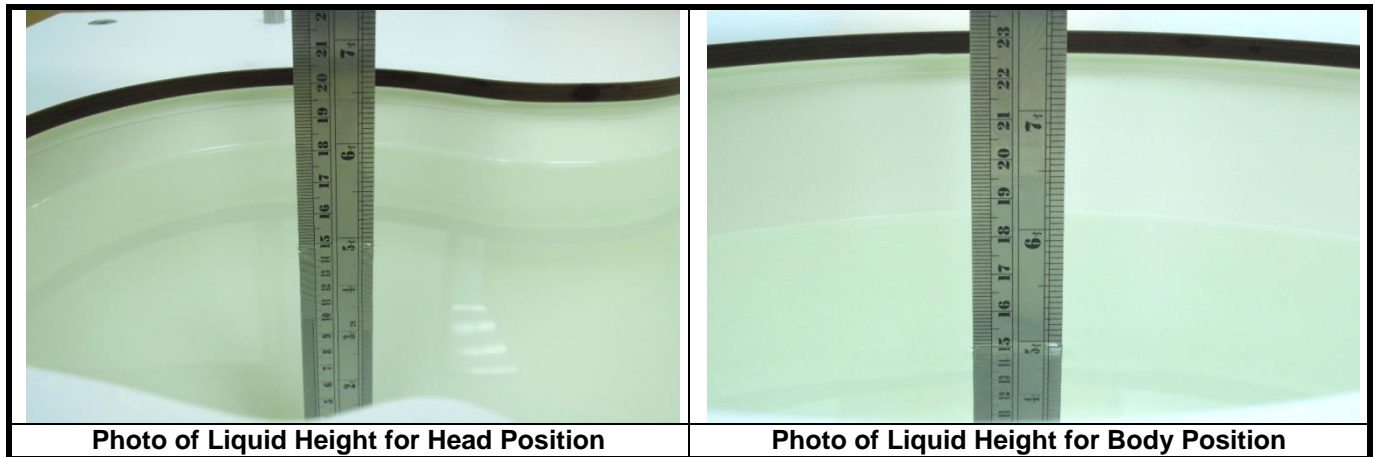

The dielectric properties of the head tissue simulating liquids are defined in IEEE1528, and KDB 865664 D01 Appendix A. For the body tissue simulating liquids, the dielectric properties are defined in KDB 865664 D01 Appendix A. The dielectric properties of the tissue simulating liquids were verified prior to the SAR evaluation using a dielectric assessment kit and a network analyzer.

**Table-3.1 Targets of Tissue Simulating Liquid**

Frequency (MHz)	Target Permittivity	Range of $\pm 5\%$	Target Conductivity	Range of $\pm 5\%$
750	41.9	39.8 ~ 44.0	0.89	0.85 ~ 0.93
835	41.5	39.4 ~ 43.6	0.90	0.86 ~ 0.95
900	41.5	39.4 ~ 43.6	0.97	0.92 ~ 1.02
1450	40.5	38.5 ~ 42.5	1.20	1.14 ~ 1.26
1640	40.3	38.3 ~ 42.3	1.29	1.23 ~ 1.35
1750	40.1	38.1 ~ 42.1	1.37	1.30 ~ 1.44
1800	40.0	38.0 ~ 42.0	1.40	1.33 ~ 1.47
1900	40.0	38.0 ~ 42.0	1.40	1.33 ~ 1.47
2000	40.0	38.0 ~ 42.0	1.40	1.33 ~ 1.47
2300	39.5	37.5 ~ 41.5	1.67	1.59 ~ 1.75
2450	39.2	37.2 ~ 41.2	1.80	1.71 ~ 1.89
2600	39.0	37.1 ~ 41.0	1.96	1.86 ~ 2.06
3500	37.9	36.0 ~ 39.8	2.91	2.76 ~ 3.06
5200	36.0	34.2 ~ 37.8	4.66	4.43 ~ 4.89
5300	35.9	34.1 ~ 37.7	4.76	4.52 ~ 5.00
5500	35.6	33.8 ~ 37.4	4.96	4.71 ~ 5.21
5600	35.5	33.7 ~ 37.3	5.07	4.82 ~ 5.32
5800	35.3	33.5 ~ 37.1	5.27	5.01 ~ 5.53

The following table gives the recipes for tissue simulating liquids.

**Table-3.2 Recipes of Tissue Simulating Liquid**

Tissue Type	Bactericide	DGBE	HEC	NaCl	Sucrose	Triton X-100	Water	Diethylene Glycol Monohexylether
H750	0.2	-	0.2	1.5	56.0	-	42.1	-
H835	0.2	-	0.2	1.5	57.0	-	41.1	-
H900	0.2	-	0.2	1.4	58.0	-	40.2	-
H1450	-	43.3	-	0.6	-	-	56.1	-
H1640	-	45.8	-	0.5	-	-	53.7	-
H1750	-	47.0	-	0.4	-	-	52.6	-
H1800	-	44.5	-	0.3	-	-	55.2	-
H1900	-	44.5	-	0.2	-	-	55.3	-
H2000	-	44.5	-	0.1	-	-	55.4	-
H2300	-	44.9	-	0.1	-	-	55.0	-
H2450	-	45.0	-	0.1	-	-	54.9	-
H2600	-	45.1	-	0.1	-	-	54.8	-
H3500	-	8.0	-	0.2	-	20.0	71.8	-
H5G	-	-	-	-	-	17.2	65.5	17.3

**3.3 SAR System Verification**

The system check verifies that the system operates within its specifications. It is performed daily or before every SAR measurement. The system check uses normal SAR measurements in the flat section of the phantom with a matched dipole at a specified distance. The system verification setup is shown as below.

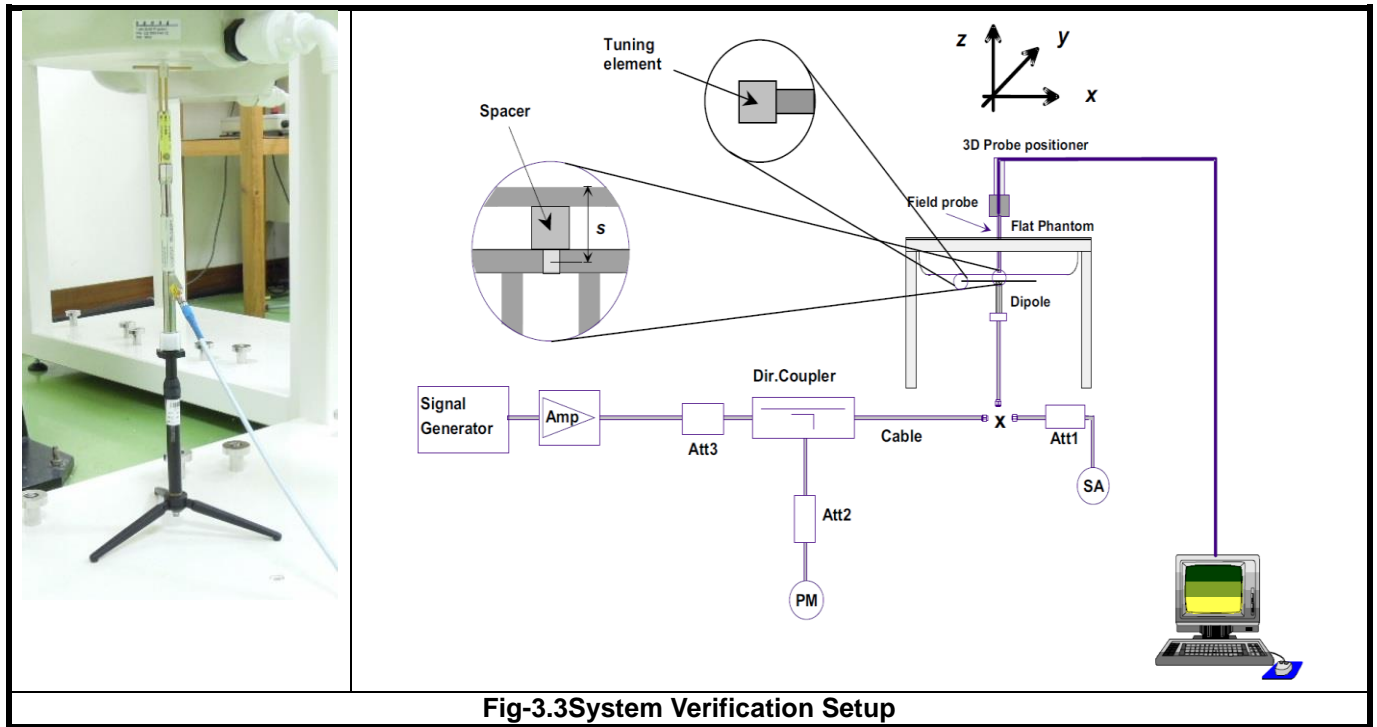

**Fig-3.3 System Verification Setup**

The validation dipole is placed beneath the flat phantom with the specific spacer in place. The distance spacer is touch the phantom surface with a light pressure at the reference marking and be oriented parallel to the long side of the phantom. The spectrum analyzer measures the forward power at the location of the system check dipole connector. The signal generator is adjusted for the desired forward power (250 mW is used for 700 MHz to 3 GHz, 100 mW is used for 3.5 GHz to 6 GHz) at the dipole connector and the power meter is read at that level. After connecting the cable to the dipole, the signal generator is readjusted for the same reading at power meter.

After system check testing, the SAR result will be normalized to 1W forward input power and compared with the reference SAR value derived from validation dipole certificate report. The deviation of system check should be within 10 %.

**3.4 SAR Measurement Procedure**

According to the SAR test standard, the recommended procedure for assessing the peak spatial-average SAR value consists of the following steps:

- (a) Power reference measurement
- (b) Area scan
- (c) Zoom scan
- (d) Power drift measurement

The SAR measurement procedures for each of test conditions are as follows:

- (a) Make EUT to transmit maximum output power
- (b) Measure conducted output power through RF cable
- (c) Place the EUT in the specific position of phantom
- (d) Perform SAR testing steps on the DASY system
- (e) Record the SAR value

**3.4.1 Area & Zoom Scan Procedure**

First Area Scan is used to locate the approximate location(s) of the local peak SAR value(s). The measurement grid within an Area Scan is defined by the grid extent, grid step size and grid offset. Next, in order to determine the EM field distribution in a three-dimensional spatial extension, Zoom Scan is required. The Zoom Scan is performed around the highest E-field value to determine the averaged SAR-distribution over 10 g. According to KDB 865664D01, the resolution for Area and Zoom scan is specified in the table below.

Items	<= 2 GHz	2-3 GHz	3-4 GHz	4-5 GHz	5-6 GHz
Area Scan ( $\Delta x, \Delta y$ )	<= 15 mm	<= 12 mm	<= 12 mm	<= 10 mm	<= 10 mm
Zoom Scan ( $\Delta x, \Delta y$ )	<= 8 mm	<= 5 mm	<= 5 mm	<= 4 mm	<= 4 mm
Zoom Scan ( $\Delta z$ )	<= 5 mm	<= 5 mm	<= 4 mm	<= 3 mm	<= 2 mm
Zoom Scan Volume	>= 30 mm	>= 30 mm	>= 28 mm	>= 25 mm	>= 22 mm

**Note:**

When zoom scan is required and report SAR is <=1.4 W/kg, the zoom scan resolution of  $\Delta x / \Delta y$  (2-3GHz: <= 8 mm, 3-4GHz: <= 7 mm, 4-6GHz: <= 5 mm) may be applied.

**3.4.2 Volume Scan Procedure**

The volume scan is used for assess overlapping SAR distributions for antennas transmitting in different frequency bands. It is equivalent to an oversized zoom scan used in standalone measurements. The measurement volume will be used to enclose all the simultaneous transmitting antennas. For antennas transmitting simultaneously in different frequency bands, the volume scan is measured separately in each frequency band. In order to sum correctly to compute the 1g aggregate SAR, the EUT remain in the same test position for all measurements and all volume scan use the same spatial resolution and grid spacing. When all volume scan were completed, the software, SEMCAD postprocessor can combine and subsequently superpose these measurement data to calculating the multiband SAR.

### 3.4.3 Power Drift Monitoring

All SAR testing is under the EUT install full charged battery and transmit maximum output power. In DASYS measurement software, the power reference measurement and power drift measurement procedures are used for monitoring the power drift of EUT during SAR test. Both these procedures measure the field at a specified reference position before and after the SAR testing. The software will calculate the field difference in dB. If the power drift more than 5%, the SAR will be retested.

### 3.4.4 Spatial Peak SAR Evaluation

The procedure for spatial peak SAR evaluation has been implemented according to the test standard. It can be conducted for 1g and 10g, as well as for user-specific masses. The DASYS software includes all numerical procedures necessary to evaluate the spatial peak SAR value.

The base for the evaluation is a "cube" measurement. The measured volume must include the 1g and 10g cubes with the highest averaged SAR values. For that purpose, the center of the measured volume is aligned to the interpolated peak SAR value of a previously performed area scan.

The entire evaluation of the spatial peak values is performed within the post-processing engine (SEMCAD). The system always gives the maximum values for the 1g and 10g cubes. The algorithm to find the cube with highest averaged SAR is divided into the following stages:

- (a) Extraction of the measured data (grid and values) from the Zoom Scan
- (b) Calculation of the SAR value at every measurement point based on all stored data (A/D values and measurement parameters)
- (c) Generation of a high-resolution mesh within the measured volume
- (d) Interpolation of all measured values from the measurement grid to the high-resolution grid
- (e) Extrapolation of the entire 3-D field distribution to the phantom surface over the distance from sensor to surface
- (f) Calculation of the averaged SAR within masses of 1g and 10g

### 3.4.5 SAR Averaged Methods

In DASYS, the interpolation and extrapolation are both based on the modified Quadratic Shepard's method. The interpolation scheme combines a least-square fitted function method and a weighted average method which are the two basic types of computational interpolation and approximation.

Extrapolation routines are used to obtain SAR values between the lowest measurement points and the inner phantom surface. The extrapolation distance is determined by the surface detection distance and the probe sensor offset. The uncertainty increases with the extrapolation distance. To keep the uncertainty within 1% for the 1 g and 10 g cubes, the extrapolation distance should not be larger than 5 mm.

## 4. SAR Measurement Evaluation

### 4.1 EUT Configuration and Setting

#### <Connections between EUT and System Simulator>

For WWAN SAR testing, the EUT was linked and controlled by base station emulator. Communication between the EUT and the emulator was established by air link. The distance between the EUT and the communicating antenna of the emulator is larger than 50 cm and the output power radiated from the emulator antenna is at least 30 dB smaller than the output power of EUT. The EUT was set from the emulator to radiate maximum output power during SAR testing.

#### <Considerations Related to LTE for Setup and Testing>

This device contains LTE transmitter which follows 3GPP standards, is category 3, supports both QPSK and QAM modulations, and supported LTE band and channel bandwidth is listed in below. The output power was tested per 3GPP TS 36.521-1 maximum transmit procedures for both QPSK and QAM modulation. The results please refer to section 4.6 of this report.

EUT Supported LTE Band and Channel Bandwidth						
LTE Band	BW 1.4 MHz	BW 3 MHz	BW 5 MHz	BW 10 MHz	BW 15 MHz	BW 20 MHz
48			V	V	V	V

The LTE maximum power reduction (MPR) in accordance with 3GPP TS 36.101 is active all times during LTE operation. The allowed MPR for the maximum output power is specified in below.

Modulation	Channel Bandwidth / RB Configurations						LTE MPR Setting (dB)
	BW 1.4 MHz	BW 3 MHz	BW 5 MHz	BW 10 MHz	BW 15 MHz	BW 20 MHz	
QPSK	> 5	> 4	> 8	> 12	> 16	> 18	1
16QAM	<= 5	<= 4	<= 8	<= 12	<= 16	<= 18	1
16QAM	> 5	> 4	> 8	> 12	> 16	> 18	2

**Note:** MPR is according to the standard and implemented in the circuit (mandatory).

In addition, the device is compliant with additional maximum power reduction (A-MPR) requirements defined in 3GPP TS 36.101 section 6.2.4 that was disabled for all FCC compliance testing.

During LTE SAR testing, the related parameters of operating band, channel bandwidth, uplink channel number, modulation type, and RB was set in base station simulator. When the EUT has registered and communicated to base station simulator, the simulator set to make EUT transmitting the maximum radiated power.

# FCC SAR Test Report

## TDD-LTE Setup Configurations

According to KDB 941225 D05, SAR testing for TDD-LTE device must be tested using a fixed periodic duty factor according to the highest transmission duty factor implemented for the device and supported by the defined 3GPP TDD-LTE configurations. The TDD-LTE of this device supports frame structure type 2 defined in 3GPP TS 36.211 section 4.2, and the frame structure configuration can be referred to below.

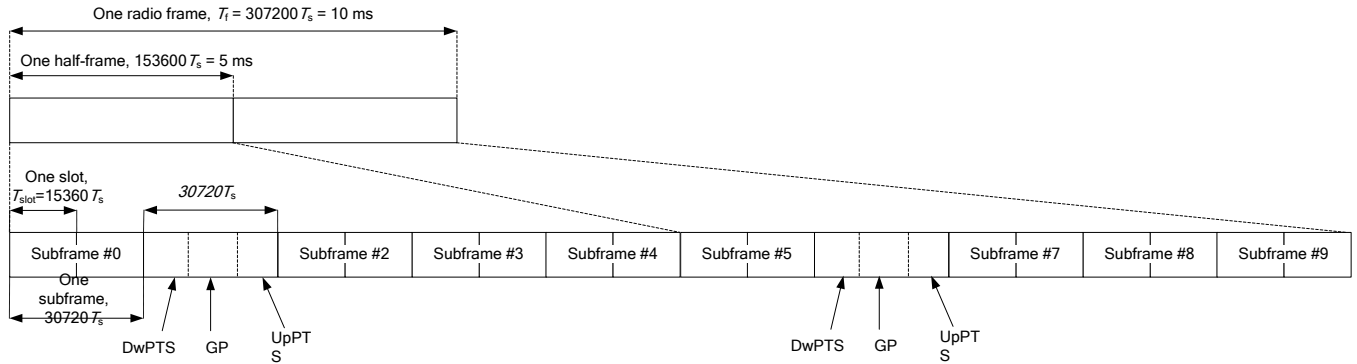

3GPP TS 36.211 Figure 4.2-1: Frame Structure Type 2

Special Subframe Configuration	Normal Cyclic Prefix in Downlink			Extended Cyclic Prefix in Downlink		
	DwPTS	UpPTS		DwPTS	UpPTS	
		Normal Cyclic Prefix in Uplink	Extended Cyclic Prefix in Uplink		Normal Cyclic Prefix in Uplink	Extended Cyclic Prefix in Uplink
0	6592 · Ts	2192 · Ts	2560 · Ts	7680 · Ts	2192 · Ts	2560 · Ts
1	19760 · Ts			20480 · Ts		
2	21952 · Ts			23040 · Ts		
3	24144 · Ts			25600 · Ts		
4	26336 · Ts	4384 · Ts	5120 · Ts	7680 · Ts	4384 · Ts	5120 · Ts
5	6592 · Ts			20480 · Ts		
6	19760 · Ts			23040 · Ts		
7	21952 · Ts			12800 · Ts		
8	24144 · Ts	-	-	-	-	-
9	13168 · Ts	-	-	-	-	-

3GPP TS 36.211 Table 4.2-1: Configuration of Special Subframe

Uplink-Downlink Configuration	Downlink-to-Uplink Switch-Point Periodicity	Subframe Number										
		0	1	2	3	4	5	6	7	8	9	
0	5 ms	D	S	U	U	U	D	S	U	U	U	
1	5 ms	D	S	U	U	D	D	S	U	U	D	
2	5 ms	D	S	U	D	D	D	S	U	D	D	
3	10 ms	D	S	U	U	U	D	D	D	D	D	
4	10 ms	D	S	U	U	D	D	D	D	D	D	
5	10 ms	D	S	U	D	D	D	D	D	D	D	
6	5 ms	D	S	U	U	U	D	S	U	U	D	

3GPP TS 36.211 Table 4.2-2: Uplink-Downlink Configurations



## FCC SAR Test Report

The variety of different TD-LTE uplink-downlink configurations allows a network operator to allocate the network's capacity between uplink and downlink traffic to meet the needs of the network. The uplink duty cycle of these seven configurations can readily be computed and shown in below.

UL-DL Configuration	0	1	2	3	4	5	6
Highest Duty-Cycle	63.33%	43.33%	23.33%	31.67%	21.67%	11.67%	53.33%

Considering the highest transmission duty cycle, TDD-LTE was tested using Uplink-Downlink Configuration 0 with 6 uplink subframe and 2 special subframe. The special subframe was set to special subframe configuration 7 using extended cyclic prefix uplink. Therefore, SAR testing for TDD-LTE was performed at the maximum output power with highest transmission duty cycle of 63.33%.

### <Considerations Related to WLAN for Setup and Testing>

In general, various vendor specific external test software and chipset based internal test modes are typically used for SAR measurement. These chipset based test mode utilities are generally hardware and manufacturer dependent, and often include substantial flexibility to reconfigure or reprogram a device. A Wi-Fi device must be configured to transmit continuously at the required data rate, channel bandwidth and signal modulation, using the highest transmission duty factor supported by the test mode tools for SAR measurement. The test frequencies established using test mode must correspond to the actual channel frequencies. When 802.11 frame gaps are accounted for in the transmission, a maximum transmission duty factor of 92 - 96% is typically achievable in most test mode configurations. A minimum transmission duty factor of 85% is required to avoid certain hardware and device implementation issues related to wide range SAR scaling. In addition, a periodic transmission duty factor is required for current generation SAR systems to measure SAR correctly. The reported SAR must be scaled to 100% transmission duty factor to determine compliance at the maximum tune-up tolerance limit.

According to KDB 248227 D01, this device has installed WLAN engineering testing software which can provide continuous transmitting RF signal. During WLAN SAR testing, this device was operated to transmit continuously at the maximum transmission duty with specified transmission mode, operating frequency, lowest data rate, and maximum output power.

### Initial Test Configuration

An initial test configuration is determined for OFDM transmission modes in 2.4 GHz and 5 GHz bands according to the channel bandwidth, modulation and data rate combination(s) with the highest maximum output power specified for production units in each standalone and aggregated frequency band. When the same maximum power is specified for multiple transmission modes in a frequency band, the largest channel bandwidth, lowest order modulation, lowest data rate and lowest order 802.11a/g/n/ac mode is used for SAR measurement, on the highest measured output power channel in the initial test configuration, for each frequency band.

## FCC SAR Test Report

---

### Subsequent Test Configuration

SAR measurement requirements for the remaining 802.11 transmission mode configurations that have not been tested in the initial test configuration are determined separately for each standalone and aggregated frequency band, in each exposure condition, according to the maximum output power specified for production units. Additional power measurements may be required to determine if SAR measurements are required for subsequent highest output power channels in a subsequent test configuration. When the highest reported SAR for the initial test configuration according to the initial test position or fixed exposure position requirements, is adjusted by the ratio of the subsequent test configuration to initial test configuration specified maximum output power and the adjusted SAR is  $\leq 1.2$  W/kg, SAR is not required for that subsequent test configuration.

### SAR Test Configuration and Channel Selection





When multiple channel bandwidth configurations in a frequency band have the same specified maximum output power, the initial test configuration is using largest channel bandwidth, lowest order modulation, lowest data rate, and lowest order 802.11 mode (i.e., 802.11a is chosen over 802.11n then 802.11ac or 802.11g is chosen over 802.11n). After an initial test configuration is determined, if multiple test channels have the same measured maximum output power, the channel chosen for SAR measurement is determined according to the following.

- 1) The channel closest to mid-band frequency is selected for SAR measurement.
- 2) For channels with equal separation from mid-band frequency; for example, high and low channels or two mid-band channels, the higher frequency (number) channel is selected for SAR measurement.

**4.2 EUT Testing Position**

**<Simple Dongle Procedures>**

For USB dongle transmitter, according to KDB 447498 D02, SAR evaluation is required for all USB orientations illustrated as below with a device-to-phantom separation distance of 5 mm or less. The typical Horizontal-Up USB connection, found in the majority of host computers, must be tested using an appropriate host computer. A host computer with either Vertical-Front or Vertical-Back USB connection should be used to test one of the vertical USB orientations. If a suitable host computer is not available for testing the Horizontal-Down or the remaining Vertical USB orientation, a high quality USB cable, 12 inches or less, may be used for testing these other orientations.

			
<b>USB Orientation 1 (Horizontal-Up)</b>	<b>USB Orientation 2 (Horizontal-Down)</b>	<b>USB Orientation 3 (Vertical-Front)</b>	<b>USB Orientation 4 (Vertical-Back)</b>

**Fig-4.1 Illustration for USB Connector Orientations**

**<Dongles with Swivel or Rotating Connectors>**

The procedures described for simple dongles should be used to position the four surfaces of the dongle at 5 mm from the phantom to evaluate SAR. If the antenna is within 1 cm from the tip of the dongle (the end without the USB connector), the tip of the dongle should also be tested at 5 mm perpendicular to the phantom. For antennas located within 2.5 cm from the USB connector and if the dongle can be positioned at 45° to 90° from the horizontal position, testing in one or more of these configurations may need to be considered. A KDB inquiry should be submitted to determine the applicable test configurations.

**4.3 Tissue Verification**

The measuring results for tissue simulating liquid are shown as below.

Test Date	Frequency (MHz)	Liquid Temp. (°C)	Measured Conductivity ( $\sigma$ )	Measured Permittivity ( $\epsilon_r$ )	Target Conductivity ( $\sigma$ )	Target Permittivity ( $\epsilon_r$ )	Conductivity Deviation (%)	Permittivity Deviation (%)
Aug. 27, 2019	2450	23.1	1.882	38.31	1.8	39.2	4.56	-2.27
Sep. 10, 2019	3500	23.1	2.893	36.469	2.91	37.9	-0.58	-3.78
Sep. 10, 2019	3700	23.1	3.039	36.271	3.12	37.7	-2.60	-3.79

**Note:**

The dielectric properties of the tissue simulating liquid must be measured within 24 hours before the SAR testing and within  $\pm 5\%$  of the target values. Liquid temperature during the SAR testing must be within  $\pm 2$  °C.

**4.4 System Validation**

The SAR measurement system was validated according to procedures in KDB 865664 D01. The validation status in tabulated summary is as below.

Test Date	Probe S/N	Calibration Point	Measured Conductivity ( $\sigma$ )	Measured Permittivity ( $\epsilon_r$ )	Validation for CW			Validation for Modulation		
					Sensitivity Range	Probe Linearity	Probe Isotropy	Modulation Type	Duty Factor	PAR
Aug. 27, 2019	3971	2450	1.882	38.31	Pass	Pass	Pass	OFDM	N/A	Pass
Sep. 10, 2019	3650	3500	2.893	36.469	Pass	Pass	Pass	N/A	N/A	Pass
Sep. 10, 2019	3650	3700	3.039	36.271	Pass	Pass	Pass	N/A	N/A	Pass

**4.5 System Verification**

The measuring result for system verification is tabulated as below.

Test Date	Frequency (MHz)	1W Target SAR-1g (W/kg)	Measured SAR-1g (W/kg)	Normalized to 1W SAR-1g (W/kg)	Deviation (%)	Dipole S/N	Probe S/N	DAE S/N
Aug. 27, 2019	2450	53.10	12.70	50.80	-4.33	835	3971	1431
Sep. 10, 2019	3500	66.60	6.54	65.40	-1.80	1007	3650	861
Sep. 10, 2019	3700	69.00	7.23	72.30	4.78	1017	3650	861

**Note:**

Comparing to the reference SAR value provided by SPEAG, the validation data should be within its specification of 10 %. The result indicates the system check can meet the variation criterion and the plots can be referred to Appendix A of this report.

**4.6 Maximum Output Power**

**4.6.1 Maximum Target Conducted Power**

The maximum conducted average power (Unit: dBm) including tune-up tolerance is shown as below.

Mode	LTE 48
Maximum Target Power	18.0

**<WLAN 2.4G>**

Mode	Channel	Frequency (MHz)	Tune up Power
802.11b	1	2412	18.5
	6	2437	19.5
	11	2462	18.5
802.11g	1	2412	18.5
	6	2437	19.5
	11	2462	18.5
802.11n (HT20)	1	2412	18.0
	6	2437	19.5
	11	2462	18.5
802.11n (HT40)	3	2422	18.5
	6	2437	19.5
	9	2452	18.5

# FCC SAR Test Report

## 4.6.2 Measured Conducted Power Result

The measuring conducted average power (Unit: dBm) is shown as below.

LTE Band 48																	
BW	MCS Index	RB Size	RB Offset	Low	Mid	Mid	High	3GPP MPR (dB)	BW	MCS Index	RB Size	RB Offset	Low	Mid	Mid	High	3GPP MPR (dB)
		Channel		55340	55780	56210	56640				Channel		55315	55765	56215	56665	
		Frequency (MHz)		3560	3603	3647	3690				Frequency (MHz)		3557.5	3602.5	3647.5	3692.5	
20M	QPSK	1	0	17.32	17.75	17.94	17.30	0	15M	QPSK	1	0	17.25	17.65	17.85	17.24	0
		1	50	16.86	17.29	17.48	16.84	0			1	37	16.76	17.28	17.40	16.76	0
		1	99	17.10	17.53	17.72	17.08	0			1	74	17.06	17.48	17.71	17.04	0
		50	0	17.07	17.50	17.69	17.05	0			36	0	17.08	17.50	17.59	16.97	0
		50	25	16.93	17.36	17.55	16.91	0			36	19	16.83	17.27	17.50	16.89	0
		50	50	17.02	17.45	17.64	17.00	0			36	39	16.96	17.35	17.59	16.97	0
		100	0	16.98	17.41	17.60	16.96	0			75	0	16.95	17.40	17.50	16.87	0
	16QAM	1	0	17.30	17.73	17.92	17.28	0		16QAM	1	0	17.26	17.63	17.91	17.26	0
		1	50	17.00	17.43	17.62	16.98	0			1	37	16.95	17.43	17.56	16.93	0
		1	99	17.08	17.51	17.70	17.06	0			1	74	17.08	17.47	17.60	16.98	0
		50	0	17.11	17.54	17.73	17.09	0			36	0	17.06	17.46	17.66	17.08	0
		50	25	17.00	17.43	17.62	16.98	0			36	19	16.94	17.41	17.55	16.90	0
		50	50	16.92	17.35	17.54	16.90	0			36	39	16.84	17.30	17.54	16.86	0
		100	0	16.99	17.42	17.61	16.97	0			75	0	16.90	17.36	17.61	16.93	0

## <WLAN 2.4G>

Mode	Channel	Frequency (MHz)	Average Power
802.11b	1	2412	18.25
	6	2437	19.21
	11	2462	18.07

## 4.7 SAR Testing Results

### 4.7.1 SAR Test Reduction Considerations

#### <KDB 447498 D01, General RF Exposure Guidance>

Testing of other required channels within the operating mode of a frequency band is not required when the reported SAR for the mid-band or highest output power channel is:

- (1)  $\leq 0.8$  W/kg or 2.0 W/kg, for 1-g or 10-g respectively, when the transmission band is  $\leq 100$  MHz
- (2)  $\leq 0.6$  W/kg or 1.5 W/kg, for 1-g or 10-g respectively, when the transmission band is between 100 MHz and 200 MHz
- (3)  $\leq 0.4$  W/kg or 1.0 W/kg, for 1-g or 10-g respectively, when the transmission band is  $\geq 200$  MHz

When SAR is not measured at the maximum power level allowed for production units, the measured SAR will be scaled to the maximum tune-up tolerance limit to determine compliance. The scaling factor for the tune-up power is defined as maximum tune-up limit (mW) / measured conducted power (mW). The reported SAR would be calculated by measured SAR x tune-up power scaling factor.

The SAR has been measured with highest transmission duty factor supported by the test mode tools for WLAN and/or Bluetooth. When the transmission duty factor could not achieve 100%, the reported SAR will be scaled to 100% transmission duty factor to determine compliance at the maximum tune-up power. The scaling factor for the duty factor is defined as 100% / transmission duty cycle (%). The reported SAR would be calculated by measured SAR x tune-up power scaling factor x duty cycle scaling factor.

#### <KDB 941225 D05, SAR Evaluation Considerations for LTE Devices>

- (1) QPSK with 1 RB and 50% RB allocation

Start with the largest channel bandwidth and measure SAR, using the RB offset and required test channel combination with the highest maximum output power among RB offsets at the upper edge, middle and lower edge of each required test channel. When the reported SAR is  $\leq 0.8$  W/kg, testing of the remaining RB offset configurations and required test channels is not required; otherwise, SAR is required for the remaining required test channels and only for the RB offset configuration with the highest output power for that channel. When the reported SAR of a required test channel is  $> 1.45$  W/kg, SAR is required for all three RB offset configurations for that required test channel.

- (2) QPSK with 100% RB allocation

SAR is not required when the highest maximum output power for 100% RB allocation is less than the highest maximum output power in 50% and 1 RB allocations and the highest reported SAR for 1 RB and 50% RB allocation are  $\leq 0.8$  W/kg. Otherwise, SAR is measured for the highest output power channel; and if the reported SAR is  $> 1.45$  W/kg, the remaining required test channels must also be tested.

- (3) Higher order modulations

SAR is required only when the highest maximum output power for the configuration in the higher order modulation is  $> 1/2$  dB higher than the same configuration in QPSK or when the reported SAR for the QPSK configuration is  $> 1.45$  W/kg.

# FCC SAR Test Report

## (4) Other channel bandwidth

SAR is required when the highest maximum output power of the smaller channel bandwidth is >1/2 dB higher than the equivalent channel configurations in the largest channel bandwidth configuration or the reported SAR of a configuration for the largest channel bandwidth is > 1.45 W/kg.

### <KDB 248227 D01, SAR Guidance for Wi-Fi Transmitters>

- (1) For handsets operating next to ear, hotspot mode or mini-tablet configurations, the initial test position procedures were applied. The test position with the highest extrapolated peak SAR will be used as the initial test position. When the reported SAR of initial test position is  $\leq 0.4$  W/kg, SAR testing for remaining test positions is not required. Otherwise, SAR is evaluated at the subsequent highest peak SAR positions until the reported SAR result is  $\leq 0.8$  W/kg or all test positions are measured.
- (2) For WLAN 2.4 GHz, the highest measured maximum output power channel for DSSS was selected for SAR measurement. When the reported SAR is  $\leq 0.8$  W/kg, no further SAR testing is required. Otherwise, SAR is evaluated at the next highest measured output power channel. When any reported SAR is >1.2 W/kg, SAR is required for the third channel. For OFDM modes (802.11g/n), SAR is not required when the highest reported SAR for DSSS is adjusted by the ratio of OFDM to DSSS specified maximum output power and it is  $\leq 1.2$  W/kg.

### 4.7.2 SAR Results for Body Exposure Condition (Test Separation Distance is 5 mm)

Plot No.	Band	Mode	Test Position	Ch.	RB#	RB Offset	EUT condition	Max. Tune-up Power (dBm)	Measured Conducted Power (dBm)	Scaling Factor	Power Drift (dB)	Measured SAR-1g (W/kg)	Scaled SAR-1g (W/kg)
	LTE 48	QPSK20M	Horizontal Up	56210	1	0	Closing	18.0	17.94	1.01	0.17	0.982	0.99
	LTE 48	QPSK20M	Horizontal Down	56210	1	0	Closing	18.0	17.94	1.01	-0.11	0.865	0.87
	LTE 48	QPSK20M	Vertical Front	56210	1	0	Closing	18.0	17.94	1.01	0.06	0.277	0.28
	LTE 48	QPSK20M	Vertical Back	56210	1	0	Closing	18.0	17.94	1.01	0.07	0.371	0.37
	LTE 48	QPSK20M	Tip Mode	56210	1	0	Closing	18.0	17.94	1.01	0.19	0.105	0.11
	LTE 48	QPSK20M	Horizontal Up	56210	1	0	Opening 90 degree	18.0	17.94	1.01	-0.07	0.070	0.07
	LTE 48	QPSK20M	Horizontal Down	56210	1	0	Opening 90 degree	18.0	17.94	1.01	0.17	0.097	0.10
	LTE 48	QPSK20M	Vertical Front	56210	1	0	Opening 90 degree	18.0	17.94	1.01	0.09	0.224	0.23
	LTE 48	QPSK20M	Vertical Back	56210	1	0	Opening 90 degree	18.0	17.94	1.01	0.03	0.506	0.51
	LTE 48	QPSK20M	Tip Mode	56210	1	0	Opening 90 degree	18.0	17.94	1.01	-0.08	1.03	1.04
	LTE 48	QPSK20M	Horizontal Up	56210	1	0	Opening 180 degree	18.0	17.94	1.01	-0.07	1.05	1.06
	LTE 48	QPSK20M	Horizontal Down	56210	1	0	Opening 180 degree	18.0	17.94	1.01	0.14	0.609	0.62
	LTE 48	QPSK20M	Vertical Front	56210	1	0	Opening 180 degree	18.0	17.94	1.01	-0.03	0.217	0.22
	LTE 48	QPSK20M	Vertical Back	56210	1	0	Opening 180 degree	18.0	17.94	1.01	-0.11	0.550	0.56
	LTE 48	QPSK20M	Tip Mode	56210	1	0	Opening 180 degree	18.0	17.94	1.01	0.19	0.102	0.10
	LTE 48	QPSK20M	Horizontal Up	56210	50	0	Closing	18.0	17.69	1.07	-0.08	0.941	1.01
	LTE 48	QPSK20M	Horizontal Down	56210	50	0	Closing	18.0	17.69	1.07	0.02	0.771	0.82
	LTE 48	QPSK20M	Vertical Front	56210	50	0	Closing	18.0	17.69	1.07	-0.07	0.214	0.23
	LTE 48	QPSK20M	Vertical Back	56210	50	0	Closing	18.0	17.69	1.07	0.13	0.275	0.29
	LTE 48	QPSK20M	Tip Mode	56210	50	0	Closing	18.0	17.69	1.07	-0.11	0.077	0.08
	LTE 48	QPSK20M	Horizontal Up	56210	50	0	Opening 90 degree	18.0	17.69	1.07	0.05	0.021	0.02
	LTE 48	QPSK20M	Horizontal Down	56210	50	0	Opening 90 degree	18.0	17.69	1.07	0.09	0.051	0.05
	LTE 48	QPSK20M	Vertical Front	56210	50	0	Opening 90 degree	18.0	17.69	1.07	-0.12	0.101	0.11
	LTE 48	QPSK20M	Vertical Back	56210	50	0	Opening 90 degree	18.0	17.69	1.07	0.08	0.343	0.37
	LTE 48	QPSK20M	Tip Mode	56210	50	0	Opening 90 degree	18.0	17.69	1.07	-0.07	0.853	0.91
	LTE 48	QPSK20M	Horizontal Up	56210	50	0	Opening 180 degree	18.0	17.69	1.07	0.03	0.93	1.00
	LTE 48	QPSK20M	Horizontal Down	56210	50	0	Opening 180 degree	18.0	17.69	1.07	-0.09	0.618	0.66
	LTE 48	QPSK20M	Vertical Front	56210	50	0	Opening 180 degree	18.0	17.69	1.07	0.07	0.121	0.13
	LTE 48	QPSK20M	Vertical Back	56210	50	0	Opening 180 degree	18.0	17.69	1.07	0.02	0.382	0.41
	LTE 48	QPSK20M	Tip Mode	56210	50	0	Opening 180 degree	18.0	17.69	1.07	0.00	0.098	0.10



# FCC SAR Test Report

Plot No.	Band	Mode	Test Position	Ch.	RB#	RB Offset	EUT condition	Max. Tune-up Power (dBm)	Measured Conducted Power (dBm)	Scaling Factor	Power Drift (dB)	Measured SAR-1g (W/kg)	Scaled SAR-1g (W/kg)
	LTE 48	QPSK20M	Horizontal Up	55340	1	0	Closing	18.0	17.32	1.17	-0.09	0.834	0.98
	LTE 48	QPSK20M	Horizontal Up	55780	1	0	Closing	18.0	17.75	1.06	0.12	0.948	1.00
	LTE 48	QPSK20M	Horizontal Up	56640	1	0	Closing	18.0	17.30	1.17	-0.03	0.822	0.96
	LTE 48	QPSK20M	Horizontal Down	55340	1	0	Closing	18.0	17.32	1.17	-0.08	0.735	0.86
	LTE 48	QPSK20M	Horizontal Down	55780	1	0	Closing	18.0	17.75	1.06	0.02	0.836	0.89
	LTE 48	QPSK20M	Horizontal Down	56640	1	0	Closing	18.0	17.30	1.17	-0.07	0.724	0.85
	LTE 48	QPSK20M	Tip Mode	55340	1	0	Opening 90 degree	18.0	17.32	1.17	0.03	0.875	1.02
	LTE 48	QPSK20M	Tip Mode	55780	1	0	Opening 90 degree	18.0	17.75	1.06	-0.15	0.976	1.03
	LTE 48	QPSK20M	Tip Mode	56640	1	0	Opening 90 degree	18.0	17.30	1.17	0.09	0.862	1.01
	LTE 48	QPSK20M	Horizontal Up	55340	1	0	Opening 180 degree	18.0	17.32	1.17	-0.14	0.936	1.10
01	LTE 48	QPSK20M	Horizontal Up	55780	1	0	Opening 180 degree	18.0	17.75	1.06	0.09	1.05	1.11
	LTE 48	QPSK20M	Horizontal Up	56640	1	0	Opening 180 degree	18.0	17.30	1.17	0.16	0.928	1.09
	LTE 48	QPSK20M	Horizontal Up	55340	50	0	Closing	18.0	17.07	1.24	-0.07	0.799	0.99
	LTE 48	QPSK20M	Horizontal Up	55780	50	0	Closing	18.0	17.50	1.12	0.09	0.908	1.02
	LTE 48	QPSK20M	Horizontal Up	56640	50	0	Closing	18.0	17.05	1.24	-0.02	0.788	0.98
	LTE 48	QPSK20M	Horizontal Down	55340	50	0	Closing	18.0	17.07	1.24	0.07	0.655	0.81
	LTE 48	QPSK20M	Horizontal Down	55780	50	0	Closing	18.0	17.50	1.12	0.01	0.745	0.83
	LTE 48	QPSK20M	Horizontal Down	56640	50	0	Closing	18.0	17.05	1.24	0.13	0.645	0.80
	LTE 48	QPSK20M	Tip Mode	55340	50	0	Opening 90 degree	18.0	17.07	1.24	-0.06	0.725	0.90
	LTE 48	QPSK20M	Tip Mode	55780	50	0	Opening 90 degree	18.0	17.50	1.12	-0.13	0.825	0.92
	LTE 48	QPSK20M	Tip Mode	56640	50	0	Opening 90 degree	18.0	17.05	1.24	0.05	0.714	0.89
	LTE 48	QPSK20M	Horizontal Up	55340	50	0	Opening 180 degree	18.0	17.07	1.24	-0.09	0.789	0.98
	LTE 48	QPSK20M	Horizontal Up	55780	50	0	Opening 180 degree	18.0	17.50	1.12	0.02	0.899	1.01
	LTE 48	QPSK20M	Horizontal Up	56640	50	0	Opening 180 degree	18.0	17.05	1.24	0.02	0.779	0.97
	LTE 48	QPSK20M	Horizontal Up	56210	100	0	Closing	18.0	17.60	1.10	0.14	0.902	0.99
	LTE 48	QPSK20M	Horizontal Down	56210	100	0	Closing	18.0	17.60	1.10	-0.07	0.841	0.93
	LTE 48	QPSK20M	Tip Mode	56210	100	0	Opening 90 degree	18.0	17.60	1.10	0.15	0.987	1.09
	LTE 48	QPSK20M	Horizontal Up	56210	100	0	Opening 180 degree	18.0	17.60	1.10	-0.09	0.992	1.09
	LTE 48	QPSK20M	Horizontal Up	55780	1	0	Opening 180 degree	18.0	17.75	1.06	-0.15	1.01	1.07

Plot No.	Band	Mode	Test Position	Ch.	EUT condition	Duty Cycle	Crest Factor	Max. Tune-up Power (dBm)	Measured Conducted Power (dBm)	Scaling Factor	Power Drift (dB)	Measured SAR-1g (W/kg)	Scaled SAR-1g (W/kg)
	WLAN2.4G	802.11b	Horizontal Up	6	Closing	99.50	1.01	19.5	19.21	1.07	0.10	0.844	0.91
	WLAN2.4G	802.11b	Horizontal Down	6	Closing	99.50	1.01	19.5	19.21	1.07	-0.03	0.323	0.35
	WLAN2.4G	802.11b	Vertical Front	6	Closing	99.50	1.01	19.5	19.21	1.07	-0.11	0.608	0.66
	WLAN2.4G	802.11b	Vertical Back	6	Closing	99.50	1.01	19.5	19.21	1.07	-0.07	0.071	0.08
	WLAN2.4G	802.11b	Horizontal Up	6	Opening 90 degree	99.50	1.01	19.5	19.21	1.07	-0.01	0.819	0.89
	WLAN2.4G	802.11b	Horizontal Down	6	Opening 90 degree	99.50	1.01	19.5	19.21	1.07	0.10	0.014	0.02
	WLAN2.4G	802.11b	Vertical Front	6	Opening 90 degree	99.50	1.01	19.5	19.21	1.07	-0.14	0.860	0.93
	WLAN2.4G	802.11b	Vertical Back	6	Opening 90 degree	99.50	1.01	19.5	19.21	1.07	0.06	0.045	0.05
	WLAN2.4G	802.11b	Horizontal Up	6	Opening 180 degree	99.50	1.01	19.5	19.21	1.07	-0.15	0.616	0.67
	WLAN2.4G	802.11b	Horizontal Down	6	Opening 180 degree	99.50	1.01	19.5	19.21	1.07	-0.02	0.912	0.99
02	WLAN2.4G	802.11b	Vertical Front	6	Opening 180 degree	99.50	1.01	19.5	19.21	1.07	0.16	1.03	1.11
	WLAN2.4G	802.11b	Vertical Back	6	Opening 180 degree	99.50	1.01	19.5	19.21	1.07	0.09	0.039	0.04
	WLAN2.4G	802.11b	Horizontal Up	1	Closing	99.50	1.01	18.5	18.25	1.06	0.17	0.556	0.60
	WLAN2.4G	802.11b	Horizontal Up	11	Closing	99.50	1.01	18.5	18.07	1.10	0.03	0.543	0.60
	WLAN2.4G	802.11b	Horizontal Up	1	Opening 90 degree	99.50	1.01	18.5	18.25	1.06	0.01	0.538	0.58
	WLAN2.4G	802.11b	Horizontal Up	11	Opening 90 degree	99.50	1.01	18.5	18.07	1.10	-0.11	0.521	0.58
	WLAN2.4G	802.11b	Vertical Front	1	Opening 90 degree	99.50	1.01	18.5	18.25	1.06	0.16	0.567	0.61
	WLAN2.4G	802.11b	Vertical Front	11	Opening 90 degree	99.50	1.01	18.5	18.07	1.10	0.03	0.553	0.61
	WLAN2.4G	802.11b	Horizontal Down	1	Opening 180 degree	99.50	1.01	18.5	18.25	1.06	-0.02	0.601	0.64
	WLAN2.4G	802.11b	Horizontal Down	11	Opening 180 degree	99.50	1.01	18.5	18.07	1.10	-0.04	0.586	0.65
	WLAN2.4G	802.11b	Vertical Front	1	Opening 180 degree	99.50	1.01	18.5	18.25	1.06	0.02	0.679	0.73
	WLAN2.4G	802.11b	Vertical Front	11	Opening 180 degree	99.50	1.01	18.5	18.07	1.10	0.11	0.662	0.74
	WLAN2.4G	802.11b	Vertical Front	6	Opening 180 degree	99.50	1.01	19.5	19.21	1.07	0.04	0.985	1.06

## FCC SAR Test Report

### 4.7.3 SAR Measurement Variability

According to KDB 865664 D01, SAR measurement variability was assessed for each frequency band, which is determined by the SAR probe calibration point and tissue-equivalent medium used for the device measurements. When both head and body tissue-equivalent media are required for SAR measurements in a frequency band, the variability measurement procedures should be applied to the tissue medium with the highest measured SAR, using the highest measured SAR configuration for that tissue-equivalent medium. Alternatively, if the highest measured SAR for both head and body tissue-equivalent media are  $\leq 1.45$  W/kg and the ratio of these highest SAR values, i.e., largest divided by smallest value, is  $\leq 1.10$ , the highest SAR configuration for either head or body tissue-equivalent medium may be used to perform the repeated measurement. These additional measurements are repeated after the completion of all measurements requiring the same head or body tissue-equivalent medium in a frequency band. The test device should be returned to ambient conditions (normal room temperature) with the battery fully charged before it is re-mounted on the device holder for the repeated measurement(s) to minimize any unexpected variations in the repeated results.

SAR repeated measurement procedure:

1. When the highest measured SAR is  $< 0.80$  W/kg, repeated measurement is not required.
2. When the highest measured SAR is  $\geq 0.80$  W/kg, repeat that measurement once.
3. If the ratio of largest to smallest SAR for the original and first repeated measurements is  $> 1.20$ , or when the original or repeated measurement is  $\geq 1.45$  W/kg, perform a second repeated measurement.
4. If the ratio of largest to smallest SAR for the original, first and second repeated measurements is  $> 1.20$ , and the original, first or second repeated measurement is  $\geq 1.5$  W/kg, perform a third repeated measurement.

Band	Mode	Test Position	Ch.	Original Measured SAR-1g (W/kg)	1st Repeated SAR-1g (W/kg)	L/S Ratio	2nd Repeated SAR-1g (W/kg)	L/S Ratio	3rd Repeated SAR-1g (W/kg)	L/S Ratio
LTE 48	QPSK20M	Horizontal Up	55780	1.05	1.01	1.04	N/A	N/A	N/A	N/A
WLAN2.4G	802.11b	Vertical Front	6	1.03	0.985	1.05	N/A	N/A	N/A	N/A

### 4.7.4 Simultaneous Multi-band Transmission Evaluation

There is no simultaneous transmission configuration in this device.

Test Engineer : Kevin Yao, and Sam Onn

## 5. Calibration of Test Equipment

Equipment	Manufacturer	Model	SN	Cal. Date	Cal. Interval
System Validation Dipole	SPEAG	D2450V2	835	Jun. 27, 2019	1 Year
System Validation Dipole	SPEAG	D3500V2	1007	Jan. 29, 2019	1 Year
System Validation Dipole	SPEAG	D3700V2	1017	Sep. 24, 2018	1 Year
Dosimetric E-Field Probe	SPEAG	EX3DV4	3650	May. 20, 2019	1 Year
Dosimetric E-Field Probe	SPEAG	EX3DV4	3971	Mar. 29, 2019	1 Year
Data Acquisition Electronics	SPEAG	DAE4	1431	Mar. 25, 2019	1 Year
Data Acquisition Electronics	SPEAG	DAE4	861	May. 08, 2019	1 Year
Radio Communication Analyzer	Anritsu	MT8821C	6201381727	Jun. 14, 2019	1 Year
Spectrum Analyzer	R&S	FSL6	102006	Mar. 26, 2019	1 Year
ENA Series Network Analyzer	Agilent	E5071C	MY46214281	Jun. 17, 2019	1 Year
MXG Analog Signal Generator	Agilent	N5181A	MY50143868	Jun. 27, 2019	1 Year
Power Meter	Anritsu	ML2495A	1218009	Jun. 28, 2019	1 Year
Power Sensor	Anritsu	MA2411B	1207252	Jun. 28, 2019	1 Year
Thermometer	YFE	YF-160A	130504591	Mar. 22, 2019	1 Year

## 6. Measurement Uncertainty

According to KDB 865664 D01, SAR measurement uncertainty analysis is required in SAR reports only when the highest measured SAR in a frequency band is  $\geq 1.5$  W/kg for 1-g SAR, and  $\geq 3.75$  W/kg for 10-g SAR. The procedures described in IEEE Std 1528-2013 should be applied. The expanded SAR measurement uncertainty must be  $\leq 30\%$ , for a confidence interval of  $k = 2$ . When the highest measured SAR within a frequency band is  $< 1.5$  W/kg for 1-g and  $< 3.75$  W/kg for 10-g, the extensive SAR measurement uncertainty analysis described in IEEE Std 1528-2013 is not required in SAR reports submitted for equipment approval. Hence, the measurement uncertainty analysis is not required in this SAR report because the test result met the condition.

## 7. Information of the Testing Laboratories

We, Bureau Veritas Consumer Products Services (H.K.) Ltd., Taoyuan Branch, were founded in 1988 to provide our best service in EMC, Radio, Telecom and Safety consultation. Our laboratories are accredited and approved according to ISO/IEC 17025.

If you have any comments, please feel free to contact us at the following:

**Taiwan Huaya Lab:**

Add: No. 19, Huaya 2nd Rd., Guishan Dist., Taoyuan City 333, Taiwan

Tel: +886-(0)3-318-3232

Fax: +886-(0)3-211-5834

**Taiwan Linkou Lab:**

Add: No. 47-2, Baodoucuokeng, Linkou Dist., New Taipei City 244, Taiwan

Tel: +886-(0)2-2605-2180

Fax: +886-(0)2-2605-2943

**Taiwan Hsinchu Lab1:**

Add: E-2, No. 1, Lixing 1st Rd., East Dist., Hsinchu City 300, Taiwan

Tel: +886-(0)3-666-8565

Fax: +886-(0)3-666-8323

**Taiwan Hsinchu Lab2:**

Add: No. 49, Ln. 206, Wende Rd., Qionglin Township, Hsinchu County 307, Taiwan

Tel: +886-(0)3-512-0595

Fax: +886-(0)3-512-0568

**Taiwan Xindian Lab:**

Add: B2F., No. 215, Sec. 3, Beixin Rd., Xindian Dist., New Taipei City 231, Taiwan

Tel: +886-(0)2-8914-5882

Fax: +886-(0)2-8914-5840

**Email:** [service.adt@tw.bureauveritas.com](mailto:service.adt@tw.bureauveritas.com)

**Web Site:** <https://ee.bureauveritas.com.tw/BVInternet/Default>

The road map of all our labs can be found in our web site also.

---END---

## Appendix A. SAR Plots of System Verification

The plots for system verification with largest deviation for each SAR system combination are shown as follows.

## System Check\_H2450\_190827

**DUT: Dipole 2450 MHz; Type: D2450V2; SN: 835**

Communication System: CW; Frequency: 2450 MHz; Duty Cycle: 1:1

Medium: H19T27N1\_0827 Medium parameters used:  $f = 2450$  MHz;  $\sigma = 1.882$  S/m;  $\epsilon_r = 38.31$ ;  $\rho = 1000$  kg/m<sup>3</sup>

Ambient Temperature : 23.5 °C ; Liquid Temperature : 23.1 °C

DASY5 Configuration:

- Probe: EX3DV4 - SN3971; ConvF(7.65, 7.65, 7.65); Calibrated: 2019/03/29
- Sensor-Surface: 1.4mm (Mechanical Surface Detection)
- Electronics: DAE4 Sn1431; Calibrated: 2019/03/25
- Phantom: Twin SAM Phantom\_1496; Type: QD000P40CB;
- Measurement SW: DASY52, Version 52.10 (2); SEMCAD X Version 14.6.12 (7470)

**Pin=250mW/Area Scan (81x81x1):** Interpolated grid: dx=1.200 mm, dy=1.200 mm  
Maximum value of SAR (interpolated) = 20.2 W/kg

**Pin=250mW/Zoom Scan (7x7x7)/Cube 0:** Measurement grid: dx=5mm, dy=5mm, dz=5mm  
Reference Value = 99.84 V/m; Power Drift = -0.03 dB  
Peak SAR (extrapolated) = 25.1 W/kg  
**SAR(1 g) = 12.7 W/kg; SAR(10 g) = 5.93 W/kg**  
Maximum value of SAR (measured) = 20.2 W/kg

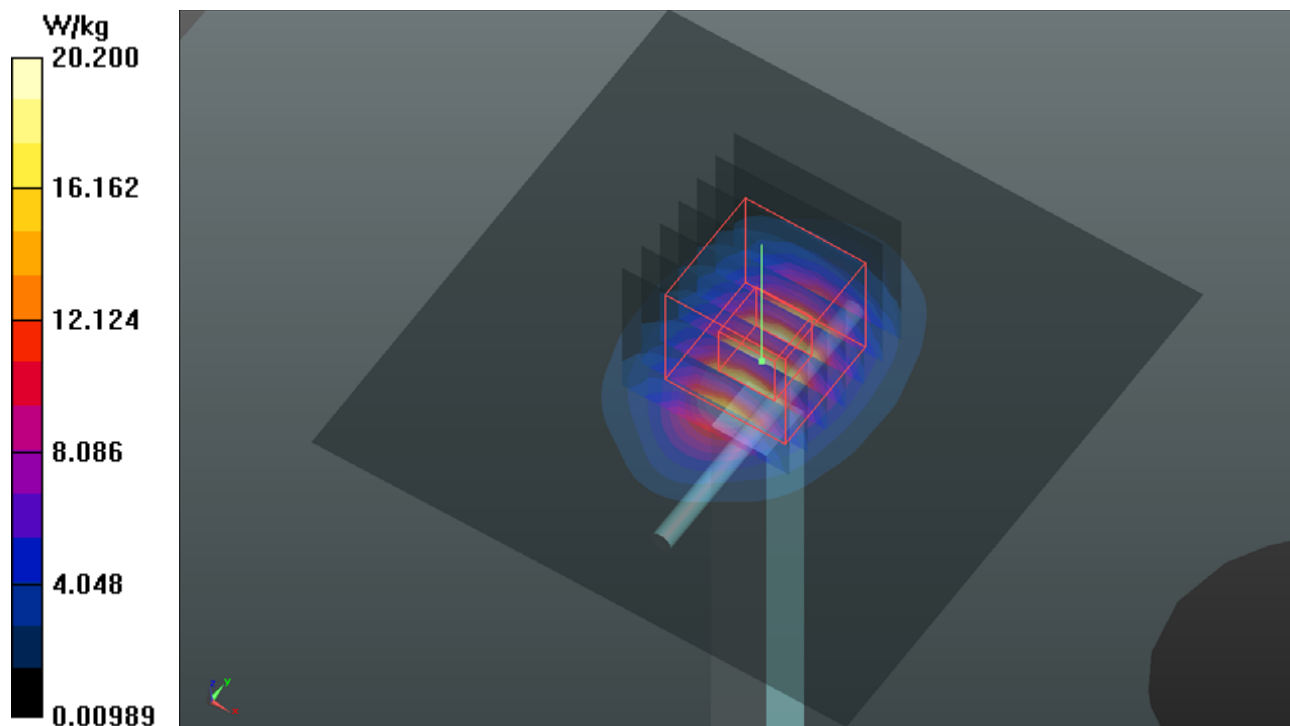

## System Check\_H3500\_190910

**DUT: Dipole 3500 MHz; Type:D3500V2; SN: 1007**

Communication System: CW; Frequency: 3500 MHz; Duty Cycle: 1:1

Medium: H34T38N1\_0910 Medium parameters used:  $f = 3500$  MHz;  $\sigma = 2.893$  S/m;  $\epsilon_r = 36.469$ ;  $\rho = 1000$  kg/m<sup>3</sup>

Ambient Temperature : 23.4 °C ; Liquid Temperature : 23.1 °C

DASY5 Configuration:

- Probe: EX3DV4 - SN3650; ConvF(6.93, 6.93, 6.93); Calibrated: 2019/05/20
- Sensor-Surface: 1.4mm (Mechanical Surface Detection)
- Electronics: DAE4 Sn861; Calibrated: 2019/05/08
- Phantom: Twin SAM Phantom\_1653; Type: QD000P40CD;
- Measurement SW: DASY52, Version 52.10 (2); SEMCAD X Version 14.6.12 (7470)

**Pin=100mW/Area Scan (41x41x1):** Interpolated grid: dx=1.200 mm, dy=1.200 mm

Maximum value of SAR (interpolated) = 11.2 W/kg

**Pin=100mW/Zoom Scan (7x7x8)/Cube 0:** Measurement grid: dx=5mm, dy=5mm, dz=4mm

Reference Value = 63.59 V/m; Power Drift = -0.06 dB

Peak SAR (extrapolated) = 17.2 W/kg

**SAR(1 g) = 6.54 W/kg; SAR(10 g) = 2.55 W/kg**

Maximum value of SAR (measured) = 11.3 W/kg

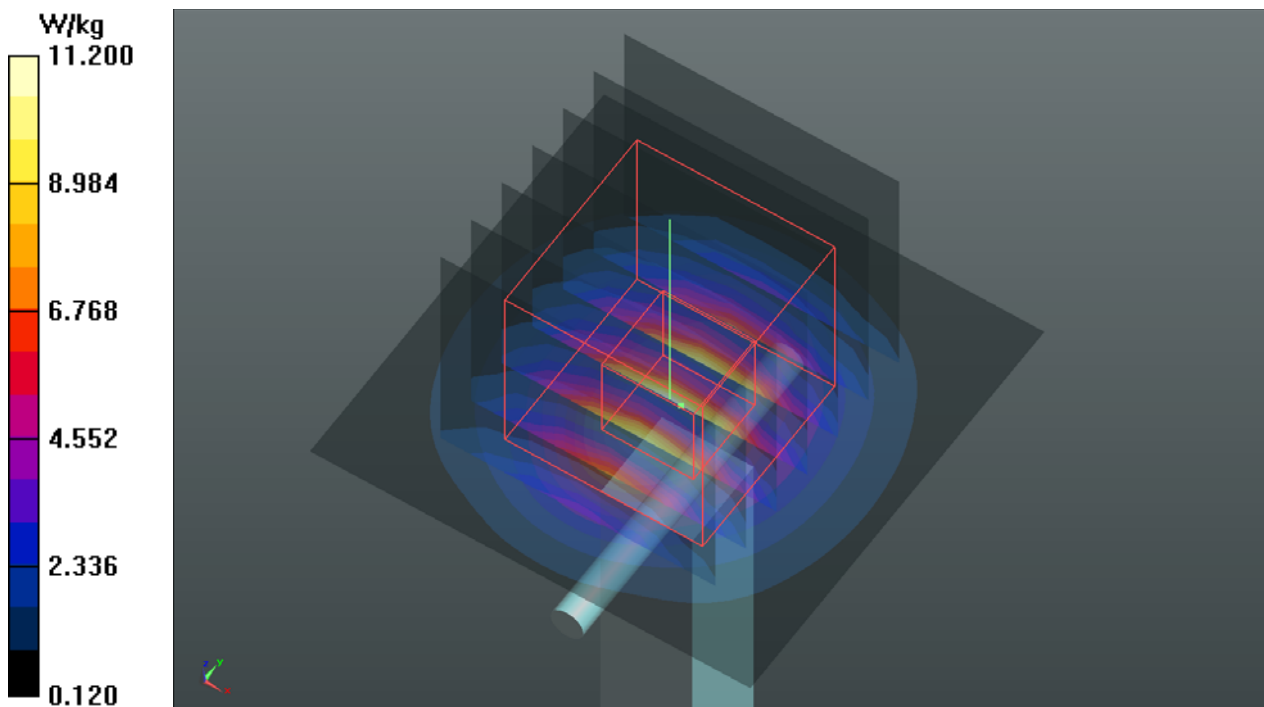



## System Check\_H3700\_190910

**DUT: Dipole 3700 MHz; Type: D3700V2; SN: 1017**

Communication System: CW; Frequency: 3700 MHz; Duty Cycle: 1:1

Medium: H34T38N1\_0910 Medium parameters used:  $f = 3700$  MHz;  $\sigma = 3.039$  S/m;  $\epsilon_r = 36.271$ ;  $\rho = 1000$  kg/m<sup>3</sup>

Ambient Temperature : 23.4 °C ; Liquid Temperature : 23.1 °C

DASY5 Configuration:

- Probe: EX3DV4 - SN3650; ConvF(6.71, 6.71, 6.71); Calibrated: 2019/05/20
- Sensor-Surface: 1.4mm (Mechanical Surface Detection)
- Electronics: DAE4 Sn861; Calibrated: 2019/05/08
- Phantom: Twin SAM Phantom\_1653; Type: QD000P40CD;
- Measurement SW: DASY52, Version 52.10 (2); SEMCAD X Version 14.6.12 (7470)

**Pin=100mW/Area Scan (41x41x1):** Interpolated grid: dx=1.200 mm, dy=1.200 mm

Maximum value of SAR (interpolated) = 14.1 W/kg

**Pin=100mW/Zoom Scan (7x7x8)/Cube 0:** Measurement grid: dx=5mm, dy=5mm, dz=4mm

Reference Value = 70.06 V/m; Power Drift = -0.09 dB

Peak SAR (extrapolated) = 17.8 W/kg

**SAR(1 g) = 7.23 W/kg; SAR(10 g) = 2.71 W/kg**

Maximum value of SAR (measured) = 14.8 W/kg

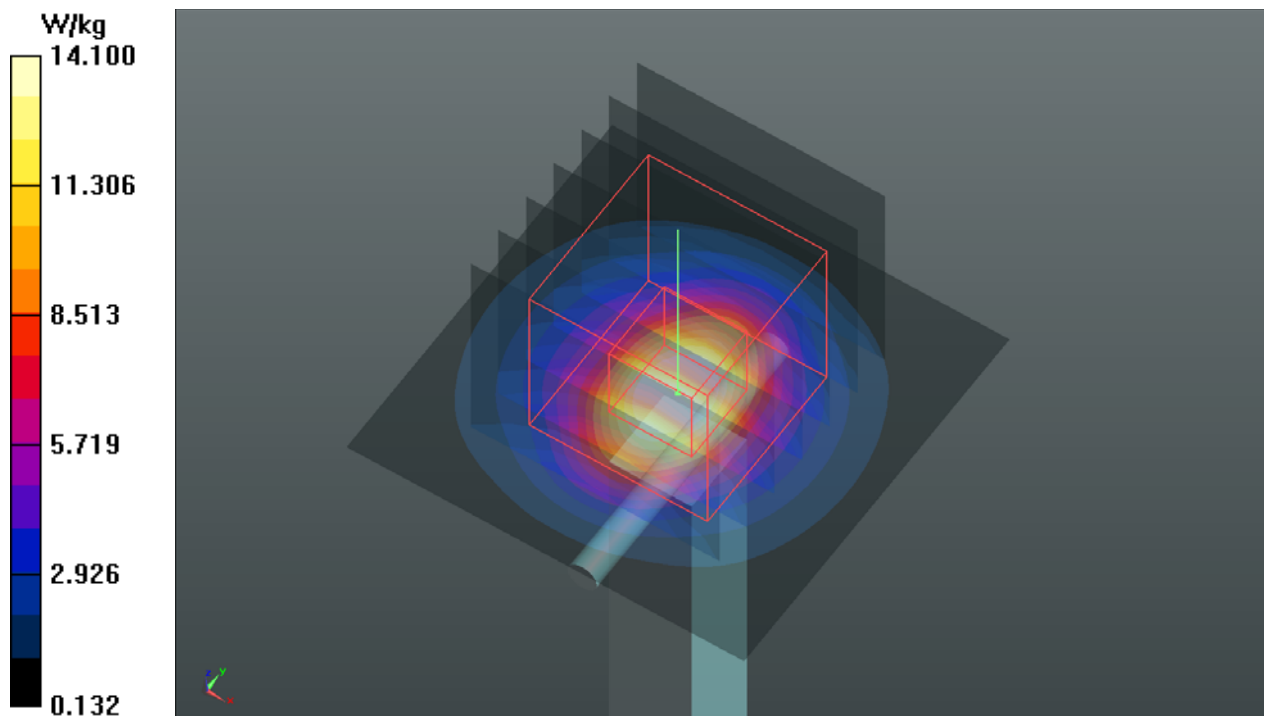



### Appendix B. SAR Plots of SAR Measurement

The SAR plots for highest measured SAR in each exposure configuration, wireless mode and frequency band combination, and measured SAR > 1.5 W/kg are shown as follows.

# P01 LTE 48\_QPSK20M\_Horizontal Up\_5mm\_Ch55780\_1RB\_OS0\_Opening 180 degree

**DUT: 190801D01**

Communication System: LTE TDD CF0; Frequency: 3603 MHz; Duty Cycle: 1:1.58  
Medium: H34T38N1\_0910 Medium parameters used:  $f = 3603$  MHz;  $\sigma = 2.966$  S/m;  $\epsilon_r = 36.357$ ;  $\rho = 1000$  kg/m<sup>3</sup>  
Ambient Temperature : 23.4 °C ; Liquid Temperature : 23.1 °C

### DASY5 Configuration:

- Probe: EX3DV4 - SN3650; ConvF(6.71, 6.71, 6.71); Calibrated: 2019/05/20
- Sensor-Surface: 1.4mm (Mechanical Surface Detection)
- Electronics: DAE4 Sn861; Calibrated: 2019/05/08
- Phantom: Twin SAM Phantom\_1653; Type: QD000P40CD;
- Measurement SW: DASY52, Version 52.10 (2); SEMCAD X Version 14.6.12 (7470)

- **Area Scan (51x161x1):** Interpolated grid: dx=1.200 mm, dy=1.200 mm  
Maximum value of SAR (interpolated) = 2.00 W/kg

- **Zoom Scan (5x5x8)/Cube 0:** Measurement grid: dx=7mm, dy=7mm, dz=4mm  
Reference Value = 22.97 V/m; Power Drift = 0.09 dB  
Peak SAR (extrapolated) = 2.61 W/kg  
**SAR(1 g) = 1.05 W/kg; SAR(10 g) = 0.431 W/kg**  
Maximum value of SAR (measured) = 1.95 W/kg

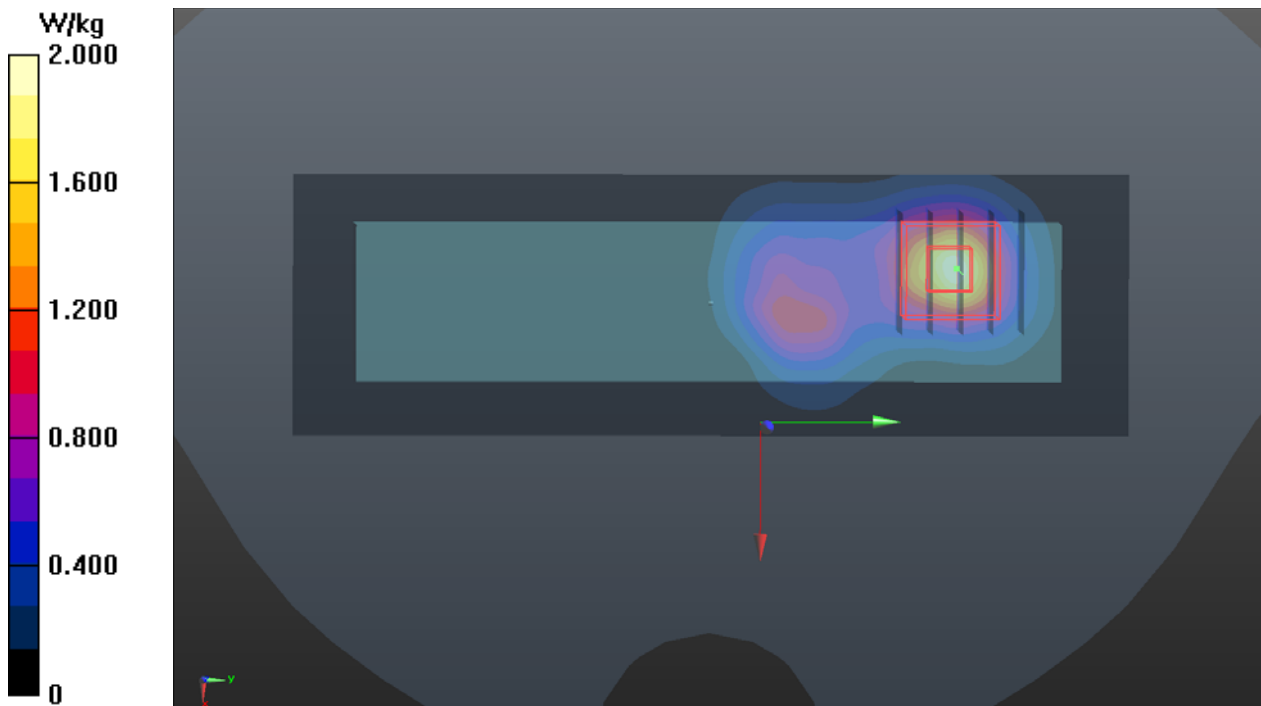

## P02 WLAN2.4G\_802.11b\_Verical Front\_5mm\_Ch6\_Opening 180 degree

**DUT: 190801D01**

Communication System: WLAN\_2.4G; Frequency: 2437 MHz; Duty Cycle: 1:1.01

Medium: H19T27N1\_0827 Medium parameters used:  $f = 2437$  MHz;  $\sigma = 1.868$  S/m;  $\epsilon_r = 38.359$ ;  $\rho = 1000$  kg/m<sup>3</sup>

Ambient Temperature : 23.5 °C ; Liquid Temperature : 23.1 °C

DASY5 Configuration:

- Probe: EX3DV4 - SN3971; ConvF(7.65, 7.65, 7.65); Calibrated: 2019/03/29
- Sensor-Surface: 1.4mm (Mechanical Surface Detection)
- Electronics: DAE4 Sn1431; Calibrated: 2019/03/25
- Phantom: Twin SAM Phantom\_1496; Type: QD000P40CB;
- Measurement SW: DASY52, Version 52.10 (2); SEMCAD X Version 14.6.12 (7470)

- **Area Scan (41x151x1):** Interpolated grid: dx=1.200 mm, dy=1.200 mm

Maximum value of SAR (interpolated) = 1.71 W/kg

- **Zoom Scan (5x5x7)/Cube 0:** Measurement grid: dx=8mm, dy=8mm, dz=5mm

Reference Value = 25.09 V/m; Power Drift = 0.16 dB

Peak SAR (extrapolated) = 2.08 W/kg

**SAR(1 g) = 1.03 W/kg; SAR(10 g) = 0.514 W/kg**

Maximum value of SAR (measured) = 1.64 W/kg

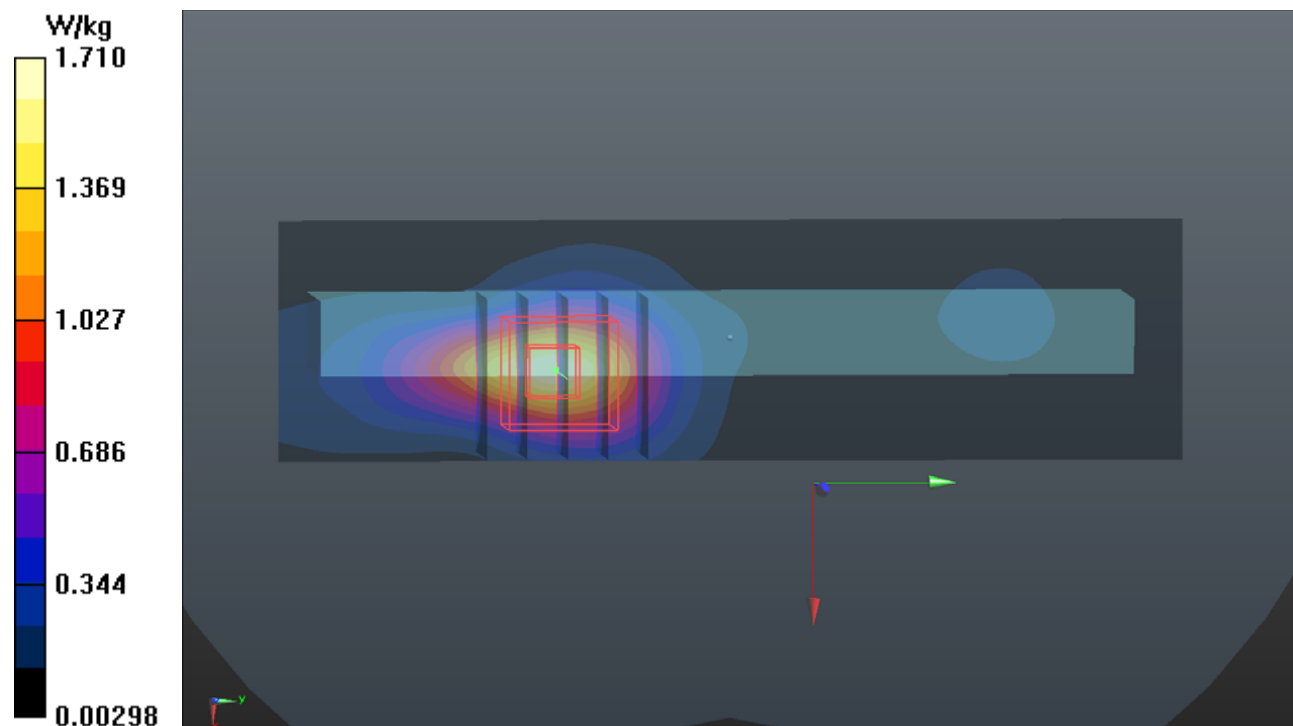



## **Appendix C. Calibration Certificate for Probe and Dipole**

The SPEAG calibration certificates are shown as follows.



Accredited by the Swiss Accreditation Service (SAS)  
The Swiss Accreditation Service is one of the signatories to the EA  
Multilateral Agreement for the recognition of calibration certificates

Accreditation No.: **SCS 0108**

Client **Auden**

Certificate No: **D2450V2-835\_Jun19**

## CALIBRATION CERTIFICATE

Object **D2450V2 - SN:835**

Calibration procedure(s) **QA CAL-05.v11  
Calibration Procedure for SAR Validation Sources between 0.7-3 GHz**

Calibration date: **June 27, 2019**

This calibration certificate documents the traceability to national standards, which realize the physical units of measurements (SI).  
The measurements and the uncertainties with confidence probability are given on the following pages and are part of the certificate.

All calibrations have been conducted in the closed laboratory facility: environment temperature ( $22 \pm 3$ )°C and humidity < 70%.

Calibration Equipment used (M&TE critical for calibration)

Primary Standards	ID #	Cal Date (Certificate No.)	Scheduled Calibration
Power meter NRP	SN: 104778	03-Apr-19 (No. 217-02892/02893)	Apr-20
Power sensor NRP-Z91	SN: 103244	03-Apr-19 (No. 217-02892)	Apr-20
Power sensor NRP-Z91	SN: 103245	03-Apr-19 (No. 217-02893)	Apr-20
Reference 20 dB Attenuator	SN: 5058 (20k)	04-Apr-19 (No. 217-02894)	Apr-20
Type-N mismatch combination	SN: 5047.2 / 06327	04-Apr-19 (No. 217-02895)	Apr-20
Reference Probe EX3DV4	SN: 7349	29-May-19 (No. EX3-7349_May19)	May-20
DAE4	SN: 601	30-Apr-19 (No. DAE4-601_Apr19)	Apr-20
Secondary Standards	ID #	Check Date (in house)	Scheduled Check
Power meter E4419B	SN: GB39512475	30-Oct-14 (in house check Feb-19)	In house check: Oct-20
Power sensor HP 8481A	SN: US37292783	07-Oct-15 (in house check Oct-18)	In house check: Oct-20
Power sensor HP 8481A	SN: MY41092317	07-Oct-15 (in house check Oct-18)	In house check: Oct-20
RF generator R&S SMT-06	SN: 100972	15-Jun-15 (in house check Oct-18)	In house check: Oct-20
Network Analyzer Agilent E8358A	SN: US41080477	31-Mar-14 (in house check Oct-18)	In house check: Oct-19

	Name	Function	Signature
Calibrated by:	Michael Weber	Laboratory Technician	
Approved by:	Katja Pokovic	Technical Manager	

Issued: June 27, 2019

This calibration certificate shall not be reproduced except in full without written approval of the laboratory.





Accredited by the Swiss Accreditation Service (SAS)  
The Swiss Accreditation Service is one of the signatories to the EA  
Multilateral Agreement for the recognition of calibration certificates

Accreditation No.: **SCS 0108**

**Glossary:**

TSL	tissue simulating liquid
ConvF	sensitivity in TSL / NORM x,y,z
N/A	not applicable or not measured

**Calibration is Performed According to the Following Standards:**

- a) IEEE Std 1528-2013, "IEEE Recommended Practice for Determining the Peak Spatial-Averaged Specific Absorption Rate (SAR) in the Human Head from Wireless Communications Devices: Measurement Techniques", June 2013
- b) IEC 62209-1, "Measurement procedure for the assessment of Specific Absorption Rate (SAR) from hand-held and body-mounted devices used next to the ear (frequency range of 300 MHz to 6 GHz)", July 2016
- c) IEC 62209-2, "Procedure to determine the Specific Absorption Rate (SAR) for wireless communication devices used in close proximity to the human body (frequency range of 30 MHz to 6 GHz)", March 2010
- d) KDB 865664, "SAR Measurement Requirements for 100 MHz to 6 GHz"

**Additional Documentation:**

- e) DASY4/5 System Handbook

**Methods Applied and Interpretation of Parameters:**

- *Measurement Conditions:* Further details are available from the Validation Report at the end of the certificate. All figures stated in the certificate are valid at the frequency indicated.
- *Antenna Parameters with TSL:* The dipole is mounted with the spacer to position its feed point exactly below the center marking of the flat phantom section, with the arms oriented parallel to the body axis.
- *Feed Point Impedance and Return Loss:* These parameters are measured with the dipole positioned under the liquid filled phantom. The impedance stated is transformed from the measurement at the SMA connector to the feed point. The Return Loss ensures low reflected power. No uncertainty required.
- *Electrical Delay:* One-way delay between the SMA connector and the antenna feed point. No uncertainty required.
- *SAR measured:* SAR measured at the stated antenna input power.
- *SAR normalized:* SAR as measured, normalized to an input power of 1 W at the antenna connector.
- *SAR for nominal TSL parameters:* The measured TSL parameters are used to calculate the nominal SAR result.

The reported uncertainty of measurement is stated as the standard uncertainty of measurement multiplied by the coverage factor  $k=2$ , which for a normal distribution corresponds to a coverage probability of approximately 95%.

## Measurement Conditions

DASY system configuration, as far as not given on page 1.

<b>DASY Version</b>	DASY5	V52.10.2
<b>Extrapolation</b>	Advanced Extrapolation	
<b>Phantom</b>	Modular Flat Phantom	
<b>Distance Dipole Center - TSL</b>	10 mm	with Spacer
<b>Zoom Scan Resolution</b>	dx, dy, dz = 5 mm	
<b>Frequency</b>	2450 MHz ± 1 MHz	

## Head TSL parameters

The following parameters and calculations were applied.

	Temperature	Permittivity	Conductivity
<b>Nominal Head TSL parameters</b>	22.0 °C	39.2	1.80 mho/m
<b>Measured Head TSL parameters</b>	(22.0 ± 0.2) °C	37.9 ± 6 %	1.86 mho/m ± 6 %
<b>Head TSL temperature change during test</b>	< 0.5 °C	----	----

## SAR result with Head TSL

<b>SAR averaged over 1 cm<sup>3</sup> (1 g) of Head TSL</b>	Condition	
SAR measured	250 mW input power	13.6 W/kg
SAR for nominal Head TSL parameters	normalized to 1W	<b>53.1 W/kg ± 17.0 % (k=2)</b>

<b>SAR averaged over 10 cm<sup>3</sup> (10 g) of Head TSL</b>	condition	
SAR measured	250 mW input power	6.30 W/kg
SAR for nominal Head TSL parameters	normalized to 1W	<b>24.9 W/kg ± 16.5 % (k=2)</b>

## Body TSL parameters

The following parameters and calculations were applied.

	Temperature	Permittivity	Conductivity
<b>Nominal Body TSL parameters</b>	22.0 °C	52.7	1.95 mho/m
<b>Measured Body TSL parameters</b>	(22.0 ± 0.2) °C	51.0 ± 6 %	2.03 mho/m ± 6 %
<b>Body TSL temperature change during test</b>	< 0.5 °C	----	----

## SAR result with Body TSL

<b>SAR averaged over 1 cm<sup>3</sup> (1 g) of Body TSL</b>	Condition	
SAR measured	250 mW input power	13.1 W/kg
SAR for nominal Body TSL parameters	normalized to 1W	<b>51.0 W/kg ± 17.0 % (k=2)</b>

<b>SAR averaged over 10 cm<sup>3</sup> (10 g) of Body TSL</b>	condition	
SAR measured	250 mW input power	6.14 W/kg
SAR for nominal Body TSL parameters	normalized to 1W	<b>24.2 W/kg ± 16.5 % (k=2)</b>



## Appendix (Additional assessments outside the scope of SCS 0108)

### Antenna Parameters with Head TSL

Impedance, transformed to feed point	54.0 $\Omega$ + 5.3 j $\Omega$
Return Loss	- 23.9 dB

### Antenna Parameters with Body TSL

Impedance, transformed to feed point	50.1 $\Omega$ + 7.3 j $\Omega$
Return Loss	- 22.8 dB

### General Antenna Parameters and Design

Electrical Delay (one direction)	1.160 ns
----------------------------------	----------

After long term use with 100W radiated power, only a slight warming of the dipole near the feedpoint can be measured.

The dipole is made of standard semirigid coaxial cable. The center conductor of the feeding line is directly connected to the second arm of the dipole. The antenna is therefore short-circuited for DC-signals. On some of the dipoles, small end caps are added to the dipole arms in order to improve matching when loaded according to the position as explained in the "Measurement Conditions" paragraph. The SAR data are not affected by this change. The overall dipole length is still according to the Standard.

No excessive force must be applied to the dipole arms, because they might bend or the soldered connections near the feedpoint may be damaged.

### Additional EUT Data

Manufactured by	SPEAG
-----------------	-------

## DASY5 Validation Report for Head TSL

Date: 27.06.2019

Test Laboratory: SPEAG, Zurich, Switzerland

**DUT: Dipole 2450 MHz; Type: D2450V2; Serial: D2450V2 - SN:835**

Communication System: UID 0 - CW; Frequency: 2450 MHz

Medium parameters used:  $f = 2450$  MHz;  $\sigma = 1.86$  S/m;  $\epsilon_r = 37.9$ ;  $\rho = 1000$  kg/m<sup>3</sup>

Phantom section: Flat Section

Measurement Standard: DASY5 (IEEE/IEC/ANSI C63.19-2011)

DASY52 Configuration:

- Probe: EX3DV4 - SN7349; ConvF(7.9, 7.9, 7.9) @ 2450 MHz; Calibrated: 29.05.2019
- Sensor-Surface: 1.4mm (Mechanical Surface Detection)
- Electronics: DAE4 Sn601; Calibrated: 30.04.2019
- Phantom: Flat Phantom 5.0 (front); Type: QD 000 P50 AA; Serial: 1001
- DASY52 52.10.2(1504); SEMCAD X 14.6.12(7470)

### Dipole Calibration for Head Tissue/Pin=250 mW, d=10mm/Zoom Scan (7x7x7)/Cube 0:

Measurement grid: dx=5mm, dy=5mm, dz=5mm

Reference Value = 117.6 V/m; Power Drift = 0.02 dB

Peak SAR (extrapolated) = 26.8 W/kg

**SAR(1 g) = 13.6 W/kg; SAR(10 g) = 6.3 W/kg**

Maximum value of SAR (measured) = 22.3 W/kg

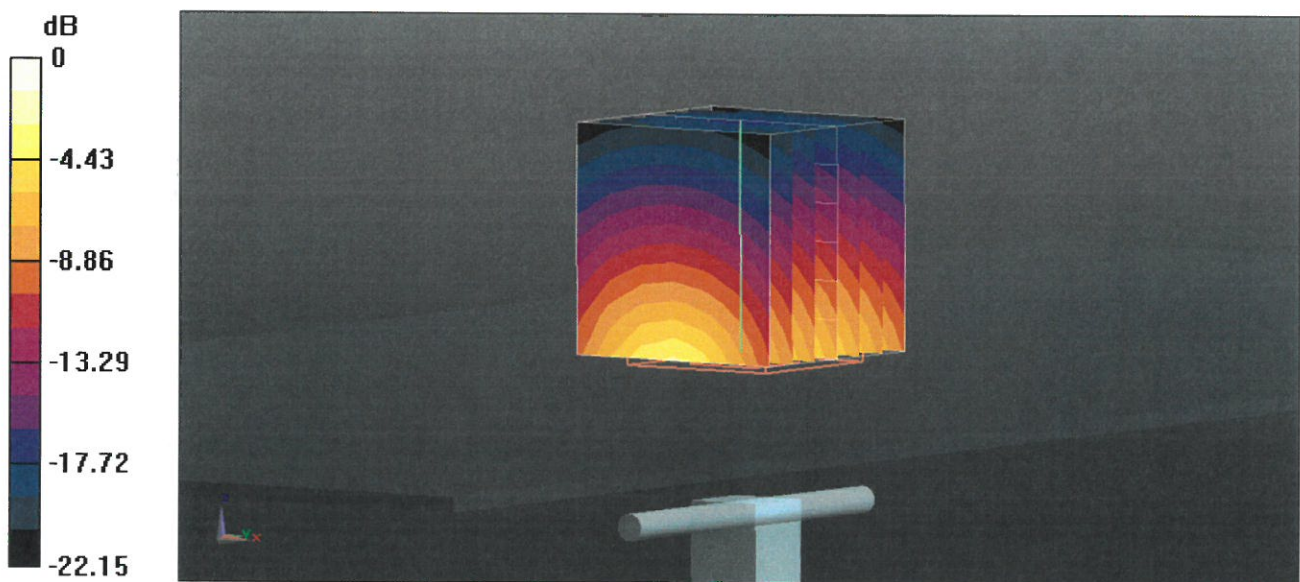

0 dB = 22.3 W/kg = 13.48 dBW/kg

# Impedance Measurement Plot for Head TSL

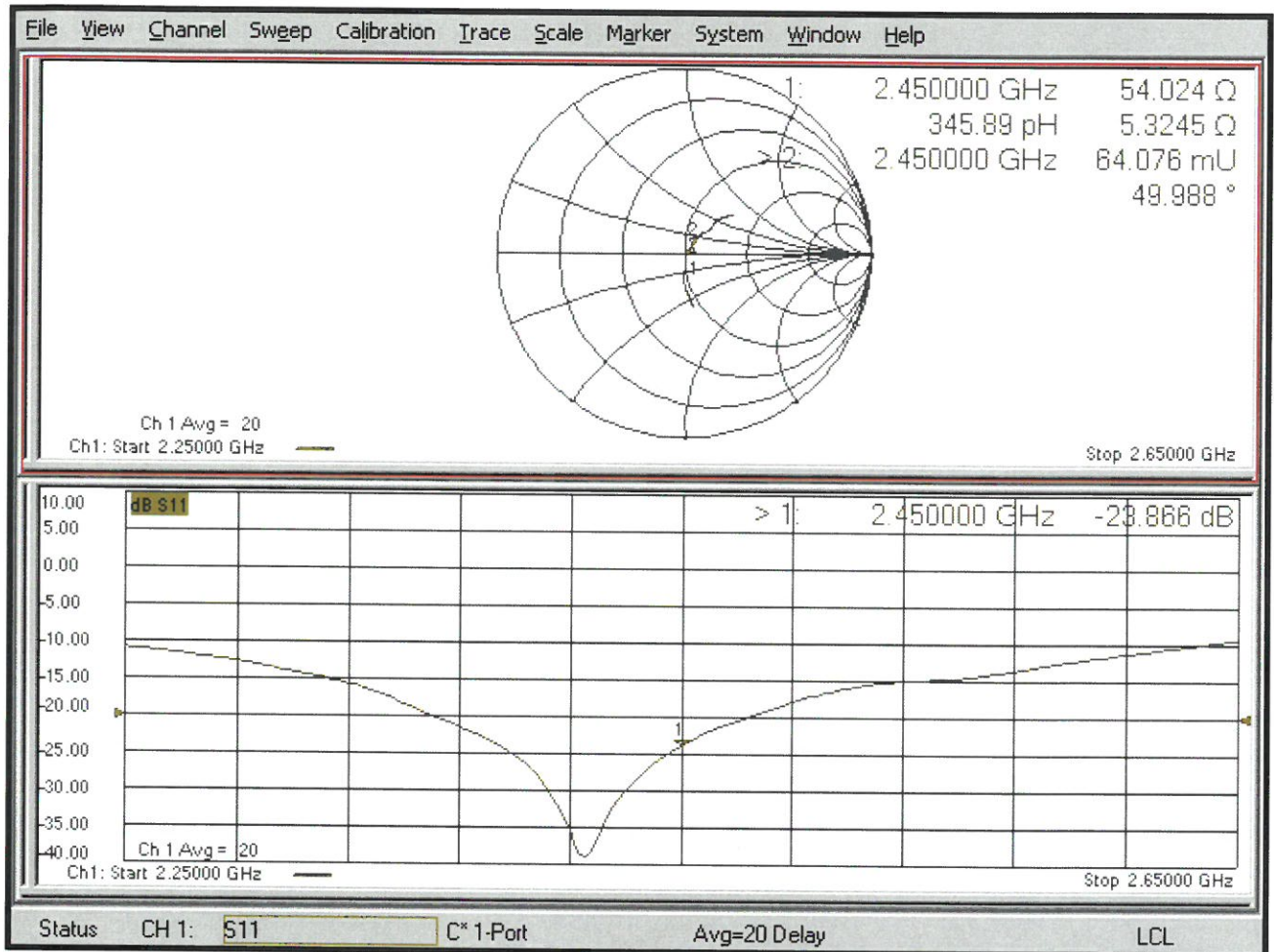



## DASY5 Validation Report for Body TSL

Date: 27.06.2019

Test Laboratory: SPEAG, Zurich, Switzerland

**DUT: Dipole 2450 MHz; Type: D2450V2; Serial: D2450V2 - SN:835**

Communication System: UID 0 - CW; Frequency: 2450 MHz

Medium parameters used:  $f = 2450$  MHz;  $\sigma = 2.03$  S/m;  $\epsilon_r = 51$ ;  $\rho = 1000$  kg/m<sup>3</sup>

Phantom section: Flat Section

Measurement Standard: DASY5 (IEEE/IEC/ANSI C63.19-2011)

DASY52 Configuration:

- Probe: EX3DV4 - SN7349; ConvF(7.94, 7.94, 7.94) @ 2450 MHz; Calibrated: 29.05.2019
- Sensor-Surface: 1.4mm (Mechanical Surface Detection)
- Electronics: DAE4 Sn601; Calibrated: 30.04.2019
- Phantom: Flat Phantom 5.0 (back); Type: QD 000 P50 AA; Serial: 1002
- DASY52 52.10.2(1504); SEMCAD X 14.6.12(7470)

### Dipole Calibration for Body Tissue/Pin=250 mW, d=10mm/Zoom Scan (7x7x7)/Cube 0:

Measurement grid: dx=5mm, dy=5mm, dz=5mm

Reference Value = 108.4 V/m; Power Drift = -0.04 dB

Peak SAR (extrapolated) = 25.6 W/kg

**SAR(1 g) = 13.1 W/kg; SAR(10 g) = 6.14 W/kg**

Maximum value of SAR (measured) = 21.1 W/kg

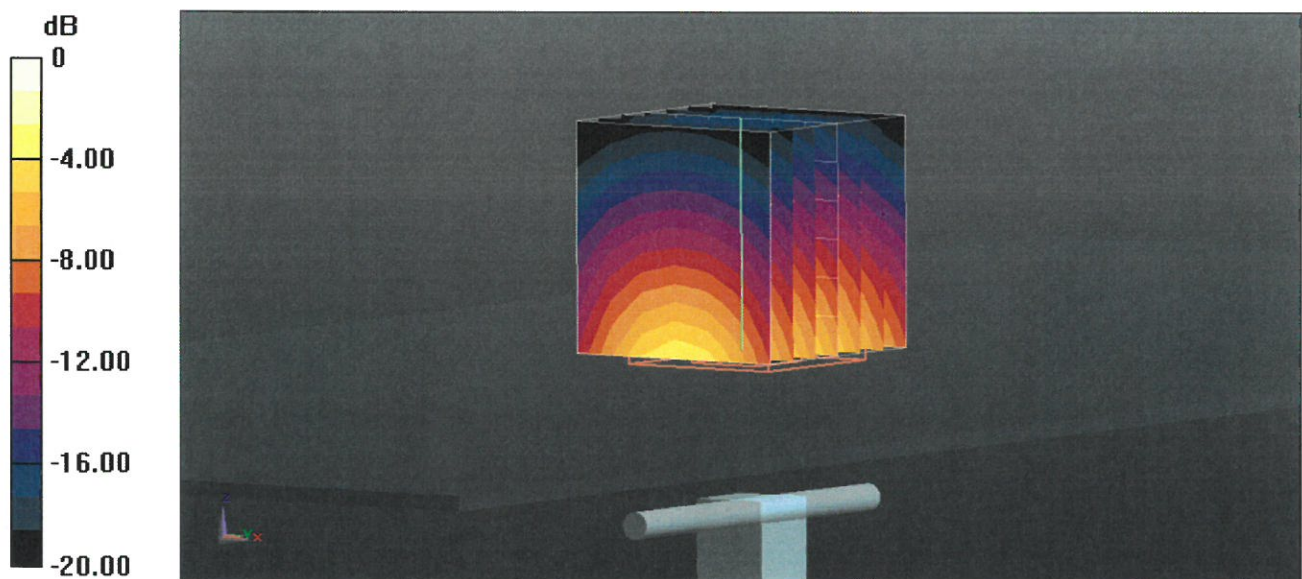

# Impedance Measurement Plot for Body TSL

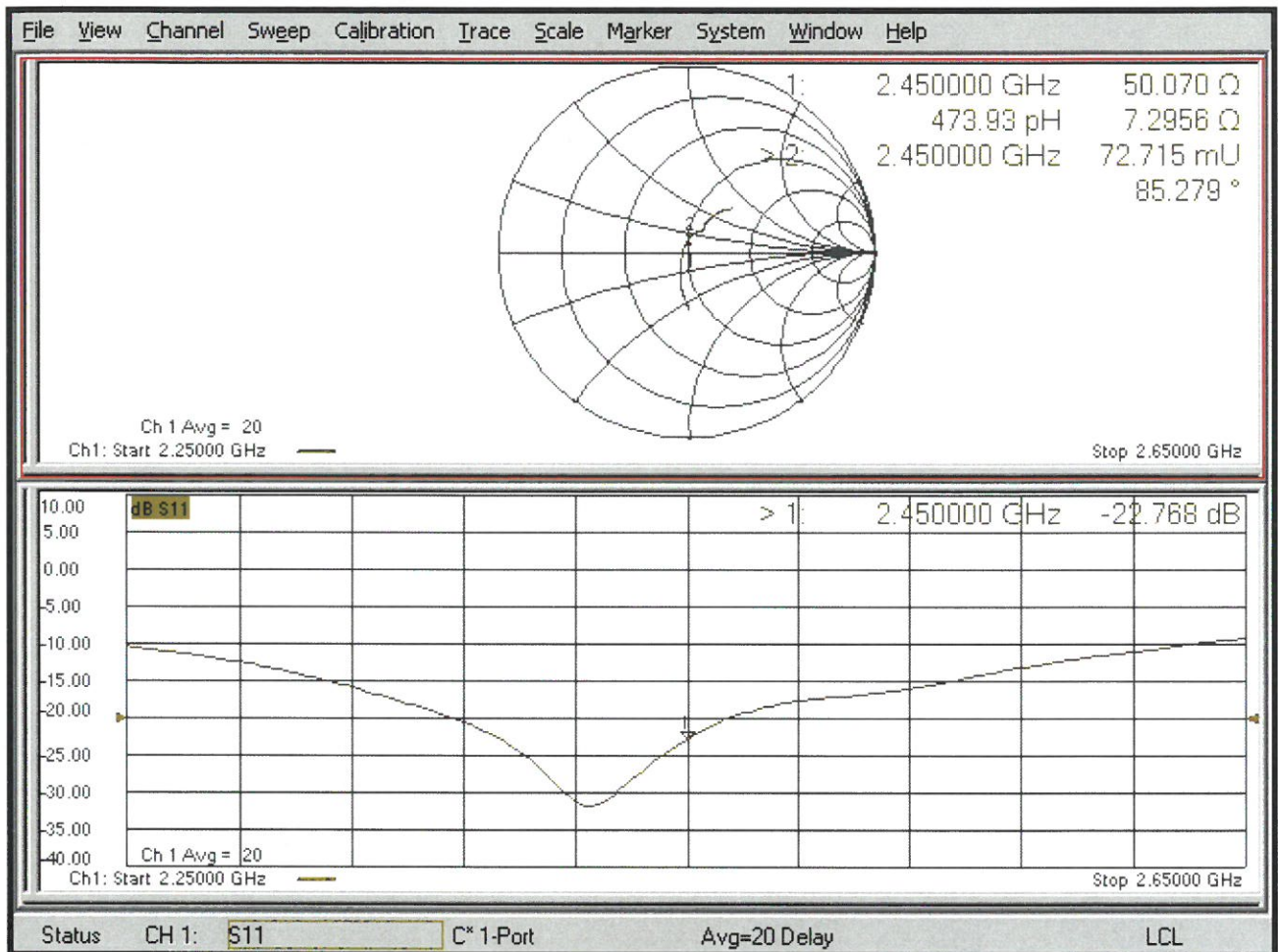



Accreditation No.: **SCS 0108**

Accredited by the Swiss Accreditation Service (SAS)

The Swiss Accreditation Service is one of the signatories to the EA Multilateral Agreement for the recognition of calibration certificates

Client **B.V. ADT (Auden)**

Certificate No: **D3500V2-1007\_Jan19**

## CALIBRATION CERTIFICATE

Object **D3500V2 - SN:1007**

Calibration procedure(s) **QA CAL-22.v4  
Calibration Procedure for SAR Validation Sources between 3-6 GHz**

Calibration date: **January 29, 2019**

This calibration certificate documents the traceability to national standards, which realize the physical units of measurements (SI). The measurements and the uncertainties with confidence probability are given on the following pages and are part of the certificate.

All calibrations have been conducted in the closed laboratory facility: environment temperature ( $22 \pm 3$ )°C and humidity < 70%.

Calibration Equipment used (M&TE critical for calibration)

Primary Standards	ID #	Cal Date (Certificate No.)	Scheduled Calibration
Power meter NRP	SN: 104778	04-Apr-18 (No. 217-02672/02673)	Apr-19
Power sensor NRP-Z91	SN: 103244	04-Apr-18 (No. 217-02672)	Apr-19
Power sensor NRP-Z91	SN: 103245	04-Apr-18 (No. 217-02673)	Apr-19
Reference 20 dB Attenuator	SN: 5058 (20k)	04-Apr-18 (No. 217-02682)	Apr-19
Type-N mismatch combination	SN: 5047.2 / 06327	04-Apr-18 (No. 217-02683)	Apr-19
Reference Probe EX3DV4	SN: 3503	31-Dec-18 (No. EX3-3503_Dec18)	Dec-19
DAE4	SN: 601	04-Oct-18 (No. DAE4-601_Oct18)	Oct-19

Secondary Standards	ID #	Check Date (in house)	Scheduled Check
Power meter EPM-442A	SN: GB37480704	07-Oct-15 (in house check Oct-18)	In house check: Oct-20
Power sensor HP 8481A	SN: US37292783	07-Oct-15 (in house check Oct-18)	In house check: Oct-20
Power sensor HP 8481A	SN: MY41092317	07-Oct-15 (in house check Oct-18)	In house check: Oct-20
RF generator R&S SMT-06	SN: 100972	15-Jun-15 (in house check Oct-18)	In house check: Oct-20
Network Analyzer Agilent E8358A	SN: US41080477	31-Mar-14 (in house check Oct-18)	In house check: Oct-19

Calibrated by:	<b>Jeton Kastrati</b>	Function <b>Laboratory Technician</b>	Signature 
Approved by:	<b>Katja Pokovic</b>	Technical Manager	

Issued: January 29, 2019

This calibration certificate shall not be reproduced except in full without written approval of the laboratory.





Accredited by the Swiss Accreditation Service (SAS)

The Swiss Accreditation Service is one of the signatories to the EA Multilateral Agreement for the recognition of calibration certificates

Accreditation No.: **SCS 0108**

### Glossary:

TSL	tissue simulating liquid
ConvF	sensitivity in TSL / NORM x,y,z
N/A	not applicable or not measured

### Calibration is Performed According to the Following Standards:

- IEEE Std 1528-2013, "IEEE Recommended Practice for Determining the Peak Spatial-Averaged Specific Absorption Rate (SAR) in the Human Head from Wireless Communications Devices: Measurement Techniques", June 2013
- IEC 62209-1, "Measurement procedure for the assessment of Specific Absorption Rate (SAR) from hand-held and body-mounted devices used next to the ear (frequency range of 300 MHz to 6 GHz)", July 2016
- IEC 62209-2, "Procedure to determine the Specific Absorption Rate (SAR) for wireless communication devices used in close proximity to the human body (frequency range of 30 MHz to 6 GHz)", March 2010
- KDB 865664, "SAR Measurement Requirements for 100 MHz to 6 GHz"

### Additional Documentation:

- DASY4/5 System Handbook

### Methods Applied and Interpretation of Parameters:

- Measurement Conditions:** Further details are available from the Validation Report at the end of the certificate. All figures stated in the certificate are valid at the frequency indicated.
- Antenna Parameters with TSL:** The dipole is mounted with the spacer to position its feed point exactly below the center marking of the flat phantom section, with the arms oriented parallel to the body axis.
- Feed Point Impedance and Return Loss:** These parameters are measured with the dipole positioned under the liquid filled phantom. The impedance stated is transformed from the measurement at the SMA connector to the feed point. The Return Loss ensures low reflected power. No uncertainty required.
- Electrical Delay:** One-way delay between the SMA connector and the antenna feed point. No uncertainty required.
- SAR measured:** SAR measured at the stated antenna input power.
- SAR normalized:** SAR as measured, normalized to an input power of 1 W at the antenna connector.
- SAR for nominal TSL parameters:** The measured TSL parameters are used to calculate the nominal SAR result.

The reported uncertainty of measurement is stated as the standard uncertainty of measurement multiplied by the coverage factor  $k=2$ , which for a normal distribution corresponds to a coverage probability of approximately 95%.

## Measurement Conditions

DASY system configuration, as far as not given on page 1.

DASY Version	DASY5	V52.10.2
Extrapolation	Advanced Extrapolation	
Phantom	Modular Flat Phantom	
Distance Dipole Center - TSL	10 mm	with Spacer
Zoom Scan Resolution	dx, dy = 4 mm, dz = 1.4 mm	Graded Ratio = 1.4 (Z direction)
Frequency	3500 MHz $\pm$ 1 MHz	

## Head TSL parameters

The following parameters and calculations were applied.

	Temperature	Permittivity	Conductivity
Nominal Head TSL parameters	22.0 °C	37.9	2.91 mho/m
Measured Head TSL parameters	(22.0 $\pm$ 0.2) °C	39.0 $\pm$ 6 %	2.89 mho/m $\pm$ 6 %
Head TSL temperature change during test	< 0.5 °C	----	----

## SAR result with Head TSL

SAR averaged over 1 cm <sup>3</sup> (1 g) of Head TSL	Condition	
SAR measured	100 mW input power	6.61 W/kg
SAR for nominal Head TSL parameters	normalized to 1W	<b>66.6 W/kg <math>\pm</math> 19.9 % (k=2)</b>

SAR averaged over 10 cm <sup>3</sup> (10 g) of Head TSL	condition	
SAR measured	100 mW input power	2.49 W/kg
SAR for nominal Head TSL parameters	normalized to 1W	<b>25.1 W/kg <math>\pm</math> 19.5 % (k=2)</b>

## Body TSL parameters

The following parameters and calculations were applied.

	Temperature	Permittivity	Conductivity
Nominal Body TSL parameters	22.0 °C	51.3	3.31 mho/m
Measured Body TSL parameters	(22.0 $\pm$ 0.2) °C	50.1 $\pm$ 6 %	3.28 mho/m $\pm$ 6 %
Body TSL temperature change during test	< 0.5 °C	----	----

## SAR result with Body TSL

SAR averaged over 1 cm <sup>3</sup> (1 g) of Body TSL	Condition	
SAR measured	100 mW input power	6.50 W/kg
SAR for nominal Body TSL parameters	normalized to 1W	<b>64.8 W/kg <math>\pm</math> 19.9 % (k=2)</b>

SAR averaged over 10 cm <sup>3</sup> (10 g) of Body TSL	condition	
SAR measured	100 mW input power	2.42 W/kg
SAR for nominal Body TSL parameters	normalized to 1W	<b>24.1 W/kg <math>\pm</math> 19.5 % (k=2)</b>



## Appendix (Additional assessments outside the scope of SCS 0108)

### Antenna Parameters with Head TSL

Impedance, transformed to feed point	52.7 $\Omega$ - 5.7 j $\Omega$
Return Loss	- 24.2 dB

### Antenna Parameters with Body TSL

Impedance, transformed to feed point	53.1 $\Omega$ - 4.2 j $\Omega$
Return Loss	- 25.9 dB

### General Antenna Parameters and Design

Electrical Delay (one direction)	1.134 ns
----------------------------------	----------

After long term use with 100W radiated power, only a slight warming of the dipole near the feedpoint can be measured.

The dipole is made of standard semirigid coaxial cable. The center conductor of the feeding line is directly connected to the second arm of the dipole. The antenna is therefore short-circuited for DC-signals. On some of the dipoles, small end caps are added to the dipole arms in order to improve matching when loaded according to the position as explained in the "Measurement Conditions" paragraph. The SAR data are not affected by this change. The overall dipole length is still according to the Standard.

No excessive force must be applied to the dipole arms, because they might bend or the soldered connections near the feedpoint may be damaged.

### Additional EUT Data

Manufactured by	SPEAG
-----------------	-------

## DASY5 Validation Report for Head TSL

Date: 29.01.2019

Test Laboratory: SPEAG, Zurich, Switzerland

**DUT: Dipole 3500 MHz; Type: D3500V2; Serial: D3500V2 - SN:1007**

Communication System: UID 0 - CW; Frequency: 3500 MHz

Medium parameters used:  $f = 3500$  MHz;  $\sigma = 2.89$  S/m;  $\epsilon_r = 39$ ;  $\rho = 1000$  kg/m<sup>3</sup>

Phantom section: Flat Section

Measurement Standard: DASY5 (IEEE/IEC/ANSI C63.19-2011)

DASY52 Configuration:

- Probe: EX3DV4 - SN3503; ConvF(7.6, 7.6, 7.6) @ 3500 MHz; Calibrated: 31.12.2018
- Sensor-Surface: 1.4mm (Mechanical Surface Detection)
- Electronics: DAE4 Sn601; Calibrated: 04.10.2018
- Phantom: Flat Phantom 5.0 (front); Type: QD 000 P50 AA; Serial: 1001
- DASY52 52.10.2(1495); SEMCAD X 14.6.12(7450)

### Dipole Calibration for Head Tissue/Pin=100 mW, d=10mm/Zoom Scan, dist=1.4mm

**(8x8x8)/Cube 0:** Measurement grid: dx=4mm, dy=4mm, dz=1.4mm

Reference Value = 71.58 V/m; Power Drift = -0.03 dB

Peak SAR (extrapolated) = 17.9 W/kg

**SAR(1 g) = 6.61 W/kg; SAR(10 g) = 2.49 W/kg**

Maximum value of SAR (measured) = 12.5 W/kg



0 dB = 12.5 W/kg = 10.97 dBW/kg