



FCC 47 CFR PART 15 SUBPART C

TEST REPORT

For

Wireless Network Camera

Model:

**iCamera2xxxxxxx(The “x” in model name can be 0 to 9, A to Z, blank or “-“,
for marking purpose)**

Trade Name: Sercomm

Issued to

Sercomm Corporation

8F, No. 3-1, YuanQu St., NanKang, Taipei 115, Taiwan, R.O.C.

Issued by

Compliance Certification Services Inc.

**No.11, Wugong 6th Rd., Wugu Dist.,
New Taipei City 24891, Taiwan. (R.O.C.)**

<http://www.ccsrf.com>

service@ccsrf.com

Issued Date: September 11, 2014



Note: This report shall not be reproduced except in full, without the written approval of Compliance Certification Services Inc. This document may be altered or revised by Compliance Certification Services Inc. personnel only, and shall be noted in the revision section of the document.



Revision History

Rev.	Issue Date	Revisions	Effect Page	Revised By
00	September 11, 2014	Initial Issue	ALL	Doris Chu



TABLE OF CONTENTS

1. TEST RESULT CERTIFICATION.....	4
2. EUT DESCRIPTION	5
3. TEST METHODOLOGY	6
3.1 EUT CONFIGURATION	6
3.2 EUT EXERCISE.....	6
3.3 GENERAL TEST PROCEDURES.....	6
3.4 FCC PART 15.205 RESTRICTED BANDS OF OPERATIONS.....	7
3.5 DESCRIPTION OF TEST MODES	8
4. INSTRUMENT CALIBRATION.....	9
4.1 MEASURING INSTRUMENT CALIBRATION	9
4.2 MEASUREMENT EQUIPMENT USED	9
4.3 MEASUREMENT UNCERTAINTY	10
5. FACILITIES AND ACCREDITATIONS	11
5.1 FACILITIES	11
5.2 EQUIPMENT.....	11
5.3 TABLE OF ACCREDITATIONS AND LISTINGS.....	12
6. SETUP OF EQUIPMENT UNDER TEST	13
6.1 SETUP CONFIGURATION OF EUT.....	13
6.2 SUPPORT EQUIPMENT	13
7. FCC PART 15.247 REQUIREMENTS.....	14
7.1 6DB BANDWIDTH.....	14
7.2 PEAK POWER.....	34
7.3 AVERAGE POWER	36
7.4 BAND EDGES MEASUREMENT	38
7.5 PEAK POWER SPECTRAL DENSITY.....	68
7.6 SPURIOUS EMISSIONS.....	88
7.7 RADIATED EMISSIONS	107
7.8 POWERLINE CONDUCTED EMISSIONS.....	124
APPENDIX 1 - PHOTOGRAPHS OF EUT	



1. TEST RESULT CERTIFICATION

Applicant: Sercomm Corporation
8F, No. 3-1, YuanQu St., NanKang, Taipei 115, Taiwan, R.O.C.

Equipment Under Test: Wireless Network Camera

Trade Name: Sercomm

Model Number: iCamera2xxxxxxxx(The "x" in model name can be 0 to 9, A to Z, blank or "-", for marking purpose)

Date of Test: September 2 ~ 4, 2014

APPLICABLE STANDARDS	
STANDARD	TEST RESULT
FCC 47 CFR Part 15 Subpart C	No non-compliance noted

We hereby certify that:

The above equipment was tested by Compliance Certification Services Inc. The test data, data evaluation, test procedures, and equipment configurations shown in this report were made in accordance with the procedures given in ANSI C63.4: 2009 and the energy emitted by the sample EUT tested as described in this report is in compliance with the requirements of FCC Rules Part 15.207, 15.209, 15.247.

The test results of this report relate only to the tested sample EUT identified in this report.

Approved by:

Reviewed by:

Miller Lee
Section Manager
Compliance Certification Services Inc.

Angel Cheng
Section Manager
Compliance Certification Services Inc.



2. EUT DESCRIPTION

Product	Wireless Network Camera
Trade Name	Sercomm
Model Number	iCamera2xxxxxxx(The "x" in model name can be 0 to 9, A to Z, blank or "-", for marking purpose)
Model Discrepancy	All the specification and layout are identical except they come with different model numbers for marketing purposes.
Received Date	July 16, 2014
Power Rating	Vdc form Power Adapter.
Power Adaptor Power Rating / Manufacturer	APD / WA-12M12FU Input:100-240V~,50-60Hz, 0.5A Max./Output:12V=1A
	Sunny / SYS1381-1212-W2 Input:100-240V~0.5A MAX,50-60Hz./Output:12V=1.0A
Frequency Range	IEEE 802.11b/g mode: 2412 ~ 2462 MHz IEEE 802.11n HT 20 MHz mode: 2412 ~ 2462 MHz IEEE 802.11n HT 40 MHz mode: 2422 ~ 2452 MHz
Transmit Power	IEEE 802.11b mode: 20.18 dBm IEEE 802.11g mode: 25.42 dBm IEEE 802.11n HT 20 mode: 27.01 dBm IEEE 802.11n HT 40 mode: 26.88 dBm
Modulation Technique	IEEE 802.11b mode: DSSS IEEE 802.11g mode: OFDM IEEE 802.11n HT 20 mode: OFDM IEEE 802.11n HT 40 mode: OFDM
Number of Channels	IEEE 802.11b/g mode: 11 Channels IEEE 802.11n HT 20 mode: 11 Channels IEEE 802.11n HT 40 mode: 7 Channels
Antenna Specification	PIFA Antenna / Gain: 2.02 dBi

Remark:

1. The sample selected for test was engineering sample that approximated to production product and was provided by manufacturer.
2. This submittal(s) (test report) is intended for FCC ID: **P27ICAMERA2** filing to comply with Section 15.207, 15.209 and 15.247 of the FCC Part 15, Subpart C Rules.



3. TEST METHODOLOGY The tests documented in this report were performed in accordance with ANSI C63.4: 2009 and FCC CFR 47 Part 15.207, 15.209, 15.247, KDB558074.

3.1 EUT CONFIGURATION

The EUT configuration for testing is installed on RF field strength measurement to meet the Commissions requirement and operating in a manner that intends to maximize its emission characteristics in a continuous normal application.

3.2 EUT EXERCISE

The EUT was operated in the engineering mode to fix the TX frequency that was for the purpose of the measurements.

According to its specifications, the EUT must comply with the requirements of the Section 15.207, 15.209 and 15.247 under the FCC Rules Part 15 Subpart C.

3.3 GENERAL TEST PROCEDURES

Conducted Emissions

The EUT is placed on the turntable, which is 0.8 m above ground plane. According to the requirements in Section 13.1.4.1 of ANSI C63.4 Conducted emissions from the EUT measured in the frequency range between 0.15 MHz and 30MHz using CISPR Quasi-peak and average detector modes.

Radiated Emissions

The EUT is placed on a turn table, which is 0.8 m above ground plane. The turntable shall rotate 360 degrees to determine the position of maximum emission level. EUT is set 3m away from the receiving antenna, which varied from 1m to 4m to find out the highest emission. And also, each emission was to be maximized by changing the polarization of receiving antenna both horizontal and vertical. In order to find out the maximum emissions, exploratory radiated emission measurements were made according to the requirements in Section 13.1.4.1 of ANSI C63.4.



3.4 FCC PART 15.205 RESTRICTED BANDS OF OPERATIONS

(a) Except as shown in paragraph (d) of this section, only spurious emissions are permitted in any of the frequency bands listed below:

MHz	MHz	MHz	GHz
0.090 - 0.110	16.42 - 16.423	399.9 - 410	4.5 - 5.15
¹ 0.495 - 0.505	16.69475 - 16.69525	608 - 614	5.35 - 5.46
2.1735 - 2.1905	16.80425 - 16.80475	960 - 1240	7.25 - 7.75
4.125 - 4.128	25.5 - 25.67	1300 - 1427	8.025 - 8.5
4.17725 - 4.17775	37.5 - 38.25	1435 - 1626.5	9.0 - 9.2
4.20725 - 4.20775	73 - 74.6	1645.5 - 1646.5	9.3 - 9.5
6.215 - 6.218	74.8 - 75.2	1660 - 1710	10.6 - 12.7
6.26775 - 6.26825	108 - 121.94	1718.8 - 1722.2	13.25 - 13.4
6.31175 - 6.31225	123 - 138	2200 - 2300	14.47 - 14.5
8.291 - 8.294	149.9 - 150.05	2310 - 2390	15.35 - 16.2
8.362 - 8.366	156.52475 -	2483.5 - 2500	17.7 - 21.4
8.37625 - 8.38675	156.52525	2655 - 2900	22.01 - 23.12
8.41425 - 8.41475	156.7 - 156.9	3260 - 3267	23.6 - 24.0
12.29 - 12.293	162.0125 - 167.17	3332 - 3339	31.2 - 31.8
12.51975 - 12.52025	167.72 - 173.2	3345.8 - 3358	36.43 - 36.5
12.57675 - 12.57725	240 - 285	3600 - 4400	(²)
13.36 - 13.41	322 - 335.4		

¹ Until February 1, 1999, this restricted band shall be 0.490-0.510 MHz.

² Above 38.6

(b) Except as provided in paragraphs (d) and (e), the field strength of emissions appearing within these frequency bands shall not exceed the limits shown in Section 15.209. At frequencies equal to or less than 1000 MHz, compliance with the limits in Section 15.209 shall be demonstrated using measurement instrumentation employing a CISPR quasi-peak detector. Above 1000 MHz, compliance with the emission limits in Section 15.209 shall be demonstrated based on the average value of the measured emissions. The provisions in Section 15.35 apply to these measurements.



3.5 DESCRIPTION OF TEST MODES

The EUT (model: iCamera2) comes with four types of power adapter (WA-12M12FU / SYS1381-1212-W2) for sale. After the preliminary test, the power adapter SYS1381-1212-W2 was found to emit the worst emissions and therefore had been tested under operating condition.

The EUT is a 2x2 configuration spatial MIMO (2Tx & 2Rx) without beam forming function that operate in double TX chains and double RX chains. The 2x2 configuration is implemented with two outside TX & RX chains (Chain 0 and 1).

Software used to control the EUT for staying in continuous transmitting mode was programmed.

After verification, all tests were carried out with the worst case test modes as shown below except radiated spurious emission below 1GHz and power line conducted emissions below 30MHz, which worst case was in normal link mode only.

IEEE 802.11b mode:

Channel Low (2412MHz), Channel Mid (2437MHz) and Channel High (2462MHz) with 1Mbps data rate and cyclic delay diversity were chosen for full testing.

IEEE 802.11g mode:

Channel Low (2412MHz), Channel Mid (2437MHz) and Channel High (2462MHz) with 6Mbps data rate and cyclic delay diversity were chosen for full testing.

IEEE 802.11n HT 20 mode:

Channel Low (2412MHz), Channel Mid (2437MHz) and Channel High (2462MHz) with 6.5Mbps data rate were chosen for full testing.

IEEE 802.11n HT 40 mode:

Channel Low (2422MHz), Channel Mid (2437MHz) and Channel High (2452MHz) with 13.5Mbps data rate were chosen for full testing.



4. INSTRUMENT CALIBRATION

4.1 MEASURING INSTRUMENT CALIBRATION

The measuring equipment, which was utilized in performing the tests documented herein, has been calibrated in accordance with the manufacturer's recommendations for utilizing calibration equipment, which is traceable to recognized national standards.

4.2 MEASUREMENT EQUIPMENT USED

Equipment Used for Emissions Measurement

Remark: Each piece of equipment is scheduled for calibration once a year.

Conducted Emissions Test Site				
Name of Equipment	Manufacturer	Model	Serial Number	Calibration Due
Spectrum Analyzer	Agilent	E4446A	MY43360131	03/19/2015
Power Meter	Anritsu	ML2495A	1012009	06/03/2015
Power Sensor	Anritsu	MA2411A	0917072	06/03/2015

3M Chamber Test Site				
Name of Equipment	Manufacturer	Model	Serial Number	Calibration Due
Spectrum Analyzer	Agilent	E4446A	US42510268	11/05/2014
EMI Test Receiver	R&S	ESCI	100064	02/26/2015
Pre-Amplifier	Mini-Circuits	ZFL-1000LN	SF350700823	01/11/2015
Pre-Amplifier	MITEQ	AFS44-00102650-42-10P-44	1415367	11/18/2014
Bilog Antenna	Sunol Sciences	JB3	A030105	10/01/2014
Horn Antenna	EMCO	3117	00055165	02/12/2015
Horn Antenna	EMCO	3116	2487	10/09/2014
Loop Antenna	EMCO	6502	8905/2356	06/11/2015
Turn Table	CCS	CC-T-1F	N/A	N.C.R
Antenna Tower	CCS	CC-A-1F	N/A	N.C.R
Controller	CCS	CC-C-1F	N/A	N.C.R
Site NSA	CCS	N/A	N/A	12/21/2014
Test S/W	EZ-EMC (CCS-3A1RE)			



Conducted Emission room # A				
Name of Equipment	Manufacturer	Model	Serial Number	Calibration Due
TEST RECEIVER	R&S	ESCI	101201	09/15/2014
LISN (EUT)	SCHWARZBECK	NSLK 8127	8127527	12/12/2014
LISN	SCHWARZBECK	NSLK 8127	8127526	12/12/2014
BNC CABLE	EMCI	CFD300-NL	BNC A6	06/23/2015
Pulse Limiter	R&S	ESH3-Z2	C3010026-2	09/05/2014
THERMO-HYGRO METER	WISEWIND	201A	No. 02	05/12/2015
Test S/W	EZ-EMC			

NOTE: 1. The calibration interval of the above test instruments is 12 months and the calibrations are traceable to NML/ROC and NIST/USA.
 2. N.C.R = No Calibration Request.

4.3 MEASUREMENT UNCERTAINTY

PARAMETER	UNCERTAINTY
Powerline Conducted Emission	+/- 1.0717
3M Semi Anechoic Chamber / <200M	+/- 4.0138
3M Semi Anechoic Chamber / 200M~1000M	+/- 3.9483
3M Semi Anechoic Chamber / 1G~8G	+/- 2.5975
3M Semi Anechoic Chamber / 8G~18G	+/- 2.6112
3M Semi Anechoic Chamber / 18G~26G	+/- 2.7389
3M Semi Anechoic Chamber / 26G~40G	+/- 2.9683

Remark: This uncertainty represents an expanded uncertainty expressed at approximately the 95% confidence level using a coverage factor of k=2.



5. FACILITIES AND ACCREDITATIONS

5.1 FACILITIES

All measurement facilities used to collect the measurement data are located at

No.199, Chunghsen Road, Hsintien City, Taipei Hsien, Taiwan, R.O.C.

Tel: 886-2-2217-0894 / Fax: 886-2-2217-1029

Remark: *The Powerline Conducted test items was tested at Compliance Certification Services Inc. (Hsintien Lab.)
The test equipments were listed in page 10 and the test data, please refer page 125-126.*

No.11, Wugong 6th Rd., Wugu Dist., New Taipei City 24891, Taiwan. (R.O.C.)

Tel: 886-2-2299-9720 / Fax: 886-2-2298-4045

No.81-1, Lane 210, Bade 2nd Rd., Lujhu Township, Taoyuan County 33841, TAIWAN, R.O.C.

Tel: 886-3-324-0332 / Fax: 886-3-324-5235

The sites are constructed in conformance with the requirements of ANSI C63.7, ANSI C63.4 and CISPR Publication 22.

5.2 EQUIPMENT

Radiated emissions are measured with one or more of the following types of linearly polarized antennas: tuned dipole, biconical, log periodic, bi-log, and/or ridged waveguide, horn. Spectrum analyzers with pre-selectors and quasi-peak detectors are used to perform radiated measurements.



Conducted emissions are measured with Line Impedance Stabilization Networks and EMI Test Receivers.

Calibrated wideband preamplifiers, coaxial cables, and coaxial attenuators are also used for making measurements.

All receiving equipment conforms to CISPR Publication 16-1, "Radio Interference Measuring Apparatus and Measurement Methods."



5.3 TABLE OF ACCREDITATIONS AND LISTINGS

Country	Agency	Scope of Accreditation	Logo
USA	FCC	3M Semi Anechoic Chamber (FCC MRA: TW1039) to perform FCC Part 15 measurements	 FCC MRA: TW1039
Taiwan	TAF	LP0002, RTTE01, FCC Method-47 CFR Part 15 Subpart C, D, E, RSS-210, RSS-310 IDA TS SRD, AS/NZS 4268, AS/NZS 4771, TS 12.1 & 12.2, ETSI EN 300 440-1, ETSI EN 300 440-2, ETSI EN 300 328, ETSI EN 300 220-1, ETSI EN 300 220-2, ETSI EN 301 893, ETSI EN 301 489-1/3/7/17 FCC OET Bulletin 65 + Supplement C, EN 50360, EN 50361, EN 50371, RSS 102, EN 50383, EN 50385, EN 50392, IEC 62209, CNS 14958-1, CNS 14959 FCC Method -47 CFR Part 15 Subpart B IEC / EN 61000-3-2, IEC / EN 61000-3-3, IEC / EN 61000-4-2/3/4/5/6/8/11	
Canada	Industry Canada	3M Semi Anechoic Chamber (IC 2324G-1 / IC 2324G-2) to perform	

* No part of this report may be used to claim or imply product endorsement by A2LA or any agency of the US Government.



6. SETUP OF EQUIPMENT UNDER TEST

6.1 SETUP CONFIGURATION OF EUT

See test photographs attached in Appendix II for the actual connections between EUT and support equipment.

6.2 SUPPORT EQUIPMENT

No	Equipment	Brand	Model	Series No.	FCC ID	Data Cable	Power Cord
1	Server PC	T3500	EX36VBX	DOC BSMI: R33002	DELL	Unshielded, 20m	Unshielded, 1.8m

Remark:

1. All the equipment/cables were placed in the worst-case configuration to maximize the emission during the test.
2. Grounding was established in accordance with the manufacturer's requirements and conditions for the intended use.



7. FCC PART 15.247 REQUIREMENTS

7.16DB BANDWIDTH

LIMIT

According to §15.247(a)(2), systems using digital modulation techniques may operate in the, 2400 - 2483.5 MHz bands. The minimum 6dB bandwidth shall be at least 500 kHz.

Test Configuration

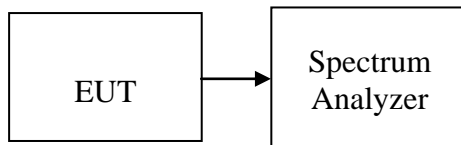

TEST PROCEDURE

The transmitter output is connected to the spectrum analyzer. Set the RBW=100kHz the emission bandwidth, VBW $\geq 3 \times$ RBW, Detector = Peak, Trace mode = max hold, Sweep = auto couple. Measure the maximum width of the emission that is constrained by the frequencies associated with the two amplitude points (upper and lower) that are attenuated by 6dB relative to the maximum level measured in the fundamental emission.

TEST RESULTS

No non-compliance noted.



Test Data

Test mode: IEEE 802.11b mode

Channel	Frequency (MHz)	Bandwidth (MHz)	Limit (kHz)	Result
Low	2412	10.3334	>500	PASS
Mid	2437	10.3334		PASS
High	2462	10.3334		PASS

Test mode: IEEE 802.11g mode

Channel	Frequency (MHz)	Bandwidth (MHz)	Limit (kHz)	Result
Low	2412	16.8333	>500	PASS
Mid	2437	16.8333		PASS
High	2462	16.8333		PASS

Test mode: IEEE 802.11n HT 20 mode / Chain 0

Channel	Frequency (MHz)	Bandwidth (MHz)	Limit (kHz)	Result
Low	2412	17.8334	>500	PASS
Mid	2437	17.8334		PASS
High	2462	17.9167		PASS

Test mode: IEEE 802.11n HT 20 mode / Chain 1

Channel	Frequency (MHz)	Bandwidth (MHz)	Limit (kHz)	Result
Low	2412	17.9167	>500	PASS
Mid	2437	17.9167		PASS
High	2462	17.9167		PASS

Test mode: IEEE 802.11n HT 40 mode / Chain 0

Channel	Frequency (MHz)	Bandwidth (MHz)	Limit (kHz)	Result
Low	2422	36.4167	>500	PASS
Mid	2437	36.3334		PASS
High	2452	36.4167		PASS

Test mode: IEEE 802.11n HT 40 mode / Chain 1

Channel	Frequency (MHz)	Bandwidth (MHz)	Limit (kHz)	Result
Low	2422	36.25	>500	PASS
Mid	2437	36.1667		PASS
High	2452	36.1667		PASS



Test Plot

IEEE 802.11b mode

6dB Bandwidth (CH Low)

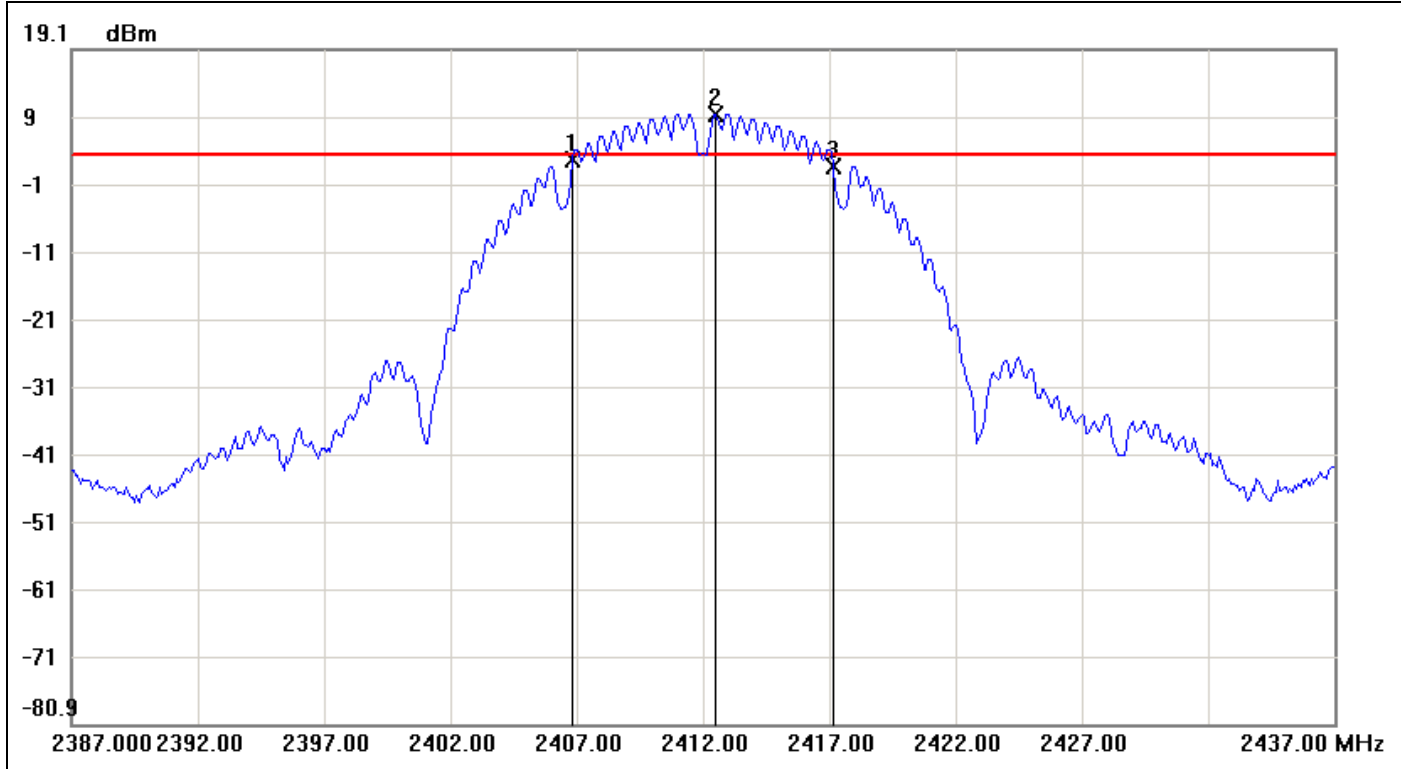

No.	Frequency(MHz)	Result(dBm)	Limit(dBm)	Margin(dBm)
1	2406.8333	2.67	3.53	-0.86
2	2412.5000	9.53	3.53	6.00
3	2417.1667	1.66	3.53	-1.87

No.		Δ Frequency(MHz)	Δ Level(dB)
1	mk3-mk1	10.3334	-1.01



6dB Bandwidth (CH Mid)

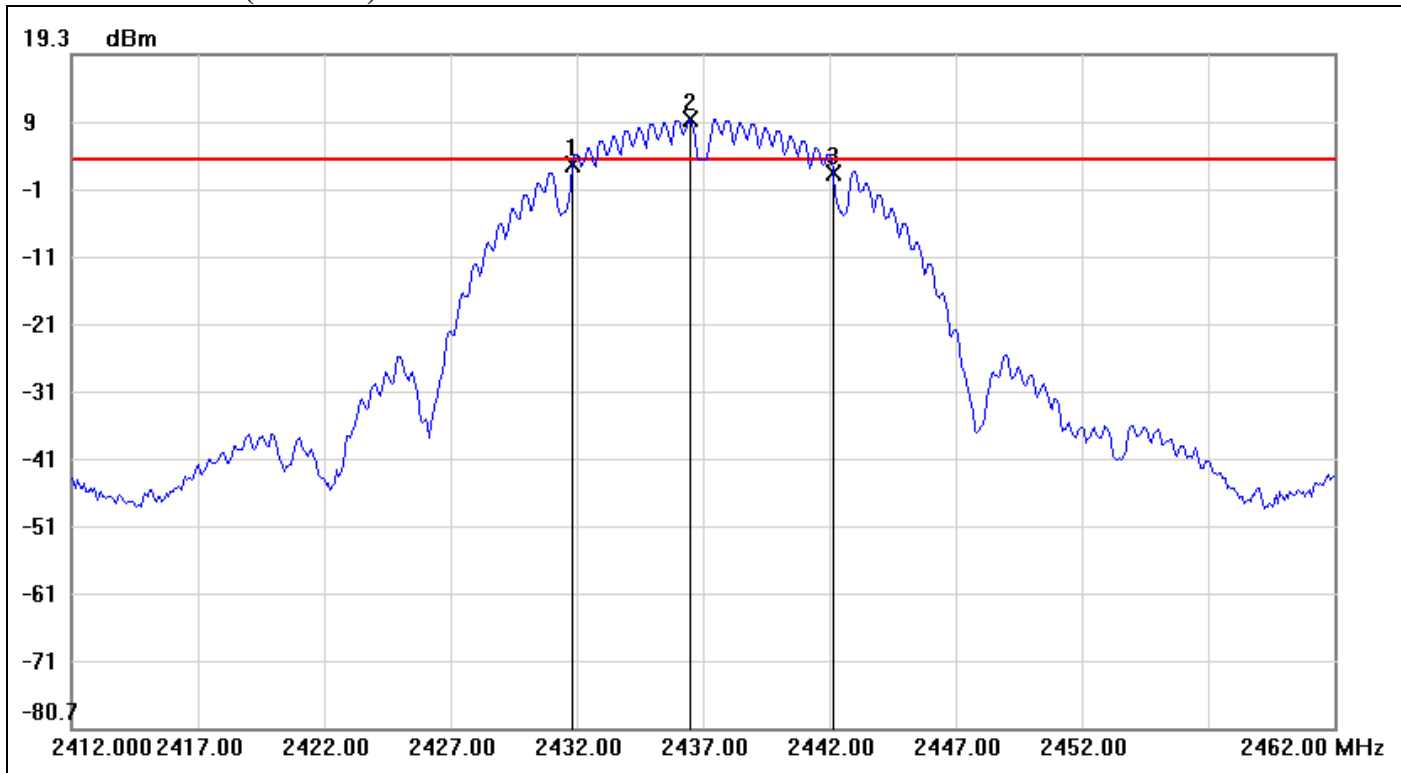

No.	Frequency(MHz)	Result(dBm)	Limit(dBm)	Margin(dBm)
1	2431.8333	2.89	3.66	-0.77
2	2436.5000	9.66	3.66	6.00
3	2442.1667	1.68	3.66	-1.98

No.		Δ Frequency(MHz)	Δ Level(dB)
1	mk3-mk1	10.3334	-1.21



6dB Bandwidth (CH High)

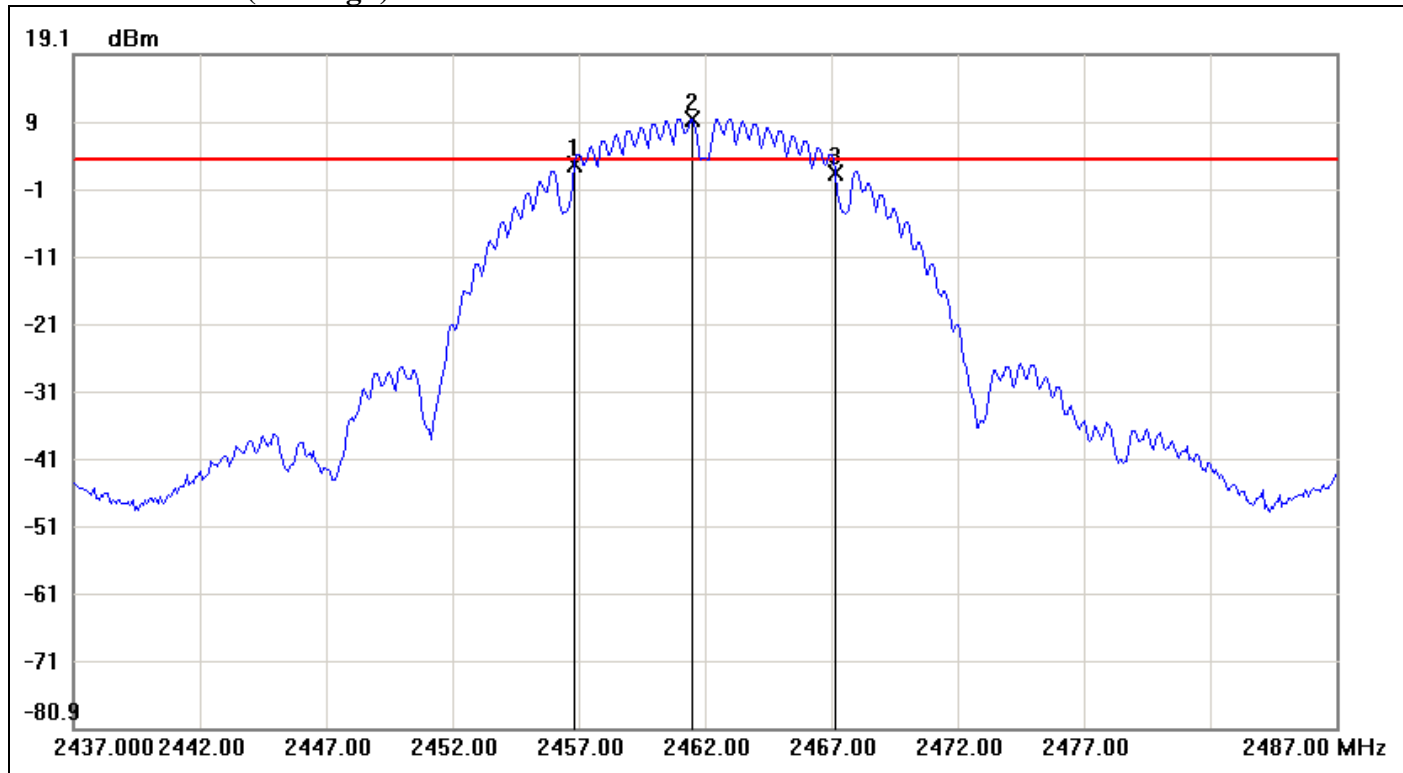

No.	Frequency(MHz)	Result(dBm)	Limit(dBm)	Margin(dBm)
1	2456.8333	2.81	3.52	-0.71
2	2461.5000	9.52	3.52	6.00
3	2467.1667	1.48	3.52	-2.04

No.		Δ Frequency(MHz)	Δ Level(dB)
1	mk3-mk1	10.3334	-1.33



IEEE 802.11g mode

6dB Bandwidth (CH Low)

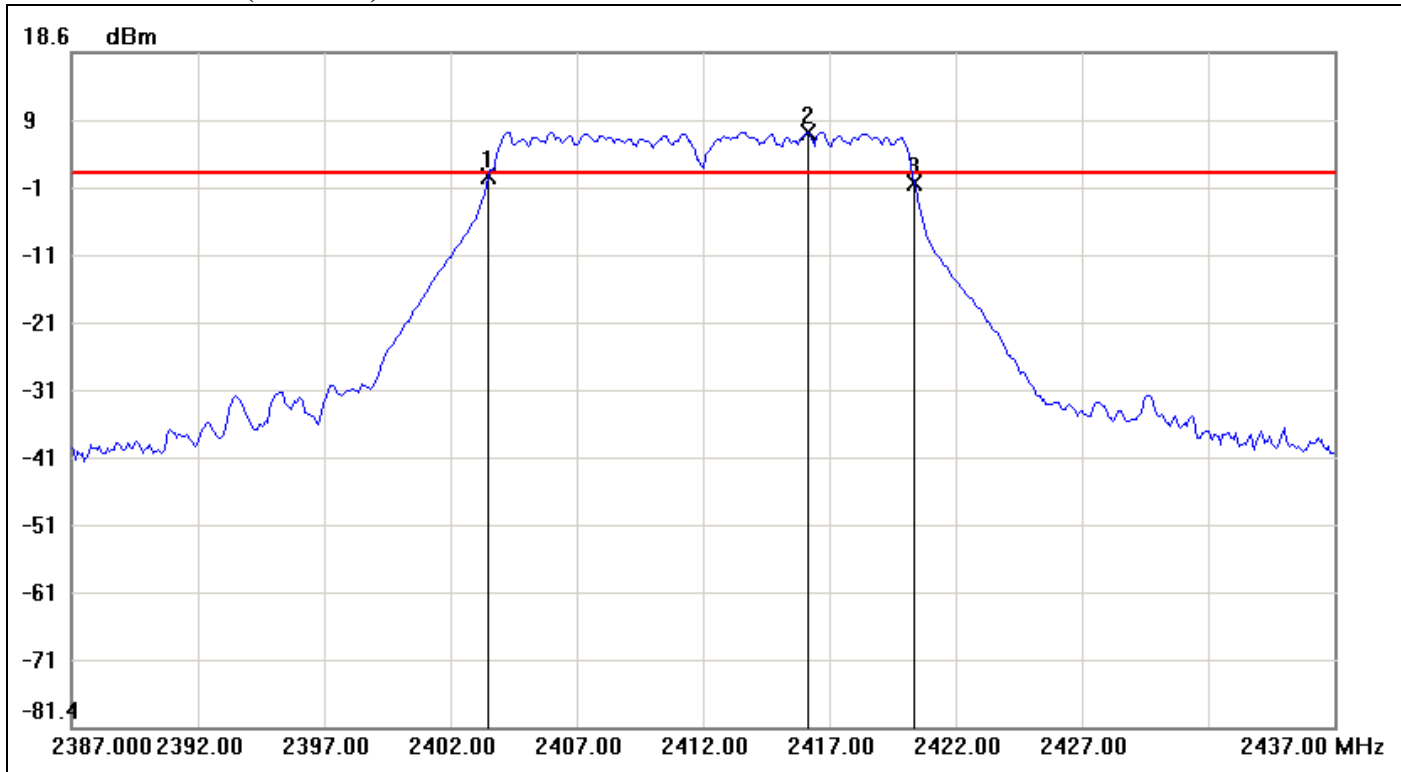

No.	Frequency(MHz)	Result(dBm)	Limit(dBm)	Margin(dBm)
1	2403.5000	0.33	0.82	-0.49
2	2416.1667	6.82	0.82	6.00
3	2420.3333	-0.71	0.82	-1.53

No.		Δ Frequency(MHz)	Δ Level(dB)
1	mk3-mk1	16.8333	-1.04



6dB Bandwidth (CH Mid)

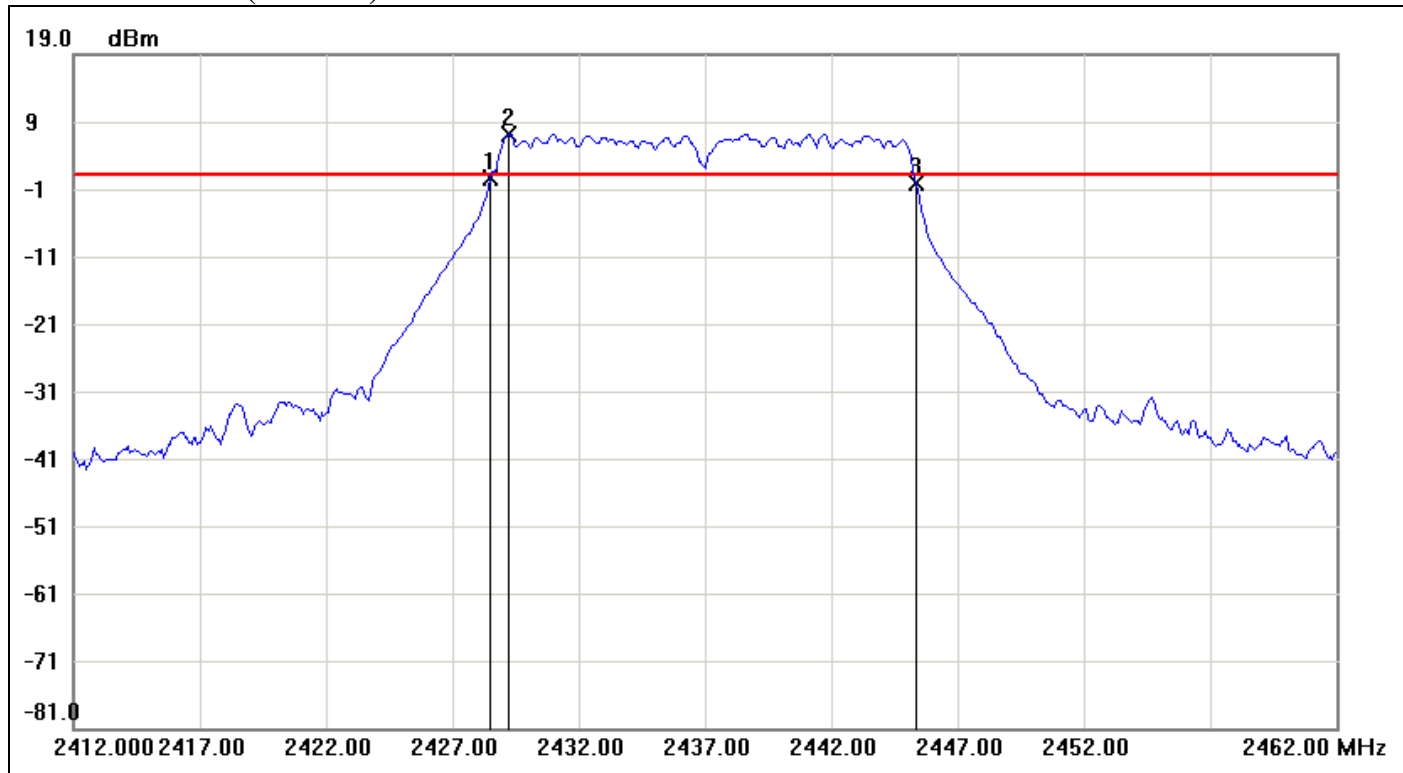

No.	Frequency(MHz)	Result(dBm)	Limit(dBm)	Margin(dBm)
1	2428.5000	0.70	1.16	-0.46
2	2429.2500	7.16	1.16	6.00
3	2445.3333	-0.26	1.16	-1.42

No.		Δ Frequency(MHz)	Δ Level(dB)
1	mk3-mk1	16.8333	-0.96



6dB Bandwidth (CH High)

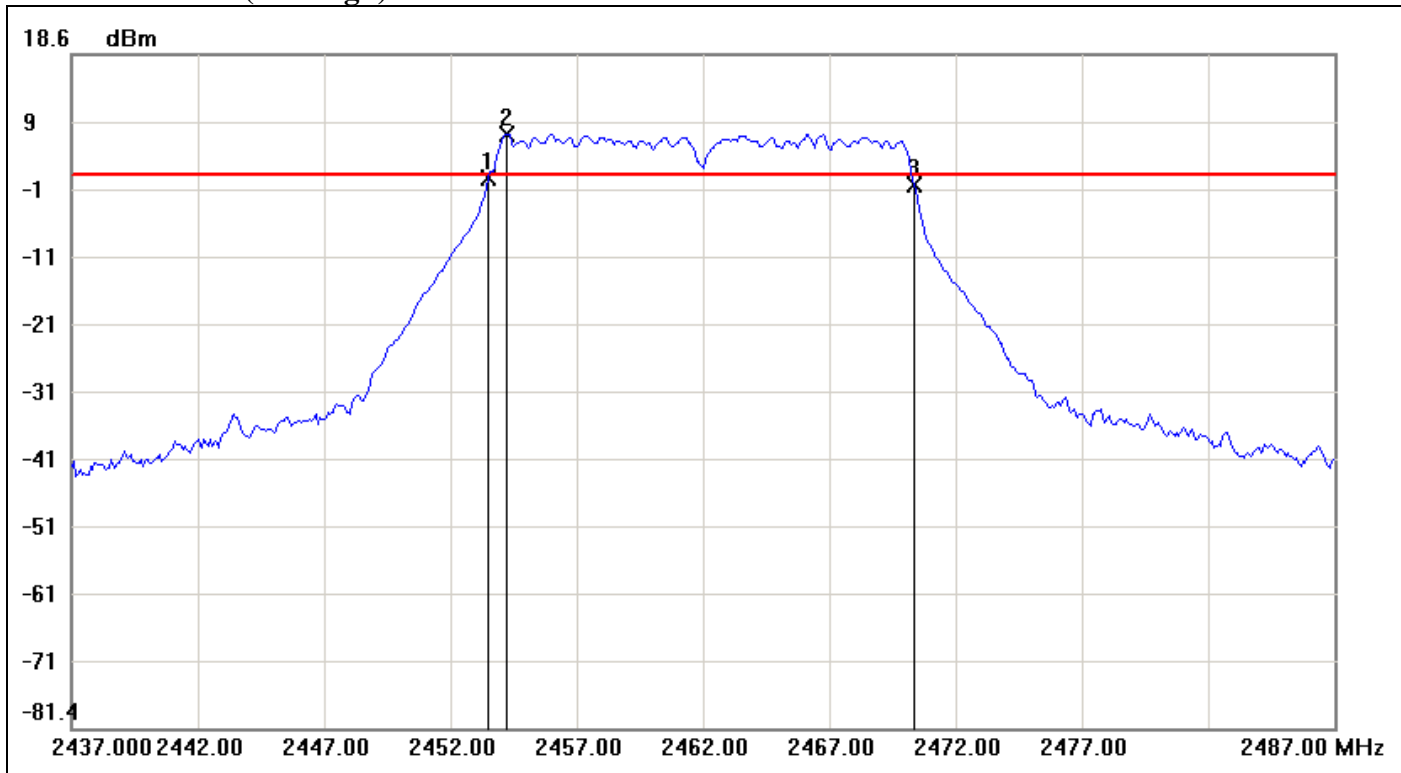

No.	Frequency(MHz)	Result(dBm)	Limit(dBm)	Margin(dBm)
1	2453.5000	0.32	0.77	-0.45
2	2454.2500	6.77	0.77	6.00
3	2470.3333	-0.84	0.77	-1.61

No.		Δ Frequency(MHz)	Δ Level(dB)
1	mk3-mk1	16.8333	-1.16



IEEE 802.11n HT 20 mode / Chain 0

6dB Bandwidth (CH Low)

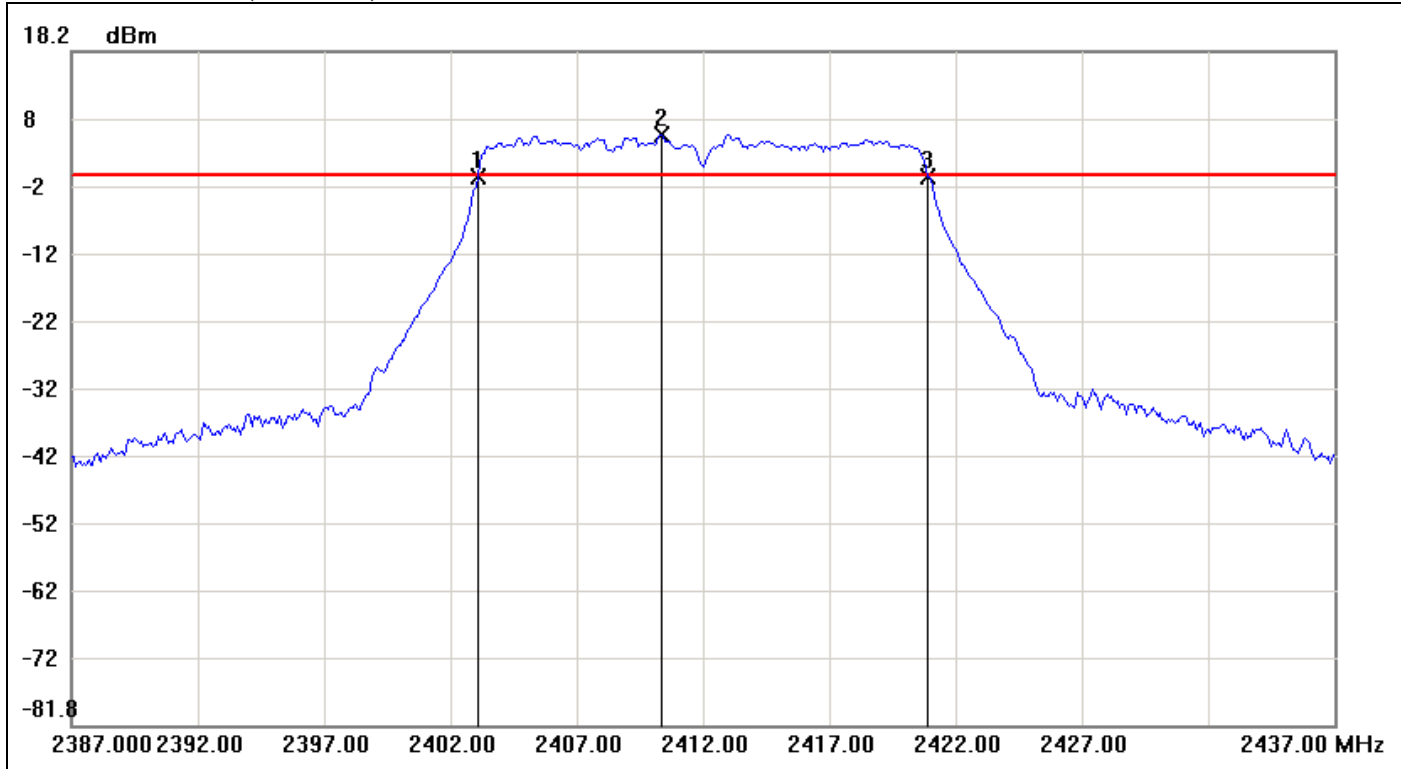

No.	Frequency(MHz)	Result(dBm)	Limit(dBm)	Margin(dBm)
1	2403.0833	-0.35	-0.28	-0.07
2	2410.3333	5.72	-0.28	6.00
3	2420.9167	-0.49	-0.28	-0.21

No.		Δ Frequency(MHz)	Δ Level(dB)
1	mk3-mk1	17.8334	-0.14



6dB Bandwidth (CH Mid)

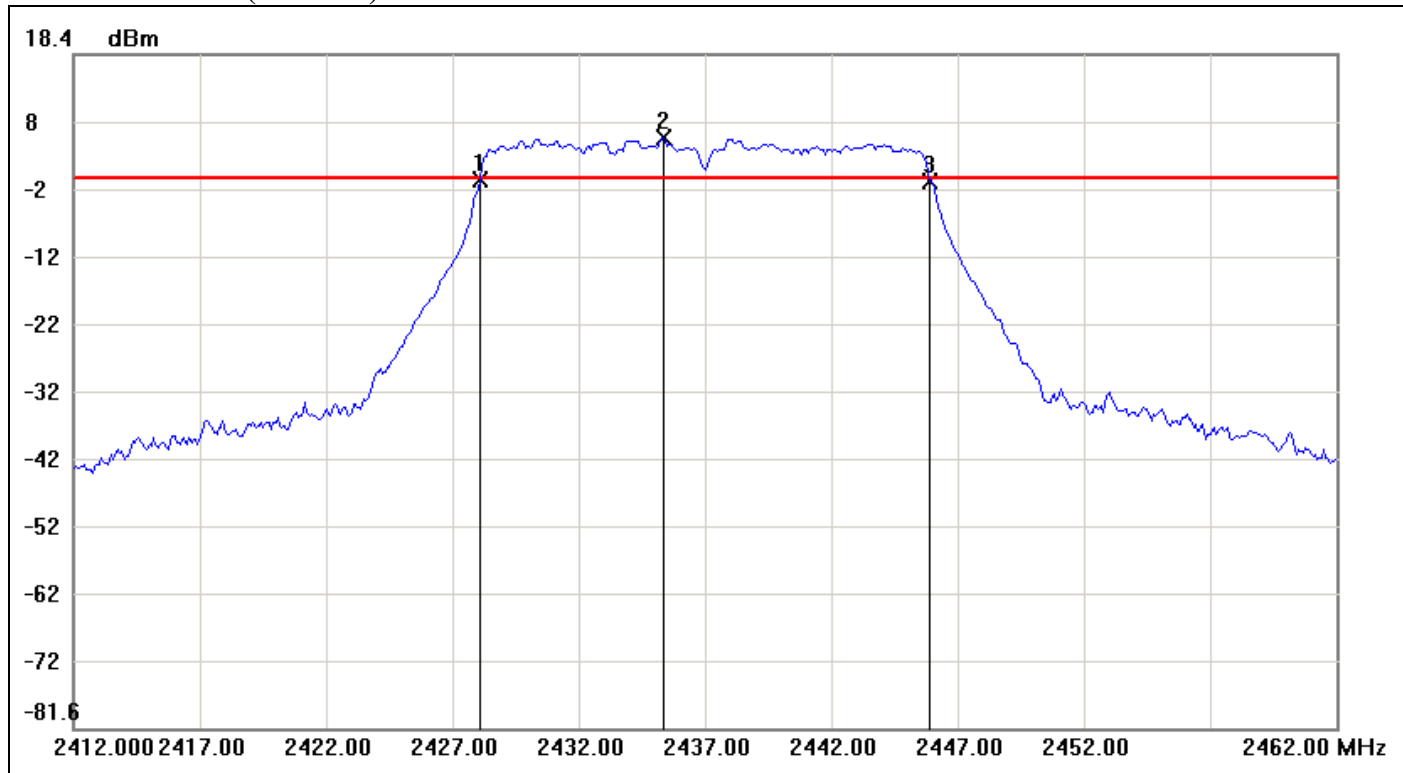

No.	Frequency(MHz)	Result(dBm)	Limit(dBm)	Margin(dBm)
1	2428.0833	-0.12	0.02	-0.14
2	2435.3333	6.02	0.02	6.00
3	2445.9167	-0.45	0.02	-0.47

No.		Δ Frequency(MHz)	Δ Level(dB)
1	mk3-mk1	17.8334	-0.33



6dB Bandwidth (CH High)

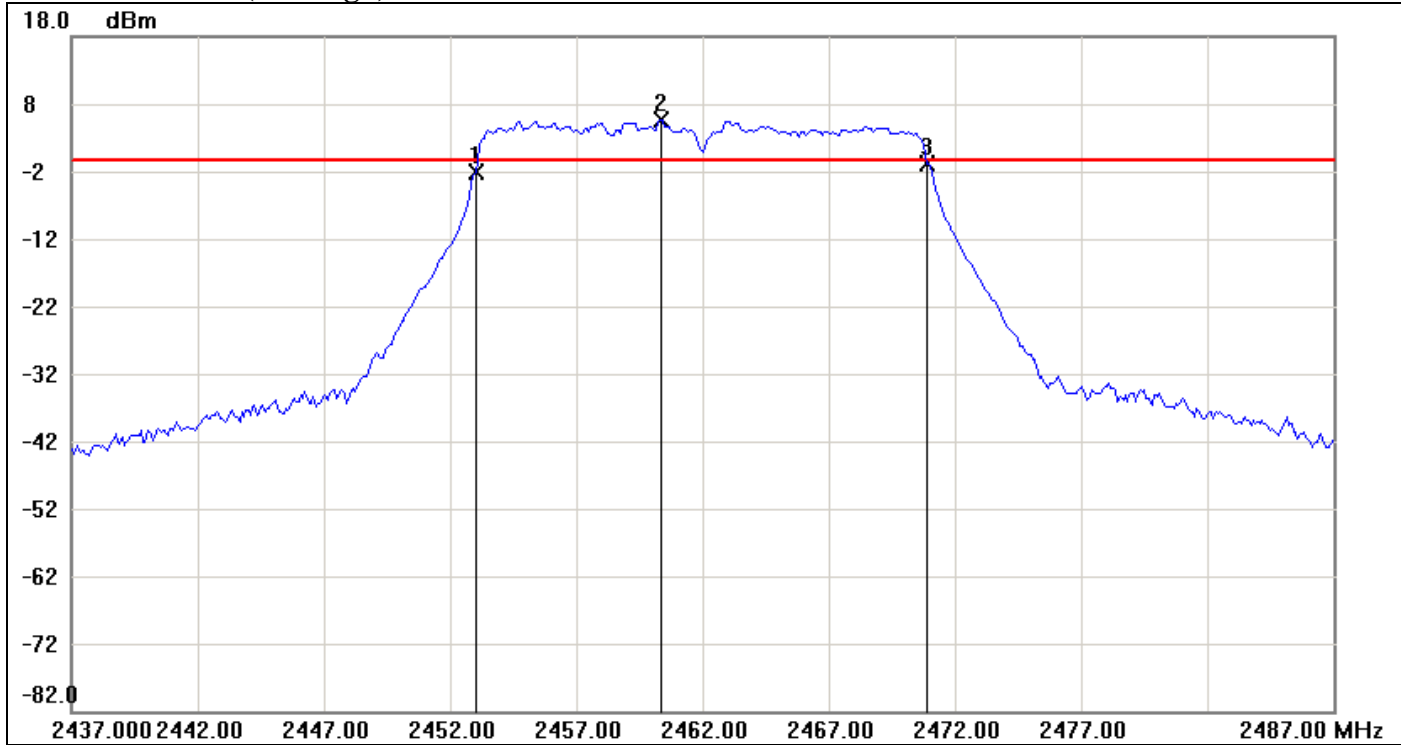

No.	Frequency(MHz)	Result(dBm)	Limit(dBm)	Margin(dBm)
1	2453.0000	-2.09	-0.34	-1.75
2	2460.3333	5.66	-0.34	6.00
3	2470.9167	-0.87	-0.34	-0.53

No.		Δ Frequency(MHz)	Δ Level(dB)
1	mk3-mk1	17.9167	1.22



IEEE 802.11n HT 20 mode / Chain 1

6dB Bandwidth (CH Low)

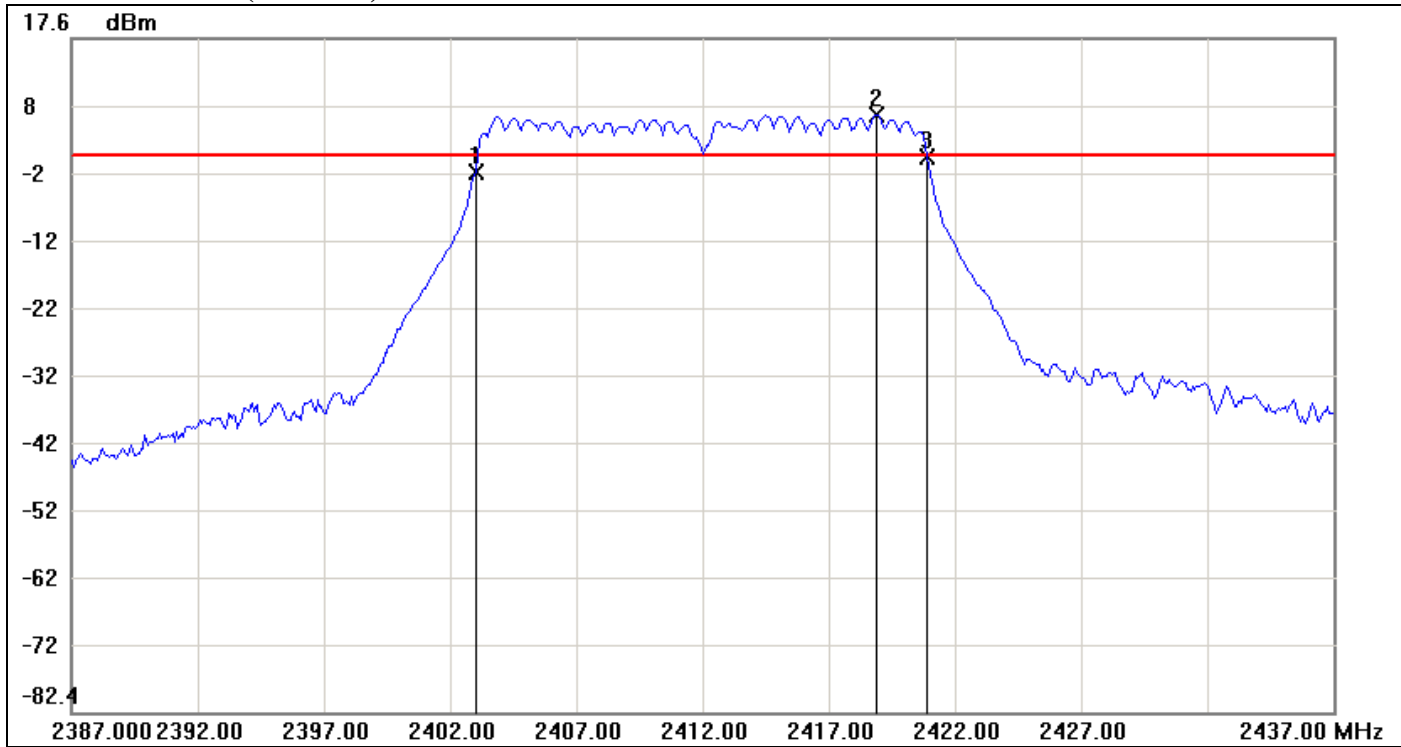

No.	Frequency(MHz)	Result(dBm)	Limit(dBm)	Margin(dBm)
1	2403.0000	-2.33	0.34	-2.67
2	2418.9167	6.34	0.34	6.00
3	2420.9167	-0.12	0.34	-0.46

No.		Δ Frequency(MHz)	Δ Level(dB)
1	mk3-mk1	17.9167	2.21



6dB Bandwidth (CH Mid)

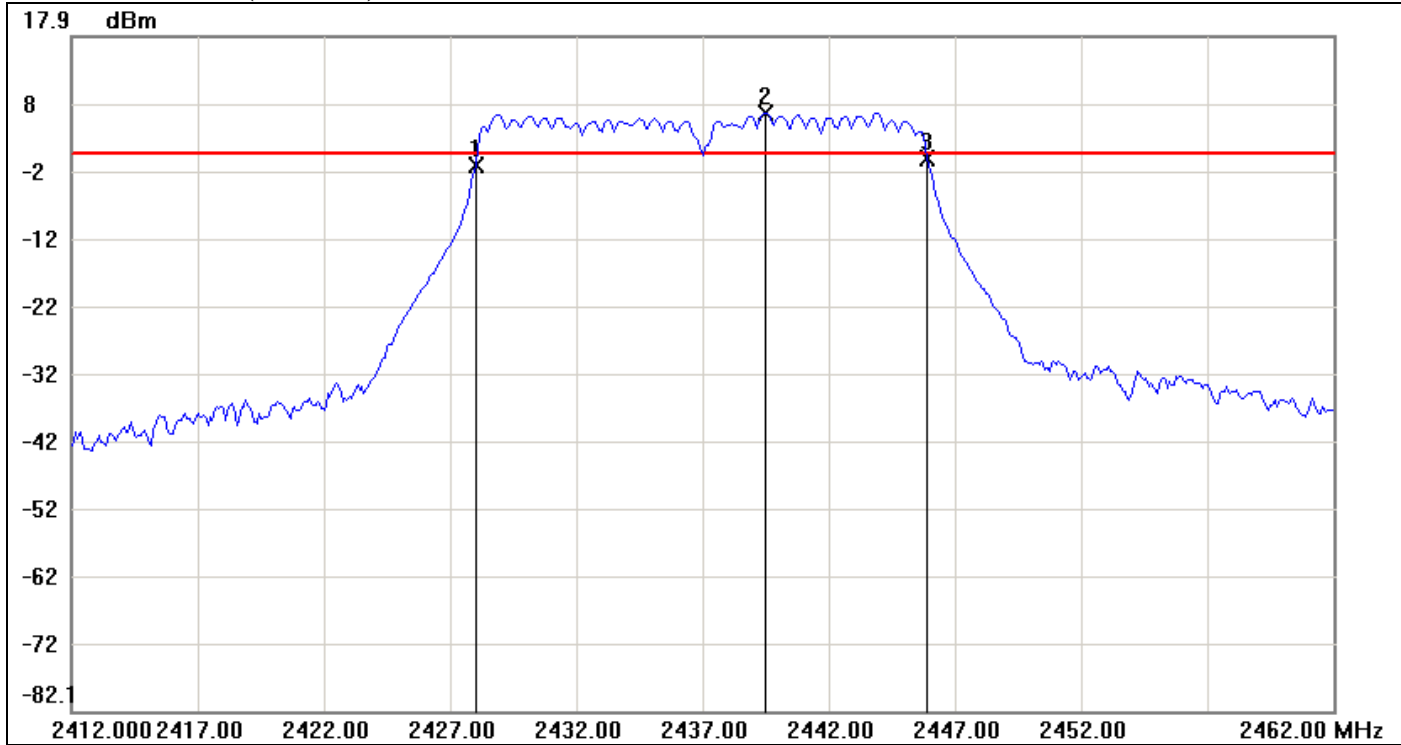

No.	Frequency(MHz)	Result(dBm)	Limit(dBm)	Margin(dBm)
1	2428.0000	-1.26	0.66	-1.92
2	2439.5000	6.66	0.66	6.00
3	2445.9167	-0.21	0.66	-0.87

No.		Δ Frequency(MHz)	Δ Level(dB)
1	mk3-mk1	17.9167	1.05



6dB Bandwidth (CH High)

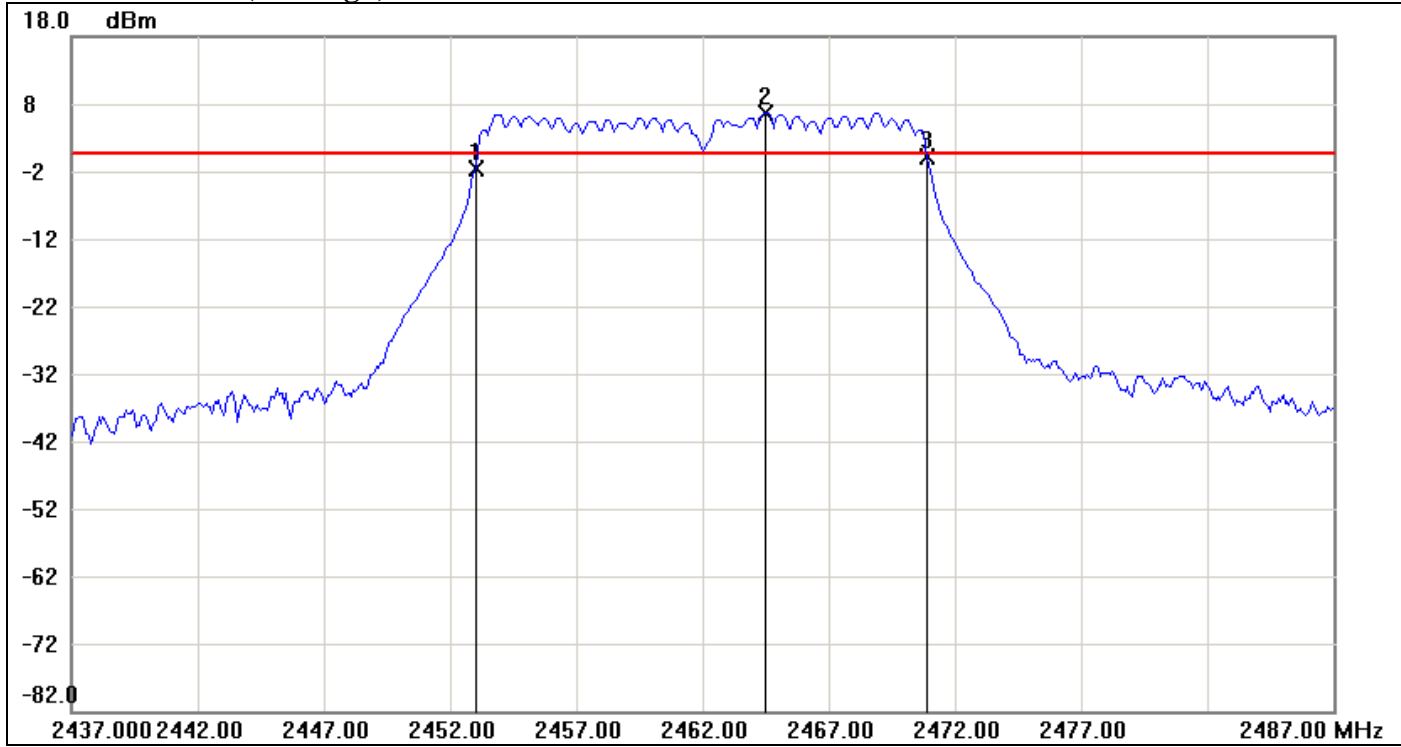

No.	Frequency(MHz)	Result(dBm)	Limit(dBm)	Margin(dBm)
1	2453.0000	-1.49	0.73	-2.22
2	2464.5000	6.73	0.73	6.00
3	2470.9167	0.17	0.73	-0.56

No.		Δ Frequency(MHz)	Δ Level(dB)
1	mk3-mk1	17.9167	1.66



IEEE 802.11n HT 40 mode / Chain 0

6dB Bandwidth (CH Low)

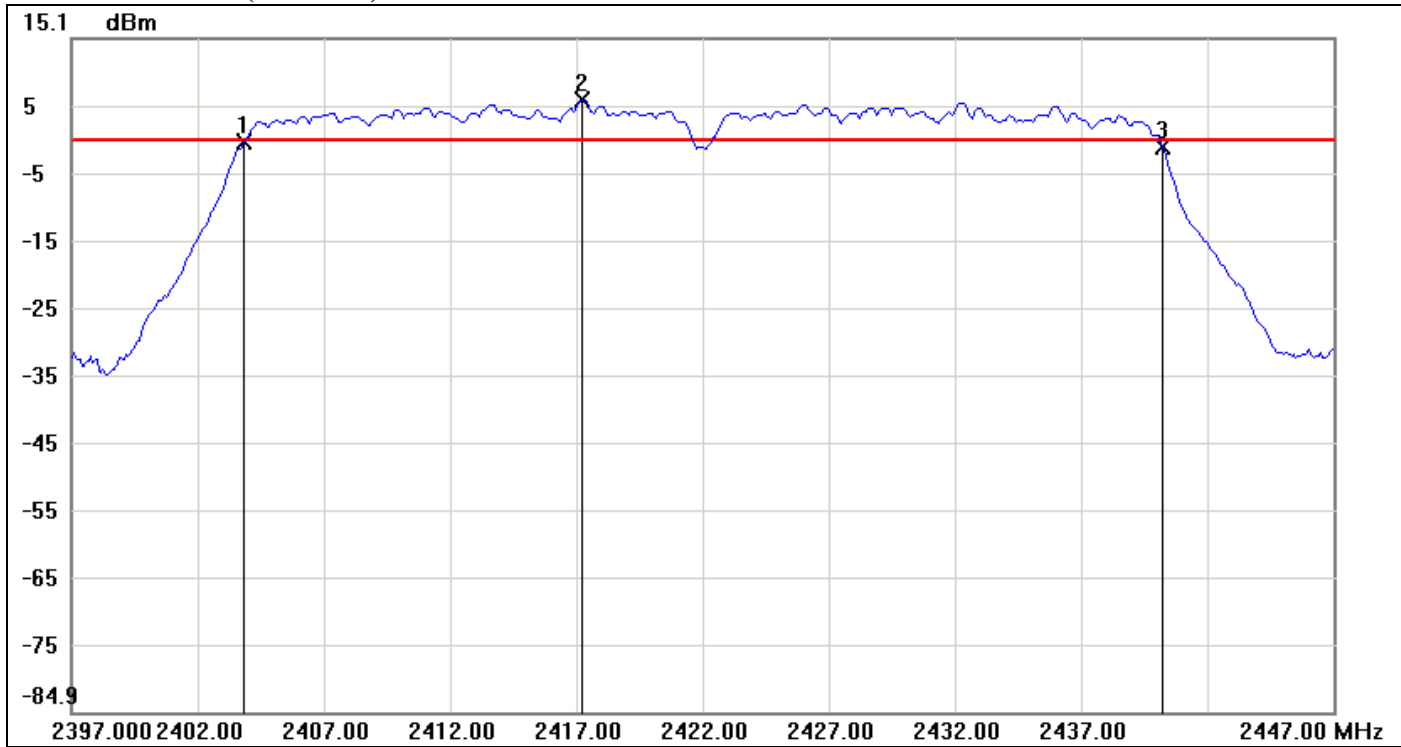

No.	Frequency(MHz)	Result(dBm)	Limit(dBm)	Margin(dBm)
1	2403.8333	-0.22	-0.02	-0.20
2	2417.2500	5.98	-0.02	6.00
3	2440.2500	-1.13	-0.02	-1.11

No.		Δ Frequency(MHz)	Δ Level(dB)
1	mk3-mk1	36.4167	-0.91



6dB Bandwidth (CH Mid)

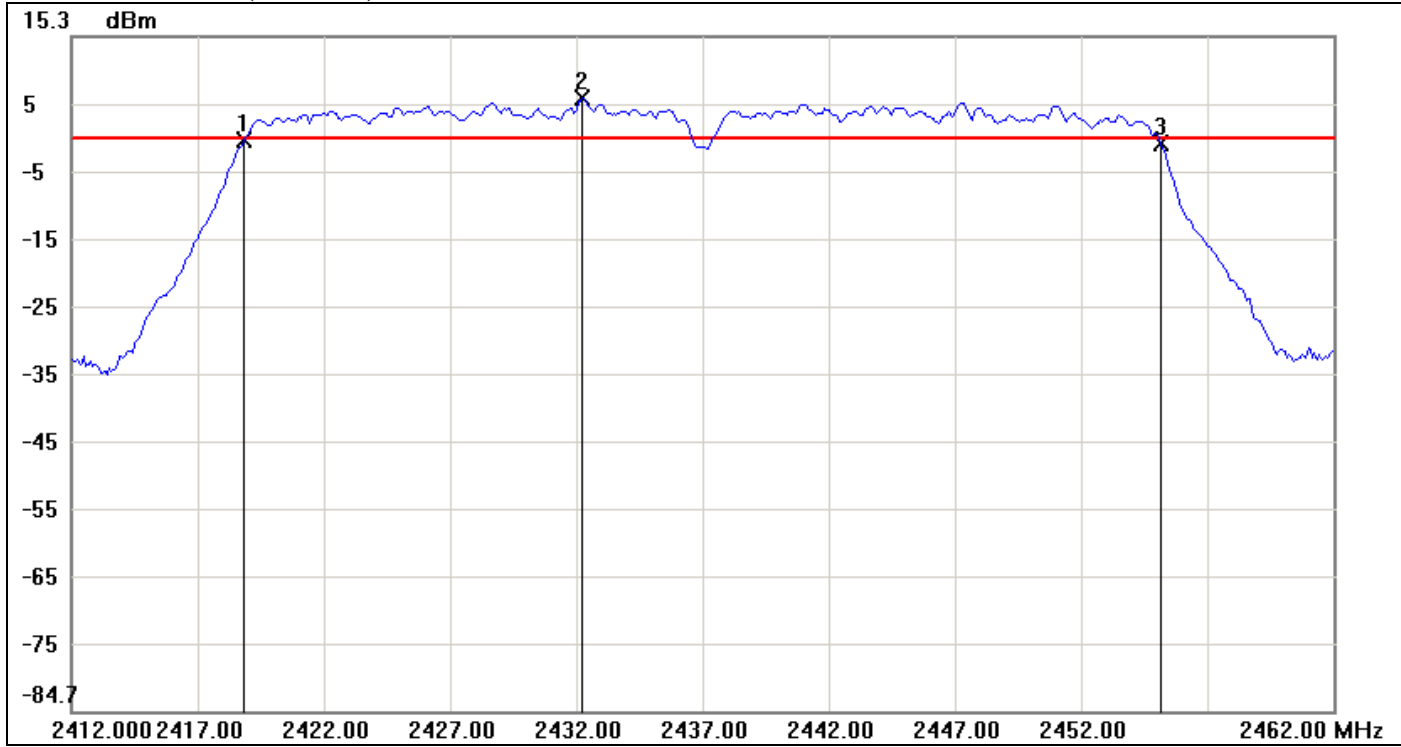

No.	Frequency(MHz)	Result(dBm)	Limit(dBm)	Margin(dBm)
1	2418.8333	-0.04	0.07	-0.11
2	2432.2500	6.07	0.07	6.00
3	2455.1667	-0.61	0.07	-0.68

No.		Δ Frequency(MHz)	Δ Level(dB)
1	mk3-mk1	36.3334	-0.57



6dB Bandwidth (CH High)

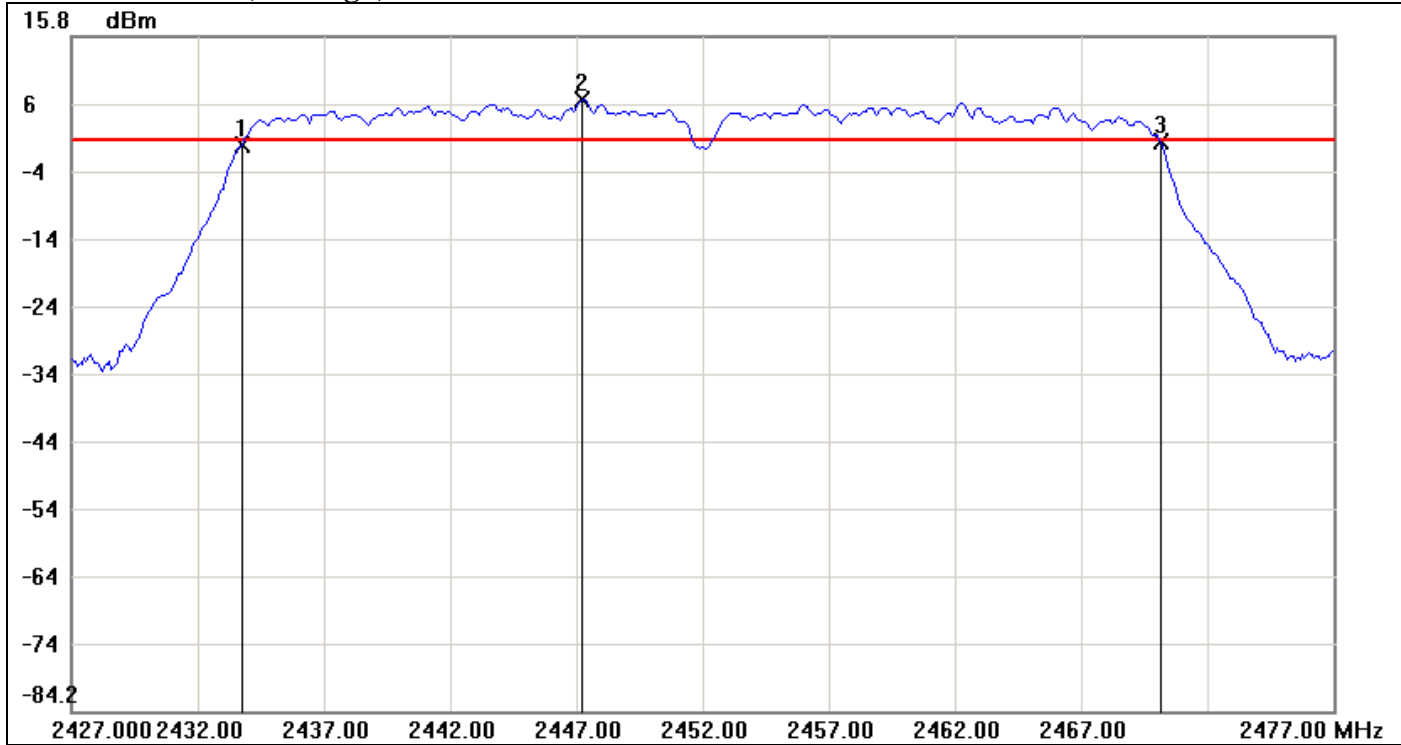

No.	Frequency(MHz)	Result(dBm)	Limit(dBm)	Margin(dBm)
1	2433.7500	-0.32	0.49	-0.81
2	2447.2500	6.49	0.49	6.00
3	2470.1667	0.06	0.49	-0.43

No.		Δ Frequency(MHz)	Δ Level(dB)
1	mk3-mk1	36.4167	0.38



IEEE 802.11n HT 40 mode / Chain 1

6dB Bandwidth (CH Low)

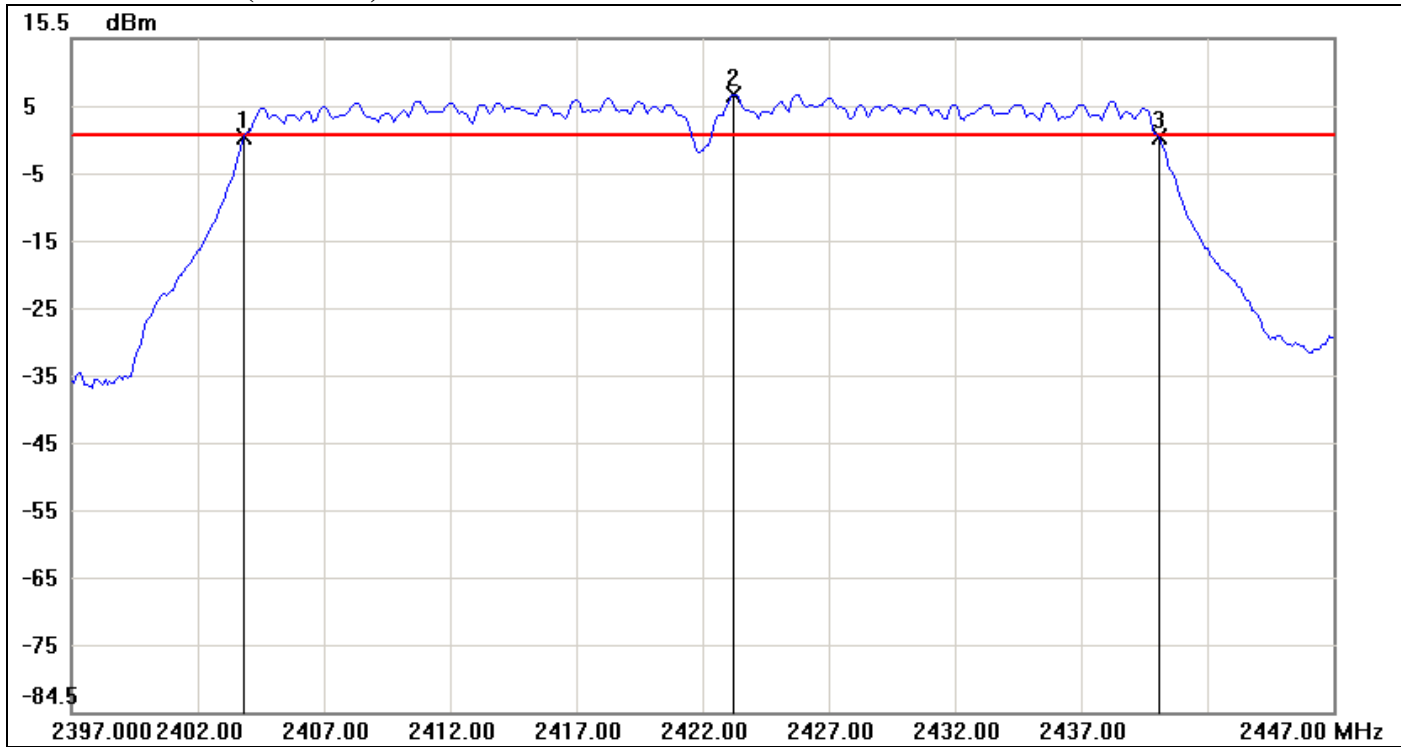

No.	Frequency(MHz)	Result(dBm)	Limit(dBm)	Margin(dBm)
1	2403.8333	0.89	1.21	-0.32
2	2423.2500	7.21	1.21	6.00
3	2440.0833	0.87	1.21	-0.34

No.		Δ Frequency(MHz)	Δ Level(dB)
1	mk3-mk1	36.25	-0.02



6dB Bandwidth (CH Mid)

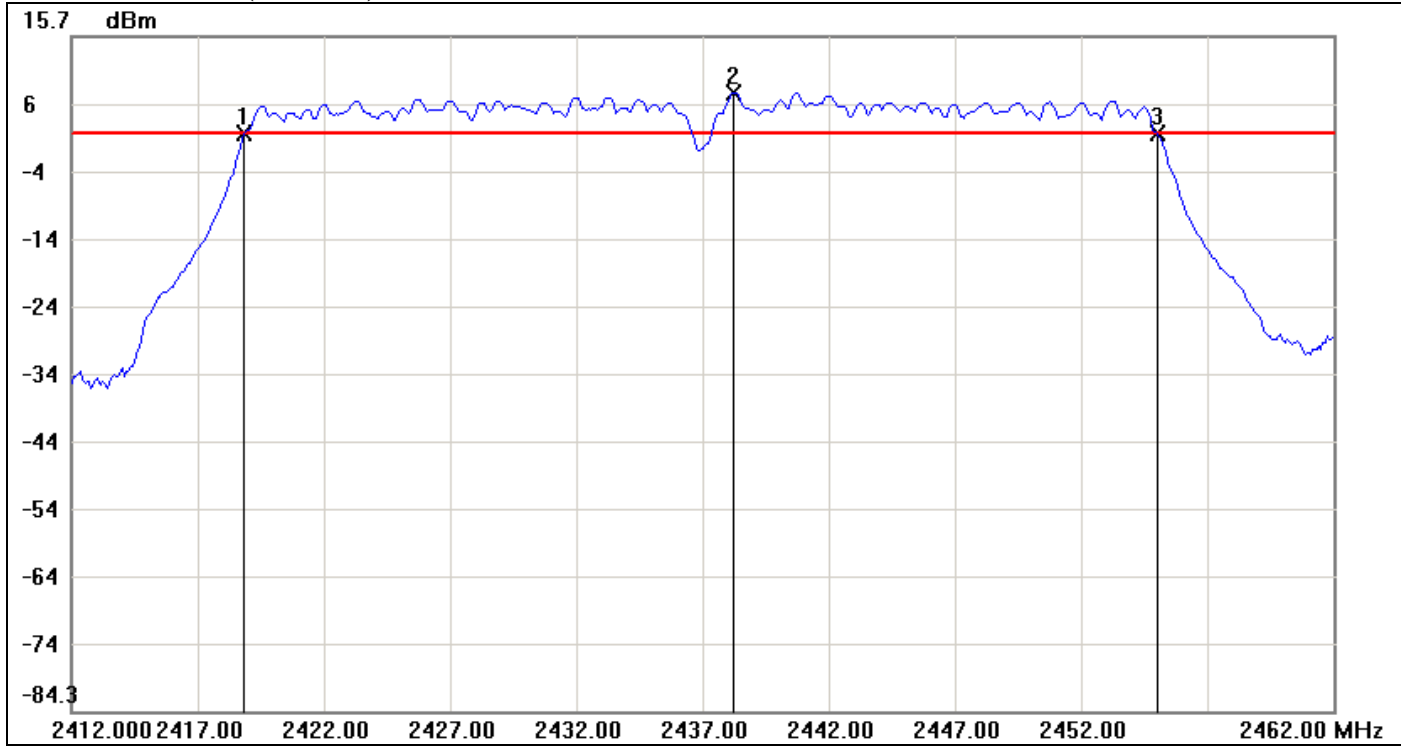

No.	Frequency(MHz)	Result(dBm)	Limit(dBm)	Margin(dBm)
1	2418.8333	1.25	1.42	-0.17
2	2438.2500	7.42	1.42	6.00
3	2455.0000	1.32	1.42	-0.10

No.		Δ Frequency(MHz)	Δ Level(dB)
1	mk3-mk1	36.1667	0.07



6dB Bandwidth (CH High)

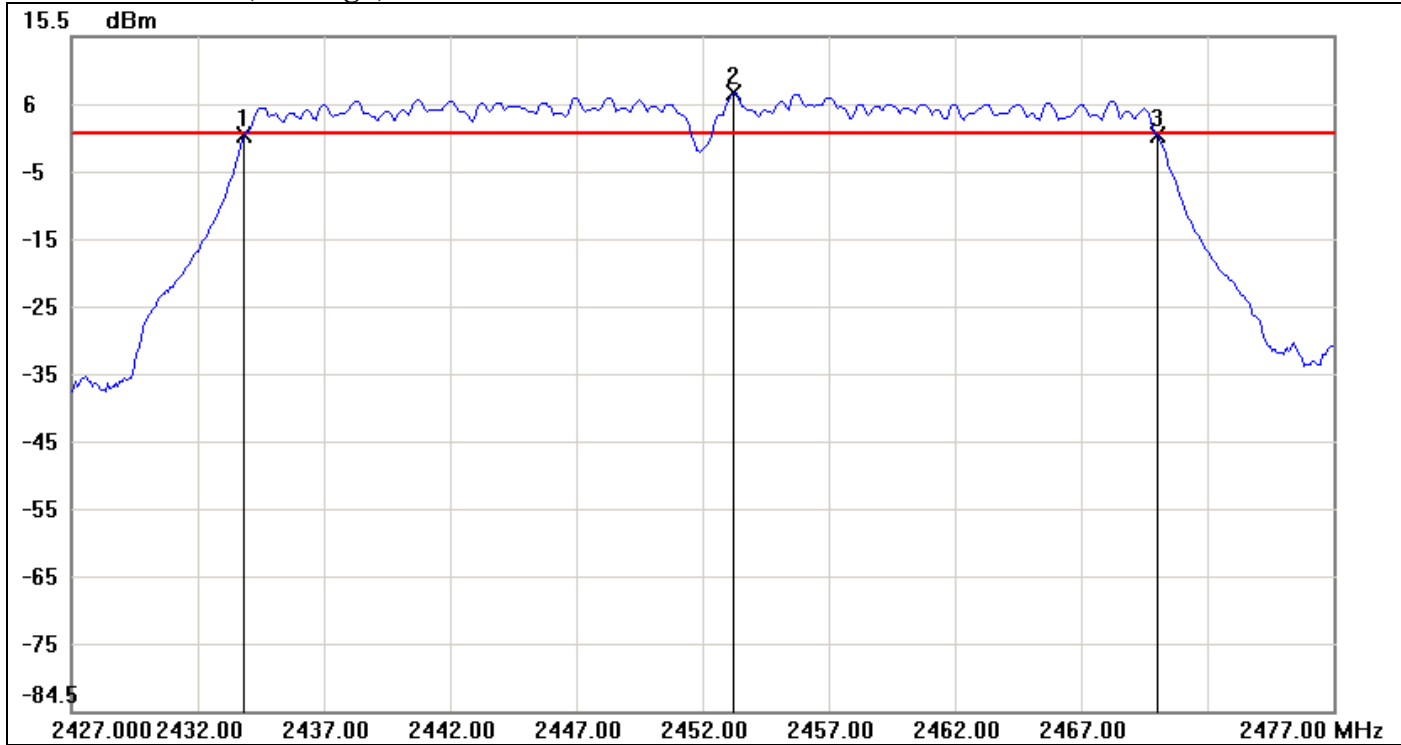

No.	Frequency(MHz)	Result(dBm)	Limit(dBm)	Margin(dBm)
1	2433.8333	0.94	1.02	-0.08
2	2453.2500	7.02	1.02	6.00
3	2470.0000	1.00	1.02	-0.02

No.		Δ Frequency(MHz)	Δ Level(dB)
1	mk3-mk1	36.1667	0.06



7.2 PEAK POWER

LIMIT

The maximum peak output power of the intentional radiator shall not exceed the following:

1. According to §15.247(b)(3), for systems using digital modulation in the bands of 2400-2483.5 MHz: 1 Watt.
2. According to §15.247(b)(4), the conducted output power limit specified in paragraph (b) of this section is based on the use of antennas with directional gains that do not exceed 6 dBi. Except as shown in paragraph (c) of this section, if transmitting antennas of directional gain greater than 6 dBi are used, the conducted output power from the intentional radiator shall be reduced below the stated values in paragraphs (b)(1), (b)(2), and (b)(3) of this section, as appropriate, by the amount in dB that the directional gain of the antenna exceeds 6 dBi.

Test Configuration

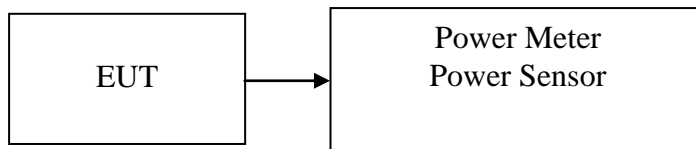

TEST PROCEDURE

The transmitter output is connected to the Power Meter. The Power Meter is set to the peak power detection.

**Test Data****Test mode: IEEE 802.11b mode**

Channel	Frequency (MHz)	Output Power (dBm)	Output Power (W)	Limit (W)	Result
Low	2412	19.98	0.09954	1.00	PASS
Mid	2437	20.18	0.10423		PASS
High	2462	20.09	0.10209		PASS

Test mode: IEEE 802.11g mode

Channel	Frequency (MHz)	Output Power (dBm)	Output Power (W)	Limit (W)	Result
Low	2412	25.1	0.32359	1.00	PASS
Mid	2437	25.42	0.34834		PASS
High	2462	25.18	0.32961		PASS

Test mode: IEEE 802.11n HT 20 mode

Channel	Frequency (MHz)	Chain 0 Output Power (dBm)	Chain 1 Output Power (dBm)	Total Output Power (dBm)	Output Power (W)	Limit (W)	Result
Low	2412	24.25	23.25	26.79	0.4774	1.00	PASS
Mid	2437	24.51	23.41	27.01	0.5018		PASS
High	2462	24.25	23.43	26.87	0.4864		PASS

Test mode: IEEE 802.11n HT 40 mode

Channel	Frequency (MHz)	Chain 0 Output Power (dBm)	Chain 1 Output Power (dBm)	Total Output Power (dBm)	Output Power (W)	Limit (W)	Result
Low	2422	23.98	23.76	26.88	0.4877	1.00	PASS
Mid	2437	23.85	23.62	26.75	0.4728		PASS
High	2452	23.86	23.68	26.78	0.4766		PASS

)



7.3 AVERAGE POWER

LIMIT

None; for reporting purposes only.

Test Configuration

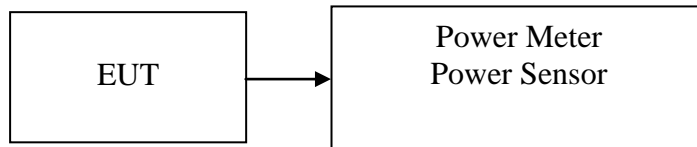

TEST PROCEDURE

The transmitter output is connected to the Power Meter. The Power Meter is set to the avg power detection.



TEST RESULTS

No non-compliance noted

Test Data

Test mode: IEEE 802.11b mode

Channel	Frequency (MHz)	Output Power (dBm)	Output Power (W)
Low	2412	17.78	0.05998
Mid	2437	18.1	0.06457
High	2462	17.86	0.06109

Test mode: IEEE 802.11g mode

Channel	Frequency (MHz)	Output Power (dBm)	Output Power (W)
Low	2412	15.98	0.03963
Mid	2437	16.26	0.04227
High	2462	15.78	0.03784

Test mode: IEEE 802.11n HT 20 mode

Channel	Frequency (MHz)	Chain 0 Output Power (dBm)	Chain 1 Output Power (dBm)	Total Output Power (dBm)	Output Power (W)	Limit (W)	Result
Low	2412	14.78	14.87	17.84	0.0608	1.00	PASS
Mid	2437	15.17	15.15	18.17	0.0656		PASS
High	2462	14.85	15.14	18.01	0.0632		PASS

Test mode: IEEE 802.11n HT 40 mode

Channel	Frequency (MHz)	Chain 0 Output Power (dBm)	Chain 1 Output Power (dBm)	Total Output Power (dBm)	Output Power (W)	Limit (W)	Result
Low	2422	14.98	15.26	18.13	0.0651	1.00	PASS
Mid	2437	14.91	15.25	18.09	0.0645		PASS
High	2452	14.84	15.14	18.00	0.0631		PASS



7.4BAND EDGES MEASUREMENT

LIMIT

According to §15.247(d), in any 100 kHz bandwidth outside the frequency bands in which the spread spectrum intentional radiator is operating, the radio frequency power that is produced by the intentional radiator shall be at least 20 dB below that in the 100 kHz bandwidth within the band that contains the highest level of the desired power, based on either an RF conducted or a radiated measurement, provided the transmitter demonstrates compliance with the peak conducted power limits. In addition, radiated emissions which fall in the restricted bands, as defined in §15.205(a), must also comply with the radiated emission limits specified in 15.209(a) (see Section 15.205(c)).

Test Configuration

For Radiated

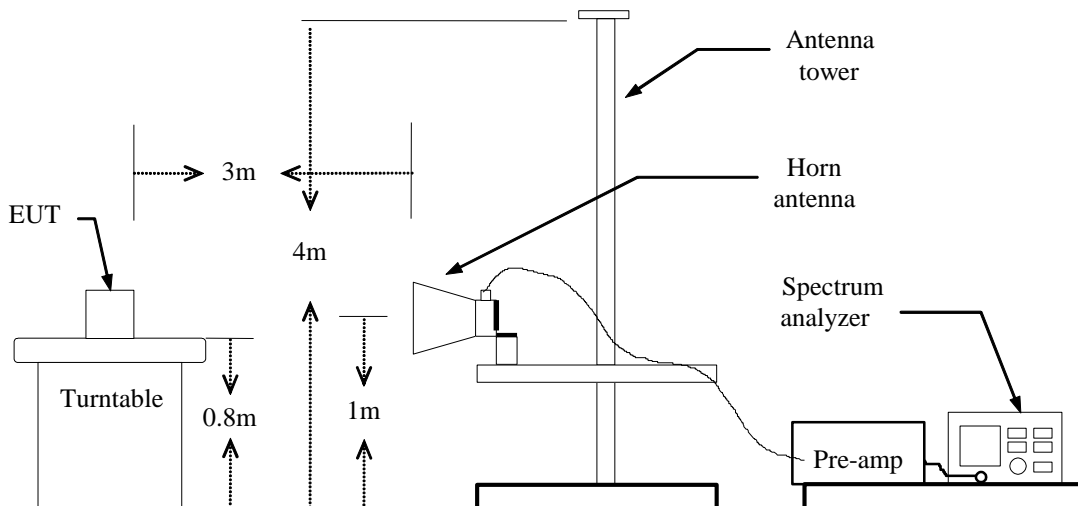

For Conducted

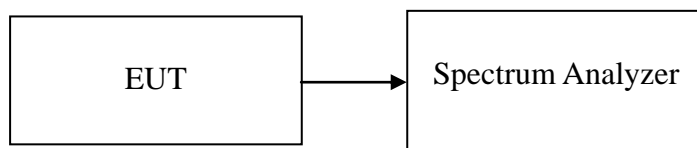



TEST PROCEDURE

For Radiated

1. The EUT is placed on a turntable, which is 0.8m above the ground plane.
2. The turntable shall be rotated for 360 degrees to determine the position of maximum emission level.
3. EUT is set 3m away from the receiving antenna, which is varied from 1m to 4m to find out the highest emission.
4. Set the spectrum analyzer in the following setting in order to capture the lower and upper band-edges of the emission:
 - (a) PEAK: RBW=1MHz / VBW=3MHz / Sweep=AUTO
 - (b) AVERAGE: RBW=1MHz / VBW= 300Hz / Sweep=AUTO
5. Repeat the procedures until all the PEAK and AVERAGE versus POLARIZATION are measured.

For Conducted

Conducted RF measurements of the transmitter output were made to confirm that the EUT antenna port conducted emissions meet the specified limit and to identify any spurious signals that require further investigation or measurements on the radiated emissions site.

The transmitter output is connected to the spectrum analyzer. The resolution bandwidth is set to 100 kHz. The video bandwidth is set to 100 kHz.

TEST RESULTS

Refer to attach spectrum analyzer data chart.



Band Edges (IEEE 802.11b mode / CH Low)

Polarity: Vertical

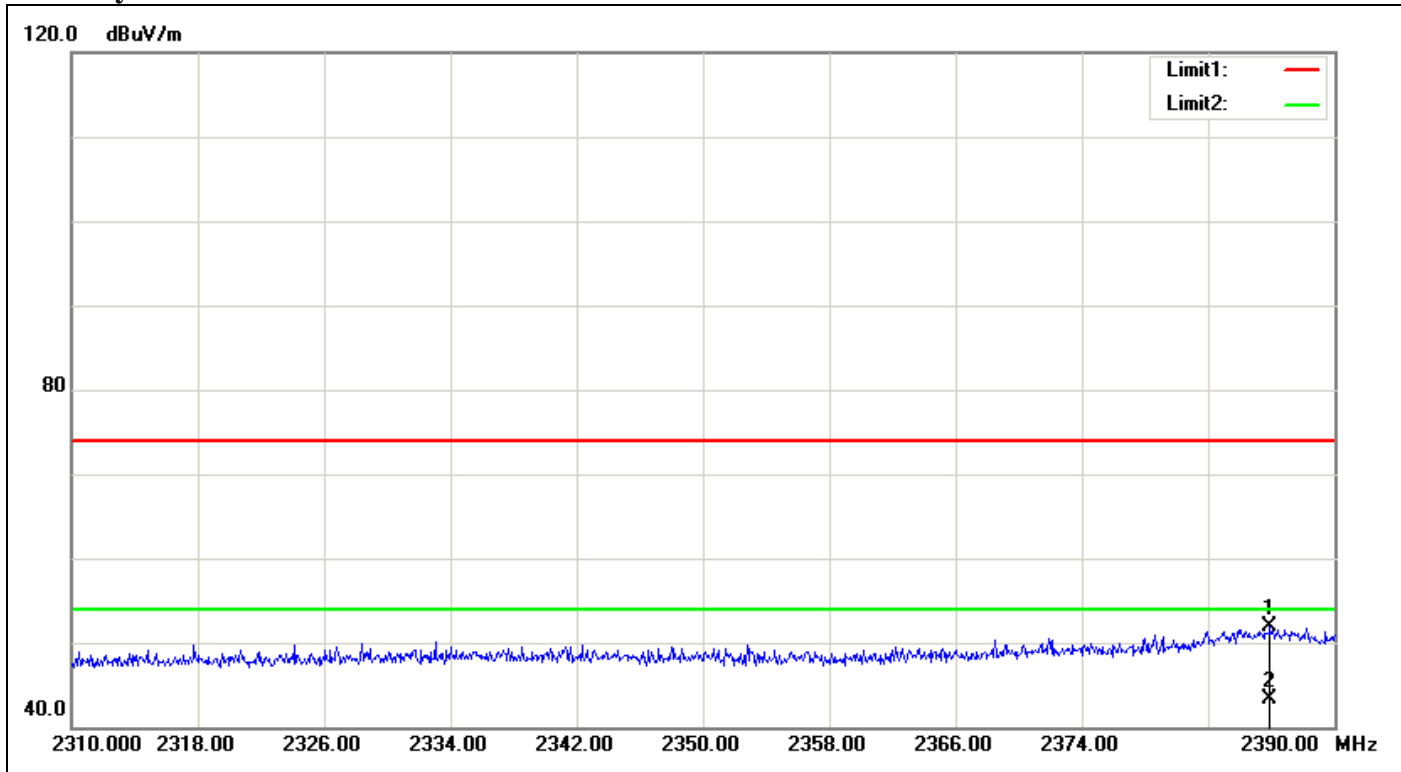

No.	Frequency (MHz)	Reading (dBuV)	Correct Factor(dB/m)	Result (dBuV/m)	Limit (dBuV/m)	Margin (dB)	Height (cm)	Degree (°)	Remark
1	2385.920	52.97	-1.09	51.88	74.00	-22.12			peak
2	2385.920	44.38	-1.09	43.29	54.00	-10.71			AVG



Polarity: Horizontal

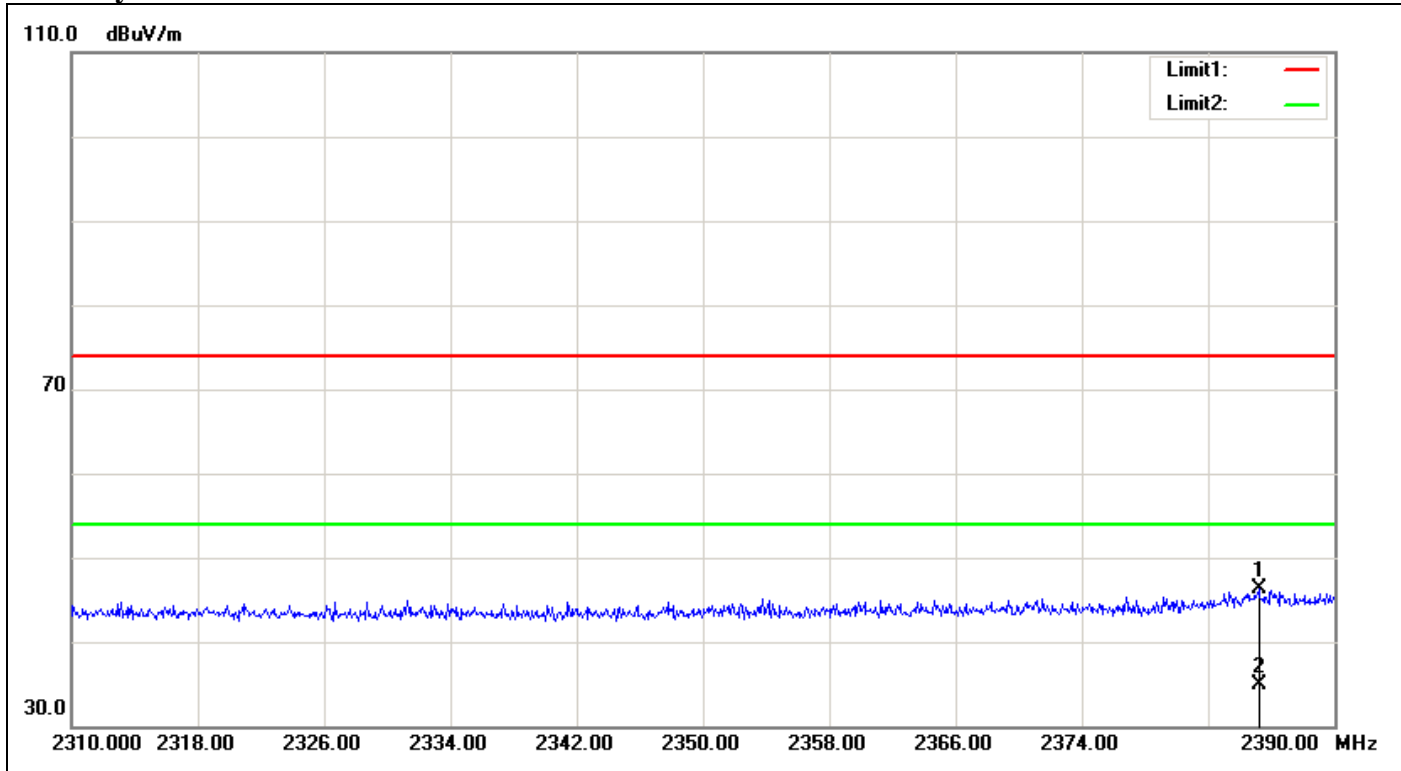

No.	Frequency (MHz)	Reading (dBuV)	Correct Factor(dB/m)	Result (dBuV/m)	Limit (dBuV/m)	Margin (dB)	Height (cm)	Degree (°)	Remark
1	2385.200	47.35	-1.10	46.25	74.00	-27.75			peak
2	2385.200	35.96	-1.10	34.86	54.00	-19.14			AVG



Band Edges (IEEE 802.11b mode / CH High)

Polarity: Vertical

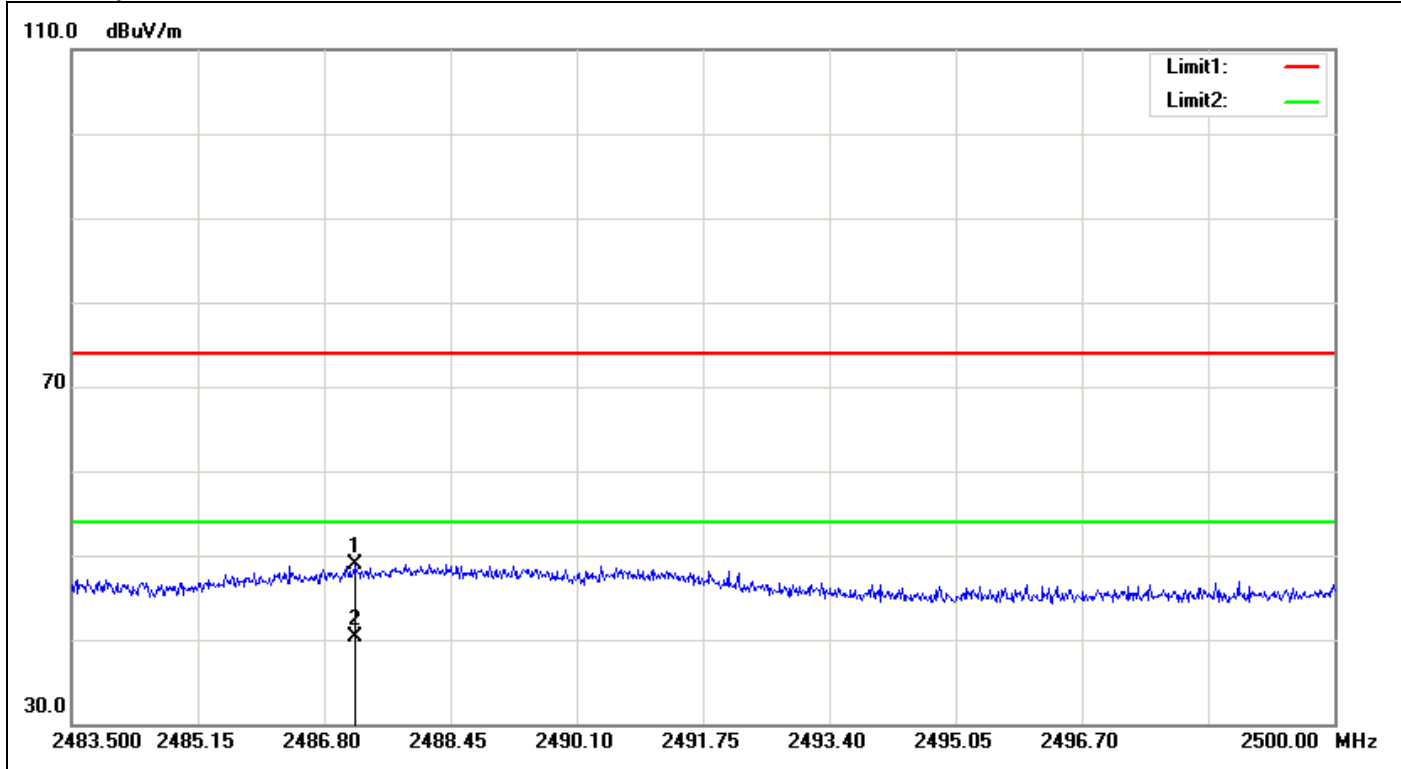

No.	Frequency (MHz)	Reading (dBuV)	Correct Factor(dB/m)	Result (dBuV/m)	Limit (dBuV/m)	Margin (dB)	Height (cm)	Degree (°)	Remark
1	2487.196	49.37	-0.43	48.94	74.00	-25.06			peak
2	2487.196	40.68	-0.43	40.25	54.00	-13.75			AVG



Polarity: Horizontal

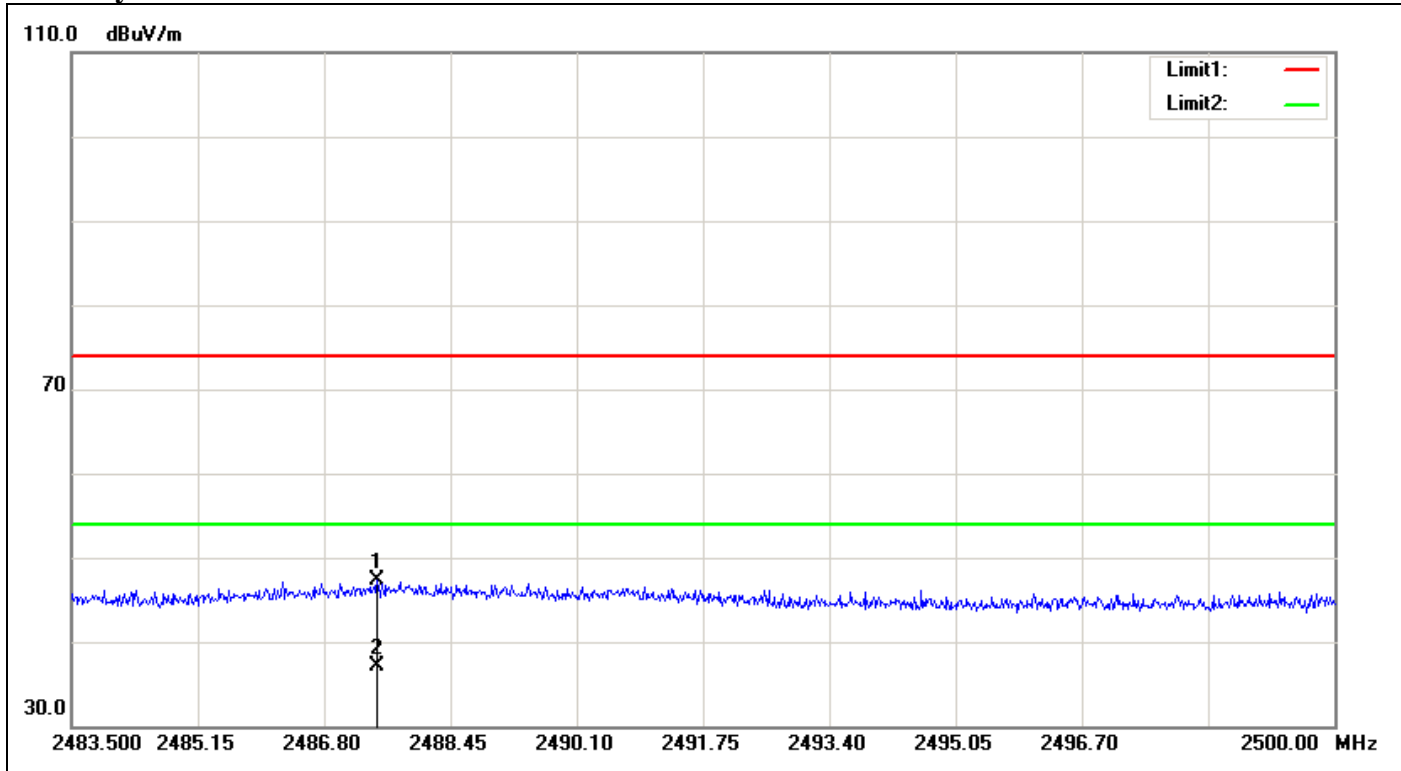

No.	Frequency (MHz)	Reading (dBuV)	Correct Factor(dB/m)	Result (dBuV/m)	Limit (dBuV/m)	Margin (dB)	Height (cm)	Degree (°)	Remark
1	2487.493	47.64	-0.43	47.21	74.00	-26.79			peak
2	2487.493	37.50	-0.43	37.07	54.00	-16.93			AVG



Band Edges (IEEE 802.11g mode / CH Low)

Polarity: Vertical

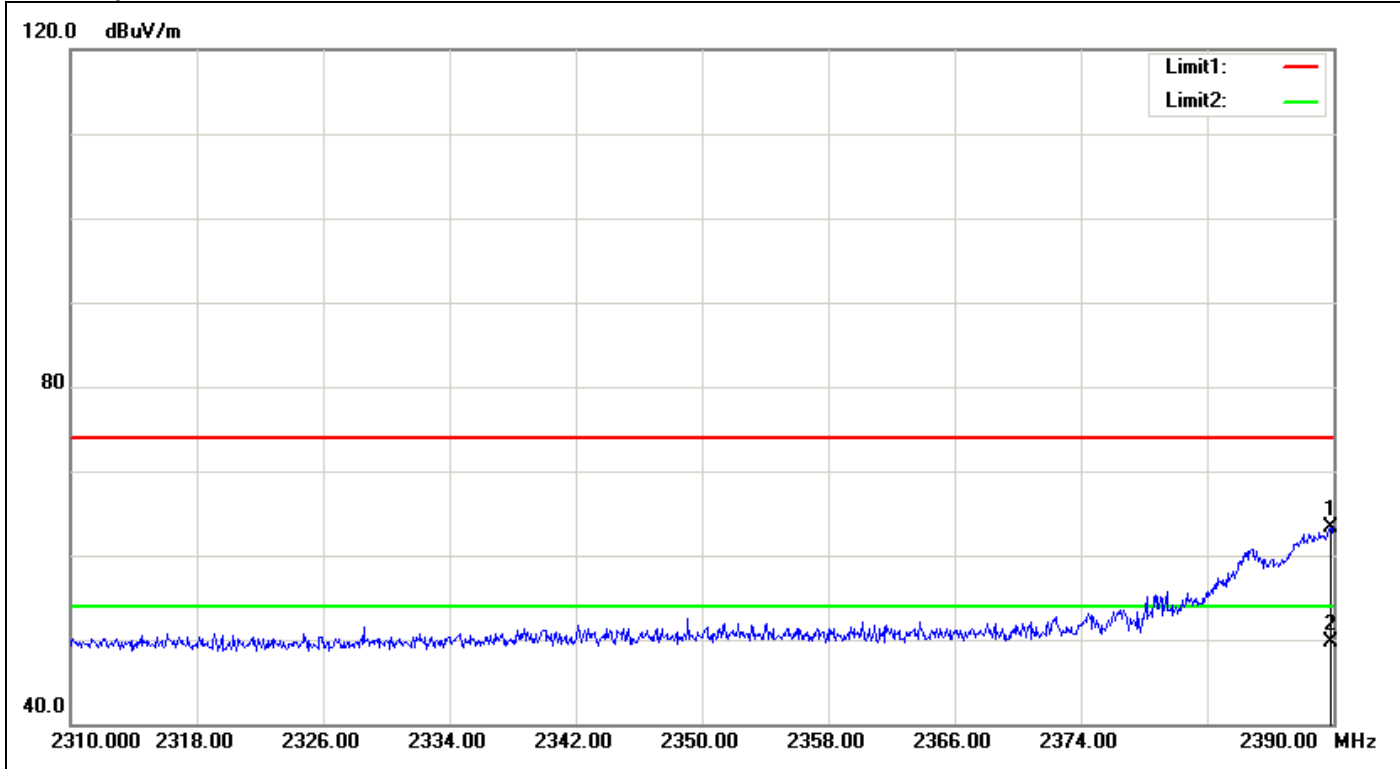

No.	Frequency (MHz)	Reading (dBuV)	Correct Factor(dB/m)	Result (dBuV/m)	Limit (dBuV/m)	Margin (dB)	Height (cm)	Degree (°)	Remark
1	2389.840	64.29	-1.05	63.24	74.00	-10.76			peak
2	2389.840	50.79	-1.05	49.74	54.00	-4.26			AVG



Polarity: Horizontal

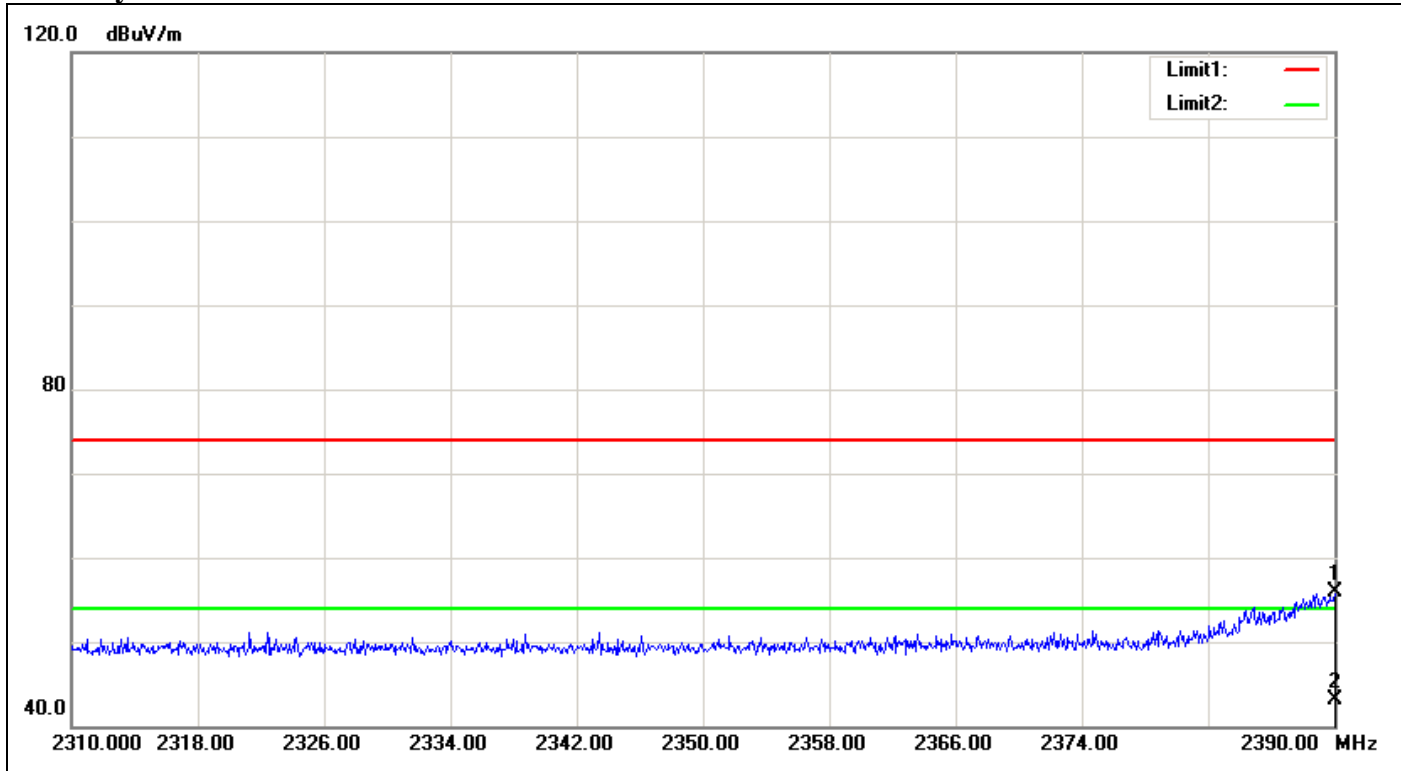

No.	Frequency (MHz)	Reading (dBuV)	Correct Factor(dB/m)	Result (dBuV/m)	Limit (dBuV/m)	Margin (dB)	Height (cm)	Degree (°)	Remark
1	2390.000	56.89	-1.05	55.84	74.00	-18.16			peak
2	2390.000	44.21	-1.05	43.16	54.00	-10.84			AVG



Band Edges (IEEE 802.11g mode / CH High)

Polarity: Vertical

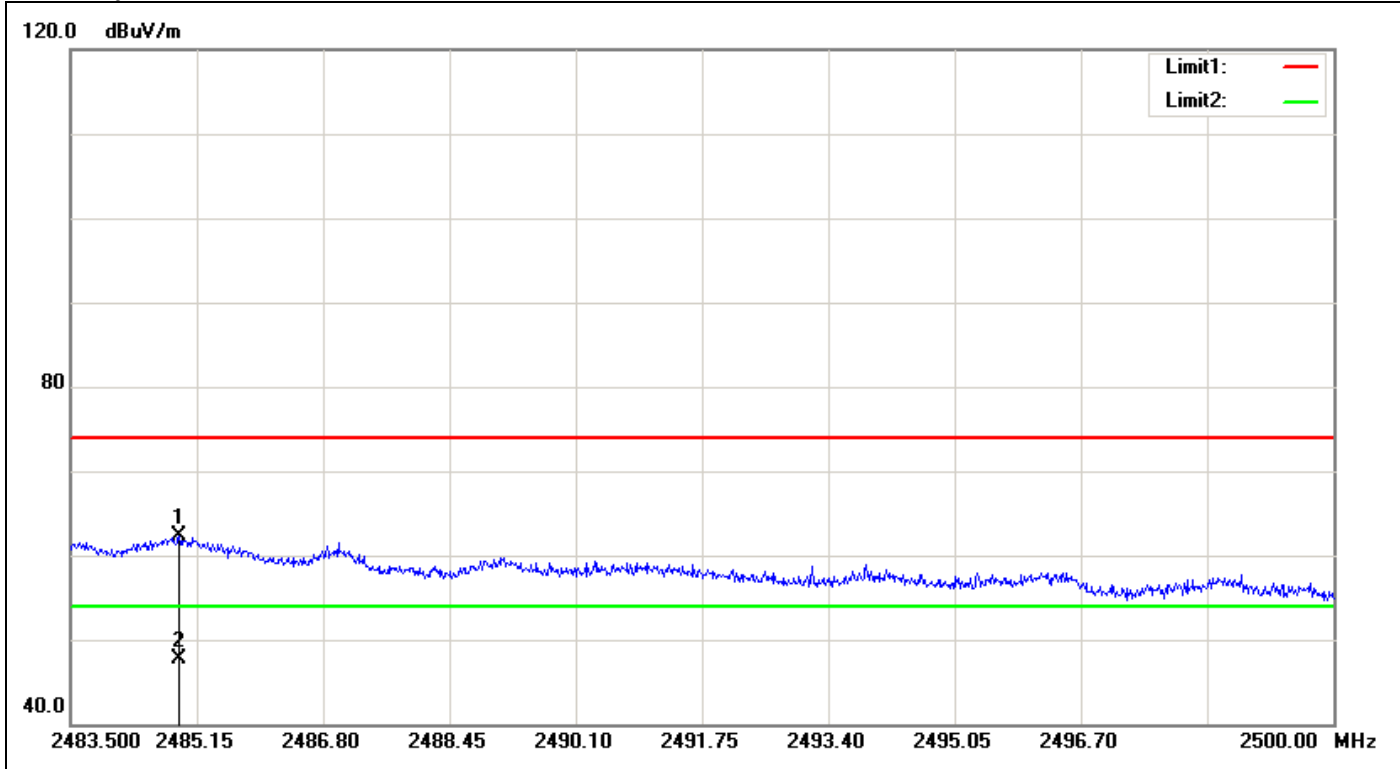

No.	Frequency (MHz)	Reading (dBuV)	Correct Factor(dB/m)	Result (dBuV/m)	Limit (dBuV/m)	Margin (dB)	Height (cm)	Degree (°)	Remark
1	2484.919	62.74	-0.46	62.28	74.00	-11.72			peak
2	2484.919	48.26	-0.46	47.80	54.00	-6.20			AVG



Polarity: Horizontal

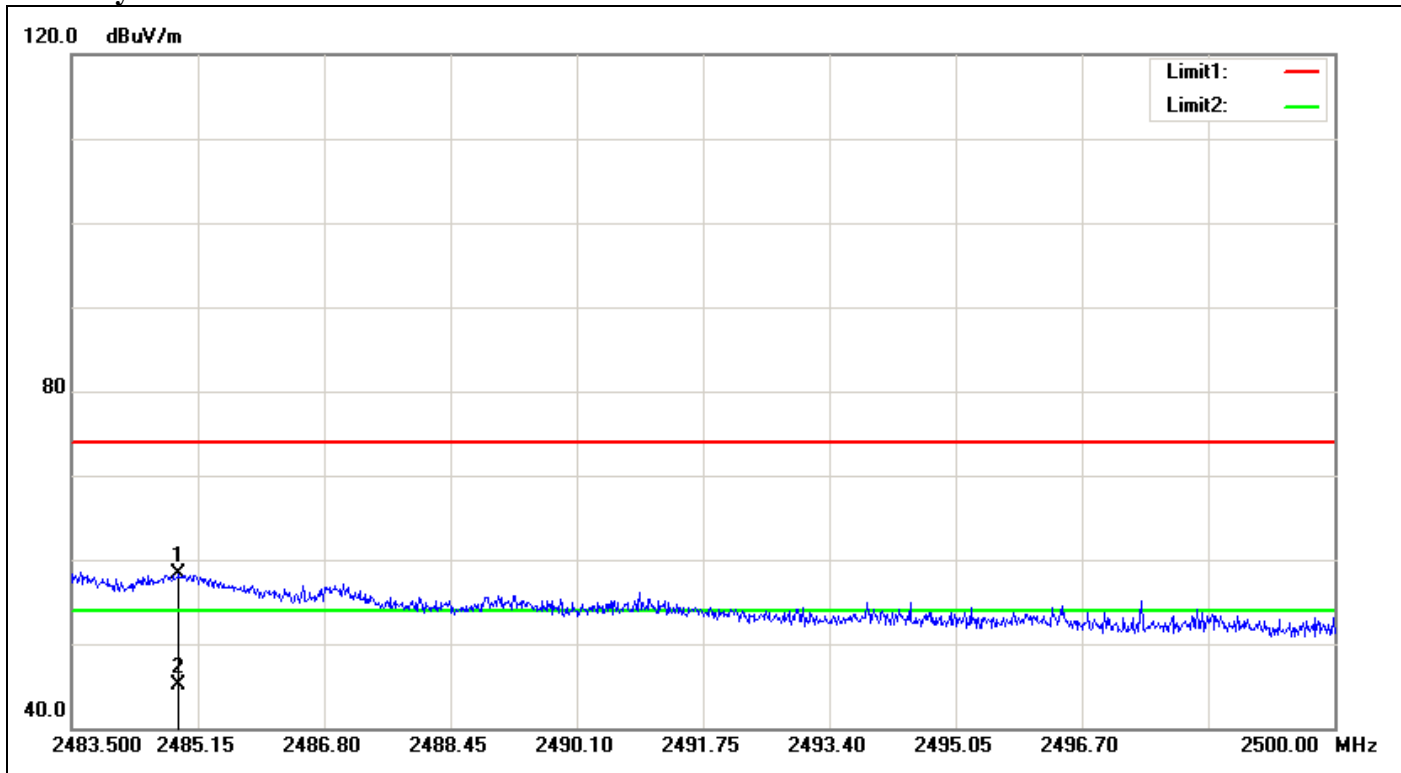

No.	Frequency (MHz)	Reading (dBuV)	Correct Factor(dB/m)	Result (dBuV/m)	Limit (dBuV/m)	Margin (dB)	Height (cm)	Degree (°)	Remark
1	2484.903	58.70	-0.46	58.24	74.00	-15.76			peak
2	2484.903	45.50	-0.46	45.04	54.00	-8.96			AVG



Band Edges (IEEE 802.11n HT 20 mode / CH Low)

Polarity: Vertical

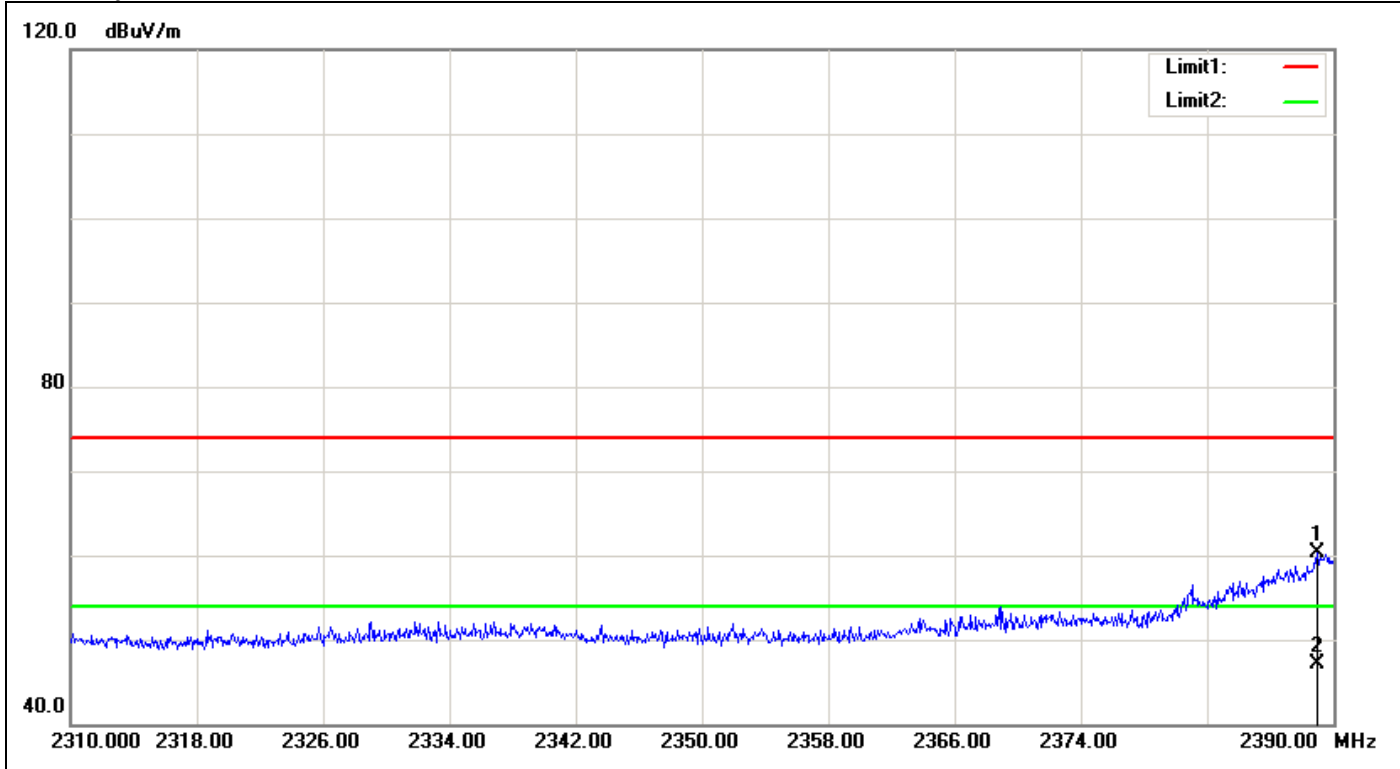

No.	Frequency (MHz)	Reading (dBuV)	Correct Factor(dB/m)	Result (dBuV/m)	Limit (dBuV/m)	Margin (dB)	Height (cm)	Degree (°)	Remark
1	2388.960	61.35	-1.06	60.29	74.00	-13.71			peak
2	2388.960	48.20	-1.06	47.14	54.00	-6.86			AVG



Polarity: Horizontal

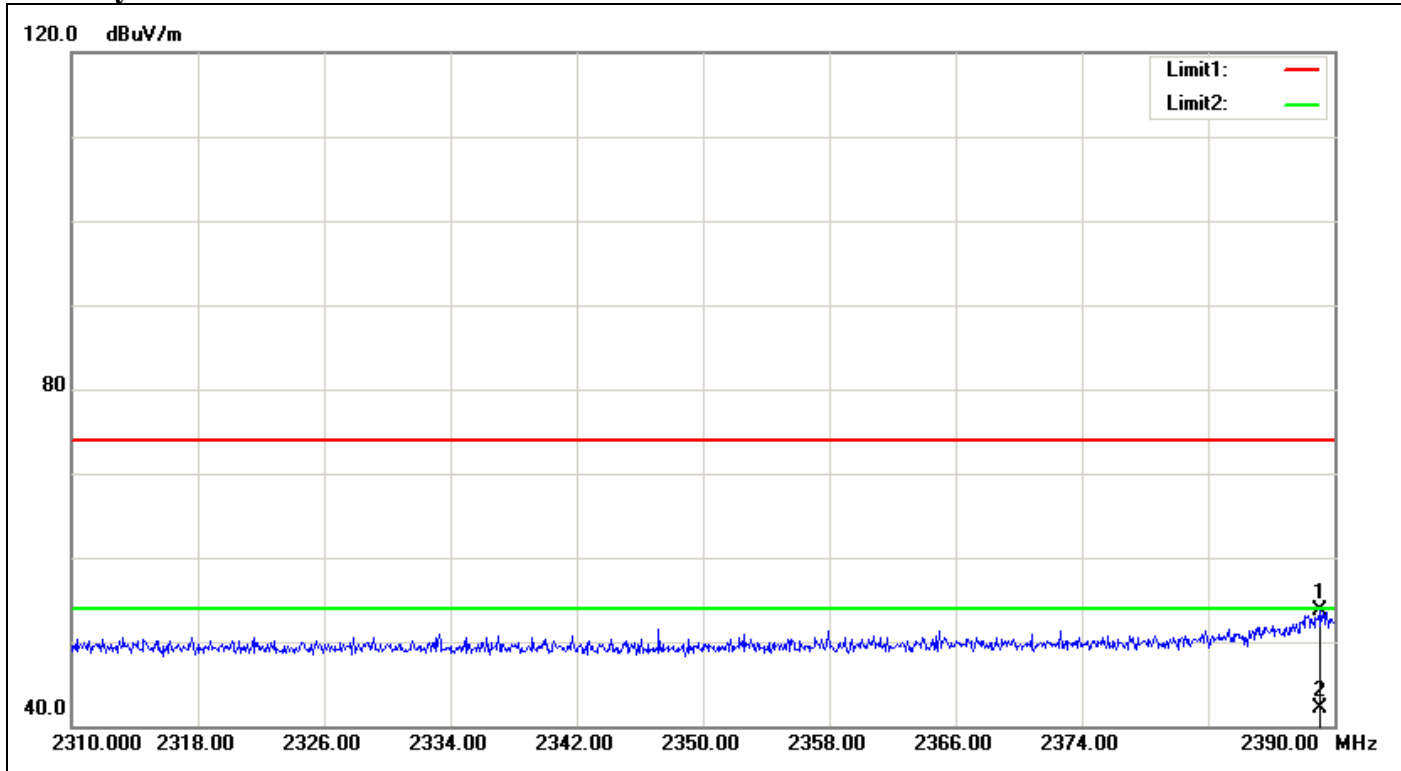

No.	Frequency (MHz)	Reading (dBuV)	Correct Factor(dB/m)	Result (dBuV/m)	Limit (dBuV/m)	Margin (dB)	Height (cm)	Degree (°)	Remark
1	2389.040	54.68	-1.06	53.62	74.00	-20.38			peak
2	2389.040	43.13	-1.06	42.07	54.00	-11.93			AVG



Band Edges (IEEE 802.11n HT 20 mode / CH High)

Polarity: Vertical

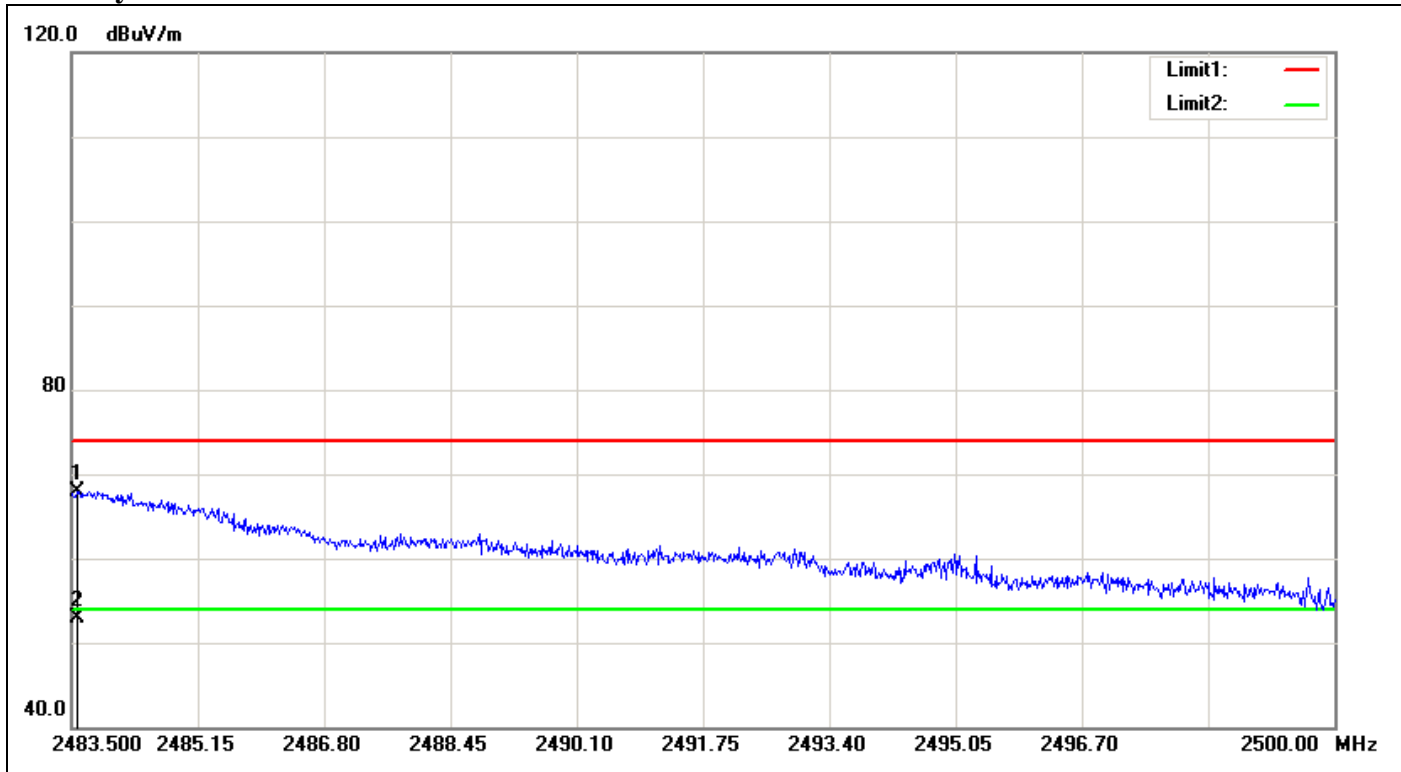

No.	Frequency (MHz)	Reading (dBuV)	Correct Factor(dB/m)	Result (dBuV/m)	Limit (dBuV/m)	Margin (dB)	Height (cm)	Degree (°)	Remark
1	2483.582	68.45	-0.47	67.98	74.00	-6.02			peak
2	2483.582	53.43	-0.47	52.96	54.00	-1.04			AVG



Polarity: Horizontal

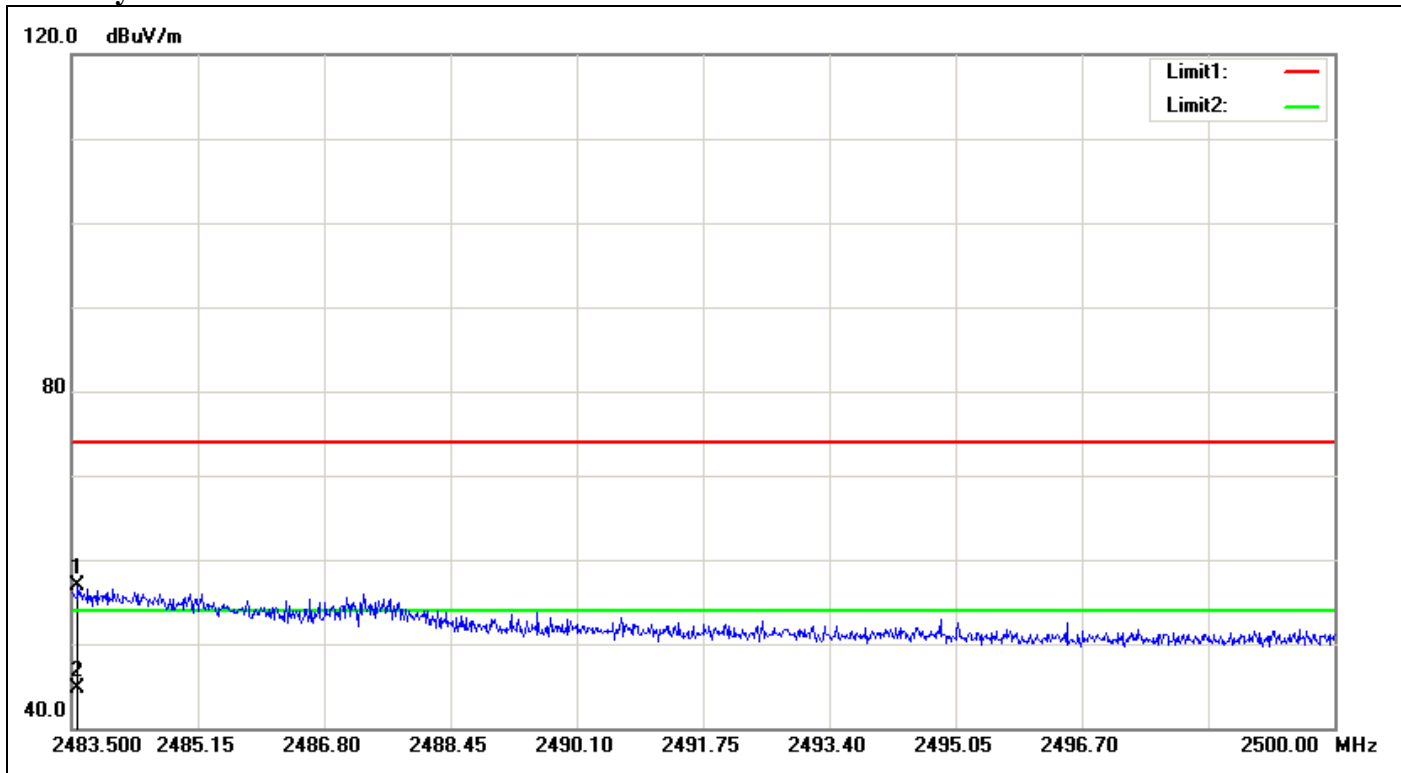

No.	Frequency (MHz)	Reading (dBuV)	Correct Factor(dB/m)	Result (dBuV/m)	Limit (dBuV/m)	Margin (dB)	Height (cm)	Degree (°)	Remark
1	2483.582	57.31	-0.47	56.84	74.00	-17.16			peak
2	2483.582	45.19	-0.47	44.72	54.00	-9.28			AVG



Band Edges (IEEE 802.11n HT 40 mode / CH Low)

Polarity: Vertical

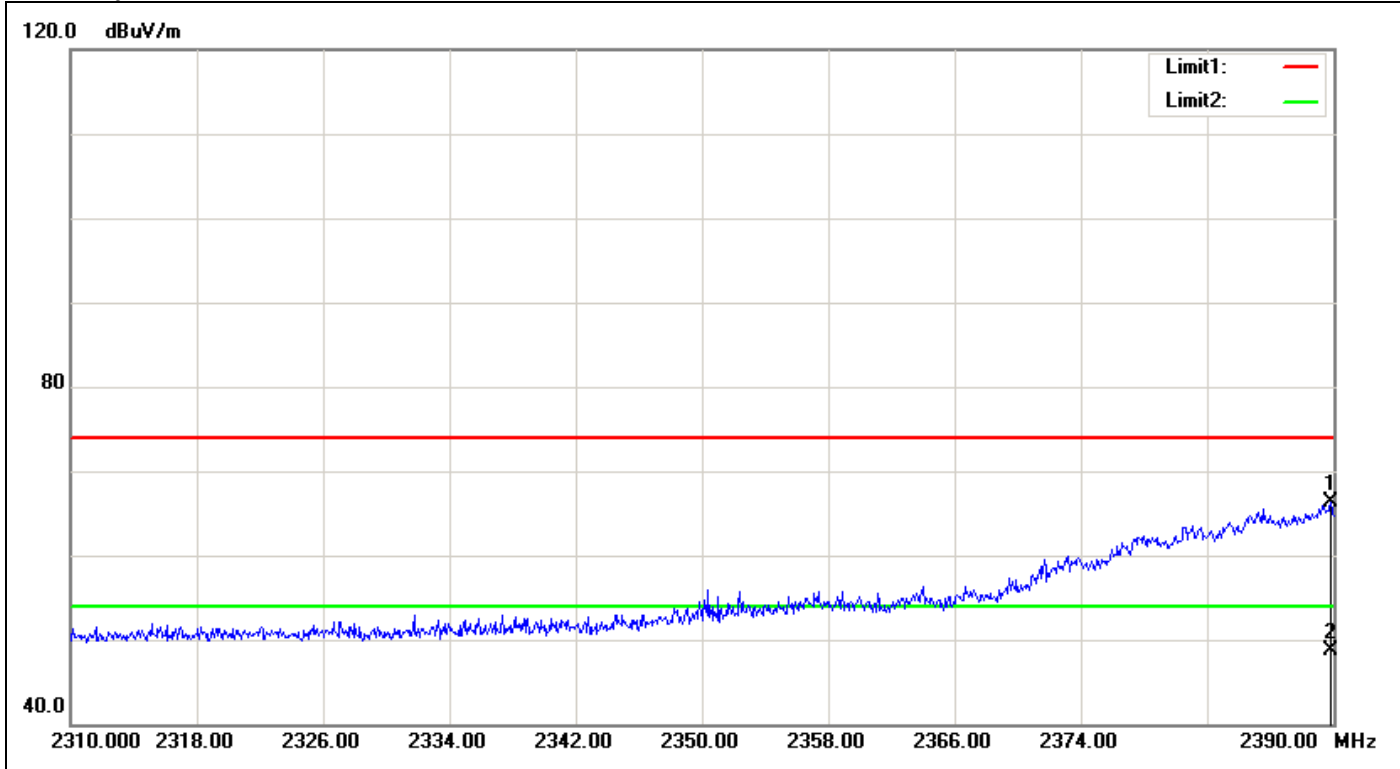

No.	Frequency (MHz)	Reading (dBuV)	Correct Factor(dB/m)	Result (dBuV/m)	Limit (dBuV/m)	Margin (dB)	Height (cm)	Degree (°)	Remark
1	2389.840	67.28	-1.05	66.23	74.00	-7.77			peak
2	2389.840	49.78	-1.05	48.73	54.00	-5.27			AVG



Polarity: Horizontal

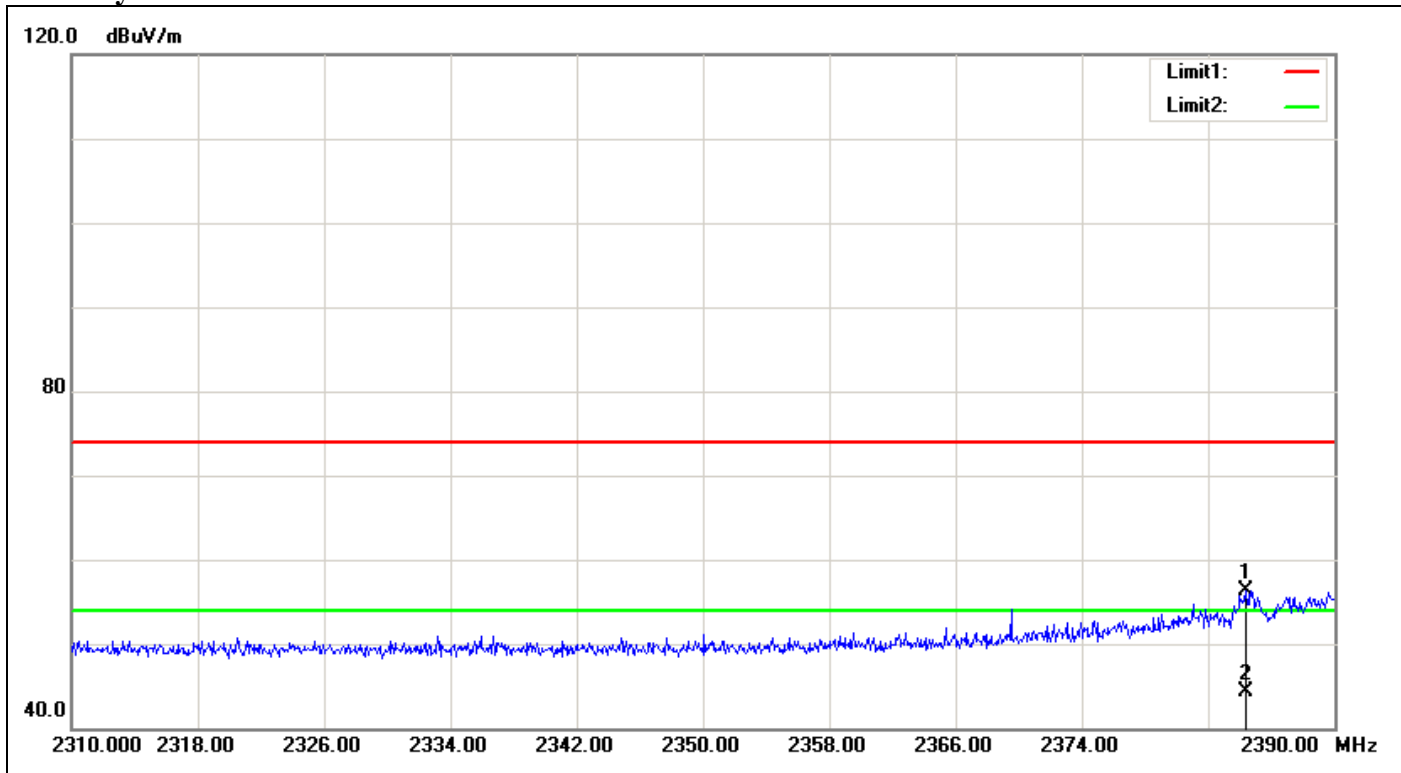

No.	Frequency (MHz)	Reading (dBuV)	Correct Factor(dB/m)	Result (dBuV/m)	Limit (dBuV/m)	Margin (dB)	Height (cm)	Degree (°)	Remark
1	2384.400	57.39	-1.11	56.28	74.00	-17.72			peak
2	2384.400	45.46	-1.11	44.35	54.00	-9.65			AVG



Band Edges (IEEE 802.11n HT 40 mode / CH High)

Polarity: Vertical

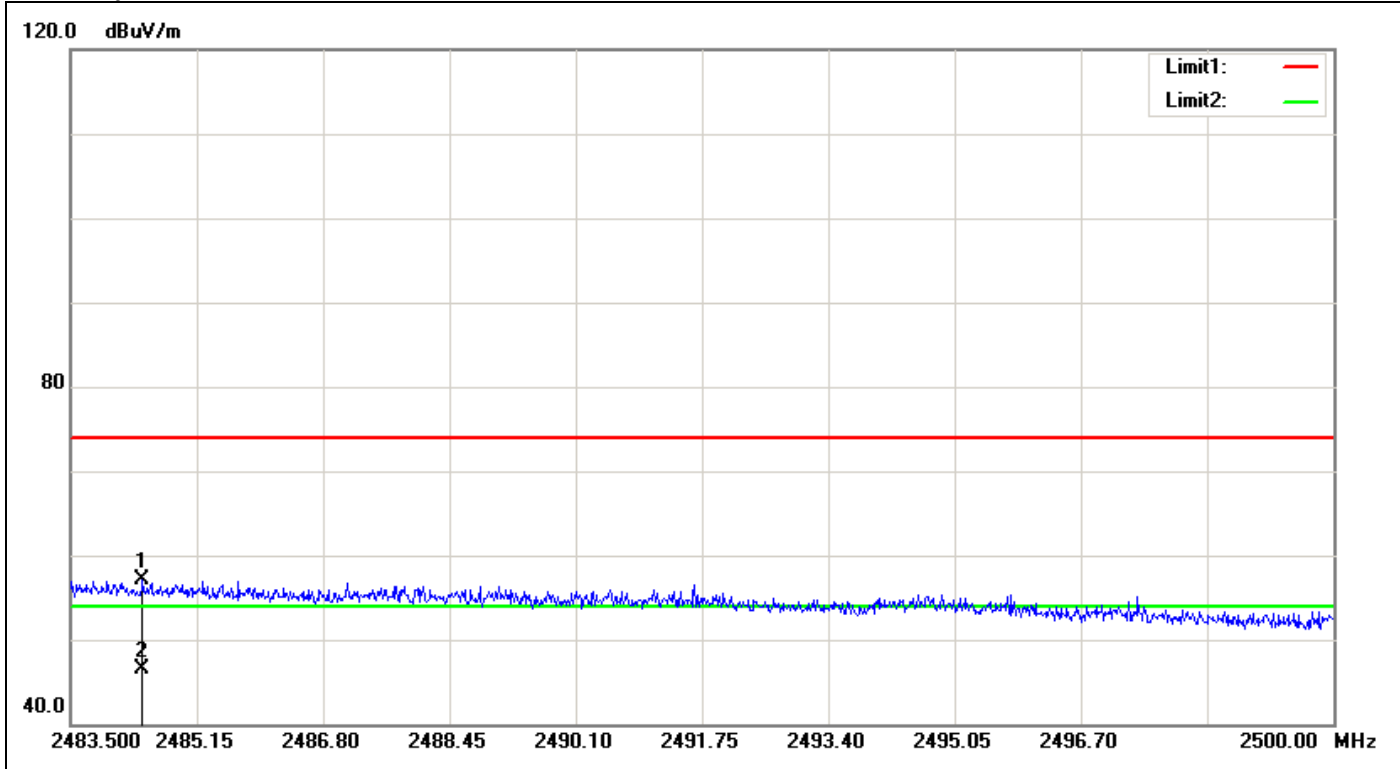

No.	Frequency (MHz)	Reading (dBuV)	Correct Factor(dB/m)	Result (dBuV/m)	Limit (dBuV/m)	Margin (dB)	Height (cm)	Degree (°)	Remark
1	2484.441	57.49	-0.46	57.03	74.00	-16.97			peak
2	2484.441	46.88	-0.46	46.42	54.00	-7.58			AVG



Polarity: Horizontal

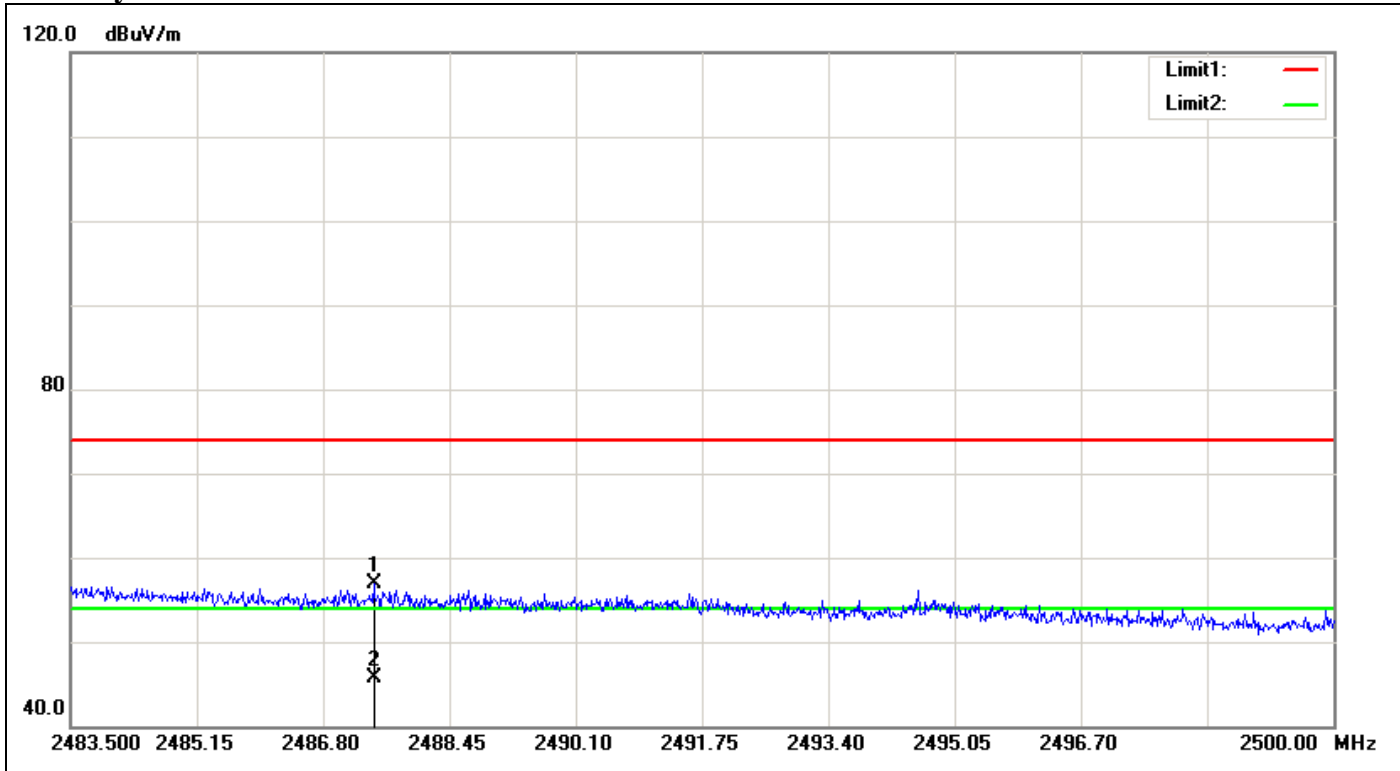

No.	Frequency (MHz)	Reading (dBuV)	Correct Factor(dB/m)	Result (dBuV/m)	Limit (dBuV/m)	Margin (dB)	Height (cm)	Degree (°)	Remark
1	2487.460	57.34	-0.43	56.91	74.00	-17.09			peak
2	2487.460	46.16	-0.43	45.73	54.00	-8.27			AVG



Test Plot

Conducted Band Edges (IEEE 802.11b mode / CH Low)

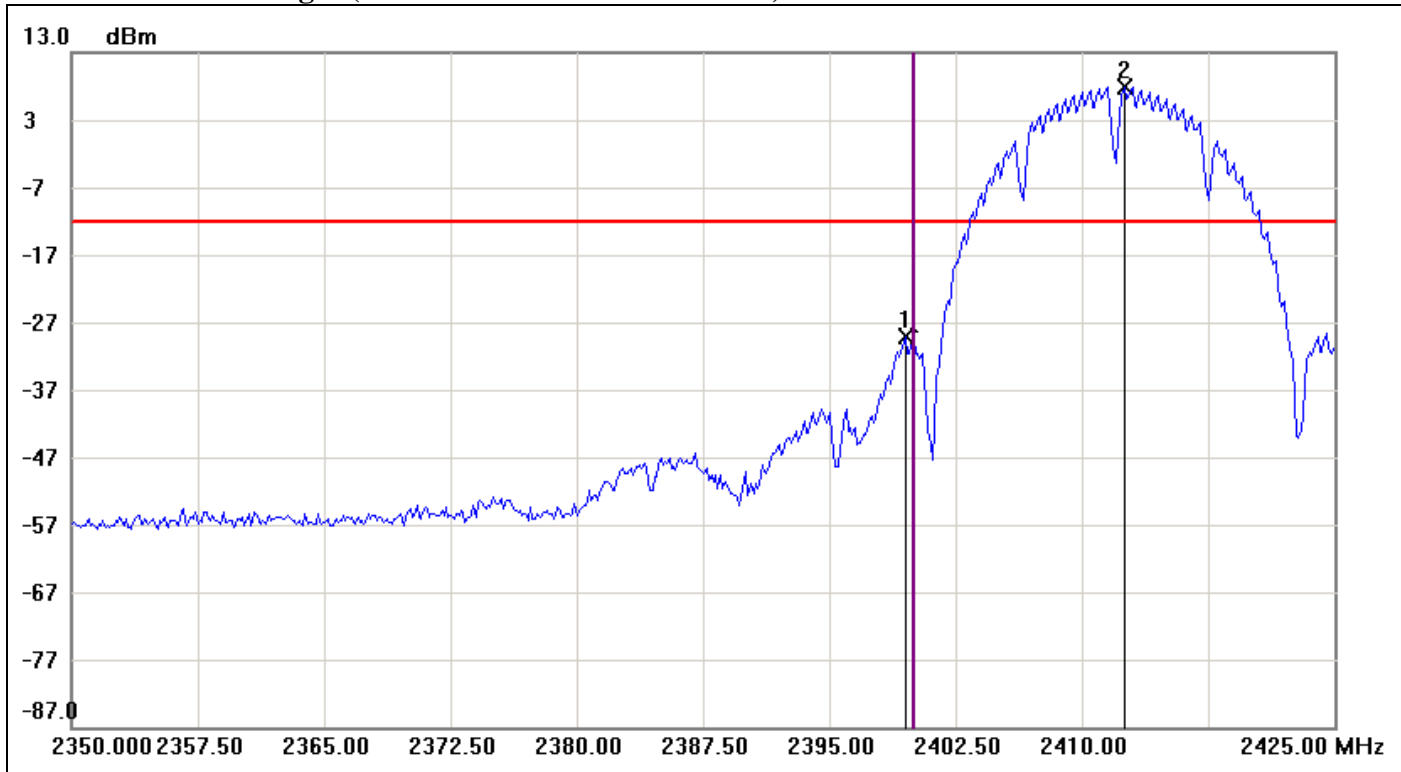

No.	Frequency(MHz)	Result(dBm)	Limit(dBm)	Margin(dBm)
1	2399.5000	-29.11	-12.19	-16.92
2	2412.5000	7.81	-12.19	20.00



Conducted Band Edges (IEEE 802.11b mode / CH High)

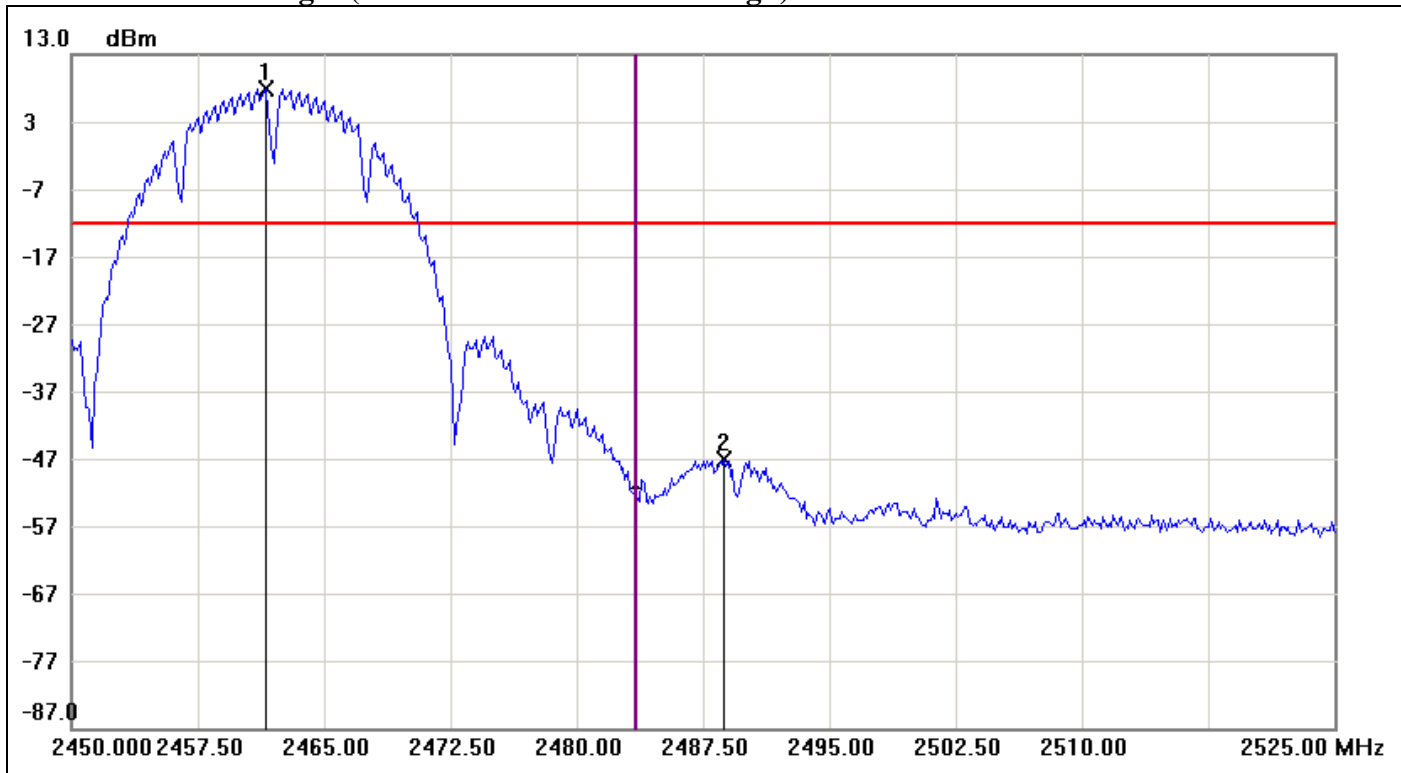

No.	Frequency(MHz)	Result(dBm)	Limit(dBm)	Margin(dBm)
1	2461.5000	7.87	-12.13	20.00
2	2488.7500	-47.01	-12.13	-34.88



Conducted Band Edges (IEEE 802.11g mode / CH Low)

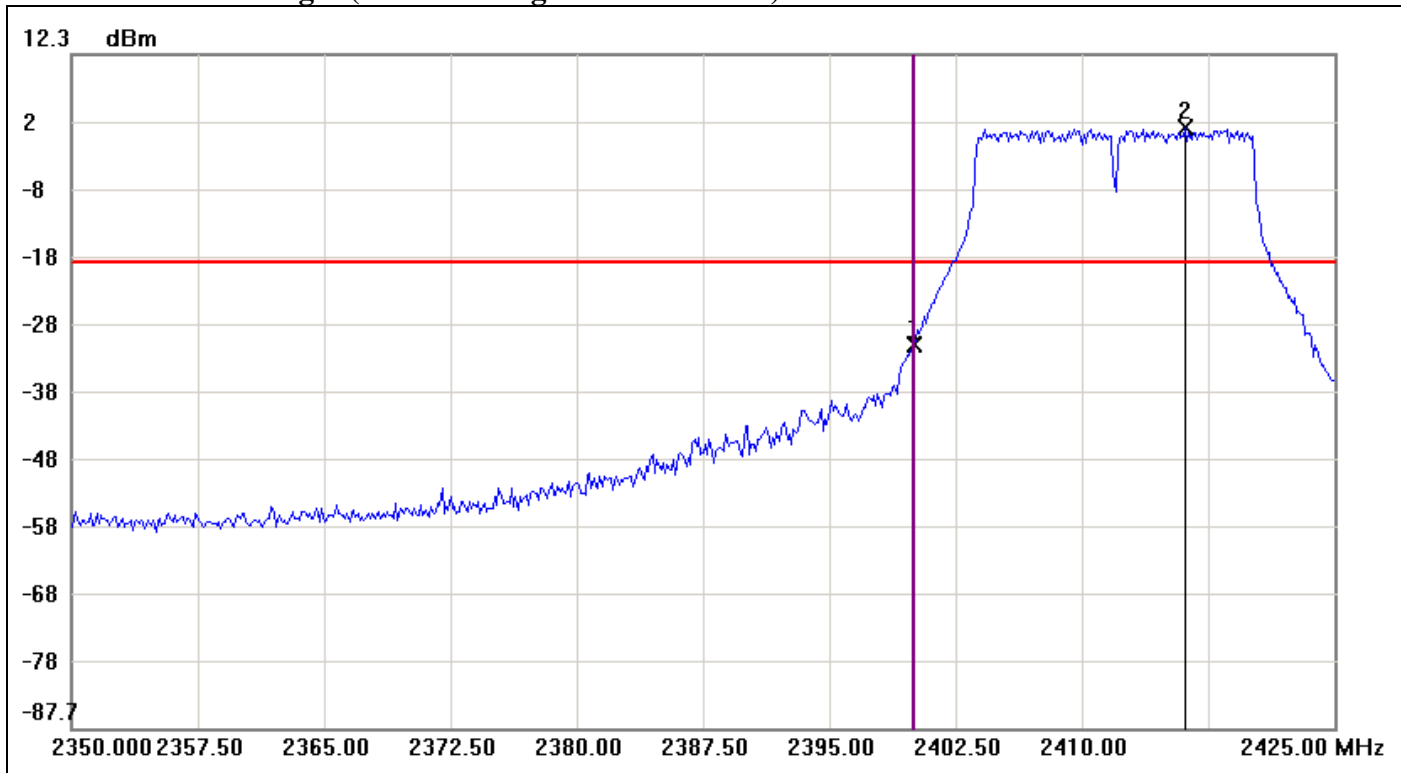

No.	Frequency(MHz)	Result(dBm)	Limit(dBm)	Margin(dBm)
1	2400.0000	-30.75	-18.63	-12.12
2	2416.1250	1.37	-18.63	20.00



Conducted Band Edges (IEEE 802.11g mode / CH High)

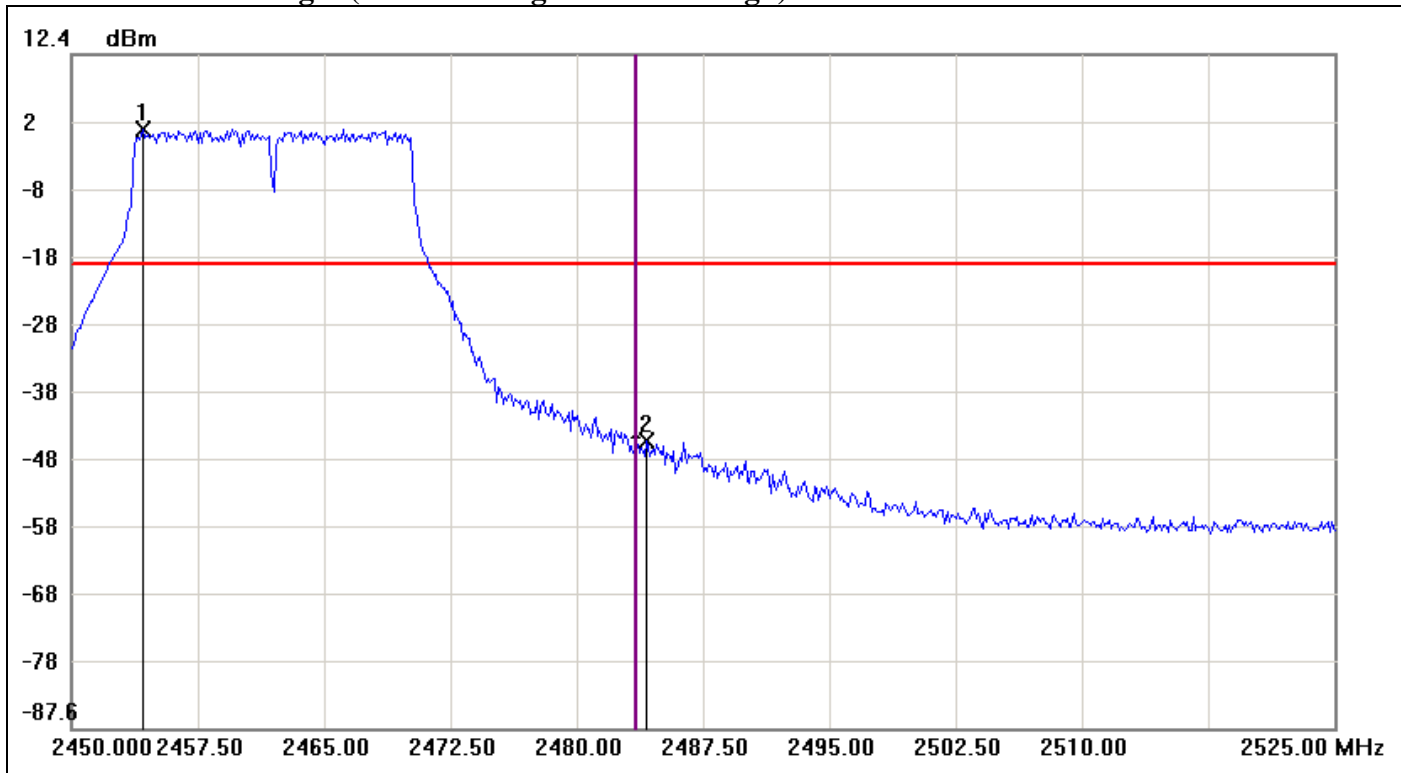

No.	Frequency(MHz)	Result(dBm)	Limit(dBm)	Margin(dBm)
1	2454.2500	1.35	-18.65	20.00
2	2484.1250	-44.91	-18.65	-26.26



Conducted Band Edges (IEEE 802.11n HT 20 mode / CH Low / Chain 0)

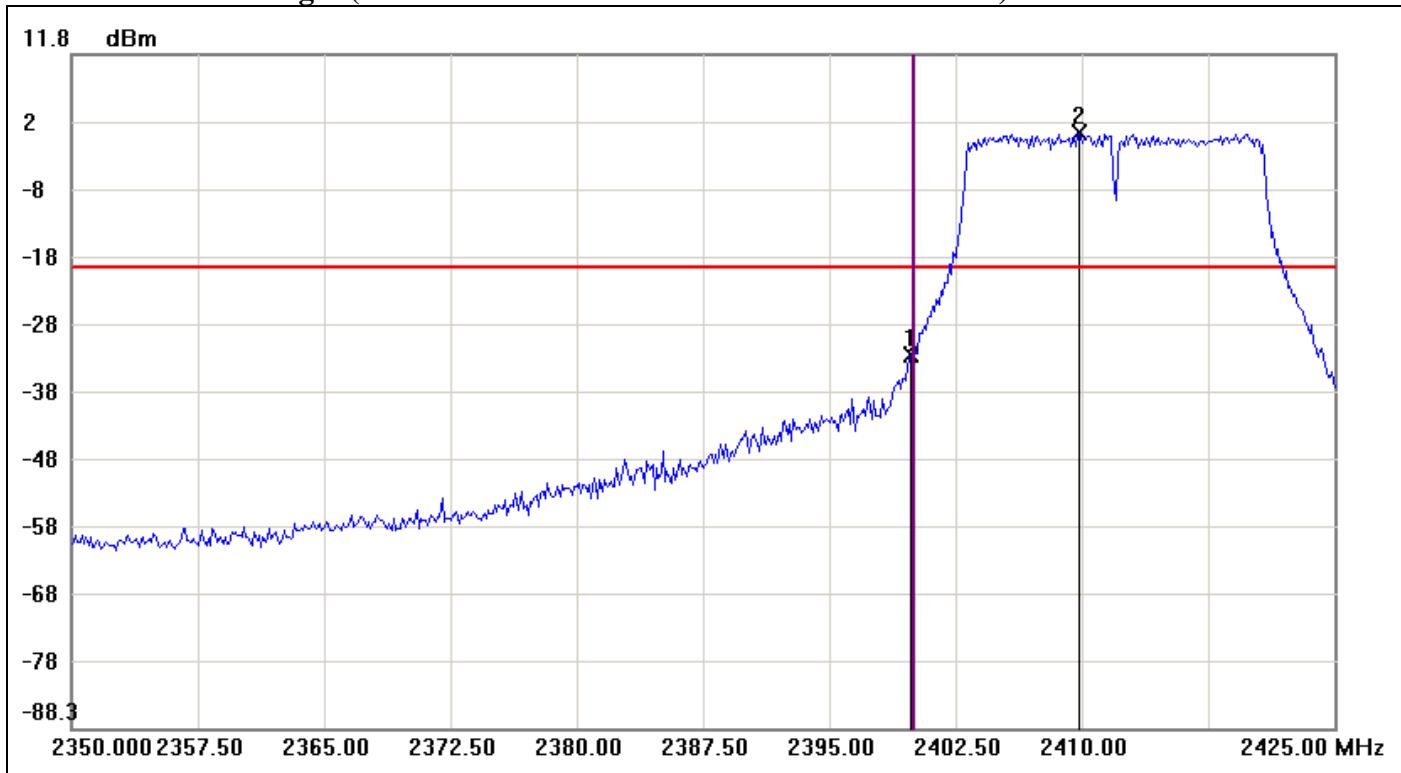

No.	Frequency(MHz)	Result(dBm)	Limit(dBm)	Margin(dBm)
1	2399.8750	-32.91	-19.95	-12.96
2	2409.8750	0.05	-19.95	20.00



Conducted Band Edges (IEEE 802.11n HT 20 mode / CH High / Chain 0)

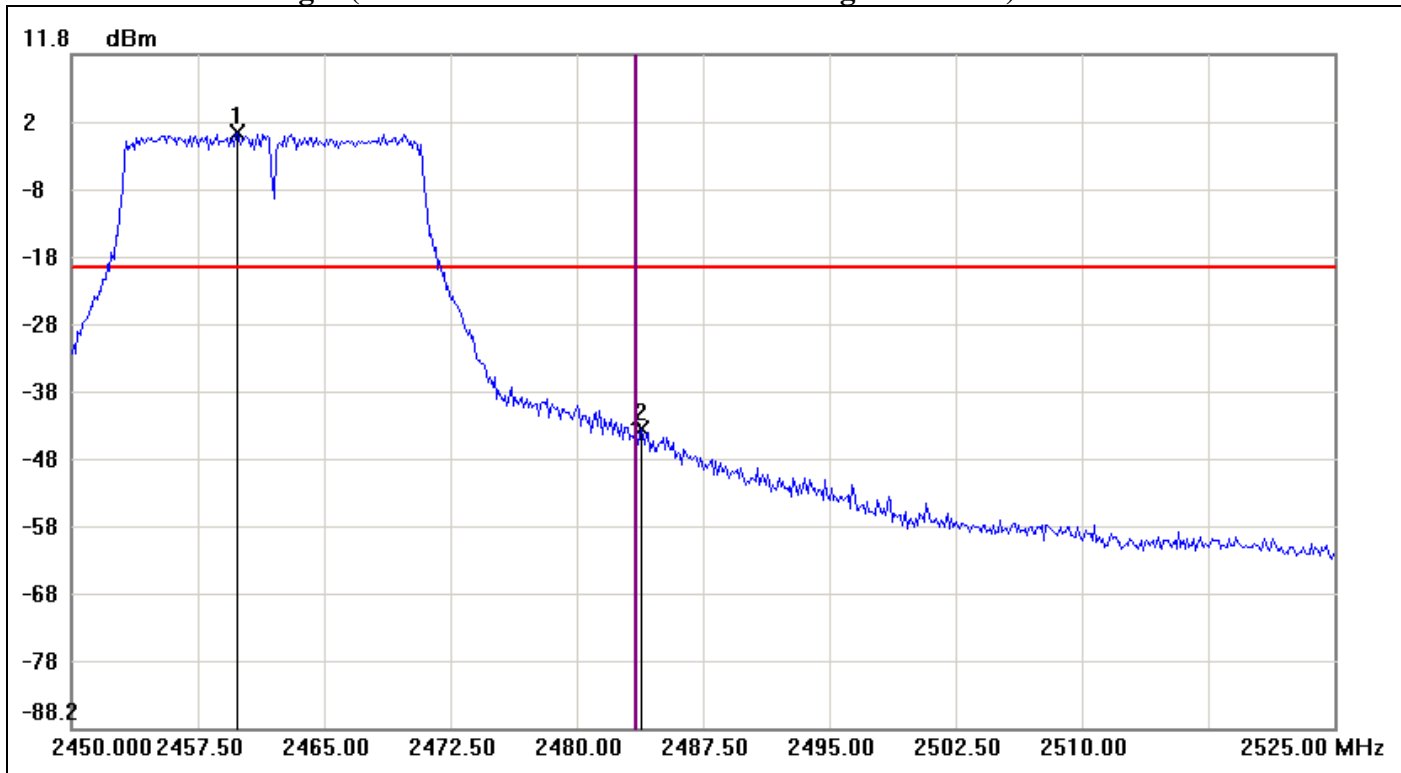

No.	Frequency(MHz)	Result(dBm)	Limit(dBm)	Margin(dBm)
1	2459.8750	0.32	-19.68	20.00
2	2483.8750	-43.71	-19.68	-24.03



Conducted Band Edges (IEEE 802.11n HT 20 mode / CH Low / Chain 1)

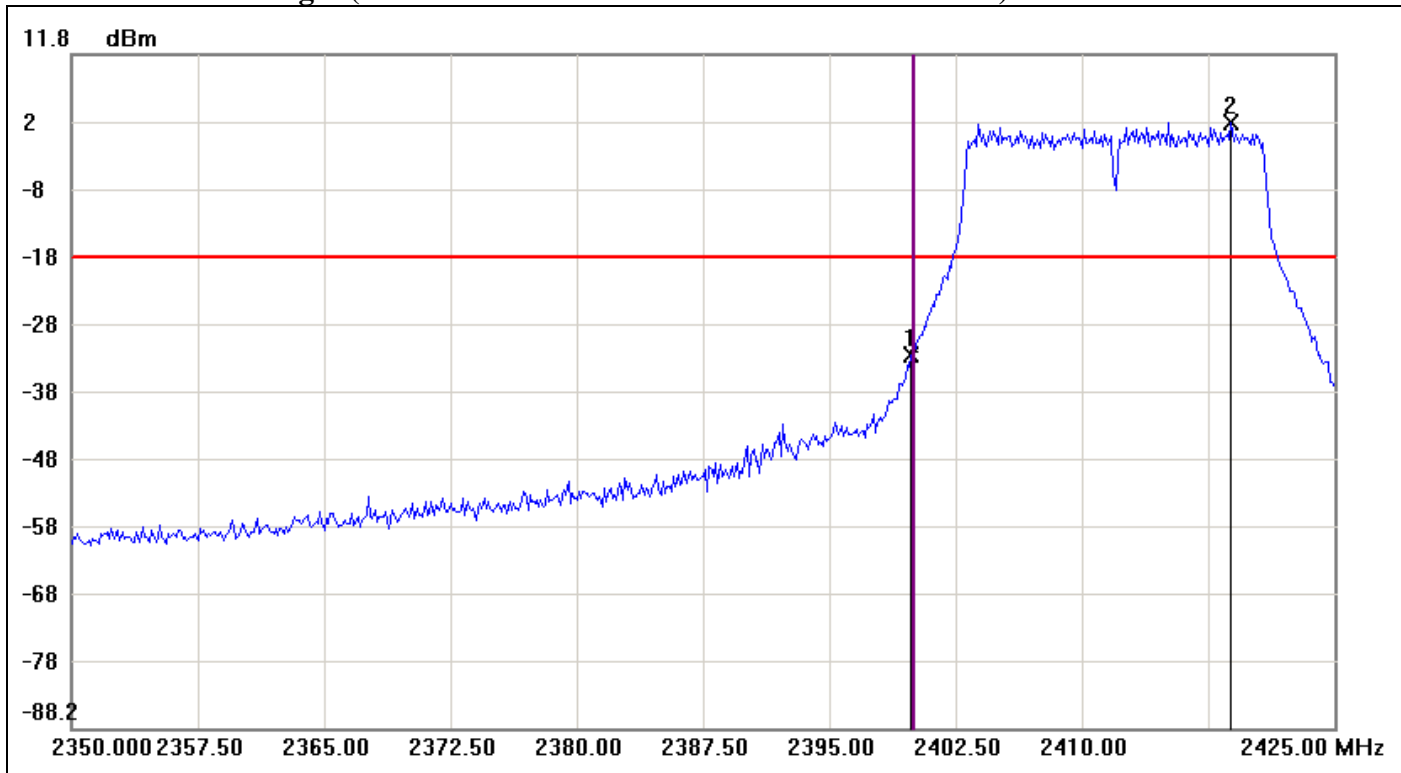

No.	Frequency(MHz)	Result(dBm)	Limit(dBm)	Margin(dBm)
1	2399.8750	-32.80	-18.39	-14.41
2	2418.8750	1.61	-18.39	20.00



Conducted Band Edges (IEEE 802.11n HT 20 mode / CH High / Chain 1)

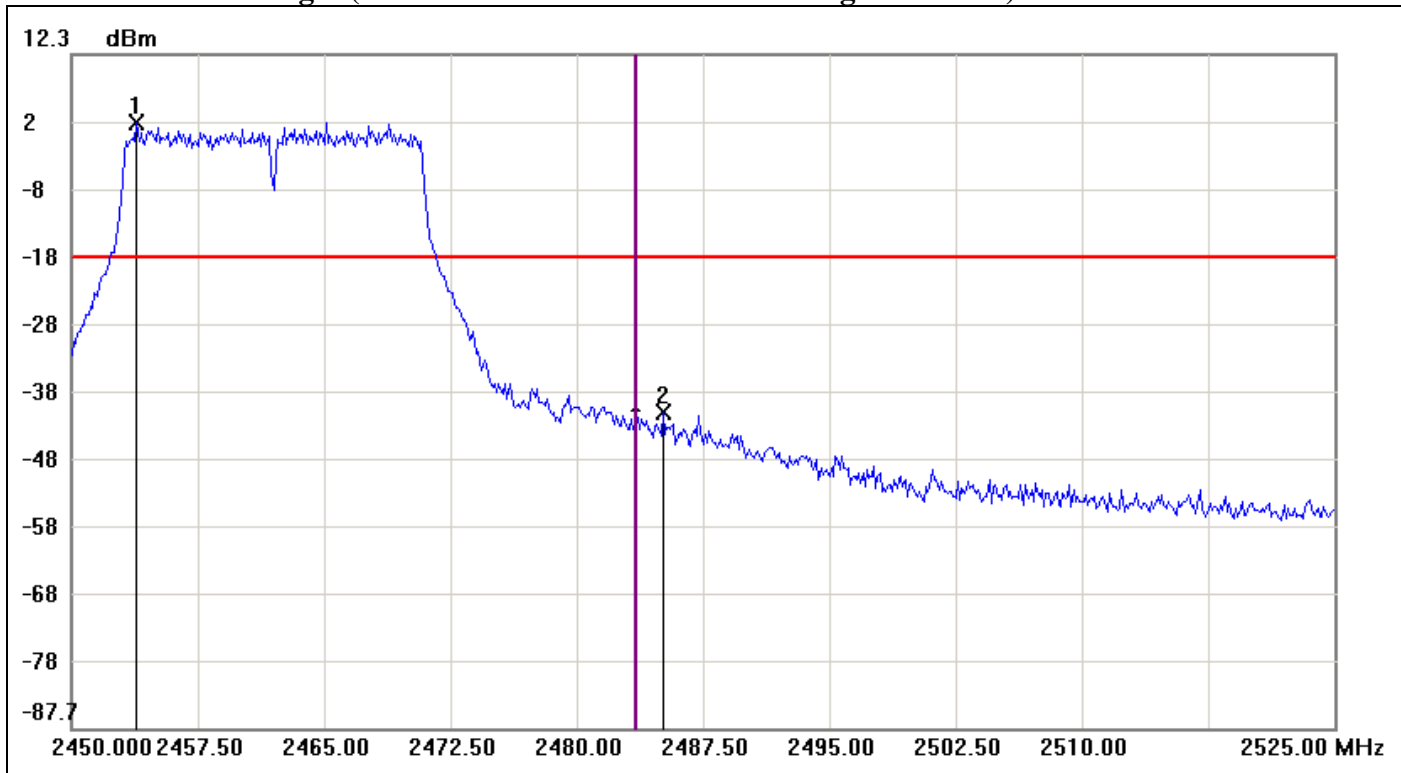

No.	Frequency(MHz)	Result(dBm)	Limit(dBm)	Margin(dBm)
1	2453.8750	2.15	-17.85	20.00
2	2485.1250	-40.84	-17.85	-22.99



Conducted Band Edges (IEEE 802.11n HT 40 mode / CH Low / Chain 0)

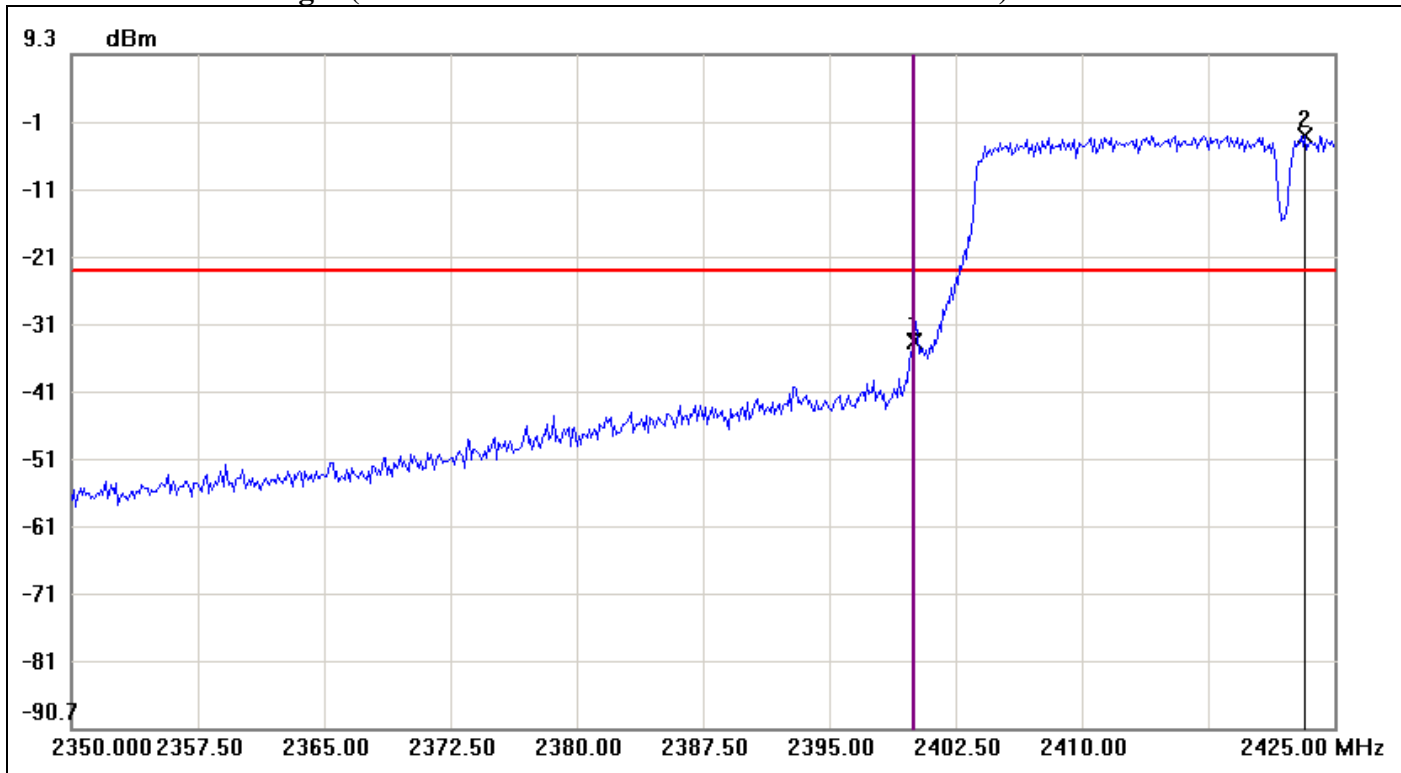

No.	Frequency(MHz)	Result(dBm)	Limit(dBm)	Margin(dBm)
1	2400.0000	-33.20	-22.67	-10.53
2	2423.2500	-2.67	-22.67	20.00



Conducted Band Edges (IEEE 802.11n HT 40 mode / CH High / Chain 0)

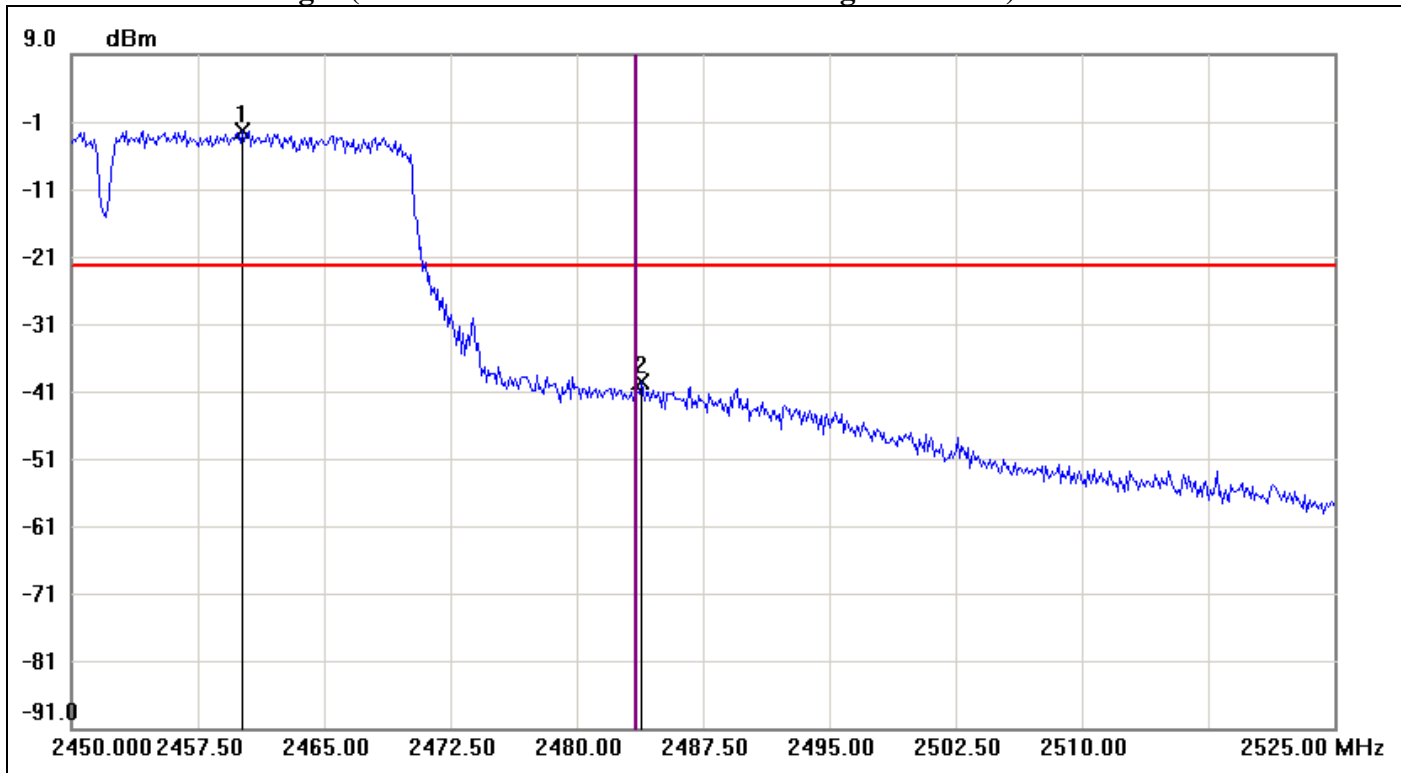

No.	Frequency(MHz)	Result(dBm)	Limit(dBm)	Margin(dBm)
1	2460.1250	-2.26	-22.26	20.00
2	2483.8750	-39.70	-22.26	-17.44



Conducted Band Edges (IEEE 802.11n HT 40 mode / CH Low / Chain 1)

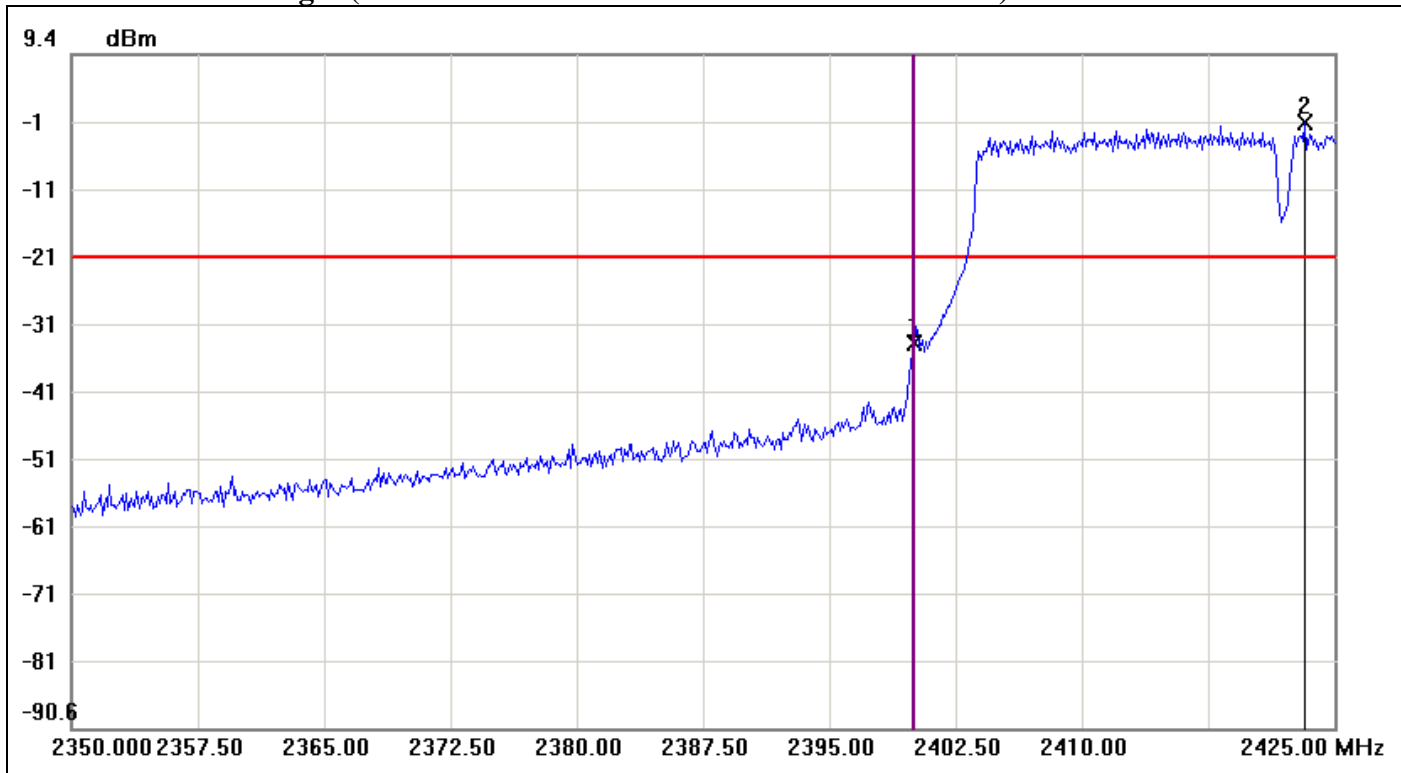

No.	Frequency(MHz)	Result(dBm)	Limit(dBm)	Margin(dBm)
1	2400.0000	-33.36	-20.62	-12.74
2	2423.2500	-0.62	-20.62	20.00



Conducted Band Edges (IEEE 802.11n HT 40 mode / CH High / Chain 1)

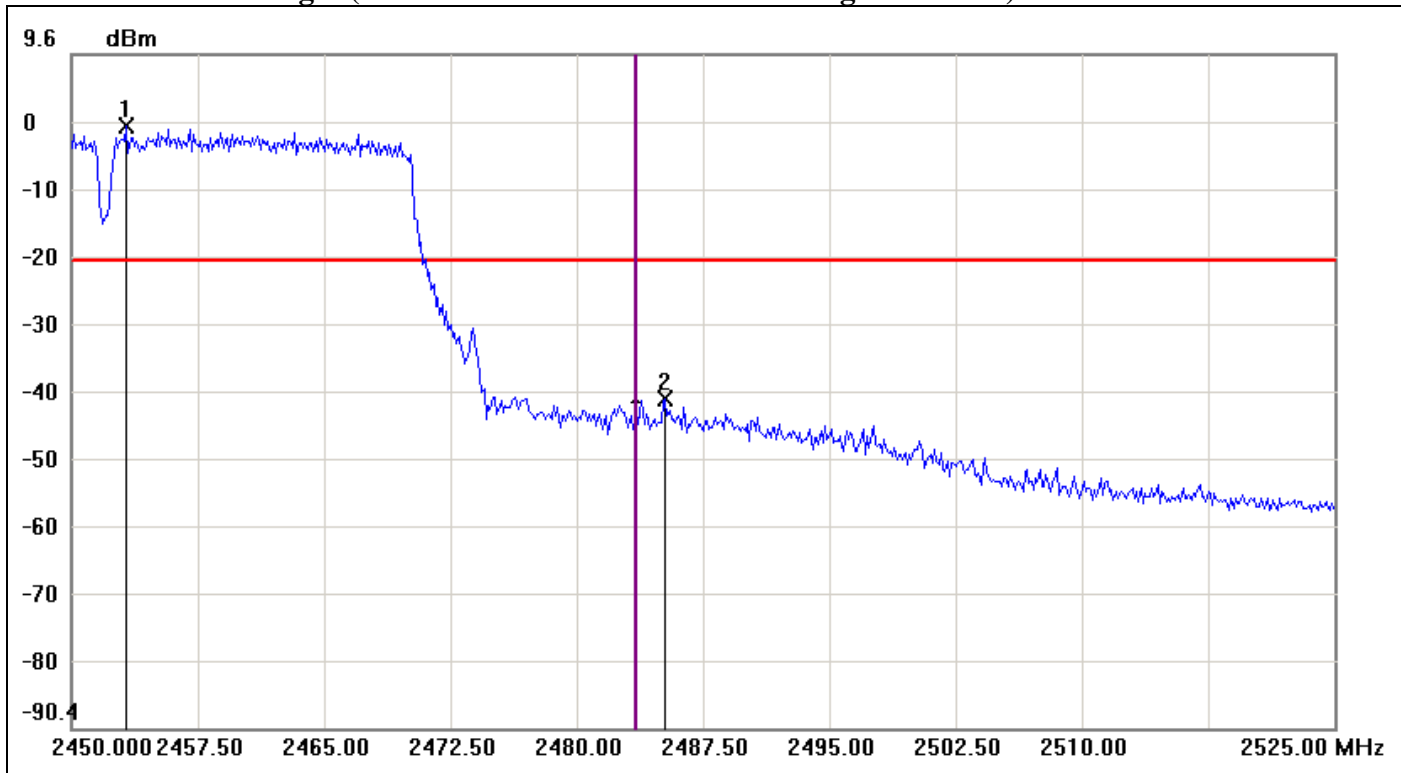

No.	Frequency(MHz)	Result(dBm)	Limit(dBm)	Margin(dBm)
1	2453.2500	-0.99	-20.99	20.00
2	2485.2500	-41.52	-20.99	-20.53



7.5 PEAK POWER SPECTRAL DENSITY

LIMIT

1. According to §15.247(e), for digitally modulated systems, the power spectral density conducted from the intentional radiator to the antenna shall not be greater than 8 dBm in any 3 kHz band during any time interval of continuous transmission.
2. According to §15.247(f), the digital modulation operation of the hybrid system, with the frequency hopping turned off, shall comply with the power density requirements of paragraph (d) of this section.

Test Configuration

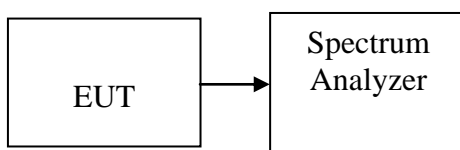

TEST PROCEDURE

The transmitter output is connected to a spectrum analyzer. Set the RBW = 100 kHz, VBW \geq 300 kHz, span to 1.5 times the DTS bandwidth, Detector = peak, Trace mode = max hold, Sweep = auto couple. Use the peak marker function to determine the maximum amplitude level within the RBW. If measured value exceeds limit, reduce RBW (no less than 3 kHz).

TEST RESULTS

No non-compliance noted.

**Test Data****Test mode: IEEE 802.11b mode**

Channel	Frequency (MHz)	PPSD (dBm)	Limit (dBm)	Result
Low	2412	-1.87	8.00	PASS
Mid	2437	-1.77		PASS
High	2462	-1.87		PASS

Test mode: IEEE 802.11g mode

Channel	Frequency (MHz)	PPSD (dBm)	Limit (dBm)	Result
Low	2412	-6.10	8.00	PASS
Mid	2437	-5.81		PASS
High	2462	-6.26		PASS

Test mode: IEEE 802.11n HT 20 mode

Channel	Frequency (MHz)	Chain 0 PPSD	Chain 1 PPSD	PPSD (dBm)	Limit (dBm)	Result
Low	2412	-6.20	-6.65	-3.41	8.00	PASS
Mid	2437	-5.57	-6.44	-2.97		PASS
High	2462	-6.74	-6.08	-3.39		PASS

Test mode: IEEE 802.11n HT 40 mode

Channel	Frequency (MHz)	Chain 0 PPSD	Chain 1 PPSD	PPSD (dBm)	Limit (dBm)	Result
Low	2412	-9.33	-8.41	-5.84	8.00	PASS
Mid	2437	-7.94	-8.32	-5.12		PASS
High	2462	-9.49	-8.63	-6.03		PASS

Remark: Total PPSD (dBm) = $10 * \text{LOG}(10^{\text{Chain 0 PPSD} / 10} + 10^{\text{Chain 1 PPSD} / 10})$



Test Plot

IEEE 802.11b mode

PPSD (CH Low)

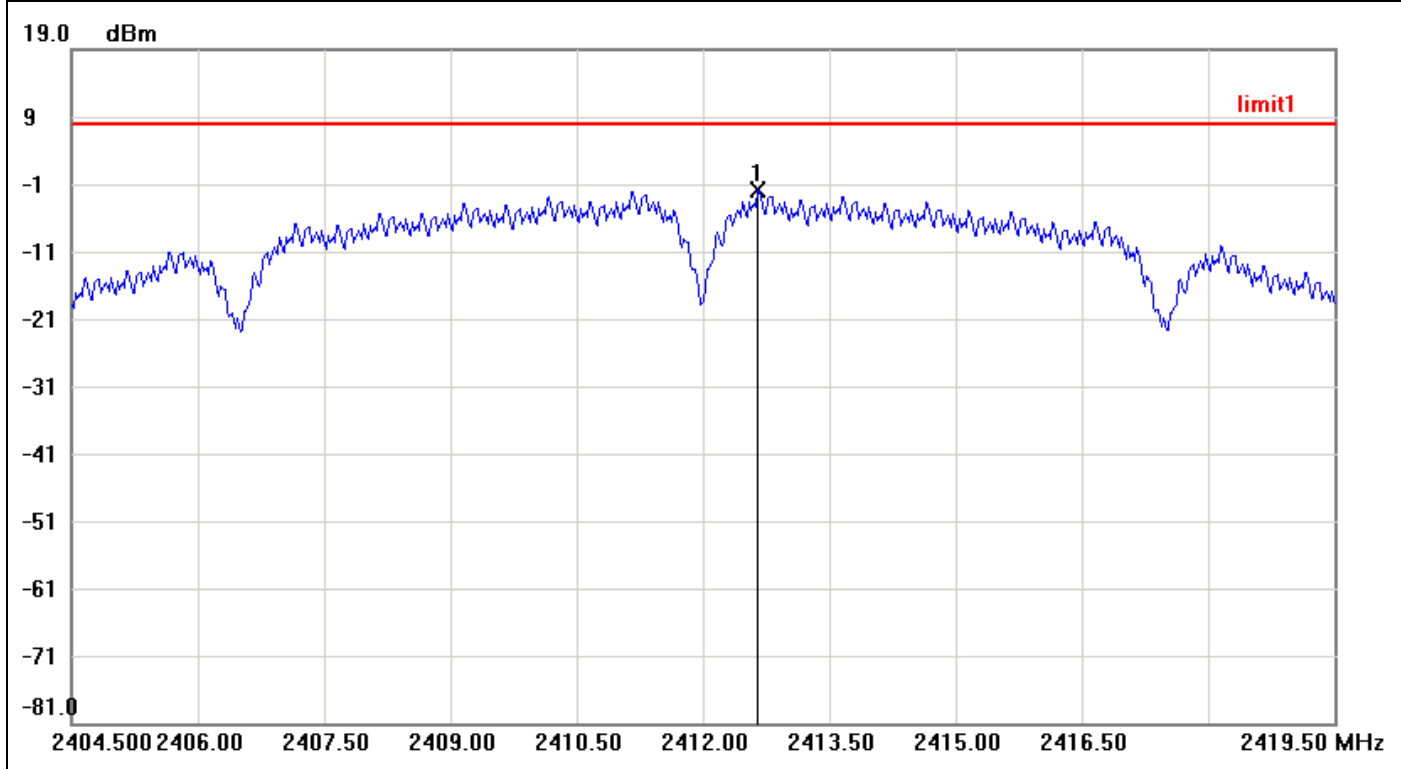

No.	Frequency(MHz)	Result(dBm)	Limit(dBm)	Margin(dBm)
1	2412.6500	-1.87	8.00	-9.87



PPSD (CH Mid)

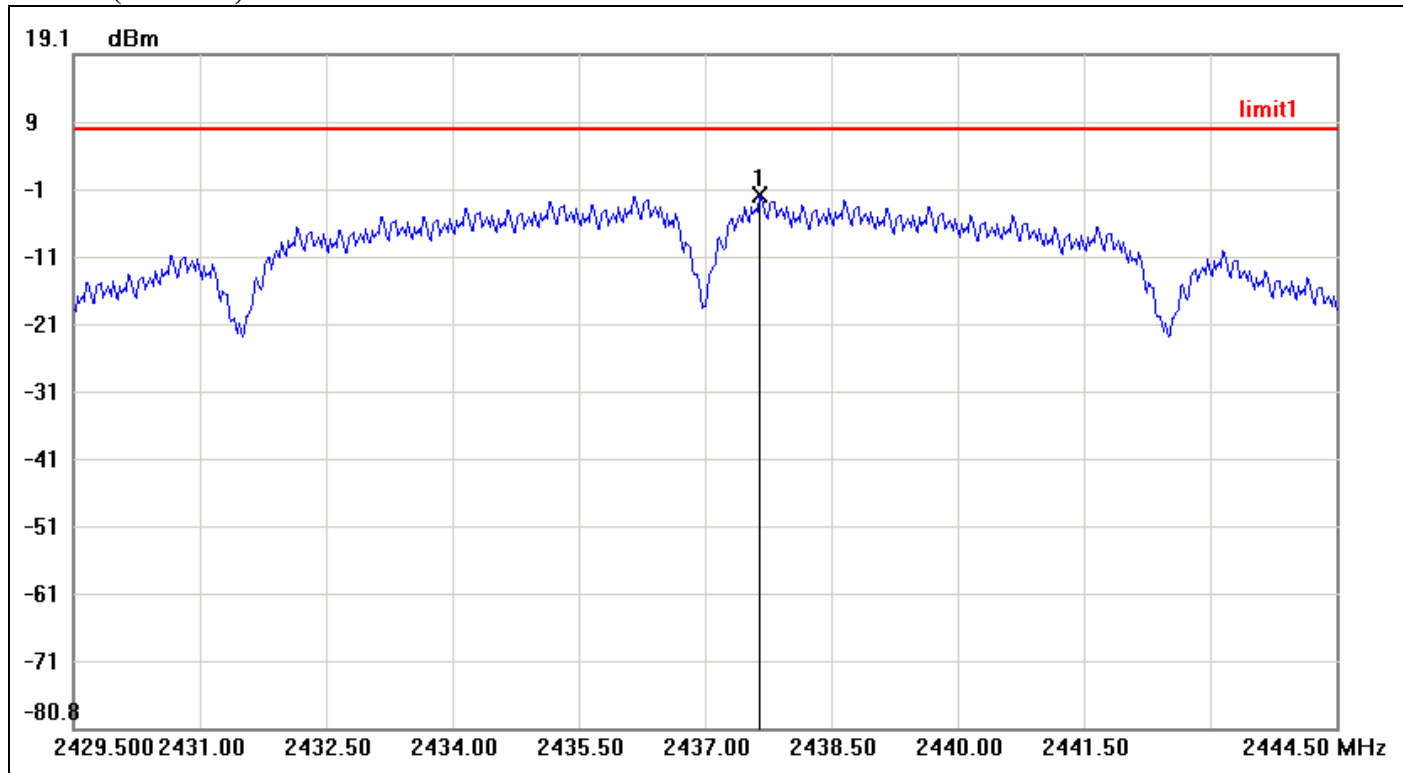

No.	Frequency(MHz)	Result(dBm)	Limit(dBm)	Margin(dBm)
1	2437.6500	-1.77	8.00	-9.77



PPSD (CH High)

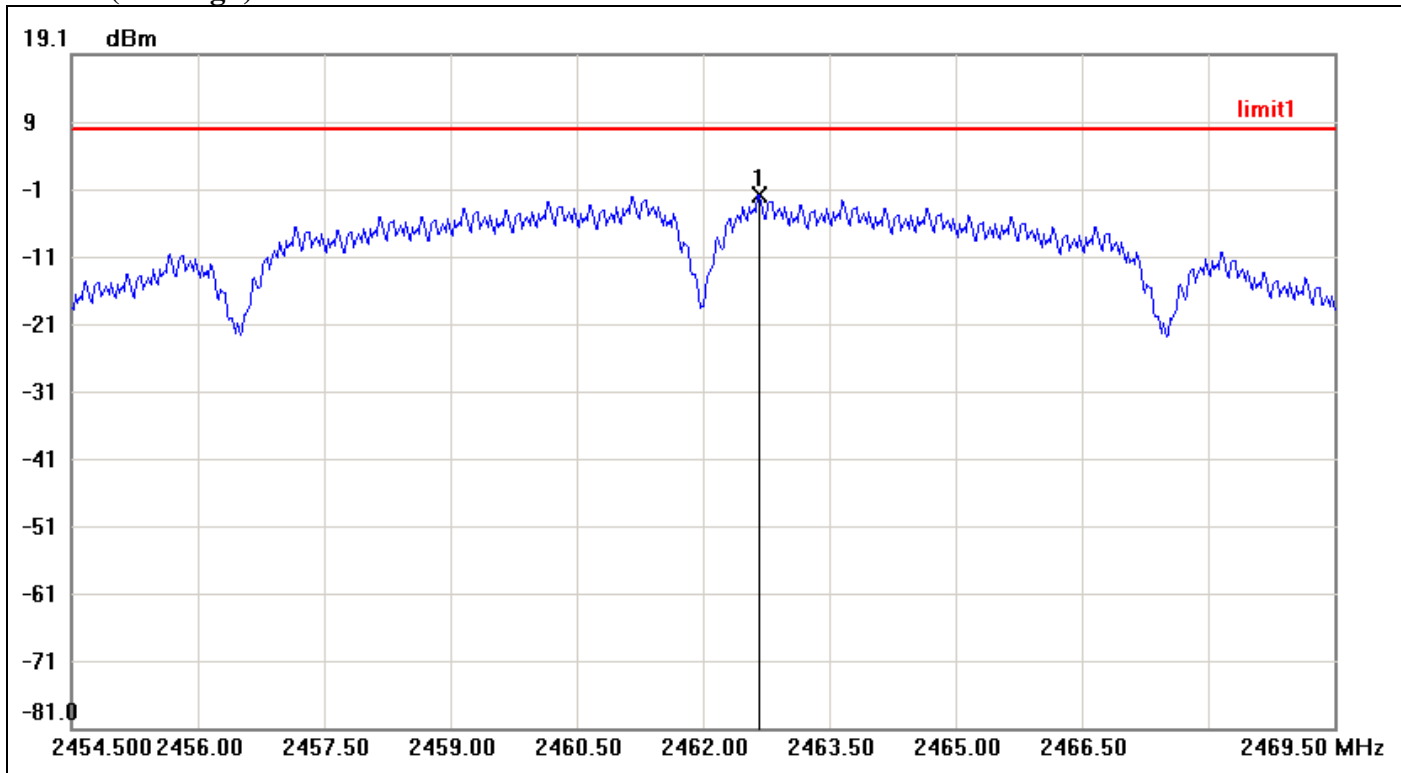

No.	Frequency(MHz)	Result(dBm)	Limit(dBm)	Margin(dBm)
1	2462.6750	-1.87	8.00	-9.87



IEEE 802.11g mode

PPSD (CH Low)

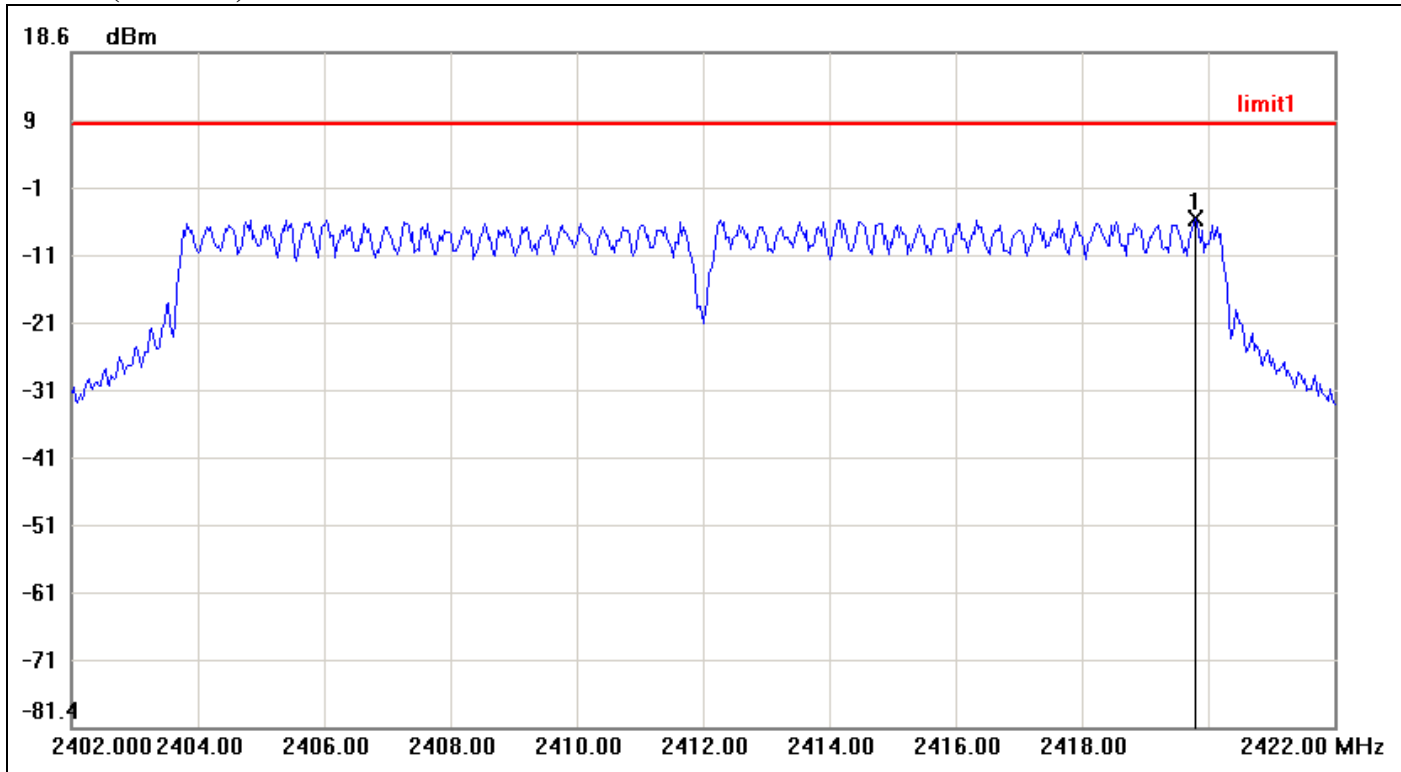

No.	Frequency(MHz)	Result(dBm)	Limit(dBm)	Margin(dBm)
1	2419.8000	-6.10	8.00	-14.10



PPSD (CH Mid)

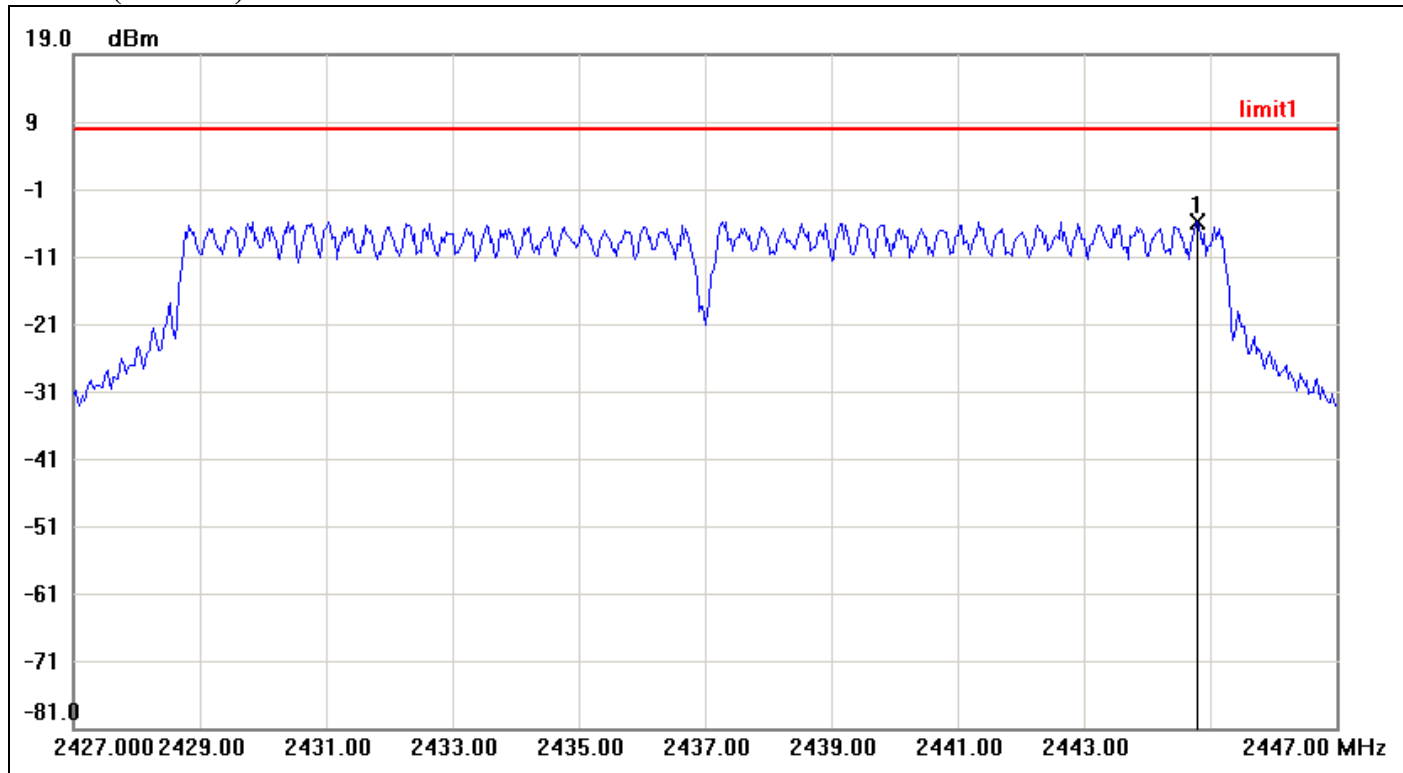

No.	Frequency(MHz)	Result(dBm)	Limit(dBm)	Margin(dBm)
1	2444.8000	-5.81	8.00	-13.81



PPSD (CH High)

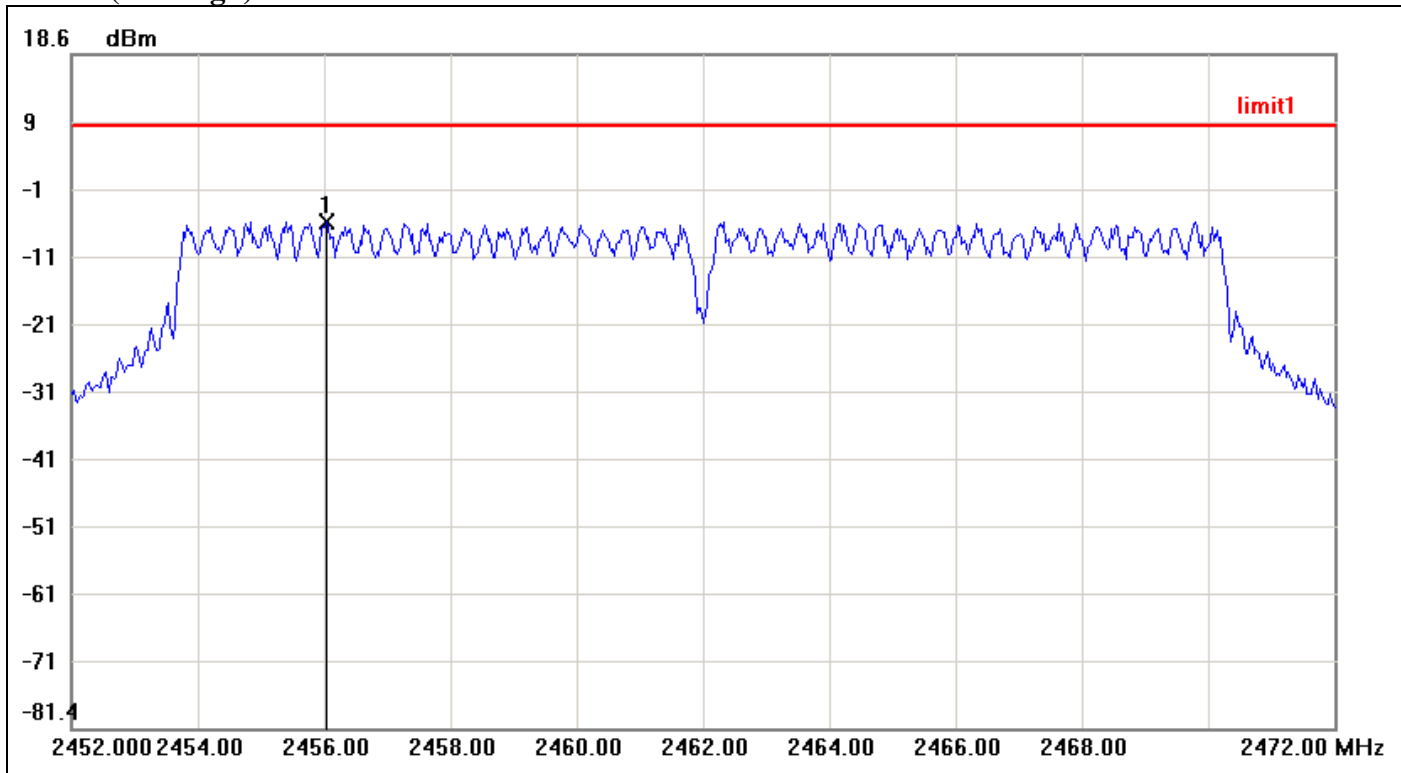

No.	Frequency(MHz)	Result(dBm)	Limit(dBm)	Margin(dBm)
1	2456.0333	-6.26	8.00	-14.26



IEEE 802.11n HT 20 mode / Chain 0

PPSD (CH Low)

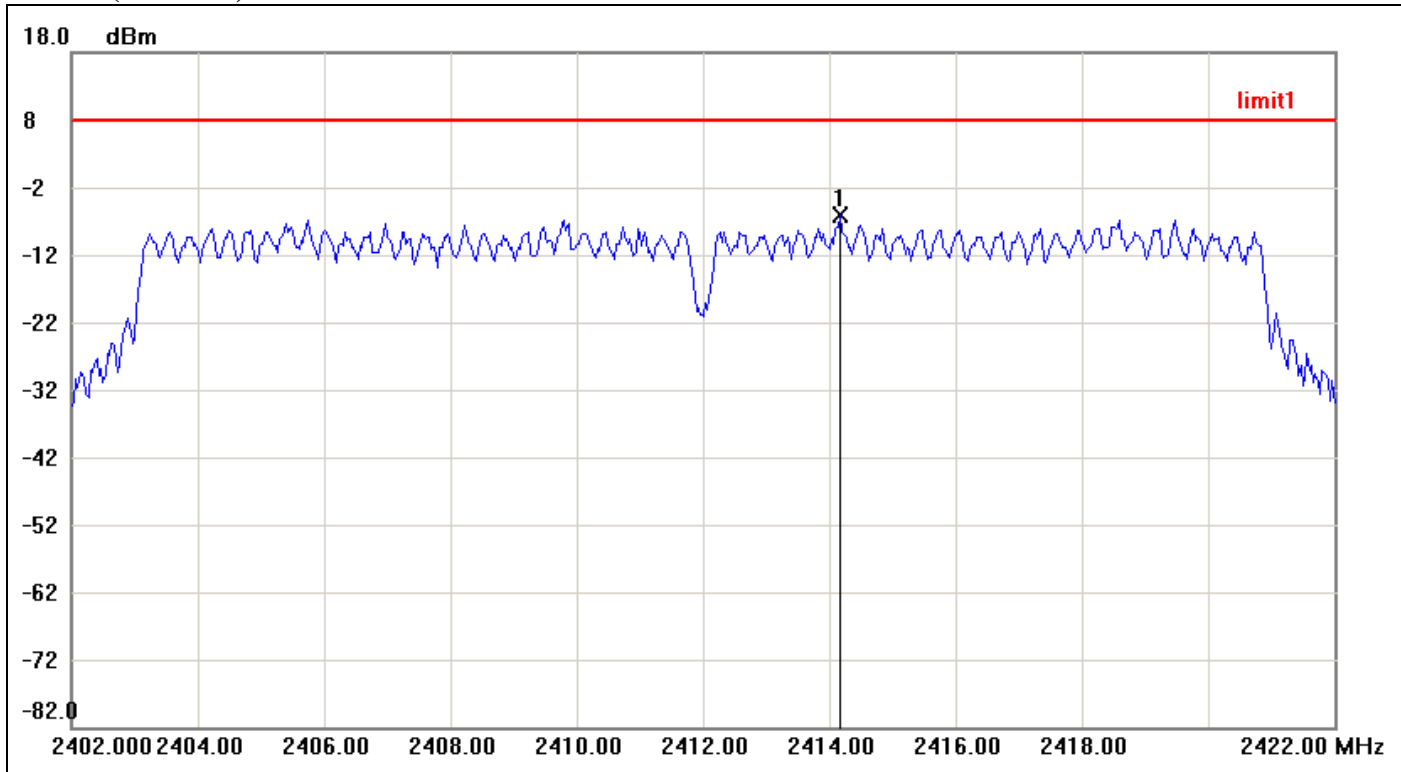

No.	Frequency(MHz)	Result(dBm)	Limit(dBm)	Margin(dBm)
1	2414.1667	-6.20	8.00	-14.20



PPSD (CH Mid)

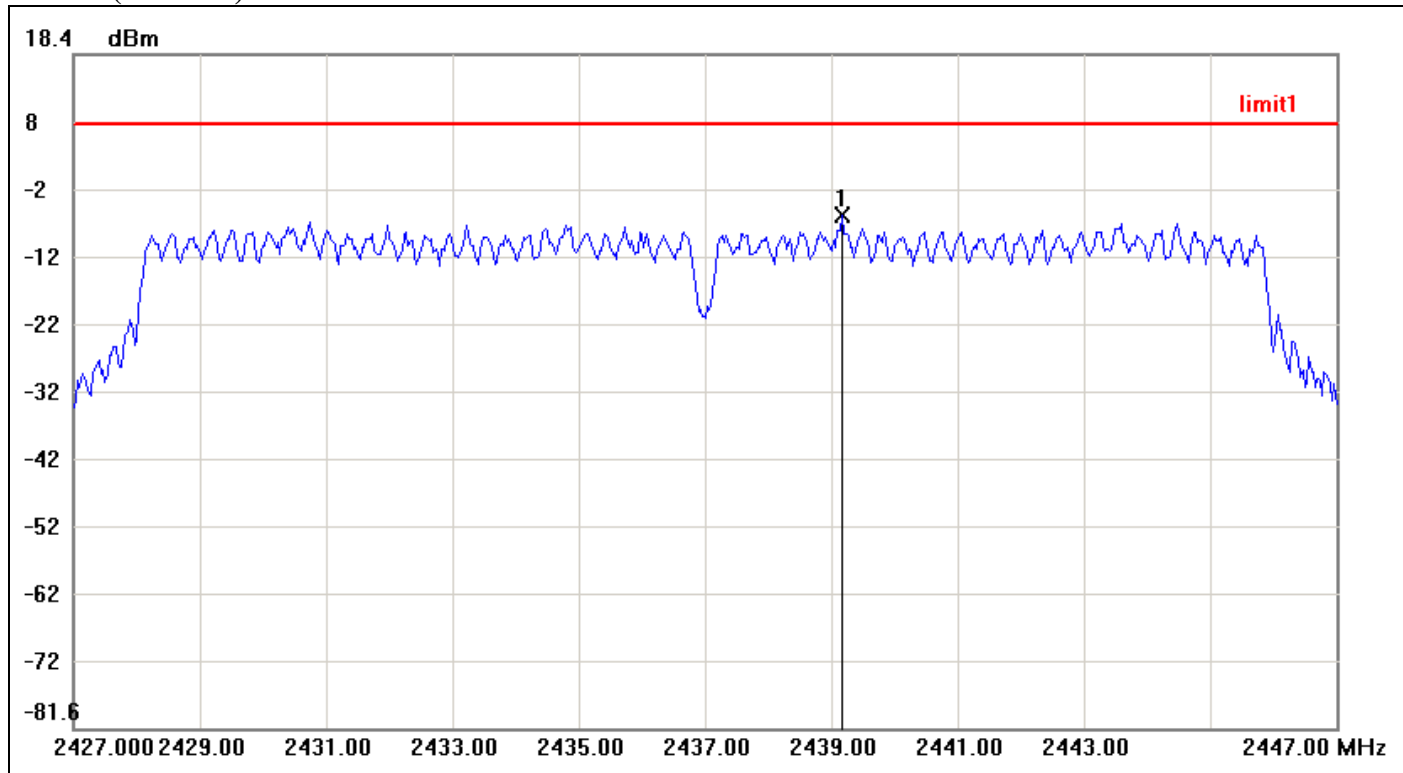

No.	Frequency(MHz)	Result(dBm)	Limit(dBm)	Margin(dBm)
1	2439.1667	-5.57	8.00	-13.57



PPSD (CH High)

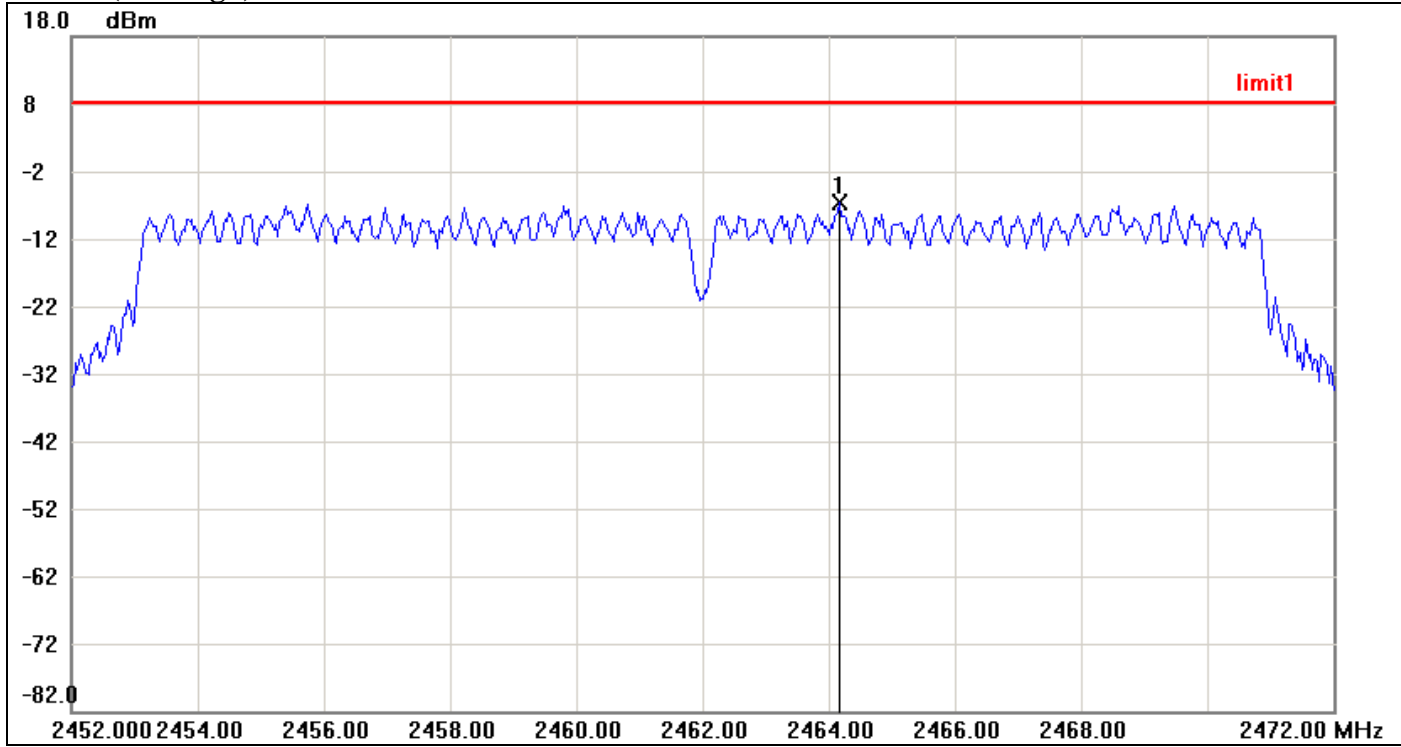

No.	Frequency(MHz)	Result(dBm)	Limit(dBm)	Margin(dBm)
1	2464.1667	-6.74	8.00	-14.74



IEEE 802.11n HT 20 mode / Chain 1

PPSD (CH Low)

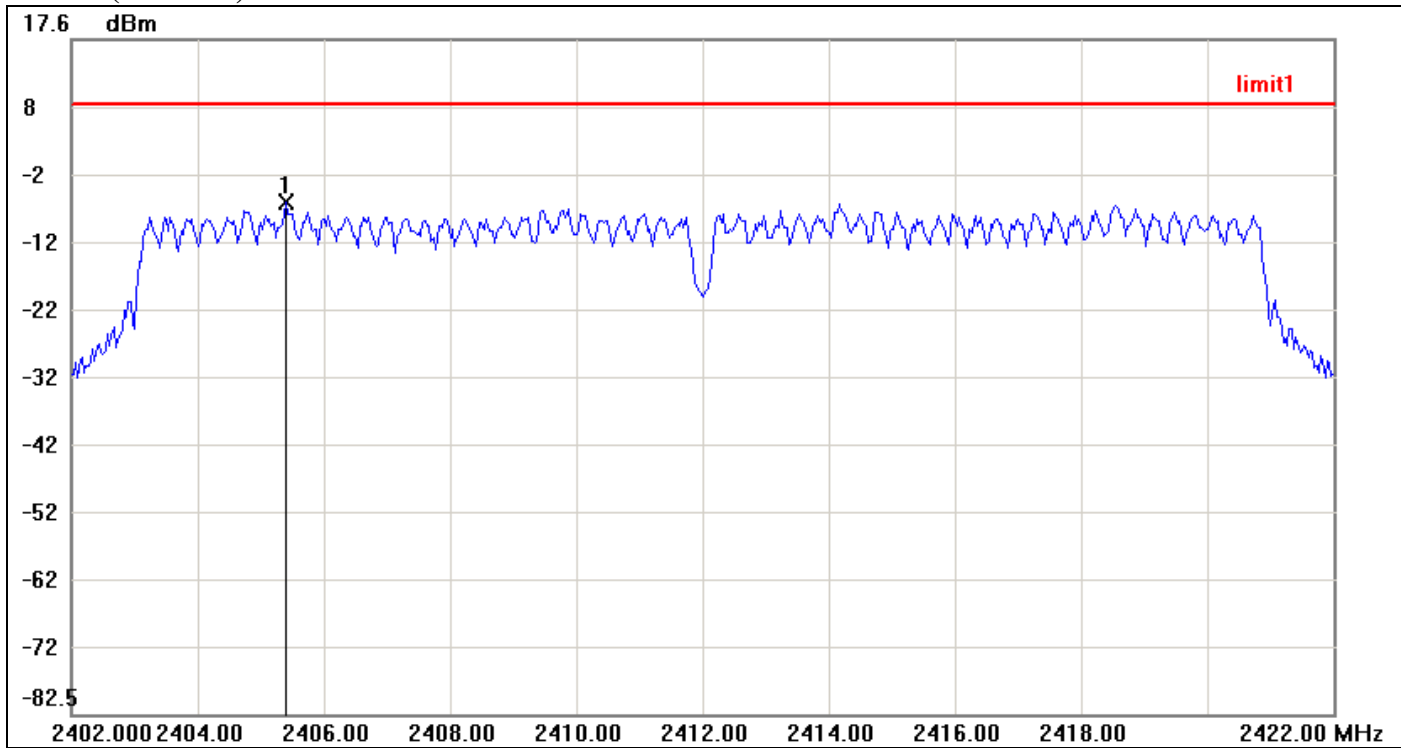

No.	Frequency(MHz)	Result(dBm)	Limit(dBm)	Margin(dBm)
1	2405.4000	-6.65	8.00	-14.65



PPSD (CH Mid)

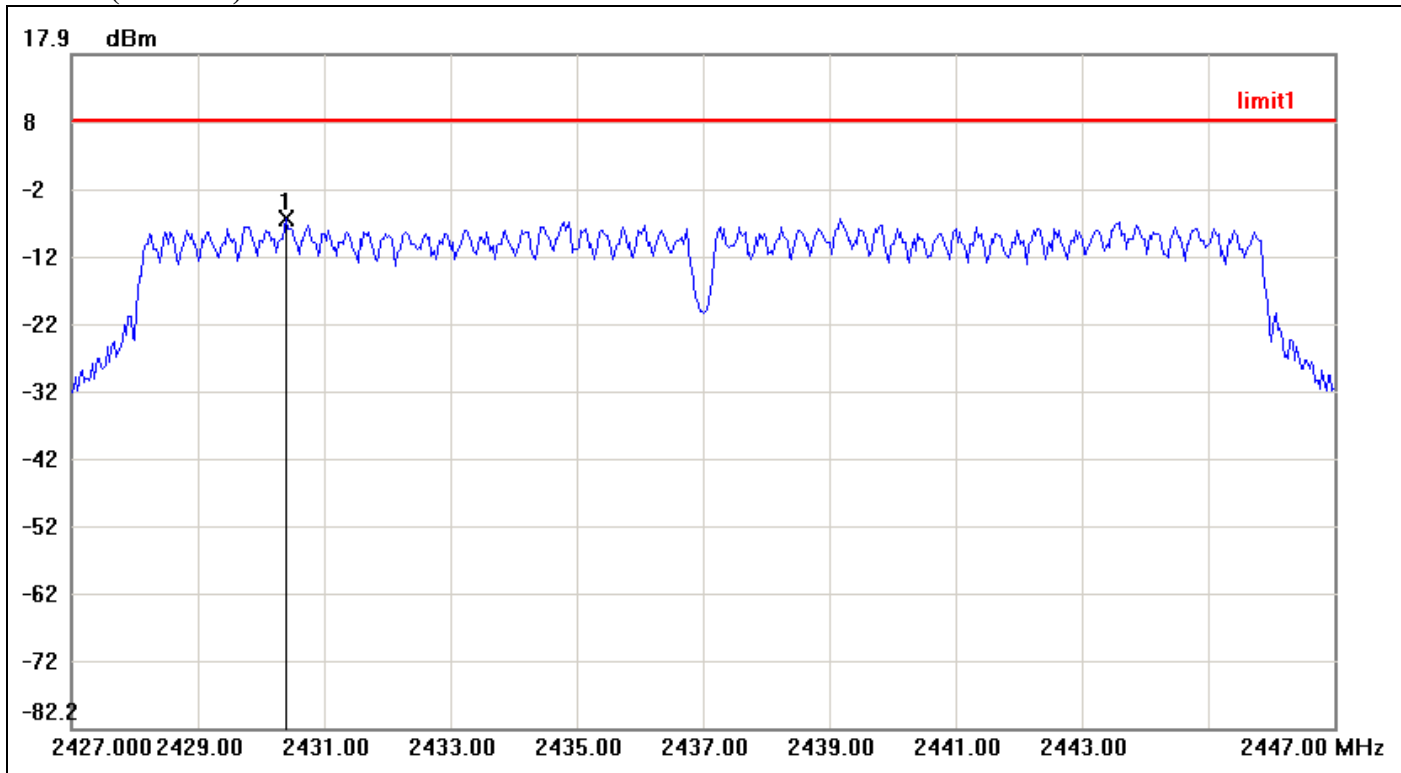

No.	Frequency(MHz)	Result(dBm)	Limit(dBm)	Margin(dBm)
1	2430.4000	-6.44	8.00	-14.44



PPSD (CH High)

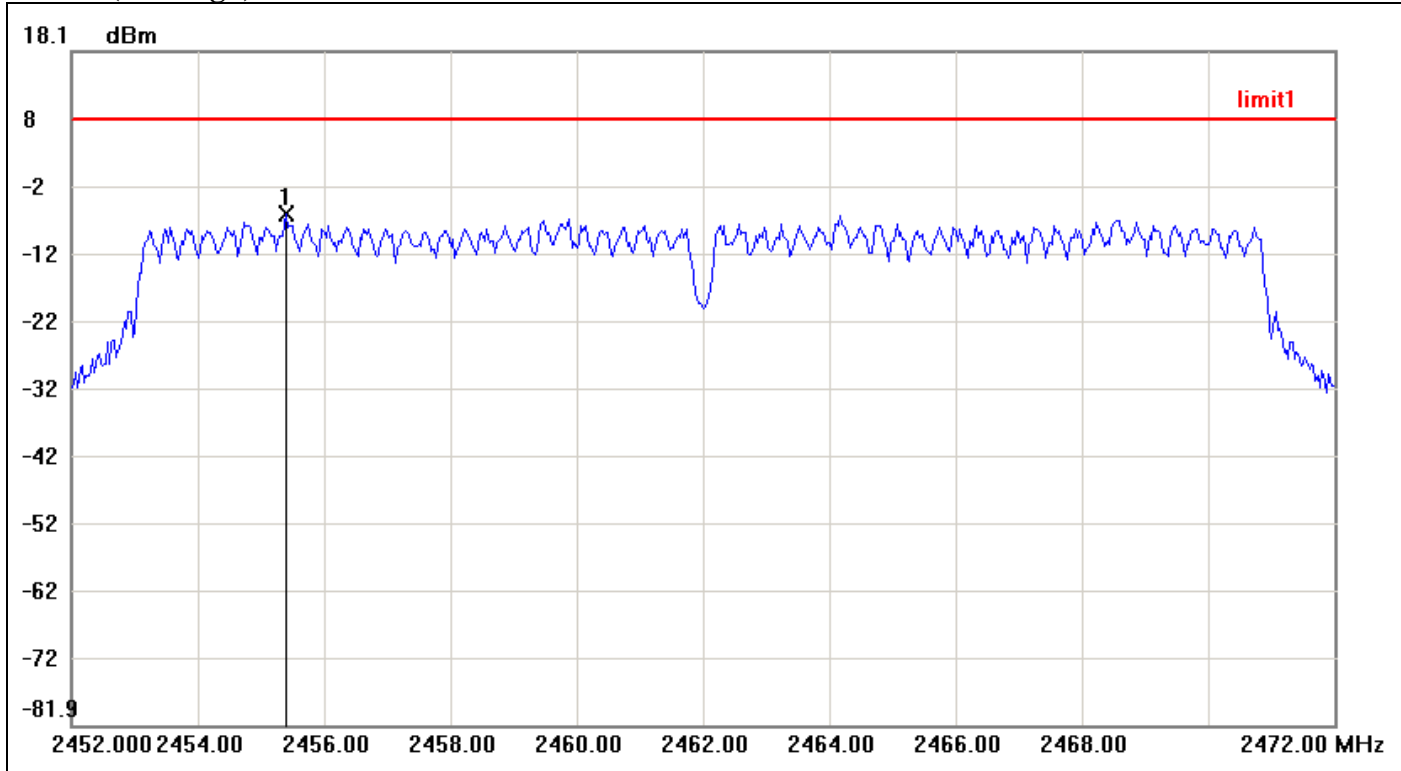

No.	Frequency(MHz)	Result(dBm)	Limit(dBm)	Margin(dBm)
1	2455.4000	-6.08	8.00	-14.08



IEEE 802.11n HT 40 mode / Chain 0

PPSD (CH Low)

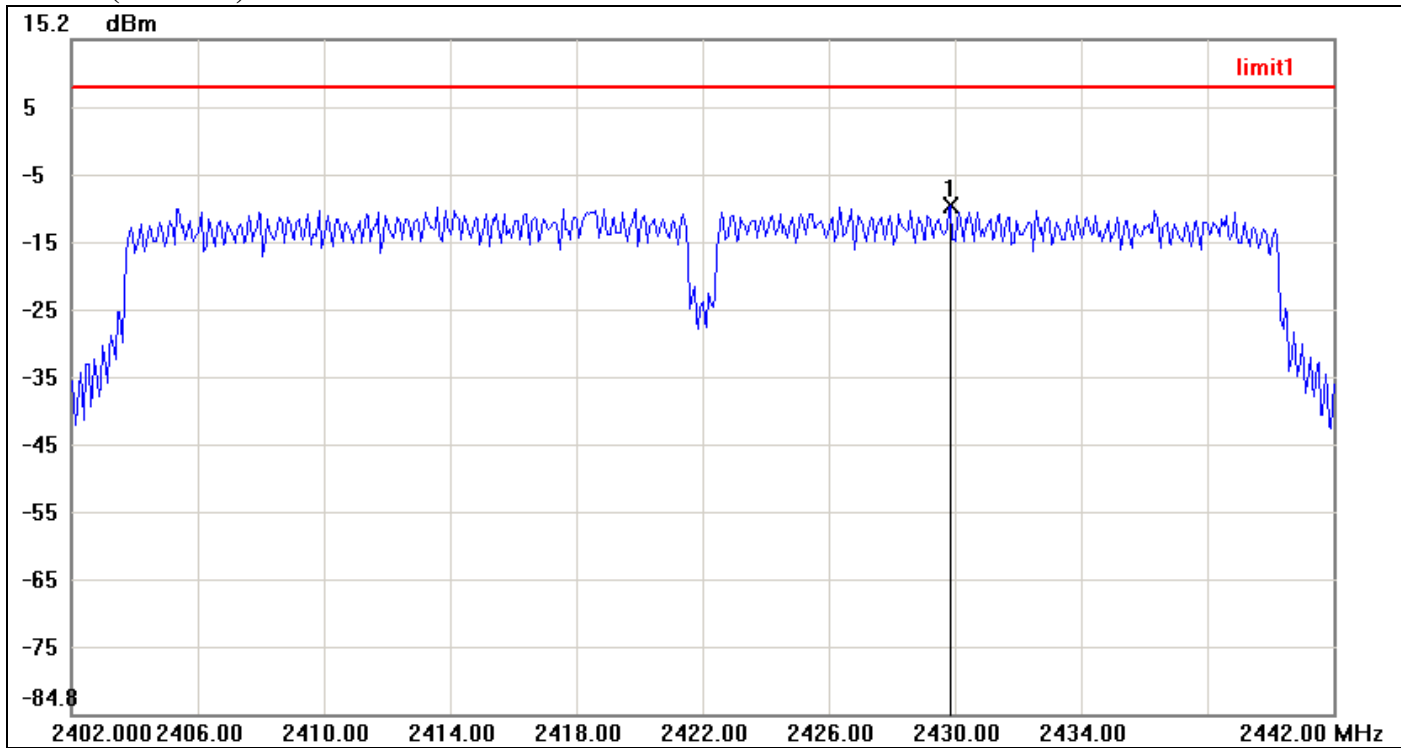

No.	Frequency(MHz)	Result(dBm)	Limit(dBm)	Margin(dBm)
1	2429.8667	-9.33	8.00	-17.33



PPSD (CH Mid)

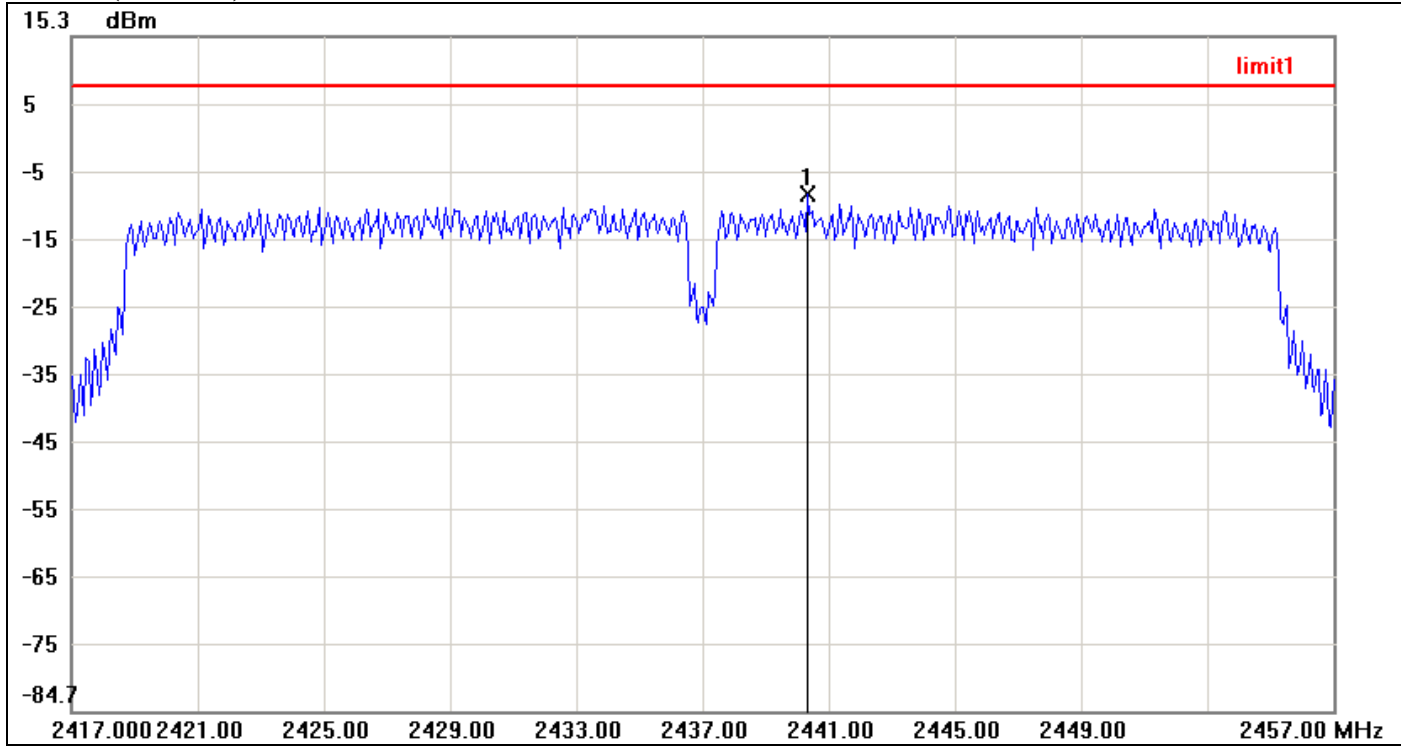

No.	Frequency(MHz)	Result(dBm)	Limit(dBm)	Margin(dBm)
1	2440.3333	-7.94	8.00	-15.94



PPSD (CH High)

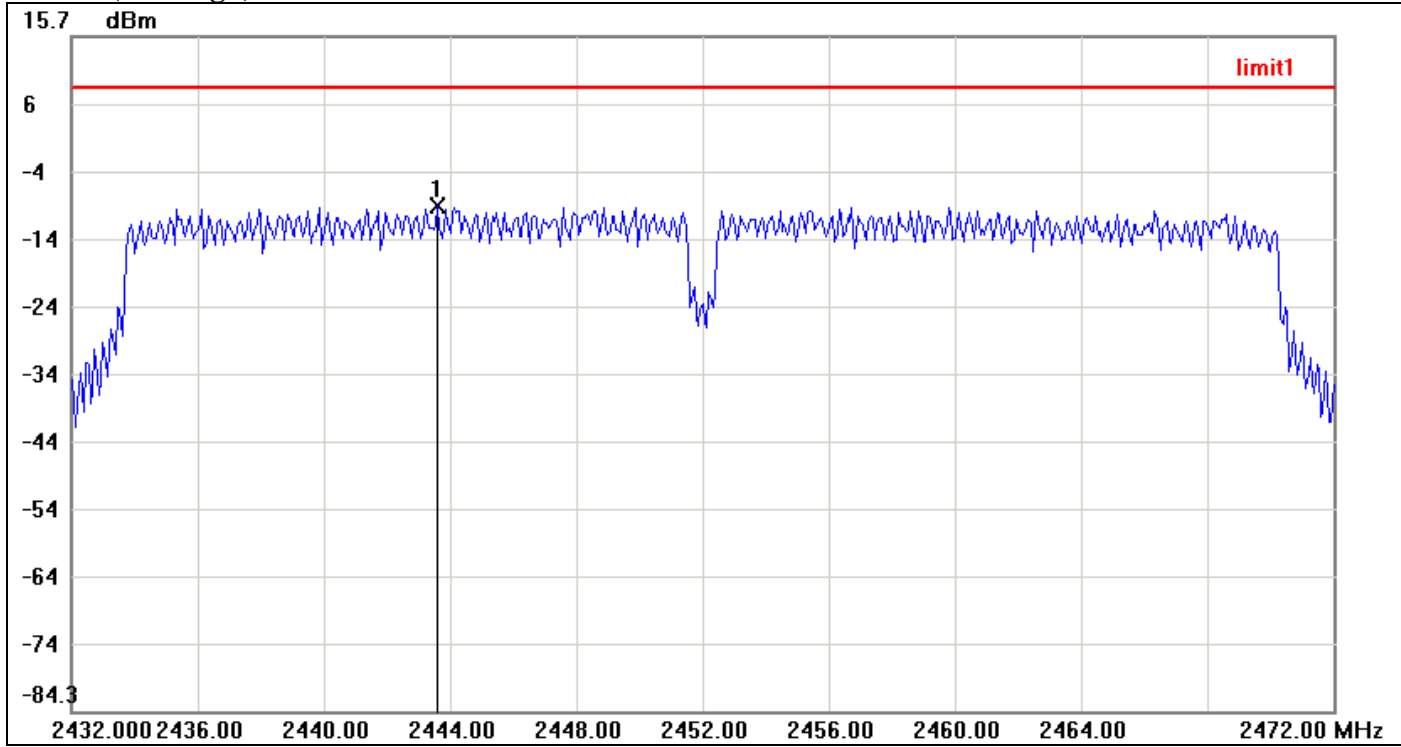

No.	Frequency(MHz)	Result(dBm)	Limit(dBm)	Margin(dBm)
1	2443.6000	-9.49	8.00	-17.49



IEEE 802.11n HT 40 mode / Chain 1

PPSD (CH Low)

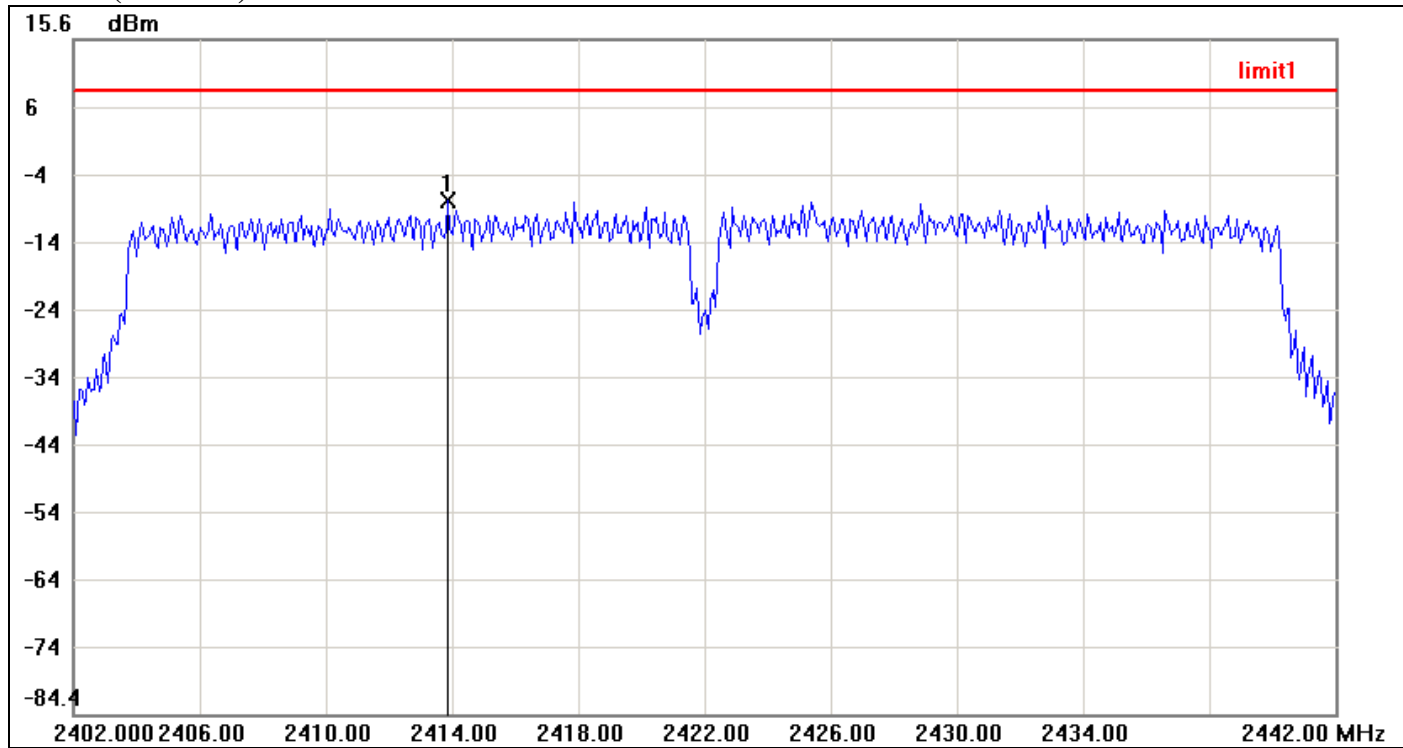

No.	Frequency(MHz)	Result(dBm)	Limit(dBm)	Margin(dBm)
1	2413.8667	-8.41	8.00	-16.41



PPSD (CH Mid)

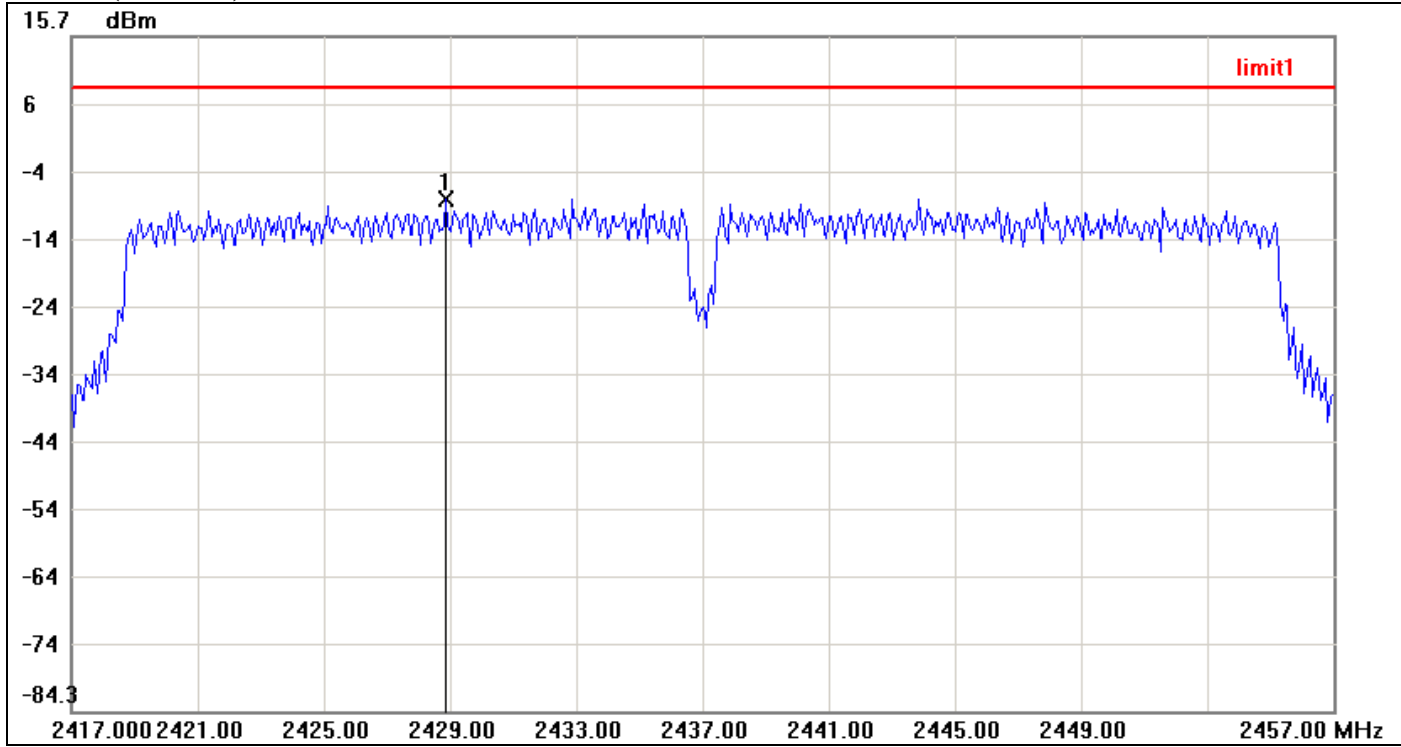

No.	Frequency(MHz)	Result(dBm)	Limit(dBm)	Margin(dBm)
1	2428.8667	-8.32	8.00	-16.32



PPSD (CH High)

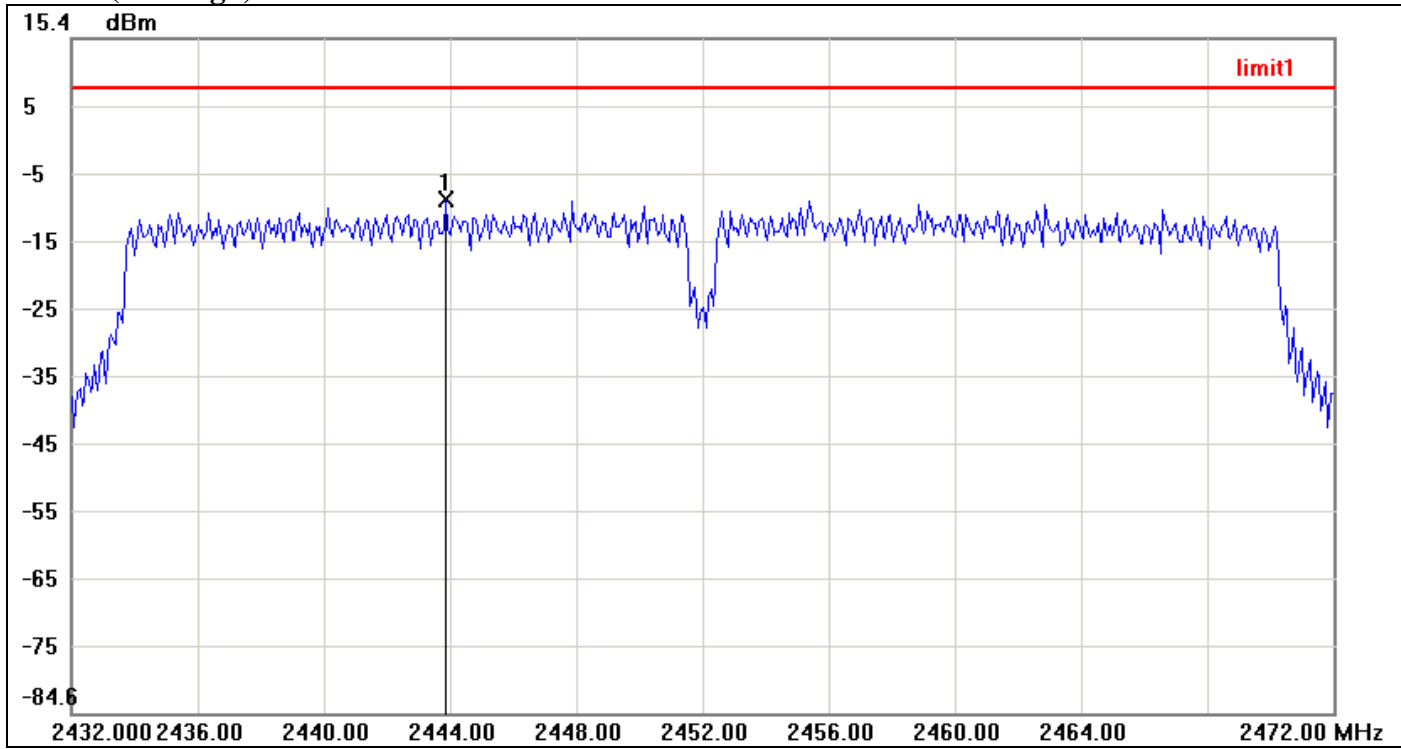

No.	Frequency(MHz)	Result(dBm)	Limit(dBm)	Margin(dBm)
1	2443.8667	-8.63	8.00	-16.63



7.6 SPURIOUS EMISSIONS

Conducted Measurement

LIMIT

According to §15.247(d), in any 100 kHz bandwidth outside the frequency bands in which the spread spectrum intentional radiator is operating, the radio frequency power that is produced by the intentional radiator shall be at least 20 dB below that in the 100 kHz bandwidth within the band that contains the highest level of the desired power, based on either an RF conducted or a radiated measurement, provided the transmitter demonstrates compliance with the peak conducted power limits. In addition, radiated emissions which fall in the restricted bands, as defined in §15.205(a), must also comply with the radiated emission limits specified in 15.209(a) (see Section 15.205(c)).

Test Configuration

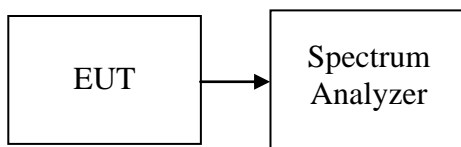

TEST PROCEDURE

The transmitter output is connected to a spectrum analyzer. Set the RBW=100 kHz and VBW= 300 kHz. Investigate the frequency from 30 MHz to 26 GHz with L, M and H channels separately.

TEST RESULTS

No non-compliance noted.



Test Plot

IEEE 802.11b mode

CH Low

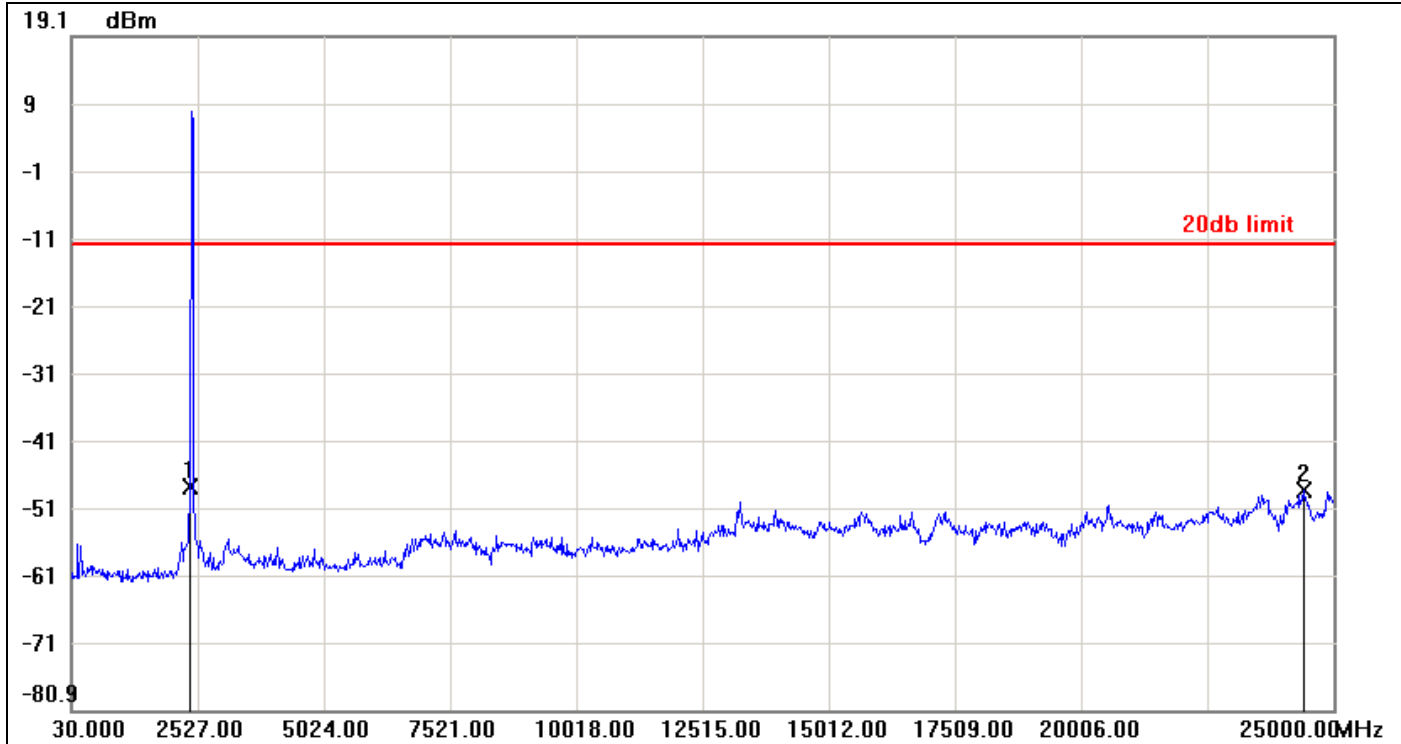

No.	Frequency(MHz)	Result(dBm)	Limit(dBm)	Margin(dBm)
1	2377.1800	-47.83	-11.70	-36.13
2	24400.7200	-48.30	-11.70	-36.60



CH Mid

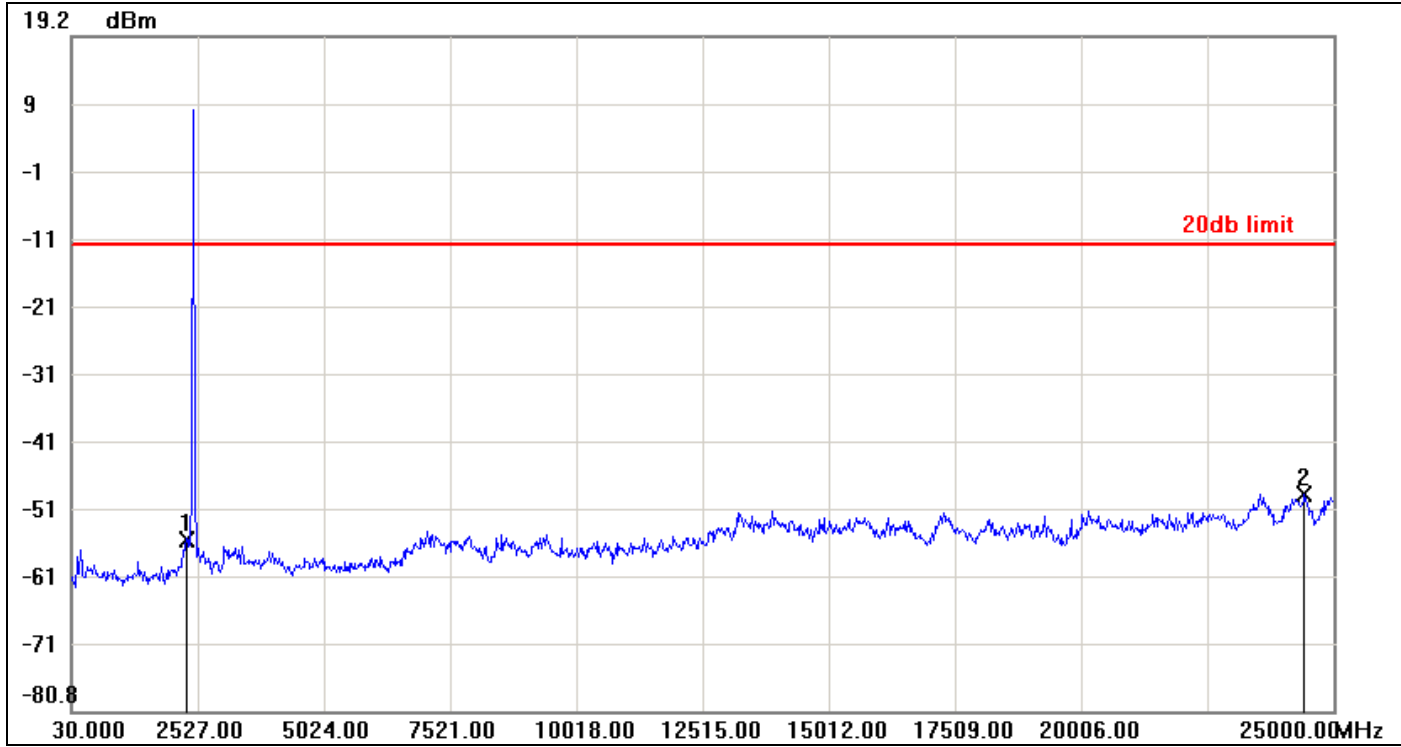

No.	Frequency(MHz)	Result(dBm)	Limit(dBm)	Margin(dBm)
1	2302.2700	-55.32	-11.58	-43.74
2	24425.6900	-48.60	-11.58	-37.02



CH High

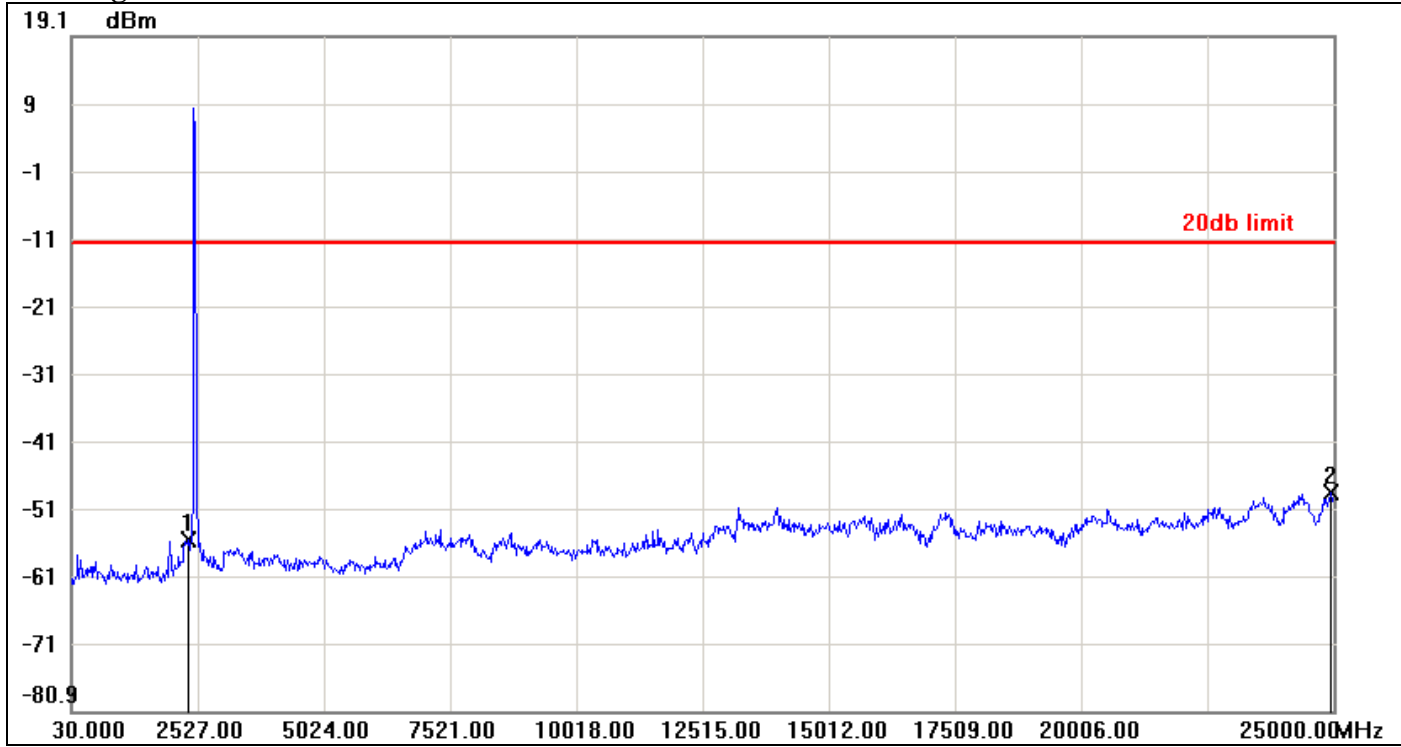

No.	Frequency(MHz)	Result(dBm)	Limit(dBm)	Margin(dBm)
1	2352.2100	-55.48	-11.67	-43.81
2	24950.0600	-48.52	-11.67	-36.85



IEEE 802.11g mode

CH Low



No.	Frequency(MHz)	Result(dBm)	Limit(dBm)	Margin(dBm)
1	2377.1800	-46.11	-18.34	-27.77
2	24975.0300	-47.39	-18.34	-29.05



CH Mid

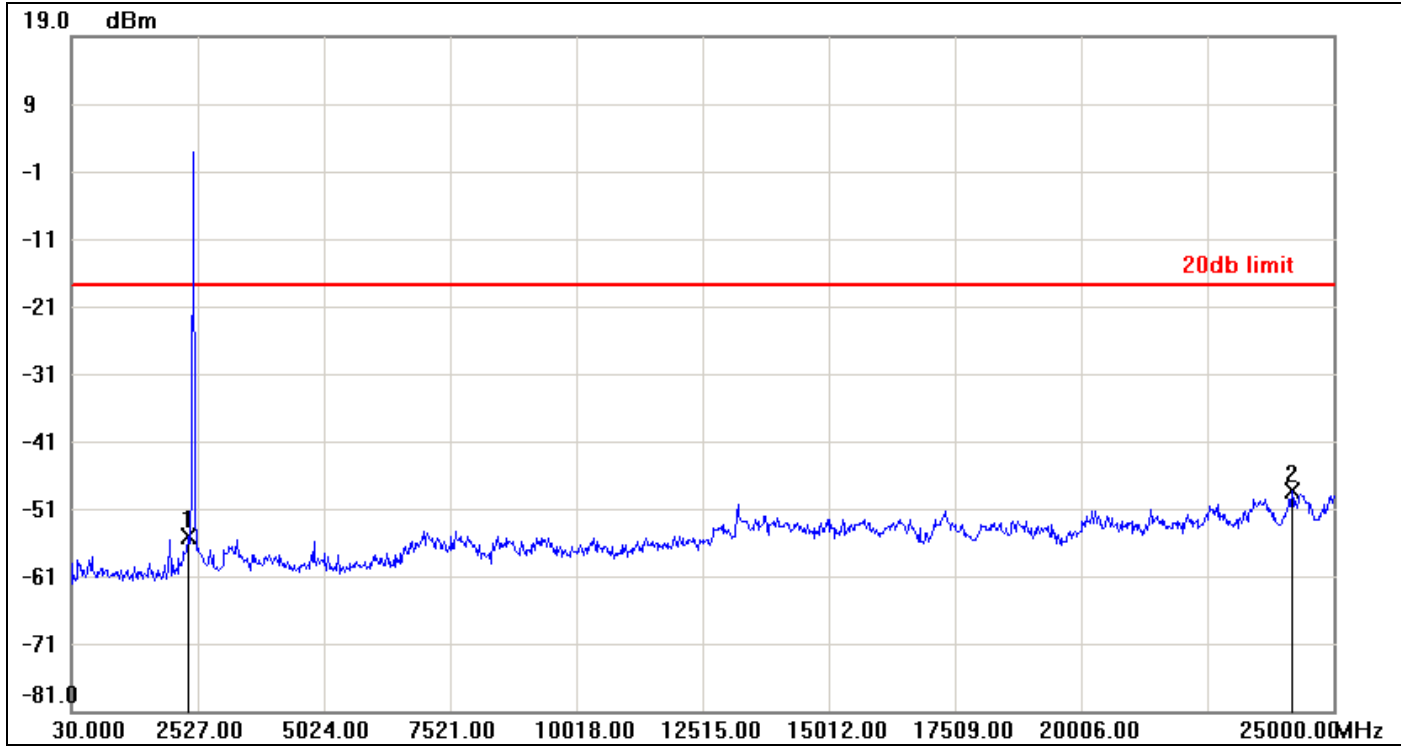

No.	Frequency(MHz)	Result(dBm)	Limit(dBm)	Margin(dBm)
1	2327.2400	-55.09	-17.91	-37.18
2	24175.9900	-48.32	-17.91	-30.41



CH High

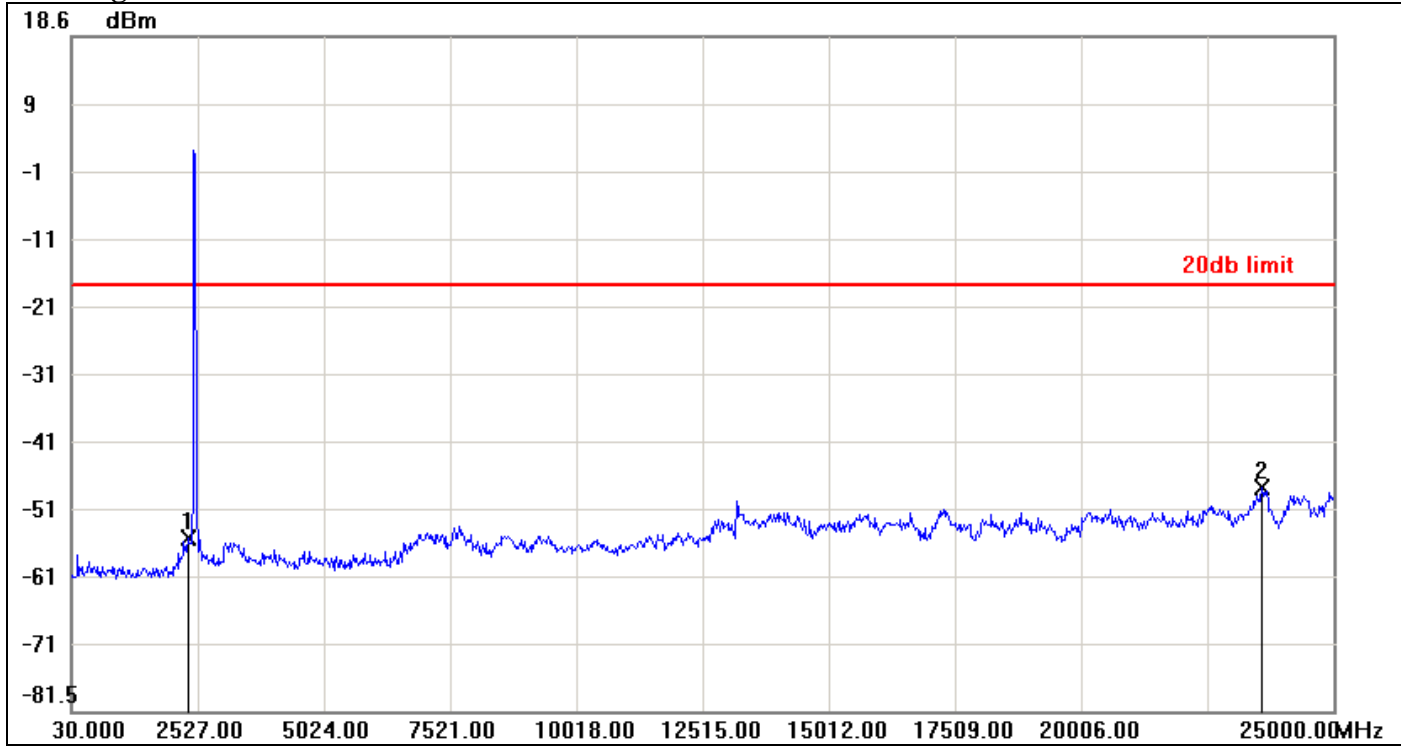

No.	Frequency(MHz)	Result(dBm)	Limit(dBm)	Margin(dBm)
1	2327.2400	-55.82	-18.32	-37.50
2	23576.7100	-48.32	-18.32	-30.00



IEEE 802.11n HT 20 mode / Chain 0

CH Low



No.	Frequency(MHz)	Result(dBm)	Limit(dBm)	Margin(dBm)
1	2377.1800	-47.34	-19.23	-28.11
2	24450.6600	-48.74	-19.23	-29.51



CH Mid

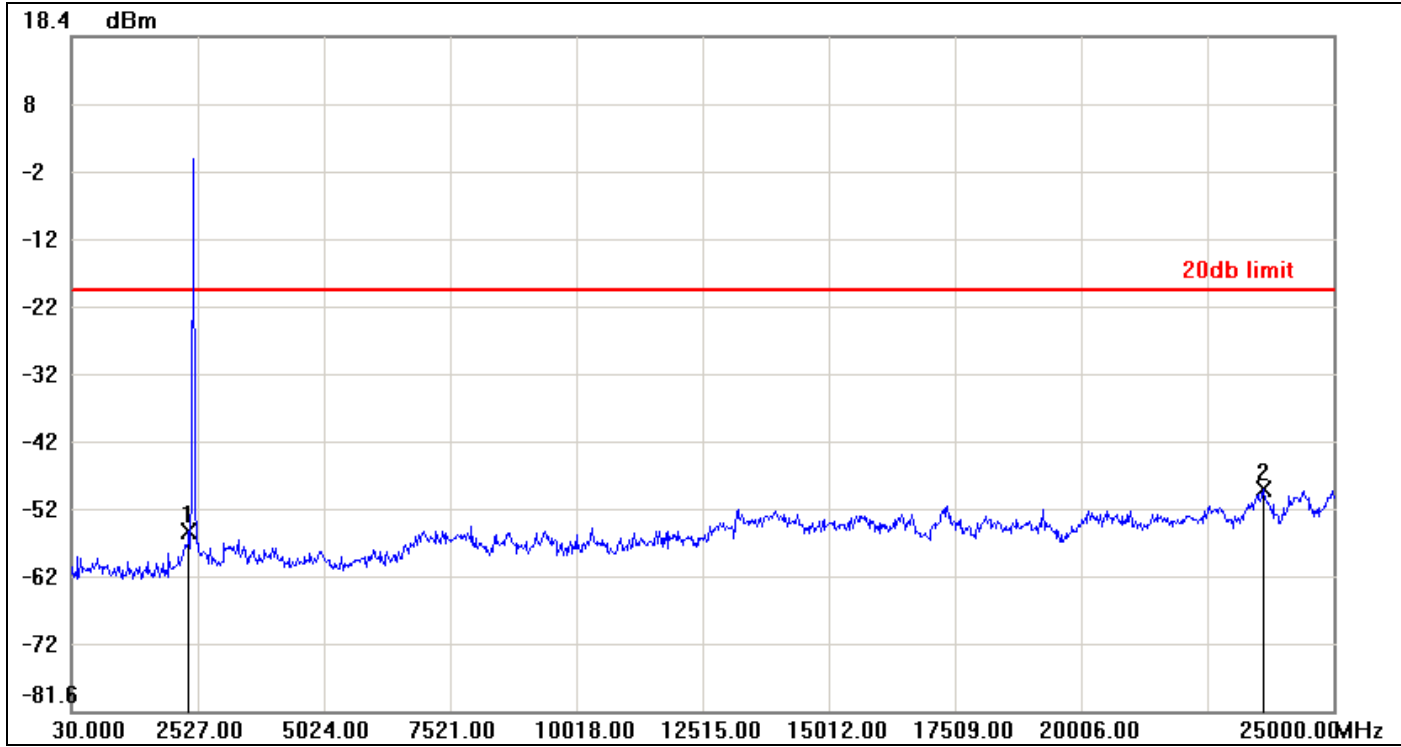

No.	Frequency(MHz)	Result(dBm)	Limit(dBm)	Margin(dBm)
1	2352.2100	-54.91	-19.18	-35.73
2	23601.6800	-48.76	-19.18	-29.58



CH High

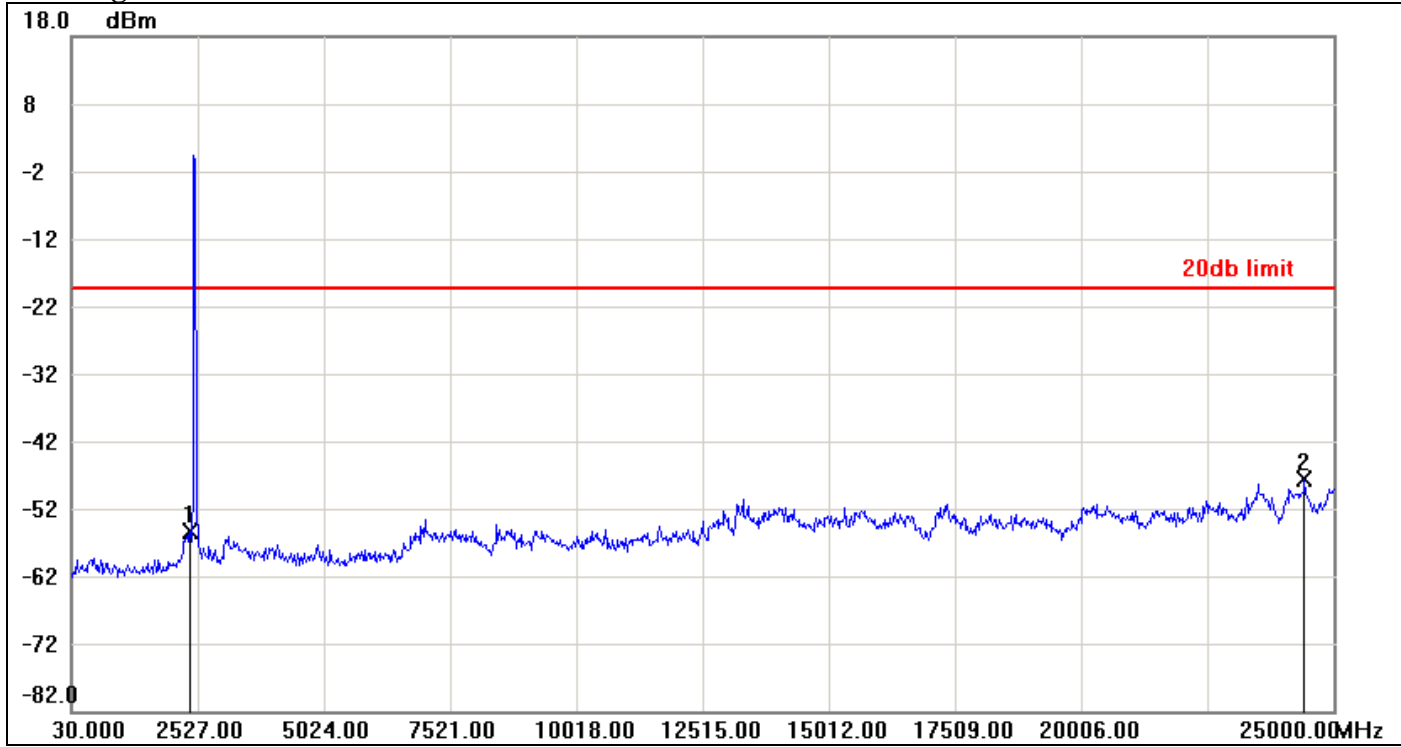

No.	Frequency(MHz)	Result(dBm)	Limit(dBm)	Margin(dBm)
1	2377.1800	-55.50	-19.34	-36.16
2	24425.6900	-47.67	-19.34	-28.33



IEEE 802.11n HT 20 mode / Chain 1

CH Low

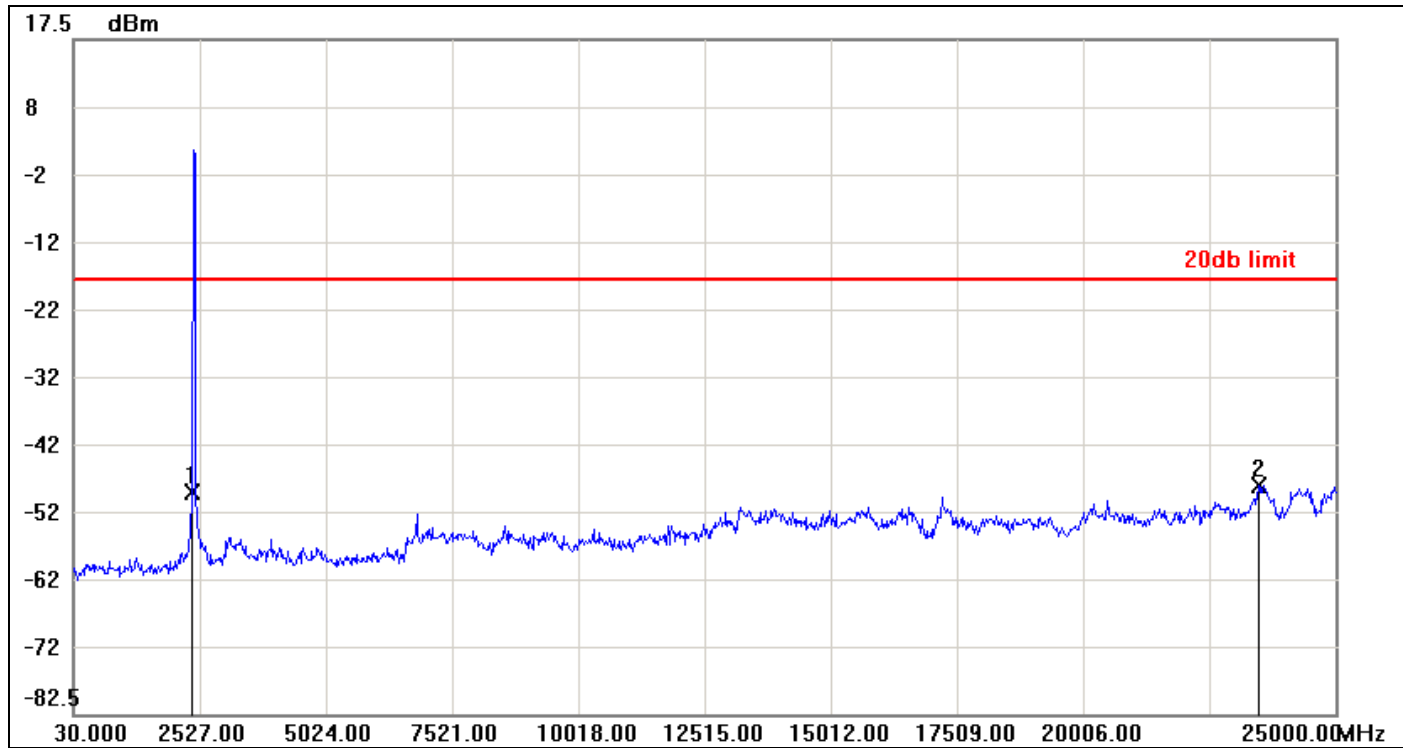

No.	Frequency(MHz)	Result(dBm)	Limit(dBm)	Margin(dBm)
1	2377.1800	-49.55	-18.08	-31.47
2	23476.8300	-48.63	-18.08	-30.55



CH Mid



No.	Frequency(MHz)	Result(dBm)	Limit(dBm)	Margin(dBm)
1	2352.2100	-55.81	-18.25	-37.56
2	25000.0000	-48.70	-18.25	-30.45



CH High

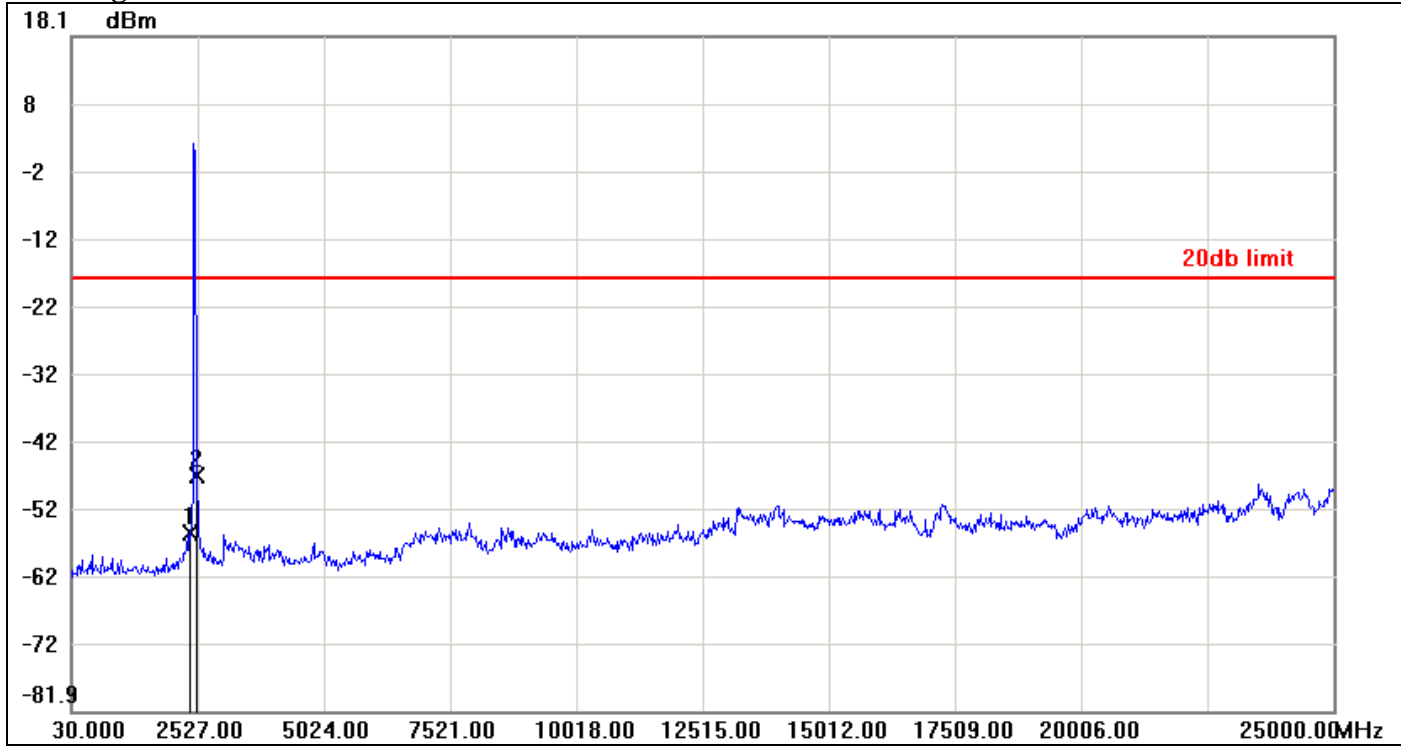

No.	Frequency(MHz)	Result(dBm)	Limit(dBm)	Margin(dBm)
1	2377.1800	-55.47	-17.69	-37.78
2	2502.0300	-47.14	-17.69	-29.45



IEEE 802.11n HT 40 mode / Chain 0

CH Low

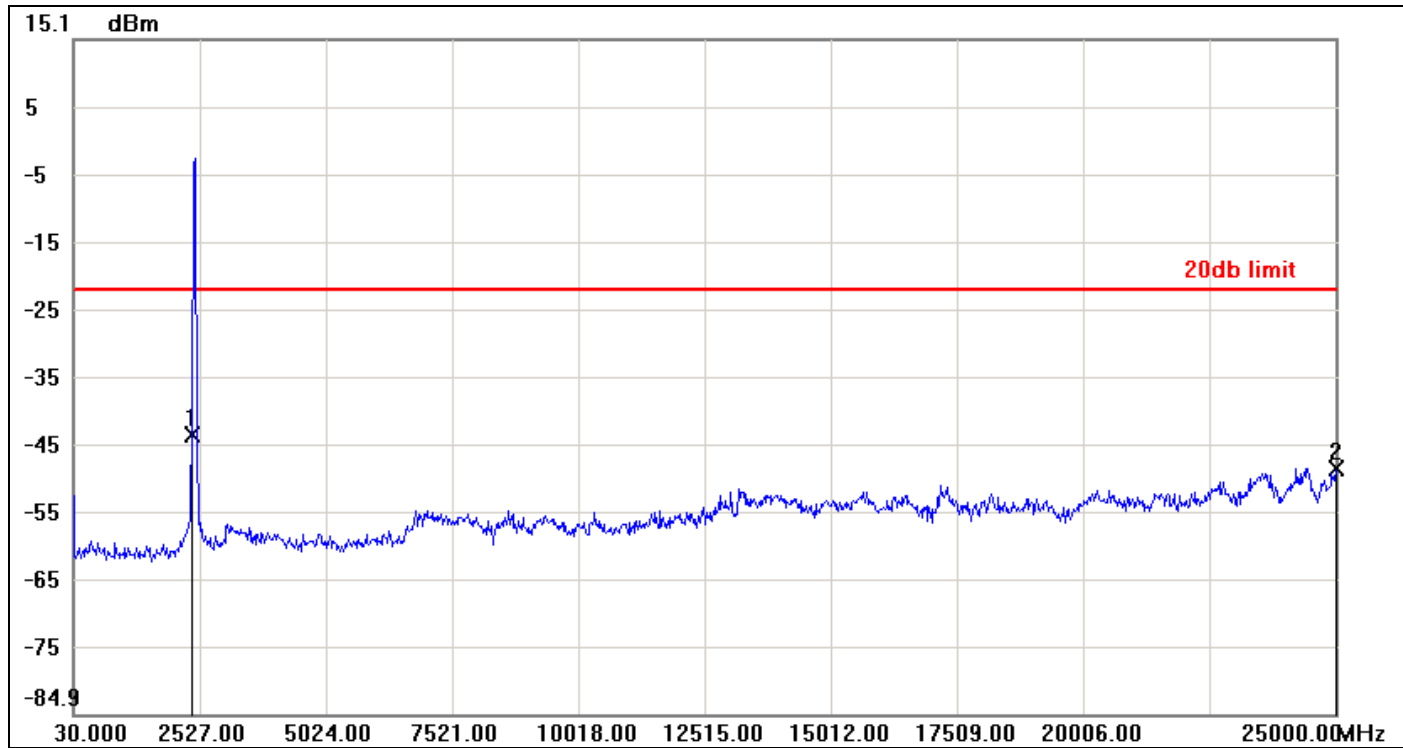

No.	Frequency(MHz)	Result(dBm)	Limit(dBm)	Margin(dBm)
1	2377.1800	-43.43	-21.98	-21.45
2	25000.0000	-48.47	-21.98	-26.49



CH Mid

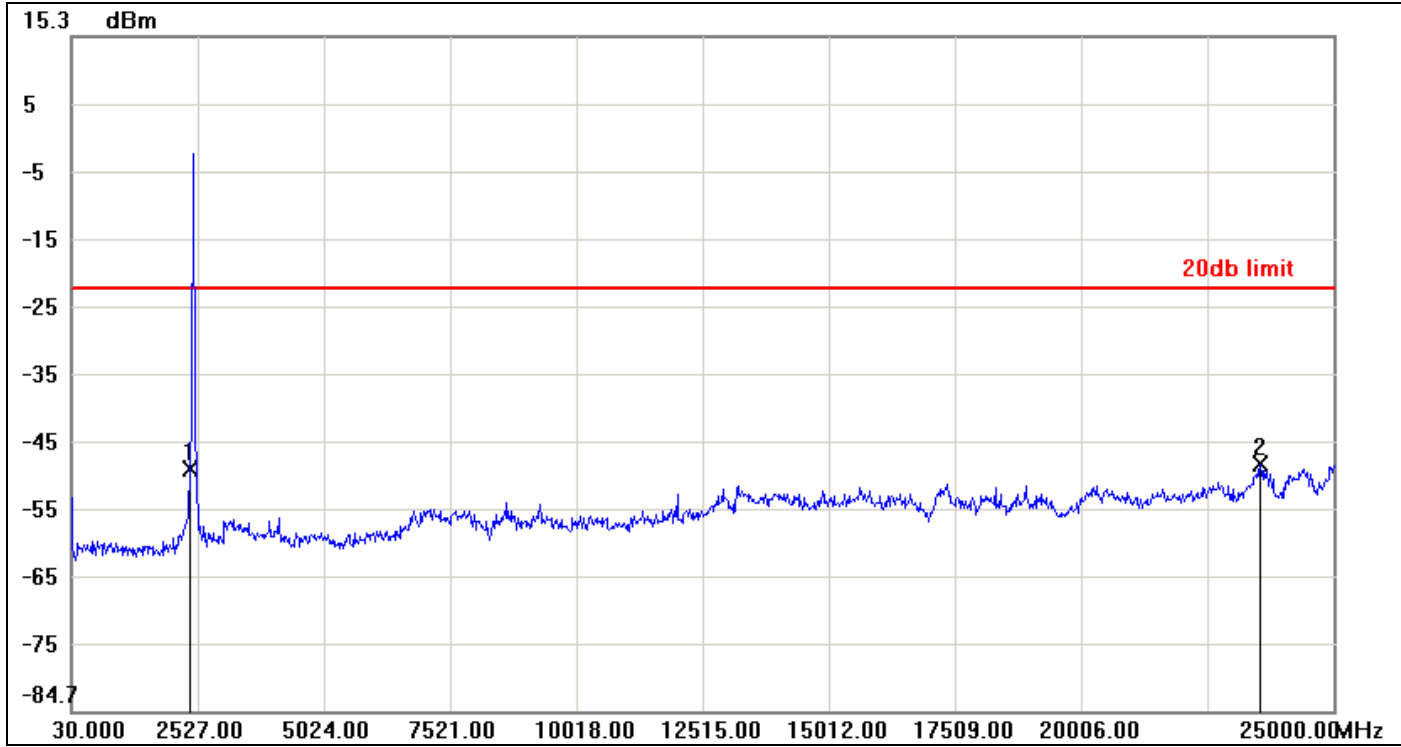

No.	Frequency(MHz)	Result(dBm)	Limit(dBm)	Margin(dBm)
1	2377.1800	-48.90	-22.02	-26.88
2	23551.7400	-48.07	-22.02	-26.05



CH High

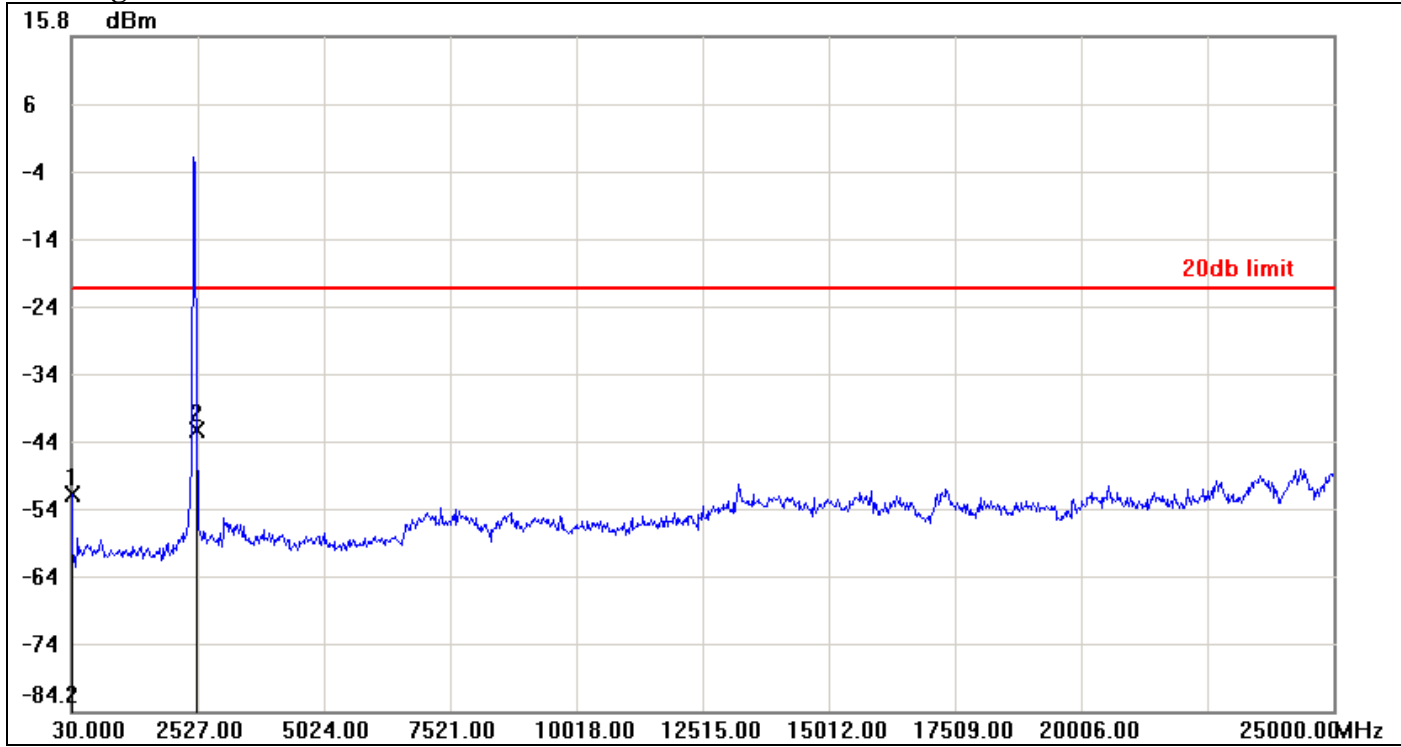

No.	Frequency(MHz)	Result(dBm)	Limit(dBm)	Margin(dBm)
1	30.0000	-52.18	-21.73	-30.45
2	2502.0300	-42.64	-21.73	-20.91



IEEE 802.11n HT 40 mode / Chain 1

CH Low

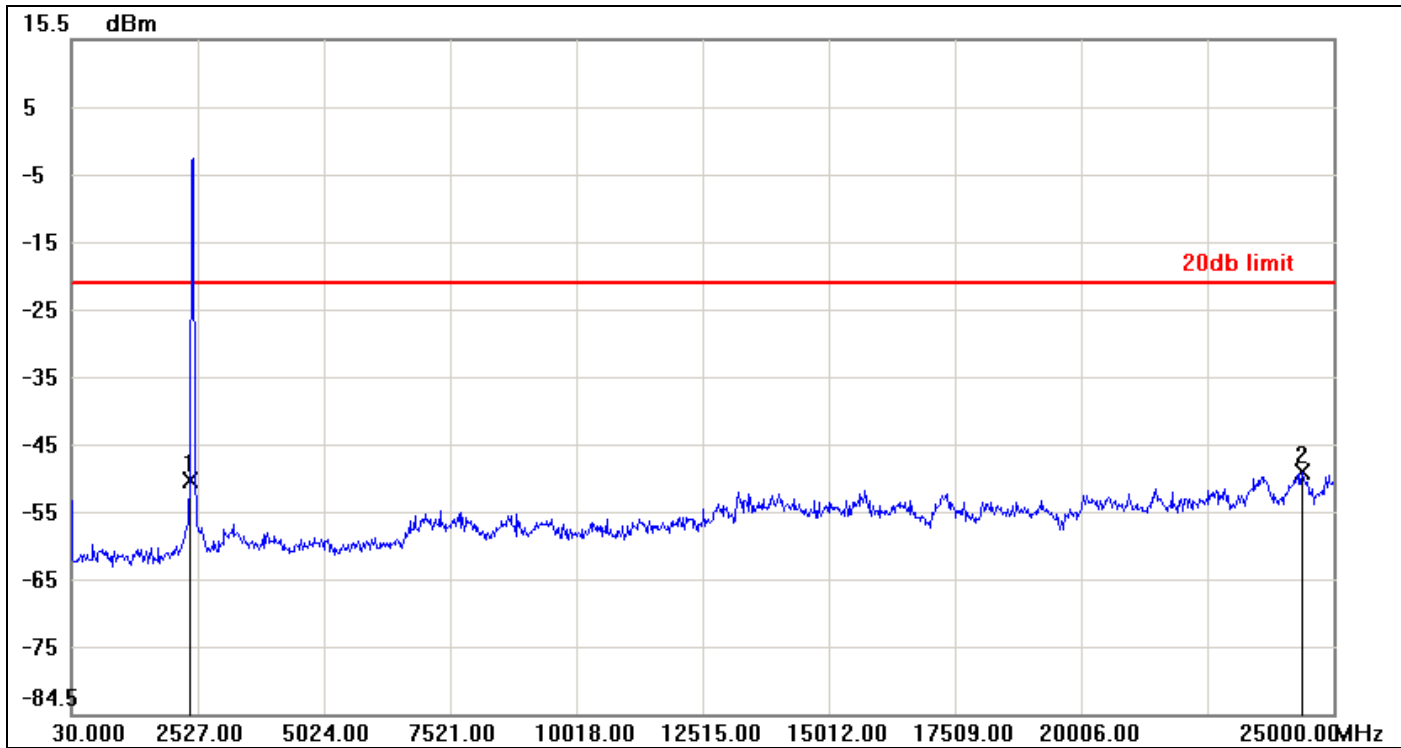

No.	Frequency(MHz)	Result(dBm)	Limit(dBm)	Margin(dBm)
1	2377.1800	-49.97	-20.68	-29.29
2	24375.7500	-48.57	-20.68	-27.89



CH Mid

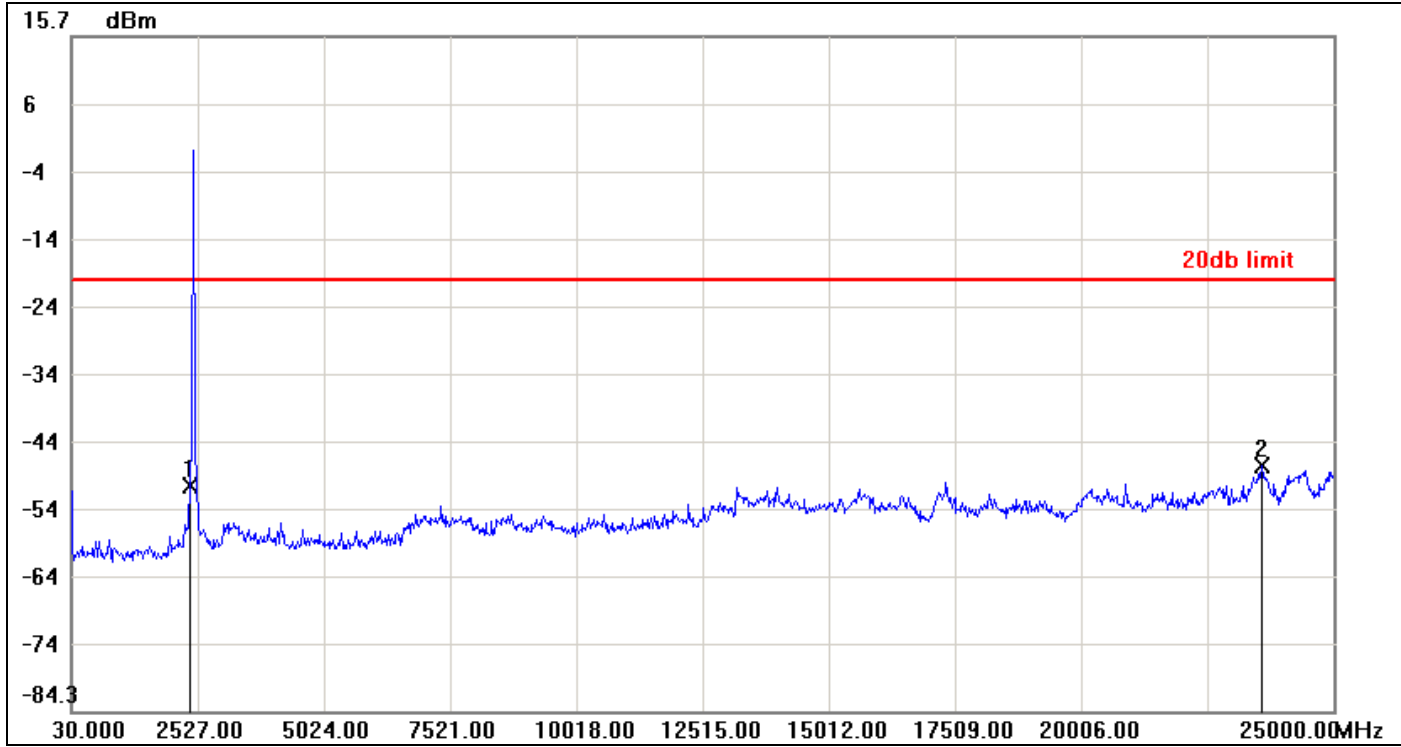

No.	Frequency(MHz)	Result(dBm)	Limit(dBm)	Margin(dBm)
1	2377.1800	-50.89	-20.33	-30.56
2	23576.7100	-48.03	-20.33	-27.70



CH High

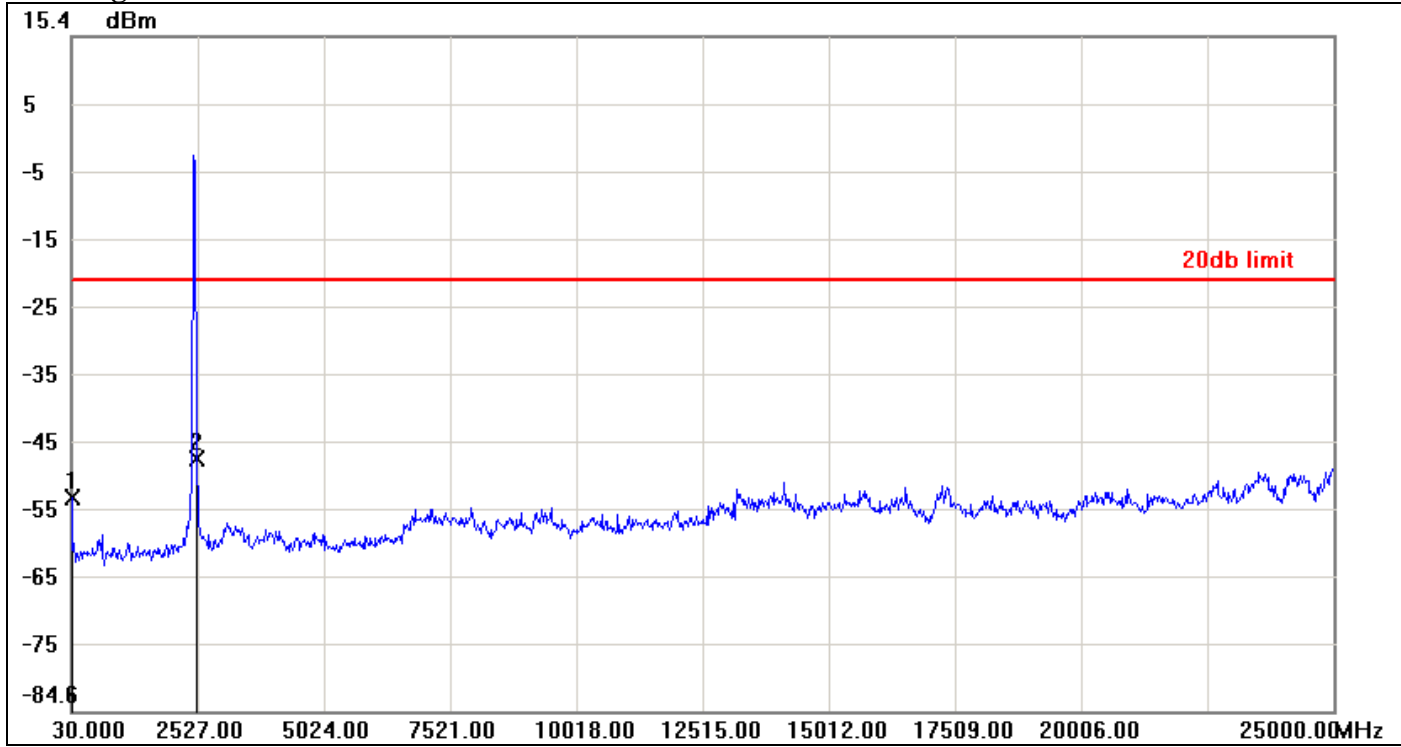

No.	Frequency(MHz)	Result(dBm)	Limit(dBm)	Margin(dBm)
1	30.0000	-52.96	-20.78	-32.18
2	2502.0300	-47.31	-20.78	-26.53



7.7 RADIATED EMISSIONS

LIMIT

1. According to §15.209(a), except as provided elsewhere in this Subpart, the emissions from an intentional radiator shall not exceed the field strength levels specified in the following table:

Frequency (MHz)	Field Strength (µV/m)	Measurement Distance (m)
0.009 - 0.490	2400/F(kHz)	300
0.490 - 1.705	24000/F(kHz)	30
1.705 – 30.0	30	30
30-88	100	3
88-216	150	3
216-960	200	3
Above 960	500	3

Remark: Except as provided in paragraph (g), fundamental emissions from intentional radiators operating under this Section shall not be located in the frequency bands 54-72 MHz, 76-88 MHz, 174-216 MHz or 470-806 MHz. However, operation within these frequency bands is permitted under other sections of this Part, e.g., Sections 15.231 and 15.241.

2. In the emission table above, the tighter limit applies at the band edges.

Frequency (MHz)	Field Strength (µV/m at 3-meter)	Field Strength (dBµV/m at 3-meter)
0.009 - 0.490	2400/F(kHz) +80	20LOG((2400/F(kHz))+80)
0.490 - 1.705	24000/F(kHz) +40	20LOG((24000/F(kHz))+40)
1.705 – 30.0	30	69.54
30-88	100	40
88-216	150	43.5
216-960	200	46
Above 960	500	54



Test Configuration

9kHz ~ 30MHz

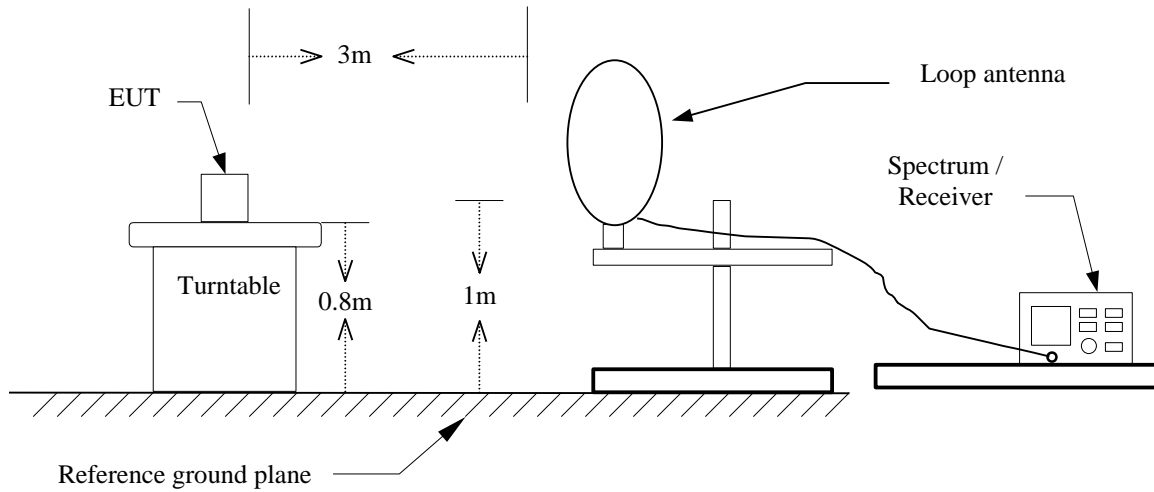

30MHz ~ 1GHz

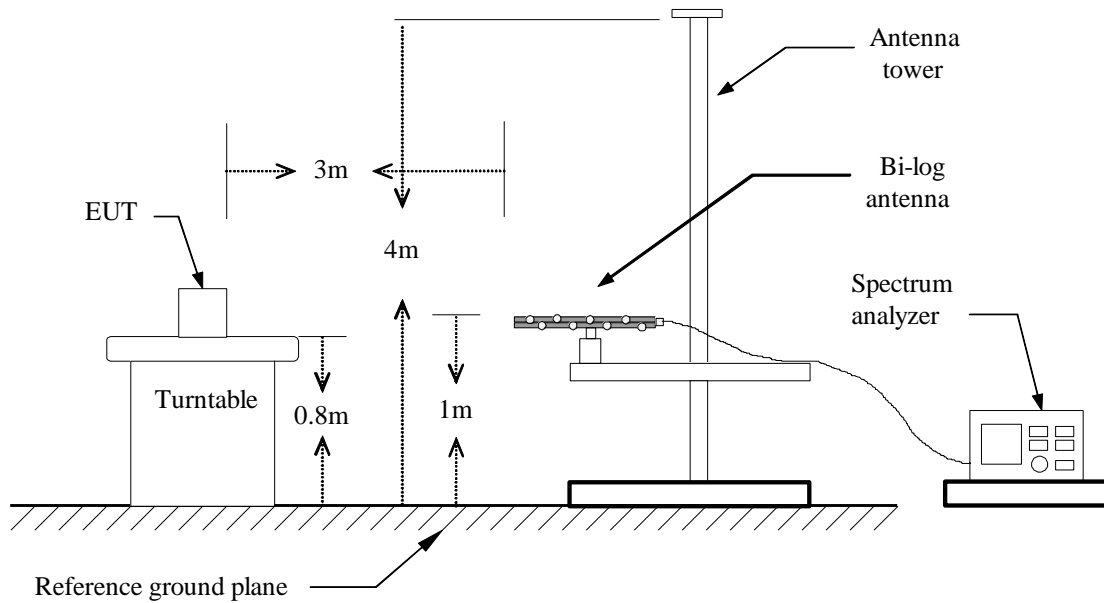



Above 1 GHz

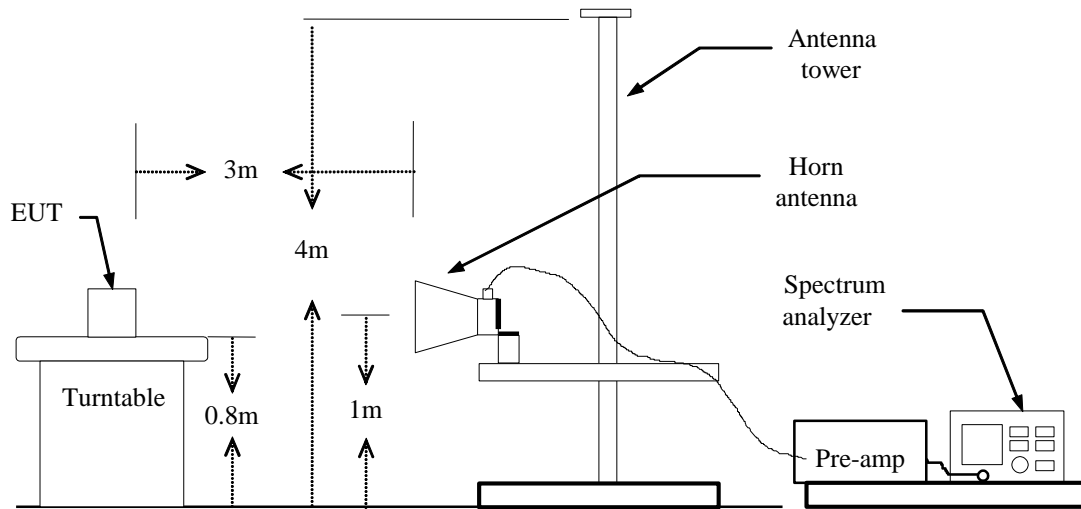



TEST PROCEDURE

1. The EUT is placed on a turntable, which is 0.8m above ground plane.
2. The turntable shall be rotated for 360 degrees to determine the position of maximum emission level.
3. EUT is set 3m away from the receiving antenna, which is varied from 1m to 4m to find out the highest emissions.
4. Maximum procedure was performed on the six highest emissions to ensure EUT compliance.
5. And also, each emission was to be maximized by changing the polarization of receiving antenna both horizontal and vertical.
6. Set the spectrum analyzer in the following setting as:
Below 1GHz:
RBW=100kHz / VBW=300kHz / Sweep=AUTO
Above 1GHz:
(a) PEAK: RBW=1MHz / VBW=3MHz / Sweep=AUTO
(b) AVERAGE: RBW=1MHz / VBW=300Hz / Sweep=AUTO
7. Repeat above procedures until the measurements for all frequencies are complete.

TEST RESULTS

No non-compliance noted.



Below 1GHz

Operation Mode: Normal Link **Test Date:** September 4, 2014
Temperature: 27°C **Tested by:** Ashby Cheng
Humidity: 53% RH **Polarity:** Ver. / Hor.

Frequency (MHz)	Reading (dBuV)	Correction Factor (dB/m)	Result (dBuV/m)	Limit (dBuV/m)	Margin (dB)	Remark	Ant. Pol. (H/V)
37.7600	52.80	-15.56	37.24	40.00	-2.76	peak	V
46.4900	58.83	-20.90	37.93	40.00	-2.07	peak	V
87.2300	54.23	-23.28	30.95	40.00	-9.05	peak	V
268.6200	44.41	-17.04	27.37	46.00	-18.63	peak	V
408.3000	44.63	-13.79	30.84	46.00	-15.16	peak	V
799.2100	41.00	-7.39	33.61	46.00	-12.39	peak	V
30.9700	48.57	-10.58	37.99	40.00	-2.01	peak	H
46.4900	55.32	-20.90	34.42	40.00	-5.58	peak	H
59.1000	57.45	-23.85	33.60	40.00	-6.40	peak	H
267.6500	50.86	-17.11	33.75	46.00	-12.25	peak	H
676.0200	40.36	-9.04	31.32	46.00	-14.68	peak	H
800.1800	47.64	-7.38	40.26	46.00	-5.74	peak	H

Remark:

1. No emission found between lowest internal used/generated frequency to 30MHz (9kHz~30MHz)
2. Radiated emissions measured in frequency range from 30 MHz to 1000MHz were made with an instrument using peak/quasi-peak detector mode.
3. Measurements above show only up to 6 maximum emissions noted, or would be lesser, with " N/A " remark, if no specific emissions from the EUT are recorded (ie: margin>20dB from the applicable limit) and considered that's already beyond the background noise floor.
4. $Margin (dB) = Result (dBuV/m) - Limit (dBuV/m)$.



Above 1 GHz

Operation Mode: TX / IEEE 802.11b / CH Low

Test Date: September 4, 2014

Temperature: 23°C

Tested by: Ashby Cheng

Humidity: 50 % RH

Polarity: Ver. / Hor.

Frequency (MHz)	Reading (dBuV)	Correction Factor (dB/m)	Result (dBuV/m)	Limit (dBuV/m)	Margin (dB)	Remark	Ant. Pol. (H/V)
1708.000	51.23	-4.25	46.98	74.00	-27.02	peak	V
N/A							
2184.000	45.66	-1.95	43.71	74.00	-30.29	peak	H
N/A							

Remark:

1. Measuring frequencies from 1 GHz to the 10th harmonic of highest fundamental frequency.
2. Radiated emissions measured in frequency above 1000MHz were made with an instrument using peak/average detector mode.
3. Average test would be performed if the peak result were greater than the average limit or as required by the applicant.
4. Data of measurement within this frequency range shown “ --- ” in the table above means the reading of emissions are attenuated more than 20dB below the permissible limits or the field strength is too small to be measured.
5. Measurements above show only up to 6 maximum emissions noted, or would be lesser, with “ N/A ” remark, if no specific emissions from the EUT are recorded (ie: margin>20dB from the applicable limit) and considered that's already beyond the background noise floor.
6. Margin (dB) = Remark result (dBuV/m) – Average limit (dBuV/m).



Operation Mode: TX / IEEE 802.11b / CH Mid

Test Date: September 4, 2014

Temperature: 23°C

Tested by: Ashby Cheng

Humidity: 50 % RH

Polarity: Ver. / Hor.

Frequency (MHz)	Reading (dBuV)	Correction Factor (dB/m)	Result (dBuV/m)	Limit (dBuV/m)	Margin (dB)	Remark	Ant. Pol. (H/V)
1704.000	44.94	-4.27	40.67	74.00	-33.33	peak	V
N/A							
1842.000	44.02	-3.43	40.59	74.00	-33.41	peak	H
N/A							

Remark:

1. Measuring frequencies from 1 GHz to the 10th harmonic of highest fundamental frequency.
2. Radiated emissions measured in frequency above 1000MHz were made with an instrument using peak/average detector mode.
3. Average test would be performed if the peak result were greater than the average limit or as required by the applicant.
4. Data of measurement within this frequency range shown “ --- ” in the table above means the reading of emissions are attenuated more than 20dB below the permissible limits or the field strength is too small to be measured.
5. Measurements above show only up to 6 maximum emissions noted, or would be lesser, with “ N/A ” remark, if no specific emissions from the EUT are recorded (ie: margin > 20dB from the applicable limit) and considered that's already beyond the background noise floor.
6. Margin (dB) = Remark result (dBuV/m) – Average limit (dBuV/m).



Operation Mode: TX / IEEE 802.11b / CH High

Test Date: September 4, 2014

Temperature: 23°C

Tested by: Ashby Cheng

Humidity: 50 % RH

Polarity: Ver. / Hor.

Frequency (MHz)	Reading (dBuV)	Correction Factor (dB/m)	Result (dBuV/m)	Limit (dBuV/m)	Margin (dB)	Remark	Ant. Pol. (H/V)
1758.000	44.91	-3.94	40.97	74.00	-33.03	peak	V
N/A							
1672.000	45.43	-4.46	40.97	74.00	-33.03	peak	H
N/A							

Remark:

1. Measuring frequencies from 1 GHz to the 10th harmonic of highest fundamental frequency.
2. Radiated emissions measured in frequency above 1000MHz were made with an instrument using peak/average detector mode.
3. Average test would be performed if the peak result were greater than the average limit or as required by the applicant.
4. Data of measurement within this frequency range shown “ --- ” in the table above means the reading of emissions are attenuated more than 20dB below the permissible limits or the field strength is too small to be measured.
5. Measurements above show only up to 6 maximum emissions noted, or would be lesser, with “ N/A ” remark, if no specific emissions from the EUT are recorded (ie: margin > 20dB from the applicable limit) and considered that's already beyond the background noise floor.
6. Margin (dB) = Remark result (dBuV/m) – Average limit (dBuV/m).



Operation Mode: TX / IEEE 802.11g / CH Low

Test Date: September 4, 2014

Temperature: 23°C

Tested by: Ashby Cheng

Humidity: 50 % RH

Polarity: Ver. / Hor.

Frequency (MHz)	Reading (dBuV)	Correction Factor (dB/m)	Result (dBuV/m)	Limit (dBuV/m)	Margin (dB)	Remark	Ant. Pol. (H/V)
1696.000	51.11	-4.32	46.79	74.00	-27.21	peak	V
N/A							
1794.000	50.84	-3.72	47.12	74.00	-26.88	peak	H
N/A							

Remark:

1. Measuring frequencies from 1 GHz to the 10th harmonic of highest fundamental frequency.
2. Radiated emissions measured in frequency above 1000MHz were made with an instrument using peak/average detector mode.
3. Average test would be performed if the peak result were greater than the average limit or as required by the applicant.
4. Data of measurement within this frequency range shown “ --- ” in the table above means the reading of emissions are attenuated more than 20dB below the permissible limits or the field strength is too small to be measured.
5. Measurements above show only up to 6 maximum emissions noted, or would be lesser, with “ N/A ” remark, if no specific emissions from the EUT are recorded (ie: margin > 20dB from the applicable limit) and considered that's already beyond the background noise floor.
6. Margin (dB) = Remark result (dBuV/m) – Average limit (dBuV/m).



Operation Mode: TX / IEEE 802.11g / CH Mid

Test Date: September 4, 2014

Temperature: 23°C

Tested by: Ashby Cheng

Humidity: 50 % RH

Polarity: Ver. / Hor.

Frequency (MHz)	Reading (dBuV)	Correction Factor (dB/m)	Result (dBuV/m)	Limit (dBuV/m)	Margin (dB)	Remark	Ant. Pol. (H/V)
1854.000	51.01	-3.36	47.65	74.00	-26.35	peak	V
N/A							
1782.000	50.62	-3.80	46.82	74.00	-27.18	peak	H
N/A							

Remark:

1. Measuring frequencies from 1 GHz to the 10th harmonic of highest fundamental frequency.
2. Radiated emissions measured in frequency above 1000MHz were made with an instrument using peak/average detector mode.
3. Average test would be performed if the peak result were greater than the average limit or as required by the applicant.
4. Data of measurement within this frequency range shown “ --- ” in the table above means the reading of emissions are attenuated more than 20dB below the permissible limits or the field strength is too small to be measured.
5. Measurements above show only up to 6 maximum emissions noted, or would be lesser, with “ N/A ” remark, if no specific emissions from the EUT are recorded (ie: margin > 20dB from the applicable limit) and considered that's already beyond the background noise floor.
6. Margin (dB) = Remark result (dBuV/m) – Average limit (dBuV/m).



Operation Mode: TX / IEEE 802.11g / CH High

Test Date: September 4, 2014

Temperature: 23°C

Tested by: Ashby Cheng

Humidity: 50 % RH

Polarity: Ver. / Hor.

Frequency (MHz)	Reading (dBuV)	Correction Factor (dB/m)	Result (dBuV/m)	Limit (dBuV/m)	Margin (dB)	Remark	Ant. Pol. (H/V)
1794.000	51.05	-3.72	47.33	74.00	-26.67	peak	V
N/A							
1788.000	51.05	-3.76	47.29	74.00	-26.71	peak	H
N/A							

Remark:

1. Measuring frequencies from 1 GHz to the 10th harmonic of highest fundamental frequency.
2. Radiated emissions measured in frequency above 1000MHz were made with an instrument using peak/average detector mode.
3. Average test would be performed if the peak result were greater than the average limit or as required by the applicant.
4. Data of measurement within this frequency range shown “ --- ” in the table above means the reading of emissions are attenuated more than 20dB below the permissible limits or the field strength is too small to be measured.
5. Measurements above show only up to 6 maximum emissions noted, or would be lesser, with “ N/A ” remark, if no specific emissions from the EUT are recorded (ie: margin>20dB from the applicable limit) and considered that's already beyond the background noise floor.
6. Margin (dB) = Remark result (dBuV/m) – Average limit (dBuV/m).



Operation Mode: TX / IEEE 802.11n HT 20 mode / CH Low

Test Date: September 4, 2014

Temperature: 23°C

Tested by: Ashby Cheng

Humidity: 50 % RH

Polarity: Ver. / Hor.

Frequency (MHz)	Reading (dBuV)	Correction Factor (dB/m)	Result (dBuV/m)	Limit (dBuV/m)	Margin (dB)	Remark	Ant. Pol. (H/V)
1790.000	51.09	-3.75	47.34	74.00	-26.66	peak	V
N/A							
1774.000	51.01	-3.84	47.17	74.00	-26.83	peak	H
N/A							

Remark:

1. Measuring frequencies from 1 GHz to the 10th harmonic of highest fundamental frequency.
2. Radiated emissions measured in frequency above 1000MHz were made with an instrument using peak/average detector mode.
3. Average test would be performed if the peak result were greater than the average limit or as required by the applicant.
4. Data of measurement within this frequency range shown “ --- ” in the table above means the reading of emissions are attenuated more than 20dB below the permissible limits or the field strength is too small to be measured.
5. Measurements above show only up to 6 maximum emissions noted, or would be lesser, with “ N/A ” remark, if no specific emissions from the EUT are recorded (ie: margin>20dB from the applicable limit) and considered that's already beyond the background noise floor.
6. Margin (dB) = Remark result (dBuV/m) – Average limit (dBuV/m).



Operation Mode: TX / IEEE 802.11n HT 20 mode / CH Mid

Test Date: September 4, 2014

Temperature: 23°C

Tested by: Ashby Cheng

Humidity: 50 % RH

Polarity: Ver. / Hor.

Frequency (MHz)	Reading (dBuV)	Correction Factor (dB/m)	Result (dBuV/m)	Limit (dBuV/m)	Margin (dB)	Remark	Ant. Pol. (H/V)
1670.000	51.04	-4.48	46.56	74.00	-27.44	peak	V
N/A							
1902.000	50.00	-3.07	46.93	74.00	-27.07	peak	H
N/A							

Remark:

1. Measuring frequencies from 1 GHz to the 10th harmonic of highest fundamental frequency.
2. Radiated emissions measured in frequency above 1000MHz were made with an instrument using peak/average detector mode.
3. Average test would be performed if the peak result were greater than the average limit or as required by the applicant.
4. Data of measurement within this frequency range shown “ --- ” in the table above means the reading of emissions are attenuated more than 20dB below the permissible limits or the field strength is too small to be measured.
5. Measurements above show only up to 6 maximum emissions noted, or would be lesser, with “ N/A ” remark, if no specific emissions from the EUT are recorded (ie: margin > 20dB from the applicable limit) and considered that's already beyond the background noise floor.
6. Margin (dB) = Remark result (dBuV/m) – Average limit (dBuV/m).



Operation Mode: TX / IEEE 802.11n HT 20 mode / CH High

Test Date: September 4, 2014

Temperature: 23°C

Tested by: Ashby Cheng

Humidity: 50 % RH

Polarity: Ver. / Hor.

Frequency (MHz)	Reading (dBuV)	Correction Factor (dB/m)	Result (dBuV/m)	Limit (dBuV/m)	Margin (dB)	Remark	Ant. Pol. (H/V)
1696.000	51.96	-4.32	47.64	74.00	-26.36	peak	V
N/A							
1798.000	50.97	-3.70	47.27	74.00	-26.73	peak	H
N/A							

Remark:

1. Measuring frequencies from 1 GHz to the 10th harmonic of highest fundamental frequency.
2. Radiated emissions measured in frequency above 1000MHz were made with an instrument using peak/average detector mode.
3. Average test would be performed if the peak result were greater than the average limit or as required by the applicant.
4. Data of measurement within this frequency range shown “ --- ” in the table above means the reading of emissions are attenuated more than 20dB below the permissible limits or the field strength is too small to be measured.
5. Measurements above show only up to 6 maximum emissions noted, or would be lesser, with “ N/A ” remark, if no specific emissions from the EUT are recorded (ie: margin > 20dB from the applicable limit) and considered that's already beyond the background noise floor.
6. Margin (dB) = Remark result (dBuV/m) – Average limit (dBuV/m).



Operation Mode: TX / IEEE 802.11n HT 40 mode
/ CH Low

Temperature: 23°C

Humidity: 50 % RH

Test Date: September 4, 2014

Tested by: Ashby Cheng

Polarity: Ver. / Hor.

Frequency (MHz)	Reading (dBuV)	Correction Factor (dB/m)	Result (dBuV/m)	Limit (dBuV/m)	Margin (dB)	Remark	Ant. Pol. (H/V)
1780.000	51.04	-3.81	47.23	74.00	-26.77	peak	V
N/A							
1704.000	50.79	-4.27	46.52	74.00	-27.48	peak	H
N/A							

Remark:

1. Measuring frequencies from 1 GHz to the 10th harmonic of highest fundamental frequency.
2. Radiated emissions measured in frequency above 1000MHz were made with an instrument using peak/average detector mode.
3. Average test would be performed if the peak result were greater than the average limit or as required by the applicant.
4. Data of measurement within this frequency range shown “ --- ” in the table above means the reading of emissions are attenuated more than 20dB below the permissible limits or the field strength is too small to be measured.
5. Measurements above show only up to 6 maximum emissions noted, or would be lesser, with “ N/A ” remark, if no specific emissions from the EUT are recorded (ie: margin > 20dB from the applicable limit) and considered that's already beyond the background noise floor.
6. Margin (dB) = Remark result (dBuV/m) – Average limit (dBuV/m).



Operation Mode: TX / IEEE 802.11n HT 40 mode
/ CH Mid

Temperature: 23°C

Humidity: 50 % RH

Test Date: September 4, 2014

Tested by: Ashby Cheng

Polarity: Ver. / Hor.

Frequency (MHz)	Reading (dBuV)	Correction Factor (dB/m)	Result (dBuV/m)	Limit (dBuV/m)	Margin (dB)	Remark	Ant. Pol. (H/V)
1948.000	50.10	-2.79	47.31	74.00	-26.69	peak	V
N/A							
1828.000	51.98	-3.52	48.46	74.00	-25.54	peak	H
N/A							

Remark:

1. Measuring frequencies from 1 GHz to the 10th harmonic of highest fundamental frequency.
2. Radiated emissions measured in frequency above 1000MHz were made with an instrument using peak/average detector mode.
3. Average test would be performed if the peak result were greater than the average limit or as required by the applicant.
4. Data of measurement within this frequency range shown “ --- ” in the table above means the reading of emissions are attenuated more than 20dB below the permissible limits or the field strength is too small to be measured.
5. Measurements above show only up to 6 maximum emissions noted, or would be lesser, with “ N/A ” remark, if no specific emissions from the EUT are recorded (ie: margin>20dB from the applicable limit) and considered that's already beyond the background noise floor.
6. Margin (dB) = Remark result (dBuV/m) – Average limit (dBuV/m).



Operation Mode: TX / IEEE 802.11n HT 40 mode / CH High

Test Date: September 4, 2014

Temperature: 23°C

Tested by: Ashby Cheng

Humidity: 50 % RH

Polarity: Ver. / Hor.

Frequency (MHz)	Reading (dBuV)	Correction Factor (dB/m)	Result (dBuV/m)	Limit (dBuV/m)	Margin (dB)	Remark	Ant. Pol. (H/V)
1832.000	51.13	-3.49	47.64	74.00	-26.36	peak	V
N/A							
1726.000	51.07	-4.14	46.93	74.00	-27.07	peak	H
N/A							

Remark:

1. Measuring frequencies from 1 GHz to the 10th harmonic of highest fundamental frequency.
2. Radiated emissions measured in frequency above 1000MHz were made with an instrument using peak/average detector mode.
3. Average test would be performed if the peak result were greater than the average limit or as required by the applicant.
4. Data of measurement within this frequency range shown “ --- ” in the table above means the reading of emissions are attenuated more than 20dB below the permissible limits or the field strength is too small to be measured.
5. Measurements above show only up to 6 maximum emissions noted, or would be lesser, with “ N/A ” remark, if no specific emissions from the EUT are recorded (ie: margin > 20dB from the applicable limit) and considered that's already beyond the background noise floor.
6. Margin (dB) = Remark result (dBuV/m) – Average limit (dBuV/m).



7.8 POWERLINE CONDUCTED EMISSIONS

LIMIT

According to §15.207(a), except as shown in paragraphs (b) and (c) of this section, for an intentional radiator that is designed to be connected to the public utility (AC) power line, the radio frequency voltage that is conducted back onto the AC power line on any frequency or frequencies within the band 150 kHz to 30 MHz shall not exceed the limits in the following table, as measured using a 50 μ H/50 ohms line impedance stabilization network (LISN). Compliance with the provisions of this paragraph shall be based on the measurement of the radio frequency voltage between each power line and ground at the power terminal. The lower limit applies at the boundary between the frequency ranges.

Frequency Range (MHz)	Limits (dB μ V)	
	Quasi-peak	Average
0.15 to 0.50	66 to 56*	56 to 46*
0.50 to 5	56	46
5 to 30	60	50

* Decreases with the logarithm of the frequency.

Test Configuration

See test photographs attached in Appendix II for the actual connections between EUT and support equipment.

TEST PROCEDURE

1. The EUT was placed on a table, which is 0.8m above ground plane.
2. Maximum procedure was performed on the six highest emissions to ensure EUT compliance.
3. Repeat above procedures until all frequency measured were complete.



TEST RESULTS

The initial step in collecting conducted data is a spectrum analyzer peak scan of the measurement range. Significant peaks are then marked as shown on the following data page, and these signals are then quasi-peaked.

Test Data

Operation Mode: Normal Link **Test Date:** September 4, 2014
Temperature: 28°C **Tested by:** Kevin Chang
Humidity: 57% RH

Frequency (MHz)	Reading (dBuV)	Factor (dB)	Result (dBuV)	Limit (dBuV)	Margin (dB)	Detector	Note
0.1539	33.93	10.01	43.94	65.78	-21.84	peak	L1
0.1539	23.45	10.01	33.46	55.78	-22.32	AVG	L1
0.4139	29.47	10.00	39.47	47.57	-8.10	AVG	L1
0.4140	33.07	10.00	43.07	57.57	-14.50	peak	L1
0.6979	20.01	10.04	30.05	46.00	-15.95	AVG	L1
0.6980	23.95	10.04	33.99	56.00	-22.01	peak	L1
6.2659	16.48	10.37	26.85	50.00	-23.15	AVG	L1
6.3580	26.96	10.37	37.33	60.00	-22.67	peak	L1
16.2258	33.06	10.75	43.81	50.00	-6.19	AVG	L1
16.2260	36.37	10.75	47.12	60.00	-12.88	peak	L1
23.1299	33.95	10.95	44.90	60.00	-15.10	peak	L1
23.1299	28.69	10.95	39.64	50.00	-10.36	AVG	L1
0.1539	33.45	9.96	43.41	65.78	-22.37	peak	L2
0.1539	22.03	9.96	31.99	55.78	-23.79	AVG	L2
0.4139	29.29	9.95	39.24	47.57	-8.33	AVG	L2
0.4140	33.12	9.95	43.07	57.57	-14.50	peak	L2
0.6979	19.84	9.98	29.82	46.00	-16.18	AVG	L2
0.6980	23.68	9.98	33.66	56.00	-22.34	peak	L2
6.3939	16.77	10.19	26.96	50.00	-23.04	AVG	L2
6.5180	25.94	10.19	36.13	60.00	-23.87	peak	L2
16.2258	32.72	10.38	43.10	50.00	-6.90	AVG	L2
16.2260	36.33	10.38	46.71	60.00	-13.29	peak	L2
18.2419	31.34	10.40	41.74	50.00	-8.26	AVG	L2
18.2420	33.91	10.40	44.31	60.00	-15.69	peak	L2

Remark:

1. Measuring frequencies from 0.15 MHz to 30MHz.
2. The emissions measured in frequency range from 0.15 MHz to 30MHz were made with an instrument using Quasi-peak detector and average detector.
3. The IF bandwidth of SPA between 0.15MHz and 30MHz was 10 kHz; the IF bandwidth of Test Receiver between 0.15MHz and 30MHz was 9 kHz;
4. L1 = Line One (Live Line) / L2 = Line Two (Neutral Line)



Test Plots

Conducted emissions (Line 1)

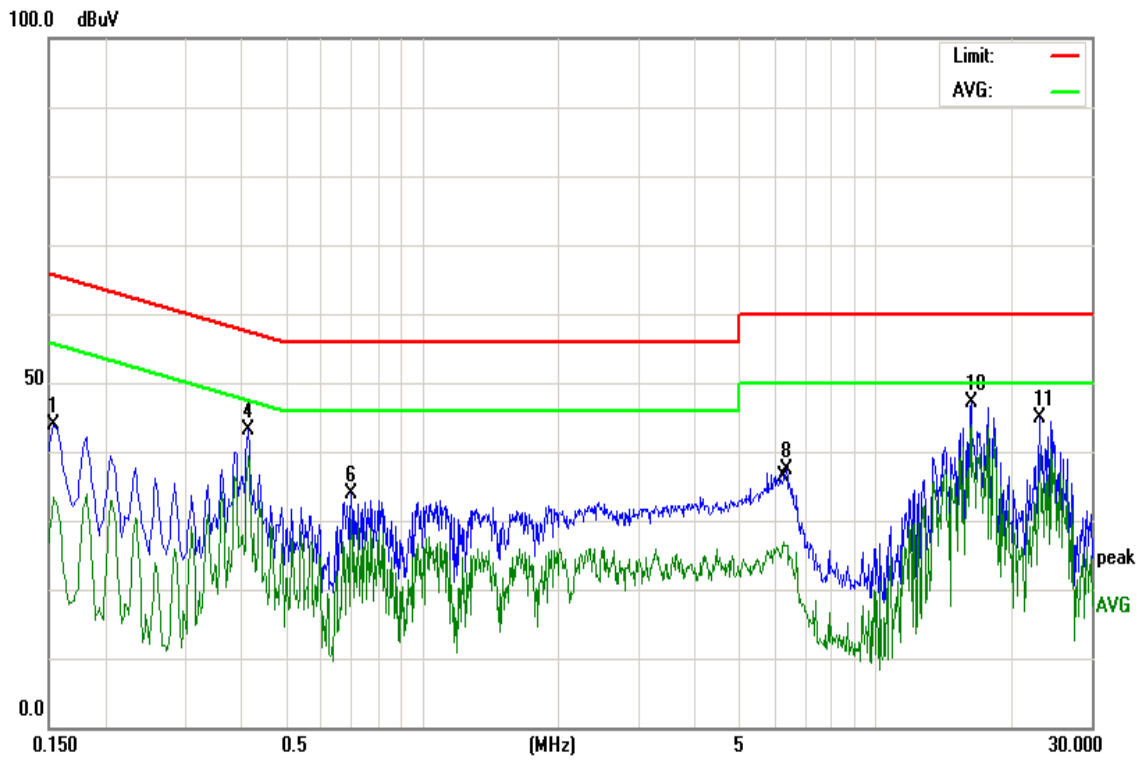

Conducted emissions (Line 2)

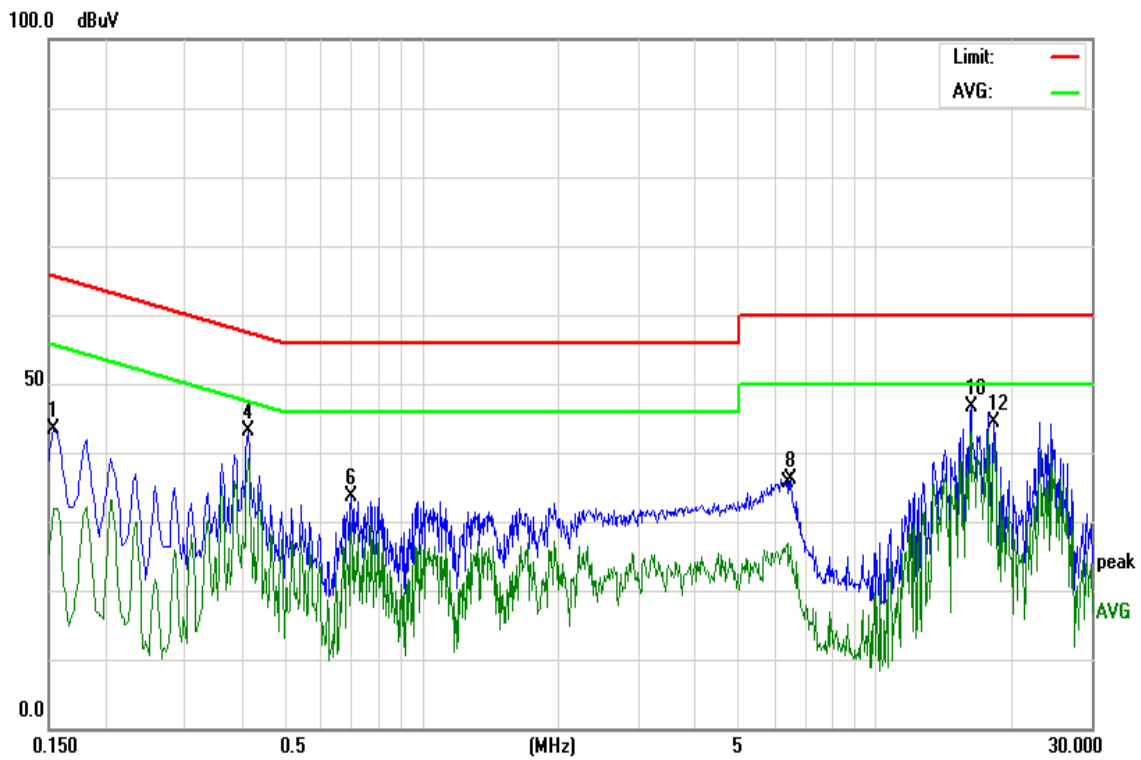



Conducted Emissions Setup Photos

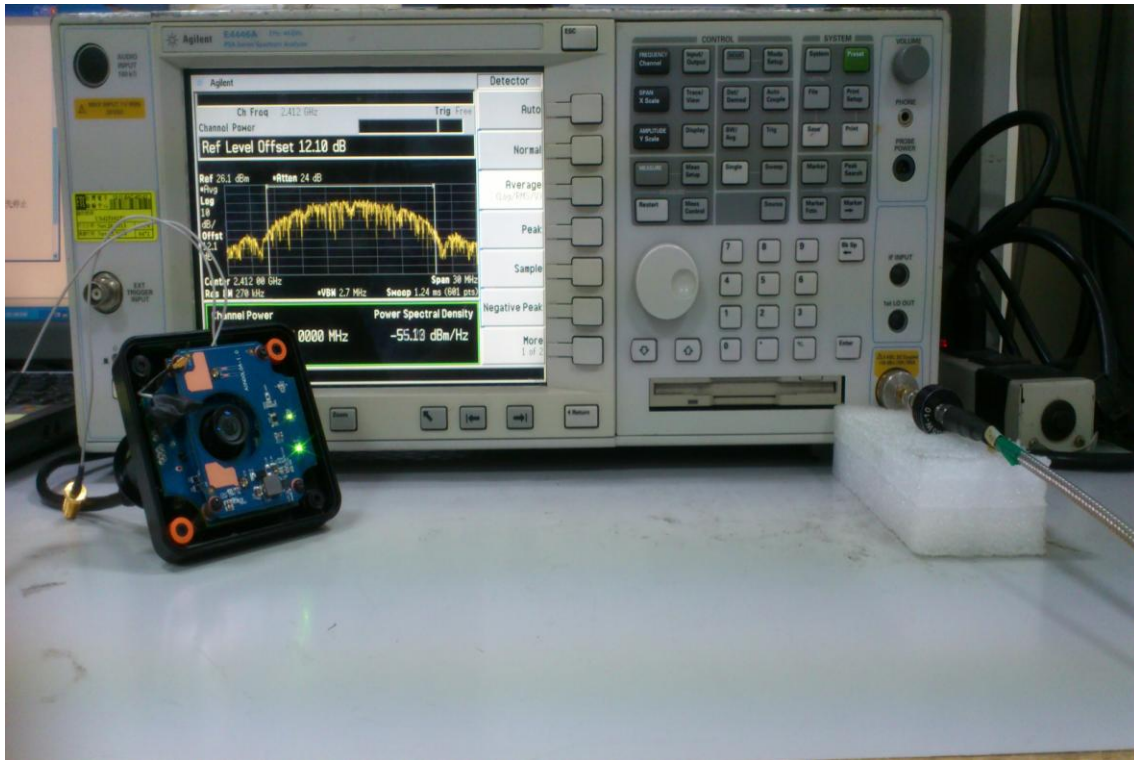



Radiated Emissions Setup Photos

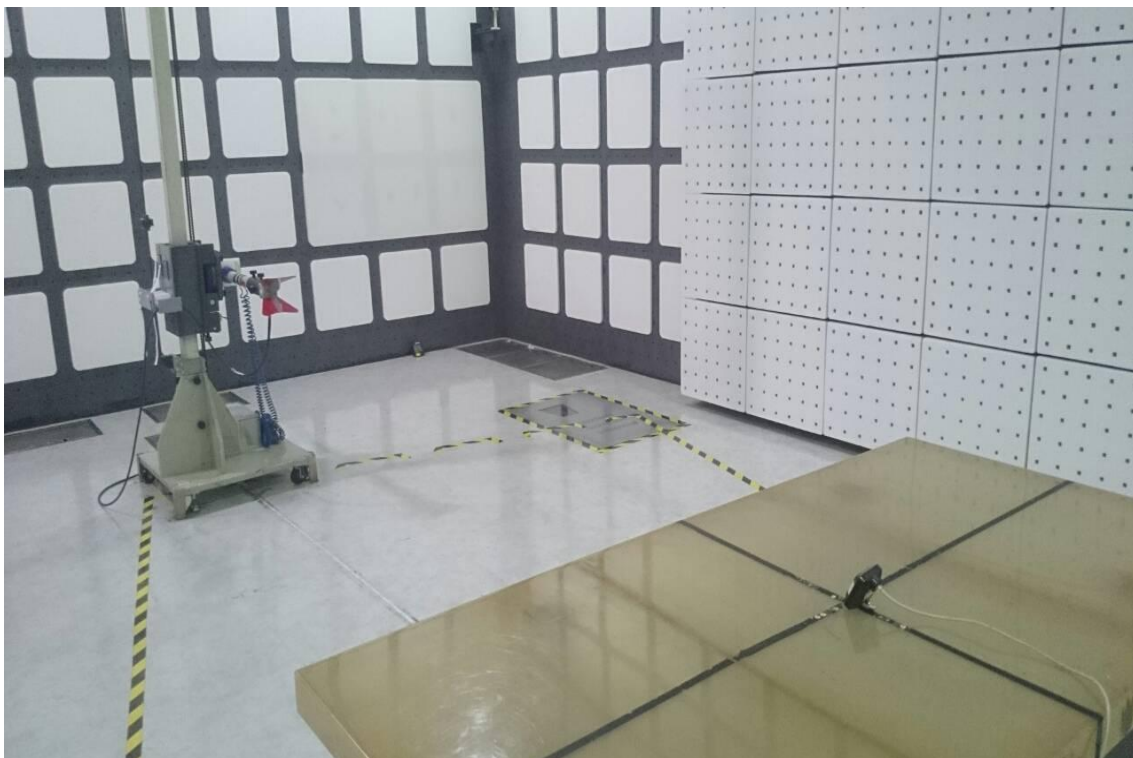



Powerline Conducted Emissions Setup Photos

