

# FCC TEST REPORT

according to

## FCC Rules and Regulations

### Part 15 Subpart C

Applicant	SerComm Corporation
Address	8F, No. 3-1, YunaQu St., Nankang, Taipei 115, Taiwan, R.O.C.
Equipment	54 Mbps Wireless PC Card
Model No.	CB801R
FCC ID	P27CB801R
Trade Name	SerComm

- The test result refers exclusively to the test presented test model / sample.,
- Without written approval of *Exclusive Certification Corp.* the test report shall not be reproduced except in full.

## Contents

1.	Report of Measurements and Examinations .....	4
1.1.	List of Measurements and Examinations .....	4
1.2.	Antenna Requirements .....	5
1.3.	Test of Conducted Emission .....	6
1.4.	Test of Radiated Emission .....	8
1.5.	6dB Bandwidth .....	9
1.6.	Maximum Peak Output Power .....	9
1.7.	Band Edges Measurement .....	10
1.8.	Power Spectral Density .....	10
1.9.	Restricted Bands of Operation .....	11
1.10.	Labeling Requirement .....	11
1.11.	RF Exposure .....	12
2.	Test Configuration of Equipment under Test .....	14
2.1.	Test Mode and Test Software .....	14
2.2.	Description of Test System .....	14
2.3.	Connection Diagram of Test System .....	14
2.4.	Feature of Equipment under Test .....	15
2.5.	History of this test report .....	15
3.	General Information of Test .....	16
4.	Test Result and Data .....	17
4.1.	Antenna Requirement .....	17
4.2.	Test Result of Conducted Emission .....	18
4.3.	RF Portion .....	31
4.4.	6dB Bandwidth Measurement Data .....	37
4.5.	Peak Output Power Measurement Data .....	41
4.6.	Band Edges Measurement Data .....	45
4.7.	Power Spectral Density Measurement Data .....	57
4.8.	Test Result of RF Exposure Evaluation .....	61
5.	List of Measuring Equipment Used .....	62
Appendix A. Photographs of EUT .....		A1 ~ A7

# CERTIFICATE OF COMPLIANCE

according to

## FCC Rules and Regulations

### Part 15 Subpart C

Applicant	SerComm Corporation
Address	8F, No. 3-1, YunaQu St., Nankang, Taipei 115, Taiwan, R.O.C.
Equipment	54 Mbps Wireless PC Card
Model No.	CB801R
FCC ID	P27CB801R

**I HEREBY CERTIFY THAT :**

The measurements shown in this test report were made in accordance with the procedures given in **ANSI C63.4**. The equipment was **passed** the test performed according to **FCC Rules and Regulations Part 15 Subpart C (2002)**.

The test was carried out on Jul. 14, 2004 at **Exclusive Certification Corp.**

Signature

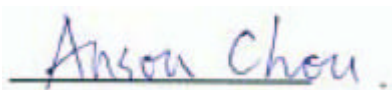

Anson Chou / Manager

# 1. Report of Measurements and Examinations

## 1.1. List of Measurements and Examinations

FCC Rule	Description of Test	Result
15.203	. Antenna Requirement	Pass
15.207	. Conducted Emission	Pass
15.209	. Radiated Emission	Pass
15.247(a)(2)	. 6dB Bandwidth	Pass
15.247(b)	. Maximum Peak Output Power	Pass
15.247(c)	. 100kHz Bandwidth of Frequency Band Edges	Pass
15.247(d)	. Power Spectral Density	Pass
1.1307 1.1310 2.1091 2.1093	. RF Exposure Compliance	Pass

Test by: Jerry

## 1.2. Antenna Requirements

### 1.2.1. Standard Applicable

For intentional device, according to FCC 47 CFR Section 15.203, an intentional radiator shall be designed to ensure that no antenna other than that furnished by the responsible party shall be used with the device.

And according to FCC 47 CFR Section 15.247 (b), if transmitting antennas of directional gain greater than 6dBi are used, the power shall be reduced by the amount in dB that the directional gain of the antenna exceeds 6dBi.

### 1.3. Test of Conducted Emission

Conducted Emissions were measured from 150 kHz to 30 MHz with a bandwidth of 9 KHz on the 115 VAC power and return leads of the EUT according to the methods defined in ANSI C63.4-1992 Section 3.1. The EUT was placed on a nonmetallic stand in a shielded room 0.8 meters above the ground plane as shown in section 2.2. The interface cables and equipment positioning were varied within limits of reasonable applications to determine the position produced maximum conducted emissions.

#### 1.3.1. Test Procedures

- a. The EUT was placed 0.4 meter from the conducting wall of the shielding room was kept at least 80 centimeters from any other grounded conducting surface.
- b. Connect EUT to the power mains through a line impedance stabilization network (LISN).
- c. All the support units are connecting to the other LISN.
- d. The LISN provides 50 ohm coupling impedance for the measuring instrument.
- e. The FCC states that a 50 ohm, 50 microhenry LISN should be used.
- f. Both sides of AC line were checked for maximum conducted interference.
- g. The frequency range from 150 kHz to 30 MHz was searched.
- h. Set the test-receiver system to Peak Detect Function and Specified Bandwidth with Maximum Hold Mode.

1.3.2. Typical Test Setup Layout of Conducted Emission

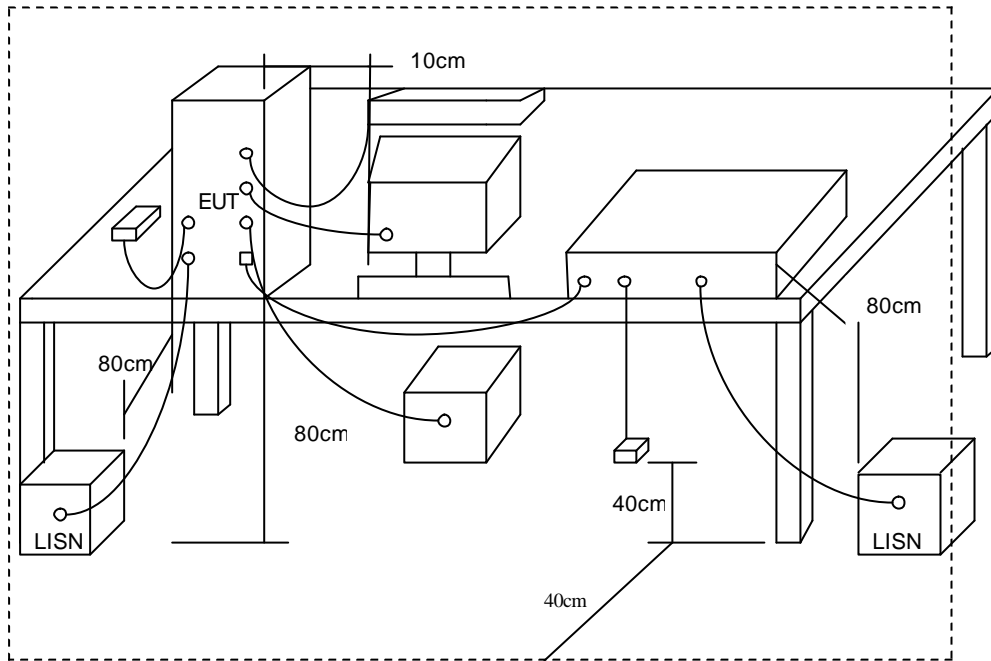

1.3.3. Conducted Emission Requirement

Except for A digital devices, for equipment that is designed to be connected to the public utility (AC) power line on any frequency voltage that is conducted back onto the AC power line on ant frequency or frequencies within the band 150KHz to 30MHz shall not exceed the limits in the following table, as measured using a 50 $\mu$ H/50 ohms line impeddance stabilization network (LISN). Compliance with the provisions of this paragraph shall be based on the measurement of the Radio frequency voltage between each power line and ground at the power terminal. The lower limit applies at the band edges.

Frequency (MHz)	Quasi Peak (dB $\mu$ V)	Average (dB $\mu$ V)
0.15 – 0.5	66-56*	56-46*
0.5 – 5.0	56	46
5.0 – 30.0	60	50

## 1.4. Test of Radiated Emission

Radiated emissions from 30 MHz to 25 GHz were measured according to the methods defines in ANSI C63.4-2001. The EUT was placed, 0.8 meter above the ground plane, as shown in section 5.6.3. The interface cables and equipment positions were varied within limits of reasonable applications to determine the positions producing maximum radiated emissions

### 1.4.1. Test Procedures

1. The EUT was placed on a rotatable table top 0.8 meter above ground.
2. The EUT was set 3 meters from the interference receiving antenna which was mounted on the top of a variable height antenna tower.
3. The table was rotated 360 degrees to determine the position of the highest radiation.
4. The antenna is a broadband antenna and its height is varied between one meter and four meters above ground to find the maximum value of the field strength both horizontal polarization and vertical polarization of the antenna are set to make the measurement.
5. For each suspected emission the EUT was arranged to its worst case and then tune the antenna tower (from 1 M to 4 M) and turn table (from 0 degree to 360 degrees) to find the maximum reading.
6. Set the test-receiver system to Peak or CISPR quasi-peak Detect Function and specified bandwidth with Maximum Hold Mode.
7. If the emission level of the EUT in peak mode was 3 dB lower than the limit specified, then testing will be stopped and peak values of EUT will be reported, otherwise, the emissions which do not have 3 dB margin will be repeated one by one using the quasi-peak method and reported.
8. For testing above 1GHz, the emission level of the EUT in peak mode was 20dB lower than average limit (that means the emission level in peak mode also complies with the limit in average mode), then testing will be stopped and peak values of EUT will be reported, otherwise, the emissions will be measured in average mode again and reported.

### 1.4.2. Typical Test Setup Layout of Radiated Emission

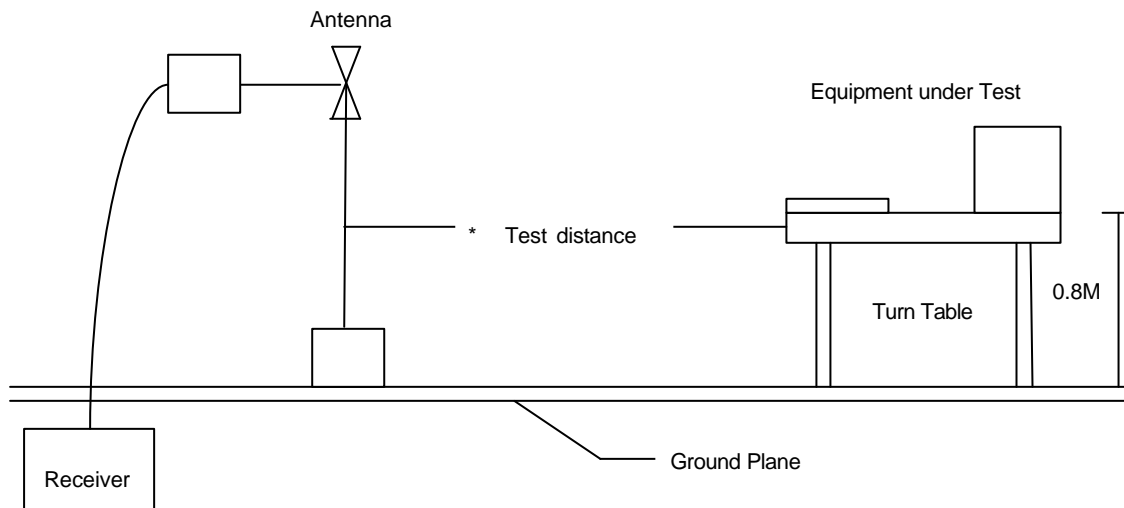



## 1.5. 6dB Bandwidth

### 1.5.1. Test Procedure :

1. The transmitter output was connected to the spectrum analyzer.
2. Set RBW of spectrum analyzer to 100 KHz and VBW to 100 KHz.
3. The 6 dB bandwidth is defined as the total spectrum the power of which is higher than peak power minus 6 dB.

### 1.5.2. Test Setup Layout :

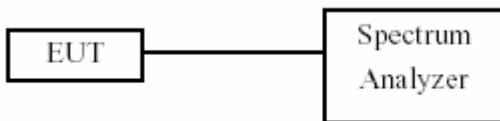

## 1.6. Maximum Peak Output Power

### 1.6.1. Test Procedure :

The antenna port ( RF output ) of the EUT was connected to the input ( RF input ) of a spectrum analyzer. Power was read directly from the meter and cable loss connection was added to the reading to obtain power at the EUT antenna terminal. The EUT Output Power was set to maximum to produce the worse case test result.

### 1.6.2. Test Setup Layout :

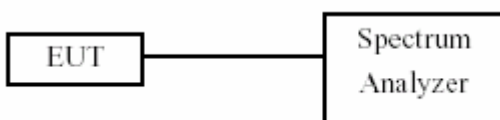

## 1.7. Band Edges Measurement

### 1.7.1. Test Procedure :

1. The transmitter output was connected to the spectrum analyzer via a low lose cable.
2. Set both RBW and VBW of spectrum analyzer to 100 KHz with convenient frequency span including 100 MHz bandwidth from band edge.
3. The band edges was measured and recorded.

## 1.8. Power Spectral Density

### 1.8.1. Test Procedure :

1. The transmitter output was connected to spectrum analyzer.
2. The spectrum analyzer' s resolution bandwidth were set at 3KHz RBW and 30KHz VBW as that of the fundamental frequency. Set the sweep time=span/3KHz.
3. The power spectral density was measured and recorded.
4. The Sweep time is allowed to be longer than span/3KHz for a full response of the mixer in the spectrum analyzer.

### 1.8.2. Test Setup Layout :

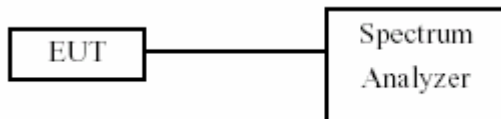

## 1.9. Restricted Bands of Operation

Only spurious emissions are permitted in any of the frequency bands listed below:

MHz	MHz	MHz	GHz
0.09000 – 0.11000	16.42000 – 16.42300	399.9 – 410.0	4.500 – 5.250
0.49500 – 0.505**	16.69475 – 16.69525	608.0 – 614.0	5.350 – 5.460
2.17350 – 2.19050	16.80425 – 16.80475	960.0 – 1240.0	7.250 – 7.750
4.12500 – 4.12800	25.50000 – 25.67000	1300.0 – 1427.0	8.025 – 8.500
4.17725 – 4.17775	37.50000 – 38.25000	1435.0 – 1626.5	9.000 – 9.200
4.20725 – 4.20775	73.00000 – 74.60000	1645.5 – 1646.5	9.300 – 9.500
6.21500 – 6.21800	74.80000 – 75.20000	1660.0 – 1710.0	10.600 – 12.700
6.26775 – 6.26825	108.00000 – 121.94000	1718.8 – 1722.2	13.250 – 13.400
6.31175 – 6.31225	123.00000 – 138.00000	2200.0 – 2300.0	14.470 – 14.500
8.29100 – 8.29400	149.90000 – 150.05000	2310.0 – 2390.0	15.350 – 16.200
8.36200 – 8.36600	156.52475 – 156.52525	2483.5 – 2500.0	17.700 – 21.400
8.37625 – 8.38675	156.70000 – 156.90000	2655.0 – 2900.0	22.010 – 23.120
8.41425 – 8.41475	162.01250 – 167.17000	3260.0 – 3267.0	23.600 – 24.000
12.29000 – 12.29300	167.72000 – 173.20000	3332.0 – 3339.0	31.200 – 31.800
12.51975 – 12.52025	240.00000 – 285.00000	3345.8 – 3358.0	36.430 – 36.500
12.57675 – 12.57725	322.00000 – 335.40000	3600.0 – 4400.0	Above 38.6
13.36000 – 13.41000			

\*\* : Until February 1, 1999, this restricted band shall be 0.490-0.510 MHz

## 1.10. Labeling Requirement

The device shall bear the following statement in a conspicuous location on the device:

This device complies with part 15 of the FCC Rules. Operation is subject to the following two conditions: (1) This device may not cause harmful interference, and (2) this device must accept any interference received, including interference that may cause undesired operation.

**1.11. RF Exposure**

FCC Rules and Regulations Part 1.1307, 1.1310, 2.1091, 2.1093:  
RF Exposure Compliance

1.11.1. Limit For Maximum Permissible Exposure (MPE)

(A) Limits for Occupational / Controlled Exposure

Frequency Range (MHz)	Electric Field Strength (E) (V/m)	Magnetic Field Strength (H) (A/m)	Power Density (S) (mW/ cm <sup>2</sup> )	Averaging Time  E  <sup>2</sup> , H  <sup>2</sup> or S (minutes)
0.3-3.0	614	1.63	(100)*	6
3.0-30	1842/f	4.89/f	(900/f)*	6
30-300	61.4	0.163	1.0	6
300-1500			F/300	6
1500-100,000			5	6

(B) Limits for General Population / Uncontrolled Exposure

Frequency Range (MHz)	Electric Field Strength (E) (V/m)	Magnetic Field Strength (H) (A/m)	Power Density (S) (mW/cm <sup>2</sup> )	Averaging Time  E  <sup>2</sup> , H  <sup>2</sup> or S ( minutes )
0.3-1.34	614	1.63	(100)*	30
1.34-30	824/f	2.19/f	(180/f)*	30
30-300	27.5	0.073	0.2	30
300-1500			F/1500	30
1500-100,000			1.0	30

F=frequency in MHz

\*Plane-wave equivalent power density

1.11.2. MPE Calculations

$$E \text{ (V/m)} = \frac{\sqrt{30 \cdot P \cdot G}}{d} \quad \text{Power Density: } Pd \text{ (mW/cm}^2\text{)} = \frac{E^2}{3770}$$

E = Electric field (V/m)

P = Peak output power (W)

G = Antenna numeric gain (numeric)

d = Separation distance (m)

Because the EUT is belong to General Population/ Uncontrolled Exposure. So the Limit of Power Density is 10 W/m<sup>2</sup>. We can change the formula to:

$$d = \sqrt{\frac{30 \cdot P \cdot G}{3770}}$$

1.11.3. FCC Radiation Exposure Statement

This equipment complies with FCC radiation exposure limits set forth for an uncontrolled environment. In order to avoid the possibility of exceeding the FCC radio frequency exposure limits, human proximity to the antenna shall not be less than 20cm (8 inches) during normal operation. Proposed RF exposure safety information to include in User' s Manual.

## 2. Test Configuration of Equipment under Test

### 2.1. Test Mode and Test Software

The following test mode and test software was performed for conduction and radiation test:

- 802.11b (CH LO: 2412MHz) • 802.11b (CH MID: 2437MHz) • 802.11b (CH HI: 2462MHz)
- 802.11g (CH LO: 2412MHz) • 802.11g (CH MID: 2437MHz) • 802.11g (CH HI: 2462MHz)
- An executive programs, "RT2500T" Application under WIN XP.

### 2.2. Description of Test System

Device	Model No.	Manufacturer	Description
Notebook	R40(2723-BV1)	IBM	Power Cord, Unshielding, 1.8m
AP Router(Remote site)	ARM914	AboCom	Power Cord, Unshielding, 1.8m

### 2.3. Connection Diagram of Test System

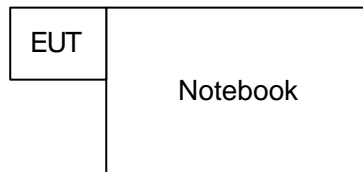

## 2.4. Feature of Equipment under Test

Chipset:	Ralink RT2560
RF Chip:	Ralink RT2525
Bus Type:	CardBus
Data Rates :	54, 48, 36, 24, 18, 12, 9, and 6 Mbps (802.11g) 11, 5.5, 2, 1 Mbps (802.11b)
Frequency Band :	2.4GHz to 2.462GHz
Wireless Medium :	DSSS and OFDM
Media Access Protocol:	CSMA/CA
Operating Channels:	1-14(FCC:1-11、 ETSI:1-13、 Japan:1-14 )
Operating Range:	Indoors: Up to 328 ft (100 meters) Outdoors: Up to 1312 ft (400 meters)
Receive Sensitivity :	802.11g (54 Mbps: -70 dBm, 48 Mbps: -72 dBm, 36 Mbps: -77 dBm, 24 Mbps: -80 dBm, 18 Mbps: -82 dBm, 12 Mbps: -85 dBm, 9 Mbps: -86 dBm, 6 Mbps: -88 dBm) 802.11b (11 Mbps: -86 dBm, 5.5 Mbps: -89 dBm, 2 Mbps: -91 dBm, 1 Mbps: -91 dBm)
Wireless Medium:	DSSS (Direct Sequence Spread Spectrum)
Media Access Protocol:	CSMA/CA
Transmit Power:	802.11g: 14±2 dBm, 802.11b: 16±2 dBm
Security :	64/128-bit WEP, WPA—Wi-Fi Protected Access
Standards Conformance:	WPA certified, IEEE 802.11g, IEEE 802.11b
Environmental Range:	Operating temperature: 0° to 40°C (32° to 104°F) Operating humidity: 0 to 90% non-condensing
System Requirements:	Notebook PC must be running Windows 98SE/ME/XP/ 2000

## 2.5. History of this test report

ORIGINAL.

### 3. General Information of Test

Test Site:	Exclusive Certification Corp. 4F-2, No. 28, Lane 78, Xing-Ai Rd. Nei-hu, Taipei City 114 Taiwan R.O.C.
Test Site Location (OATS1-SD):	No.68-1, Shihbachongsi, shihding Township, Taipei County 223, Taiwan, R.O.C.
Test Voltage:	AC 110V/ 60Hz
Test in Compliance with:	ANSI C63.4-1992 FCC Part 15 Subpart C
Frequency Range Investigated:	Conducted: from 150kHz to 30 MHz Radiation: from 30 MHz to 24620MHz
Test Distance:	The test distance of radiated emission from antenna to EUT is 10 M.



## 4. Test Result and Data

### 4.1. Antenna Requirement

#### 4.1.1. Antenna Construction and Directional Gain

Antenna type: The antenna is designed to be permanently on PCB,

No consideration of replacement.

Gain: 0 dBi.

4.2. Test Result of Conducted Emission

EUT : CB001R  
 Power : 110V 60Hz  
 Test Mode : 802.11b CH LO  
 Memo :

Pol/Phase : NEUTRAL  
 Temperature : 26 °C  
 Humidity : 63 %

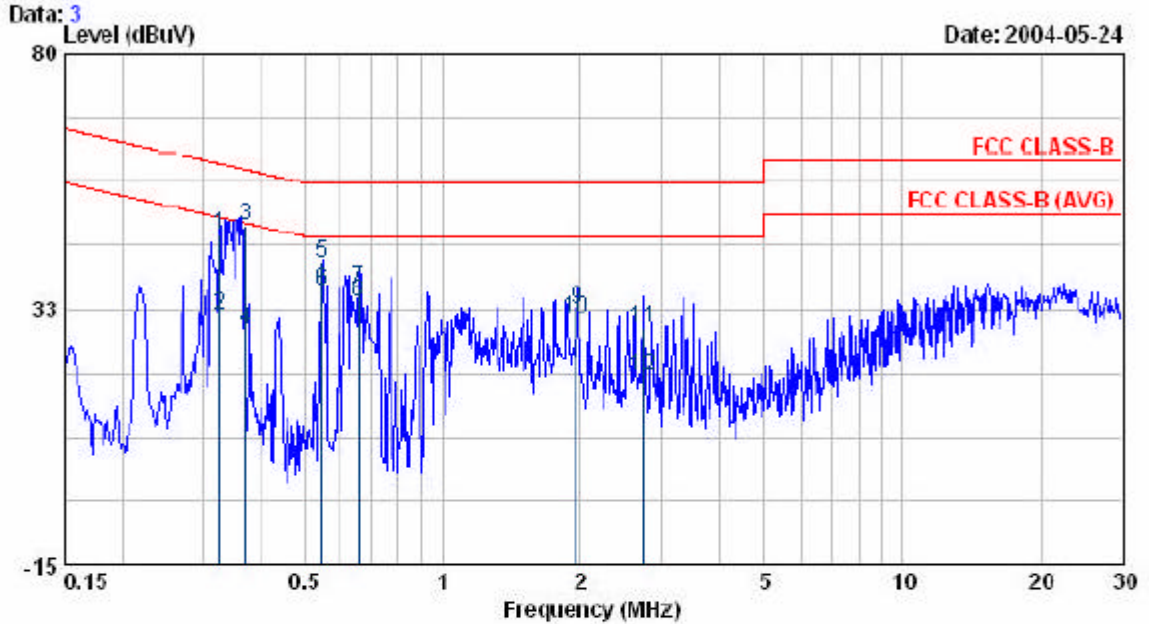

Freq	Read Level	Factor	Level	Limit	Over Limit	Remark
MHz	dBuV	dB	dBuV	dBuV	dBuV	
0.327	45.94	0.45	46.39	59.52	-13.14	QP
0.327	30.80	0.45	31.25	49.52	-18.28	AVERAGE
0.373	47.38	0.45	47.83	58.44	-10.61	QP
0.373	27.97	0.45	28.42	48.44	-20.02	AVERAGE
0.545	40.60	0.48	41.08	56.00	-14.92	QP
0.545	35.34	0.40	35.82	46.00	-10.18	AVERAGE
0.656	35.51	0.49	36.00	56.00	-20.00	QP
0.656	33.25	0.49	33.74	46.00	-12.26	AVERAGE
1.967	31.65	0.54	32.19	56.00	-23.81	QP
1.967	30.18	0.54	30.72	46.00	-15.28	AVERAGE
2.732	28.21	0.56	28.77	56.00	-27.23	QP
2.732	19.74	0.56	20.30	46.00	-25.70	AVERAGE

EUT : CB001R  
 Power : 110V 60Hz  
 Test Mode : 802.11b CH LO  
 Memo :

Pol/Phase : LINE  
 Temperature : 26 °C  
 Humidity : 63 %

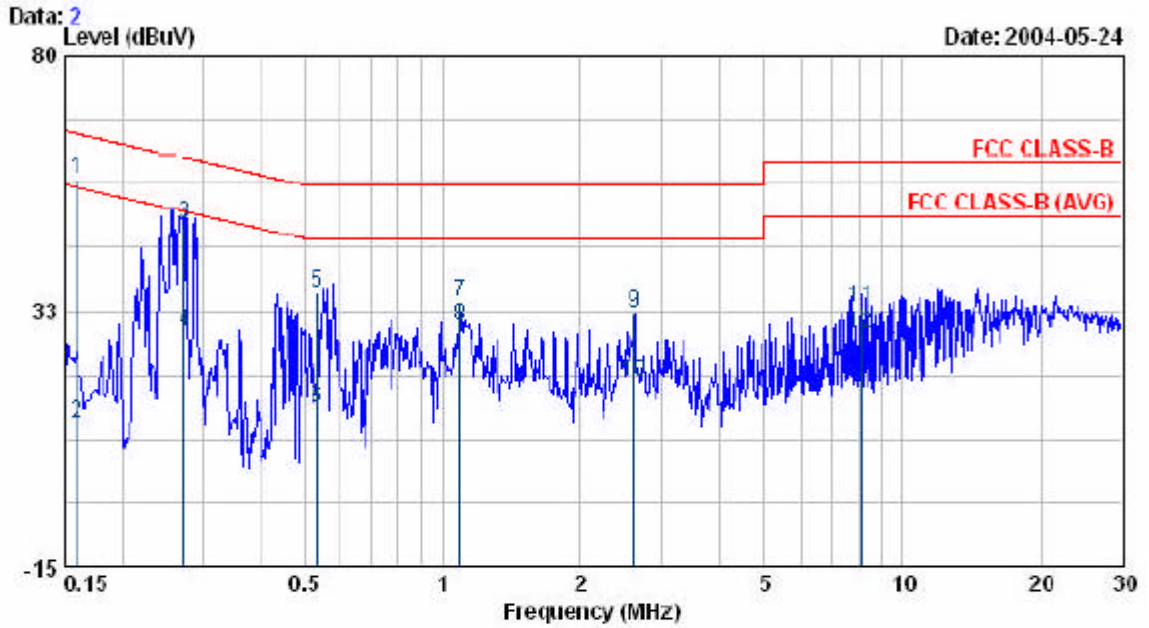

Freq	Read Level	Factor	Level	Limit	Over Limit	Remark
MHz	dBuV	dB	dBuV	dBuV	dBuV	
0.160	56.80	0.40	57.20	65.47	-8.27	QP
0.160	11.48	0.40	11.88	55.47	-43.59	AVERAGE
0.274	48.39	0.44	48.83	61.00	-12.17	QP
0.274	27.90	0.44	28.34	51.00	-22.66	AVERAGE
0.532	35.45	0.48	35.93	56.00	-20.07	QP
0.532	14.24	0.48	14.72	46.00	-31.28	AVERAGE
1.093	33.42	0.51	33.93	56.00	-22.07	QP
1.093	29.08	0.51	29.59	46.00	-16.41	AVERAGE
2.618	31.30	0.55	31.85	56.00	-24.15	QP
2.618	18.89	0.55	19.44	46.00	-26.56	AVERAGE
8.088	32.55	0.61	33.16	60.00	-26.84	QP
8.088	27.40	0.61	28.01	50.00	-21.99	AVERAGE

EUT : CB801R  
 Power : 110W 60Hz  
 Test Mode : 802.11b CH MID  
 Memo :

Pol/Phase : NEUTRAL  
 Temperature : 26 °C  
 Humidity : 63 %

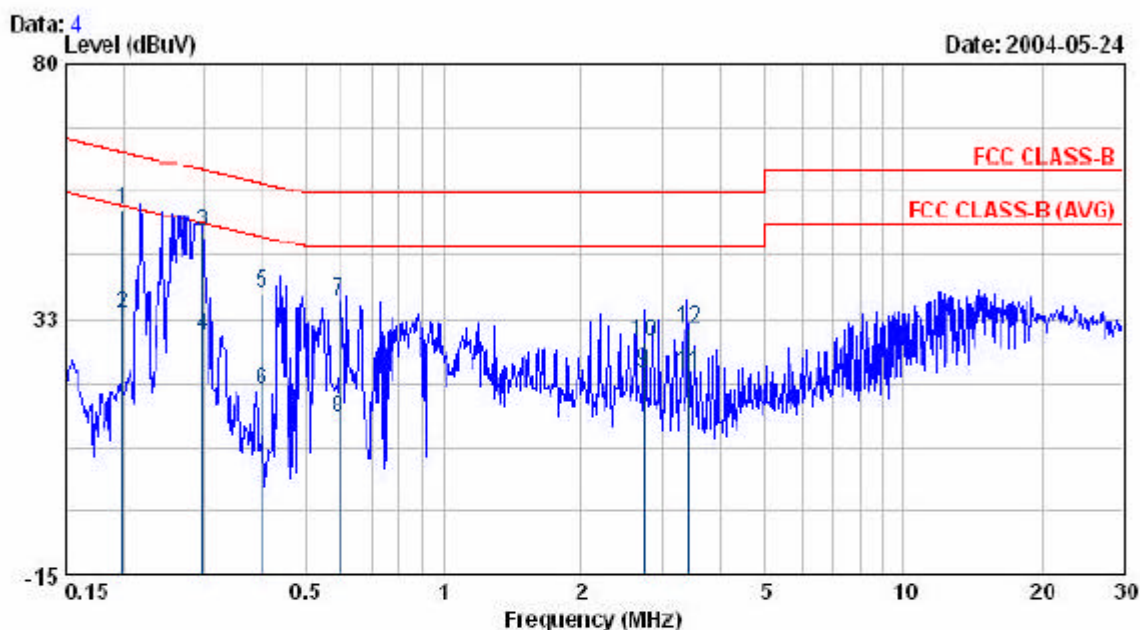

Freq	Read Level	Factor	Level	Limit	Over Limit	Remark
MHz	dBuV	dB	dBuV	dBuV	dBuV	
0.199	52.53	0.42	52.95	63.66	-10.71	QP
0.199	33.07	0.42	33.49	53.66	-20.17	AVERAGE
0.298	48.37	0.44	48.81	60.30	-11.48	QP
0.298	28.80	0.44	29.24	50.30	-21.05	AVERAGE
0.401	35.67	0.46	37.13	57.84	-20.71	QP
0.401	19.02	0.46	19.48	47.04	-28.36	AVERAGE
0.592	35.39	0.48	35.87	56.00	-20.13	QP
0.592	13.64	0.48	14.12	46.00	-31.88	AVERAGE
2.734	22.12	0.56	22.68	46.00	-23.32	AVERAGE
2.734	27.64	0.56	28.20	56.00	-27.80	QP
3.393	21.78	0.57	22.35	46.00	-23.65	AVERAGE
3.393	30.16	0.57	30.73	56.00	-25.27	QP

EUT	: CB001R	Pol/Phase	: LINE
Power	: 110V 60Hz	Temperature	: 26 °C
Test Mode	: 802.11b CH MID	Humidity	: 63 %
Memo	:		

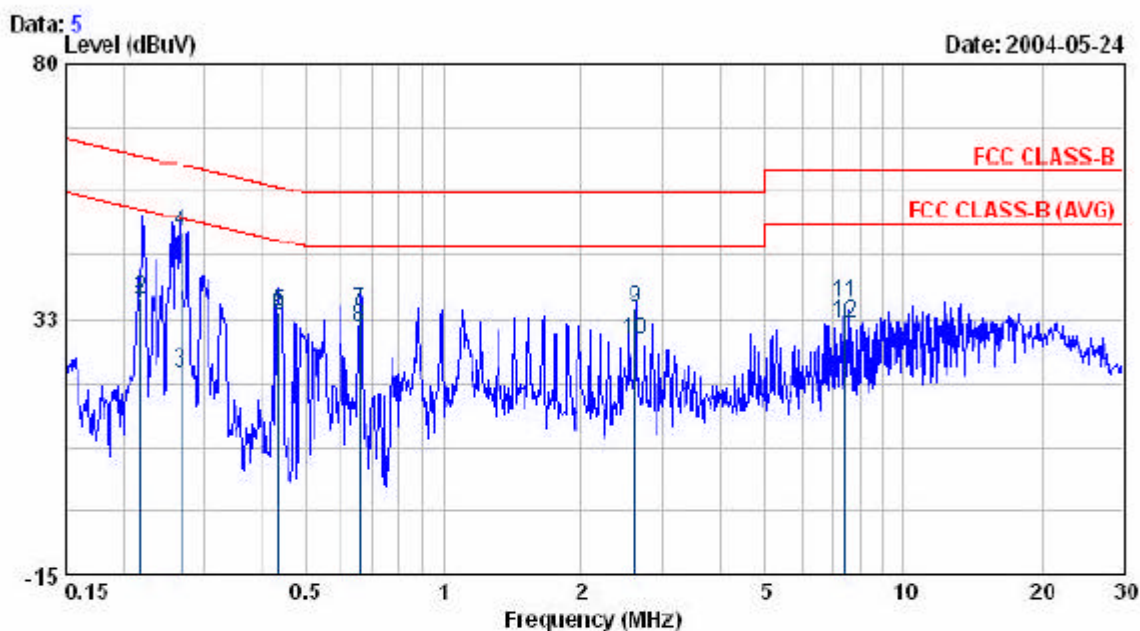

Freq	Read Level	Factor	Level	Limit	Over Limit	Remark
MHz	dBuV	dB	dBuV	dBuV	dBuV	
0.218	34.77	0.42	35.19	52.89	-17.69	AVERAGE
0.218	35.69	0.42	36.11	62.89	-26.77	QP
0.267	22.27	0.43	22.70	51.20	-28.50	AVERAGE
0.267	48.38	0.43	48.81	61.20	-12.39	QP
0.436	33.09	0.46	33.55	57.13	-23.58	QP
0.436	32.73	0.46	33.19	47.13	-13.94	AVERAGE
0.656	33.74	0.49	34.23	56.00	-21.77	QP
0.656	30.47	0.49	30.96	46.00	-15.04	AVERAGE
2.625	33.74	0.55	34.29	56.00	-21.71	QP
2.625	27.90	0.55	28.45	46.00	-17.55	AVERAGE
7.432	34.83	0.60	35.43	60.00	-24.57	QP
7.432	31.16	0.60	31.76	50.00	-18.24	AVERAGE

EUT : CB001R  
 Power : 110V 60Hz  
 Test Mode : 802.11b CH HI  
 Memo :

Pol/Phase : NEUTRAL  
 Temperature : 26 °C  
 Humidity : 63 %

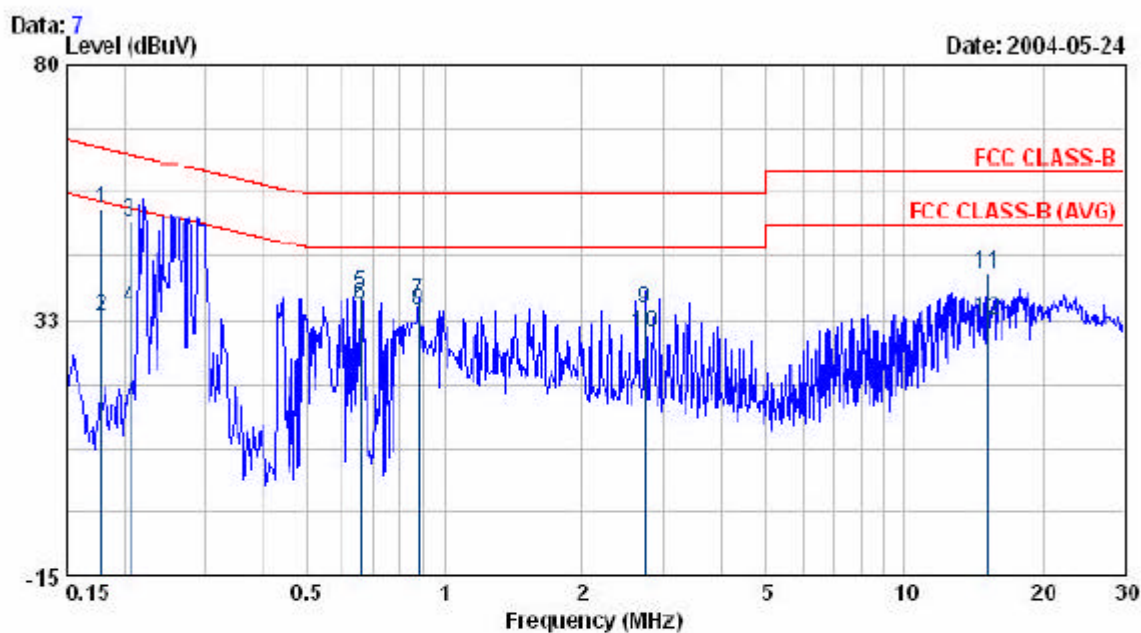

Freq	Read Level	Factor	Level	Limit	Over Limit	Remark
MHz	dBuV	dB	dBuV	dBuV	dBuV	
0.178	52.95	0.41	53.36	64.60	-11.24	QP
0.178	32.65	0.41	33.06	54.60	-21.54	AVERAGE
0.206	50.48	0.42	50.90	63.39	-12.49	QP
0.206	34.50	0.42	34.92	53.39	-18.47	AVERAGE
0.656	36.81	0.49	37.30	56.00	-18.70	QP
0.656	34.63	0.49	35.12	46.00	-10.88	AVERAGE
0.876	35.20	0.50	35.70	56.00	-20.30	QP
0.876	33.40	0.50	33.90	46.00	-12.10	AVERAGE
2.734	33.72	0.56	34.28	56.00	-21.72	QP
2.734	29.26	0.56	29.82	46.00	-16.18	AVERAGE
15.196	40.22	0.76	40.98	60.00	-19.02	QP
15.196	31.47	0.76	32.23	50.00	-17.77	AVERAGE

EUT : CB801R  
 Power : 110V 60Hz  
 Test Mode : 802.11b CH HI  
 Memo :

Pol/Phase : LINE  
 Temperature : 26 °C  
 Humidity : 63 %

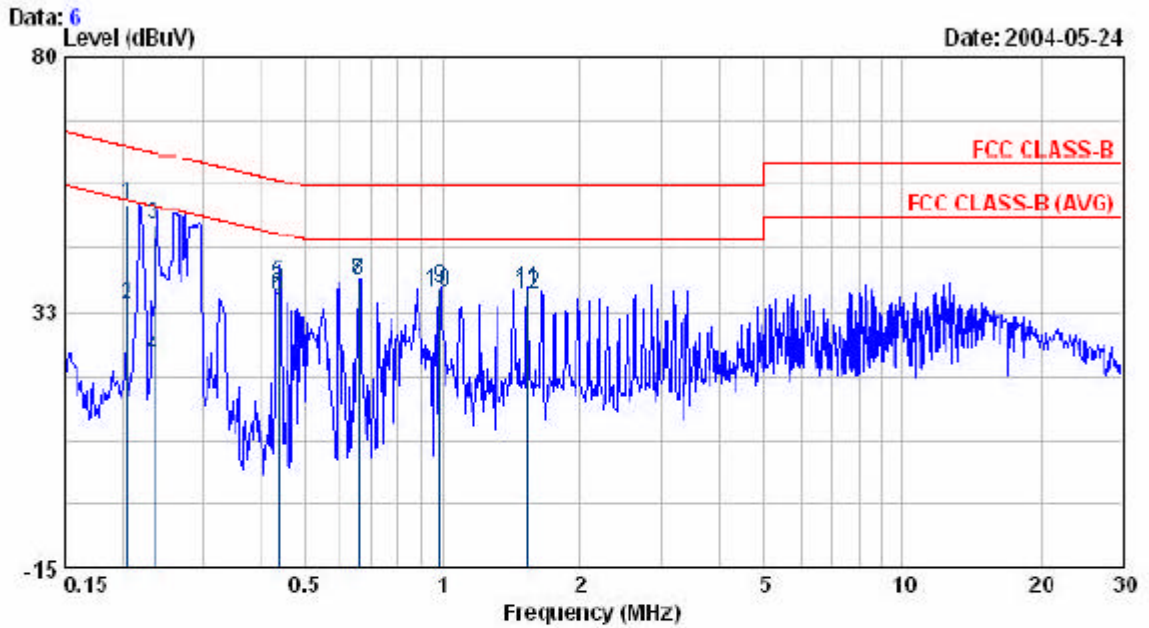

Freq	Read	Factor	Level	Limit	Over	Remark
MHz	dBuV	dB	dBuV	dBuV	dBuV	
0.205	52.11	0.42	52.53	63.42	-10.89	QP
0.205	33.39	0.42	33.81	53.42	-19.61	AVERAGE
0.234	48.33	0.43	48.76	62.30	-13.55	QP
0.234	23.57	0.43	24.00	52.30	-28.31	AVERAGE
0.437	37.22	0.46	37.68	57.11	-19.43	QP
0.437	34.96	0.46	35.42	47.11	-11.69	AVERAGE
0.656	37.84	0.49	38.33	56.00	-17.67	QP
0.656	37.61	0.49	38.10	46.00	-7.90	AVERAGE
0.983	36.23	0.51	36.74	56.00	-19.26	QP
0.983	35.50	0.51	36.01	46.00	-9.99	AVERAGE
1.531	35.94	0.53	36.47	56.00	-19.53	QP
1.531	35.27	0.53	35.80	46.00	-10.20	AVERAGE

EUT : CB801R  
 Power : 110V 60Hz(for notebook)  
 Test Mode : 802.11g CH L0  
 Memo :

Pol/Phase : NEUTRAL  
 Temperature : 26 °C  
 Humidity : 63 %

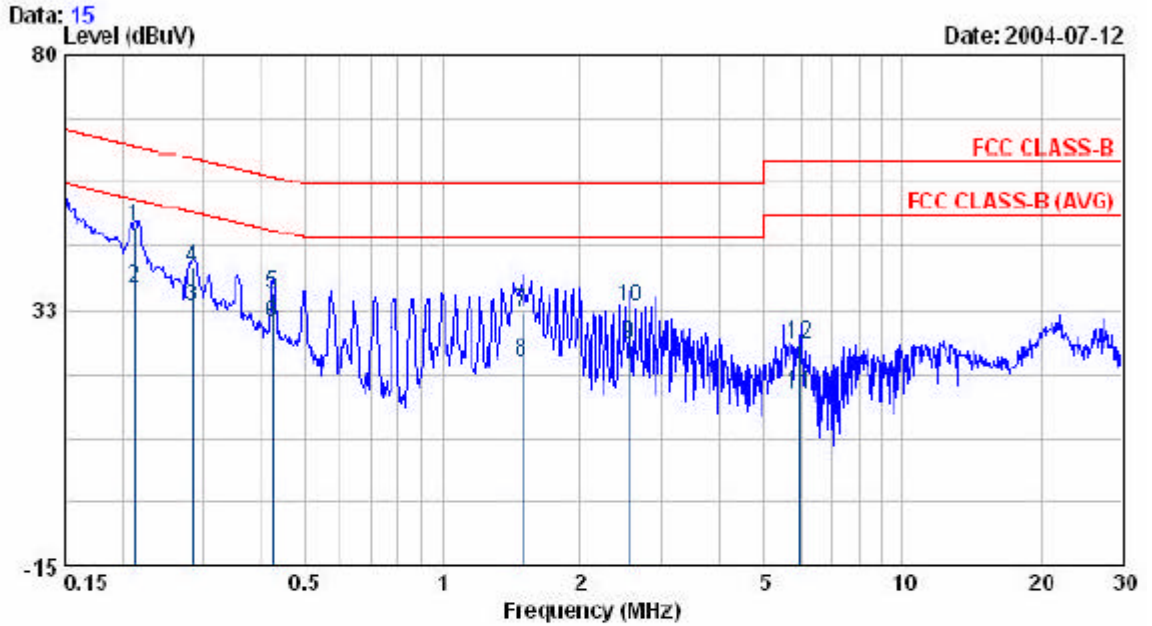

Freq	Read	Factor	Level	Limit	Over	Remark
MHz	dBuV	dB	dBuV	dBuV	dBuV	
0.213	47.58	0.42	48.00	63.08	-15.07	QP
0.213	36.20	0.42	36.62	53.08	-16.45	AVERAGE
0.285	32.50	0.44	32.94	50.67	-17.74	AVERAGE
0.285	39.91	0.44	40.35	60.67	-20.33	QP
0.426	34.85	0.46	35.31	57.33	-22.01	QP
0.426	29.30	0.46	29.76	47.33	-17.56	AVERAGE
1.487	31.43	0.53	31.96	56.00	-24.04	QP
1.487	22.47	0.53	23.00	46.00	-23.00	AVERAGE
2.559	25.49	0.55	26.04	46.00	-19.96	AVERAGE
2.559	32.43	0.55	32.98	56.00	-23.02	QP
5.977	16.29	0.64	16.93	50.00	-33.07	AVERAGE
5.977	25.57	0.64	26.21	60.00	-33.79	QP



EUT : CB801R  
 Power : 110V 60Hz (for notebook)  
 Test Mode : 802.11g CH L0  
 Memo :

Pol/Phase : LINE  
 Temperature : 26 °C  
 Humidity : 63 %

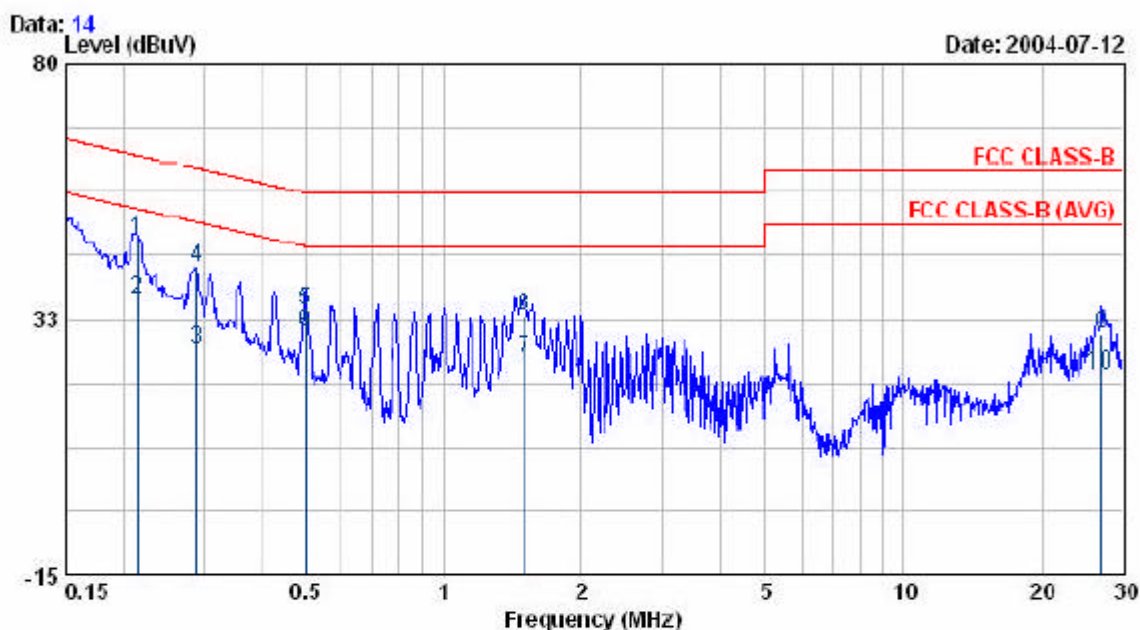

Freq	Read	Factor	Level	Limit	Over	Remark
MHz	dBuV	dB	dBuV	dBuV	dBuV	
0.216	46.80	0.42	47.22	62.98	-15.75	QP
0.216	35.70	0.42	36.12	52.98	-16.85	AVERAGE
0.289	26.20	0.44	26.64	50.54	-23.91	AVERAGE
0.289	41.70	0.44	42.14	60.54	-18.41	QP
0.499	33.60	0.47	34.07	56.01	-21.94	QP
0.499	29.31	0.47	29.70	46.01	-16.23	AVERAGE
1.503	24.39	0.53	24.92	46.00	-21.08	AVERAGE
1.503	32.50	0.53	33.03	56.00	-22.97	QP
26.837	28.35	1.25	29.60	60.00	-30.40	QP
26.837	21.00	1.25	22.25	50.00	-27.75	AVERAGE

EUT : CB001R  
 Power : 110V 60Hz(for notebook)  
 Test Mode : 802.11g CH MID  
 Memo :

Pol/Phase : NEUTRAL  
 Temperature : 26 °C  
 Humidity : 63 %

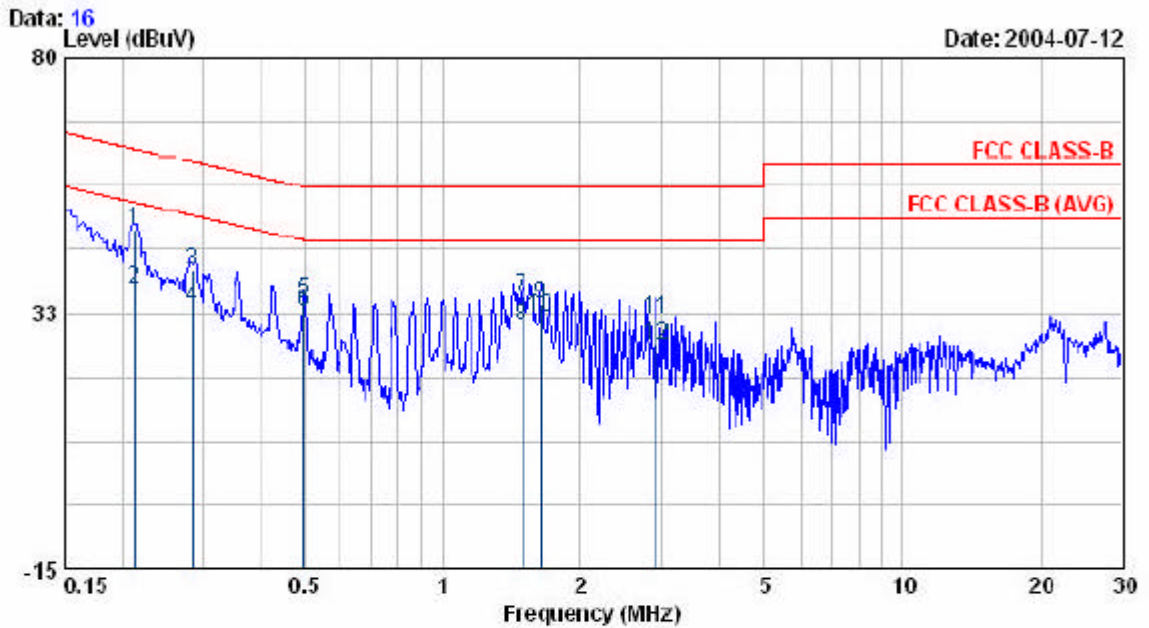

Freq	Read Level	Factor	Level	Limit	Over Limit	Remark
MHz	dBuV	dB	dBuV	dBuV	dBuV	
0.214	47.59	0.42	48.01	63.07	-15.06	QP
0.214	36.57	0.42	36.99	53.07	-16.08	AVERAGE
0.285	39.84	0.44	40.28	60.67	-20.39	QP
0.285	32.90	0.44	33.34	50.67	-17.33	AVERAGE
0.497	34.18	0.47	34.65	56.04	-21.39	QP
0.497	32.19	0.47	32.66	46.04	-13.38	AVERAGE
1.493	34.85	0.53	35.38	56.00	-20.62	QP
1.493	29.52	0.53	30.05	46.00	-15.95	AVERAGE
1.635	33.37	0.53	33.90	56.00	-22.10	QP
1.635	31.09	0.53	31.62	46.00	-14.38	AVERAGE
2.915	30.58	0.56	31.14	56.00	-24.86	QP
2.915	25.79	0.56	26.35	46.00	-19.65	AVERAGE

EUT : CB001R  
 Power : 110V 60Hz (for notebook)  
 Test Mode : 802.11g CH MID  
 Memo :

Pol/Phase : LINE  
 Temperature : 26 °C  
 Humidity : 63 %

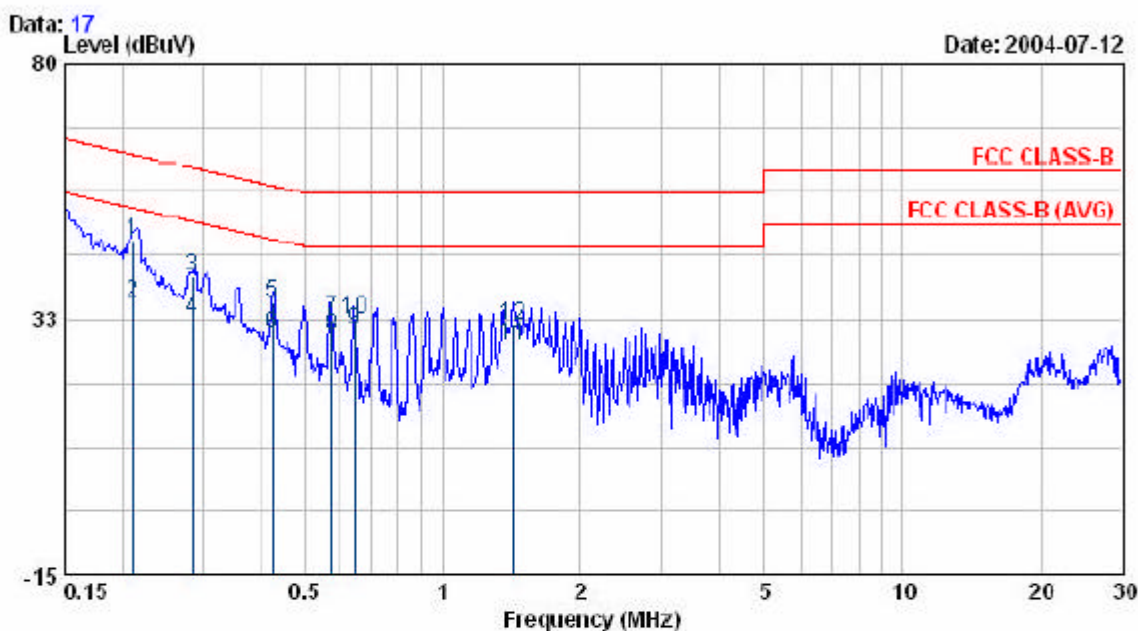

Freq	Read Level	Factor	Level	Limit	Over Limit	Remark
MHz	dBuV	dB	dBuV	dBuV	dBuV	
0.212	46.67	0.42	47.09	63.13	-16.04	QP
0.212	35.13	0.42	35.55	53.13	-17.58	AVERAGE
0.285	39.80	0.44	40.24	60.68	-20.44	QP
0.285	31.94	0.44	32.38	50.68	-18.30	AVERAGE
0.426	35.01	0.46	35.47	57.32	-21.85	QP
0.426	29.04	0.46	29.50	47.32	-17.82	AVERAGE
0.572	31.86	0.48	32.34	56.00	-23.66	QP
0.572	28.76	0.48	29.24	46.00	-16.76	AVERAGE
0.642	29.66	0.49	30.15	46.00	-15.85	AVERAGE
0.642	31.78	0.49	32.27	56.00	-23.73	QP
1.425	26.97	0.53	27.50	46.00	-18.50	AVERAGE
1.425	30.90	0.53	31.43	56.00	-24.57	QP

EUT : CB801R  
 Power : 110V 60Hz  
 Test Mode : 802.11g CH HI  
 Memo :

Pol/Phase : NEUTRAL  
 Temperature : 26 °C  
 Humidity : 63 %

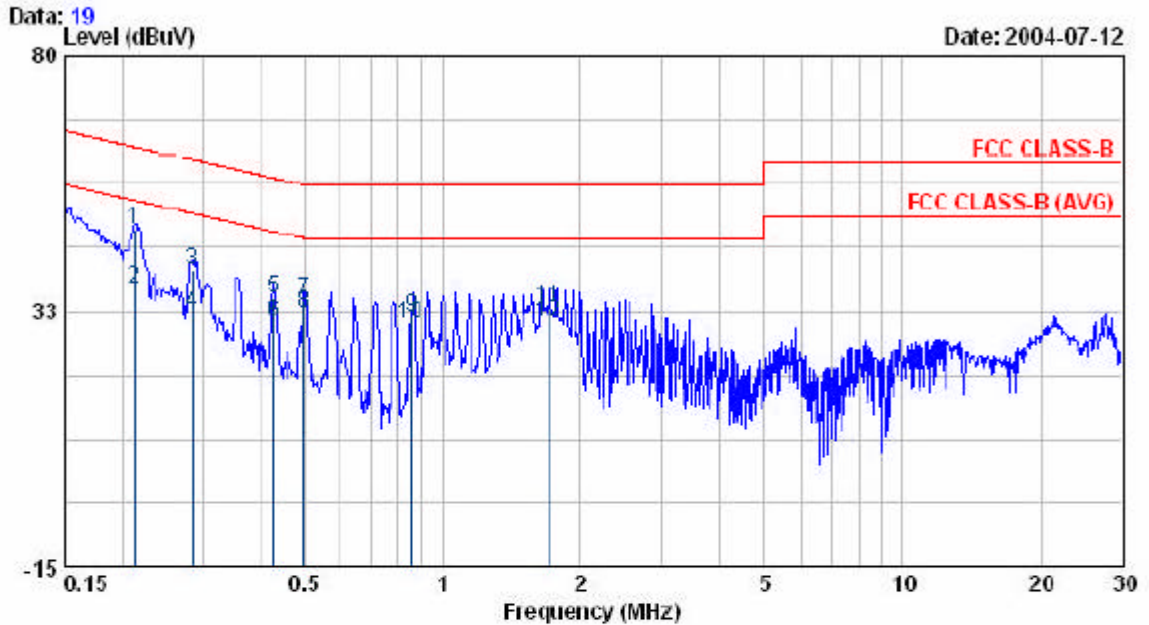

Freq	Read	Factor	Level	Limit	Over	Remark
MHz	dBuV	dB	dBuV	dBuV	dBuV	
0.214	47.13	0.42	47.55	63.05	-15.50	QP
0.214	36.00	0.42	36.42	53.05	-16.63	AVERAGE
0.285	39.49	0.44	39.93	60.66	-20.73	QP
0.285	31.52	0.44	31.96	50.66	-18.70	AVERAGE
0.428	34.35	0.46	34.81	57.30	-22.48	QP
0.428	29.73	0.46	30.19	47.30	-17.10	AVERAGE
0.498	34.03	0.47	34.50	56.03	-21.53	QP
0.498	31.68	0.47	32.15	46.03	-13.88	AVERAGE
0.856	30.81	0.50	31.31	56.00	-24.69	QP
0.856	29.37	0.50	29.87	46.00	-16.13	AVERAGE
1.709	32.48	0.53	33.02	56.00	-22.99	QP
1.709	29.85	0.53	30.39	46.00	-15.62	AVERAGE

EUT : CB001R  
 Power : 110V 60Hz (for notebook) Pol/Phase : LINE  
 Test Mode : 802.11g CH HI Temperature : 26 °C  
 Memo : Humidity : 63 %

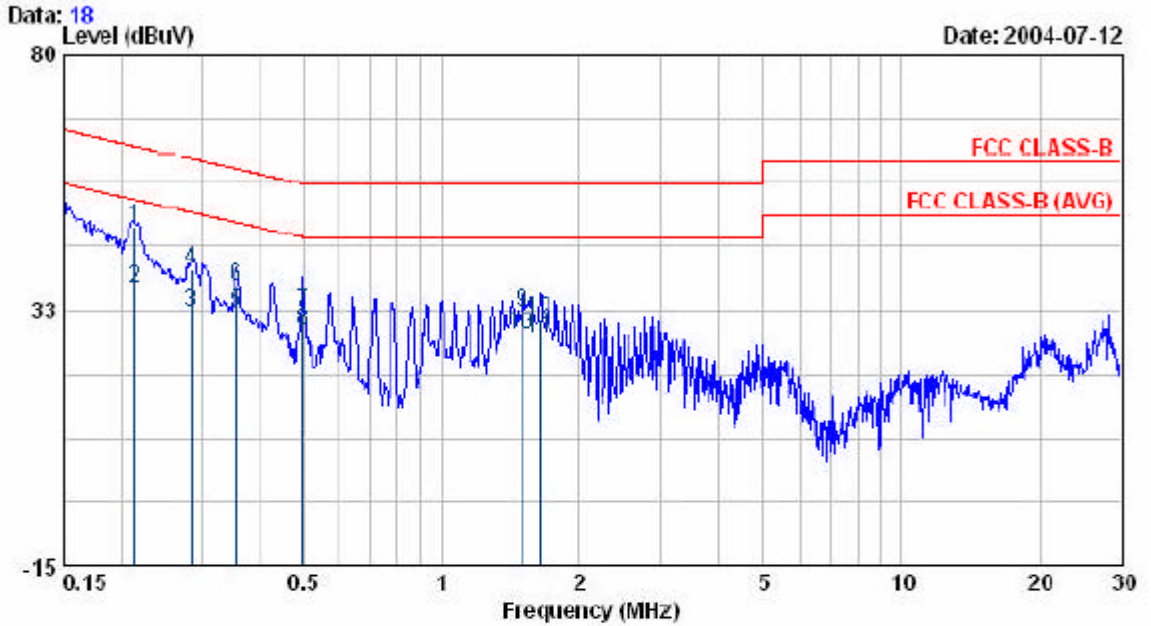

Freq	Read Level	Factor	Level	Limit	Over Limit	Remark
MHz	dBuV	dB	dBuV	dBuV	dBuV	
0.214	47.48	0.42	47.90	63.04	-15.14	QP
0.214	36.02	0.42	36.44	53.04	-16.60	AVERAGE
0.286	31.52	0.44	31.96	50.65	-18.69	AVERAGE
0.286	39.54	0.44	39.98	60.65	-20.67	QP
0.356	31.47	0.45	31.92	48.82	-16.90	AVERAGE
0.356	36.37	0.45	36.82	50.82	-22.00	QP
0.498	31.59	0.47	32.06	56.04	-23.98	QP
0.498	28.08	0.47	28.55	46.04	-17.49	AVERAGE
1.497	31.29	0.53	31.82	56.00	-24.18	QP
1.497	27.31	0.53	27.84	46.00	-18.16	AVERAGE
1.639	26.47	0.53	27.00	46.00	-19.00	AVERAGE
1.639	30.11	0.53	30.64	56.00	-25.36	QP

Test by: Carol

4.2.1. Photographs of Conducted Emission Test

FRONT VIEW



REAR VIEW

