

U11 (SAW Filter)	C21, C21	C342, C343	L18
TFS374A (Telefilter)	1.8pF	8.2pF	47nH
TB0152A (TAI-SAW)	1.5pF	5.6pF	33nH

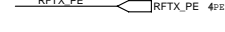

Sercomm Corporation			
Title			
CB801R			
Size	Document Number	Rev	
Custom	Transceiver RT2525	1.0	
Date:	Thursday, May 20, 2004	Sheet	2 of 5

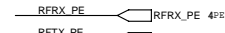
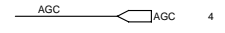
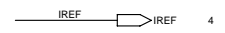
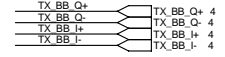
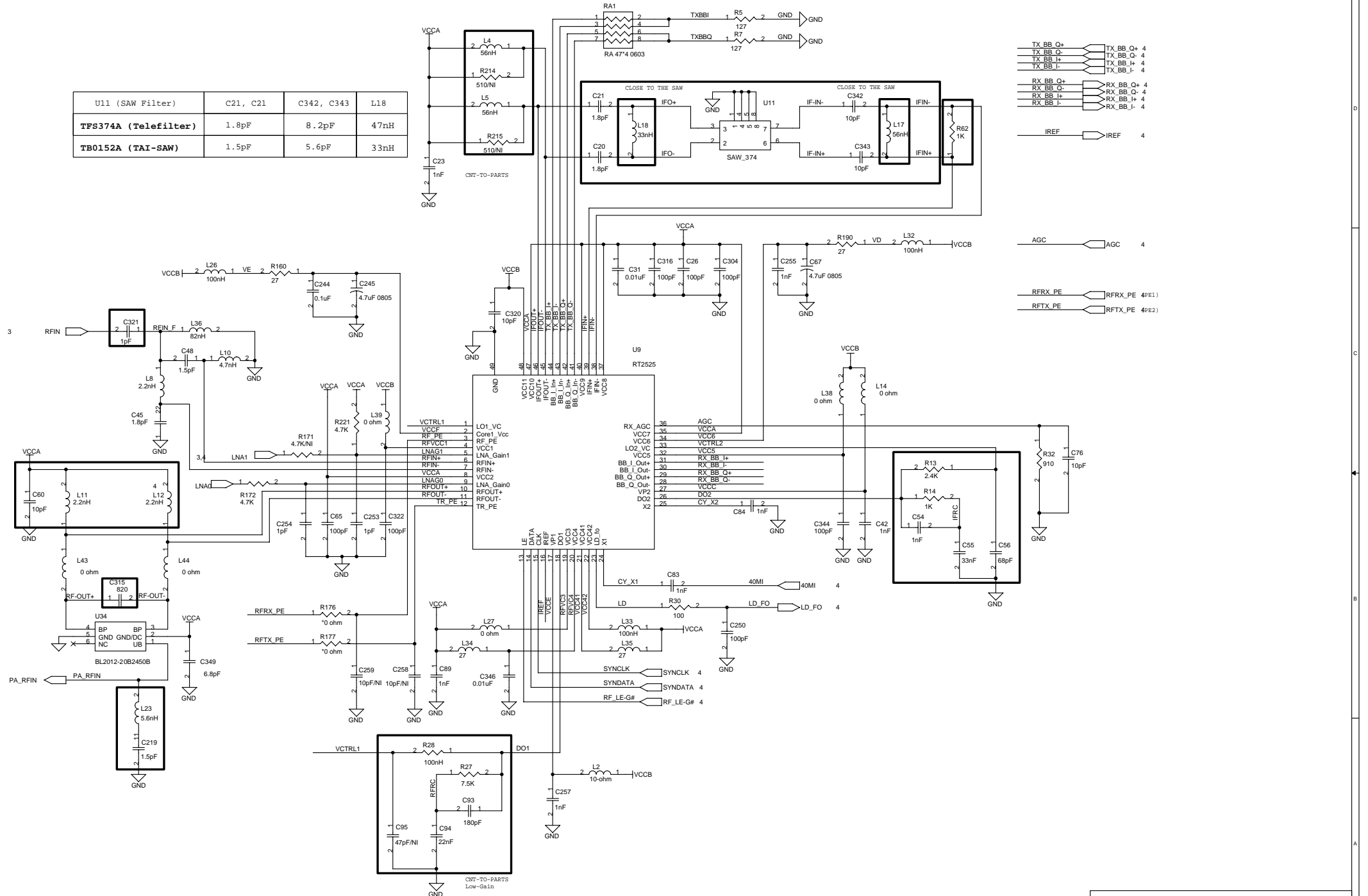
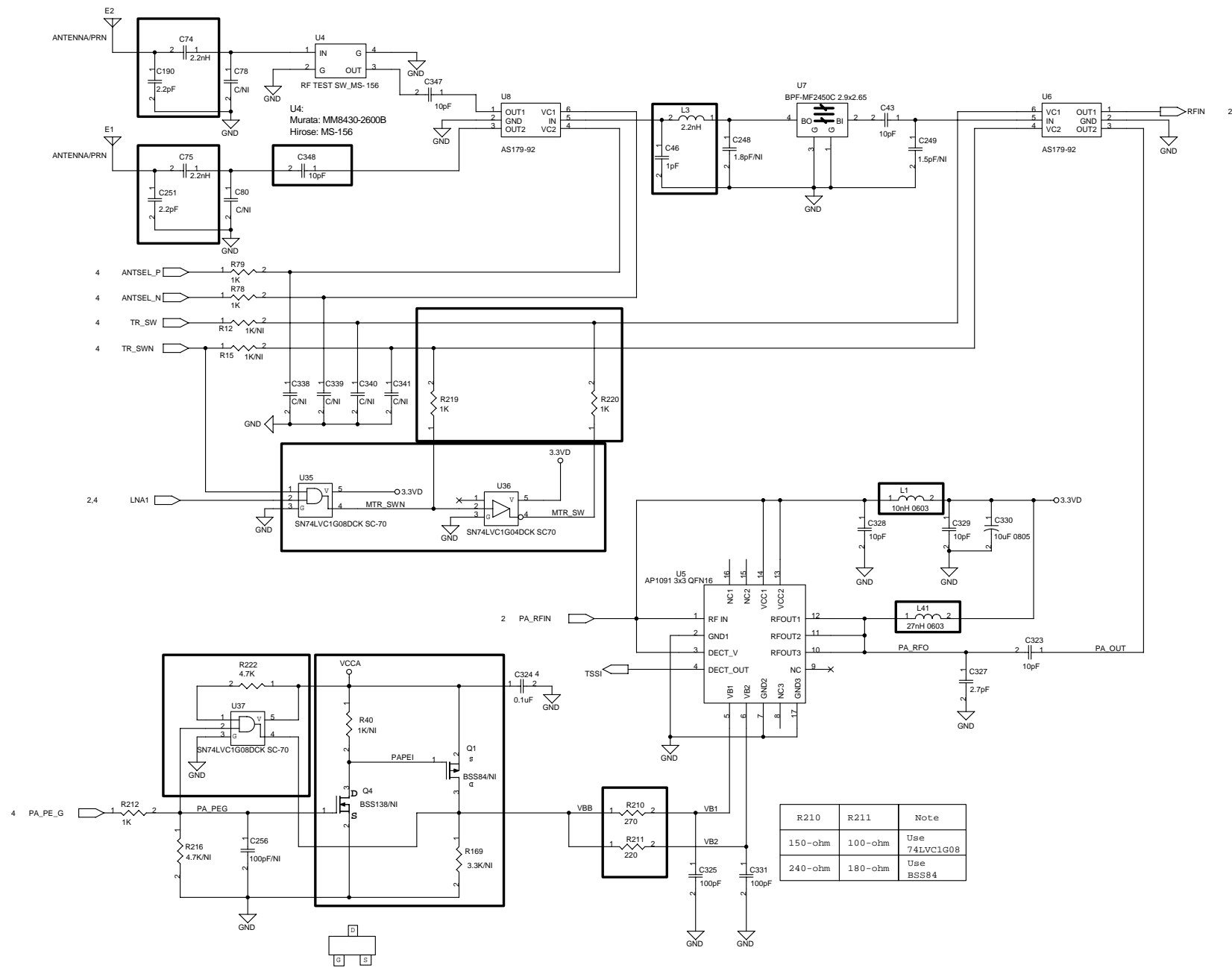

R210	R211	Note
150-ohm	100-ohm	Use 74LVC1G08
240-ohm	180-ohm	Use BSS84

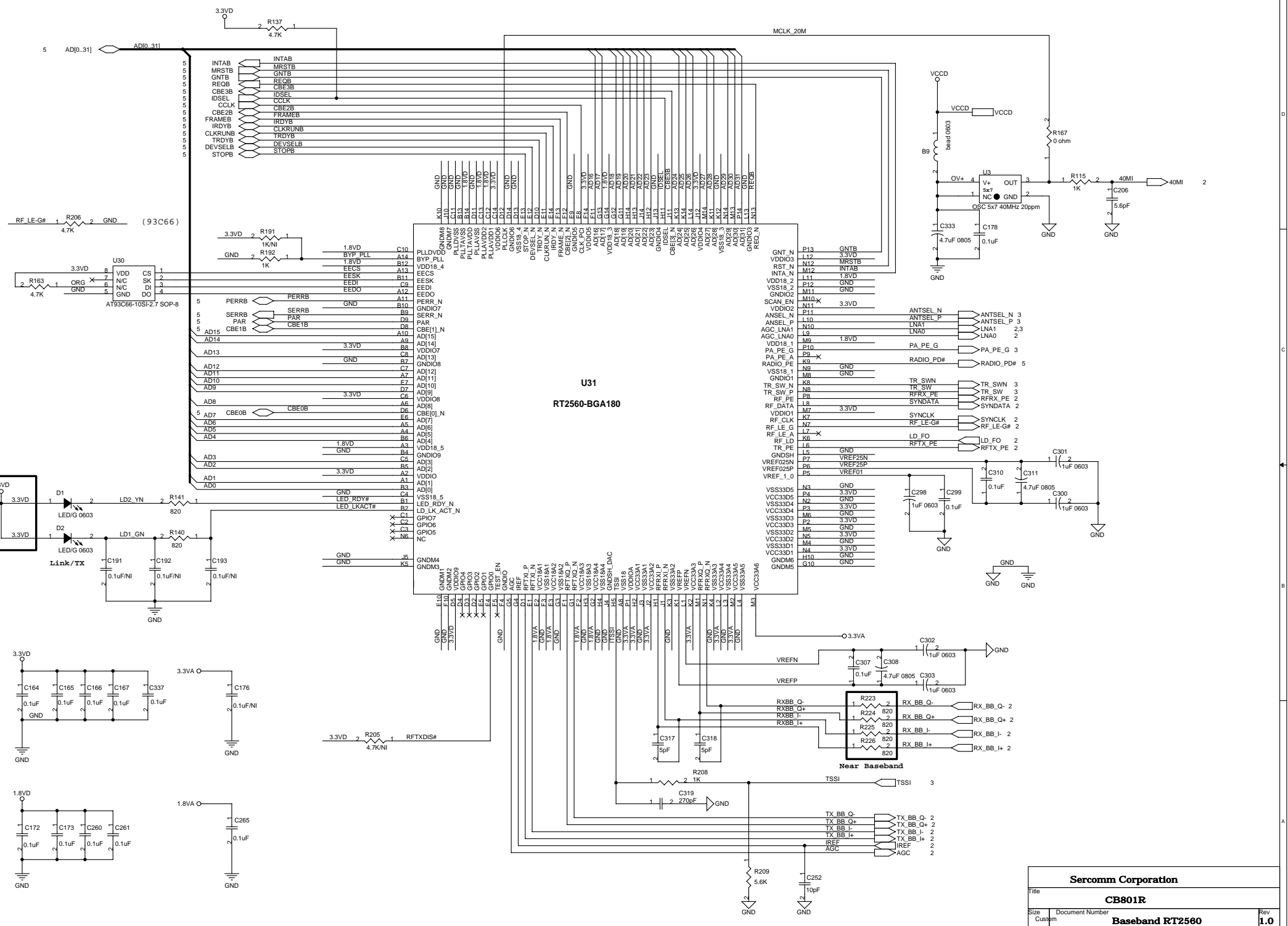

**U31
RT2560-BGA180**

GND	K10	GND	P13	GNTB
GND	K11	GND	L12	3.3V
GND	K12	GND	N12	MRSTB
GND	K13	GND	M12	INTAB
GND	K14	GND	L11	1.8V
GND	K15	GND	P12	GND
GND	K16	GND	M11	GND
GND	K17	GND	M10	X
GND	K18	GND	N11	3.3V
GND	K19	GND	P11	ANTSEL_N
GND	K20	GND	L10	ANTSEL_P
GND	K21	GND	N10	LNAT
GND	K22	GND	L9	LNAT
GND	K23	GND	M9	LNAT
GND	K24	GND	L8	LNAT
GND	K25	GND	M8	LNAT
GND	K26	GND	L7	LNAT
GND	K27	GND	M7	LNAT
GND	K28	GND	L6	LNAT
GND	K29	GND	M6	LNAT
GND	K30	GND	L5	LNAT
GND	K31	GND	M5	LNAT
GND	K32	GND	L4	LNAT
GND	K33	GND	M4	LNAT
GND	K34	GND	L3	LNAT
GND	K35	GND	M3	LNAT
GND	K36	GND	L2	LNAT
GND	K37	GND	M2	LNAT
GND	K38	GND	L1	LNAT
GND	K39	GND	M1	LNAT
GND	K40	GND	L0	LNAT
GND	K41	GND	M0	LNAT
GND	K42	GND	L0	LNAT
GND	K43	GND	M0	LNAT
GND	K44	GND	L0	LNAT
GND	K45	GND	M0	LNAT
GND	K46	GND	L0	LNAT
GND	K47	GND	M0	LNAT
GND	K48	GND	L0	LNAT
GND	K49	GND	M0	LNAT
GND	K50	GND	L0	LNAT
GND	K51	GND	M0	LNAT
GND	K52	GND	L0	LNAT
GND	K53	GND	M0	LNAT
GND	K54	GND	L0	LNAT
GND	K55	GND	M0	LNAT
GND	K56	GND	L0	LNAT
GND	K57	GND	M0	LNAT
GND	K58	GND	L0	LNAT
GND	K59	GND	M0	LNAT
GND	K60	GND	L0	LNAT
GND	K61	GND	M0	LNAT
GND	K62	GND	L0	LNAT
GND	K63	GND	M0	LNAT
GND	K64	GND	L0	LNAT
GND	K65	GND	M0	LNAT
GND	K66	GND	L0	LNAT
GND	K67	GND	M0	LNAT
GND	K68	GND	L0	LNAT
GND	K69	GND	M0	LNAT
GND	K70	GND	L0	LNAT
GND	K71	GND	M0	LNAT
GND	K72	GND	L0	LNAT
GND	K73	GND	M0	LNAT
GND	K74	GND	L0	LNAT
GND	K75	GND	M0	LNAT
GND	K76	GND	L0	LNAT
GND	K77	GND	M0	LNAT
GND	K78	GND	L0	LNAT
GND	K79	GND	M0	LNAT
GND	K80	GND	L0	LNAT
GND	K81	GND	M0	LNAT
GND	K82	GND	L0	LNAT
GND	K83	GND	M0	LNAT
GND	K84	GND	L0	LNAT
GND	K85	GND	M0	LNAT
GND	K86	GND	L0	LNAT
GND	K87	GND	M0	LNAT
GND	K88	GND	L0	LNAT
GND	K89	GND	M0	LNAT
GND	K90	GND	L0	LNAT
GND	K91	GND	M0	LNAT
GND	K92	GND	L0	LNAT
GND	K93	GND	M0	LNAT
GND	K94	GND	L0	LNAT
GND	K95	GND	M0	LNAT
GND	K96	GND	L0	LNAT
GND	K97	GND	M0	LNAT
GND	K98	GND	L0	LNAT
GND	K99	GND	M0	LNAT
GND	K100	GND	L0	LNAT

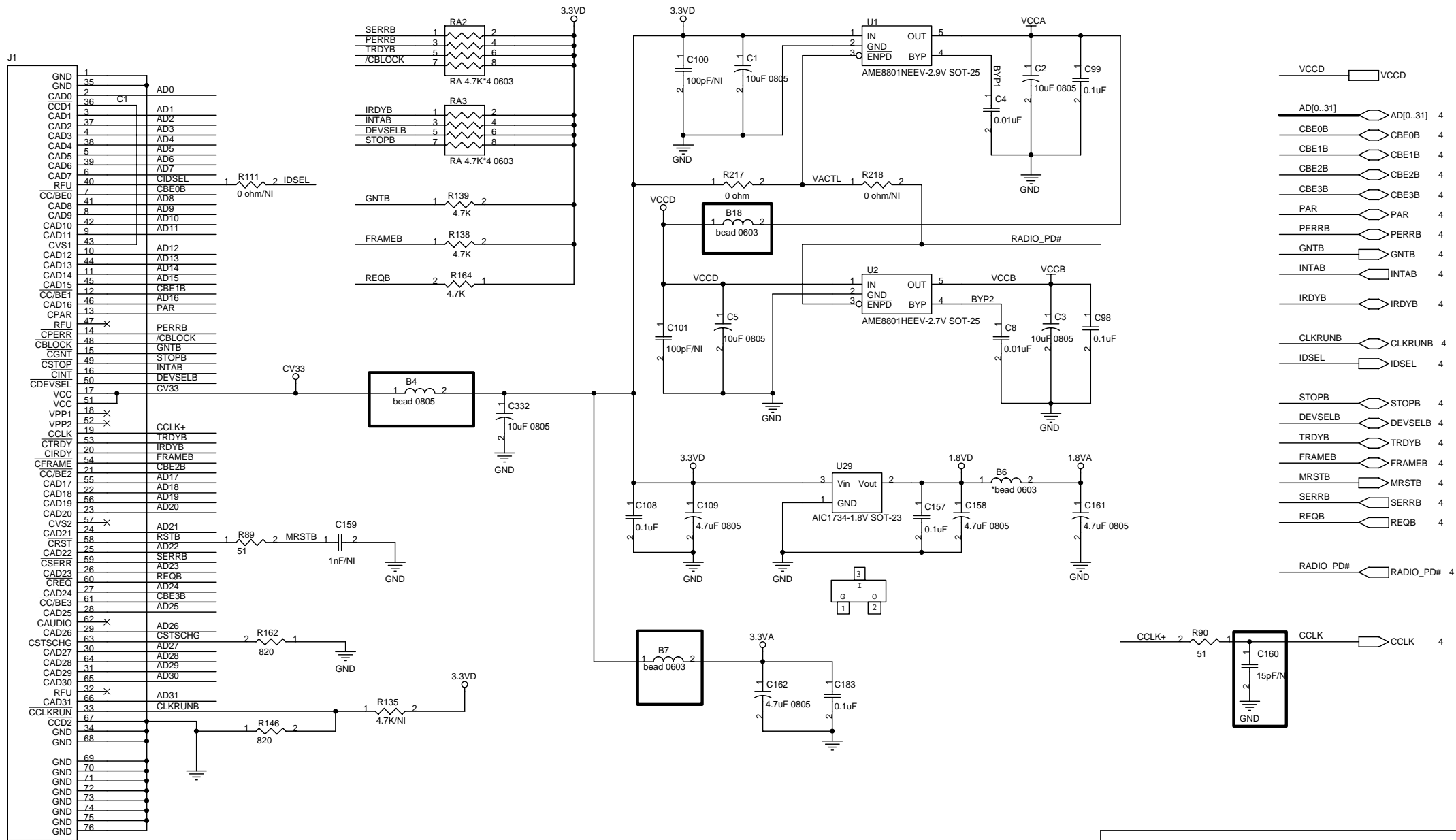

CON 68P-PC814-6830

Sercomm Corporation		
Title CB801R		
Size B	Document Number Connector & Power	Rev 1.0
Date: Thursday, May 20, 2004	Sheet 5	of 5