

FCC RADIO TEST REPORT

FCC 47 CFR PART 15 SUBPART C

| | |
|---------------------------------|--|
| Test Standard | FCC Part 15.247 |
| FCC ID | P27BC855 |
| Brand name | ADT |
| Product name | Wireless Full HD Battery Camera |
| Model No. | BC855xxxxxxx (the 1st x should be "blank" or "-"; the rest x could be 0 to 9, A to Z, a to z, "blank" or "-" , for marketing purpose) |
| Test Result | Pass |
| Statements of Conformity | Determination of compliance is based on the results of the compliance measurement, not taking into account measurement instrumentation uncertainty. |

The test Result was tested by Compliance Certification Services Inc. The test data, data evaluation, test procedures, and equipment configurations shown in this report were given in ANSI C63.10: 2013 and compliance standards.

The test results of this report relate only to the tested sample (EUT) identified in this report.

The test Report of full or partial shall not copy. Without written approval of Compliance Certification Services Inc. (Wugu Laboratory)

Approved by:

Tested by:



Kevin Tsai
Deputy Manager

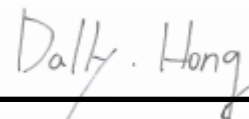

Dally Hong
Engineer

Unless otherwise stated the results shown in this test report refer only to the sample(s) tested and such sample(s) are retained for 90 days only.
除非另有說明，此報告結果僅對測試之樣品負責，同時此樣品僅保留90天。本報告未經本公司書面許可，不可部分複製。

This document is issued by the Company subject to its General Conditions of Service printed overleaf, available on request or accessible at www.sgs.com/terms_and_conditions.htm and for electronic format documents, subject to Terms and Conditions for Electronic Documents at www.sgs.com/terms_e-document.htm. Attention is drawn to the limitation of liability, indemnification and jurisdiction issues defined therein. Any holder of this document is advised that information contained hereon reflects the Company's findings at the time of its intervention only and within the limits of Client's instructions, if any. The Company's sole responsibility is to its Client and this document does not exonerate parties to a transaction from exercising all their rights and obligations under the transaction documents. This document cannot be reproduced except in full, without prior written approval of the Company. Any unauthorized alteration, forgery or falsification of the content or appearance of this document is unlawful and offenders may be prosecuted to the fullest extent of the law.



Report No.: T190711D17-RP

Page: 2 / 77

Rev.: 01

Revision History

| Rev. | Issue Date | Revisions | Effect Page | Revised By |
|------|--------------------|----------------------------------|-------------|------------|
| 00 | September 25, 2019 | Initial Issue | ALL | May Lin |
| 01 | October 23, 2019 | See the following Note Rev. (01) | P.4 | May Lin |

Rev (01):

1. *Modify the section 1.1.*



Table of contents

| | | |
|---------------------------------|---|----|
| 1. | GENERAL INFORMATION..... | 4 |
| 1.1 | EUT INFORMATION..... | 4 |
| 1.2 | EUT CHANNEL INFORMATION..... | 5 |
| 1.3 | ANTENNA INFORMATION..... | 5 |
| 1.4 | MEASUREMENT UNCERTAINTY | 6 |
| 1.5 | FACILITIES AND TEST LOCATION..... | 7 |
| 1.6 | INSTRUMENT CALIBRATION | 8 |
| 1.7 | SUPPORT AND EUT ACCESSORIES EQUIPMENT | 9 |
| 1.8 | TEST METHODOLOGY AND APPLIED STANDARDS..... | 9 |
| 2. | TEST SUMMERY..... | 10 |
| 3. | DESCRIPTION OF TEST MODES..... | 11 |
| 3.1 | THE WORST MODE OF OPERATING CONDITION | 11 |
| 3.2 | THE WORST MODE OF MEASUREMENT..... | 12 |
| 3.3 | EUT DUTY CYCLE | 13 |
| 4. | TEST RESULT..... | 14 |
| 4.1 | AC POWER LINE CONDUCTED EMISSION..... | 14 |
| 4.2 | 6dB BANDWIDTH AND OCCUPIED BANDWIDTH(99%) | 17 |
| 4.3 | OUTPUT POWER MEASUREMENT | 25 |
| 4.4 | POWER SPECTRAL DENSITY | 27 |
| 4.5 | CONDUCTED BANDEDGE AND SPURIOUS EMISSION..... | 32 |
| 4.6 | RADIATION BANDEDGE AND SPURIOUS EMISSION..... | 42 |
| APPENDIX 1 - PHOTOGRAPHS OF EUT | | |

Report No.: T190711D17-RP

1. GENERAL INFORMATION

1.1 EUT INFORMATION

| | |
|-------------------|--|
| Applicant | Sercomm Corporation 8F, No. 3-1, YuanQu St., NanKang, Taipei 115, Taiwan |
| Equipment | Wireless Full HD Battery Camera |
| Model Name | BC855xxxxxxxx (the 1st x should be "blank" or "-"; the rest x could be 0 to 9, A to Z, a to z, "blank" or "-", for marketing purpose) |
| Model Discrepancy | All the above models are identical except for the designation of model numbers. The suffix of (the 1st x should be "blank" or "-"; the rest x could be 0 to 9, A to Z, a to z, "blank" or "-") on model number is just for marketing purpose only. |
| Received Date | July 17, 2019 |
| Date of Test | July 31 ~ August 29, 2019 |
| Output Power (W) | IEEE 802.11b mode: 0.5152 IEEE 802.11g mode: 0.5495 IEEE 802.11n HT 20 mode: 0.5358 |
| Power Supply | Full HD Battery Camera: 4.2VDC from Battery Pack Battery Pack: I/P: 5VDC 2A from Adapter O/P: 3.4-4.2VDC 2A |
| Adapter | 1. PHIHONG / PSAF10A-050Q I/P: 100-240V~, 50/60Hz, 0.28A O/P: 5V, 2.0A 2. LUCENT TRAN / 1A52-UB52A I/P: 100-240V~, 0.3A, 50-60Hz O/P: 5V, 2.0A |

Report No.: T190711D17-RP

1.2 EUT CHANNEL INFORMATION

| | |
|--------------------|--|
| Frequency Range | 2412MHz-2462MHz |
| Modulation Type | 1. IEEE 802.11b Mode: DSSS(DBPSK/DQPSK/CCK) 2. IEEE 802.11g Mode: OFDM (BPSK/QPSK/16QAM/64QAM) 3. IEEE 802.11n HT20 Mode: OFDM (BPSK/QPSK/16QAM/64QAM) |
| Number of channels | 1. IEEE 802.11b Mode: 11 Channels 2. IEEE 802.11g Mode: 11 Channels 3. IEEE 802.11n HT 20 Mode: 11 Channels |

Remark:

Refer as ANSI C63.10: 2013 clause 5.6.1 Table 4 for test channels

| Number of frequencies to be tested | | |
|--|-----------------------|--|
| Frequency range in which device operates | Number of frequencies | Location in frequency range of operation |
| <input type="checkbox"/> 1 MHz or less | 1 | Middle |
| <input type="checkbox"/> 1 MHz to 10 MHz | 2 | 1 near top and 1 near bottom |
| <input checked="" type="checkbox"/> More than 10 MHz | 3 | 1 near top, 1 near middle, and 1 near bottom |

1.3 ANTENNA INFORMATION

| | |
|-------------------|--|
| Antenna Type | <input checked="" type="checkbox"/> PIFA <input type="checkbox"/> PCB <input type="checkbox"/> Dipole <input type="checkbox"/> Coils |
| Antenna Gain | Gain: 2.97dBi |
| Antenna Connector | I-PEX |

1.4 MEASUREMENT UNCERTAINTY

| PARAMETER | UNCERTAINTY |
|---------------------------------------|-------------|
| AC Powerline Conducted Emission | +/- 1.2575 |
| Emission bandwidth, 20dB bandwidth | +/- 0.0014 |
| RF output power, conducted | +/- 1.14 |
| Power density, conducted | +/- 1.40 |
| 3M Semi Anechoic Chamber / 30M~200M | +/- 4.12 |
| 3M Semi Anechoic Chamber / 200M~1000M | +/- 4.68 |
| 3M Semi Anechoic Chamber / 1G~8G | +/- 5.18 |
| 3M Semi Anechoic Chamber / 8G~18G | +/- 5.47 |
| 3M Semi Anechoic Chamber / 18G~26G | +/- 3.81 |
| 3M Semi Anechoic Chamber / 26G~40G | +/- 3.87 |

Remark:

1. This uncertainty represents an expanded uncertainty expressed at approximately the 95% confidence level using a coverage factor of $k=2$
2. ISO/IEC 17025 requires that an estimate of the measurement uncertainties associated with the emissions test results be included in the report.



Report No.: T190711D17-RP

Page: 7 / 77

Rev.: 01

1.5 FACILITIES AND TEST LOCATION

All measurement facilities used to collect the measurement data are located at
No.11, Wugong 6th Rd., Wugu Dist., New Taipei City 24891, Taiwan. (R.O.C.)

| Test site | Test Engineer | Remark |
|--------------------|---------------|--------|
| AC Conduction Room | Dally Hong | - |
| Radiation | Dally Hong | - |
| RF Conducted | Jerry Lu | - |

Remark: The sites are constructed in conformance with the requirements of ANSI C63.7, ANSI C63.4 and CISPR Publication 22.



Report No.: T190711D17-RP

1.6 INSTRUMENT CALIBRATION

| RF Conducted Test Site | | | | | |
|------------------------|--------------|---------|---------|------------|------------|
| Equipment | Manufacturer | Model | S/N | Cal Date | Cal Due |
| Power Meter | Anritsu | ML2495A | 1149001 | 02/12/2019 | 02/11/2020 |
| Power Sensor | Anritsu | MA2491A | 030982 | 02/12/2019 | 02/11/2020 |
| Signal Analyzer | R&S | FSV 40 | 101073 | 09/27/2018 | 09/26/2019 |
| Software | N/A | | | | |

| 3M 966 Chamber Test Site | | | | | |
|------------------------------|------------------|--------------------|------------|------------|------------|
| Equipment | Manufacturer | Model | S/N | Cal Date | Cal Due |
| Band Reject Filters | MICRO TRONICS | BRM 50702 | 120 | 02/26/2019 | 02/25/2020 |
| Bilog Antenna | Sunol Sciences | JB3 | A030105 | 07/26/2019 | 07/25/2020 |
| Cable | HUBER SUHNER | SUCOFLEX 104PEA | 25157 | 02/26/2019 | 02/25/2020 |
| Cable | HUBER SUHNER | SUCOFLEX 104PEA | 20995 | 02/26/2019 | 02/25/2020 |
| Digital Thermo-Hygro Meter | WISEWIND | 1206 | D07 | 01/30/2019 | 01/29/2020 |
| Horn Antenna | ETS LINDGREN | 3117 | 00143280 | 07/16/2019 | 07/15/2020 |
| Loop Ant | COM-POWER | AL-130 | 121051 | 03/22/2019 | 03/21/2020 |
| Pre-Amplifier | EMEC | EM330 | 060609 | 02/26/2019 | 02/25/2020 |
| Pre-Amplifier | HP | 8449B | 3008A00965 | 02/26/2019 | 02/25/2020 |
| PSA Series Spectrum Analyzer | Agilent | E4446A | MY46180323 | 05/29/2019 | 05/28/2020 |
| Antenna Tower | CCS | CC-A-1F | N/A | N.C.R | N.C.R |
| Controller | CCS | CC-C-1F | N/A | N.C.R | N.C.R |
| Turn Table | CCS | CC-T-1F | N/A | N.C.R | N.C.R |
| Software | e3 6.11-20180413 | | | | |

| AC Conducted Emissions Test Site | | | | | |
|----------------------------------|--------------------|-----------|----------|------------|------------|
| Equipment | Manufacturer | Model | S/N | Cal Date | Cal Due |
| CABLE | EMCI | CFD300-NL | CERF | 06/27/2019 | 06/26/2020 |
| EMI Test Receiver | R&S | ESCI | 100064 | 07/26/2019 | 07/25/2020 |
| LISN | SCHWARZBECK | NSLK 8127 | 8127-541 | 01/31/2019 | 01/30/2020 |
| LISN | SCHAFFNER | NNB 41 | 03/10013 | 02/13/2019 | 02/12/2020 |
| Software | EZ-EMC(CCS-3A1-CE) | | | | |

Remark: Each piece of equipment is scheduled for calibration once a year.



1.7 SUPPORT AND EUT ACCESSORIES EQUIPMENT

| EUT Accessories Equipment | | | | | |
|---------------------------|-----------|-------|-------|------------|--------|
| No. | Equipment | Brand | Model | Series No. | FCC ID |
| | N/A | | | | |

| Support Equipment | | | | | |
|-------------------|-----------|-------|-------|------------|--------|
| No. | Equipment | Brand | Model | Series No. | FCC ID |
| | N/A | | | | |

1.8 TEST METHODOLOGY AND APPLIED STANDARDS

The test methodology, setups and results comply with all requirements in accordance with ANSI C63.10:2013, FCC Part 2, FCC Part 15.247, KDB 558074 D01



Report No.: T190711D17-RP

Page: 10 / 77

Rev.: 01

2. TEST SUMMERY

| FCC Standard Section | Report Section | Test Item | Result |
|----------------------|----------------|-----------------------------|--------|
| 15.203 | 1.3 | Antenna Requirement | Pass |
| 15.207(a) | 4.1 | AC Conducted Emission | Pass |
| 15.247(a)(2) | 4.2 | 6 dB Bandwidth | Pass |
| - | 4.2 | Occupied Bandwidth (99%) | Pass |
| 15.247(b)(3) | 4.3 | Output Power Measurement | Pass |
| 15.247(e) | 4.4 | Power Spectral Density | Pass |
| 15.247(d) | 4.5 | Conducted Band Edge | Pass |
| 15.247(d) | 4.5 | Conducted Spurious Emission | Pass |
| 15.247(d) | 4.6 | Radiation Band Edge | Pass |
| 15.247(d) | 4.6 | Radiation Spurious Emission | Pass |

3. DESCRIPTION OF TEST MODES

3.1 THE WORST MODE OF OPERATING CONDITION

| | |
|---------------------------------|---|
| <p>Operation mode</p> | <p>IEEE 802.11b mode :1Mbps IEEE 802.11g mode :6Mbps IEEE 802.11n HT20 mode: MCS0</p> |
| <p>Test Channel Frequencies</p> | <p>IEEE 802.11b mode: 1. Lowest Channel: 2412MHz 2. Middle Channel: 2437MHz 3. Highest Channel: 2462MHz IEEE 802.11g mode: 1. Lowest Channel: 2412MHz 2. Middle Channel: 2437MHz 3. Highest Channel: 2462MHz IEEE 802.11n HT20 mode: 1. Lowest Channel: 2412MHz 2. Middle Channel: 2437MHz 3. Highest Channel: 2462MHz</p> |
| <p>Operation Transmitter</p> | <p>IEEE 802.11b mode :1T1R IEEE 802.11g mode :1T1R IEEE 802.11n HT20 mode :1T1R</p> |

Remark:

1. EUT pre-scanned data rate of output power for each mode, the worst data rate were recorded in this report.

Report No.: T190711D17-RP

3.2 THE WORST MODE OF MEASUREMENT

| AC Power Line Conducted Emission | |
|----------------------------------|---|
| Test Condition | AC Power line conducted emission for line and neutral |
| Power supply Mode | Mode 1: EUT power by Adapter (LUCENT) + Battery (1.3A&450mA) Mode 2: EUT power by Adapter (PHIHONG) + Battery (1.3A&450mA) |
| Worst Mode | <input type="checkbox"/> Mode 1 <input checked="" type="checkbox"/> Mode 2 |

| Radiated Emission Measurement Above 1G | |
|--|---|
| Test Condition | Band edge, Emission for Unwanted and Fundamental |
| Power supply Mode | Mode 1: EUT power by Battery (1.3A&450mA) Mode 2: EUT power by Adapter (LUCENT) + Battery (1.3A&450mA) Mode 3: EUT power by Adapter (PHIHONG) + Battery (1.3A&450mA) |
| Worst Mode | <input checked="" type="checkbox"/> Mode 1 <input type="checkbox"/> Mode 2 <input type="checkbox"/> Mode 3 |
| Worst Position | <input type="checkbox"/> Placed in fixed position. <input type="checkbox"/> Placed in fixed position at X-Plane (E2-Plane) <input type="checkbox"/> Placed in fixed position at Y-Plane (E1-Plane) <input checked="" type="checkbox"/> Placed in fixed position at Z-Plane (H-Plane) |
| Worst Polarity | <input type="checkbox"/> Horizontal <input checked="" type="checkbox"/> Vertical |

| Radiated Emission Measurement Below 1G | |
|--|--|
| Test Condition | Radiated Emission Below 1G |
| Power supply Mode | Mode 1: EUT power by Battery (1.3A&450mA) Mode 2: EUT power by Adapter (LUCENT) + Battery (1.3A&450mA) Mode 3: EUT power by Adapter (PHIHONG) + Battery (1.3A&450mA) |
| Worst Mode | <input checked="" type="checkbox"/> Mode 1 <input type="checkbox"/> Mode 2 <input type="checkbox"/> Mode 3 |

Remark:

1. The worst mode was record in this test report.
2. EUT pre-scanned in three axis, X, Y, Z and two polarity, Horizontal and Vertical for radiated measurement. The worst case (Z-Plane and Vertical) were recorded in this report
3. AC power line conducted emission and for below 1G radiation emission were performed the EUT transmit at the highest output power channel as worse case.

Report No.: T190711D17-RP

3.3 EUT DUTY CYCLE

| Duty Cycle | | | |
|---------------|------------|-------------|----------------|
| Configuration | TX ON (ms) | TX ALL (ms) | Duty Cycle (%) |
| 802.11b | 8.6667 | 8.6957 | 99.67% |
| 802.11g | 1.4928 | 1.5652 | 95.37% |
| 802.11n HT20 | 1.971 | 2.029 | 97.14% |



4. TEST RESULT

4.1 AC POWER LINE CONDUCTED EMISSION

4.1.1 Test Limit

According to §15.207(a)(2)

| Frequency Range (MHz) | Limits(dBμV) | |
|-----------------------|--------------|-----------|
| | Quasi-peak | Average |
| 0.15 to 0.50 | 66 to 56* | 56 to 46* |
| 0.50 to 5 | 56 | 46 |
| 5 to 30 | 60 | 50 |

* Decreases with the logarithm of the frequency.

4.1.2 Test Procedure

Test method Refer as ANSI C63.10: 2013 clause 6.2,

1. The EUT was placed on a non-conducted table, which is 0.8m above horizontal ground plane and 0.4m above vertical ground plane.
2. EUT connected to the line impedance stabilization network (LISN)
3. Receiver set RBW of 9kHz and Detector Peak, and note as quasi-peak and average.
4. Maximum procedure was performed on the six highest emissions to ensure EUT compliance.
5. Recorded Line for Neutral and Line.

4.1.3 Test Setup

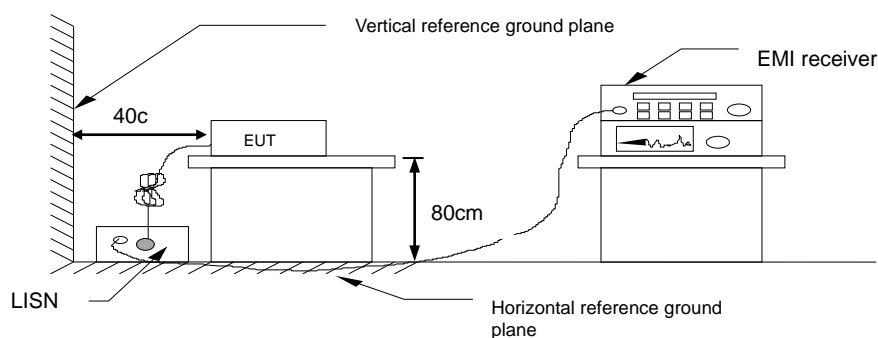

4.1.4 Test Result

Pass.

Report No.: T190711D17-RP

Test Data

| | | | |
|------------|--------|---------------|---------------|
| Test Mode: | Mode 2 | Temp/Hum | 24(°C)/ 50%RH |
| Phase: | Line | Test Date | 2019/08/29 |
| | | Test Engineer | Dally Hong |

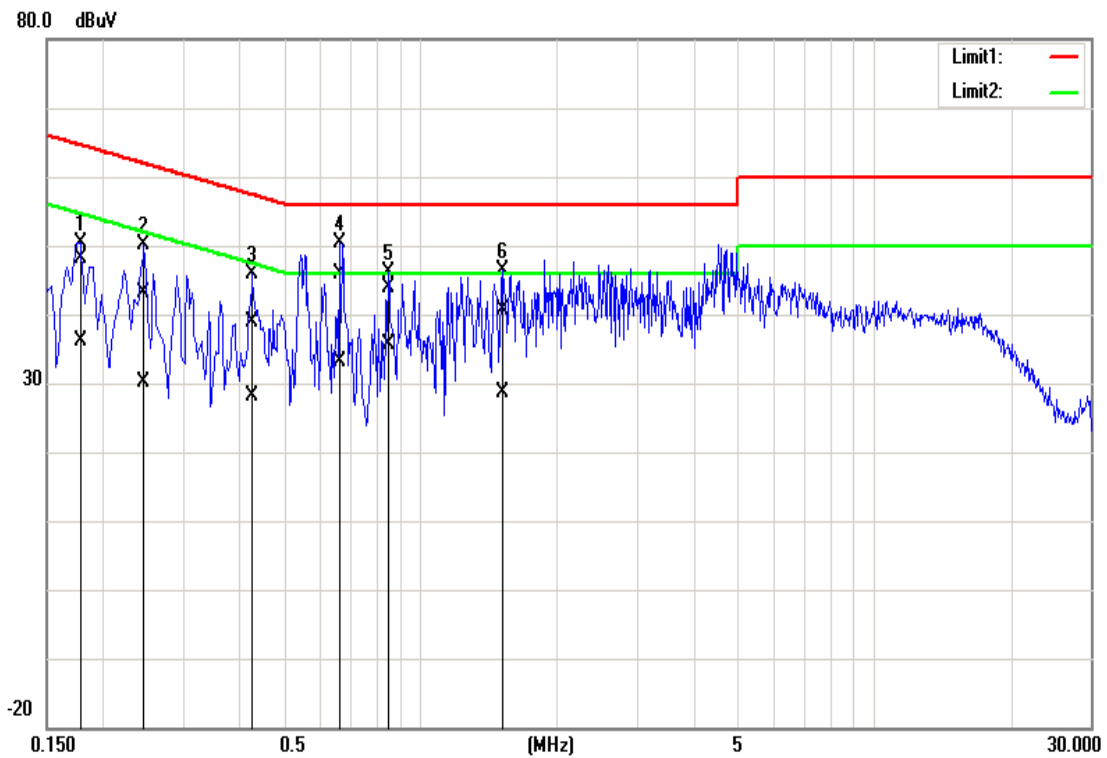

| No. | Frequency (MHz) | QuasiPeak reading (dBuV) | Average reading (dBuV) | Correction factor (dB) | QuasiPeak result (dBuV) | Average result (dBuV) | QuasiPeak limit (dBuV) | Average limit (dBuV) | QuasiPeak margin (dB) | Average margin (dB) |
|-----|--------------------|--------------------------------|------------------------------|------------------------------|-------------------------------|-----------------------------|------------------------------|----------------------------|-----------------------------|---------------------------|
| 1 | 0.1780 | 37.96 | 26.00 | 10.13 | 48.09 | 36.13 | 64.58 | 54.58 | -16.49 | -18.45 |
| 2 | 0.2460 | 33.07 | 20.11 | 10.13 | 43.20 | 30.24 | 61.89 | 51.89 | -18.69 | -21.65 |
| 3 | 0.4260 | 28.78 | 17.96 | 10.14 | 38.92 | 28.10 | 57.33 | 47.33 | -18.41 | -19.23 |
| 4 | 0.6660 | 35.61 | 23.09 | 10.15 | 45.76 | 33.24 | 56.00 | 46.00 | -10.24 | -12.76 |
| 5 | 0.8500 | 33.81 | 25.37 | 10.16 | 43.97 | 35.53 | 56.00 | 46.00 | -12.03 | -10.47 |
| 6 | 1.5140 | 30.44 | 18.40 | 10.19 | 40.63 | 28.59 | 56.00 | 46.00 | -15.37 | -17.41 |

Report No.: T190711D17-RP

| | | | |
|------------|---------|---------------|---------------|
| Test Mode: | Mode 2 | Temp/Hum | 24(°C)/ 50%RH |
| Phase: | Neutral | Test Date | 2019/08/29 |
| | | Test Engineer | Dally Hong |

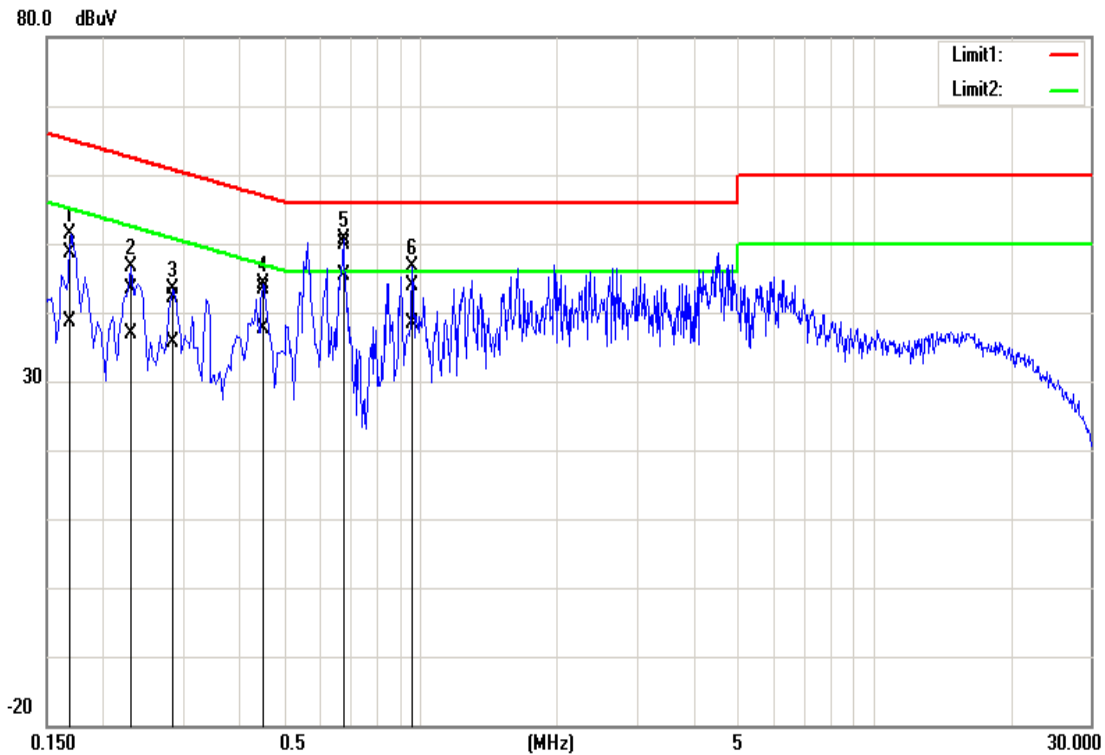

| No. | Frequency (MHz) | QuasiPeak reading (dBuV) | Average reading (dBuV) | Correction factor (dB) | QuasiPeak result (dBuV) | Average result (dBuV) | QuasiPeak limit (dBuV) | Average limit (dBuV) | QuasiPeak margin (dB) | Average margin (dB) |
|-----|-----------------|--------------------------|------------------------|------------------------|-------------------------|-----------------------|------------------------|----------------------|-----------------------|---------------------|
| 1 | 0.1700 | 38.54 | 28.60 | 10.02 | 48.56 | 38.62 | 64.96 | 54.96 | -16.40 | -16.34 |
| 2 | 0.2300 | 33.36 | 26.87 | 10.02 | 43.38 | 36.89 | 62.45 | 52.45 | -19.07 | -15.56 |
| 3 | 0.2860 | 32.03 | 25.51 | 10.02 | 42.05 | 35.53 | 60.64 | 50.64 | -18.59 | -15.11 |
| 4 | 0.4500 | 33.46 | 27.51 | 10.03 | 43.49 | 37.54 | 56.87 | 46.88 | -13.38 | -9.34 |
| 5 | 0.6780 | 39.87 | 35.26 | 10.03 | 49.90 | 45.29 | 56.00 | 46.00 | -6.10 | -0.71 |
| 6 | 0.9620 | 33.88 | 28.27 | 10.04 | 43.92 | 38.31 | 56.00 | 46.00 | -12.08 | -7.69 |

Report No.: T190711D17-RP

4.2 6dB BANDWIDTH AND OCCUPIED BANDWIDTH (99%)

4.2.1 Test Limit

According to §15.247(a)(2)

6 dB Bandwidth :

| | |
|-------|--------------------------|
| Limit | Shall be at least 500kHz |
|-------|--------------------------|

Occupied Bandwidth(99%) : For reporting purposes only.

4.2.2 Test Procedure

Test method Refer as KDB 558074 D01 and ANSI C63.10: 2013 clause 6.9.2,

1. The EUT RF output connected to the spectrum analyzer by RF cable.
2. Setting maximum power transmit of EUT
3. SA set RBW =100KHz , VBW = 300KHz and Detector = Peak, to measurement 6dB Bandwidth
4. SA set RBW = 1% ~ 5% OBW, VBW = three times the RBW and Detector = Peak, to measurement 99% Bandwidth
5. Measure and record the result of 6 dB Bandwidth and 99% Bandwidth. in the test report.

4.2.3 Test Setup

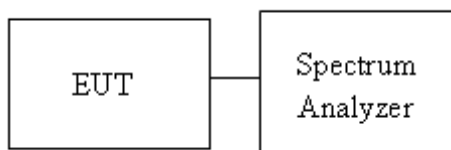

Report No.: T190711D17-RP

4.2.4 Test Result

| Test mode: IEEE 802.11b mode / 2412-2462 MHz | | | | |
|--|-----------------|-----------------|--------------|-----------------|
| Channel | Frequency (MHz) | OBW (99%) (MHz) | 6dB BW (MHz) | 6dB limit (kHz) |
| Low | 2412 | 16.3675 | 10.087 | ≥500 |
| Mid | 2437 | 16.1939 | 10.087 | |
| High | 2462 | 16.1070 | 10.0435 | |

| Test mode: IEEE 802.11g mode / 2412-2462 MHz | | | | |
|--|-----------------|-----------------|--------------|-----------------|
| Channel | Frequency (MHz) | OBW (99%) (MHz) | 6dB BW (MHz) | 6dB limit (kHz) |
| Low | 2412 | 19.6237 | 15.1304 | ≥500 |
| Mid | 2437 | 19.8842 | 15.087 | |
| High | 2462 | 19.3632 | 15.1304 | |

| Test mode: IEEE 802.11n HT 20 mode / 2412-2462 MHz | | | | |
|--|-----------------|-----------------|--------------|-----------------|
| Channel | Frequency (MHz) | OBW (99%) (MHz) | 6dB BW (MHz) | 6dB limit (kHz) |
| Low | 2412 | 18.7554 | 15.087 | ≥500 |
| Mid | 2437 | 19.0159 | 15.1304 | |
| High | 2462 | 18.7120 | 15.1304 | |

Report No.: T190711D17-RP

Test Data (6dB BANDWIDTH)

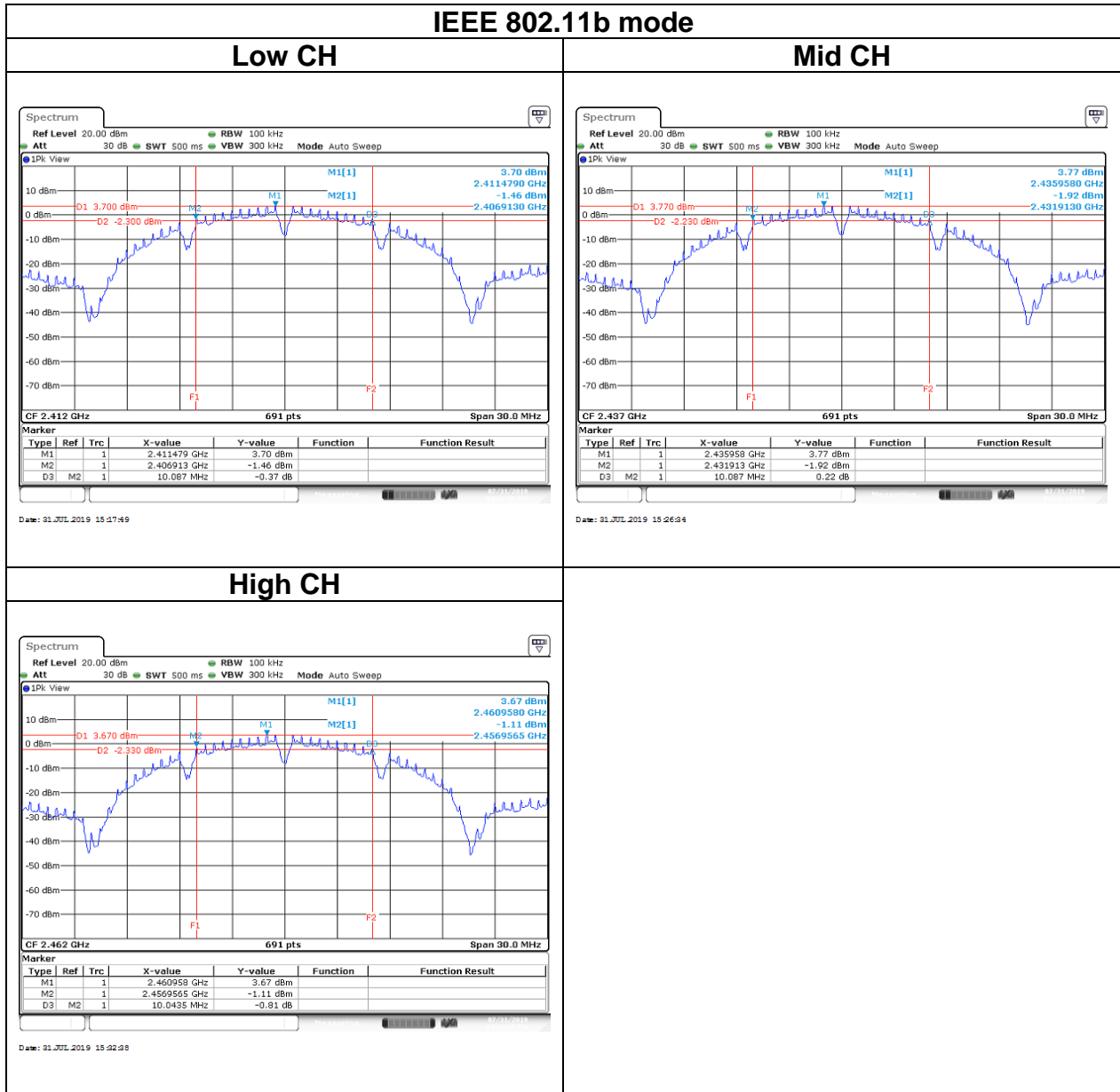



Report No.: T190711D17-RP

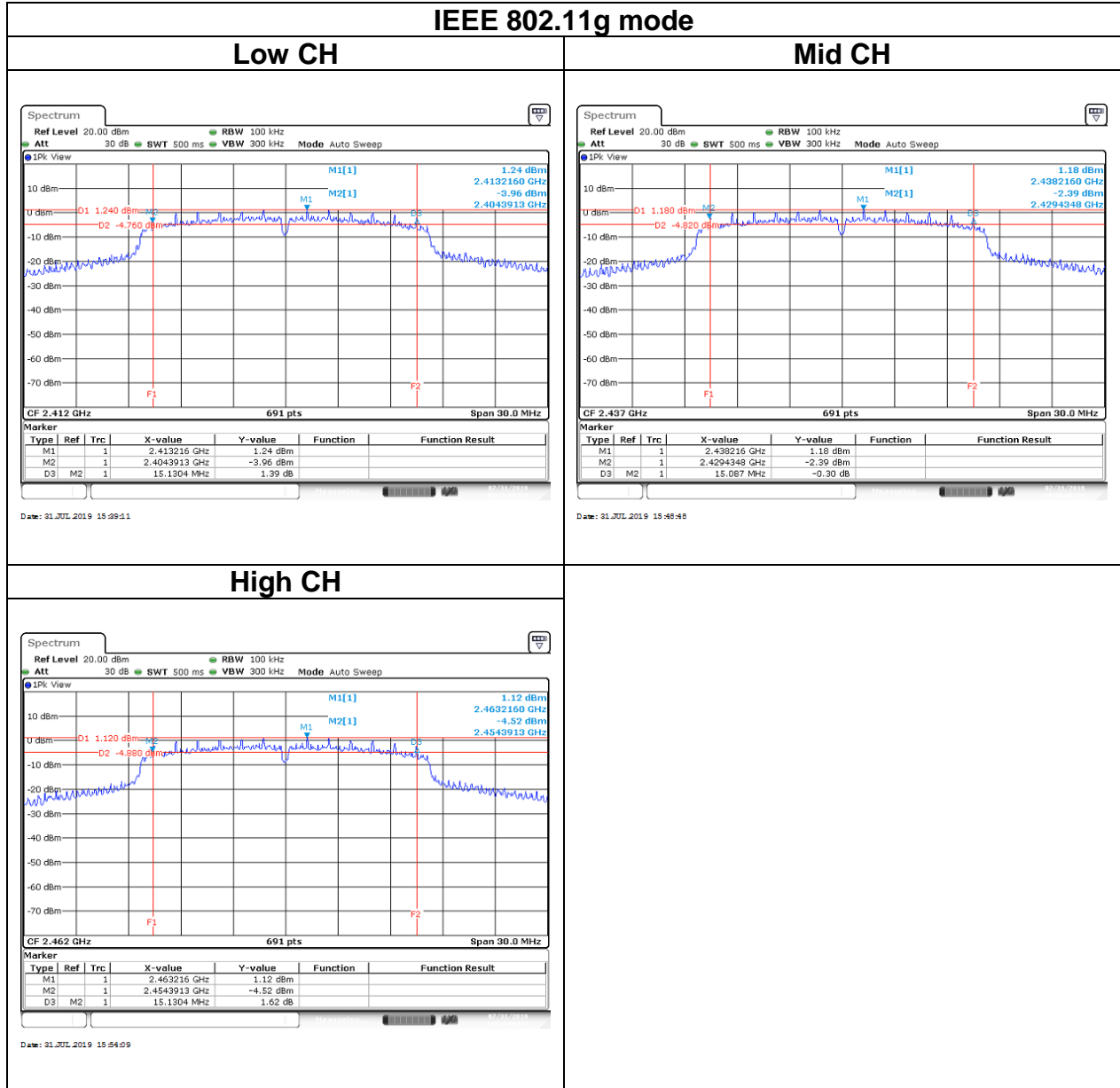

Report No.: T190711D17-RP

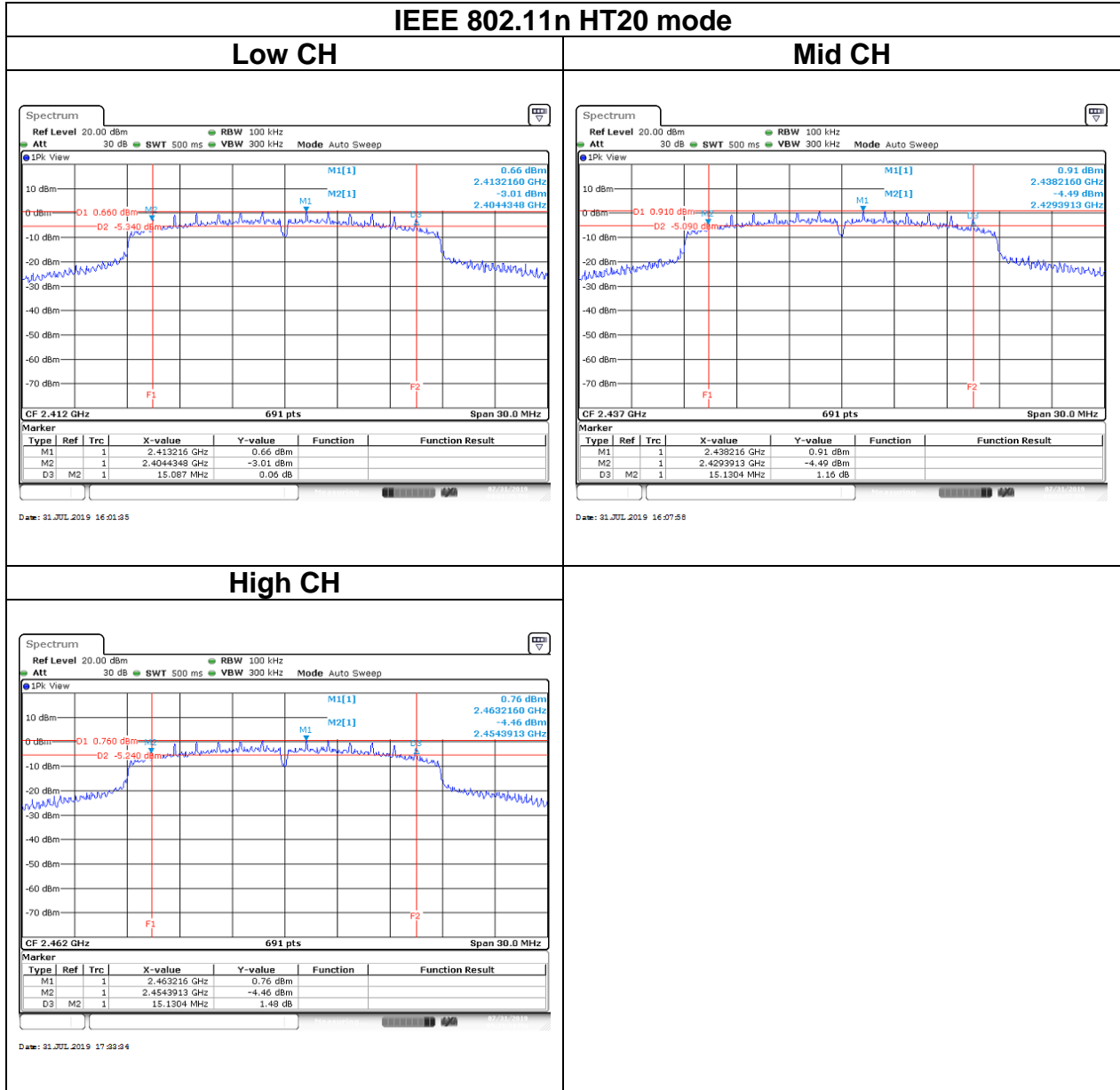

Report No.: T190711D17-RP

Test Data (BANDWIDTH 99%)

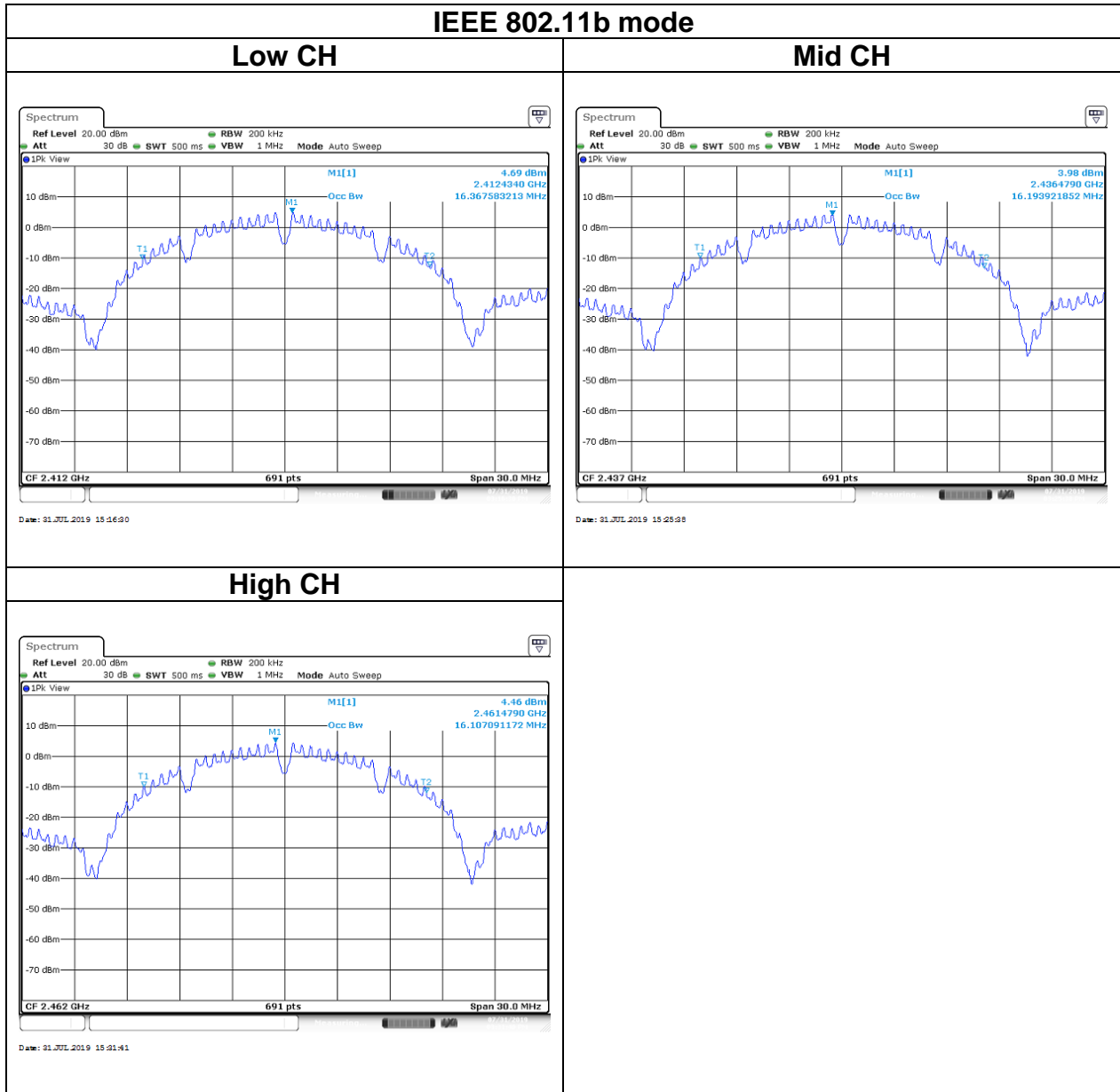



Report No.: T190711D17-RP

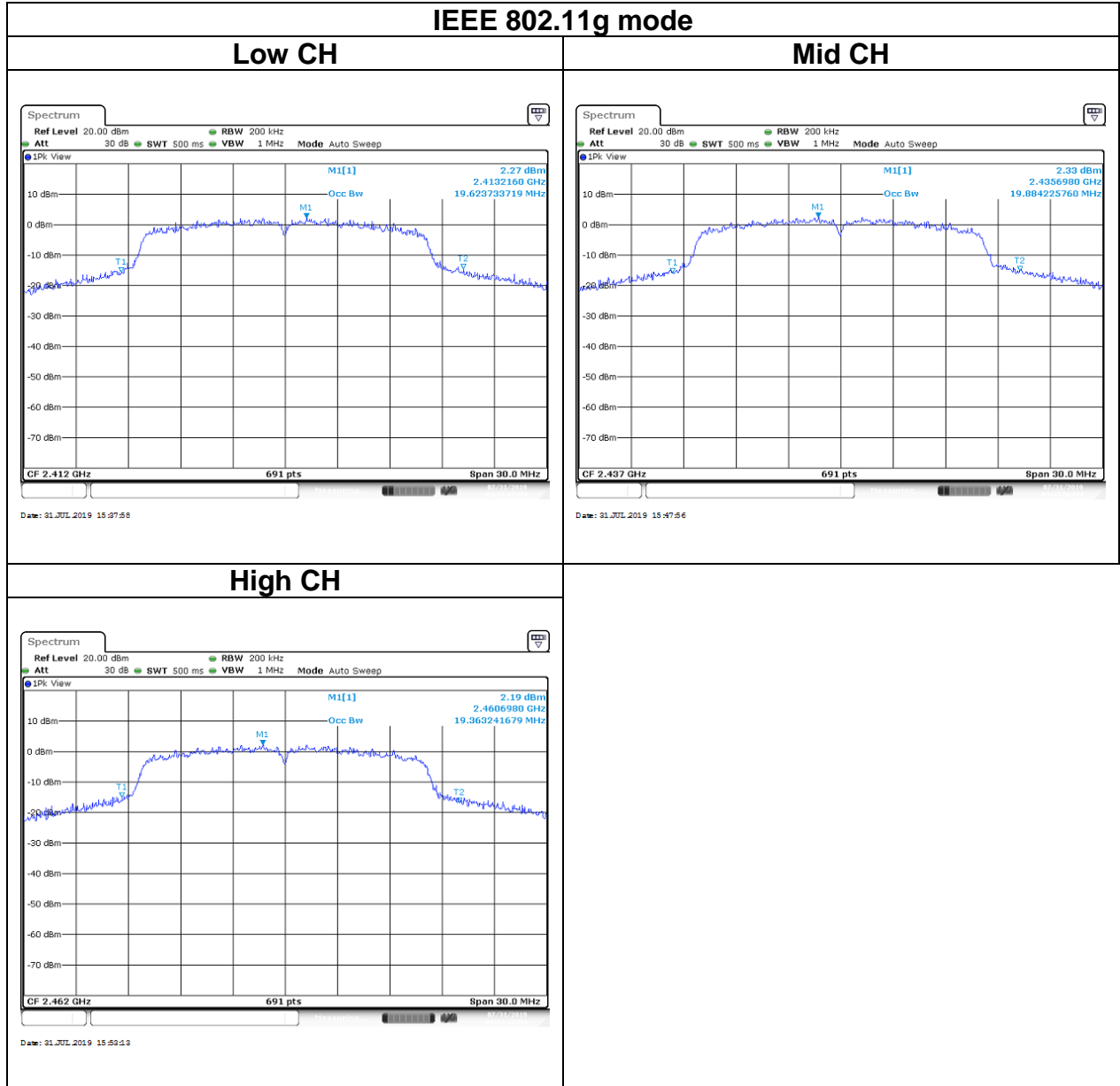

Report No.: T190711D17-RP

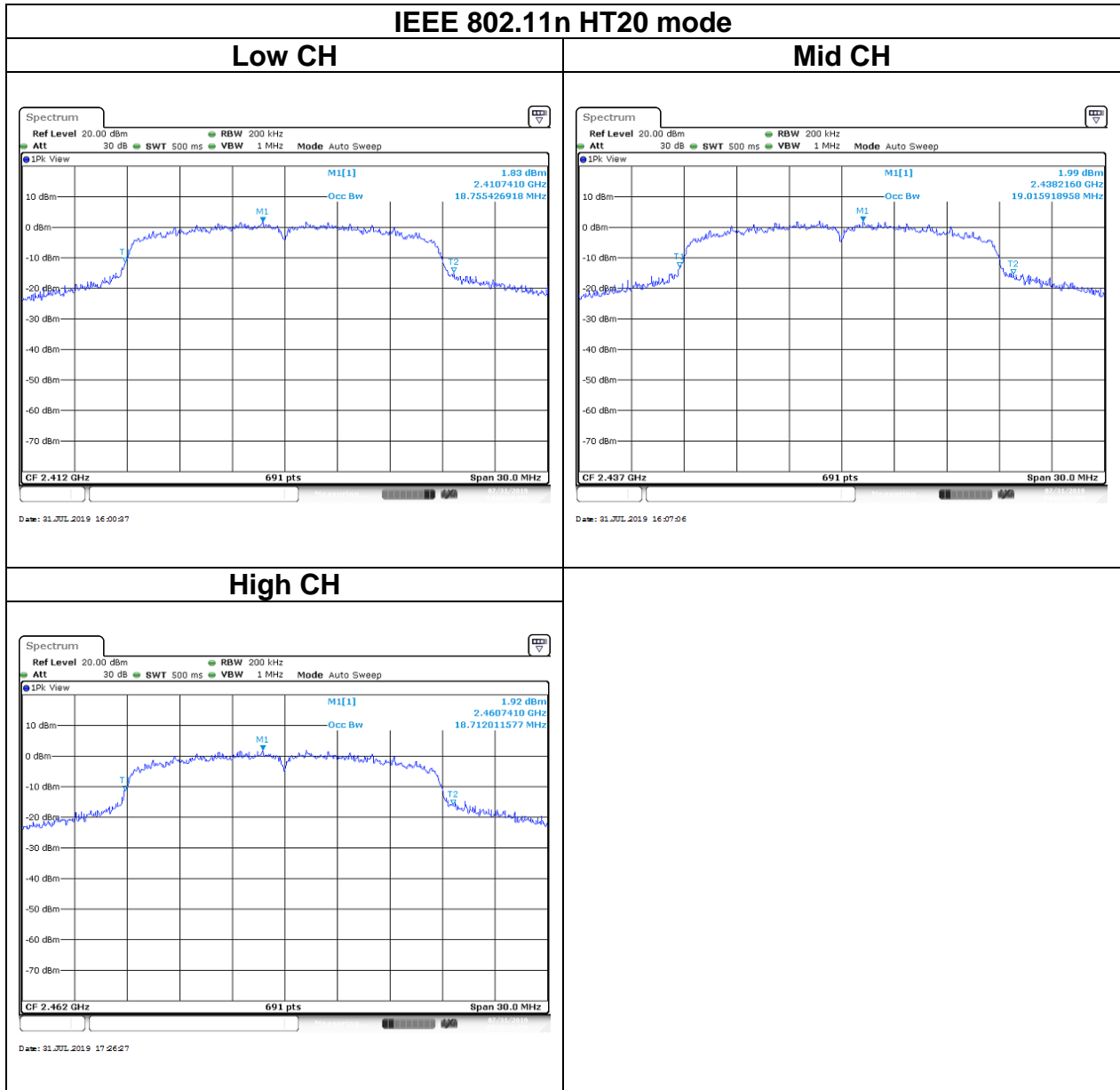

Report No.: T190711D17-RP

4.3 OUTPUT POWER MEASUREMENT

4.3.1 Test Limit

According to §15.247(b)

Peak output power :

For systems using digital modulation in the 2400-2483.5 MHz, and 5725-5850 MHz bands: 1 Watt(30 dBm), base on the use of antennas with directional gain not exceed 6 dBi If transmitting antennas of directional gain greater than 6dBi are used the peak output power the conducted output power from the intentional radiator shall be reduced by the amount in dB that the directional gain of the antenna exceeds 6 dBi. In case of point-to-point operation, the limit has to be reduced by 1dB for every 3 dB that the directional gain of the antenna exceeds 6 dBi.

| | |
|-------|---|
| Limit | <input checked="" type="checkbox"/> Antenna not exceed 6 dBi : 30dBm <input type="checkbox"/> Antenna with DG greater than 6 dBi : [Limit = 30 – (DG – 6)] <input type="checkbox"/> Point-to-point operation : |
|-------|---|

Average output power : For reporting purposes only.

4.3.2 Test Procedure

Test method Refer as KDB 558074 D01, Section 9.1.2.

1. The EUT RF output connected to the power meter by RF cable.
2. Setting maximum power transmit of EUT.
3. The path loss was compensated to the results for each measurement.
4. Measure and record the result of Peak output power and Average output power. in the test report.

4.3.3 Test Setup

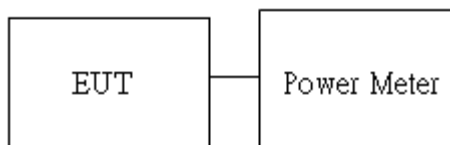

Report No.: T190711D17-RP

4.3.4 Test Result

Peak output power :

| Wifi 2.4G | | | | | | |
|---|------|-------------|-----------|----------------|--------------|-------------|
| Config | CH | Freq. (MHz) | power set | PK Power (dBm) | PK Power (W) | Limit (dBm) |
| IEEE 802.11b Data rate: 1Mbps | Low | 2412 | 19 | 22.72 | 0.1871 | 30 |
| | Mid | 2437 | 23 | 27.12 | 0.5152 | |
| | High | 2462 | 19 | 22.45 | 0.1758 | |
| IEEE 802.11g Data rate: 6Mbps | Low | 2412 | 17 | 27.40 | 0.5495 | |
| | Mid | 2437 | 22 | 26.88 | 0.4875 | |
| | High | 2462 | 16 | 27.15 | 0.5188 | |
| IEEE 802.11n HT20 Data rate: MCS0 | Low | 2412 | 16 | 27.29 | 0.5358 | |
| | Mid | 2437 | 21 | 26.92 | 0.4920 | |
| | High | 2462 | 15 | 26.57 | 0.4539 | |

Average output power :

| Wifi 2.4G | | | |
|---|------|-------------|----------------|
| Config | CH | Freq. (MHz) | AV Power (dBm) |
| IEEE 802.11b Data rate: 1Mbps | Low | 2412 | 20.16 |
| | Mid | 2437 | 24.49 |
| | High | 2462 | 19.94 |
| IEEE 802.11g Data rate: 6Mbps | Low | 2412 | 18.01 |
| | Mid | 2437 | 22.92 |
| | High | 2462 | 17.02 |
| IEEE 802.11n HT20 Data rate: MCS0 | Low | 2412 | 17.12 |
| | Mid | 2437 | 22.42 |
| | High | 2462 | 16.05 |

Report No.: T190711D17-RP

4.4 POWER SPECTRAL DENSITY

4.4.1 Test Limit

According to §15.247(e)

For digitally modulated systems, the power spectral density conducted from the intentional radiator to the antenna shall not be greater than 8 dBm in any 3 kHz band during any time interval of continuous transmission.

| | |
|-------|---|
| Limit | <input checked="" type="checkbox"/> Antenna not exceed 6 dBi : 8dBm <input type="checkbox"/> Antenna with DG greater than 6 dBi : [Limit = 8 – (DG – 6)] <input type="checkbox"/> Point-to-point operation : |
|-------|---|

4.4.2 Test Procedure

Test method Refer as KDB 558074 D01

1. The EUT RF output connected to the spectrum analyzer by RF cable.
2. Setting maximum power transmit of EUT
3. SA set RBW = 3kHz, VBW = 30kHz, Span = 1.5 times DTS Bandwidth (6 dB BW), Detector = Peak, Sweep Time = Auto and Trace = Max hold.
4. The path loss was compensated to the results for each measurement by SA.
5. Mark the maximum level.
6. Measure and record the result of power spectral density. in the test report.

4.4.3 Test Setup

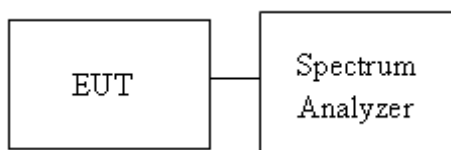

Report No.: T190711D17-RP

4.4.4 Test Result

| Test mode: IEEE 802.11b mode / 2412-2462 MHz | | | |
|---|------------------------|-------------------|--------------------|
| Channel | Frequency (MHz) | PPSD (dBm) | Limit (dBm) |
| Low | 2412 | 0.47 | 8 |
| Mid | 2437 | -0.02 | |
| High | 2462 | -0.1 | |

| Test mode: IEEE 802.11g mode / 2412-2462 MHz | | | |
|---|------------------------|-------------------|--------------------|
| Channel | Frequency (MHz) | PPSD (dBm) | Limit (dBm) |
| Low | 2412 | -2.05 | 8 |
| Mid | 2437 | -2.27 | |
| High | 2462 | -3.08 | |

| Test mode: IEEE 802.11n HT 20 mode / 2412-2462 MHz | | | |
|---|------------------------|-------------------|--------------------|
| Channel | Frequency (MHz) | PPSD (dBm) | Limit (dBm) |
| Low | 2412 | -2.15 | 8 |
| Mid | 2437 | -2.74 | |
| High | 2462 | -2.69 | |

Report No.: T190711D17-RP

Test Data

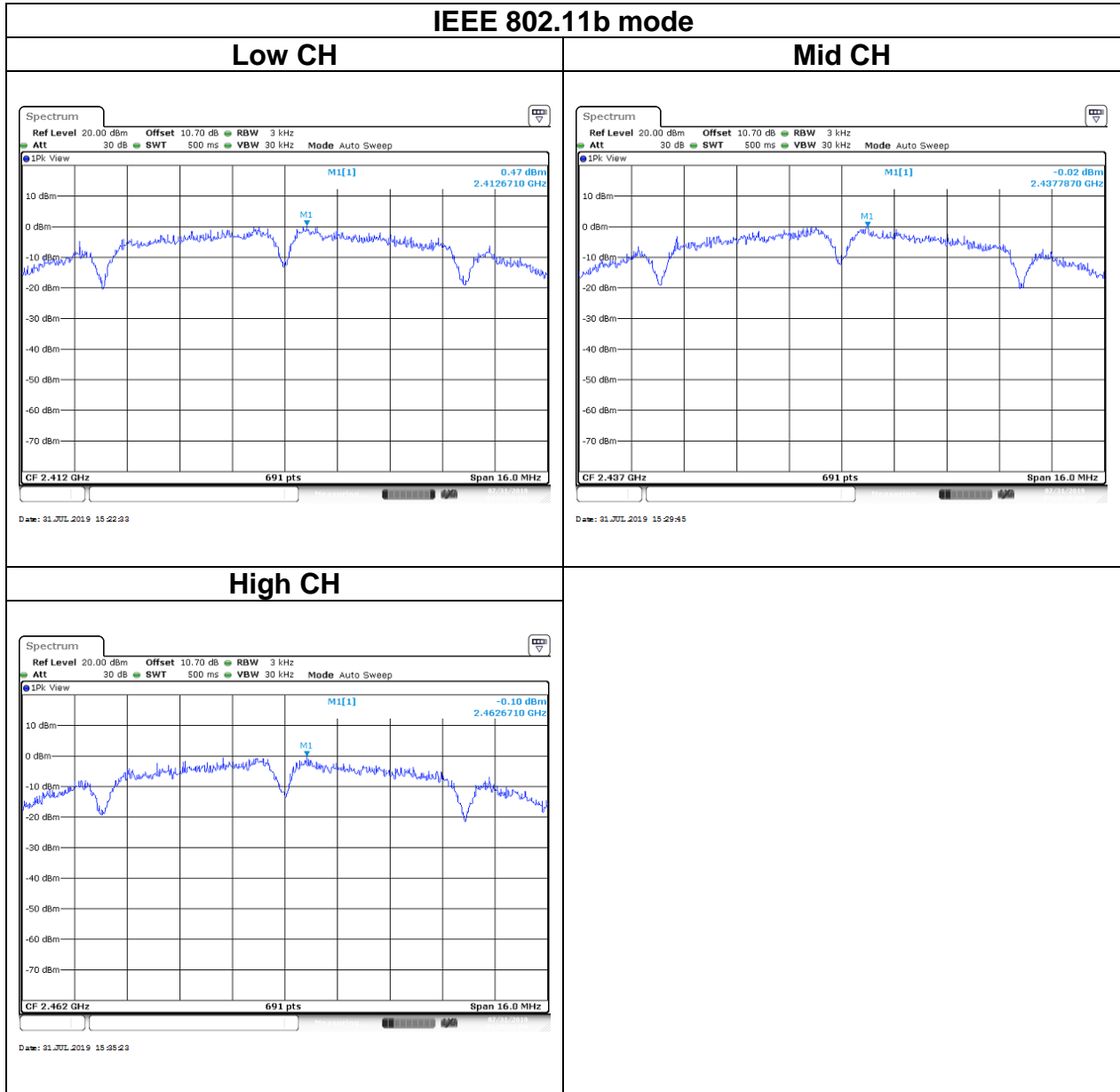

Report No.: T190711D17-RP

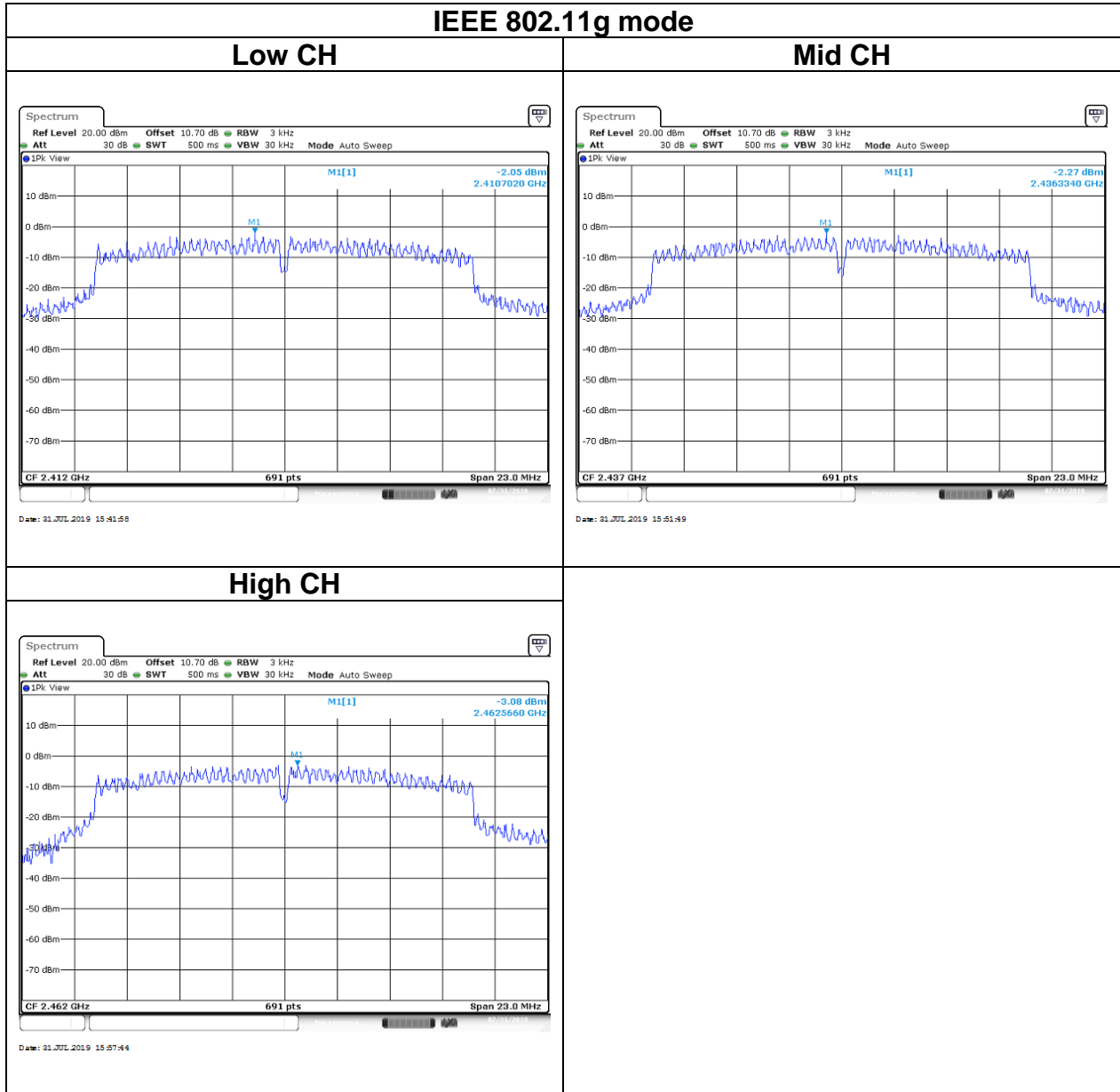



Report No.: T190711D17-RP

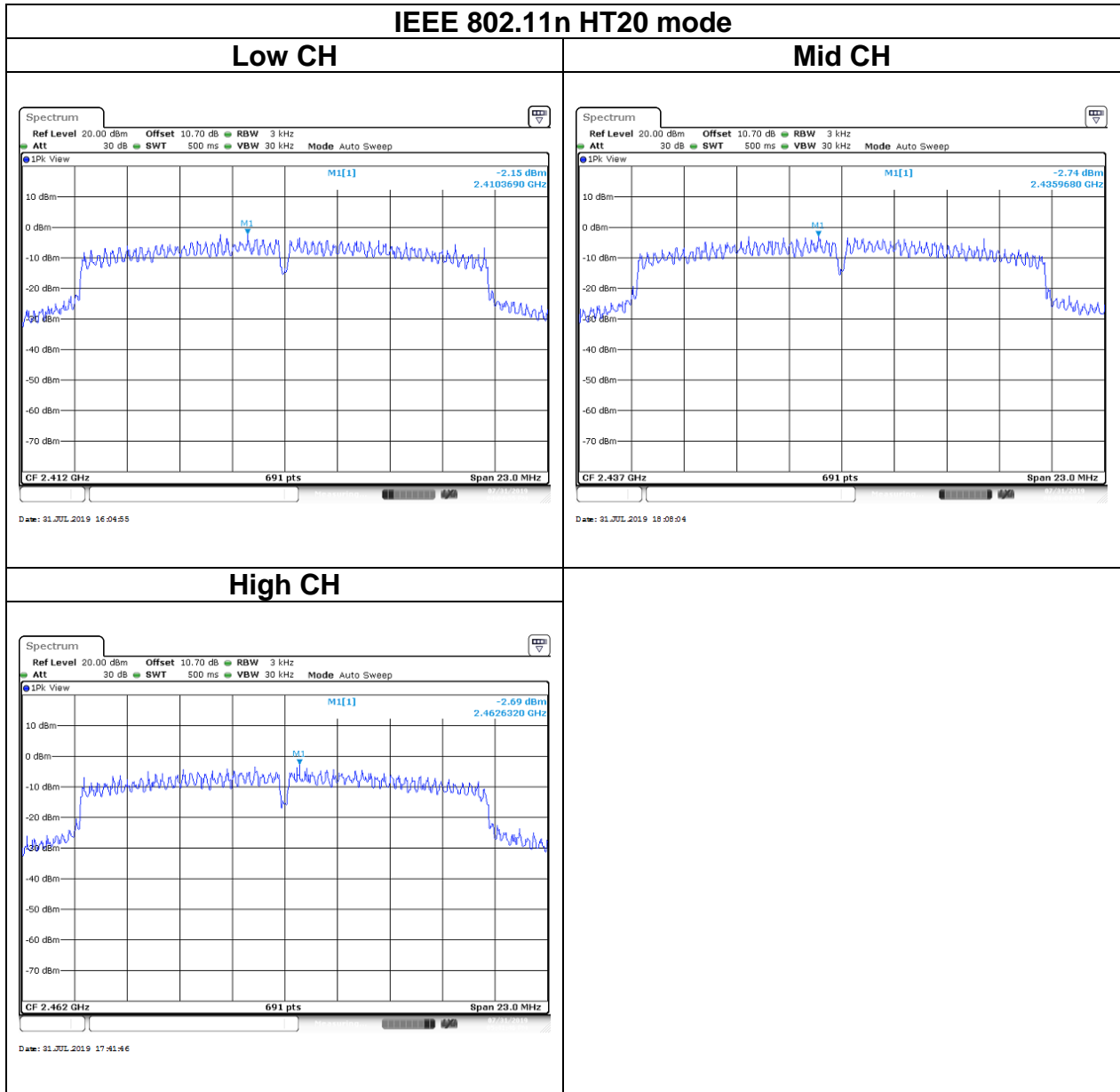

4.5 CONDUCTED BANDEDGE AND SPURIOUS EMISSION

4.5.1 Test Limit

According to §15.247(d)

In any 100 kHz bandwidth outside the authorized frequency band,

Non-restricted bands shall be attenuated at least 20 dB/30 dB relative to the maximum PSD level in 100 kHz by RF conducted or a radiated measurement which fall in the restricted bands, as defined in §15.205(a), must also comply with the radiated emission limits specified in §15.209(a).

4.5.2 Test Procedure

Test method Refer as KDB 558074 D01

1. EUT RF output port connected to the SA by RF cable, and the path loss was compensated to result.
2. SA setting, RBW=100kHz, VBW=300kHz, Detector=Peak, Trace mode = max hold, SWT = Auto.
3. In any 100 kHz bandwidth outside the authorized frequency band, shall be attenuated at least 20 dB relative to the maximum in-band peak PSD level in 100 kHz when conducted power procedure is used. If the transmitter complies with the conducted power limits based on the use of RMS averaging over a time interval, the attenuation required under this paragraph shall be 30 dB instead of 20 dB.

4.5.3 Test Setup



Report No.: T190711D17-RP

4.5.4 Test Result

Test Data

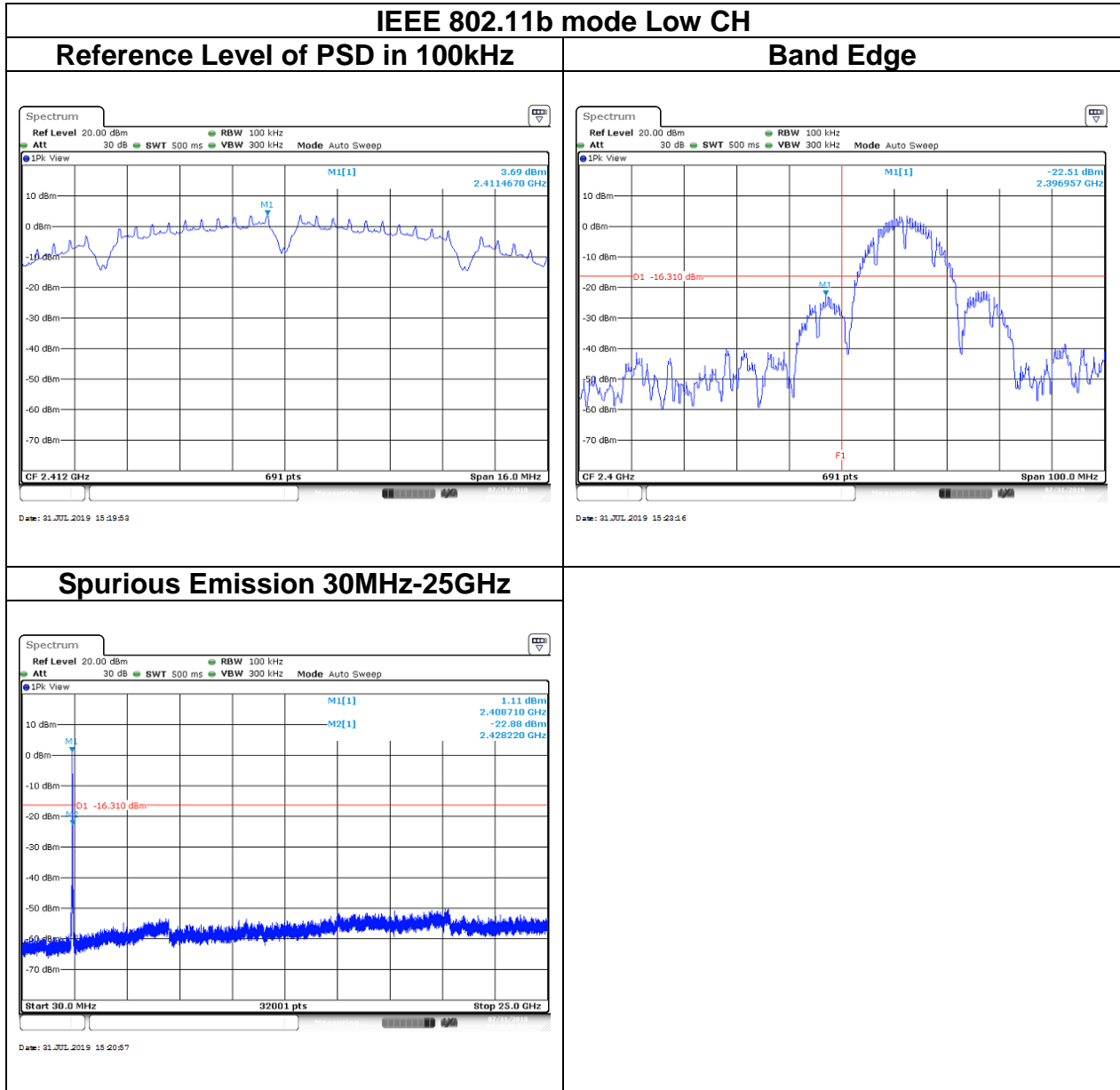

Report No.: T190711D17-RP

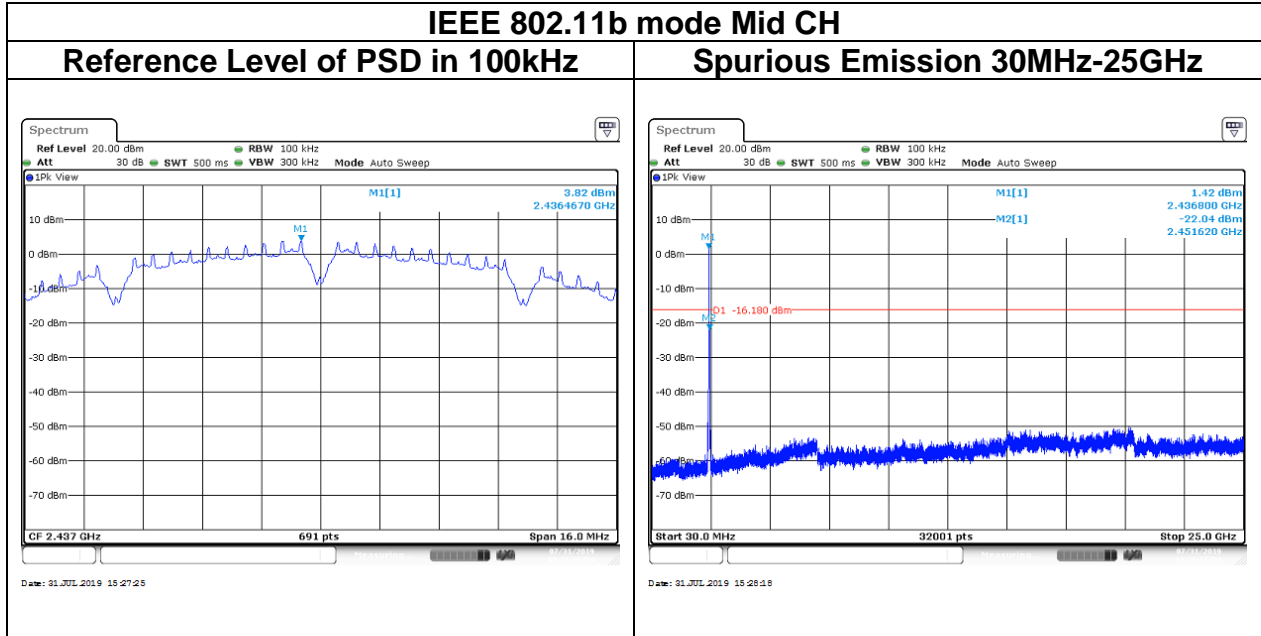

Report No.: T190711D17-RP

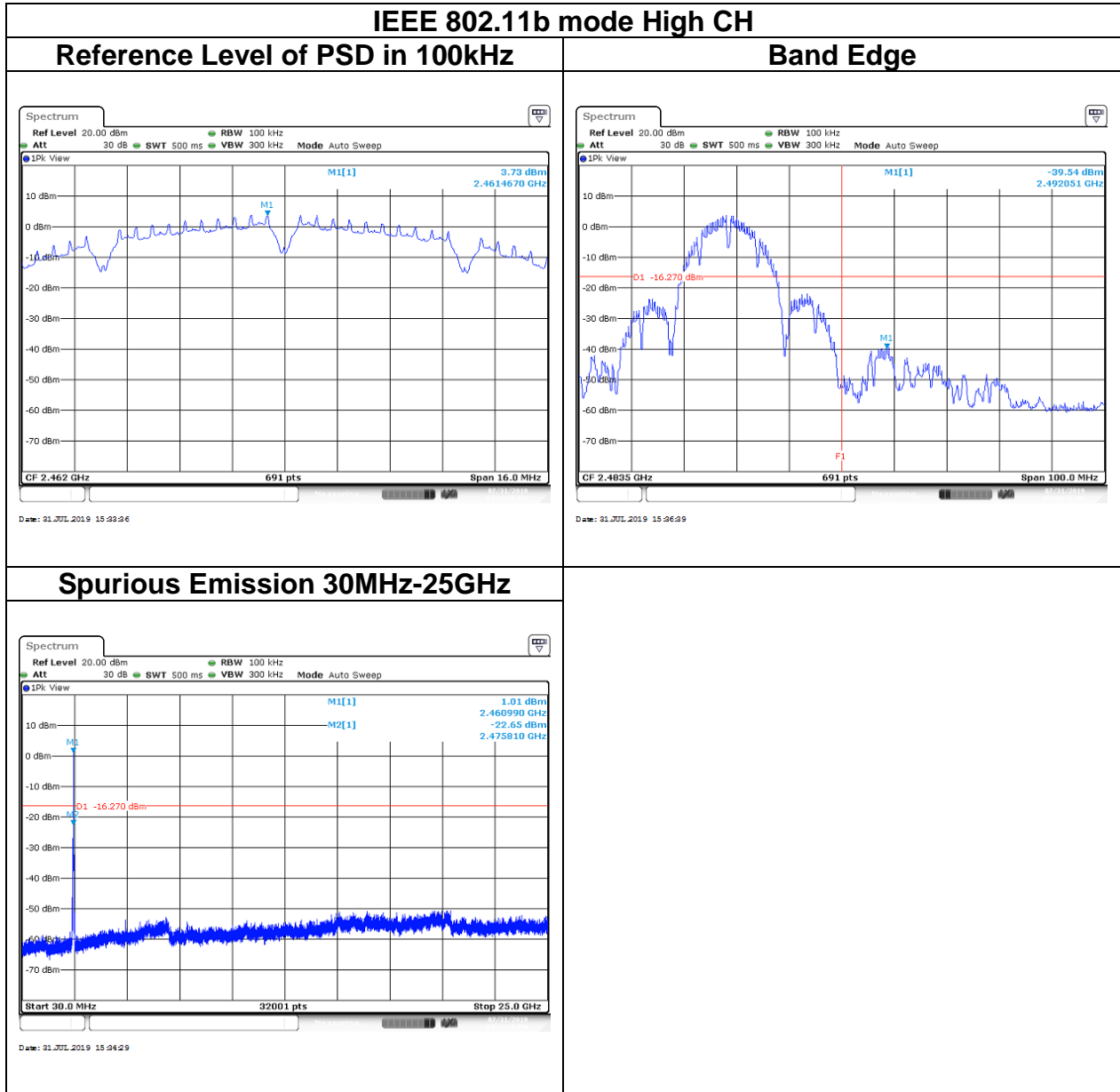

Report No.: T190711D17-RP

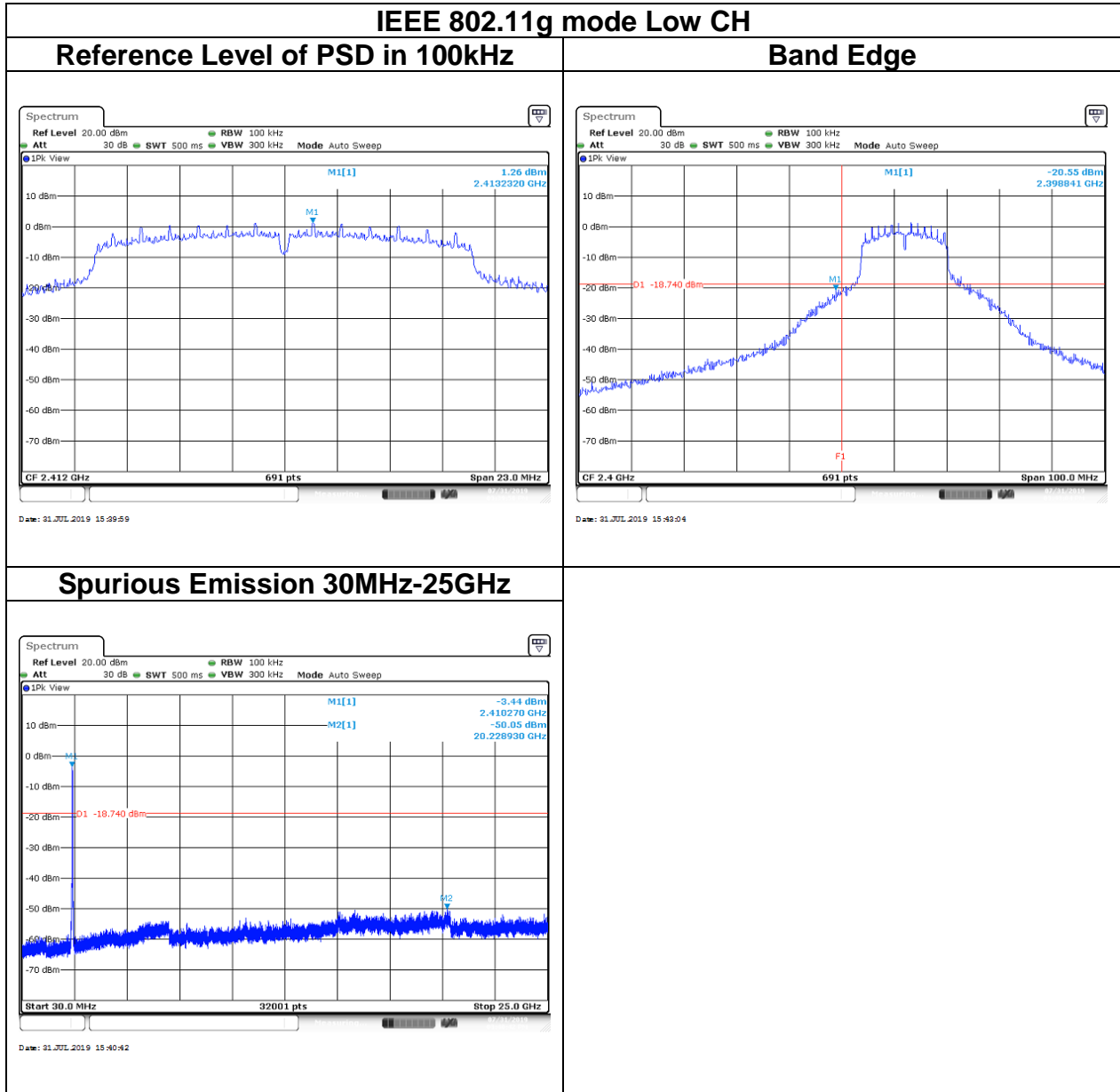

Report No.: T190711D17-RP

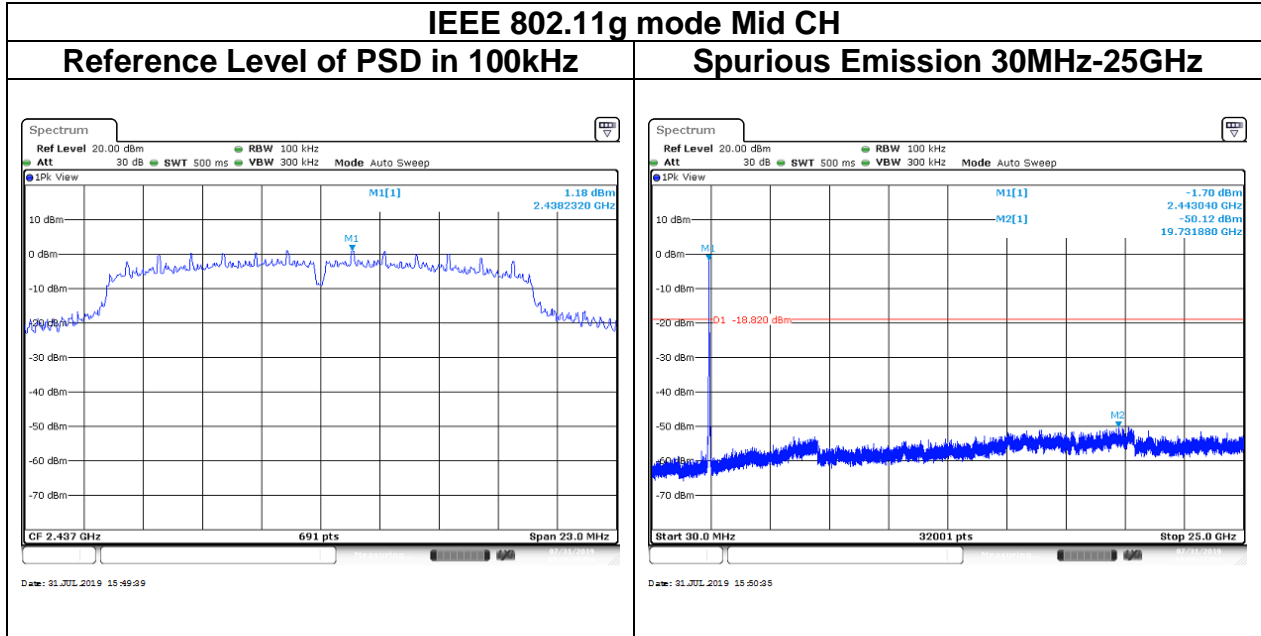

Report No.: T190711D17-RP

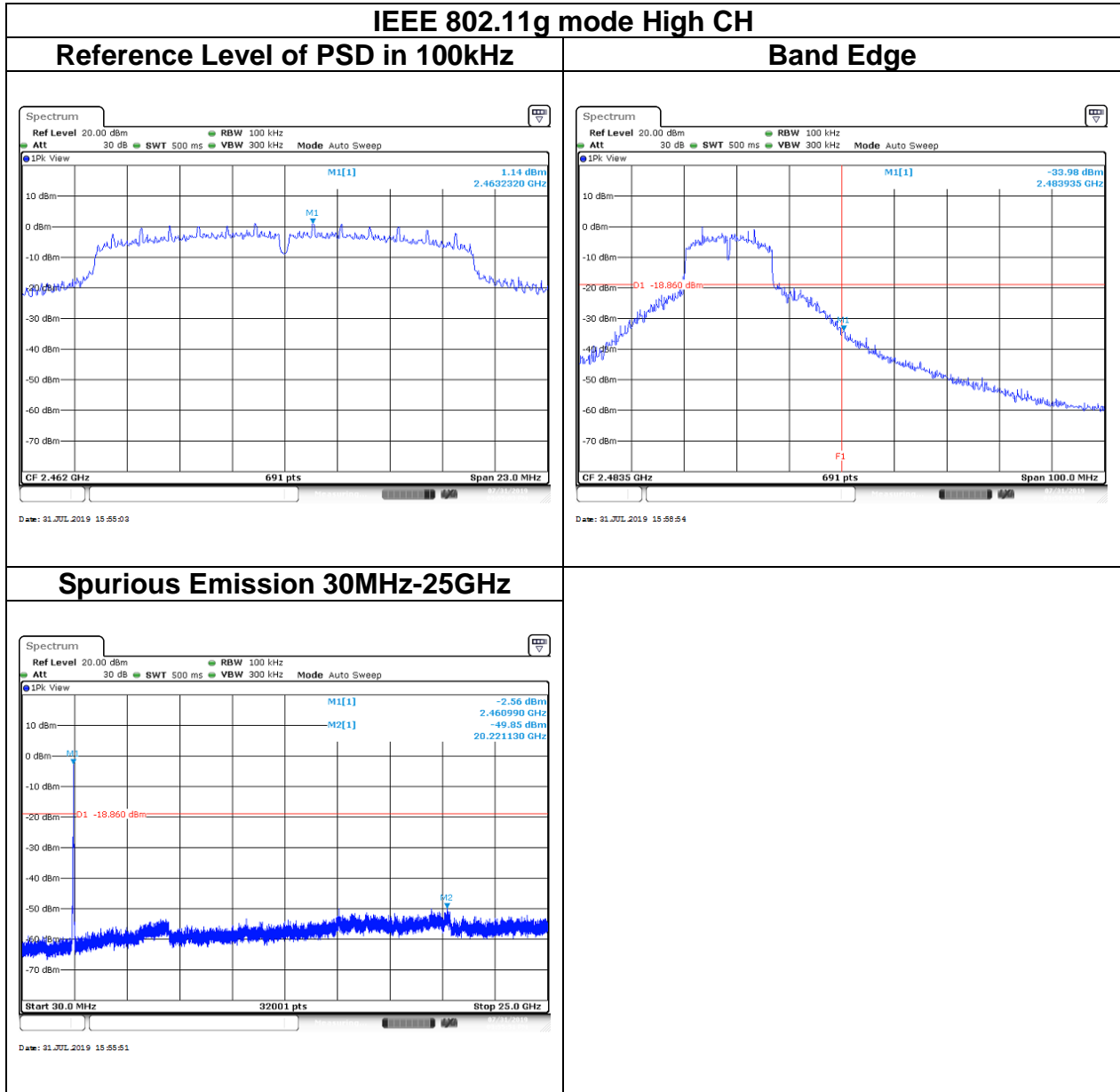

Report No.: T190711D17-RP

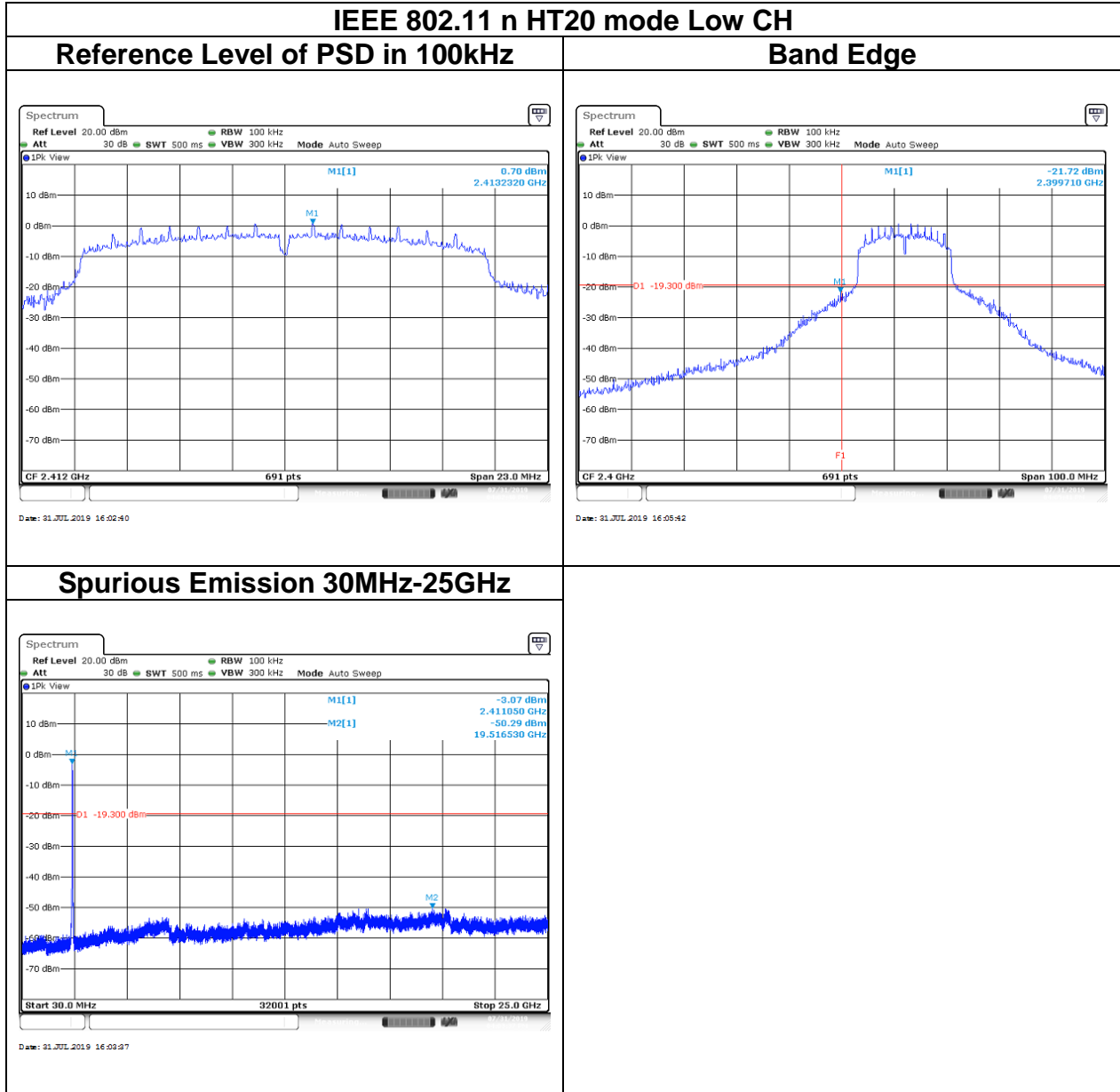

Report No.: T190711D17-RP

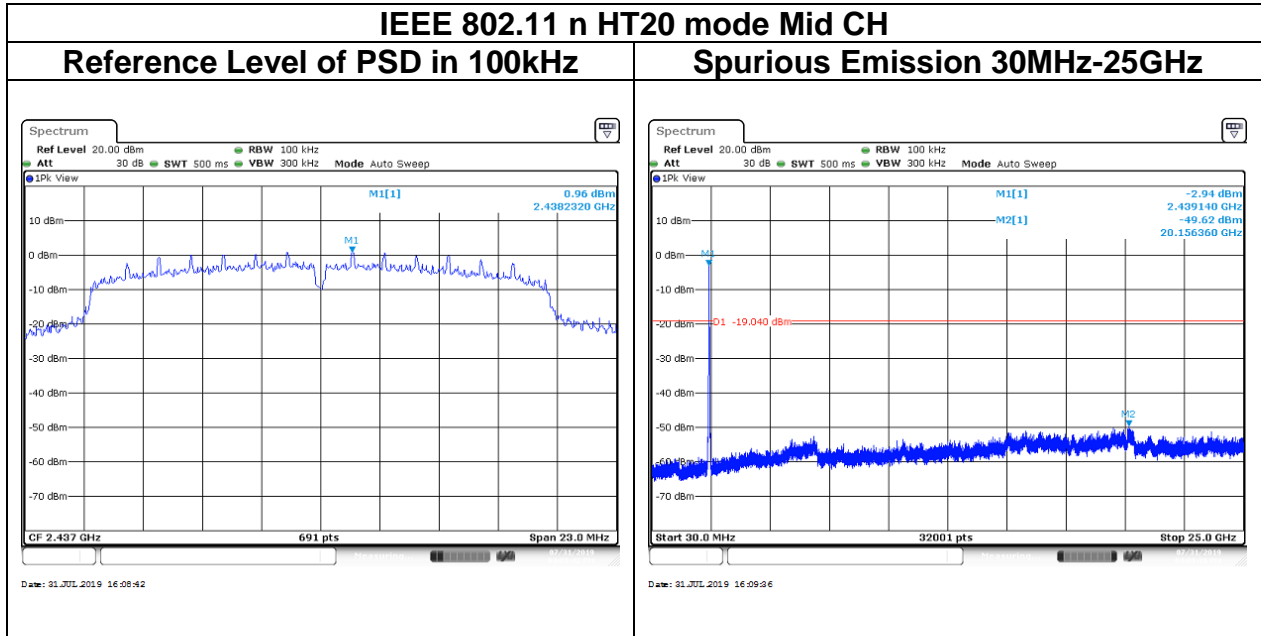

Report No.: T190711D17-RP

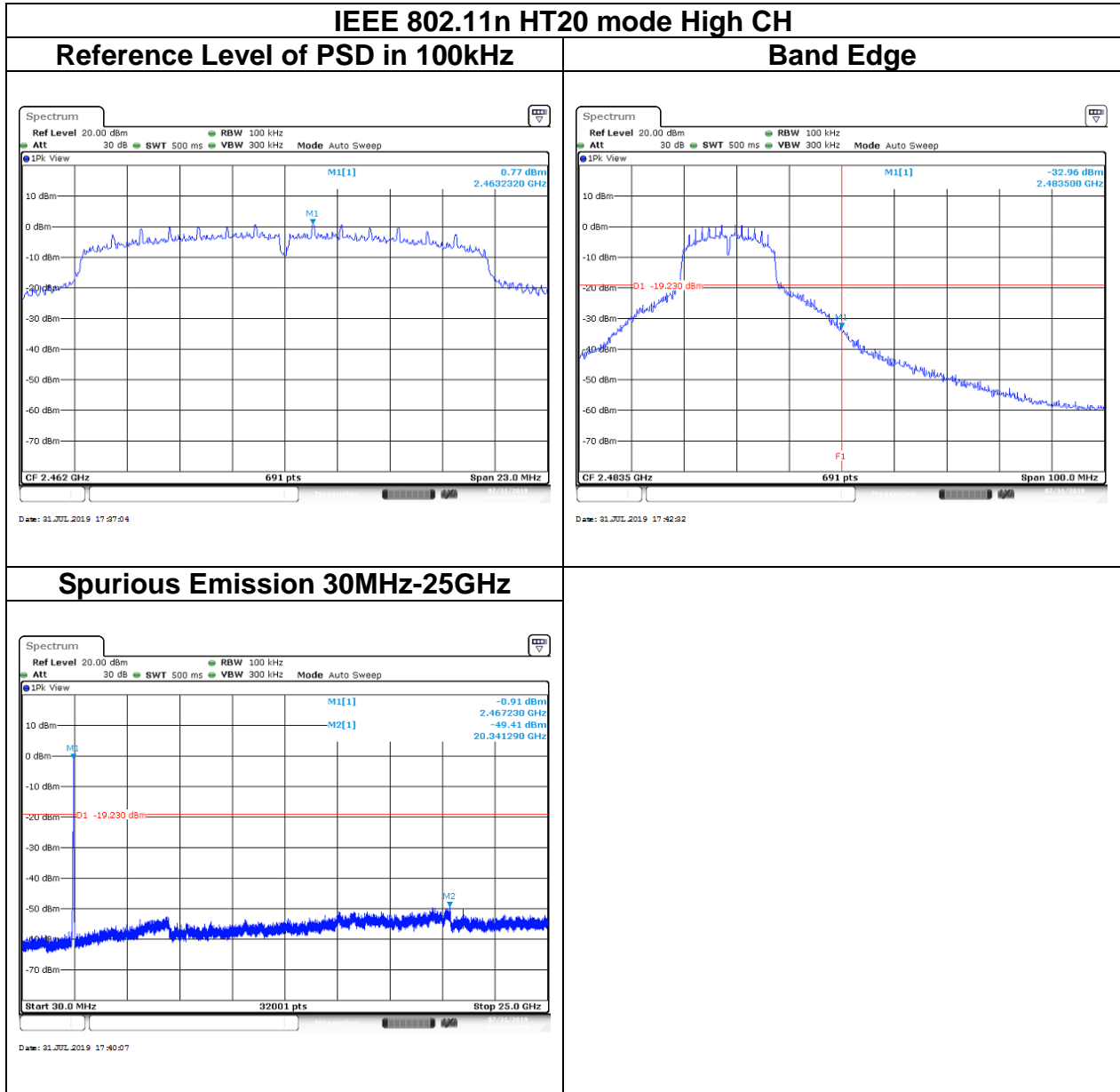

Report No.: T190711D17-RP

4.6 RADIATION BANDEDGE AND SPURIOUS EMISSION

4.6.1 Test Limit

FCC according to §15.247(d), §15.209 and §15.205,

In any 100 kHz bandwidth outside the authorized frequency band, all harmonic and spurious must be least 20 dB below the highest emission level with the authorized frequency band. Radiation emission which fall in the restricted bands must also follow the FCC section 15.209 as below limit in table.

Below 30 MHz

| Frequency | Field Strength (microvolts/m) | Magnetic H-Field (microamperes/m) | Measurement Distance (metres) |
|---------------|-------------------------------|-----------------------------------|-------------------------------|
| 9-490 kHz | 2,400/F (F in kHz) | 2,400/F (F in kHz) | 300 |
| 490-1,705 kHz | 24,000/F (F in kHz) | 24,000/F (F in kHz) | 30 |
| 1.705-30 MHz | 30 | N/A | 30 |

Above 30 MHz

| Frequency | Field Strength (microvolts/m) | Measurement Distance (metres) |
|-----------|-------------------------------|-------------------------------|
| 30-88 | 100 | 3 |
| 88-216 | 150 | 3 |
| 216-960 | 200 | 3 |
| Above 960 | 500 | 3 |

Report No.: T190711D17-RP

4.6.2 Test Procedure

Test method Refer as KDB 558074 D01

1. The EUT is placed on a turntable, Above 1 GHz is 1.5m and below 1 GHz is 0.8m above ground plane. The EUT Configured un accordance with ANSI C63.10: 2013, and the EUT set in a continuous mode.
2. The turntable shall be rotated for 360 degrees to determine the position of maximum emission level. And EUT is set 3m away from the receiving antenna, which is scanned from 1m to 4m above the ground plane to find out the highest emissions. Measurement are made polarized in both the vertical and the horizontal positions with antenna.
3. Span shall wide enough to full capture the emission measured. The SA from 30MHz to 26.5GHz set to the low, Mid and High channels with the EUT transmit.

Remark:

1. Although these tests were performed other than open area test site, adequate comparison measurements were confirmed against 30 m open are test site. Therefore sufficient tests were made to demonstrate that the alternative site produces results that correlate with the ones of tests made in an open field based on KDB 414788.
2. Note: No emission found between lowest internal used/generated frequency to 30MHz (9KHz~30MHz)

4. The SA setting following :

- (1) Below 1G : RBW = 100kHz, VBW \geq 3 RBW, Sweep = Auto, Detector = Peak, Trace = Max hold.
- (2) Above 1G :
 - (2.1) For Peak measurement : RBW = 1MHz, VBW \geq 3 RBW, Sweep = Auto, Detector = Peak, Trace = Max hold.
 - (2.2) For Average measurement : RBW = 1MHz, VBW
 - If Duty Cycle \geq 98%, VBW=10Hz.
 - If Duty Cycle < 98%, VBW=1/T.

| Configuration | Duty Cycle (%) | T(ms) | 1/T (kHz) | VBW Setting |
|---------------|----------------|--------|-----------|-------------|
| 802.11b | 99.67% | 8.6667 | - | 10Hz |
| 802.11g | 95.37% | 1.4928 | 0.670 | 680Hz |
| 802.11n HT20 | 97.14% | 1.9710 | 0.507 | 510Hz |

Report No.: T190711D17-RP

4.6.3 Test Setup

9kHz ~ 30MHz

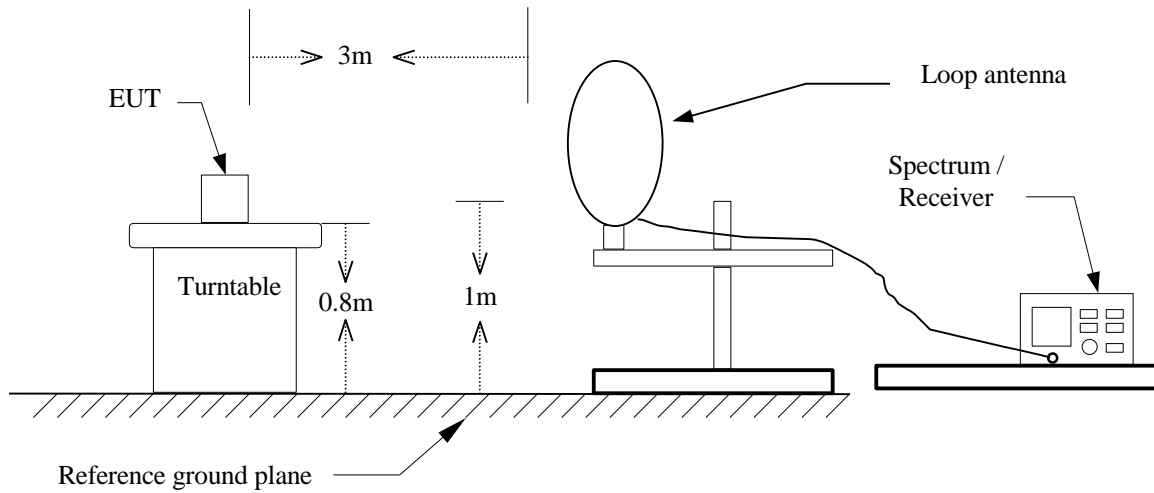

30MHz ~ 1GHz

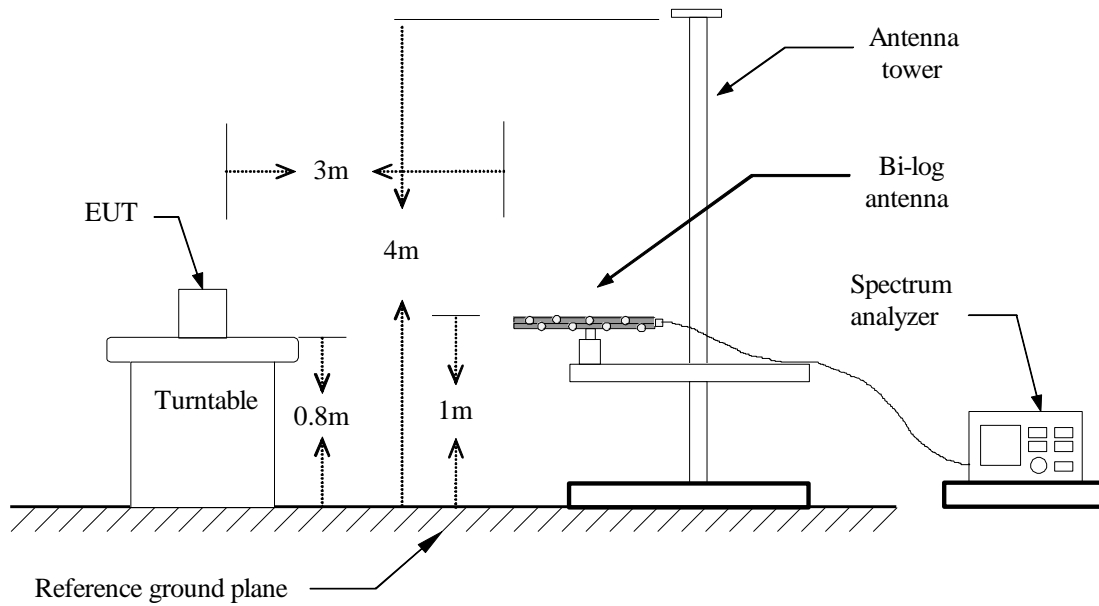

Report No.: T190711D17-RP

Above 1 GHz

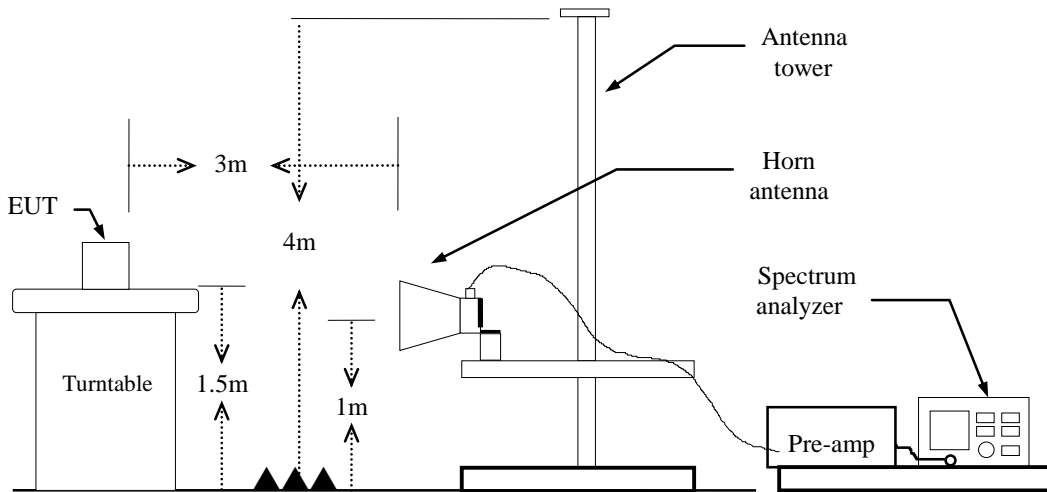

Report No.: T190711D17-RP

4.6.4 Test Result

Band Edge Test Data

| | | | |
|-----------|---------------------|---------------|-----------------|
| Test Mode | IEEE 802.11b Low CH | Temp/Hum | 31(°C)/ 57%RH |
| Test Item | Band Edge | Test Date | August 05, 2019 |
| Polarize | Vertical | Test Engineer | Jerry Lu |
| Detector | Peak / Average | | |

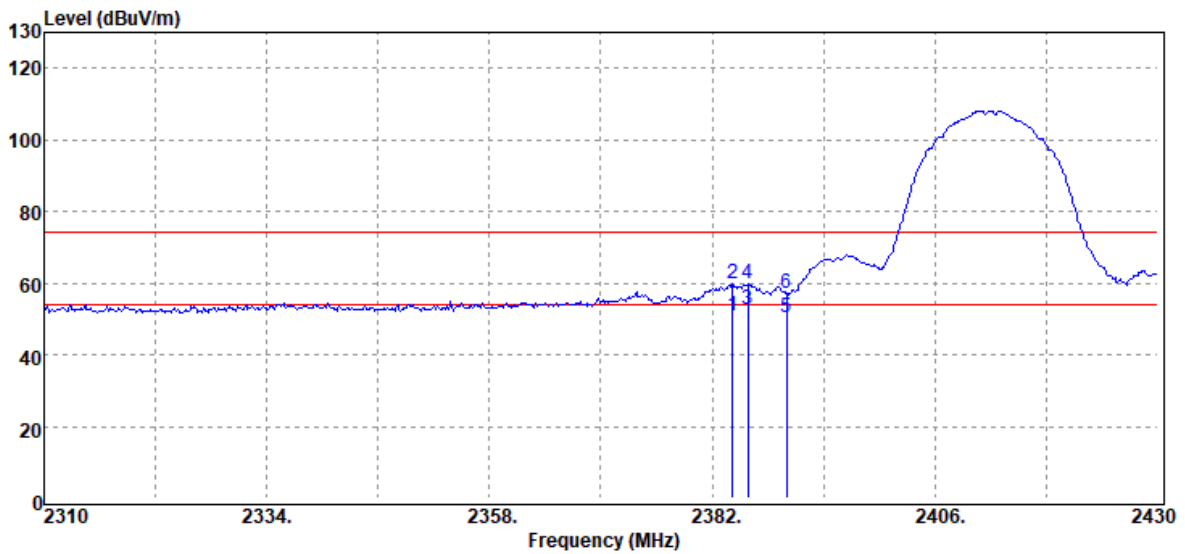

| Frequency (MHz) | Reading (dBuV) | Correct Factor (dB/m) | Result (dBuV/m) | Limit (dBuV/m) | Margin (dB) | Remark |
|-----------------|----------------|-----------------------|-----------------|----------------|-------------|---------|
| 2384.16 | 54.02 | -3.38 | 50.64 | 54.00 | -3.36 | Average |
| 2384.16 | 63.31 | -3.38 | 59.93 | 74.00 | -14.07 | Peak |
| 2385.84 | 55.88 | -3.38 | 52.50 | 54.00 | -1.50 | Average |
| 2385.84 | 63.03 | -3.38 | 59.65 | 74.00 | -14.35 | Peak |
| 2390.00 | 53.56 | -3.38 | 50.18 | 54.00 | -3.82 | Average |
| 2390.00 | 60.46 | -3.38 | 57.08 | 74.00 | -16.92 | Peak |

Report No.: T190711D17-RP

| | | | |
|-----------|---------------------|---------------|-----------------|
| Test Mode | IEEE 802.11b Low CH | Temperature: | 31(°C)/ 57%RH |
| Test Item | Band Edge | Test Date | August 05, 2019 |
| Polarize | Horizontal | Test Engineer | Jerry Lu |
| Detector | Peak / Average | | |

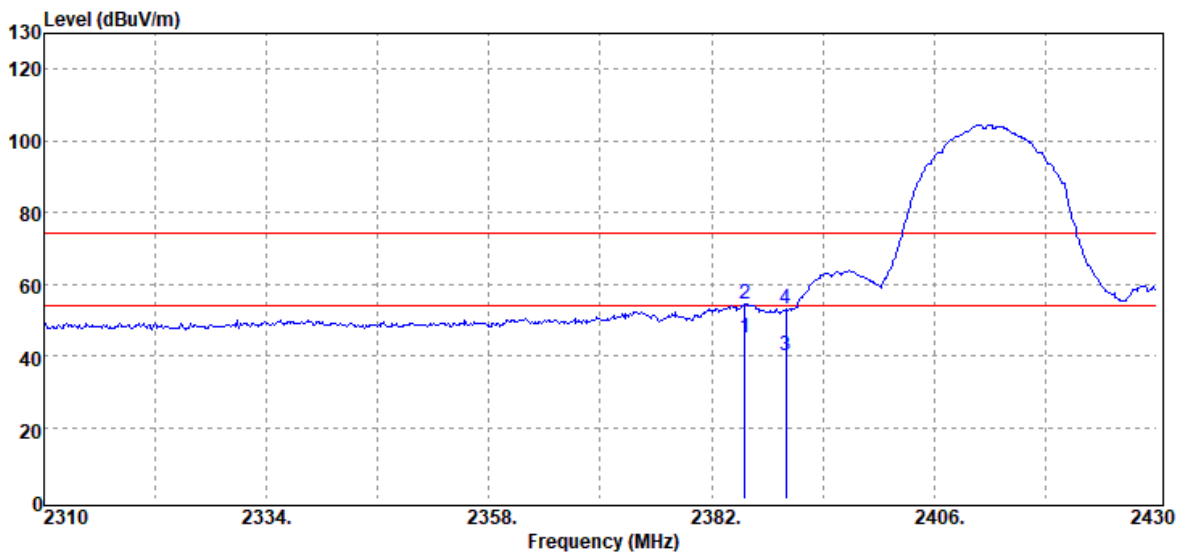

| Frequency (MHz) | Reading (dBUV) | Correct Factor (dB/m) | Result (dBUV/m) | Limit (dBUV/m) | Margin (dB) | Remark |
|-----------------|----------------|-----------------------|-----------------|----------------|-------------|---------|
| 2385.60 | 48.51 | -3.38 | 45.13 | 54.00 | -8.87 | Average |
| 2385.60 | 58.01 | -3.38 | 54.63 | 74.00 | -19.37 | Peak |
| 2390.00 | 43.49 | -3.38 | 40.11 | 54.00 | -13.89 | Average |
| 2390.00 | 56.64 | -3.38 | 53.26 | 74.00 | -20.74 | Peak |

Report No.: T190711D17-RP

| | | | |
|-----------|----------------------|---------------|-----------------|
| Test Mode | IEEE 802.11b High CH | Temp/Hum | 31(°C)/ 57%RH |
| Test Item | Band Edge | Test Date | August 05, 2019 |
| Polarize | Vertical | Test Engineer | Jerry Lu |
| Detector | Peak / Average | | |

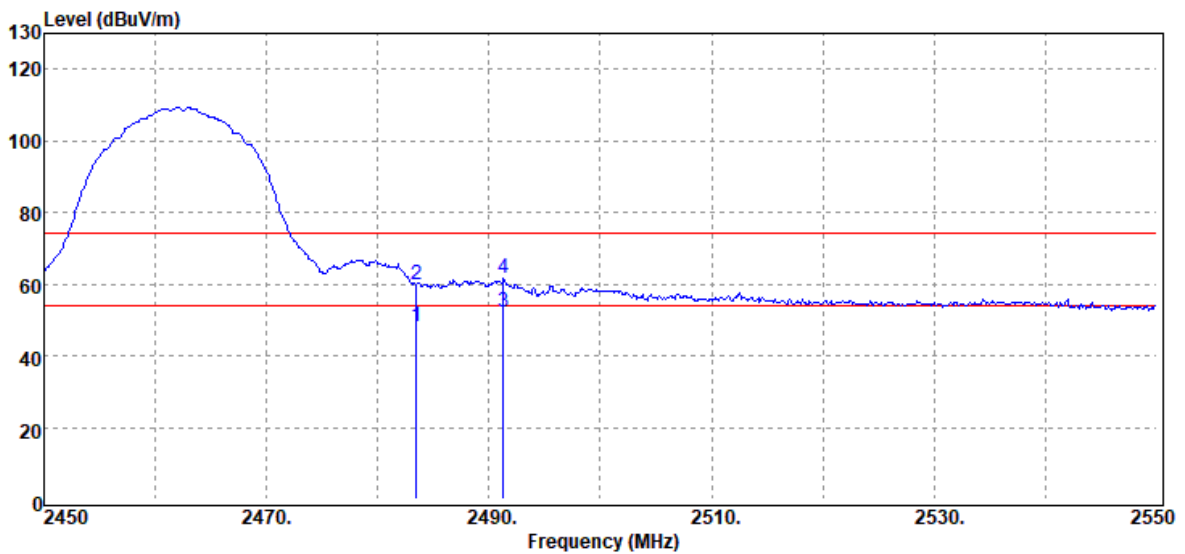

| Frequency (MHz) | Reading (dBUV) | Correct Factor (dB/m) | Result (dBUV/m) | Limit (dBUV/m) | Margin (dB) | Remark |
|-----------------|----------------|-----------------------|-----------------|----------------|-------------|---------|
| 2483.50 | 51.13 | -2.83 | 48.30 | 54.00 | -5.70 | Average |
| 2483.50 | 62.65 | -2.83 | 59.82 | 74.00 | -14.18 | Peak |
| 2491.30 | 54.97 | -2.77 | 52.20 | 54.00 | -1.80 | Average |
| 2491.30 | 64.50 | -2.77 | 61.73 | 74.00 | -12.27 | Peak |

Report No.: T190711D17-RP

| | | | |
|-----------|----------------------|---------------|-----------------|
| Test Mode | IEEE 802.11b High CH | Temperature: | 31(°C)/ 57%RH |
| Test Item | Band Edge | Test Date | August 05, 2019 |
| Polarize | Horizontal | Test Engineer | Jerry Lu |
| Detector | Peak / Average | | |

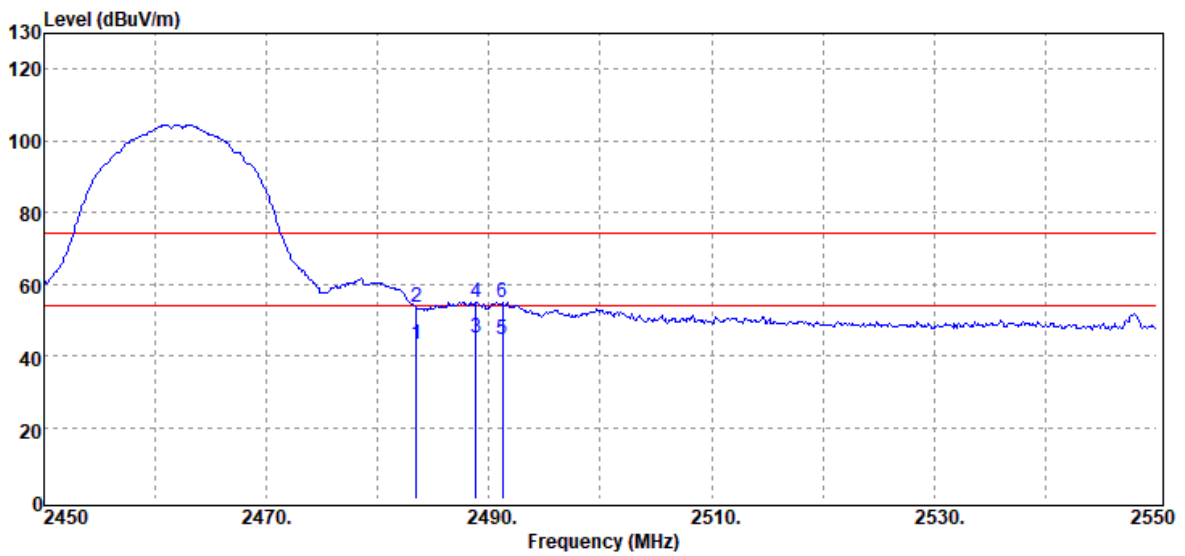

| Frequency (MHz) | Reading (dBuV) | Correct Factor (dB/m) | Result (dBuV/m) | Limit (dBuV/m) | Margin (dB) | Remark |
|-----------------|----------------|-----------------------|-----------------|----------------|-------------|---------|
| 2483.50 | 45.82 | -2.83 | 42.99 | 54.00 | -11.01 | Average |
| 2483.50 | 56.20 | -2.83 | 53.37 | 74.00 | -20.63 | Peak |
| 2488.80 | 47.60 | -2.79 | 44.81 | 54.00 | -9.19 | Average |
| 2488.80 | 57.79 | -2.79 | 55.00 | 74.00 | -19.00 | Peak |
| 2491.20 | 47.16 | -2.78 | 44.38 | 54.00 | -9.62 | Average |
| 2491.20 | 57.63 | -2.78 | 54.85 | 74.00 | -19.15 | Peak |

Report No.: T190711D17-RP

| | | | |
|-----------|---------------------|---------------|-----------------|
| Test Mode | IEEE 802.11g Low CH | Temp/Hum | 31(°C)/ 57%RH |
| Test Item | Band Edge | Test Date | August 05, 2019 |
| Polarize | Vertical | Test Engineer | Jerry Lu |
| Detector | Peak / Average | | |

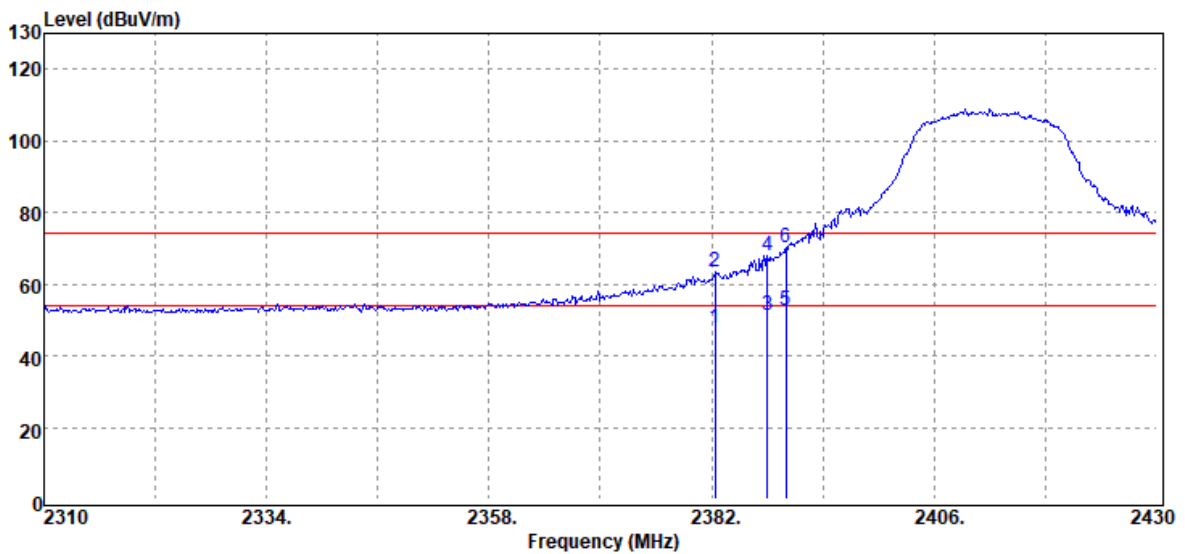

| Frequency (MHz) | Reading (dBuV) | Correct Factor (dB/m) | Result (dBuV/m) | Limit (dBuV/m) | Margin (dB) | Remark |
|-----------------|----------------|-----------------------|-----------------|----------------|-------------|---------|
| 2382.36 | 50.90 | -3.37 | 47.53 | 54.00 | -6.47 | Average |
| 2382.36 | 66.82 | -3.37 | 63.45 | 74.00 | -10.55 | Peak |
| 2388.00 | 54.78 | -3.39 | 51.39 | 54.00 | -2.61 | Average |
| 2388.00 | 71.48 | -3.39 | 68.09 | 74.00 | -5.91 | Peak |
| 2390.00 | 56.01 | -3.38 | 52.63 | 54.00 | -1.37 | Average |
| 2390.00 | 73.33 | -3.38 | 69.95 | 74.00 | -4.05 | Peak |

Report No.: T190711D17-RP

| | | | |
|-----------|---------------------|---------------|-----------------|
| Test Mode | IEEE 802.11g Low CH | Temperature: | 31(°C)/ 57%RH |
| Test Item | Band Edge | Test Date | August 05, 2019 |
| Polarize | Horizontal | Test Engineer | Jerry Lu |
| Detector | Peak / Average | | |

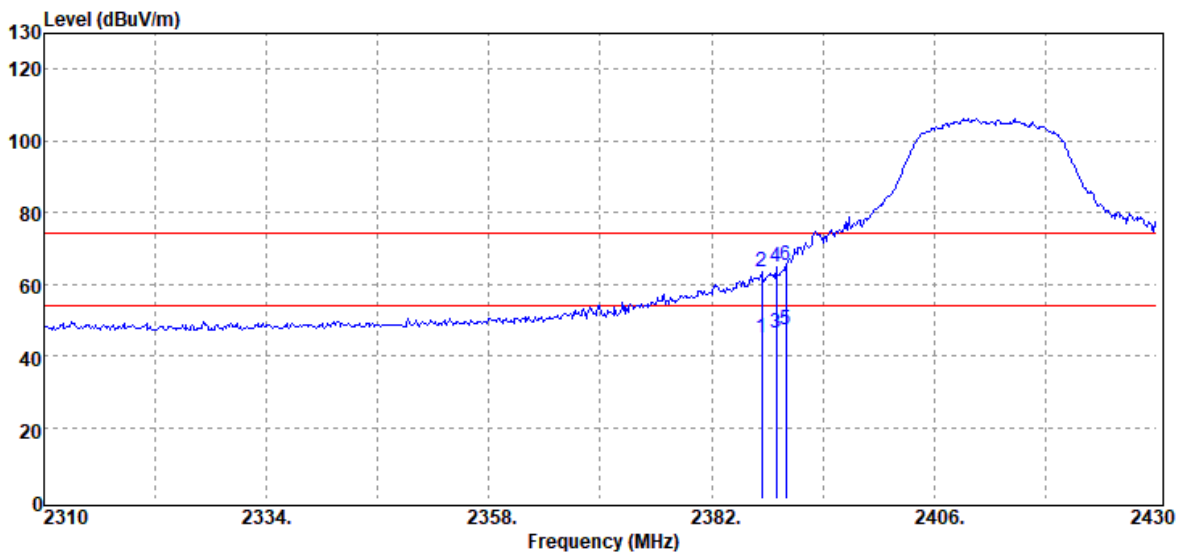

| Frequency (MHz) | Reading (dBuV) | Correct Factor (dB/m) | Result (dBuV/m) | Limit (dBuV/m) | Margin (dB) | Remark |
|-----------------|----------------|-----------------------|-----------------|----------------|-------------|---------|
| 2387.40 | 48.52 | -3.38 | 45.14 | 54.00 | -8.86 | Average |
| 2387.40 | 66.58 | -3.38 | 63.20 | 74.00 | -10.80 | Peak |
| 2388.96 | 49.87 | -3.39 | 46.48 | 54.00 | -7.52 | Average |
| 2388.96 | 68.06 | -3.39 | 64.67 | 74.00 | -9.33 | Peak |
| 2390.00 | 50.54 | -3.38 | 47.16 | 54.00 | -6.84 | Average |
| 2390.00 | 68.74 | -3.38 | 65.36 | 74.00 | -8.64 | Peak |

Report No.: T190711D17-RP

| | | | |
|-----------|----------------------|---------------|-----------------|
| Test Mode | IEEE 802.11g High CH | Temp/Hum | 31(°C)/ 57%RH |
| Test Item | Band Edge | Test Date | August 05, 2019 |
| Polarize | Vertical | Test Engineer | Jerry Lu |
| Detector | Peak / Average | | |

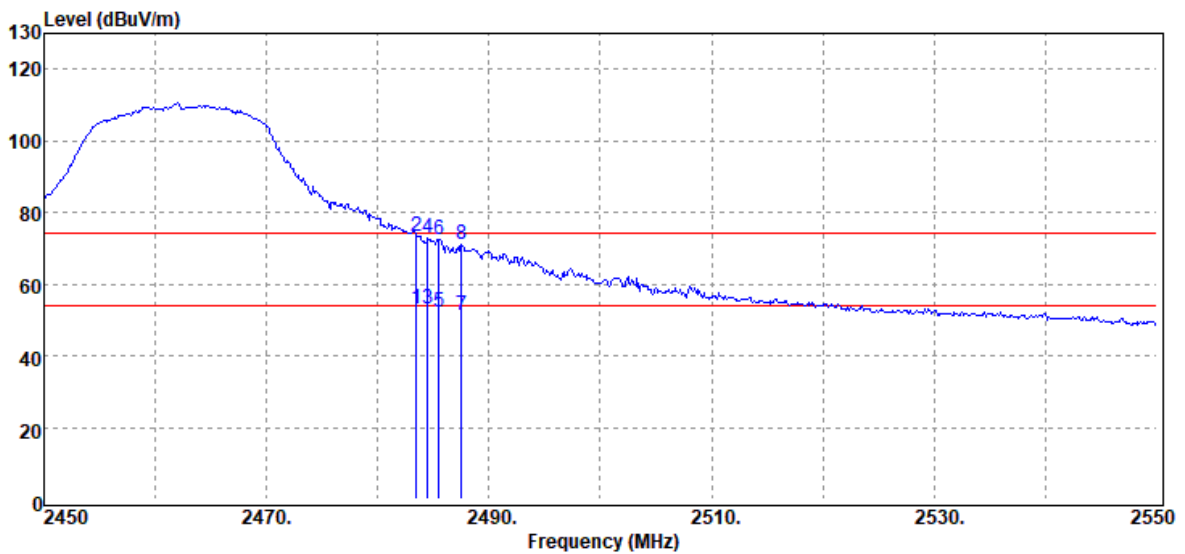

| Frequency (MHz) | Reading (dBUV) | Correct Factor (dB/m) | Result (dBUV/m) | Limit (dBUV/m) | Margin (dB) | Remark |
|-----------------|----------------|-----------------------|-----------------|----------------|-------------|---------|
| 2483.50 | 56.12 | -2.83 | 53.29 | 54.00 | -0.71 | Average |
| 2483.50 | 76.22 | -2.83 | 73.39 | 74.00 | -0.61 | Peak |
| 2484.50 | 55.83 | -2.82 | 53.01 | 54.00 | -0.99 | Average |
| 2484.50 | 75.54 | -2.82 | 72.72 | 74.00 | -1.28 | Peak |
| 2485.50 | 55.07 | -2.82 | 52.25 | 54.00 | -1.75 | Average |
| 2485.50 | 75.31 | -2.82 | 72.49 | 74.00 | -1.51 | Peak |
| 2487.50 | 53.92 | -2.80 | 51.12 | 54.00 | -2.88 | Average |
| 2487.50 | 73.94 | -2.80 | 71.14 | 74.00 | -2.86 | Peak |

Report No.: T190711D17-RP

| | | | |
|-----------|----------------------|---------------|-----------------|
| Test Mode | IEEE 802.11g High CH | Temperature: | 31(°C)/ 57%RH |
| Test Item | Band Edge | Test Date | August 05, 2019 |
| Polarize | Horizontal | Test Engineer | Jerry Lu |
| Detector | Peak / Average | | |

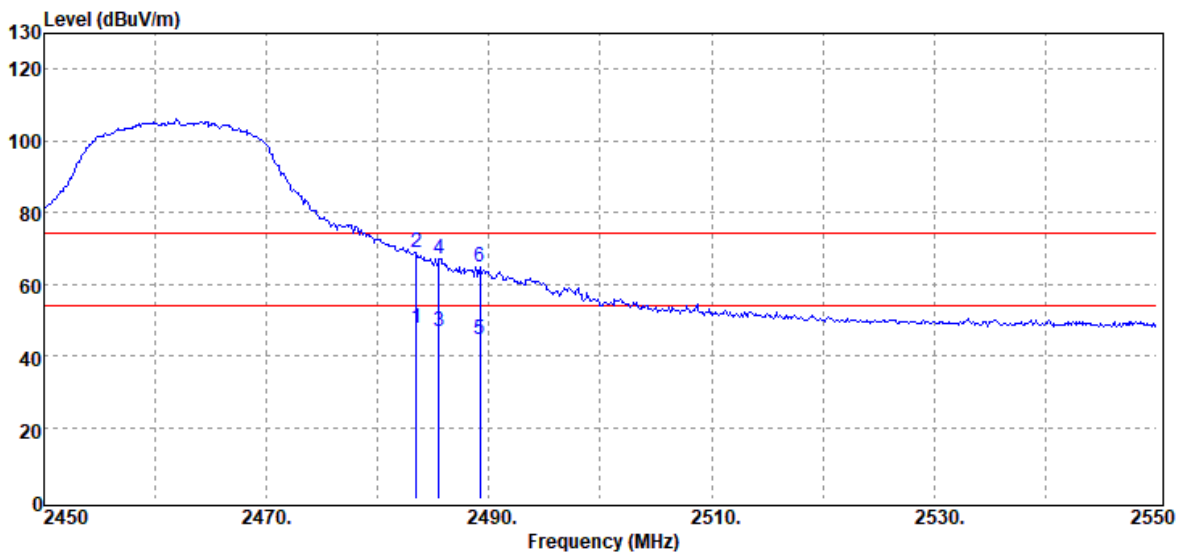

| Frequency (MHz) | Reading (dBuV) | Correct Factor (dB/m) | Result (dBuV/m) | Limit (dBuV/m) | Margin (dB) | Remark |
|-----------------|----------------|-----------------------|-----------------|----------------|-------------|---------|
| 2483.50 | 50.51 | -2.83 | 47.68 | 54.00 | -6.32 | Average |
| 2483.50 | 71.61 | -2.83 | 68.78 | 74.00 | -5.22 | Peak |
| 2485.50 | 49.82 | -2.82 | 47.00 | 54.00 | -7.00 | Average |
| 2485.50 | 70.03 | -2.82 | 67.21 | 74.00 | -6.79 | Peak |
| 2489.20 | 47.34 | -2.78 | 44.56 | 54.00 | -9.44 | Average |
| 2489.20 | 67.52 | -2.78 | 64.74 | 74.00 | -9.26 | Peak |

Report No.: T190711D17-RP

| | | | |
|-----------|--------------------------|---------------|-----------------|
| Test Mode | IEEE 802.11n HT20 Low CH | Temp/Hum | 31(°C)/ 57%RH |
| Test Item | Band Edge | Test Date | August 05, 2019 |
| Polarize | Vertical | Test Engineer | Jerry Lu |
| Detector | Peak / Average | | |

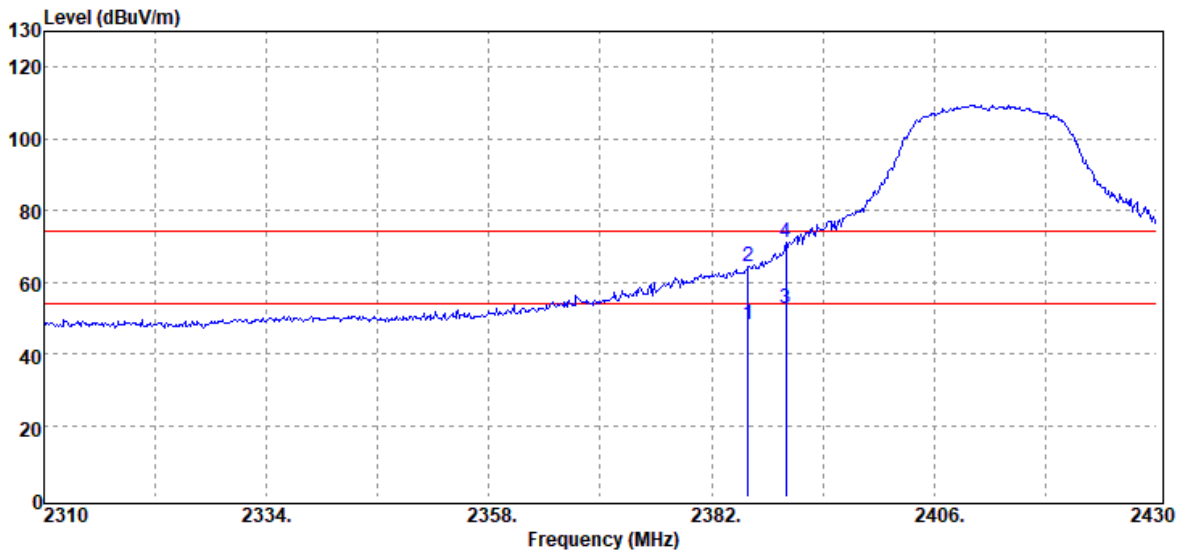

| Frequency (MHz) | Reading (dBuV) | Correct Factor (dB/m) | Result (dBuV/m) | Limit (dBuV/m) | Margin (dB) | Remark |
|-----------------|----------------|-----------------------|-----------------|----------------|-------------|---------|
| 2385.96 | 51.70 | -3.38 | 48.32 | 54.00 | -5.68 | Average |
| 2385.96 | 67.90 | -3.38 | 64.52 | 74.00 | -9.48 | Peak |
| 2390.00 | 56.09 | -3.38 | 52.71 | 54.00 | -1.29 | Average |
| 2390.00 | 74.37 | -3.38 | 70.99 | 74.00 | -3.01 | Peak |

Report No.: T190711D17-RP

| | | | |
|-----------|--------------------------|---------------|-----------------|
| Test Mode | IEEE 802.11n HT20 Low CH | Temperature: | 31(°C)/ 57%RH |
| Test Item | Band Edge | Test Date | August 05, 2019 |
| Polarize | Horizontal | Test Engineer | Jerry Lu |
| Detector | Peak / Average | | |

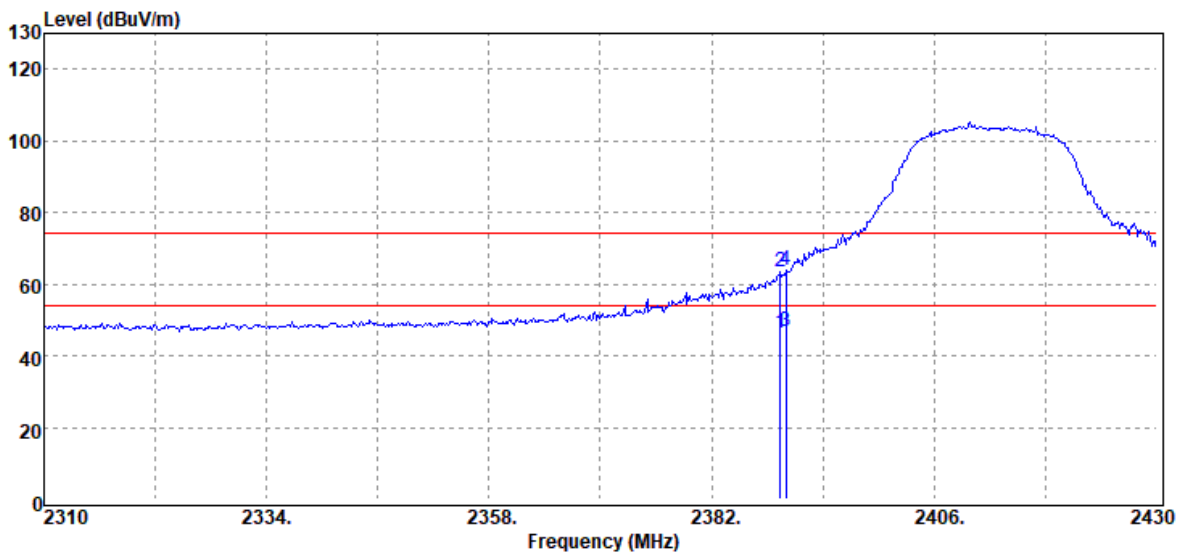

| Frequency (MHz) | Reading (dBuV) | Correct Factor (dB/m) | Result (dBuV/m) | Limit (dBuV/m) | Margin (dB) | Remark |
|-----------------|----------------|-----------------------|-----------------|----------------|-------------|---------|
| 2389.44 | 49.65 | -3.39 | 46.26 | 54.00 | -7.74 | Average |
| 2389.44 | 66.67 | -3.39 | 63.28 | 74.00 | -10.72 | Peak |
| 2390.00 | 50.27 | -3.38 | 46.89 | 54.00 | -7.11 | Average |
| 2390.00 | 67.25 | -3.38 | 63.87 | 74.00 | -10.13 | Peak |

Report No.: T190711D17-RP

| | | | |
|-----------|---------------------------|---------------|-----------------|
| Test Mode | IEEE 802.11n HT20 High CH | Temp/Hum | 31(°C)/ 57%RH |
| Test Item | Band Edge | Test Date | August 05, 2019 |
| Polarize | Vertical | Test Engineer | Jerry Lu |
| Detector | Peak / Average | | |

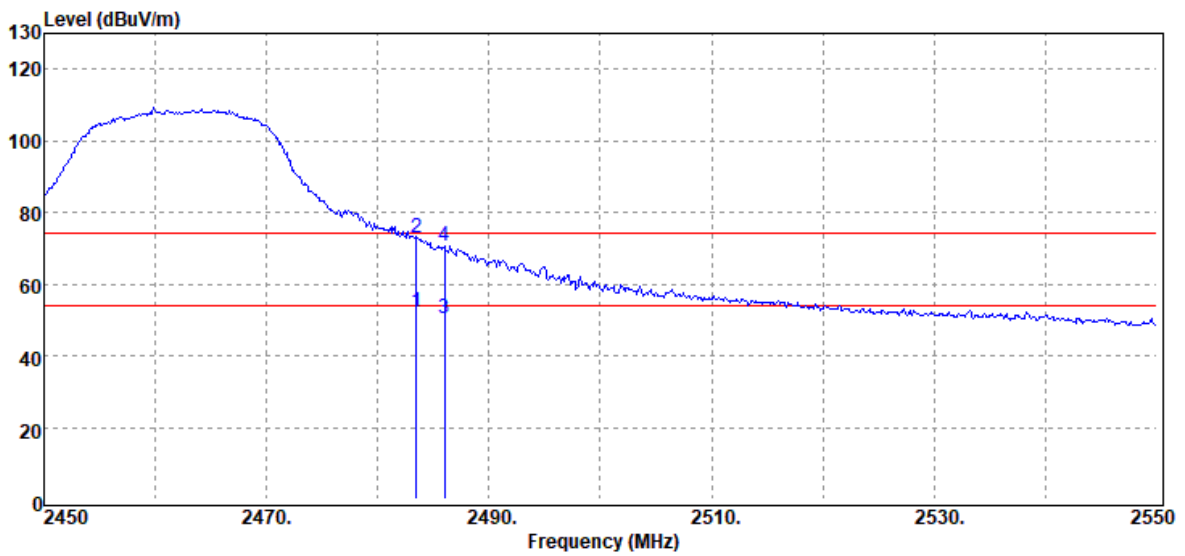

| Frequency (MHz) | Reading (dBuV) | Correct Factor (dB/m) | Result (dBuV/m) | Limit (dBuV/m) | Margin (dB) | Remark |
|-----------------|----------------|-----------------------|-----------------|----------------|-------------|---------|
| 2483.50 | 54.98 | -2.83 | 52.15 | 54.00 | -1.85 | Average |
| 2483.50 | 75.62 | -2.83 | 72.79 | 74.00 | -1.21 | Peak |
| 2486.00 | 53.18 | -2.82 | 50.36 | 54.00 | -3.64 | Average |
| 2486.00 | 73.66 | -2.82 | 70.84 | 74.00 | -3.16 | Peak |

Report No.: T190711D17-RP

| | | | |
|-----------|---------------------------|---------------|-----------------|
| Test Mode | IEEE 802.11n HT20 High CH | Temperature: | 31(°C)/ 57%RH |
| Test Item | Band Edge | Test Date | August 05, 2019 |
| Polarize | Horizontal | Test Engineer | Jerry Lu |
| Detector | Peak / Average | | |

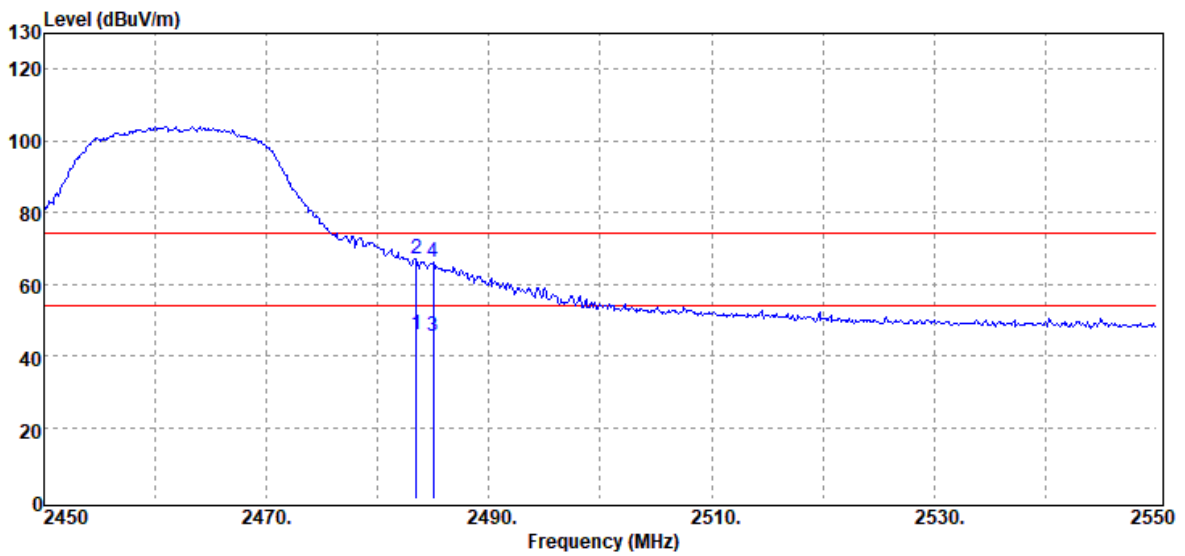

| Frequency (MHz) | Reading (dBuV) | Correct Factor (dB/m) | Result (dBuV/m) | Limit (dBuV/m) | Margin (dB) | Remark |
|-----------------|----------------|-----------------------|-----------------|----------------|-------------|---------|
| 2483.50 | 48.79 | -2.83 | 45.96 | 54.00 | -8.04 | Average |
| 2483.50 | 69.71 | -2.83 | 66.88 | 74.00 | -7.12 | Peak |
| 2485.00 | 48.38 | -2.82 | 45.56 | 54.00 | -8.44 | Average |
| 2485.00 | 68.79 | -2.82 | 65.97 | 74.00 | -8.03 | Peak |

Report No.: T190711D17-RP

Below 1G Test Data

| | | | |
|-----------|------------|---------------|-----------------|
| Test Mode | Mode 1 | Temp/Hum | 30.2(°C)/ 49%RH |
| Test Item | 30MHz-1GHz | Test Date | August 29, 2019 |
| Polarize | Vertical | Test Engineer | Jerry Lu |
| Detector | Peak | | |

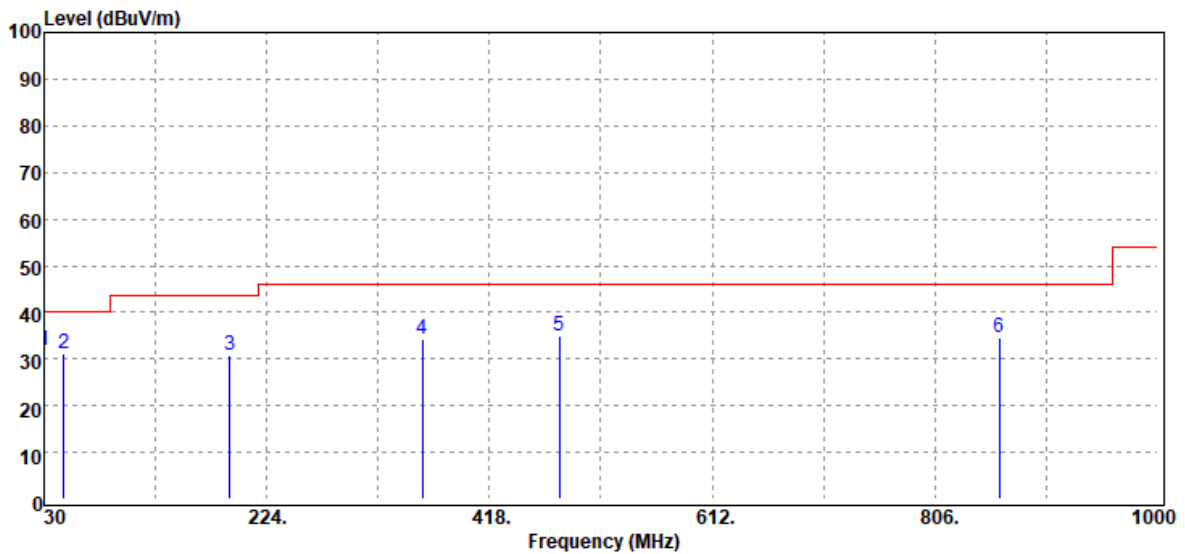

| Frequency (MHz) | Reading (dBUV) | Correct Factor (dB/m) | Result (dBUV/m) | Limit (dBUV/m) | Margin (dB) | Remark |
|-----------------|----------------|-----------------------|-----------------|----------------|-------------|--------|
| 30.00 | 33.48 | -1.51 | 31.97 | 40.00 | -8.03 | Peak |
| 47.46 | 45.33 | -14.26 | 31.07 | 40.00 | -8.93 | Peak |
| 191.99 | 41.32 | -10.55 | 30.77 | 43.50 | -12.73 | Peak |
| 359.80 | 40.98 | -6.59 | 34.39 | 46.00 | -11.61 | Peak |
| 479.11 | 37.95 | -2.98 | 34.97 | 46.00 | -11.03 | Peak |
| 862.26 | 31.75 | 3.00 | 34.75 | 46.00 | -11.25 | Peak |

Note: No emission found between lowest internal used/generated frequency to 30MHz(9KHz~30MHz)

Report No.: T190711D17-RP

| | | | |
|-----------|------------|---------------|-----------------|
| Test Mode | Mode 1 | Temp/Hum | 30.2(°C)/ 49%RH |
| Test Item | 30MHz-1GHz | Test Date | August 29, 2019 |
| Polarize | Horizontal | Test Engineer | Jerry Lu |
| Detector | Peak | | |

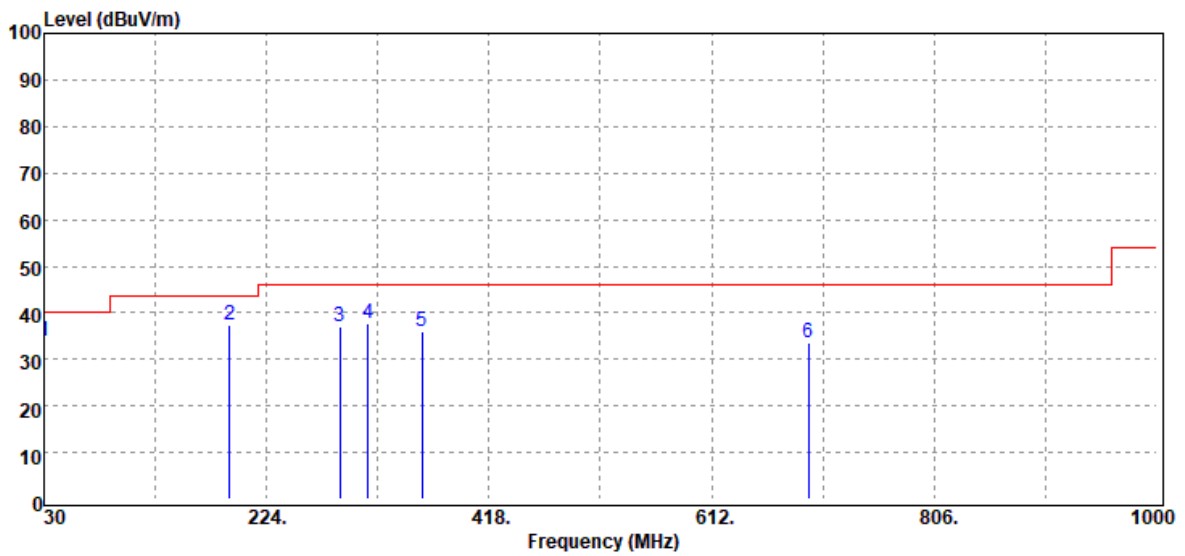

| Frequency (MHz) | Reading (dBuV) | Correct Factor (dB/m) | Result (dBuV/m) | Limit (dBuV/m) | Margin (dB) | Remark |
|-----------------|----------------|-----------------------|-----------------|----------------|-------------|--------|
| 30.00 | 35.37 | -1.51 | 33.86 | 40.00 | -6.14 | Peak |
| 191.99 | 47.97 | -10.55 | 37.42 | 43.50 | -6.08 | Peak |
| 288.02 | 45.48 | -8.39 | 37.09 | 46.00 | -8.91 | Peak |
| 312.27 | 45.64 | -7.84 | 37.80 | 46.00 | -8.20 | Peak |
| 359.80 | 42.66 | -6.59 | 36.07 | 46.00 | -9.93 | Peak |
| 696.39 | 33.86 | -0.16 | 33.70 | 46.00 | -12.30 | Peak |

Note: No emission found between lowest internal used/generated frequency to 30MHz(9KHz~30MHz)

Report No.: T190711D17-RP

Above 1G Test Data

| | | | |
|-----------|---------------------|---------------|-----------------|
| Test Mode | IEEE 802.11b Low CH | Temp/Hum | 31(°C)/ 57%RH |
| Test Item | Harmonic | Test Date | August 05, 2019 |
| Polarize | Vertical | Test Engineer | Jerry Lu |
| Detector | Peak and Average | | |

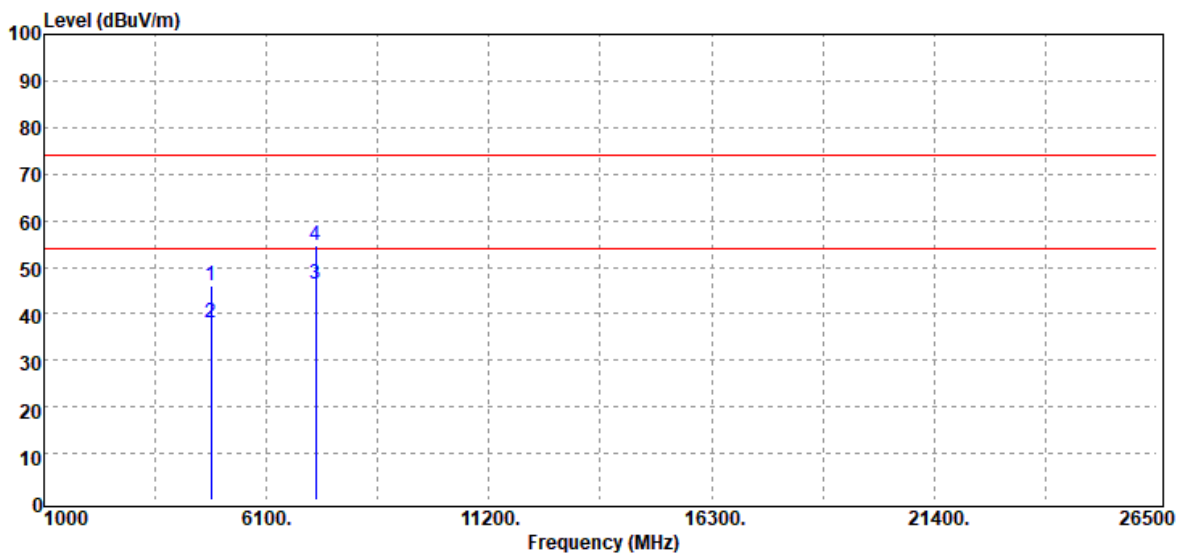

| Frequency (MHz) | Reading (dBuV) | Correct Factor (dB/m) | Result (dBuV/m) | Limit (dBuV/m) | Margin (dB) | Remark |
|-----------------|----------------|-----------------------|-----------------|----------------|-------------|---------|
| 4824.00 | 42.82 | 3.05 | 45.87 | 74.00 | -28.13 | Average |
| 4824.00 | 35.16 | 3.05 | 38.21 | 54.00 | -15.79 | Average |
| 7236.00 | 35.89 | 10.60 | 46.49 | 54.00 | -7.51 | Average |
| 7236.00 | 44.01 | 10.60 | 54.61 | 74.00 | -19.39 | Peak |

Remark:

1. Measuring frequencies from 1 GHz to the 10th harmonic of highest fundamental frequency.

Report No.: T190711D17-RP

| | | | |
|-----------|---------------------|---------------|-----------------|
| Test Mode | IEEE 802.11b Low CH | Temp/Hum | 31(°C)/ 57%RH |
| Test Item | Harmonic | Test Date | August 05, 2019 |
| Polarize | Horizontal | Test Engineer | Jerry Lu |
| Detector | Peak and Average | | |

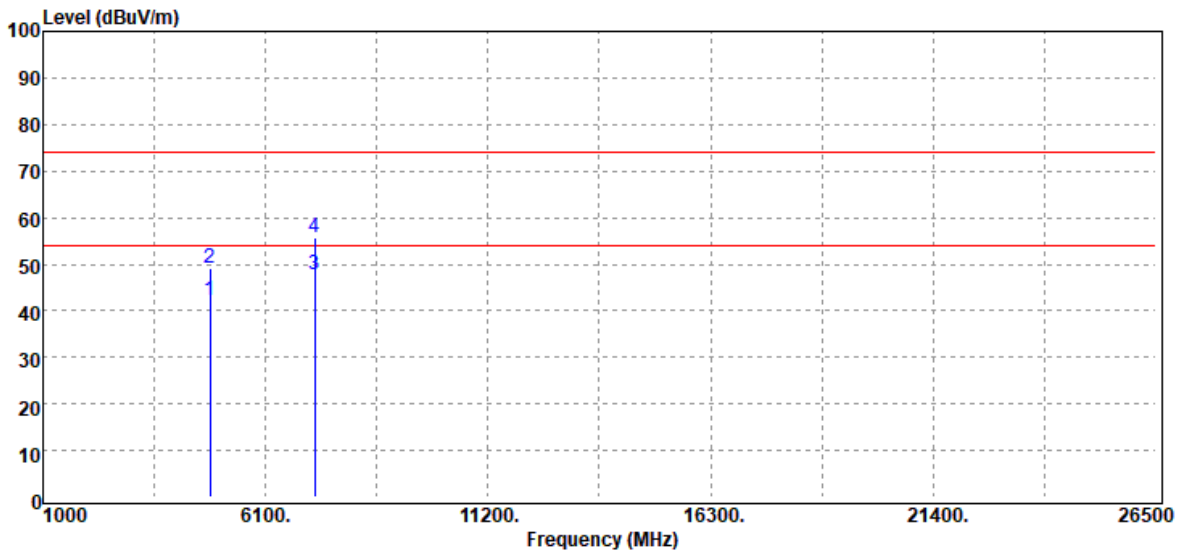

| Frequency (MHz) | Reading (dBuV) | Correct Factor (dB/m) | Result (BuV/m) | Limit (dBuV/m) | Margin (dB) | Remark |
|-----------------|----------------|-----------------------|----------------|----------------|-------------|---------|
| 4824.00 | 39.22 | 3.05 | 42.27 | 54.00 | -11.73 | Average |
| 4824.00 | 46.16 | 3.05 | 49.21 | 74.00 | -24.79 | Peak |
| 7236.00 | 37.25 | 10.60 | 47.85 | 54.00 | -6.15 | Average |
| 7236.00 | 45.21 | 10.60 | 55.81 | 74.00 | -18.19 | Peak |

Remark:

1. Measuring frequencies from 1 GHz to the 10th harmonic of highest fundamental frequency.

Report No.: T190711D17-RP

| | | | |
|-----------|---------------------|---------------|-----------------|
| Test Mode | IEEE 802.11b Mid CH | Temp/Hum | 31(°C)/ 57%RH |
| Test Item | Harmonic | Test Date | August 05, 2019 |
| Polarize | Vertical | Test Engineer | Jerry Lu |
| Detector | Peak and Average | | |

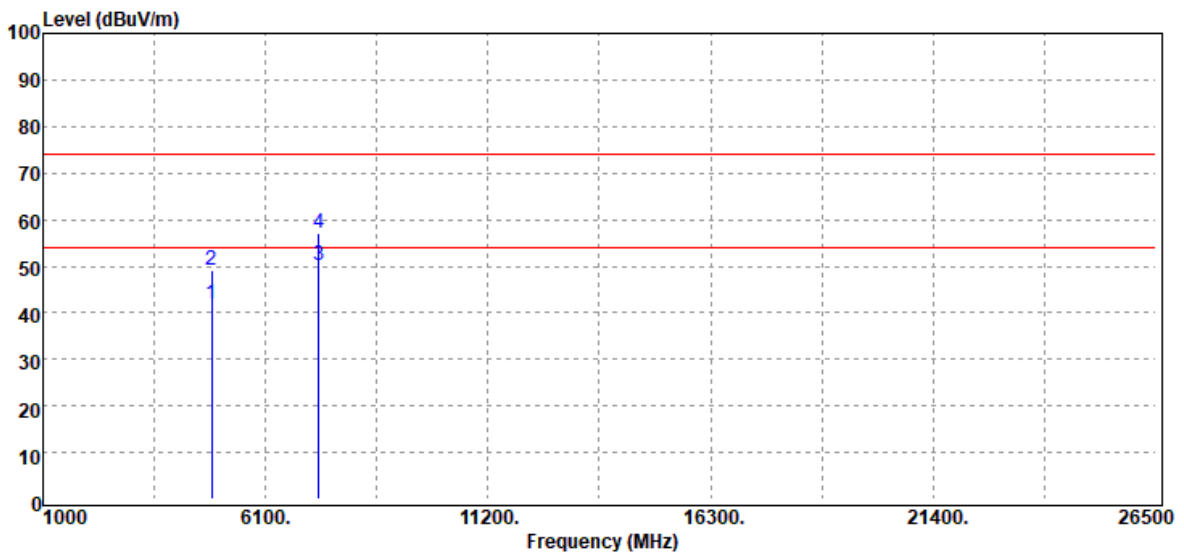

| Frequency (MHz) | Reading (dBu) | Correct Factor (dB/m) | Result (dBuV/m) | Limit (dBuV/m) | Margin (dB) | Remark |
|-----------------|----------------|-----------------------|-----------------|----------------|-------------|---------|
| 4874.00 | 38.40 | 3.31 | 41.71 | 54.00 | -12.29 | Average |
| 4874.00 | 45.76 | 3.31 | 49.07 | 74.00 | -24.93 | Peak |
| 7311.00 | 39.18 | 10.93 | 50.11 | 54.00 | -3.89 | Average |
| 7311.00 | 46.32 | 10.93 | 57.25 | 74.00 | -16.75 | Peak |

Remark:

1. Measuring frequencies from 1 GHz to the 10th harmonic of highest fundamental frequency.

Report No.: T190711D17-RP

| | | | |
|-----------|---------------------|---------------|-----------------|
| Test Mode | IEEE 802.11b Mid CH | Temp/Hum | 31(°C)/ 57%RH |
| Test Item | Harmonic | Test Date | August 05, 2019 |
| Polarize | Horizontal | Test Engineer | Jerry Lu |
| Detector | Peak and Average | | |

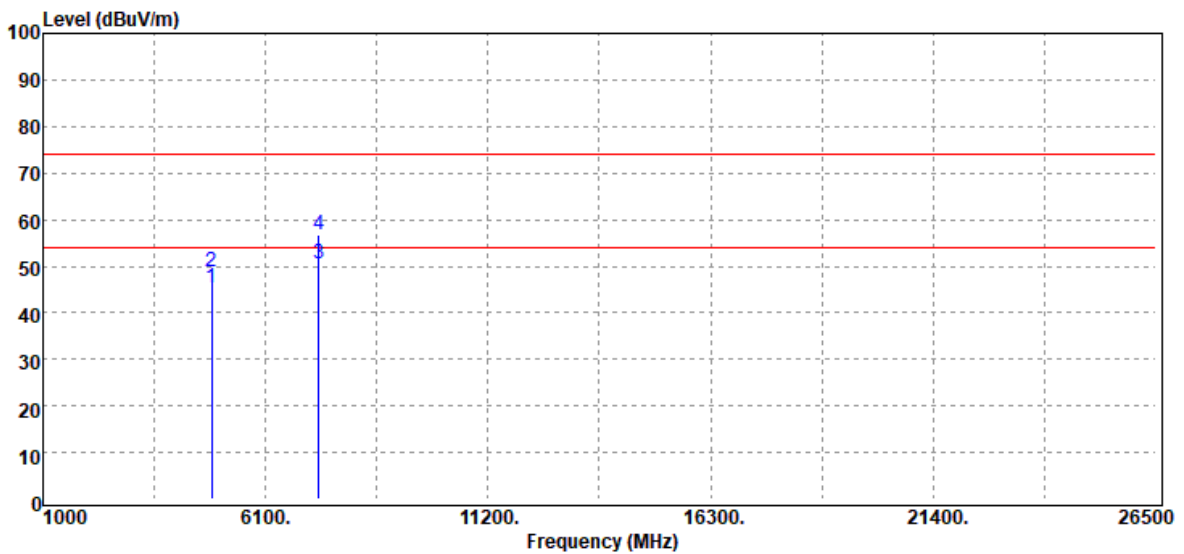

| Frequency (MHz) | Reading (dBuV) | Correct Factor (dB/m) | Result (dBuV/m) | Limit (dBuV/m) | Margin (dB) | Remark |
|-----------------|----------------|-----------------------|-----------------|----------------|-------------|---------|
| 4874.00 | 42.16 | 3.31 | 45.47 | 54.00 | -8.53 | Average |
| 4874.00 | 45.61 | 3.31 | 48.92 | 74.00 | -25.08 | Peak |
| 7311.00 | 39.65 | 10.93 | 50.58 | 54.00 | -3.42 | Average |
| 7311.00 | 45.90 | 10.93 | 56.83 | 74.00 | -17.17 | Peak |

Remark:

1. Measuring frequencies from 1 GHz to the 10th harmonic of highest fundamental frequency.

Report No.: T190711D17-RP

| | | | |
|-----------|----------------------|---------------|-----------------|
| Test Mode | IEEE 802.11b High CH | Temp/Hum | 31(°C)/ 57%RH |
| Test Item | Harmonic | Test Date | August 05, 2019 |
| Polarize | Vertical | Test Engineer | Jerry Lu |
| Detector | Peak and Average | | |

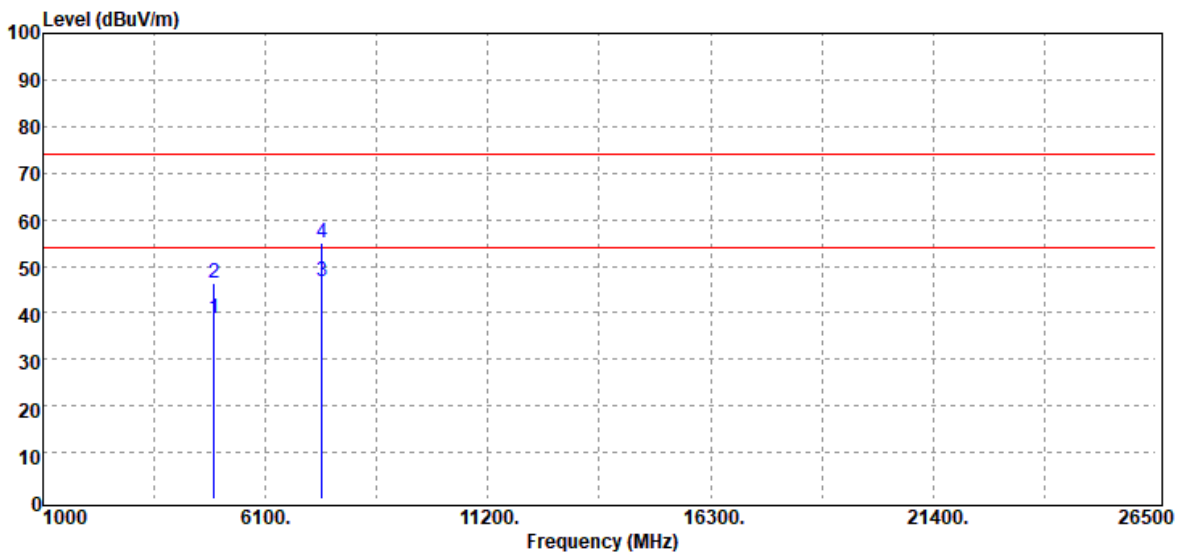

| Frequency (MHz) | Reading (dBuV) | Correct Factor (dB/m) | Result (dBuV/m) | Limit (dBuV/m) | Margin (dB) | Remark |
|-----------------|----------------|-----------------------|-----------------|----------------|-------------|---------|
| 4924.00 | 34.94 | 3.75 | 38.69 | 54.00 | -15.31 | Average |
| 4924.00 | 42.70 | 3.75 | 46.45 | 74.00 | -27.55 | Peak |
| 7386.00 | 35.71 | 11.17 | 46.88 | 54.00 | -7.12 | Average |
| 7386.00 | 43.89 | 11.17 | 55.06 | 74.00 | -18.94 | Peak |

Remark:

1. Measuring frequencies from 1 GHz to the 10th harmonic of highest fundamental frequency.

Report No.: T190711D17-RP

| | | | |
|-----------|----------------------|---------------|-----------------|
| Test Mode | IEEE 802.11b High CH | Temp/Hum | 31(°C)/ 57%RH |
| Test Item | Harmonic | Test Date | August 05, 2019 |
| Polarize | Horizontal | Test Engineer | Jerry Lu |
| Detector | Peak and Average | | |

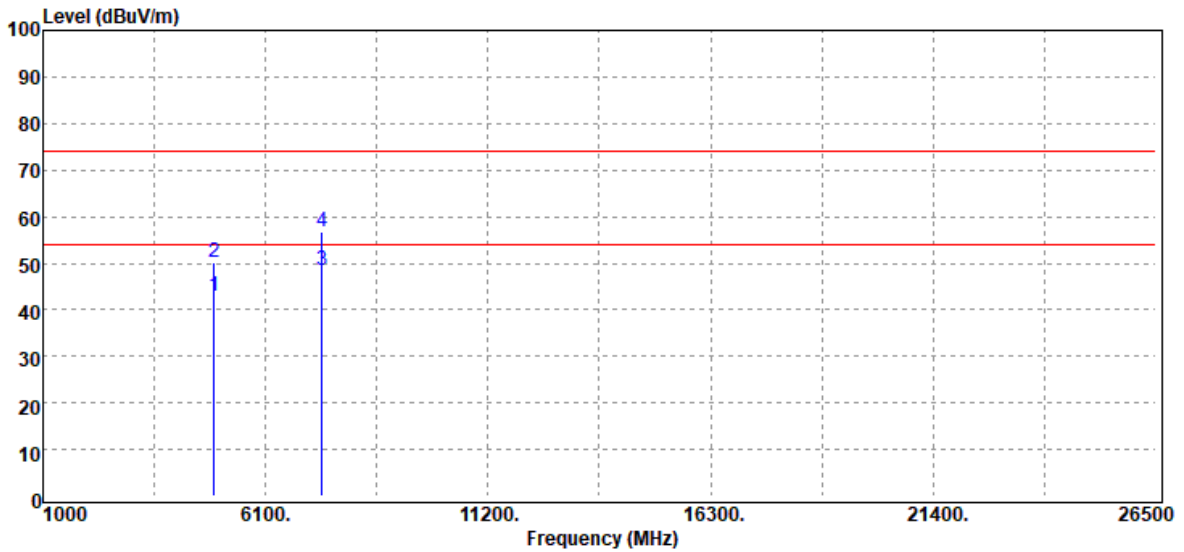

| Frequency (MHz) | Reading (dBuV) | Correct Factor (dB/m) | Result (dBuV/m) | Limit (dBuV/m) | Margin (dB) | Remark |
|-----------------|----------------|-----------------------|-----------------|----------------|-------------|---------|
| 4924.00 | 39.17 | 3.75 | 42.92 | 54.00 | -11.08 | Average |
| 4924.00 | 46.36 | 3.75 | 50.11 | 74.00 | -23.89 | Peak |
| 7386.00 | 37.29 | 11.17 | 48.46 | 54.00 | -5.54 | Average |
| 7386.00 | 45.57 | 11.17 | 56.74 | 74.00 | -17.26 | Peak |

Remark:

1. Measuring frequencies from 1 GHz to the 10th harmonic of highest fundamental frequency.

Report No.: T190711D17-RP

| | | | |
|-----------|---------------------|---------------|-----------------|
| Test Mode | IEEE 802.11g Low CH | Temp/Hum | 31(°C)/ 57%RH |
| Test Item | Harmonic | Test Date | August 05, 2019 |
| Polarize | Vertical | Test Engineer | Jerry Lu |
| Detector | Peak and Average | | |

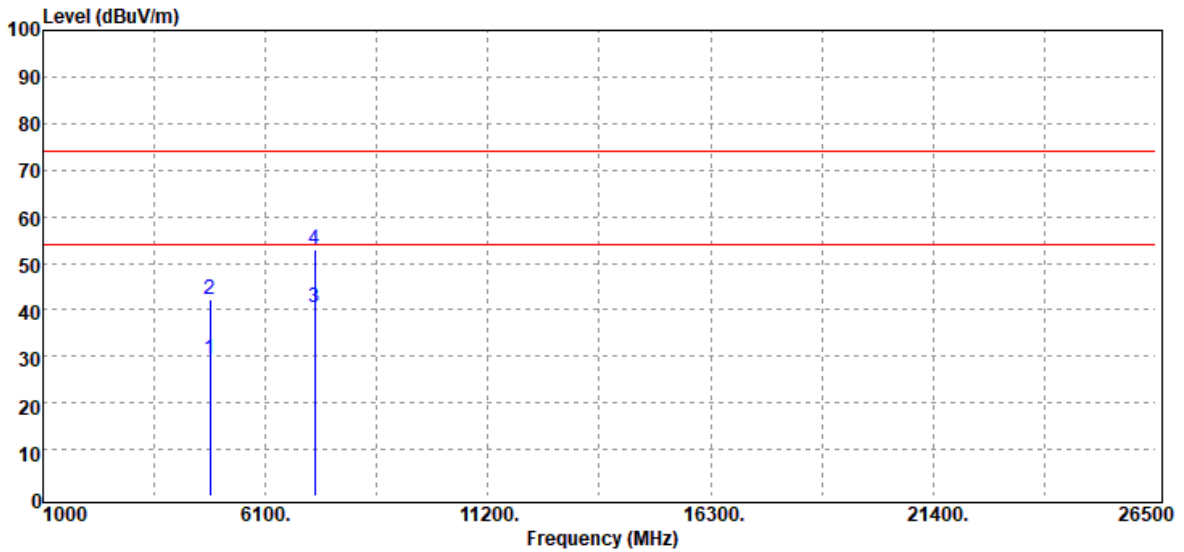

| Frequency (MHz) | Reading (dBuV) | Correct Factor (dB/m) | Result (dBuV/m) | Limit (dBuV/m) | Margin (dB) | Remark |
|-----------------|----------------|-----------------------|-----------------|----------------|-------------|---------|
| 4824.00 | 26.23 | 3.05 | 29.28 | 54.00 | -24.72 | Average |
| 4824.00 | 39.27 | 3.05 | 42.32 | 74.00 | -31.68 | Peak |
| 7236.00 | 29.72 | 10.60 | 40.32 | 54.00 | -13.68 | Average |
| 7236.00 | 42.35 | 10.60 | 52.95 | 74.00 | -21.05 | Peak |

Remark:

1. Measuring frequencies from 1 GHz to the 10th harmonic of highest fundamental frequency.

Report No.: T190711D17-RP

| | | | |
|-----------|---------------------|---------------|-----------------|
| Test Mode | IEEE 802.11g Low CH | Temp/Hum | 31(°C)/ 57%RH |
| Test Item | Harmonic | Test Date | August 05, 2019 |
| Polarize | Horizontal | Test Engineer | Jerry Lu |
| Detector | Peak and Average | | |

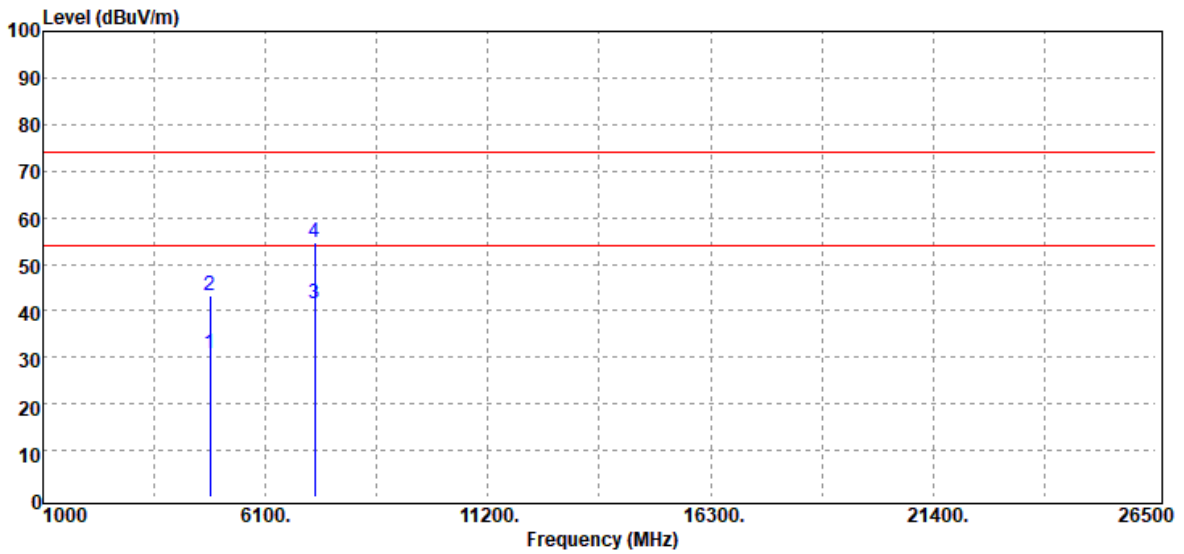

| Frequency (MHz) | Reading (dBuV) | Correct Factor (dB/m) | Result (BuV/m) | Limit (dBuV/m) | Margin (dB) | Remark |
|-----------------|----------------|-----------------------|----------------|----------------|-------------|---------|
| 4824.00 | 27.62 | 3.05 | 30.67 | 54.00 | -23.33 | Average |
| 4824.00 | 40.36 | 3.05 | 43.41 | 74.00 | -30.59 | Peak |
| 7236.00 | 30.85 | 10.60 | 41.45 | 54.00 | -12.55 | Average |
| 7236.00 | 44.13 | 10.60 | 54.73 | 74.00 | -19.27 | Peak |

Remark:

1. Measuring frequencies from 1 GHz to the 10th harmonic of highest fundamental frequency.

Report No.: T190711D17-RP

| | | | |
|-----------|---------------------|---------------|-----------------|
| Test Mode | IEEE 802.11g Mid CH | Temp/Hum | 31(°C)/ 57%RH |
| Test Item | Harmonic | Test Date | August 05, 2019 |
| Polarize | Vertical | Test Engineer | Jerry Lu |
| Detector | Peak and Average | | |

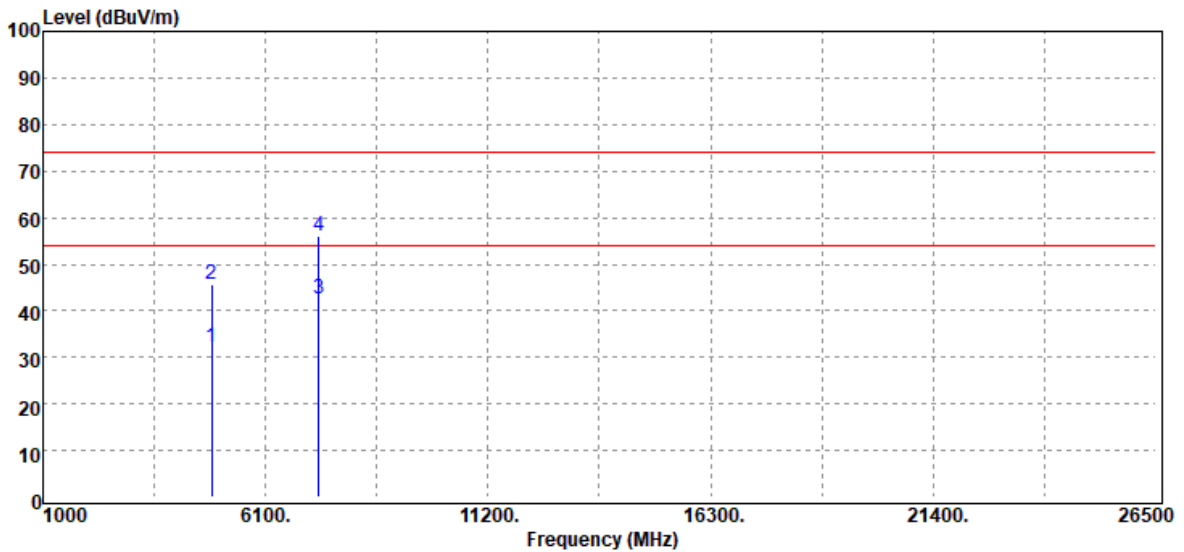

| Frequency (MHz) | Reading (dBu) | Correct Factor (dB/m) | Result (dBuV/m) | Limit (dBuV/m) | Margin (dB) | Remark |
|-----------------|----------------|-----------------------|-----------------|----------------|-------------|---------|
| 4874.00 | 28.73 | 3.31 | 32.04 | 54.00 | -21.96 | Average |
| 4874.00 | 42.52 | 3.31 | 45.83 | 74.00 | -28.17 | Peak |
| 7311.00 | 31.79 | 10.93 | 42.72 | 54.00 | -11.28 | Average |
| 7311.00 | 45.22 | 10.93 | 56.15 | 74.00 | -17.85 | Peak |

Remark:

1. Measuring frequencies from 1 GHz to the 10th harmonic of highest fundamental frequency.

Report No.: T190711D17-RP

| | | | |
|-----------|---------------------|---------------|-----------------|
| Test Mode | IEEE 802.11g Mid CH | Temp/Hum | 31(°C)/ 57%RH |
| Test Item | Harmonic | Test Date | August 05, 2019 |
| Polarize | Horizontal | Test Engineer | Jerry Lu |
| Detector | Peak and Average | | |

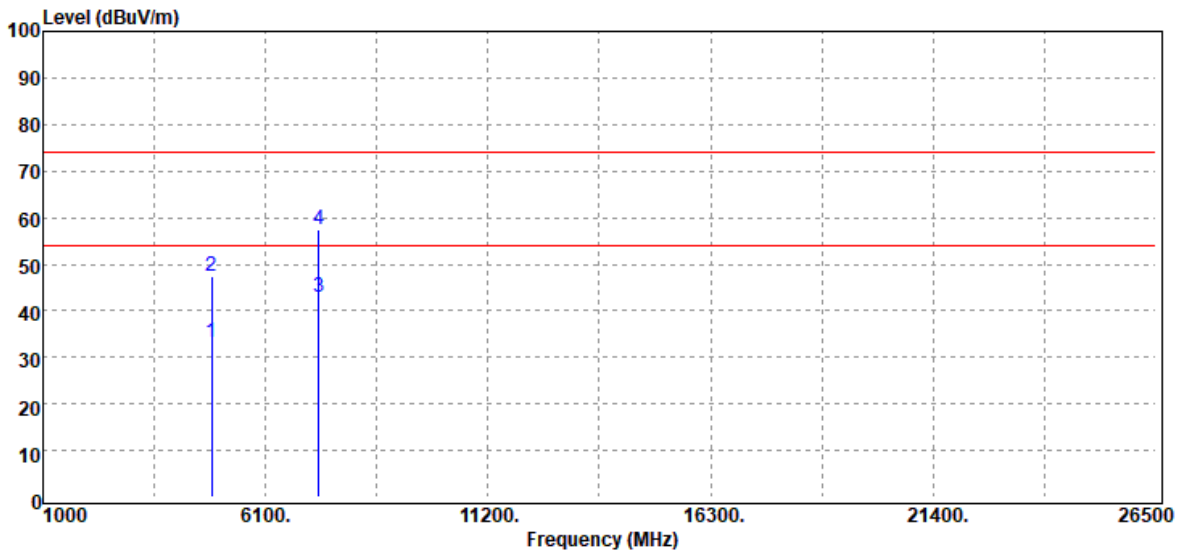

| Frequency (MHz) | Reading (dBuV) | Correct Factor (dB/m) | Result (dBuV/m) | Limit (dBuV/m) | Margin (dB) | Remark |
|-----------------|----------------|-----------------------|-----------------|----------------|-------------|---------|
| 4874.00 | 29.96 | 3.31 | 33.27 | 54.00 | -20.73 | Average |
| 4874.00 | 43.96 | 3.31 | 47.27 | 74.00 | -26.73 | Peak |
| 7311.00 | 32.15 | 10.93 | 43.08 | 54.00 | -10.92 | Average |
| 7311.00 | 46.55 | 10.93 | 57.48 | 74.00 | -16.52 | Peak |

Remark:

1. Measuring frequencies from 1 GHz to the 10th harmonic of highest fundamental frequency.

Report No.: T190711D17-RP

| | | | |
|-----------|----------------------|---------------|-----------------|
| Test Mode | IEEE 802.11g High CH | Temp/Hum | 31(°C)/ 57%RH |
| Test Item | Harmonic | Test Date | August 05, 2019 |
| Polarize | Vertical | Test Engineer | Jerry Lu |
| Detector | Peak and Average | | |

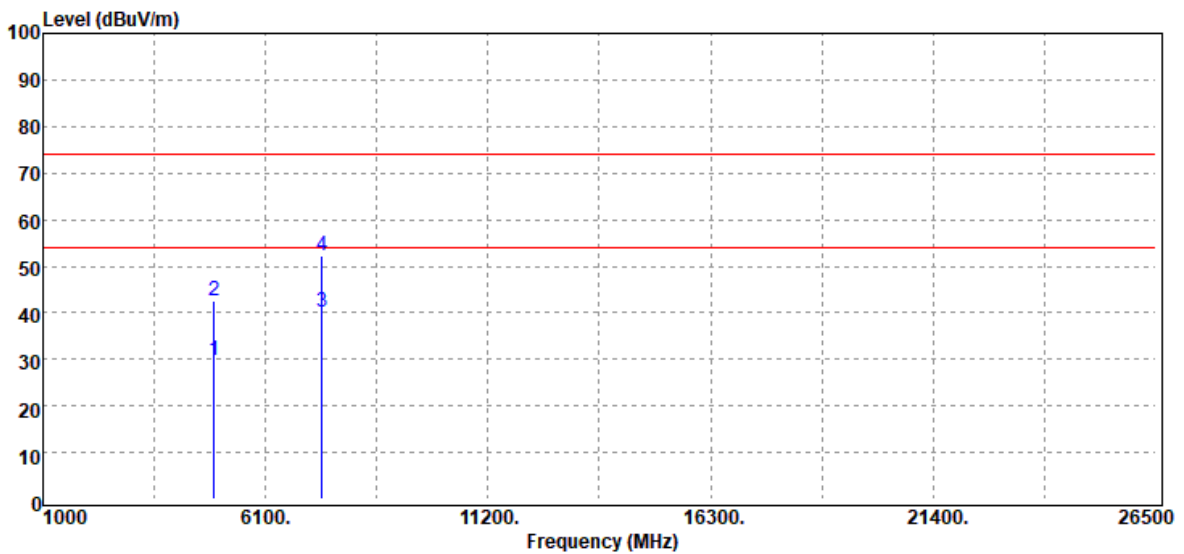

| Frequency (MHz) | Reading (dBuV) | Correct Factor (dB/m) | Result (dBuV/m) | Limit (dBuV/m) | Margin (dB) | Remark |
|-----------------|----------------|-----------------------|-----------------|----------------|-------------|---------|
| 4924.00 | 25.89 | 3.75 | 29.64 | 54.00 | -24.36 | Average |
| 4924.00 | 38.77 | 3.75 | 42.52 | 74.00 | -31.48 | Peak |
| 7386.00 | 29.13 | 11.17 | 40.30 | 54.00 | -13.70 | Average |
| 7386.00 | 41.25 | 11.17 | 52.42 | 74.00 | -21.58 | Peak |

Remark:

1. Measuring frequencies from 1 GHz to the 10th harmonic of highest fundamental frequency.

Report No.: T190711D17-RP

| | | | |
|-----------|----------------------|---------------|-----------------|
| Test Mode | IEEE 802.11g High CH | Temp/Hum | 31(°C)/ 57%RH |
| Test Item | Harmonic | Test Date | August 05, 2019 |
| Polarize | Horizontal | Test Engineer | Jerry Lu |
| Detector | Peak and Average | | |

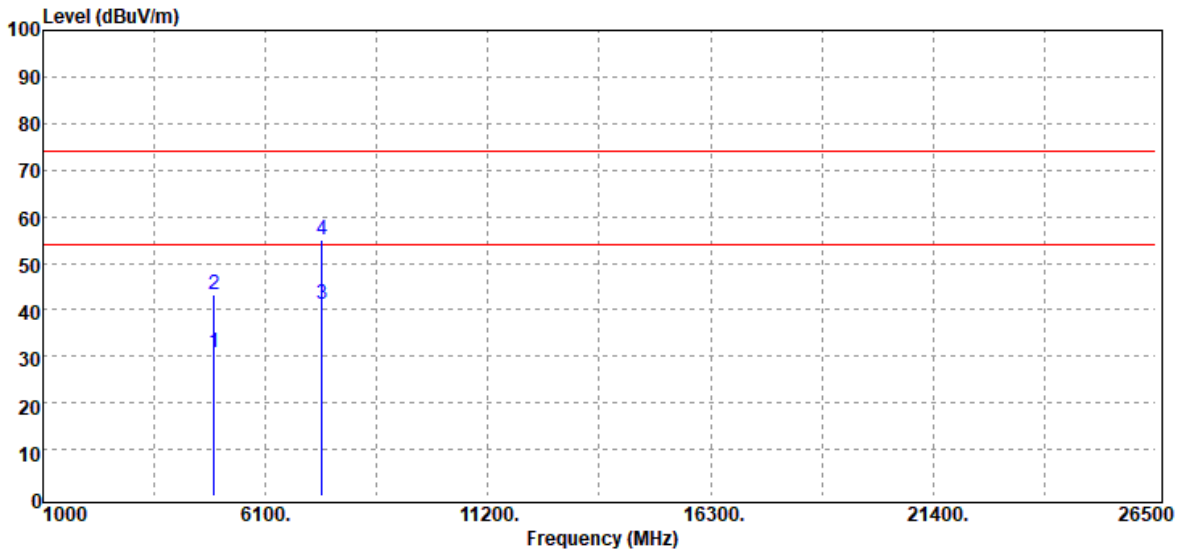

| Frequency (MHz) | Reading (dBuV) | Correct Factor (dB/m) | Result (dBuV/m) | Limit (dBuV/m) | Margin (dB) | Remark |
|-----------------|----------------|-----------------------|-----------------|----------------|-------------|---------|
| 4924.00 | 27.22 | 3.75 | 30.97 | 54.00 | -23.03 | Average |
| 4924.00 | 39.59 | 3.75 | 43.34 | 74.00 | -30.66 | Peak |
| 7386.00 | 30.15 | 11.17 | 41.32 | 54.00 | -12.68 | Average |
| 7386.00 | 43.88 | 11.17 | 55.05 | 74.00 | -18.95 | Peak |

Remark:

1. Measuring frequencies from 1 GHz to the 10th harmonic of highest fundamental frequency.

Report No.: T190711D17-RP

| | | | |
|-----------|--------------------------|---------------|-----------------|
| Test Mode | IEEE 802.11n HT20 Low CH | Temp/Hum | 31(°C)/ 57%RH |
| Test Item | Harmonic | Test Date | August 05, 2019 |
| Polarize | Vertical | Test Engineer | Jerry Lu |
| Detector | Peak and Average | | |

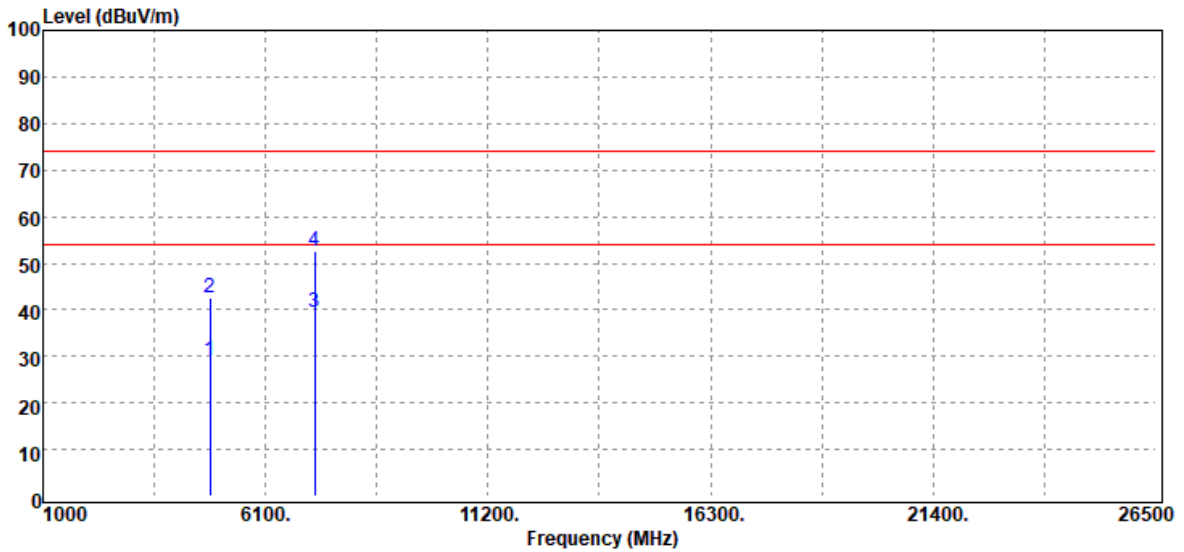

| Frequency (MHz) | Reading (dBuV) | Correct Factor (dB/m) | Result (dBuV/m) | Limit (dBuV/m) | Margin (dB) | Remark |
|-----------------|----------------|-----------------------|-----------------|----------------|-------------|---------|
| 4824.00 | 26.10 | 3.05 | 29.15 | 54.00 | -24.85 | Average |
| 4824.00 | 39.36 | 3.05 | 42.41 | 74.00 | -31.59 | Peak |
| 7236.00 | 28.83 | 10.60 | 39.43 | 54.00 | -14.57 | Average |
| 7236.00 | 42.03 | 10.60 | 52.63 | 74.00 | -21.37 | Peak |

Remark:

1. Measuring frequencies from 1 GHz to the 10th harmonic of highest fundamental frequency.

Report No.: T190711D17-RP

| | | | |
|-----------|--------------------------|---------------|-----------------|
| Test Mode | IEEE 802.11n HT20 Low CH | Temp/Hum | 31(°C)/ 57%RH |
| Test Item | Harmonic | Test Date | August 05, 2019 |
| Polarize | Horizontal | Test Engineer | Jerry Lu |
| Detector | Peak and Average | | |

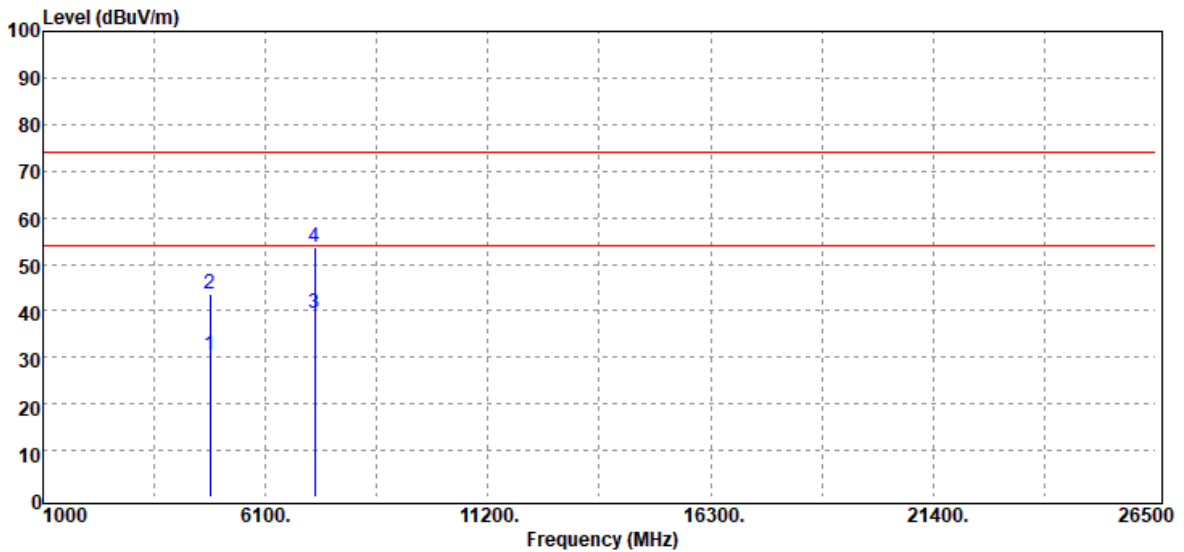

| Frequency (MHz) | Reading (dBuV) | Correct Factor (dB/m) | Result (dBuV/m) | Limit (dBuV/m) | Margin (dB) | Remark |
|-----------------|----------------|-----------------------|-----------------|----------------|-------------|---------|
| 4824.00 | 27.57 | 3.05 | 30.62 | 54.00 | -23.38 | Average |
| 4824.00 | 40.42 | 3.05 | 43.47 | 74.00 | -30.53 | Peak |
| 7236.00 | 29.02 | 10.60 | 39.62 | 54.00 | -14.38 | Average |
| 7236.00 | 43.19 | 10.60 | 53.79 | 74.00 | -20.21 | Peak |

Remark:

1. Measuring frequencies from 1 GHz to the 10th harmonic of highest fundamental frequency.

Report No.: T190711D17-RP

| | | | |
|-----------|--------------------------|---------------|-----------------|
| Test Mode | IEEE 802.11n HT20 Mid CH | Temp/Hum | 31(°C)/ 57%RH |
| Test Item | Harmonic | Test Date | August 05, 2019 |
| Polarize | Vertical | Test Engineer | Jerry Lu |
| Detector | Peak and Average | | |

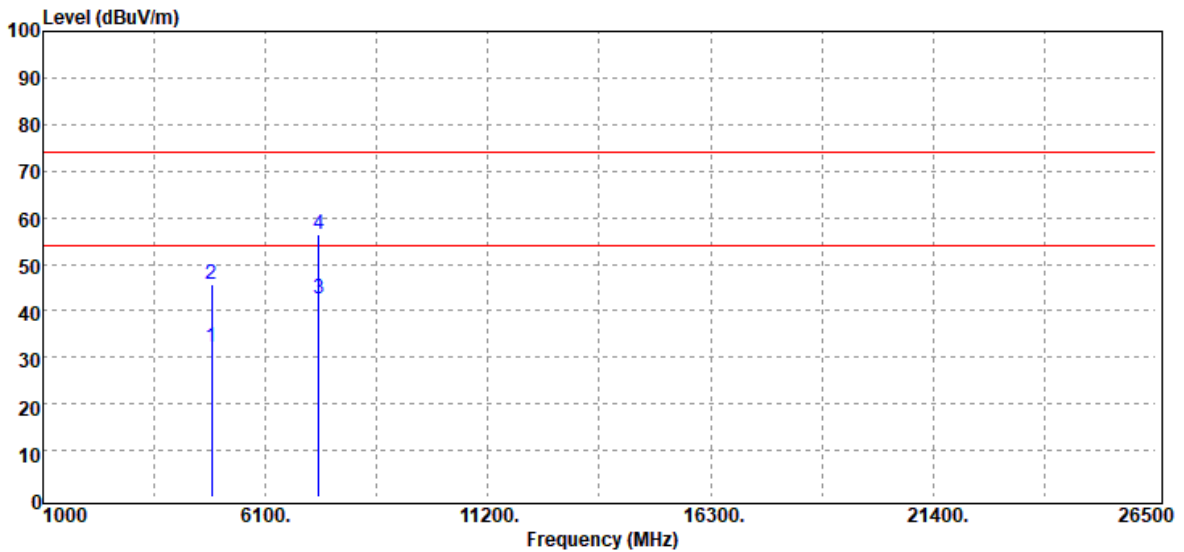

| Frequency (MHz) | Reading (dBuV) | Correct Factor (dB/m) | Result (dBuV/m) | Limit (dBuV/m) | Margin (dB) | Remark |
|-----------------|----------------|-----------------------|-----------------|----------------|-------------|---------|
| 4874.00 | 28.84 | 3.31 | 32.15 | 54.00 | -21.85 | Average |
| 4874.00 | 42.40 | 3.31 | 45.71 | 74.00 | -28.29 | Peak |
| 7311.00 | 31.80 | 10.93 | 42.73 | 54.00 | -11.27 | Average |
| 7311.00 | 45.33 | 10.93 | 56.26 | 74.00 | -17.74 | Peak |

Remark:

1. Measuring frequencies from 1 GHz to the 10th harmonic of highest fundamental frequency.

Report No.: T190711D17-RP

| | | | |
|-----------|--------------------------|---------------|-----------------|
| Test Mode | IEEE 802.11n HT20 Mid CH | Temp/Hum | 31(°C)/ 57%RH |
| Test Item | Harmonic | Test Date | August 05, 2019 |
| Polarize | Horizontal | Test Engineer | Jerry Lu |
| Detector | Peak and Average | | |

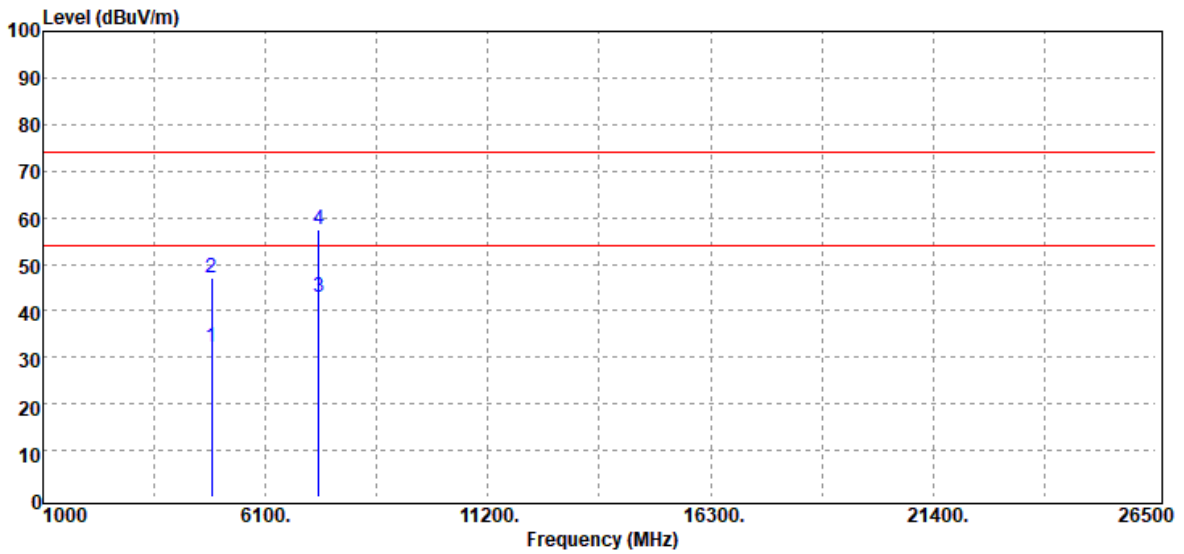

| Frequency (MHz) | Reading (dBuV) | Correct Factor (dB/m) | Result (dBuV/m) | Limit (dBuV/m) | Margin (dB) | Remark |
|-----------------|----------------|-----------------------|-----------------|----------------|-------------|---------|
| 4874.00 | 29.01 | 3.31 | 32.32 | 54.00 | -21.68 | Average |
| 4874.00 | 43.74 | 3.31 | 47.05 | 74.00 | -26.95 | Peak |
| 7311.00 | 31.95 | 10.93 | 42.88 | 54.00 | -11.12 | Average |
| 7311.00 | 46.51 | 10.93 | 57.44 | 74.00 | -16.56 | Peak |

Remark:

1. Measuring frequencies from 1 GHz to the 10th harmonic of highest fundamental frequency.

Report No.: T190711D17-RP

| | | | |
|-----------|---------------------------|---------------|-----------------|
| Test Mode | IEEE 802.11n HT20 High CH | Temp/Hum | 31(°C)/ 57%RH |
| Test Item | Harmonic | Test Date | August 05, 2019 |
| Polarize | Vertical | Test Engineer | Jerry Lu |
| Detector | Peak and Average | | |

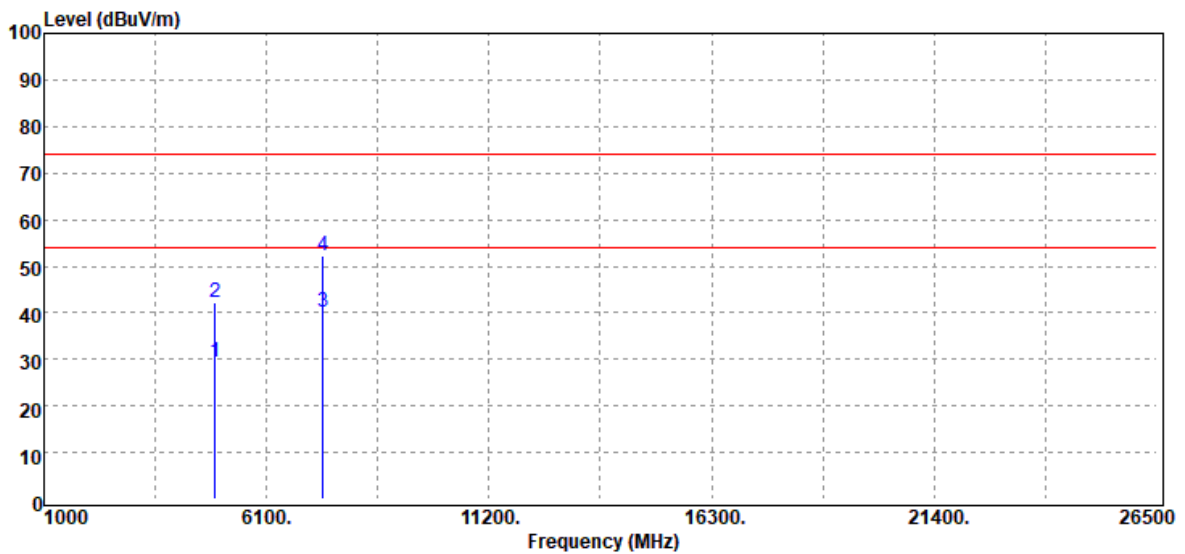

| Frequency (MHz) | Reading (dBuV) | Correct Factor (dB/m) | Result (dBuV/m) | Limit (dBuV/m) | Margin (dB) | Remark |
|-----------------|----------------|-----------------------|-----------------|----------------|-------------|---------|
| 4924.00 | 25.51 | 3.75 | 29.26 | 54.00 | -24.74 | Average |
| 4924.00 | 38.63 | 3.75 | 42.38 | 74.00 | -31.62 | Peak |
| 7386.00 | 28.80 | 11.17 | 39.97 | 54.00 | -14.03 | Average |
| 7386.00 | 41.03 | 11.17 | 52.20 | 74.00 | -21.80 | Peak |

Remark:

1. Measuring frequencies from 1 GHz to the 10th harmonic of highest fundamental frequency.

Report No.: T190711D17-RP

| | | | |
|-----------|---------------------------|---------------|-----------------|
| Test Mode | IEEE 802.11n HT20 High CH | Temp/Hum | 31(°C)/ 57%RH |
| Test Item | Harmonic | Test Date | August 05, 2019 |
| Polarize | Horizontal | Test Engineer | Jerry Lu |
| Detector | Peak and Average | | |

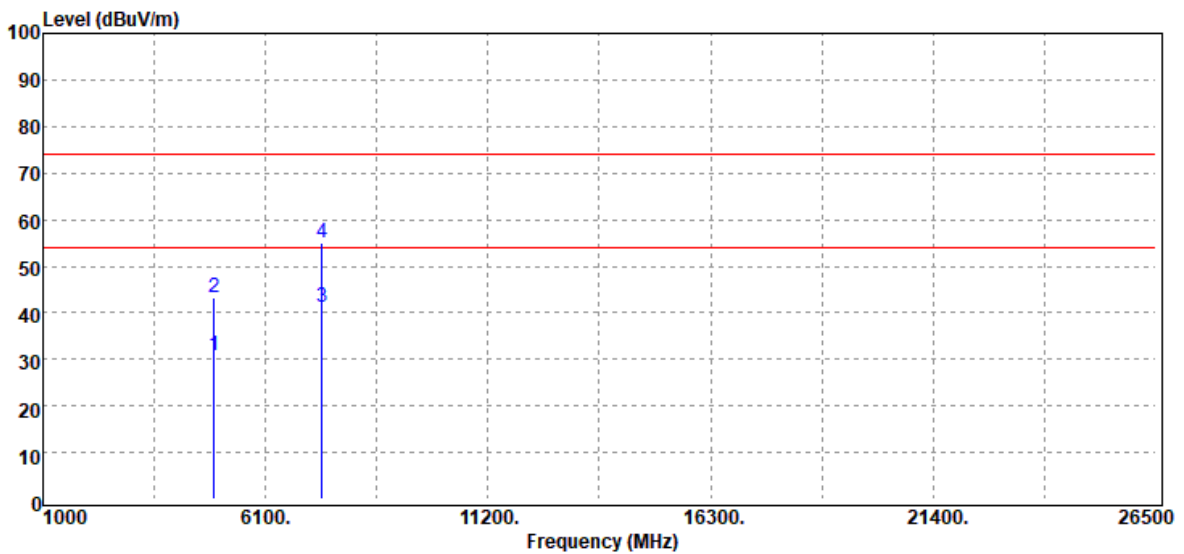

| Frequency (MHz) | Reading (dBuV) | Correct Factor (dB/m) | Result (dBuV/m) | Limit (dBuV/m) | Margin (dB) | Remark |
|-----------------|----------------|-----------------------|-----------------|----------------|-------------|---------|
| 4924.00 | 27.12 | 3.75 | 30.87 | 54.00 | -23.13 | Average |
| 4924.00 | 39.36 | 3.75 | 43.11 | 74.00 | -30.89 | Peak |
| 7386.00 | 29.85 | 11.17 | 41.02 | 54.00 | -12.98 | Average |
| 7386.00 | 43.69 | 11.17 | 54.86 | 74.00 | -19.14 | Peak |

Remark:

1. Measuring frequencies from 1 GHz to the 10th harmonic of highest fundamental frequency.

--End of Test Report--