



FCC TEST REPORT

REPORT NO.: RF131108D08
MODEL NO.: SR-KPD02, BASIC KEYPAD
FCC ID: P27BASICKEYPAD
RECEIVED: Nov. 8, 2013
TESTED: Nov. 14 ~ Dec. 12, 2013
ISSUED: Dec. 31, 2013

APPLICANT: Sercomm Corp.

ADDRESS: 8F, No.3-1, YuangQu St., NanKang, Taipei
115, Taiwan, R.O.C. (NanKang Software Park)

ISSUED BY: Bureau Veritas Consumer Products Services
(H.K.) Ltd., Taoyuan Branch

LAB ADDRESS: No. 47, 14th Ling, Chia Pau Vil., Lin Kou Dist.,
New Taipei City, Taiwan, R.O.C.

This report should not be used by the client to claim product certification, approval, or endorsement by TAF or any government agencies.



This report is for your exclusive use. Any copying or replication of this report to or for any other person or entity, or use of our name or trademark, is permitted only with our prior written permission. This report sets forth our findings solely with respect to the test samples identified herein. The results set forth in this report are not indicative or representative of the quality or characteristics of the lot from which a test sample was taken or any similar or identical product unless specifically and expressly noted. Our report includes all of the tests requested by you and the results thereof based upon the information that you provided to us. You have 60 days from date of issuance of this report to notify us of any material error or omission caused by our negligence, provided, however, that such notice shall be in writing and shall specifically address the issue you wish to raise. A failure to raise such issue within the prescribed time shall constitute your unqualified acceptance of the completeness of this report, the tests conducted and the correctness of the report contents. Unless specific mention, the uncertainty of measurement has been explicitly taken into account to declare the compliance or non-compliance to the specification.

Table of Contents

RELEASE CONTROL RECORD	4
1. CERTIFICATION.....	5
2. SUMMARY OF TEST RESULTS	6
2.1 MEASUREMENT UNCERTAINTY	6
3. GENERAL INFORMATION	7
3.1 GENERAL DESCRIPTION OF EUT	7
3.2 DESCRIPTION OF TEST MODES	8
3.2.1 TEST MODE APPLICABILITY AND TESTED CHANNEL DETAIL.....	9
3.3 DESCRIPTION OF SUPPORT UNITS	10
3.3.1 CONFIGURATION OF SYSTEM UNDER TEST.....	10
3.4 GENERAL DESCRIPTION OF APPLIED STANDARDS.....	11
4. TEST TYPES AND RESULTS	12
4.1 RADIATED EMISSION AND BANDEDGE MEASUREMENT	12
4.1.1 LIMITS OF RADIATED EMISSION AND BANDEDGE MEASUREMENT	12
4.1.2 TEST INSTRUMENTS.....	13
4.1.3 TEST PROCEDURES	14
4.1.4 DEVIATION FROM TEST STANDARD.....	14
4.1.5 TEST SETUP.....	15
4.1.6 EUT OPERATING CONDITIONS	15
4.1.7 TEST RESULTS	16
4.2 CONDUCTED EMISSION MEASUREMENT.....	23
4.2.1 LIMITS OF CONDUCTED EMISSION MEASUREMENT	23
4.2.2 TEST INSTRUMENTS.....	23
4.2.3 TEST PROCEDURES	24
4.2.4 DEVIATION FROM TEST STANDARD.....	24
4.2.5 TEST SETUP.....	25
4.2.6 EUT OPERATING CONDITIONS	25
4.2.7 TEST RESULTS	26
4.3 NUMBER OF HOPPING FREQUENCY USED.....	28
4.3.1 LIMIT OF HOPPING FREQUENCY USED.....	28
4.3.2 TEST SETUP.....	28
4.3.3 TEST INSTRUMENTS.....	28
4.3.4 TEST PROCEDURES	28
4.3.5 DEVIATION FROM TEST STANDARD.....	28
4.3.6 TEST RESULTS	28
4.4 DWELL TIME ON EACH CHANNEL.....	30
4.4.1 LIMIT OF DWELL TIME USED	30
4.4.2 TEST SETUP.....	30
4.4.3 TEST INSTRUMENTS.....	30
4.4.4 TEST PROCEDURES	30
4.4.5 DEVIATION FROM TEST STANDARD.....	30
4.4.6 TEST RESULTS	31
4.5 CHANNEL BANDWIDTH	32
4.5.1 LIMITS OF CHANNEL BANDWIDTH.....	32
4.5.2 TEST SETUP.....	32
4.5.3 TEST INSTRUMENTS.....	32



A D T

4.5.4	TEST PROCEDURE	32
4.5.5	DEVIATION FROM TEST STANDARD	32
4.5.6	EUT OPERATING CONDITION	32
4.5.7	TEST RESULTS	33
4.6	HOPPING CHANNEL SEPARATION	34
4.6.1	LIMIT OF HOPPING CHANNEL SEPARATION	34
4.6.2	TEST SETUP	34
4.6.3	TEST INSTRUMENTS	34
4.6.4	TEST PROCEDURES	34
4.6.5	DEVIATION FROM TEST STANDARD	34
4.6.6	TEST RESULTS	35
4.7	MAXIMUM OUTPUT POWER	36
4.7.1	LIMITS OF MAXIMUM OUTPUT POWER MEASUREMENT	36
4.7.2	TEST SETUP	36
4.7.3	TEST INSTRUMENTS	36
4.7.4	TEST PROCEDURES	36
4.7.5	DEVIATION FROM TEST STANDARD	36
4.7.6	EUT OPERATING CONDITION	36
4.7.7	TEST RESULTS	37
4.8	CONDUCTED OUT OF BAND EMISSION MEASUREMENT	38
4.8.1	LIMITS OF CONDUCTED OUT OF BAND EMISSION MEASUREMENT	38
4.8.2	TEST INSTRUMENTS	38
4.8.3	TEST PROCEDURE	38
4.8.4	DEVIATION FROM TEST STANDARD	38
4.8.5	EUT OPERATING CONDITION	38
4.8.6	TEST RESULTS	38
5.	PHOTOGRAPHS OF THE TEST CONFIGURATION	40
6.	INFORMATION ON THE TESTING LABORATORIES	41
7.	APPENDIX A - MODIFICATIONS RECORDERS FOR ENGINEERING CHANGES TO THE EUT BY THE LAB	42



A D T

RELEASE CONTROL RECORD

ISSUE NO.	REASON FOR CHANGE	DATE ISSUED
RF131108D08	Original release	Dec. 31, 2013



1. CERTIFICATION

PRODUCT: RF Basic Keypad
MODEL: SR-KPD02, BASIC KEYPAD
BRAND: Sercomm, AT&T
APPLICANT: Sercomm Corp.
TESTED: Nov. 14 ~ Dec. 12, 2013
TEST SAMPLE: ENGINEERING SAMPLE
STANDARDS: **FCC Part 15, Subpart C (Section 15.247)**
ANSI C63.10-2009

The above equipment (model no.: SR-KPD02) has been tested by **Bureau Veritas Consumer Products Services (H.K.) Ltd., Taoyuan Branch**, and found compliance with the requirement of the above standards. The test record, data evaluation & Equipment Under Test (EUT) configurations represented herein are true and accurate accounts of the measurements of the sample's EMC characteristics under the conditions specified in this report.

PREPARED BY : Celia Chen , **DATE:** Dec. 31, 2013
(Celia Chen / Senior Specialist)

APPROVED BY : Rex Lai , **DATE:** Dec. 31, 2013
(Rex Lai / Assistant Manager)

2. SUMMARY OF TEST RESULTS

The EUT has been tested according to the following specifications:

APPLIED STANDARD: FCC PART 15, SUBPART C (SECTION 15.247)			
STANDARD SECTION	TEST TYPE AND LIMIT	RESULT	REMARK
15.207	AC Power Conducted Emission	PASS	Meet the requirement of limit. Minimum passing margin is -15.37dB at 0.48203MHz.
15.247(a)(1)(i)	Number of Hopping Frequency Used Spec.: At least 50 channels	PASS	Meet the requirement of limit.
15.247(a)(1)(i)	Dwell Time on Each Channel Spec.: Max. 0.4 second within 20 second	PASS	Meet the requirement of limit.
15.247(a)(1)(i)	1. Hopping Channel Separation Spec.: Min. 25 kHz or 20 dB bandwidth, whichever is greater 2. Spectrum Bandwidth of a Frequency Hopping Sequence Spread Spectrum System	PASS	Meet the requirement of limit.
15.247(b)(2)	Maximum Peak Output Power Spec.: max. 30dBm	PASS	Meet the requirement of limit.
15.247(d)	Transmitter Radiated Emissions Spec.: Table 15.209	PASS	Meet the requirement of limit. Minimum passing margin is -5.5dB at 60.65MHz
15.247(d)	Band Edge Measurement	PASS	Meet the requirement of limit.
15.203	Antenna Requirement	PASS	No antenna connector is used.

2.1 MEASUREMENT UNCERTAINTY

Where relevant, the following measurement uncertainty levels have been estimated for tests performed on the EUT as specified in CISPR 16-4-2:

MEASUREMENT	FREQUENCY	UNCERTAINTY
Conducted emissions	150kHz~30MHz	2.41 dB
Radiated emissions	30MHz ~ 1GHz	4.30 dB
	Above 1GHz	3.36 dB

This uncertainty represents an expanded uncertainty expressed at approximately the 95% confidence level using a coverage factor of k=2.

3. GENERAL INFORMATION

3.1 GENERAL DESCRIPTION OF EUT

EUT	RF Basic Keypad
MODEL NO.	SR-KPD02, BASIC KEYPAD
POWER SUPPLY	12Vdc from AC adapter 1.2Vdc*4 from batteries
MODULATION TYPE	GFSK (Gaussian Frequency-Shift Keying)
OPERATING FREQUENCY	903-918.75MHz
NUMBER OF CHANNEL	64
CHANNEL SPACING	250kHz
OUTPUT POWER	16.9mW
ANTENNA TYPE	PIFA antenna with 1.7dBi gain
DATA CABLE	NA
I/O PORTS	Refer to user's manual
ACCESSORY DEVICE	Refer to note below

NOTE:

- The EUT is a RF Basic Keypad with several models for marketing difference as follows::

Brand	Model No.	Remark
Sercomm	SR-KPD02	For marketing difference
AT&T	BASIC KEYPAD	

For the test, **model: SR-KPD02** was selected as a representative one and therefore only its test data was recorded in this report.

- The EUT was power supplied from the following power adapter or battery:

Item	Brand	Model No.	Spec.
Adapter	AmpowerTek	AL12AA-00	AC I/P: 100-120V, 50-60Hz, 0.3A DC O/P: 12V, 1A AC 2 pin Non-shielded DC (1.8m)
Battery	-	-	1.2Vdc*4

After pre-tested above two power sources, the **Adapter** was the worst case, therefore, only its test data was recorded in this report.

- The above EUT information is declared by manufacturer and for more detailed features description, please refer to the manufacturer's specifications or User's Manual.

3.2 DESCRIPTION OF TEST MODES

64 channels are provided to this EUT:

CHANNEL	FREQ. (MHz)	CHANNEL	FREQ. (MHz)
1	903.00	33	911.00
2	903.25	34	911.25
3	903.50	35	911.50
4	903.75	36	911.75
5	904.00	37	912.00
6	904.25	38	912.25
7	904.50	39	912.50
8	904.75	40	912.75
9	905.00	41	913.00
10	905.25	42	913.25
11	905.50	43	913.50
12	905.75	44	913.75
13	906.00	45	914.00
14	906.25	46	914.25
15	906.50	47	914.50
16	906.75	48	914.75
17	907.00	49	915.00
18	907.25	50	915.25
19	907.50	51	915.50
20	907.75	52	915.75
21	908.00	53	916.00
22	908.25	54	916.25
23	908.50	55	916.50
24	908.75	56	916.75
25	909.00	57	917.00
26	909.25	58	917.25
27	909.50	59	917.50
28	909.75	60	917.75
29	910.00	61	918.00
30	910.25	62	918.25
31	910.50	63	918.50
32	910.75	64	918.75

3.2.1 TEST MODE APPLICABILITY AND TESTED CHANNEL DETAIL

EUT CONFIGURE MODE	APPLICABLE TO				DESCRIPTION
	RE \geq 1G	RE<1G	PLC	APCM	
-	√	√	√	√	-

Where **RE \geq 1G**: Radiated Emission above 1GHz
PLC: Power Line Conducted Emission

RE<1G: Radiated Emission below 1GHz
APCM: Antenna Port Conducted Measurement

RADIATED EMISSION TEST (ABOVE 1 GHz):

- Pre-Scan has been conducted to determine the worst-case mode from all possible combinations between available modulations, antenna ports (if EUT with antenna diversity architecture) and packet type.
- Following channel(s) was (were) selected for the final test as listed below.

EUT CONFIGURE MODE	AVAILABLE CHANNEL	TESTED CHANNEL	MODULATION TYPE
-	1 to 64	1, 33, 64	GFSK

RADIATED EMISSION TEST (BELOW 1 GHz):

- Pre-Scan has been conducted to determine the worst-case mode from all possible combinations between available modulations, antenna ports (if EUT with antenna diversity architecture) and packet type.
- Following channel(s) was (were) selected for the final test as listed below.

EUT CONFIGURE MODE	AVAILABLE CHANNEL	TESTED CHANNEL	MODULATION TYPE
-	1 to 64	1	GFSK

POWER LINE CONDUCTED EMISSION TEST:

- Pre-Scan has been conducted to determine the worst-case mode from all possible combinations between available modulations, data rates and antenna ports (if EUT with antenna diversity architecture).
- Following channel(s) was (were) selected for the final test as listed below.

EUT CONFIGURE MODE	AVAILABLE CHANNEL	TESTED CHANNEL	MODULATION TYPE
-	1 to 64	1	GFSK

ANTENNA PORT CONDUCTED MEASUREMENT:

- This item includes all test value of each mode, but only includes spectrum plot of worst value of each mode.
- Pre-Scan has been conducted to determine the worst-case mode from all possible combinations between available modulations, antenna ports (if EUT with antenna diversity architecture), and packet types.
- Following channel(s) was (were) selected for the final test as listed below.

EUT CONFIGURE MODE	AVAILABLE CHANNEL	TESTED CHANNEL	MODULATION TYPE
-	1 to 64	1, 33, 64	GFSK

TEST CONDITION:

APPLICABLE TO	ENVIRONMENTAL CONDITIONS	INPUT POWER	TESTED BY
RE \geq 1G	25deg. C, 75%RH	120Vac, 60Hz	Joey Liu
RE $<$ 1G	23deg. C, 76%RH	120Vac, 60Hz	Joey Liu
PLC	22deg. C, 74%RH	120Vac, 60Hz	Charlie Chang
APCM	21deg. C, 80%RH	120Vac, 60Hz	Dalen Dai

3.3 DESCRIPTION OF SUPPORT UNITS

The EUT has been tested as an independent unit together without other necessary accessories or support units.

3.3.1 CONFIGURATION OF SYSTEM UNDER TEST

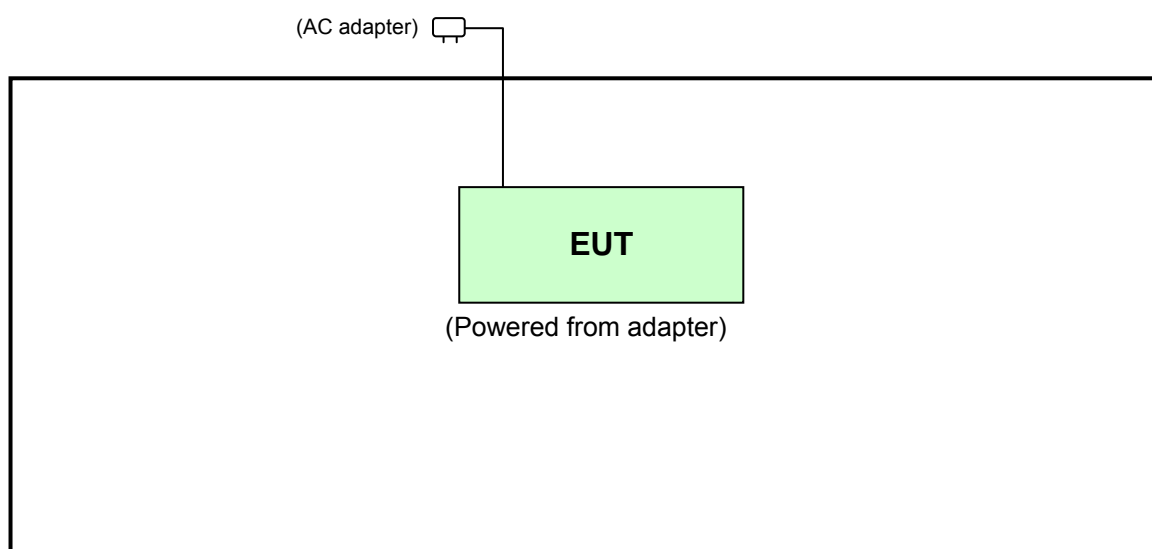

3.4 GENERAL DESCRIPTION OF APPLIED STANDARDS

The EUT is a RF Product. According to the specifications of the manufacturer, it must comply with the requirements of the following standards:

FCC Part 15, Subpart C. (15.247)

ANSI C63.10-2009

NOTE: The product has been verified to comply with the requirements of FCC Part 15, Subpart B, Class B (DoC). The test report has been issued separately.

All test items have been performed and recorded as per the above standards.

4. TEST TYPES AND RESULTS

4.1 RADIATED EMISSION AND BANDEDGE MEASUREMENT

4.1.1 LIMITS OF RADIATED EMISSION AND BANDEDGE MEASUREMENT

Emissions radiated outside of the specified bands, shall be according to the general radiated limits in 15.209 as following:

FREQUENCIES (MHz)	FIELD STRENGTH (microvolts/meter)	MEASUREMENT DISTANCE (meters)
0.009 ~ 0.490	2400/F(kHz)	300
0.490 ~ 1.705	24000/F(kHz)	30
1.705 ~ 30.0	30	30
30 ~ 88	100	3
88 ~ 216	150	3
216 ~ 960	200	3
Above 960	500	3

NOTE:

1. The lower limit shall apply at the transition frequencies.
2. Emission level (dBuV/m) = 20 log Emission level (uV/m).
3. As shown in 15.35(b), for frequencies above 1000MHz, the field strength limits are based on average detector, however, the peak field strength of any emission shall not exceed the maximum permitted average limits, specified above by more than 20dB under any condition of modulation.

4.1.2 TEST INSTRUMENTS

DESCRIPTION & MANUFACTURER	MODEL NO.	SERIAL NO.	CALIBRATED DATE	CALIBRATED UNTIL
HP Preamplifier	8447D	2432A03504	Feb. 26, 2013	Feb. 25, 2014
HP Preamplifier	8449B	3008A01201	Feb. 26, 2013	Feb. 25, 2014
Agilent TEST RECEIVER	N9038A	MY51210129	Jan. 03, 2013	Jan. 02, 2014
Schwarzbeck Antenna	VULB 9168	137	Mar. 20, 2013	Mar. 19, 2014
Schwarzbeck Antenna	VHBA 9123	480	May 29, 2013	May 28, 2014
ADT. Turn Table	TT100	0306	NA	NA
ADT. Tower	AT100	0306	NA	NA
Software	ADT_Radiated_V 7.6.15.9.2	NA	NA	NA
SUHNER RF cable	SF102	CABLE-CH6	Aug. 16, 2013	Aug. 15, 2014
Schwarzbeck Horn Antenna	BBHA 9120-D1	D130	May 13, 2013	May 12, 2014
Highpass filter Wainwright Instruments	WHK 3.1/18G-10SS	SN 8	NA	NA
ROHDE & SCHWARZ Spectrum Analyzer	FSP 40	100036	May. 17, 2013	May. 16, 2014
Anritsu Power Sensor	MA2411B	0738404	Apr. 24, 2013	Apr. 23, 2014
Anritsu Power Meter	ML2495A	0842014	Apr. 25, 2013	Apr. 24, 2014

- NOTE:**
1. The calibration interval of the above test instruments is 12 months. And the calibrations are traceable to NML/ROC and NIST/USA.
 2. The horn antenna and HP preamplifier (model: 8449B) are used only for the measurement of emission frequency above 1GHz if tested.
 3. The test was performed in Chamber No. 6.
 4. The Industry Canada Reference No. IC 7450E-6.
 5. The FCC Site Registration No. is 447212.

4.1.3 TEST PROCEDURES

- a. The EUT was placed on the top of a rotating table 0.8 meters above the ground at a 3 meter semi-anechoic chamber. The table was rotated 360 degrees to determine the position of the highest radiation.
- b. The EUT was set 3 meters away from the interference-receiving antenna, which was mounted on the top of a variable-height antenna tower.
- c. The antenna is a broadband antenna, and its height is varied from one meter to four meters above the ground to determine the maximum value of the field strength. Both horizontal and vertical polarizations of the antenna are set to make the measurement.
- d. For each suspected emission, the EUT was arranged to its worst case and then the antenna was tuned to heights from 1 meter to 4 meters and the rotatable table was turned from 0 degrees to 360 degrees to find the maximum reading.
- e. The test-receiver system was set to Peak Detect Function and Specified Bandwidth with Maximum Hold Mode.
- f. If the emission level of the EUT in peak mode was lower than the limit specified, then testing could be stopped and the peak values of the EUT would be reported. Otherwise the emissions would be re-tested one by one using peak, quasi-peak or average method as specified and then reported in a data sheet.

NOTE:

1. The resolution bandwidth and video bandwidth of test receiver/spectrum analyzer is 120kHz for Quasi-peak detection at frequency below 1GHz.
2. The resolution bandwidth of test receiver/spectrum analyzer is 1 MHz and video bandwidth is 3MHz for Peak detection at frequency above 1GHz.
3. All modes of operation were investigated and the worst-case emissions are reported.

4.1.4 DEVIATION FROM TEST STANDARD

No deviation

4.1.5 TEST SETUP

Frequency range 30MHz~1GHz

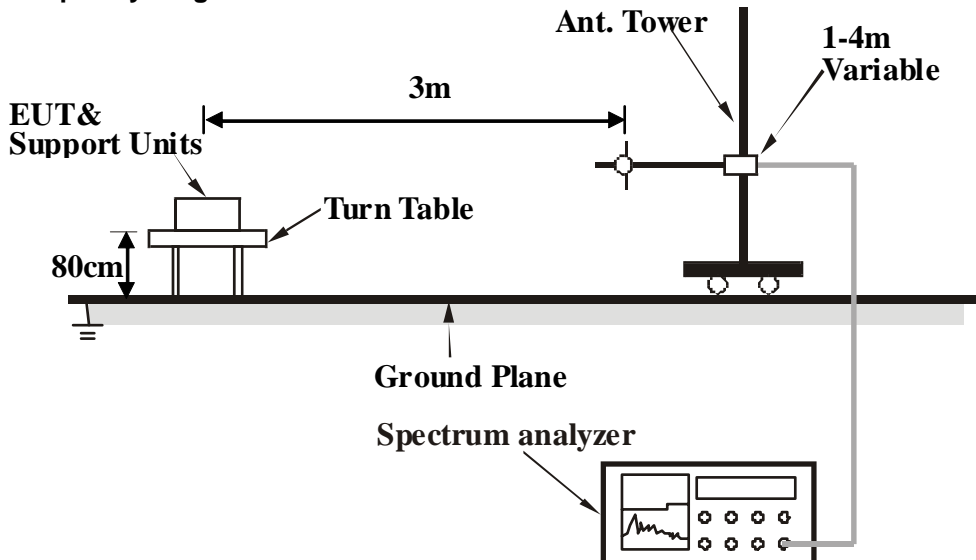

Frequency range above 1GHz

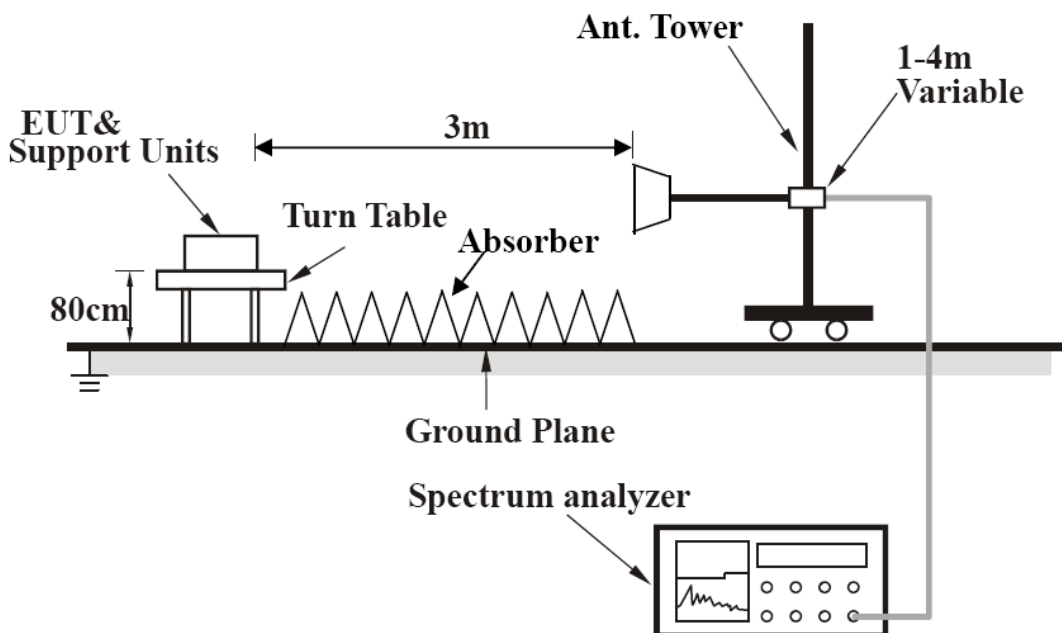

For the actual test configuration, please refer to the attached file (Test Setup Photo).

4.1.6 EUT OPERATING CONDITIONS

Set the EUT under transmission condition continuously at specific channel frequency.



A D T

4.1.7 TEST RESULTS

BELOW 1GHz DATA

CHANNEL	TX Channel 1	DETECTOR FUNCTION	Quasi-Peak (QP)
FREQUENCY RANGE	30MHz ~ 1GHz		

ANTENNA POLARITY & TEST DISTANCE: HORIZONTAL AT 3 M

NO.	FREQ. (MHz)	EMISSION LEVEL (dBuV/m)	LIMIT (dBuV/m)	MARGIN (dB)	ANTENNA HEIGHT (m)	TABLE ANGLE (Degree)	RAW VALUE (dBuV)	CORRECTION FACTOR (dB/m)
1	143.83	30.9 QP	43.5	-12.6	1.00 H	137	44.23	-13.33
2	301.36	37.4 QP	46.0	-8.6	1.22 H	348	48.78	-11.39
3	602.01	36.6 QP	46.0	-9.4	1.27 H	254	41.98	-5.37
4	726.75	36.1 QP	46.0	-9.9	1.16 H	139	39.32	-3.24
5	815.02	37.5 QP	46.0	-8.5	1.07 H	278	39.20	-1.67
6	875.26	37.7 QP	46.0	-8.3	1.55 H	224	38.81	-1.08
7	*903.00	111.2 QP			1.00 H	163	111.74	-0.51

ANTENNA POLARITY & TEST DISTANCE: VERTICAL AT 3 M

NO.	FREQ. (MHz)	EMISSION LEVEL (dBuV/m)	LIMIT (dBuV/m)	MARGIN (dB)	ANTENNA HEIGHT (m)	TABLE ANGLE (Degree)	RAW VALUE (dBuV)	CORRECTION FACTOR (dB/m)
1	31.26	32.4 QP	40.0	-7.6	1.26 V	360	48.09	-15.68
2	83.83	31.1 QP	40.0	-8.9	1.00 V	245	50.19	-19.09
3	232.83	33.8 QP	46.0	-12.2	1.87 V	257	48.84	-15.02
4	299.85	36.5 QP	46.0	-9.5	1.36 V	269	47.93	-11.45
5	603.51	34.8 QP	46.0	-11.2	1.15 V	255	40.07	-5.31
6	*903.00	102.1 QP			1.17 V	327	102.64	-0.51
7	986.52	33.0 QP	54.0	-21.1	1.64 V	164	32.30	0.65

REMARKS:

1. Emission Level(dBuV/m) = Raw Value(dBuV) + Correction Factor(dB/m)
2. Correction Factor(dB/m) = Antenna Factor(dB/m) + Cable Factor(dB) – Pre-Amplifier Factor(dB)
3. The other emission levels were very low against the limit.
4. Margin value = Emission Level – Limit value
5. " * ": Fundamental frequency.



A D T

CHANNEL	TX Channel 33	DETECTOR FUNCTION	Quasi-Peak (QP)
FREQUENCY RANGE	30MHz ~ 1GHz		

ANTENNA POLARITY & TEST DISTANCE: HORIZONTAL AT 3 M

NO.	FREQ. (MHz)	EMISSION LEVEL (dBuV/m)	LIMIT (dBuV/m)	MARGIN (dB)	ANTENNA HEIGHT (m)	TABLE ANGLE (Degree)	RAW VALUE (dBuV)	CORRECTION FACTOR (dB/m)
1	145.82	29.8 QP	43.5	-13.7	1.32 H	225	43.24	-13.43
2	232.78	24.8 QP	46.0	-21.2	1.45 H	267	39.85	-15.03
3	365.86	32.1 QP	46.0	-13.9	1.67 H	345	42.24	-10.14
4	671.99	30.1 QP	46.0	-15.9	1.27 H	267	34.24	-4.17
5	739.51	37.8 QP	46.0	-8.2	1.20 H	115	40.77	-2.95
6	861.05	39.2 QP	46.0	-6.8	1.36 H	229	40.32	-1.10
7	*911.00	109.8 QP			1.00 H	157	110.02	-0.24

ANTENNA POLARITY & TEST DISTANCE: VERTICAL AT 3 M

NO.	FREQ. (MHz)	EMISSION LEVEL (dBuV/m)	LIMIT (dBuV/m)	MARGIN (dB)	ANTENNA HEIGHT (m)	TABLE ANGLE (Degree)	RAW VALUE (dBuV)	CORRECTION FACTOR (dB/m)
1	32.91	30.3 QP	40.0	-9.7	1.16 V	258	46.05	-15.72
2	82.48	31.0 QP	40.0	-9.0	1.48 V	255	49.54	-18.58
3	232.39	33.6 QP	46.0	-12.4	1.36 V	328	48.73	-15.09
4	301.31	38.0 QP	46.0	-8.0	1.07 V	154	49.41	-11.39
5	603.66	30.7 QP	46.0	-15.3	1.12 V	118	35.99	-5.30
6	820.50	25.8 QP	46.0	-20.2	1.43 V	245	27.41	-1.61
7	*911.00	100.6 QP			1.14 V	165	100.80	-0.24

REMARKS:

1. Emission Level(dBuV/m) = Raw Value(dBuV) + Correction Factor(dB/m)
2. Correction Factor(dB/m) = Antenna Factor(dB/m) + Cable Factor(dB) – Pre-Amplifier Factor(dB)
3. The other emission levels were very low against the limit.
4. Margin value = Emission Level – Limit value
5. " * ": Fundamental frequency.



A D T

CHANNEL	TX Channel 64	DETECTOR FUNCTION	Quasi-Peak (QP)
FREQUENCY RANGE	30MHz ~ 1GHz		

ANTENNA POLARITY & TEST DISTANCE: HORIZONTAL AT 3 M

NO.	FREQ. (MHz)	EMISSION LEVEL (dBuV/m)	LIMIT (dBuV/m)	MARGIN (dB)	ANTENNA HEIGHT (m)	TABLE ANGLE (Degree)	RAW VALUE (dBuV)	CORRECTION FACTOR (dB/m)
1	114.58	30.7 QP	43.5	-12.8	1.58 H	269	47.03	-16.34
2	232.78	36.6 QP	46.0	-9.4	1.69 H	327	51.60	-15.03
3	300.34	36.6 QP	46.0	-9.4	1.44 H	264	48.03	-11.43
4	365.09	32.3 QP	46.0	-13.7	1.39 H	263	42.49	-10.15
5	603.32	33.3 QP	46.0	-12.7	1.47 H	274	38.58	-5.32
6	901.06	38.0 QP	46.0	-8.0	1.24 H	334	38.58	-0.56
7	*918.75	108.7 QP			1.36 H	327	108.67	-0.02

ANTENNA POLARITY & TEST DISTANCE: VERTICAL AT 3 M

NO.	FREQ. (MHz)	EMISSION LEVEL (dBuV/m)	LIMIT (dBuV/m)	MARGIN (dB)	ANTENNA HEIGHT (m)	TABLE ANGLE (Degree)	RAW VALUE (dBuV)	CORRECTION FACTOR (dB/m)
1	32.96	27.9 QP	40.0	-12.1	1.28 V	139	43.63	-15.72
2	60.65	34.5 QP	40.0	-5.5	1.33 V	360	48.52	-14.02
3	84.95	28.6 QP	40.0	-11.4	1.87 V	315	47.77	-19.14
4	107.26	32.3 QP	43.5	-11.2	1.68 V	245	49.38	-17.08
5	301.45	35.2 QP	46.0	-10.8	1.26 V	227	46.56	-11.39
6	602.30	31.2 QP	46.0	-14.8	1.08 V	129	36.57	-5.36
7	902.95	37.6 QP	46.0	-8.4	1.24 V	187	38.13	-0.51
8	*918.75	101.1 QP			1.42 V	264	101.08	-0.02

REMARKS:

1. Emission Level(dBuV/m) = Raw Value(dBuV) + Correction Factor(dB/m)
2. Correction Factor(dB/m) = Antenna Factor(dB/m) + Cable Factor(dB) – Pre-Amplifier Factor(dB)
3. The other emission levels were very low against the limit.
4. Margin value = Emission Level – Limit value
5. " * ": Fundamental frequency.

ABOVE 1GHz DATA

CHANNEL	TX Channel 1	DETECTOR FUNCTION	Peak (PK)
FREQUENCY RANGE	1GHz ~ 25GHz		Average (AV)

ANTENNA POLARITY & TEST DISTANCE: HORIZONTAL AT 3 M								
NO.	FREQ. (MHz)	EMISSION LEVEL (dBuV/m)	LIMIT (dBuV/m)	MARGIN (dB)	ANTENNA HEIGHT (m)	TABLE ANGLE (Degree)	RAW VALUE (dBuV)	CORRECTION FACTOR (dB/m)
1	1806.00	54.0 PK	74.0	-20.0	1.00 H	182	59.92	-5.89
2	1806.00	23.5 AV	54.0	-30.5	1.00 H	182	29.42	-5.89
3	2709.00	41.4 PK	74.0	-32.6	1.12 H	285	43.88	-2.47
4	2709.00	10.9 AV	54.0	-43.1	1.12 H	285	13.38	-2.47
5	5418.00	47.2 PK	74.0	-26.8	1.00 H	290	42.31	4.90
6	5418.00	16.7 AV	54.0	-37.3	1.00 H	290	11.81	4.90
ANTENNA POLARITY & TEST DISTANCE: VERTICAL AT 3 M								
NO.	FREQ. (MHz)	EMISSION LEVEL (dBuV/m)	LIMIT (dBuV/m)	MARGIN (dB)	ANTENNA HEIGHT (m)	TABLE ANGLE (Degree)	RAW VALUE (dBuV)	CORRECTION FACTOR (dB/m)
1	1806.00	45.3 PK	74.0	-28.7	1.00 V	84	51.17	-5.89
2	1806.00	14.8 AV	54.0	-39.2	1.00 V	84	20.67	-5.89
3	2709.00	39.4 PK	74.0	-34.6	1.35 V	0	41.89	-2.47
4	2709.00	8.9 AV	54.0	-45.1	1.35 V	0	11.39	-2.47
5	5418.00	48.0 PK	74.0	-26.0	1.07 V	82	43.10	4.90
6	5418.00	17.5 AV	54.0	-36.5	1.07 V	82	12.60	4.90

REMARKS:

1. Emission Level(dBuV/m) = Raw Value(dBuV) + Correction Factor(dB/m)
2. Correction Factor(dB/m) = Antenna Factor(dB/m) + Cable Factor(dB) – Pre-Amplifier Factor(dB)
3. The other emission levels were very low against the limit.
4. Margin value = Emission Level – Limit value
5. The average value of fundamental frequency is: Average = Peak value + 20 log(Duty cycle)

Where the duty factor is calculated from following formula:

$$20 \log (\text{Duty cycle}) = 20 \log (3 \text{ ms} / 100 \text{ ms}) = -30.5 \text{ dB}$$

Please see page 22 for plotted duty.



A D T

CHANNEL	TX Channel 33	DETECTOR FUNCTION	Peak (PK)
FREQUENCY RANGE	1GHz ~ 25GHz		Average (AV)

ANTENNA POLARITY & TEST DISTANCE: HORIZONTAL AT 3 M

NO.	FREQ. (MHz)	EMISSION LEVEL (dBuV/m)	LIMIT (dBuV/m)	MARGIN (dB)	ANTENNA HEIGHT (m)	TABLE ANGLE (Degree)	RAW VALUE (dBuV)	CORRECTION FACTOR (dB/m)
1	1822.00	54.0 PK	74.0	-20.0	1.04 H	143	59.89	-5.88
2	1822.00	23.5 AV	54.0	-30.5	1.04 H	143	29.39	-5.88
3	2733.00	41.2 PK	74.0	-32.8	1.15 H	264	43.58	-2.37
4	2733.00	10.7 AV	54.0	-43.3	1.15 H	264	13.08	-2.37
5	5466.00	47.5 PK	74.0	-26.5	1.03 H	299	42.43	5.10
6	5466.00	17.0 AV	54.0	-37.0	1.03 H	299	11.93	5.10

ANTENNA POLARITY & TEST DISTANCE: VERTICAL AT 3 M

NO.	FREQ. (MHz)	EMISSION LEVEL (dBuV/m)	LIMIT (dBuV/m)	MARGIN (dB)	ANTENNA HEIGHT (m)	TABLE ANGLE (Degree)	RAW VALUE (dBuV)	CORRECTION FACTOR (dB/m)
1	1822.00	44.3 PK	74.0	-29.7	1.24 V	224	50.20	-5.88
2	1822.00	13.8 AV	54.0	-40.2	1.24 V	224	19.70	-5.88
3	2733.00	42.6 PK	74.0	-31.4	1.18 V	227	45.01	-2.37
4	2733.00	12.1 AV	54.0	-41.9	1.18 V	227	14.51	-2.37
5	5466.00	52.2 PK	74.0	-21.8	1.14 V	21	47.14	5.10
6	5466.00	21.7 AV	54.0	-32.3	1.14 V	21	16.64	5.10

REMARKS:

1. Emission Level(dBuV/m) = Raw Value(dBuV) + Correction Factor(dB/m)
2. Correction Factor(dB/m) = Antenna Factor(dB/m) + Cable Factor(dB) – Pre-Amplifier Factor(dB)
3. The other emission levels were very low against the limit.
4. Margin value = Emission Level – Limit value
5. The average value of fundamental frequency is: Average = Peak value + 20 log(Duty cycle)

Where the duty factor is calculated from following formula:

$$20 \log (\text{Duty cycle}) = 20 \log (3 \text{ ms} / 100 \text{ ms}) = -30.5 \text{ dB}$$

Please see page 22 for plotted duty.



A D T

CHANNEL	TX Channel 64	DETECTOR FUNCTION	Peak (PK)
FREQUENCY RANGE	1GHz ~ 25GHz		Average (AV)

ANTENNA POLARITY & TEST DISTANCE: HORIZONTAL AT 3 M

NO.	FREQ. (MHz)	EMISSION LEVEL (dBuV/m)	LIMIT (dBuV/m)	MARGIN (dB)	ANTENNA HEIGHT (m)	TABLE ANGLE (Degree)	RAW VALUE (dBuV)	CORRECTION FACTOR (dB/m)
1	1837.50	45.1 PK	74.0	-28.9	1.01 H	62	50.97	-5.88
2	1837.50	14.6 AV	54.0	-39.4	1.01 H	62	20.47	-5.88
3	2756.25	41.6 PK	74.0	-32.4	1.35 H	2	43.87	-2.29
4	2756.25	11.1 AV	54.0	-42.9	1.35 H	2	13.37	-2.29
5	5512.50	48.0 PK	74.0	-26.0	1.04 H	285	42.73	5.24
6	5512.50	17.5 AV	54.0	-36.5	1.04 H	285	12.23	5.24

ANTENNA POLARITY & TEST DISTANCE: VERTICAL AT 3 M

NO.	FREQ. (MHz)	EMISSION LEVEL (dBuV/m)	LIMIT (dBuV/m)	MARGIN (dB)	ANTENNA HEIGHT (m)	TABLE ANGLE (Degree)	RAW VALUE (dBuV)	CORRECTION FACTOR (dB/m)
1	1837.50	39.6 PK	74.0	-34.4	1.00 V	351	45.51	-5.88
2	1837.50	9.1 AV	54.0	-44.9	1.00 V	351	15.01	-5.88
3	2756.25	38.8 PK	74.0	-35.2	1.00 V	1	41.11	-2.29
4	2756.25	8.3 AV	54.0	-45.7	1.00 V	1	10.61	-2.29
5	5512.50	54.2 PK	74.0	-19.8	1.11 V	291	48.96	5.24
6	5512.50	23.7 AV	54.0	-30.3	1.11 V	291	18.46	5.24

REMARKS:

1. Emission Level(dBuV/m) = Raw Value(dBuV) + Correction Factor(dB/m)
2. Correction Factor(dB/m) = Antenna Factor(dB/m) + Cable Factor(dB) – Pre-Amplifier Factor(dB)
3. The other emission levels were very low against the limit.
4. Margin value = Emission Level – Limit value
5. The average value of fundamental frequency is: Average = Peak value + 20 log(Duty cycle)

Where the duty factor is calculated from following formula:

$$20 \log (\text{Duty cycle}) = 20 \log (3 \text{ ms} / 100 \text{ ms}) = -30.5 \text{ dB}$$

Please see page 22 for plotted duty.

Duty Cycle

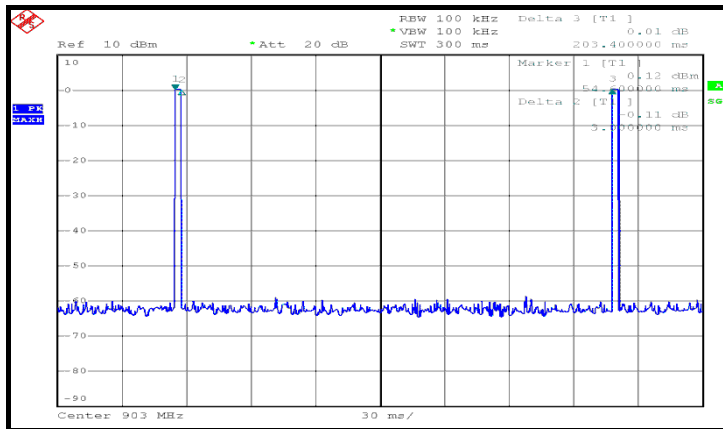

$$20 \log (\text{Duty cycle}) = 20 \log (3 \text{ ms} / 100 \text{ ms}) = -30.5 \text{ dB}$$

4.2 CONDUCTED EMISSION MEASUREMENT

4.2.1 LIMITS OF CONDUCTED EMISSION MEASUREMENT

FREQUENCY OF EMISSION (MHz)	CONDUCTED LIMIT (dB μ V)	
	Quasi-peak	Average
0.15-0.5	66 to 56	56 to 46
0.5-5	56	46
5-30	60	50

- NOTE:** 1. The lower limit shall apply at the transition frequencies.
2. The limit decreases in line with the logarithm of the frequency in the range of 0.15 to 0.50 MHz.

4.2.2 TEST INSTRUMENTS

DESCRIPTION & MANUFACTURER	MODEL NO.	SERIAL NO.	CALIBRATED DATE	CALIBRATED UNTIL
ROHDE & SCHWARZ TEST RECEIVER	ESCS 30	100276	Jan. 07, 2013	Jan. 06, 2014
ROHDE & SCHWARZ Artificial Mains Network (for EUT)	ESH3-Z5	100219	Nov. 17, 2013	Nov. 16, 2014
LISN With Adapter (for EUT)	AD10	C10Ada-001	Nov. 17, 2013	Nov. 16, 2014
ROHDE & SCHWARZ Artificial Mains Network (for peripherals)	ESH3-Z5	100218	Nov. 25, 2013	Nov. 24, 2014
Software	ADT_Cond_V7.3.7	NA	NA	NA
Software	ADT_ISN_V7.3.7	NA	NA	NA
RF cable (JYEBAO)	5D-FB	Cable-C10.01	Feb. 19, 2013	Feb. 18, 2014
SUHNER Terminator (For ROHDE & SCHWARZ LISN)	65BNC-5001	E1-010773	Feb. 06, 2013	Feb. 05, 2014

- NOTE:** 1. The calibration interval of the above test instruments is 12 months and the calibrations are traceable to NML/ROC and NIST/USA.
2. The test was performed in Shielded Room No. 10.
3. The VCCI Site Registration No. C-1852.

4.2.3 TEST PROCEDURES

- a. The EUT was placed 0.4 meters from the conducting wall of the shielded room with EUT being connected to the power mains through a line impedance stabilization network (LISN). Other support units were connected to the power mains through another LISN. The two LISNs provide 50 ohm/ 50uH of coupling impedance for the measuring instrument.
- b. Both lines of the power mains connected to the EUT were checked for maximum conducted interference.
- c. The frequency range from 150kHz to 30MHz was searched. Emission levels under (Limit - 20dB) was not recorded.

NOTE: All modes of operation were investigated and the worst-case emissions are reported.

4.2.4 DEVIATION FROM TEST STANDARD

No deviation.

4.2.5 TEST SETUP

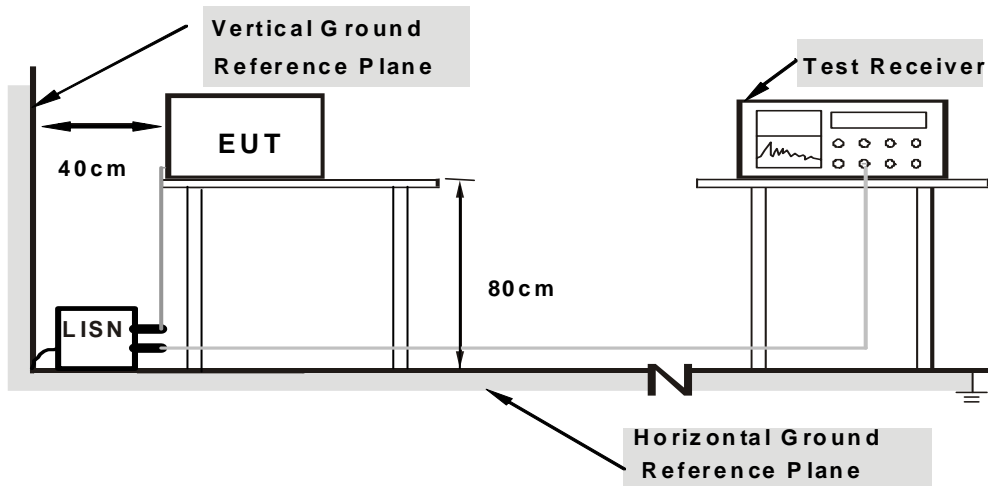

Note: Support units were connected to second LISN.

For the actual test configuration, please refer to the attached file (Test Setup Photo).

4.2.6 EUT OPERATING CONDITIONS

Same as item 4.1.6.

4.2.7 TEST RESULTS

CONDUCTED WORST-CASE DATA

PHASE	Line 1	6dB BANDWIDTH	9kHz
CHANNEL	Channel 1		

No	Freq. [MHz]	Corr. Factor (dB)	Reading Value [dB (uV)]		Emission Level [dB (uV)]		Limit [dB (uV)]		Margin (dB)	
			Q.P.	AV.	Q.P.	AV.	Q.P.	AV.	Q.P.	AV.
			1	0.15000	0.13	41.07	25.11	41.20	25.24	66.00
2	0.18516	0.14	41.63	29.24	41.77	29.38	64.25	54.25	-22.49	-24.88
3	0.33750	0.15	35.19	27.86	35.34	28.01	59.26	49.26	-23.92	-21.25
4	0.48203	0.16	36.62	30.78	36.78	30.94	56.30	46.30	-19.53	-15.37
5	0.85703	0.15	26.95	20.22	27.10	20.37	56.00	46.00	-28.90	-25.63
6	1.32031	0.16	23.91	16.99	24.07	17.15	56.00	46.00	-31.93	-28.85

REMARKS:

1. Q.P. and AV. are abbreviations of quasi-peak and average individually.
2. The emission levels of other frequencies were very low against the limit.
3. Margin value = Emission Level – Limit value
4. Correction Factor = Insertion loss + Cable loss
5. Emission Level = Correction Factor + Reading Value

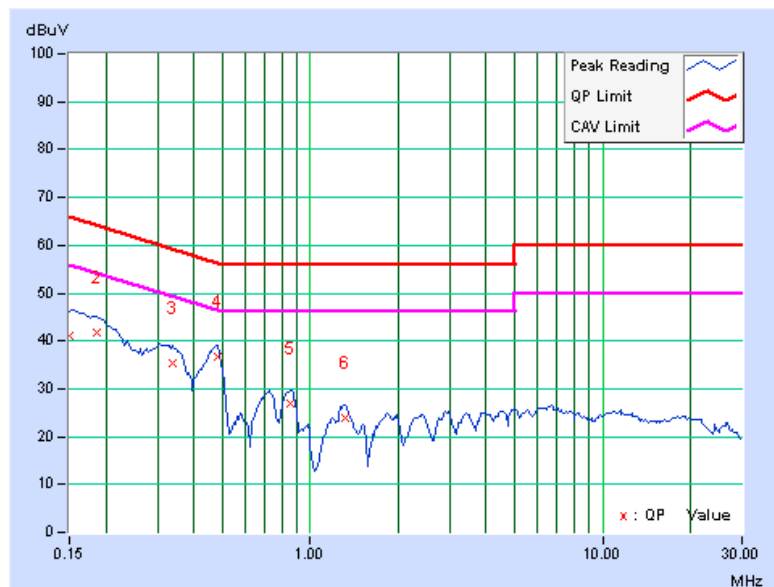

PHASE	Line 2	6dB BANDWIDTH	9kHz
CHANNEL	Channel 1		

No	Freq. [MHz]	Corr. Factor (dB)	Reading Value [dB (uV)]		Emission Level [dB (uV)]		Limit [dB (uV)]		Margin (dB)	
			Q.P.	AV.	Q.P.	AV.	Q.P.	AV.	Q.P.	AV.
			1	0.15781	0.52	43.37	27.05	43.89	27.57	65.58
2	0.18125	0.52	40.29	27.10	40.81	27.62	64.43	54.43	-23.62	-26.81
3	0.48203	0.52	31.66	25.28	32.18	25.80	56.30	46.30	-24.12	-20.50
4	0.72813	0.53	25.37	18.53	25.90	19.06	56.00	46.00	-30.10	-26.94
5	0.85313	0.54	25.97	18.89	26.51	19.43	56.00	46.00	-29.49	-26.57
6	1.29688	0.55	23.12	15.71	23.67	16.26	56.00	46.00	-32.33	-29.74

REMARKS:

1. Q.P. and AV. are abbreviations of quasi-peak and average individually.
2. The emission levels of other frequencies were very low against the limit.
3. Margin value = Emission Level – Limit value
4. Correction Factor = Insertion loss + Cable loss
5. Emission Level = Correction Factor + Reading Value

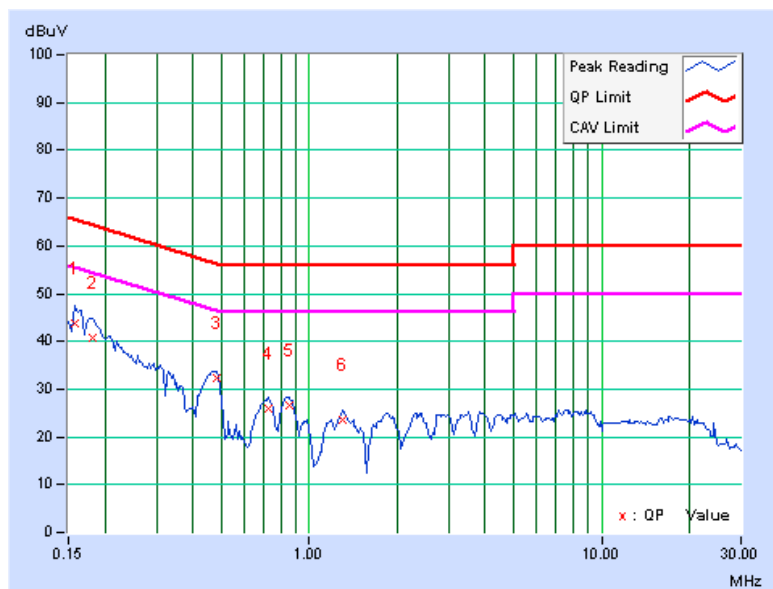

4.3 NUMBER OF HOPPING FREQUENCY USED

4.3.1 LIMIT OF HOPPING FREQUENCY USED

At least 50 channels frequencies, and should be equally spaced.

4.3.2 TEST SETUP

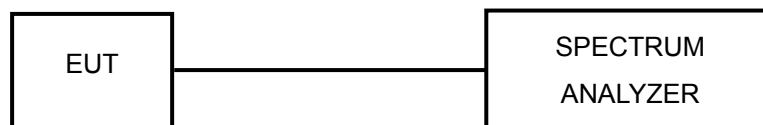

4.3.3 TEST INSTRUMENTS

Refer to section 4.1.2 to get information of above instrument.

4.3.4 TEST PROCEDURES

- a. Check the calibration of the measuring instrument (SA) using either an internal calibrator or a known signal from an external generator.
- b. Turn on the EUT and connect its antenna terminal to measurement via a low loss cable. Then set it to any one measured frequency within its operating range and make sure the instrument is operated in its linear range.
- c. Set the SA on MaxHold Mode, and then keep the EUT in hopping mode. Record all the signals from each channel until each one has been recorded.
- d. Set the SA on View mode and then plot the result on SA screen.
- e. Repeat above procedures until all frequencies measured were complete.

4.3.5 DEVIATION FROM TEST STANDARD

No deviation.

4.3.6 TEST RESULTS

There are 64 hopping frequencies in the hopping mode. Please refer to next page for the test result. On the plots, it shows that the hopping frequencies are equally spaced.



A D T

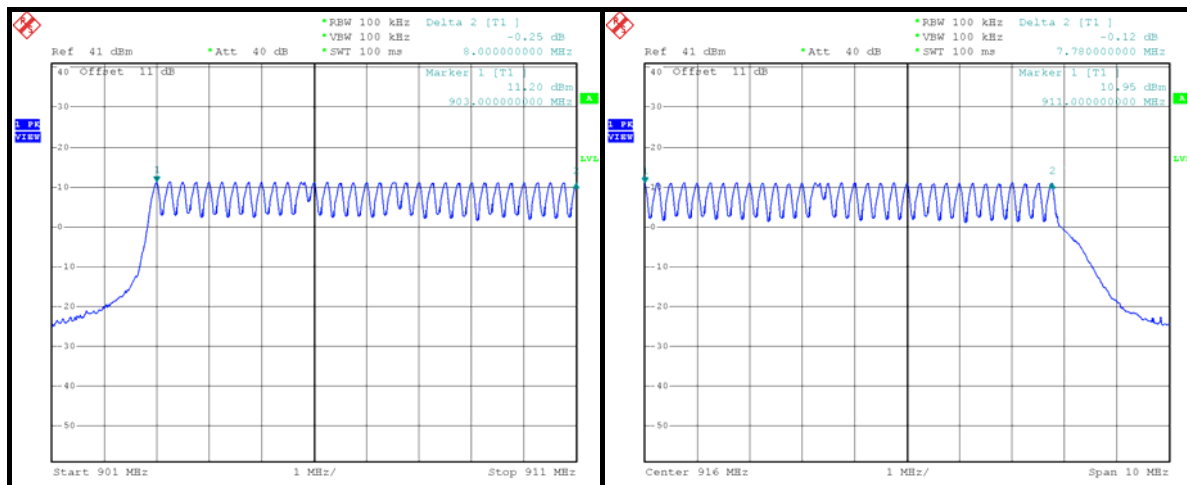

4.4 DWELL TIME ON EACH CHANNEL

4.4.1 LIMIT OF DWELL TIME USED

The average time of occupancy on any channel shall not be greater than 0.4 seconds within a period of 0.4 seconds multiplied by the number of hopping channels employed.

4.4.2 TEST SETUP

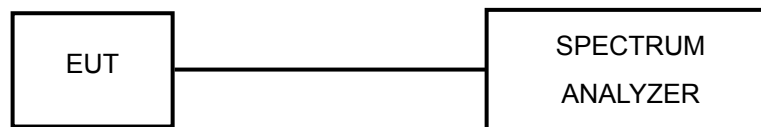

4.4.3 TEST INSTRUMENTS

Refer to section 4.1.2 to get information of above instrument.

4.4.4 TEST PROCEDURES

- a. Check the calibration of the measuring instrument (SA) using either an internal calibrator or a known signal from an external generator.
- b. Turn on the EUT and connect its antenna terminal to measurement via a low loss cable. Then set it to any one measured frequency within its operating range and make sure the instrument is operated in its linear range.
- c. Adjust the center frequency of SA on any frequency be measured and set SA to zero span mode. And then, set RBW and VBW of spectrum analyzer to proper value.
- d. Measure the time duration of one transmission on the measured frequency. And then plot the result with time difference of this time duration.
- e. Repeat above procedures until all different time-slot modes have been completed.

4.4.5 DEVIATION FROM TEST STANDARD

No deviation.

4.4.6 TEST RESULTS

Number of transmission in a 25.6 (64Hopping*0.4)	Length of transmission time (msec)	Result (msec)	Limit (msec)
25 (times / 5 sec) * 5.12 = 128times	2.9	371.2	400

NOTE: Test plots of the transmitting time slot are shown on following.

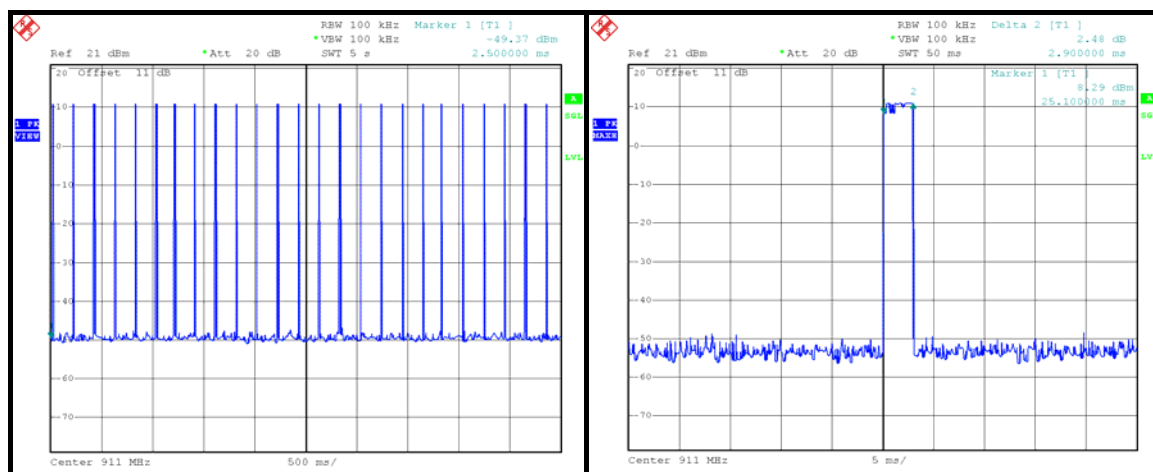

4.5 CHANNEL BANDWIDTH

4.5.1 LIMITS OF CHANNEL BANDWIDTH

The 20 dB bandwidth of the hopping channel shall be less than 250 kHz.

4.5.2 TEST SETUP

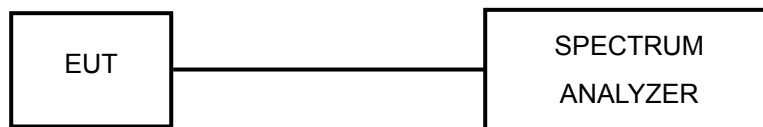

4.5.3 TEST INSTRUMENTS

Refer to section 4.1.2 to get information of above instrument.

4.5.4 TEST PROCEDURE

- a. Check the calibration of the measuring instrument using either an internal calibrator or a known signal from an external generator.
- b. Turn on the EUT and connect it to measurement instrument. Then set it to any one convenient frequency within its operating range. Set a reference level on the measuring instrument equal to the highest peak value.
- c. Measure the frequency difference of two frequencies that were attenuated 20dB from the reference level. Record the frequency difference as the emission bandwidth.
- d. Repeat above procedures until all frequencies measured were complete.

4.5.5 DEVIATION FROM TEST STANDARD

No deviation.

4.5.6 EUT OPERATING CONDITION

The software provided by client enabled the EUT to transmit and receive data at lowest, middle and highest channel frequencies individually.



A D T

4.5.7 TEST RESULTS

CHANNEL	CHANNEL FREQUENCY (MHz)	20dB BANDWIDTH (kHz)	LIMIT (kHz)
1	903.00	187.27	250
33	911.00	187.73	250
64	918.75	187.47	250

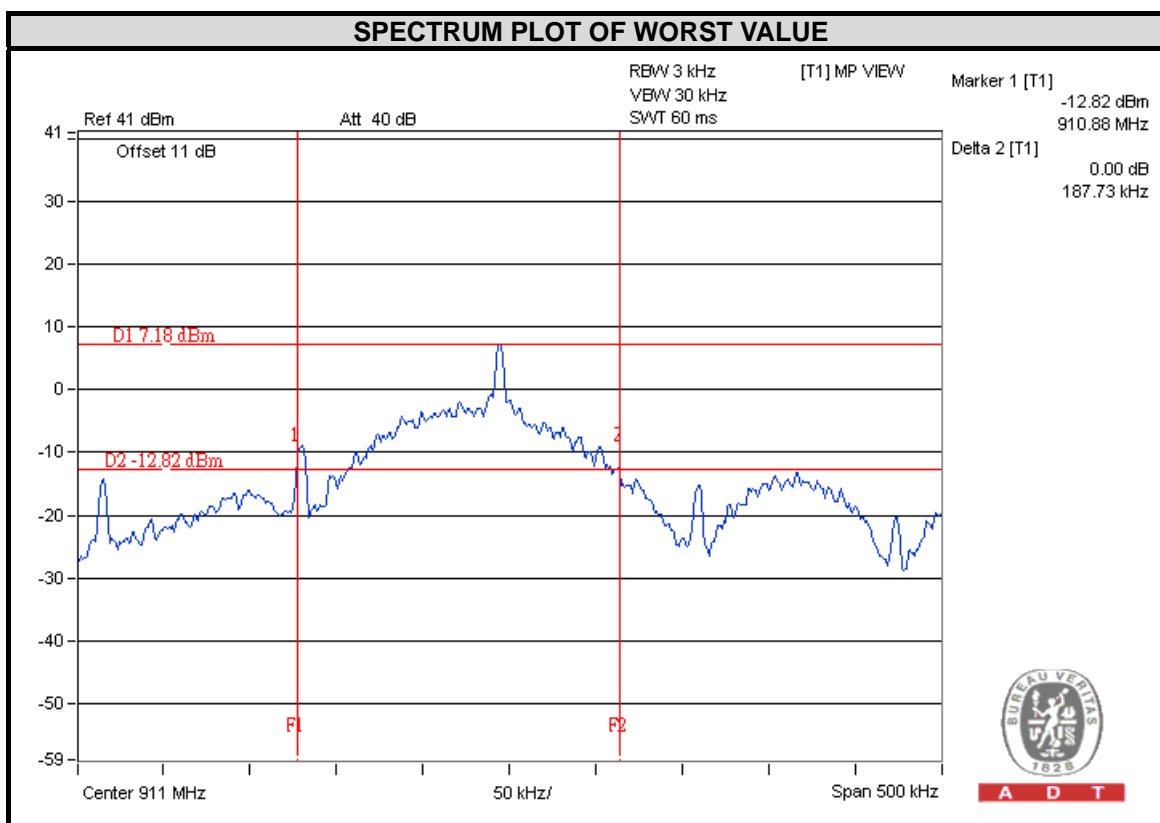

A D T

4.6 HOPPING CHANNEL SEPARATION

4.6.1 LIMIT OF HOPPING CHANNEL SEPARATION

At least 25kHz or 20dB hopping channel bandwidth (whichever is greater).

4.6.2 TEST SETUP

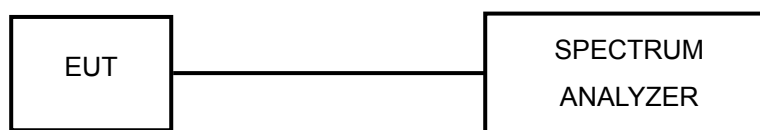

4.6.3 TEST INSTRUMENTS

Refer to section 4.1.2 to get information of above instrument.

4.6.4 TEST PROCEDURES

1. Check the calibration of the measuring instrument using either an internal calibrator or a known signal from an external generator.
2. Turn on the EUT and connect it to measurement instrument. Then set it to any one convenient frequency within its operating range.
3. By using the MaxHold function record the separation of two adjacent channels.
4. Measure the frequency difference of these two adjacent channels by SA MARK function. And then plot the result on SA screen.
5. Repeat above procedures until all frequencies measured were complete.

4.6.5 DEVIATION FROM TEST STANDARD

No deviation.

4.7 MAXIMUM OUTPUT POWER

4.7.1 LIMITS OF MAXIMUM OUTPUT POWER MEASUREMENT

The Maximum Output Power Measurement is 30dBm.

4.7.2 TEST SETUP

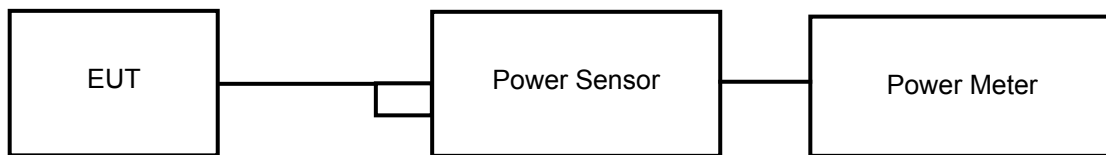

4.7.3 TEST INSTRUMENTS

Refer to section 4.1.2 to get information of above instrument.

4.7.4 TEST PROCEDURES

Peak power sensors were used on the output port of the EUT. A power meter was used to read the response of the peak power sensor. Record the peak power level.

4.7.5 DEVIATION FROM TEST STANDARD

No deviation

4.7.6 EUT OPERATING CONDITION

The software provided by client enabled the EUT to transmit and receive data at lowest, middle and highest channel frequencies individually.

4.7.7 TEST RESULTS

CHANNEL	CHANNEL FREQUENCY (MHz)	POWER OUTPUT (mW)	POWER OUTPUT (dBm)	POWER LIMIT (dBm)	PASS/FAIL
1	903.00	16.9	12.28	30	PASS
33	911.00	16.7	12.23	30	PASS
64	918.75	16.6	12.19	30	PASS

4.8 CONDUCTED OUT OF BAND EMISSION MEASUREMENT

4.8.1 LIMITS OF CONDUCTED OUT OF BAND EMISSION MEASUREMENT

Below -20dB of the highest emission level of operating band (in 100KHz RBW).

4.8.2 TEST INSTRUMENTS

Refer to section 4.1.2 to get information of above instrument.

4.8.3 TEST PROCEDURE

The transmitter output was connected to the spectrum analyzer via a low lose cable. Set both RBW and VBW of spectrum analyzer to 100 / 300 kHz with suitable frequency span including 100 MHz bandwidth from band edge. The band edges was measured and recorded.

4.8.4 DEVIATION FROM TEST STANDARD

No deviation.

4.8.5 EUT OPERATING CONDITION

The software provided by client enabled the EUT to transmit and receive data at lowest and highest channel frequencies individually.

4.8.6 TEST RESULTS

The spectrum plots are attached on the following images. D1 line indicates the highest level, D2 line indicates the 20dB offset below D1. It shows compliance with the requirement.



A D T

Low Channel

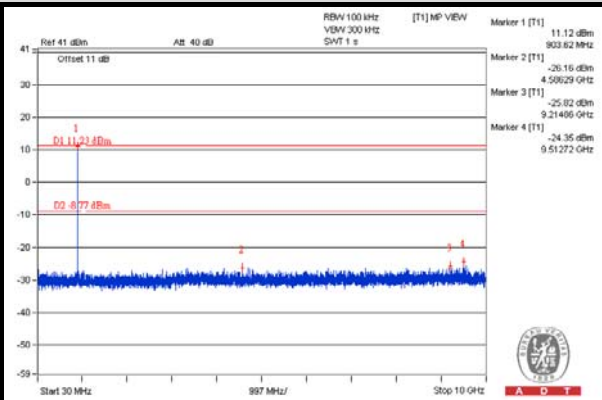
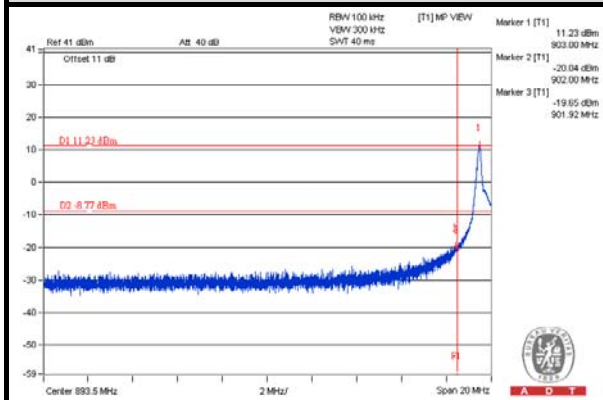

High Channel

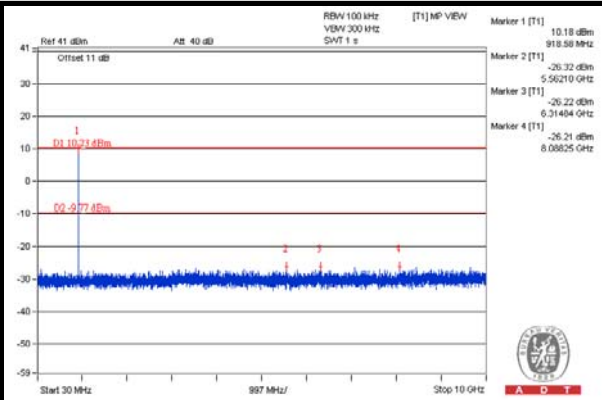
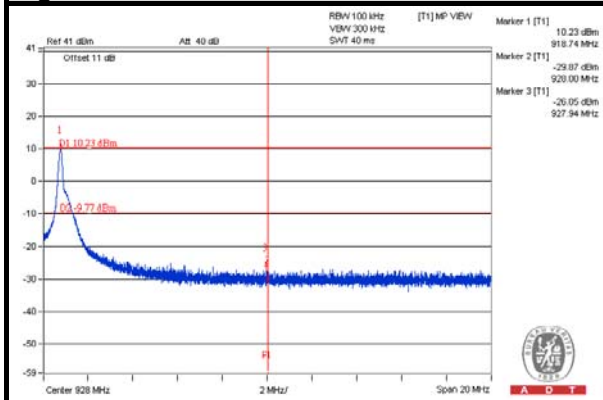

Hopping Band edge

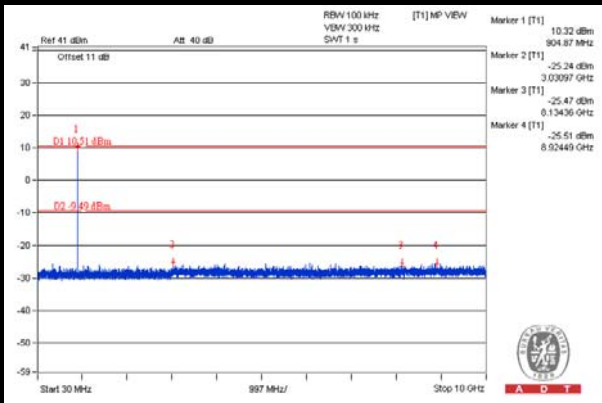
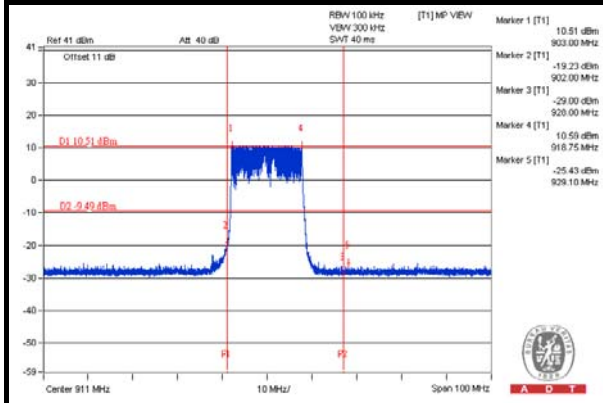

5. PHOTOGRAPHS OF THE TEST CONFIGURATION

Please refer to the attached file (Test Setup Photo).



6. INFORMATION ON THE TESTING LABORATORIES

We, Bureau Veritas Consumer Products Services (H.K.) Ltd., Taoyuan Branch, were founded in 1988 to provide our best service in EMC, Radio, Telecom and Safety consultation. Our laboratories are accredited and approved according to ISO/IEC 17025.

If you have any comments, please feel free to contact us at the following:

Linko EMC/RF Lab:

Tel: 886-2-26052180

Fax: 886-2-26051924

Hsin Chu EMC/RF Lab:

Tel: 886-3-5935343

Fax: 886-3-5935342

Hwa Ya EMC/RF/Safety Telecom Lab:

Tel: 886-3-3183232

Fax: 886-3-3270892

Email: service.adt@tw.bureauveritas.com

Web Site: www.bureauveritas-adt.com

The address and road map of all our labs can be found in our web site also.

7. APPENDIX A - MODIFICATIONS RECORDERS FOR ENGINEERING CHANGES TO THE EUT BY THE LAB

No any modifications are made to the EUT by the lab during the test.

--- END ---