

FCC DFS Test Report

FCC ID : P27-XIONESCM2
Equipment : XiOne-SC (B)
Model No. : SCXIxxBEIxxCO; SCXIxxBEI
(Refer to item 1.1.1 for more details.)
Brand Name : Comcast Xfinity; Cox; Shaw
(Refer to item 1.1.1 for more details.)
Applicant : Sercomm Corporation
Address : 8F, No. 3-1, YuanQu St., NanKang, Taipei 115,
Taiwan. R.O.C.
Standard : 47 CFR FCC Part 15.407
Received Date : Jun. 15, 2021
Tested Date : Jun. 15, 2021
Operating Mode : Client Without Radar Detection

We, International Certification Corporation, would like to declare that the tested sample has been evaluated and in compliance with the requirement of the above standards. The test results contained in this report refer exclusively to the product. It may be duplicated completely for legal use with the approval of the applicant. It shall not be reproduced except in full without the written approval of our laboratory.

Reviewed by:

Approved by:

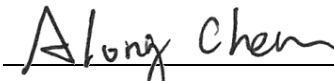
Along Chen / Assistant Manager

Gary Chang / Manager



Table of Contents

1	GENERAL DESCRIPTION	5
1.1	Information.....	5
1.2	Support Equipment List	5
1.3	The Equipment List	6
1.4	Testing Condition	6
1.5	Testing Facility	6
1.6	Test Standards	7
1.7	Deviation from Test Standard and Measurement Procedure.....	7
1.8	Measurement Uncertainty	7
2	TECHNICAL REQUIREMENTS FOR DFS.....	8
2.1	Applicability of DFS Requirements.....	8
2.2	DFS Detection Thresholds and Response Requirement	9
2.3	Radar Test Waveforms	10
3	DFS TEST RESULT.....	14
3.1	DFS Detection Threshold levels.....	14
3.2	In-Service Monitoring	15
3.3	Non-Associated	18
4	TEST LABORATORY INFORMATION	19

Release Record

Report No.	Version	Description	Issued Date
FZ161001	Rev. 01	Initial issue	Jul. 26, 2021

Summary of Test Results

FCC Rules		Description of Test	Result
FCC 15.407	KDB 905462 D02	Non-Occupancy Period	Pass
FCC 15.407	KDB 905462 D02	Channel Closing Transmission Time	Pass
FCC 15.407	KDB 905462 D02	Channel Move Time	Pass

Declaration of Conformity:

The test results with all measurement uncertainty excluded are presented in accordance with the regulation limits or requirements declared by manufacturers.

Comments and Explanations:

The declared of product specification for EUT presented in the report are provided by the manufacturer, and the manufacturer takes all the responsibilities for the accuracy of product specification.

1 General Description

1.1 Information

1.1.1 Product Details

The following models are provided to this EUT.

Brand Name	Model Name	Product Name	Description
Comcast Xfinity; Cox; Shaw	SCXIxxBEIxCO; SCXIxxBEI	XiOne-SC (B)	Where "x" may be any alphanumeric for External Body Color.
<ul style="list-style-type: none"> ✦ All models are electrically identical, different model names are for marketing purpose. ✦ The above models, model SCXI11BEI was selected as a representative one for the final test and only its data was recorded in this report. 			

1.1.2 Specification of the Equipment under Test (EUT)

Frequency Range (GHz)	5.15~5.25, 5.25~5.35, 5.47~5.725, 5.725~5.85
Wireless Function	11a / HT20 / HT40 / VHT20 / VHT40 / VHT80 / HE20 / HE40 / HE80
Operating Mode at DFS Band	Client without radar detection and ad hoc function
Firmware / Software Version	1.1000 RC15.0 wl0: Mar 23 2021 21:05:36 version 18.40.16.29 (476eb17dfc63b70107f4fc6c1b41eb7b87d352b8 WLTEST) FWID 01-810747d

1.1.3 Antenna Details

Model	Type	Connector	Antenna Gain (dBi)	
			5250~5350 MHz	5470~5725 MHz
Ant0	PIFA	UFL	3.87	3.8
Ant1	PIFA	N/A	3.85	3.85

1.2 Support Equipment List

Support Equipment List				
No.	Equipment	Brand Name	Model Name	Remark
1	AP (Master)	ZYXEL	WAX650S	I88WAX650S
2	Notebook	DELL	LATITUDE-E5420	B6FV9T1

1.3 The Equipment List

Test Site	DF01-WS				
Tested Date	Jun. 15, 2021				
Instrument	Brand	Model No.	Serial No.	Calibration Date	Calibration Until
Spectrum Analyzer	R&S	FSV7	101607	Jan. 06, 2021	Jan. 05, 2022
RF Cable	HUBER+SUHNER	SUCOFLEX_104	MY15686/4	Oct. 13, 2020	Oct. 12, 2021
RF Cable	HUBER+SUHNER	SUCOFLEX_104	296081/4	Oct. 15, 2020	Oct. 14, 2021
RF Cable	HUBER+SUHNER	SUCOFLEX_104	329023/4	Oct. 15, 2020	Oct. 14, 2021
RF Cable	HUBER+SUHNER	SUCOFLEX_104	329021/4	Oct. 15, 2020	Oct. 14, 2021
Vector signal generator	R&S	SMJ100A	100498	Jan. 08, 2021	Jan .07, 2022
Splitter (1X2)	WOKEN	2WAYDIV	12101200003	Oct. 15, 2020	Oct. 14, 2021
Splitter (1X4)	WOKEN	4WAYDIV	0120A042011010	Oct. 15, 2020	Oct. 14, 2021
Attenuator	woken	PE7013-10	10-1	Oct. 15, 2020	Oct. 14, 2021
Attenuator	woken	PE7013-10	10-2	Oct. 15, 2020	Oct. 14, 2021
Attenuator	woken	PE7013-20	20-1	Oct. 15, 2020	Oct. 14, 2021
Attenuator	woken	PE7013-20	20-2	Oct. 15, 2020	Oct. 14, 2021
20dB Attenuator	MVE	MVE2462-20	16050401	Oct. 15, 2020	Oct. 14, 2021
30dB Attenuator	MVE	MVE2462-30	16050401	Oct. 15, 2020	Oct. 14, 2021
Direction Coupler	Marvelous Microwave	MVE4514-20	20	Oct. 15, 2020	Oct. 14, 2021
Measurement Software	ICC	DFS	V1.3.30	NA	NA

Note: Calibration Interval of instruments listed above is one year.

1.4 Testing Condition

Test Item	Test Site	Ambient Condition	Tested By
DFS	DF01-WS	25°C / 66%	Jack Li

- FCC Designation No.: TW2732
- FCC site registration No.: 181692
- ISED#: 10807A
- CAB identifier: TW2732

1.5 Testing Facility

Test Laboratory	International Certification Corporation
Test Site	DF01-WS
Address of Test Site	No.3-1, Lane 6, Wen San 3rd St., Kwei Shan Dist., Tao Yuan City 33381, Taiwan (R.O.C.)

1.6 Test Standards

47 CFR FCC Part 15.407

FCC KDB 905462 D02 UNII DFS Compliance Procedures New Rules v02

FCC KDB 905462 D03 UNII Clients Without Radar Detection New Rules v01r02

FCC KDB 905462 D06 802 11 Channel Plans New Rules v02

1.7 Deviation from Test Standard and Measurement Procedure

None

1.8 Measurement Uncertainty

The measurement uncertainties given below are based on a 95% confidence level (based on a coverage factor (k=2)).

Measurement Uncertainty	
Parameters	Uncertainty
Time	±0.1%

2 Technical Requirements for DFS

2.1 Applicability of DFS Requirements

2.1.1 Applicability of DFS Requirements Prior to use of a Channel

Requirement	Operational Mode		
	Master	Client Without Radar Detection	Client With Radar Detection
Non-Occupancy Period	Yes	Not required	Yes
DFS Detection Threshold	Yes	Not required	Yes
Channel Availability Check Time	Yes	Not required	Not required
U-NII Detection Bandwidth	Yes	Not required	Yes

2.1.2 Applicability of DFS Requirements during Normal Operation

Requirement	Operational Mode	
	Master or Client With Radar Detection	Client Without Radar Detection
DFS Detection Threshold	Yes	Not required
Channel Closing Transmission Time	Yes	Yes
Channel Move Time	Yes	Yes
U-NII Detection Bandwidth	Yes	Not required

Additional requirements for devices with multiple bandwidth modes	Operational Mode	
	Master or Client With Radar Detection	Client Without Radar Detection
U-NII Detection Bandwidth and Statistical Performance Check	All BW modes must be tested	Not required
Channel Move Time and Channel Closing Transmission Time	Test using widest BW mode available	Test using the widest BW mode available for the link
All other tests	Any single BW mode	Not required

Note: Frequencies selected for statistical performance check should include several frequencies within the radar detection bandwidth and frequencies near the edge of the radar detection bandwidth. For 802.11 devices it is suggested to select frequencies in all 20 MHz channel blocks and a null frequencies between the bonded 20 MHz channel blocks.

2.2 DFS Detection Thresholds and Response Requirement

Below table provides the DFS Detection Thresholds for Master Devices as well as Client Devices incorporating In-Service Monitoring.

DFS Detection Thresholds for Master Devices and Client Devices With Radar Detection.

Maximum Transmit Power	Value (See Notes 1 , 2 and 3)
EIRP \geq 200 milliwatt	-64 dBm
EIRP < 200 milliwatt and power spectral density < 10 dBm / MHz	-62 dBm
EIRP < 200 milliwatt and that do not meet the power spectral density requirement	-64 dBm

Note 1: This is the level at the input of the receiver assuming a 0 dBi receive antenna.
 Note 2: Throughout these test procedures an additional 1 dB has been added to the amplitude of the test transmission waveforms to account for variations in measurement equipment. This will ensure that the test signal is at or above the detection threshold level to trigger a DFS response.
 Note3: EIRP is based on the highest antenna gain. For MIMO devices refer to KDB Publication 662911 D01.

DFS Response Requirement Values

Parameter	Value
Non-occupancy period	Minimum 30 minutes.
Channel Availability Check Time	60 seconds.
Channel Move Time	10 seconds. (See Note 1.)
Channel Closing Transmission Time	200 milliseconds + an aggregate of 60 milliseconds over remaining 10 second period. (See Notes 1 and 2.)
U-NII Detection Bandwidth	Minimum 100% of the U- NII 99% transmission power bandwidth. (See Note 3.)

Note 1: Channel Move Time and the Channel Closing Transmission Time should be performed with Radar Type 0. The measurement timing begins at the end of the Radar Type 0 burst.
Note 2: The Channel Closing Transmission Time is comprised of 200 milliseconds starting at the beginning of the Channel Move Time plus any additional intermittent control signals required to facilitate a Channel move (an aggregate of 60 milliseconds) during the remainder of the 10 second period. The aggregate duration of control signals will not count quiet periods in between transmissions.
Note 3: During the U-NII Detection Bandwidth detection test, radar type 0 should be used. For each frequency step the minimum percentage of detection is 90 percent. Measurements are performed with no data traffic.

2.3 Radar Test Waveforms

This section provides the parameters for required test waveforms, minimum percentage of successful detections, and the minimum number of trials that must be used for determining DFS conformance. Step intervals of 0.1 microsecond for Pulse Width, 1 microsecond for PRI, 1 MHz for chirp width and 1 for the number of pulses will be utilized for the random determination of specific test waveforms.

2.3.1 Short Pulse Radar Test Waveforms

Radar Type	Pulse Width (μsec)	PRI (μsec)	Number of Pulses	Minimum Percentage of Successful Detection	Minimum Number of Trials
0	1	1428	18	See Note1	See Note1
1		Test A: 15 unique PRI values randomly selected from the list of 23 PRI values in Table 5a Test B: 15 unique PRI values randomly selected within the range of 518-3066 μ sec, with a minimum increment of 1 μsec, excluding PRI values selected in Test A	$\text{Roundup} \left\{ \left(\frac{1}{360} \right), \left(\frac{19 \cdot 10^6}{\text{PRI}_{\mu\text{sec}}} \right) \right\}$	60%	30
2	1-5	150-230	23-29	60%	30
3	6-10	200-500	16-18	60%	30
4	11-20	200-500	12-16	60%	30
Aggregate (Radar Types 1-4)				80%	120
Note 1: Short Pulse Radar Type 0 should be used for the detection bandwidth test, channel move time, and channel closing time tests.					

A minimum of 30 unique waveforms are required for each of the Short Pulse Radar Types 2 through 4. If more than 30 waveforms are used for Short Pulse Radar Types 2 through 4, then each additional waveform must also be unique and not repeated from the previous waveforms. If more than 30 waveforms are used for Short Pulse Radar Type 1, then each additional waveform is generated with Test B and must also be unique and not repeated from the previous waveforms in Tests A or B.

Pulse Repetition Intervals Values for Test A

Pulse Repetition Frequency Number	Pulse Repetition Frequency (Pulses Per Second)	Pulse Repetition Interval (Microseconds)
1	1930.5	518
2	1858.7	538
3	1792.1	558
4	1730.1	578
5	1672.2	598
6	1618.1	618
7	1567.4	638
8	1519.8	658
9	1474.9	678
10	1432.7	698
11	1392.8	718
12	1355	738
13	1319.3	758
14	1285.3	778
15	1253.1	798
16	1222.5	818
17	1193.3	838
18	1165.6	858
19	1139	878
20	1113.6	898
21	1089.3	918
22	1066.1	938
23	326.2	3066

2.3.2 Long Pulse Radar Test Waveform

Radar Type	Pulse Width (μsec)	Chirp Width (MHz)	PRI (μsec)	Number of Pulses per Burst	Number of Bursts	Minimum Percentage of Successful Detection	Minimum Number of Trials
5	50-100	5-20	1000-2000	1-3	8-20	80%	30

The parameters for this waveform are randomly chosen. Thirty unique waveforms are required for the Long Pulse Radar Type waveforms. If more than 30 waveforms are used for the Long Pulse Radar Type waveforms, then each additional waveform must also be unique and not repeated from the previous waveforms.

2.3.3 Frequency Hopping Radar Test Waveform

Radar Type	Pulse Width (μsec)	PRI (μsec)	Pulses per Hop	Hopping Rate (kHz)	Hopping Sequence Length (msec)	Minimum Percentage of Successful Detection	Minimum Number of Trials
6	1	333	9	0.333	300	70%	30

For the Frequency Hopping Radar Type, the same *Burst* parameters are used for each waveform. The hopping sequence is different for each waveform and a 100-length segment is selected from the hopping sequence defined by the following algorithm:

The first frequency in a hopping sequence is selected randomly from the group of 475 integer frequencies from 5250 – 5724 MHz. Next, the frequency that was just chosen is removed from the group and a frequency is randomly selected from the remaining 474 frequencies in the group. This process continues until all 475 frequencies are chosen for the set. For selection of a random frequency, the frequencies remaining within the group are always treated as equally likely

2.3.4 Radar waveform generation

A Signal Generator is used for the DFS signal generation. This instrument is capable of generating all the above waveforms with Pulse Sequencer Software. The R&S Pulse Sequencer Software comes as a stand-alone PC based software with preconfigured project files for DFS. It simplifies the generation of all required waveforms and offers a one box solution

2.3.5 DFS Test Setup

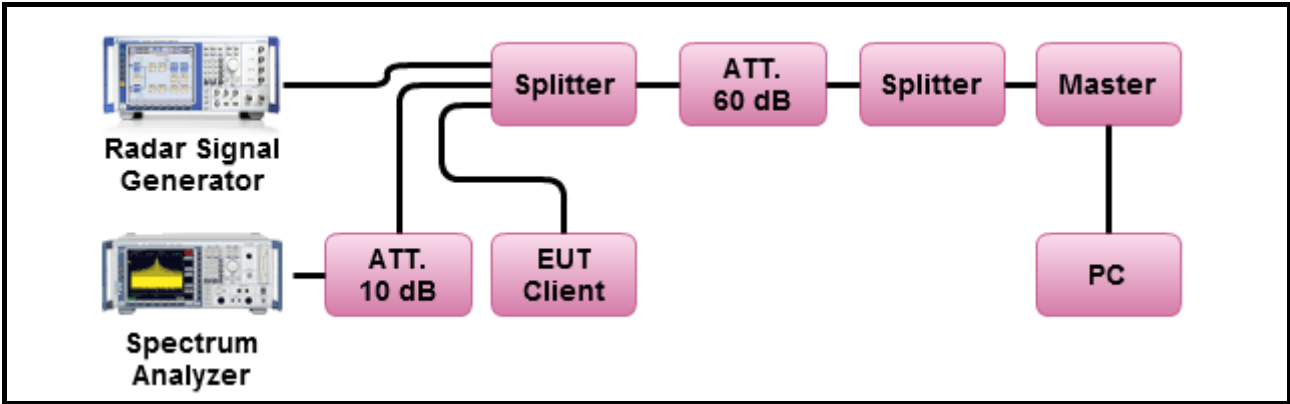

2.3.6 Channel Loading/Data Streaming

- IP Based (Load Based) - stream the test file from the Master to the Client.
- The data file must be of a type that is typical for the device (i.e., MPEG-2, MPEG-4, WAV, MP3, MP4, AVI, etc.) and must generally be transmitting in a streaming mode.
- Minimum channel loading of approximately 17 %

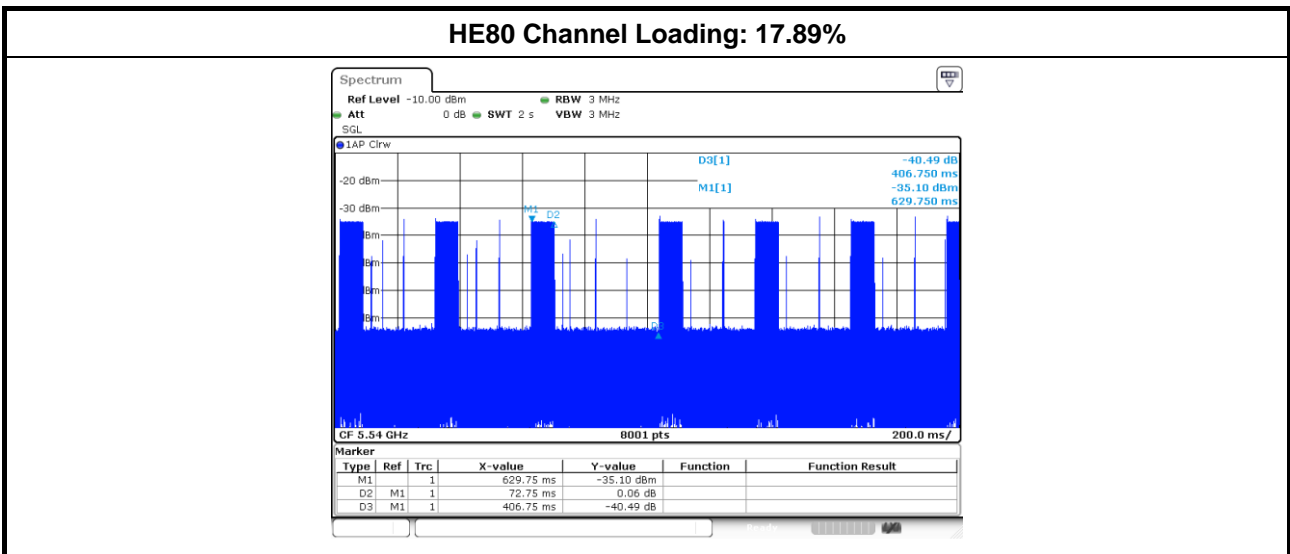

3 DFS test result

3.1 DFS Detection Threshold levels

Master DFS Threshold Level
DFS Threshold level: -58.78dBm
The Interference Radar Detection Threshold Level is $(-64\text{dBm}) + ([4.22\text{dBi}]) + \{1 \text{ dB}\} = -58.78 \text{ dBm}$. That had been taken into account the master output power range and antenna gain.

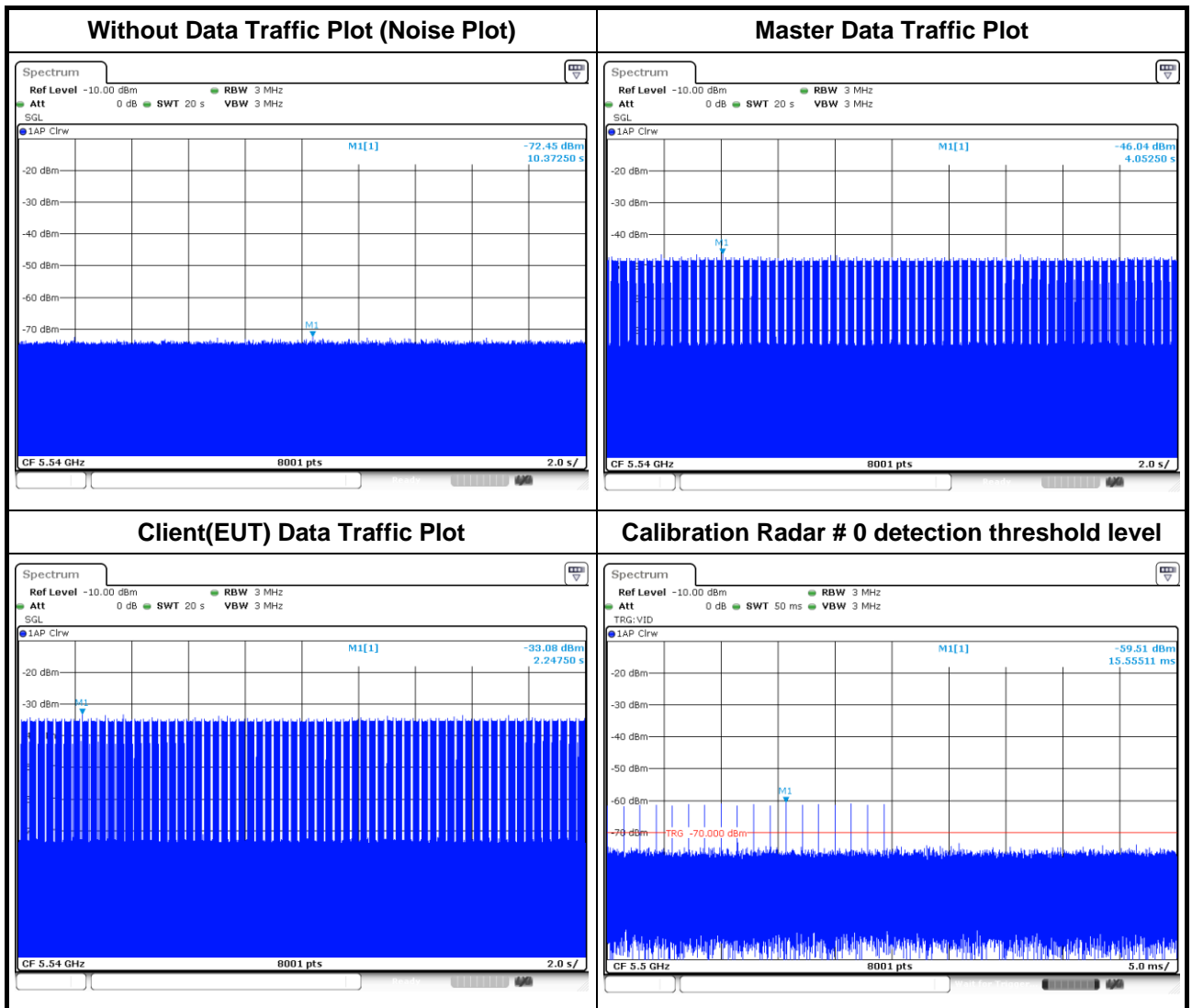

3.2 In-Service Monitoring

3.2.1 In-service Monitoring Limit

In-service Monitoring Limit	
Channel Move Time	10 sec
Channel Closing Transmission Time	200 ms + an aggregate of 60 ms over remaining 10 sec periods.
Non-occupancy period	Minimum 30 minutes

3.2.2 Test Procedures

Test Method	
<input checked="" type="checkbox"/>	Refer as FCC KDB 905462 D02, clause 7.8.3 verified during In-Service Monitoring; Channel Closing Transmission Time, Channel Move Time. EUT will associate with the master device. Observe the transmissions of the EUT at the end of the radar Burst on the Operating Channel for duration greater than 10 seconds. Measure and record the transmissions from the EUT during the observation time (Channel Move Time). Compare the Channel Move Time and Channel Closing Transmission Time limits.
<input checked="" type="checkbox"/>	Refer as FCC KDB 905462 D02, clause 7.8.3 verified during In-Service Monitoring; Non-Occupancy Period. EUT will associate with the master device. Observe the transmissions of the EUT at the end of the radar Burst on the Operating Channel for duration greater than 10 seconds. Measure and record the transmissions from the EUT during the observation time (Non-Occupancy Period). Compare the Non-Occupancy Period limits.

3.2.3 Test Result of Channel Closing Transmission and Channel Move Time

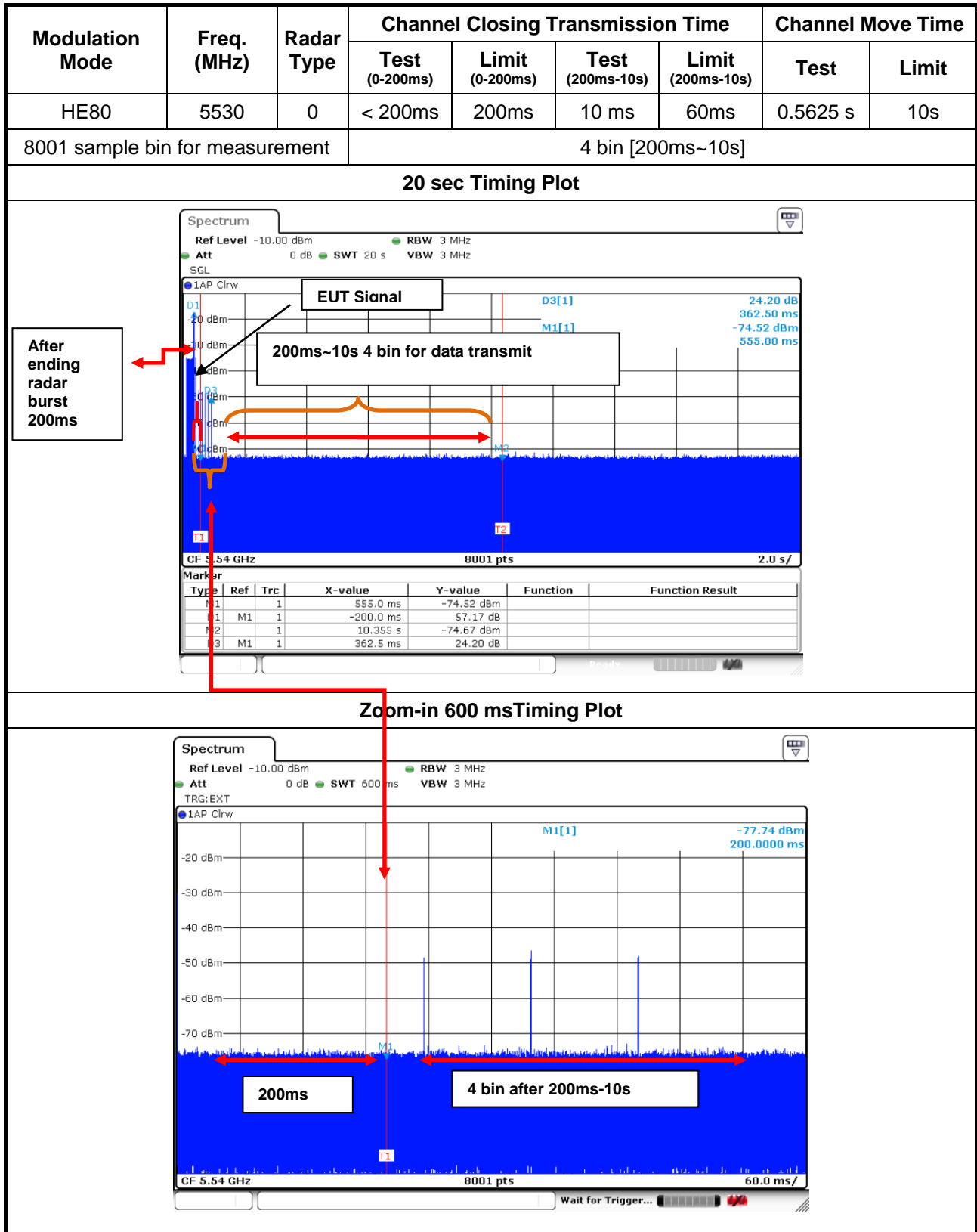

3.2.4 Test Result of Non-Occupancy

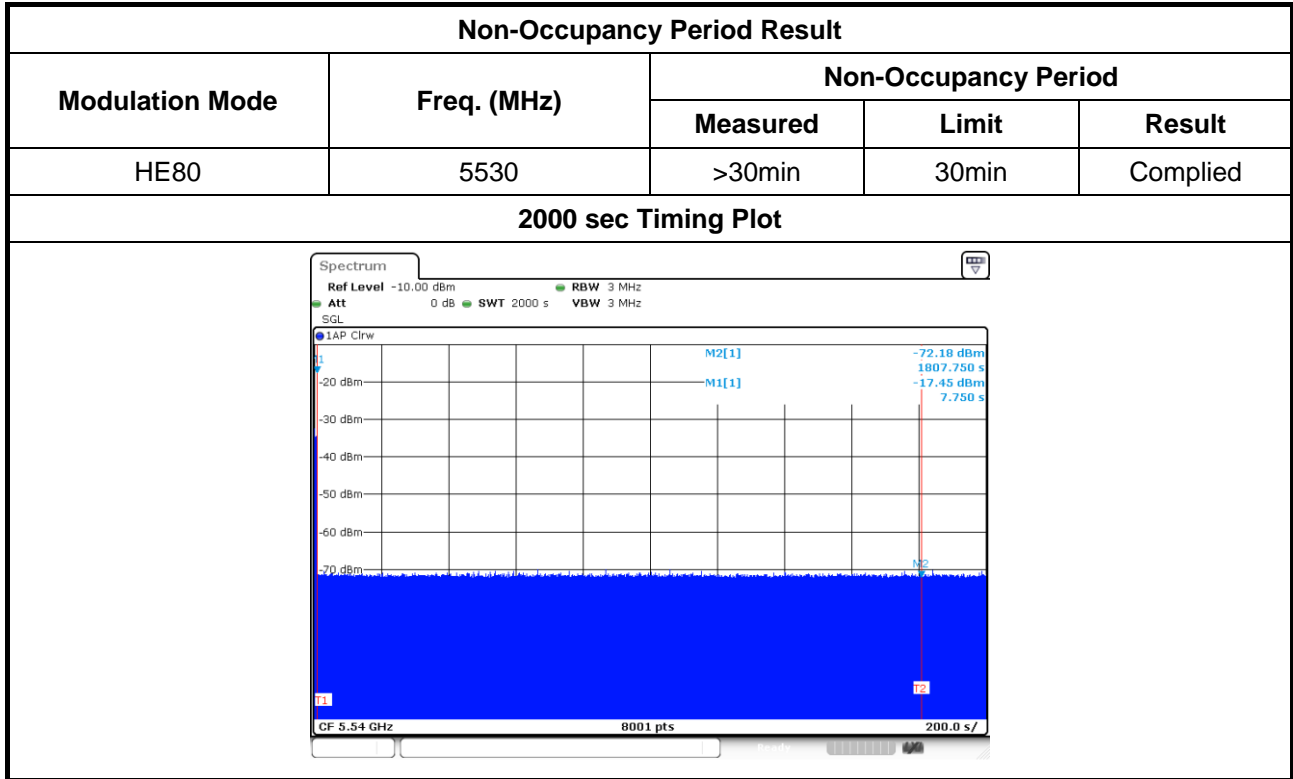

3.3 Non-Associated

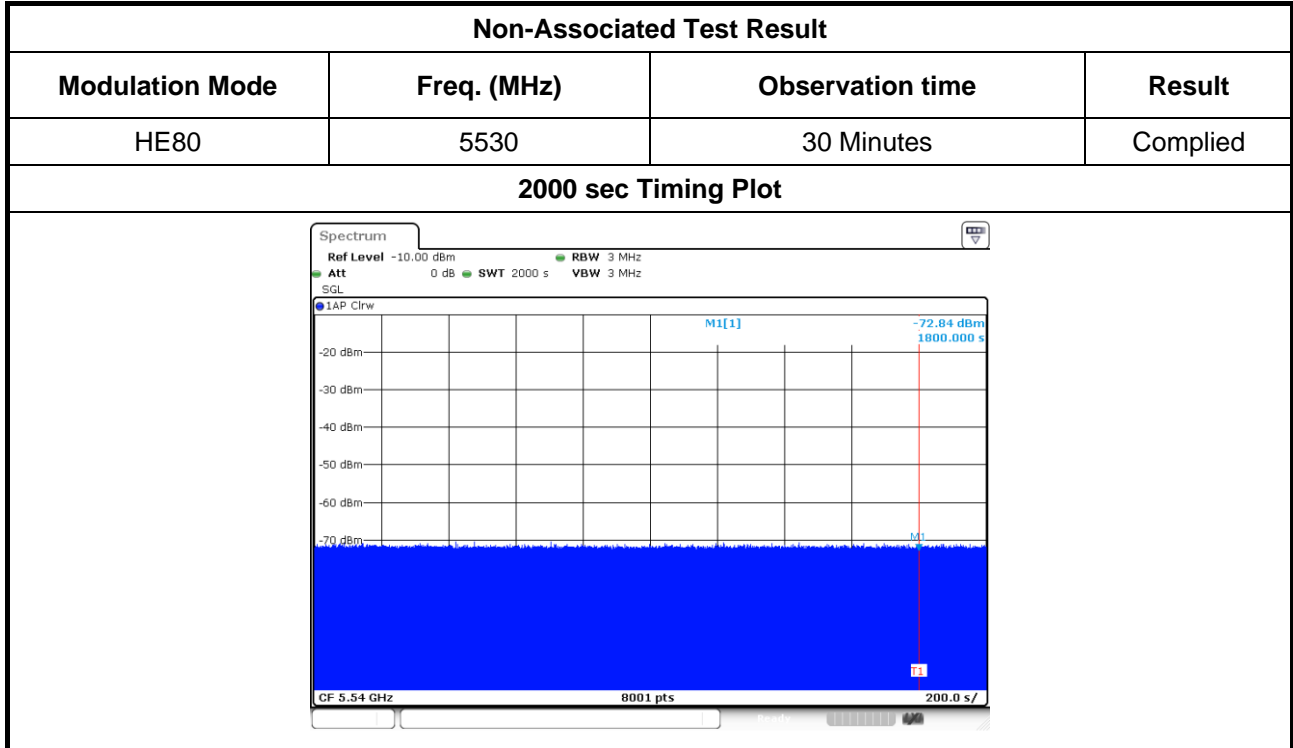

4 Test laboratory information

Established in 2012, ICC provides foremost EMC & RF Testing and advisory consultation services by our skilled engineers and technicians. Our services employ a wide variety of advanced edge test equipment and one of the widest certification extents in the business.

International Certification Corporation (EMC and Wireless Communication Laboratory), it is our definitive objective is to institute long term, trust-based associations with our clients. The expectation we set up with our clients is based on outstanding service, practical expertise and devotion to a certified value structure. Our passion is to grant our clients with best EMC / RF services by oriented knowledgeable and accommodating staff.

Our Test sites are located at Linkou District and Kwei Shan District. Location map can be found on our website <http://www.icertifi.com.tw>.

Linkou

Tel: 886-2-2601-1640

No.30-2, Ding Fwu Tsuen, Lin Kou
District, New Taipei City, Taiwan
(R.O.C.)

Kwei Shan

Tel: 886-3-271-8666

No.3-1, Lane 6, Wen San 3rd
St., Kwei Shan Dist., Tao Yuan
City 33381, Taiwan (R.O.C.)
No.2-1, Lane 6, Wen San 3rd
St., Kwei Shan Dist., Tao Yuan
City 33381, Taiwan (R.O.C.)

Kwei Shan Site II

Tel: 886-3-271-8640

No.14-1, Lane 19, Wen San 3rd
St., Kwei Shan Dist., Tao Yuan
City 333, Taiwan (R.O.C.)

If you have any suggestion, please feel free to contact us as below information.

Tel: 886-3-271-8666

Fax: 886-3-318-0345

Email: ICC_Service@icertifi.com.tw

==END==