

FCC Test Report (Co-Located)

Report No.: RFBEIH-WTW-P20110721-6

FCC ID: P27-XIONESCM1

Test Model: Xione-SC

Series Model: SCXlxxAEI-xCO
(xx For Marketing purpose (e.g.11, 12,13,14~);
x External Body Color for Product (e.g. Black=B; Gray=G; White= W))

Received Date: Nov. 24, 2020

Test Date: Jan. 25, 2021

Issued Date: Jan. 26, 2021

Applicant: Sercomm Corp.

Address: 8F, No. 3-1, YuanQu St., NanKang, Taipei 115, Taiwan, R.O.C. (NanKang Software Park)

Issued By: Bureau Veritas Consumer Products Services (H.K.) Ltd., Taoyuan Branch
Lin Kou Laboratories

Lab Address: No. 47-2, 14th Ling, Chia Pau Vil., Lin Kou Dist., New Taipei City, Taiwan

**FCC Registration/
Designation Number:** 198487 / TW2021



This report is for your exclusive use. Any copying or replication of this report to or for any other person or entity, or use of our name or trademark, is permitted only with our prior written permission. This report sets forth our findings solely with respect to the test samples identified herein. The results set forth in this report are not indicative or representative of the quality or characteristics of the lot from which a test sample was taken or any similar or identical product unless specifically and expressly noted. Our report includes all of the tests requested by you and the results thereof based upon the information that you provided to us. You have 60 days from date of issuance of this report to notify us of any material error or omission caused by our negligence, provided, however, that such notice shall be in writing and shall specifically address the issue you wish to raise. A failure to raise such issue within the prescribed time shall constitute your unqualified acceptance of the completeness of this report, the tests conducted and the correctness of the report contents. Unless specific mention, the uncertainty of measurement has been explicitly taken into account to declare the compliance or non-compliance to the specification.

Table of Contents

Release Control Record	3
1 Certificate of Conformity	4
2 Summary of Test Results	5
2.1 Measurement Uncertainty.....	5
2.2 Modification Record.....	5
3 General Information	6
3.1 General Description of EUT.....	6
3.2 Description of Test Modes.....	8
3.2.1 Test Mode Applicability and Tested Channel Detail.....	13
3.3 Configuration of System under Test.....	14
3.3.1 Configuration of System under Test.....	14
3.4 General Description of Applied Standards.....	15
4 Test Types and Results	16
4.1 Radiated Emission and Bandedge Measurement.....	16
4.1.1 Limits of Radiated Emission and Bandedge Measurement.....	16
4.1.2 Test Instruments.....	17
4.1.3 Test Procedures.....	18
4.1.4 Deviation from Test Standard.....	18
4.1.5 Test Setup.....	19
4.1.6 EUT Operating Conditions.....	20
4.1.7 Test Results.....	21
5 Pictures of Test Arrangements	27
Appendix – Information of the Testing Laboratories	28

Release Control Record

Issue No.	Description	Date Issued
RFBEIH-WTW-P20110721-6	Original release	Jan. 26, 2021

1 Certificate of Conformity

Product: Set Top Box

Brand: Comcast Xfinity

Test Model: Xione-SC

Series Model: SCX1xxAEI-xCO
(xx For Marketing purpose (e.g.11, 12,13,14~);
x External Body Color for Product (e.g. Black=B; Gray=G; White= W))

Sample Status: Engineering sample

Applicant: Sercomm Corp.

Test Date: Jan. 25, 2021

Standards: 47 CFR FCC Part 15, Subpart C (Section 15.247)

47 CFR FCC Part 15, Subpart E (Section 15.407)

ANSI C63.10:2013

The above equipment has been tested by **Bureau Veritas Consumer Products Services (H.K.) Ltd., Taoyuan Branch**, and found compliance with the requirement of the above standards. The test record, data evaluation & Equipment Under Test (EUT) configurations represented herein are true and accurate accounts of the measurements of the sample's RF characteristics under the conditions specified in this report.

Prepared by : Annie Chang, **Date:** Jan. 26, 2021
Annie Chang / Senior Specialist

Approved by : Rex Lai, **Date:** Jan. 26, 2021
Rex Lai / Associate Technical Manager

2 Summary of Test Results

Applied Standard	47 CFR FCC Part 15, Subpart C (Section 15.247) 47 CFR FCC Part 15, Subpart E (Section 15.407)		
FCC Clause	Test Item	Result	Remarks
15.205 / 15.209 / 15.247(d)/ 15.407(b) (1/2/3/4(i/ii)/6)	Radiated Emissions	Pass	Meet the requirement of limit. Minimum passing margin is -1.48dB at 2483.50MHz.

Note: Determining compliance based on the results of the compliance measurement, not taking into account measurement instrumentation uncertainty.

2.1 Measurement Uncertainty

Where relevant, the following measurement uncertainty levels have been estimated for tests performed on the EUT as specified in CISPR 16-4-2:

Measurement	Frequency	Expanded Uncertainty (k=2) (\pm)
Radiated Emissions up to 1 GHz	9kHz ~ 30MHz	2.61 dB
	30MHz ~ 1GHz	5.43 dB
Radiated Emissions above 1 GHz	Above 1GHz	5.14 dB

2.2 Modification Record

There were no modifications required for compliance.

3 General Information

3.1 General Description of EUT

Product	Set Top Box	
Brand	Comcast Xfinity	
Test Model	Xione-SC	
Series Model	SCXlxxAEI-xCO (xx For Marketing purpose (e.g.11, 12,13,14~); x External Body Color for Product (e.g. Black=B; Gray=G; White= W))	
Model Difference	Marketing Differentiation	
Status of EUT	Engineering sample	
Power Supply Rating	5Vdc from Adapter	
Modulation Type	WLAN	CCK, DQPSK, DBPSK for DSSS 56QAM, 64QAM, 16QAM, QPSK, BPSK for OFDM 1024QAM for OFDMA
	BT EDR	GFSK, $\pi/4$ -DQPSK, 8DPSK
	BT LE	GFSK
	Zigbee	O-QPSK
Modulation Technology	WLAN	DSSS, OFDM, OFDMA
	BT EDR	FHSS
Operating Frequency	WLAN	2.4GHz: 2412~2462MHz 5.0GHz: 5180~5240MHz, 5260~5320MHz, 5500~5720MHz, 5745~5825MHz
	BT EDR	2402MHz ~ 2480MHz
	BT LE	2402MHz ~ 2480MHz
	Zigbee	2425 ~ 2475MHz
Antenna Type	WLAN	2.4GHz: Ant. 0: Printed Antenna with 2.93dBi gain Ant. 1: Printed Antenna with 2.70dBi gain 5.0GHz: Ant. 0: Printed Antenna with 3.84dBi gain Ant. 1: Printed Antenna with 4.03dBi gain
	BT EDR	Printed antenna with 1.17dBi gain
	BT LE	Printed antenna with 1.17dBi gain
	Zigbee	Printed antenna with 1.17dBi gain
Antenna Connector	N/A	
Accessory Device	Adapter	
Cable Supplied	NA	

Note:

1. The EUT provides 2 completed transmitters and 2 receivers.

Modulation Mode	CDD Mode	Beamforming Mode	TX Function
802.11a	Support	Not Support	2TX
802.11b	Support	Not Support	2TX
802.11g	Support	Not Support	2TX
802.11n (20MHz)	Support	Not Support	2TX
802.11n (40MHz)	Support	Not Support	2TX
802.11ac (20MHz)	Support	Support	2TX
802.11ac (40MHz)	Support	Support	2TX
802.11ac (80MHz)	Support	Support	2TX
802.11ax (20MHz)	Support	Support	2TX
802.11ax (40MHz)	Support	Support	2TX
802.11ax (80MHz)	Support	Support	2TX

* The bandwidth and modulation are similar for 20MHz/40MHz on 802.11n mode and 20MHz/40MHz on 802.11n mode and 20MHz/40MHz on 802.11ax mode. Therefore the investigated worst case is the representative mode in test report. (Final test mode refer section 3.2.1)

* For 802.11n/ac/ax, CDD mode and Beamforming mode are presented in power output test item. For other test items, CDD mode is the worst case for final tests after pretesting.

2. WLAN & Bluetooth technologies can transmit at same time. 2.4GHz & 5GHz WLAN technologies cannot transmit at same time.

3. The above Antenna information is declared by manufacturer and for more detailed features description, please refer to the manufacturer's specifications, the laboratory shall not be held responsible.

4. The EUT consumes power from a switching power adapter, which has several models could be chosen, as the following:

Adapter	Brand	Model No.	Specification
1	LEI	ML08-7050150-A1	AC I/P: 100-120V, 50/60Hz, 0.25A DC O/P: 5V, 1.5A AC 2 Pin Non-shielded DC cable (1.8m)
2	Acbel	WAK010	AC I/P: 100-120V, 50/60Hz, 0.25A DC O/P: 5V, 1.5A AC 2 Pin Non-shielded DC cable (1.8m)

The above two adapters were pre-tested, and Adapter 1 was the worst case for final test.

5. The above EUT information is declared by manufacturer and for more detailed features description, please refer to the manufacturer's specifications or user's manual.

3.2 Description of Test Modes

For WLAN (2.4GHz):

11 channels are provided for 802.11b, 802.11g and 802.11n (20MHz), 802.11ac (20MHz), 802.11ax (20MHz):

Channel	Frequency	Channel	Frequency
1	2412MHz	7	2442MHz
2	2417MHz	8	2447MHz
3	2422MHz	9	2452MHz
4	2427MHz	10	2457MHz
5	2432MHz	11	2462MHz
6	2437MHz		

7 channels are provided for 802.11n (40MHz), 802.11ac (40MHz), 802.11ax (40MHz):

Channel	Frequency	Channel	Frequency
3	2422MHz	7	2442MHz
4	2427MHz	8	2447MHz
5	2432MHz	9	2452MHz
6	2437MHz		

For WLAN (5GHz)

For 5180 ~ 5240MHz:

4 channels are provided for 802.11a, 802.11n (20MHz), 802.11ac (20MHz), 802.11ax (20MHz):

Channel	Frequency	Channel	Frequency
36	5180 MHz	44	5220 MHz
40	5200 MHz	48	5240 MHz

2 channels are provided for 802.11n (40MHz), 802.11ac (40MHz), 802.11ax (40MHz):

Channel	Frequency	Channel	Frequency
38	5190 MHz	46	5230 MHz

1 channel is provided for 802.11ac (80MHz), 802.11ax (80MHz):

Channel	Frequency
42	5210MHz

5260~5320MHz:

4 channels are provided for 802.11a, 802.11n (20MHz), 802.11ac (20MHz), 802.11ax (20MHz):

Channel	Frequency	Channel	Frequency
52	5260 MHz	60	5300 MHz
56	5280 MHz	64	5320 MHz

2 channels are provided for 802.11n (40MHz), 802.11ac (40MHz), 802.11ax (40MHz):

Channel	Frequency	Channel	Frequency
54	5270 MHz	62	5310 MHz

1 channel is provided for 802.11ac (80MHz), 802.11ax (80MHz):

Channel	Frequency
58	5290MHz

5500~5720MHz:

12 channels are provided for 802.11a, 802.11n (20MHz), 802.11ac (20MHz), 802.11ax (20MHz):

Channel	Frequency	Channel	Frequency
100	5500 MHz	124	5620 MHz
104	5520 MHz	128	5640 MHz
108	5540 MHz	132	5660 MHz
112	5560 MHz	136	5680 MHz
116	5580 MHz	140	5700 MHz
120	5600 MHz	144	5720 MHz

6 channels are provided for 802.11n (40MHz), 802.11ac (40MHz), 802.11ax (40MHz):

Channel	Frequency	Channel	Frequency
102	5510 MHz	126	5630 MHz
110	5550 MHz	134	5670 MHz
118	5590 MHz	142	5710 MHz

3 channels are provided for 802.11ac (80MHz), 802.11ax (80MHz):

Channel	Frequency	Channel	Frequency
106	5530 MHz	122	5610 MHz
138	5690 MHz		

5745~5825MHz:

5 channels are provided for 802.11a, 802.11n (20MHz), 802.11ac (20MHz), 802.11ax (20MHz):

Channel	Frequency	Channel	Frequency
149	5745MHz	161	5805MHz
153	5765MHz	165	5825MHz
157	5785MHz		

2 channels are provided for 802.11n (40MHz), 802.11ac (40MHz), 802.11ax (40MHz):

Channel	Frequency	Channel	Frequency
151	5755MHz	159	5795MHz

1 channel is provided for 802.11ac (80MHz), 802.11ax (80MHz):

Channel	Frequency
155	5775MHz

For BT EDR

79 channels are provided for BT-EDR mode:

Channel	Freq. (MHz)	Channel	Freq. (MHz)	Channel	Freq. (MHz)	Channel	Freq. (MHz)
0	2402	20	2422	40	2442	60	2462
1	2403	21	2423	41	2443	61	2463
2	2404	22	2424	42	2444	62	2464
3	2405	23	2425	43	2445	63	2465
4	2406	24	2426	44	2446	64	2466
5	2407	25	2427	45	2447	65	2467
6	2408	26	2428	46	2448	66	2468
7	2409	27	2429	47	2449	67	2469
8	2410	28	2430	48	2450	68	2470
9	2411	29	2431	49	2451	69	2471
10	2412	30	2432	50	2452	70	2472
11	2413	31	2433	51	2453	71	2473
12	2414	32	2434	52	2454	72	2474
13	2415	33	2435	53	2455	73	2475
14	2416	34	2436	54	2456	74	2476
15	2417	35	2437	55	2457	75	2477
16	2418	36	2438	56	2458	76	2478
17	2419	37	2439	57	2459	77	2479
18	2420	38	2440	58	2460	78	2480
19	2421	39	2441	59	2461		

For BT LE

40 channels are provided to this EUT:

CHANNEL	FREQ. (MHz)	CHANNEL	FREQ. (MHz)	CHANNEL	FREQ. (MHz)	CHANNEL	FREQ. (MHz)
0	2402	10	2422	20	2442	30	2462
1	2404	11	2424	21	2444	31	2464
2	2406	12	2426	22	2446	32	2466
3	2408	13	2428	23	2448	33	2468
4	2410	14	2430	24	2450	34	2470
5	2412	15	2432	25	2452	35	2472
6	2414	16	2434	26	2454	36	2474
7	2416	17	2436	27	2456	37	2476
8	2418	18	2438	28	2458	38	2478
9	2420	19	2440	29	2460	39	2480

For Zigbee

11 channels are provided to this EUT:

CHANNEL	FREQUENCY	CHANNEL	FREQUENCY
15	2425MHz	21	2455MHz
16	2430MHz	22	2460MHz
17	2435MHz	23	2465MHz
18	2440MHz	24	2470MHz
19	2445MHz	25	2475MHz
20	2450MHz		

3.2.1 Test Mode Applicability and Tested Channel Detail

EUT Configure Mode	Applicable to		Description
	RE \geq 1G	RE<1G	
-	√	√	-

Where RE \geq 1G: Radiated Emission above 1GHz & Bandedge Measurement RE<1G: Radiated Emission below 1GHz

Radiated Emission Test (Above 1GHz):

- Pre-Scan has been conducted to determine the worst-case mode from all possible combinations between available modulations, data rates and antenna ports (if EUT with antenna diversity architecture).
- Following channel(s) was (were) selected for the final test as listed below.

EUT Configure Mode	Mode	Freq. Range (MHz)	Available Channel	Tested Channel	Modulation Technology
1	802.11b + BT EDR	2412 ~ 2462	1 to 11	1 + 78	DSSS
		2402 ~ 2480	0 to 78		FHSS
2	802.11ax (40MHz) + BT EDR	5745-5825	151 to 159	159 + 78	OFDMA
		2402 ~ 2480	0 to 78		FHSS

*The above test mode was found to be the worst cases test mode and had been chosen for final test.

Radiated Emission Test (Below 1GHz):

- Pre-Scan has been conducted to determine the worst-case mode from all possible combinations between available modulations, data rates and antenna ports (if EUT with antenna diversity architecture).
- Following channel(s) was (were) selected for the final test as listed below.

EUT Configure Mode	Mode	Freq. Range (MHz)	Available Channel	Tested Channel	Modulation Technology
1	802.11b + BT EDR	2412 ~ 2462	1 to 11	1 + 78	DSSS
		2402 ~ 2480	0 to 78		FHSS
2	802.11ax (40MHz) + BT EDR	5745-5825	151 to 159	159 + 78	OFDMA
		2402 ~ 2480	0 to 78		FHSS

*The above test mode was found to be the worst cases test mode and had been chosen for final test.

Test Condition:

Applicable to	Environmental Conditions	Input Power	Tested by
RE \geq 1G	20 deg. C, 64% RH	120Vac, 60Hz	Ian Chang
RE<1G	20 deg. C, 64% RH	120Vac, 60Hz	Ian Chang

3.3 Configuration of System under Test

The ET has been tested as an independent unit together with other necessary accessories or support units. The following support units or accessories were used to form a representative test configuration during the tests.

ID	Product	Brand	Model No.	Serial No.	FCC ID	Remarks
A.	LCD Monitor	ASUS	MG28UQ	H8LMTF147978	N/A	Supplied by client
B.	Notebook PC	Lenovo	81LG	PHNGBDP	N/A	Provided by Lab
C.	AP	Netgear	R6800	N/A	N/A	Provided by Lab
D.	Wireless Connection Tester	ROHDE & SCHWARZ	CMW270	101075	N/A	Provided by Lab

Note:

1. All power cords of the above support units are non-shielded (1.8m).
2. Items B-D acted as communication partners to transfer data.

No.	Cable Descriptions	Qty.	Length (m)	Shielding (Yes/ No)	Cores (Qty.)	Remarks
1.	LAN cable	1	10	N	0	Provided by Lab (RJ45, Cat.5e)
2.	HDMI cable	1	1.5	Y	0	Provided by Lab
3.	DC cable	1	1.8	N	0	Supplied by client

NOTE: The core(s) is(are) originally attached to the cable(s).

3.3.1 Configuration of System under Test

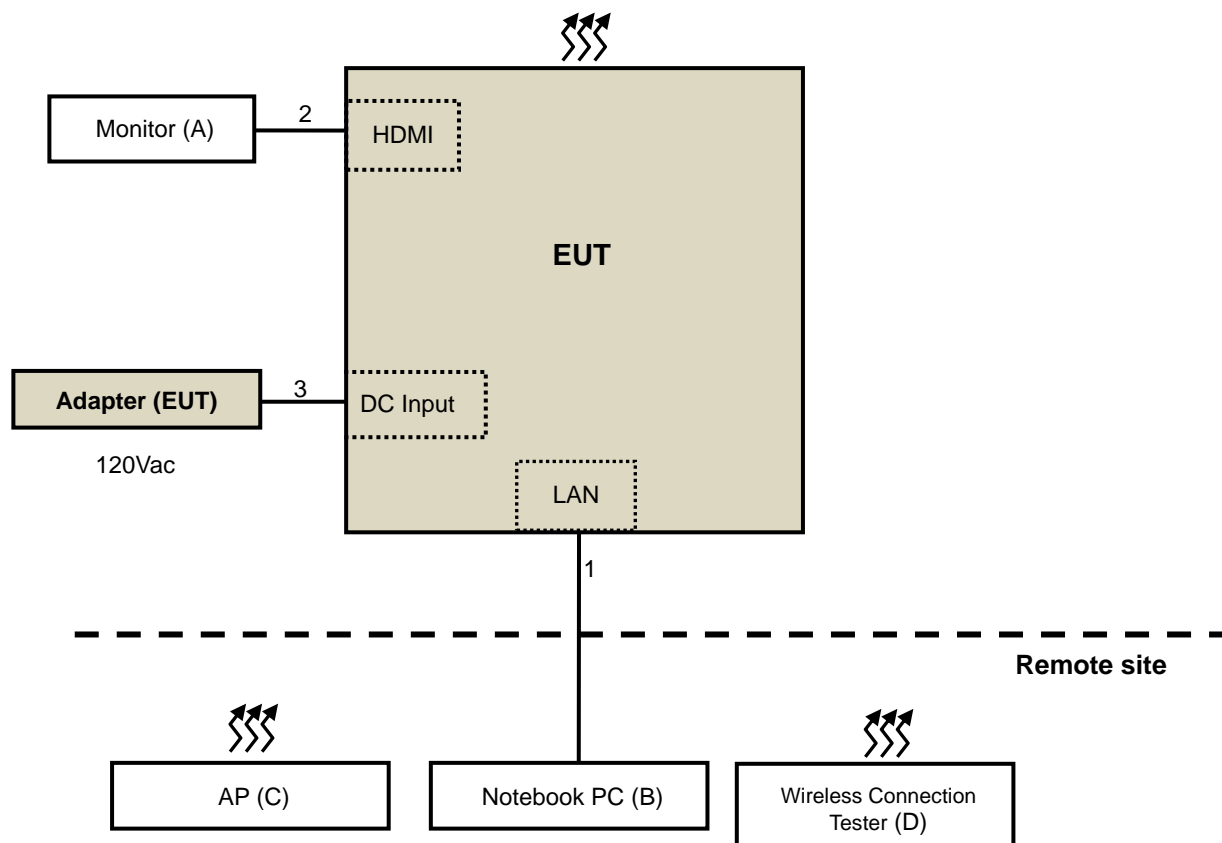

3.4 General Description of Applied Standards

The EUT is a RF Product. According to the specification of the EUT declared by the manufacturer, it must comply with the requirements of the following standards:

FCC Part 15, Subpart C (15.247)

FCC Part 15, Subpart E (15.407)

ANSI C63.10:2013

All test items have been performed and recorded as per the above standards.

4 Test Types and Results

4.1 Radiated Emission and Bandedge Measurement

4.1.1 Limits of Radiated Emission and Bandedge Measurement

Radiated emissions which fall in the restricted bands must comply with the radiated emission limits specified as below table.

Frequencies (MHz)	Field Strength (microvolts/meter)	Measurement Distance (meters)
0.009 ~ 0.490	2400/F(kHz)	300
0.490 ~ 1.705	24000/F(kHz)	30
1.705 ~ 30.0	30	30
30 ~ 88	100	3
88 ~ 216	150	3
216 ~ 960	200	3
Above 960	500	3

Note:

1. The lower limit shall apply at the transition frequencies.
2. Emission level (dBuV/m) = 20 log Emission level (uV/m).
3. For frequencies above 1000MHz, the field strength limits are based on average detector, however, the peak field strength of any emission shall not exceed the maximum permitted average limits, specified above by more than 20dB under any condition of modulation.

Limits of unwanted emission out of the restricted bands

Applicable To		Limit	
789033 D02 General UNII Test Procedure New Rules v02r01		Field Strength at 3m	
		PK: 74 (dBuV/m)	AV: 54 (dBuV/m)
Frequency Band	Applicable To	EIRP Limit	Equivalent Field Strength at 3m
5150~5250 MHz	15.407(b)(1)	PK: -27 (dBm/MHz)	PK: 68.2(dBuV/m)
5250~5350 MHz	15.407(b)(2)		
5470~5725 MHz	15.407(b)(3)		
5725~5850 MHz	<input checked="" type="checkbox"/> 15.407(b)(4)(i)	PK: -27 (dBm/MHz) ^{*1} PK: 10 (dBm/MHz) ^{*2} PK: 15.6 (dBm/MHz) ^{*3} PK: 27 (dBm/MHz) ^{*4}	PK: 68.2(dBuV/m) ^{*1} PK: 105.2 (dBuV/m) ^{*2} PK: 110.8(dBuV/m) ^{*3} PK: 122.2 (dBuV/m) ^{*4}
	<input type="checkbox"/> 15.407(b)(4)(ii)	Emission limits in section 15.247(d)	
^{*1} beyond 75 MHz or more above of the band edge. ^{*3} below the band edge increasing linearly to a level of 15.6 dBm/MHz at 5 MHz above.		^{*2} below the band edge increasing linearly to 10 dBm/MHz at 25 MHz above. ^{*4} from 5 MHz above or below the band edge increasing linearly to a level of 27 dBm/MHz at the band edge.	

Note: The following formula is used to convert the equipment isotropic radiated power (eirp) to field strength:

$$E = \frac{1000000\sqrt{30P}}{3} \mu\text{V/m, where P is the eirp (Watts).}$$

4.1.2 Test Instruments

DESCRIPTION & MANUFACTURER	MODEL NO.	SERIAL NO.	CALIBRATED DATE	CALIBRATED UNTIL
HP Preamplifier	8447D	2432A03504	Feb. 19, 2020	Feb. 18, 2021
HP Preamplifier	8449B	3008A01201	Feb. 20, 2020	Feb. 19, 2021
MITEQ Preamplifier	AMF-6F-260400-33-8P	892164	Feb. 19, 2020	Feb. 18, 2021
Agilent TEST RECEIVER	N9038A	MY51210129	Mar. 18, 2020	Mar. 17, 2021
Schwarzbeck Antenna	VULB 9168	139	Nov. 6, 2020	Nov. 5, 2021
Schwarzbeck Antenna	VHBA 9123	480	Jun. 3, 2019	Jun. 2, 2021
Schwarzbeck Horn Antenna	BBHA-9170	212	Nov. 22, 2020	Nov. 21, 2021
EMCO Horn Antenna	3115	00027024	Nov. 22, 2020	Nov.21, 2021
ADT. Turn Table	TT100	0306	NA	NA
ADT. Tower	AT100	0306	NA	NA
Software	Radiated_V7.6.15.9.5	NA	NA	NA
SUHNER RF cable With 4dB PAD	SF102	Cable-CH6-01	Jul. 9, 2020	Jul. 8, 2021
EMEC RF cable With 3/4dB PAD	EM102-KMKM	01	Aug. 21, 2020	Aug. 20, 2021
KEYSIGHT MIMO Powermeasurement Test set	U2021XA	U2021XA-001	Jun. 16, 2020	Jun. 15, 2021
KEYSIGHT Spectrum Analyzer	N9030A	MY54490260	Jul. 22, 2020	Jul. 21, 2021
Loop Antenna EMCI	LPA600	270	Aug. 23, 2019	Aug. 22, 2021
EMCO Horn Antenna	3115	00028257	Nov. 22, 2020	Nov. 21, 2021
Highpass filter Wainwright Instruments	WHK 3.1/18G-10SS	SN 8	NA	NA
ROHDE & SCHWARZ Spectrum Analyzer	FSV40	101042	Sep. 8, 2020	Sep. 7, 2021
Anritsu Power Sensor	MA2411B	0738404	Apr. 13, 2020	Apr. 12, 2021
Anritsu Power Meter	ML2495A	0842014	Apr. 13, 2020	Apr. 12, 2021

- NOTE:** 1. The calibration interval of the above test instruments is 12/24 months. And the calibrations are traceable to NML/ROC and NIST/USA.
2. The horn antenna and HP preamplifier (model: 8449B) are used only for the measurement of emission frequency above 1GHz if tested.
3. The test was performed in Chamber No. 6.

4.1.3 Test Procedures

For Radiated emission below 30MHz

- a. The EUT was placed on the top of a rotating table 0.8 meters above the ground at a 3 meter chamber room. The table was rotated 360 degrees to determine the position of the highest radiation.
- b. The EUT was set 3 meters away from the interference-receiving antenna, which was mounted on the top of a variable-height antenna tower.
- c. Parallel, perpendicular, and ground-parallel orientations of the antenna are set to make the measurement.
- d. For each suspected emission, the EUT was arranged to its worst case and the rotatable table was turned from 0 degrees to 360 degrees to find the maximum reading.
- e. The test-receiver system was set to Quasi-Peak Detect Function and Specified Bandwidth with Maximum Hold Mode.

Note:

1. The resolution bandwidth and video bandwidth of test receiver/spectrum analyzer is 9kHz at frequency below 30MHz.

For Radiated emission above 30MHz

- a. The EUT was placed on the top of a rotating table 0.8 meters (for 30MHz ~ 1GHz) / 1.5 meters (for above 1GHz) above the ground at 3 meter chamber room for test. The table was rotated 360 degrees to determine the position of the highest radiation.
- b. The EUT was set 3 meters away from the interference-receiving antenna, which was mounted on the top of a variable-height antenna tower.
- c. The height of antenna is varied from one meter to four meters above the ground to determine the maximum value of the field strength. Both horizontal and vertical polarizations of the antenna are set to make the measurement.
- d. For each suspected emission, the EUT was arranged to its worst case and then the antenna was tuned to heights from 1 meter to 4 meters and the rotatable table was turned from 0 degrees to 360 degrees to find the maximum reading.
- e. The test-receiver system was set to quasi-peak detect function and specified bandwidth with maximum hold mode when the test frequency is below 1 GHz.
- f. The test-receiver system was set to peak and average detect function and specified bandwidth with maximum hold mode when the test frequency is above 1 GHz. If the peak reading value also meets average limit, measurement with the average detector is unnecessary.

Note:

1. The resolution bandwidth and video bandwidth of test receiver/spectrum analyzer is 120kHz for Quasi-peak detection (QP) or Peak detection (PK) at frequency below 1GHz.
2. The resolution bandwidth of test receiver/spectrum analyzer is 1 MHz and the video bandwidth is 3 MHz for Peak detection (PK) at frequency above 1GHz.
3. The resolution bandwidth of test receiver/spectrum analyzer is 1MHz and the video bandwidth is $\geq 1/T$ (Duty cycle < 98%) or 10Hz (Duty cycle $\geq 98\%$) for Average detection (AV) at frequency above 1GHz.
(802.11b: RBW = 1MHz, VBW = 10Hz; 802.11ax (40MHz): RBW = 1MHz, VBW = 10Hz;
BT EDR (GFSK): (PK) RB=1MHz, VB=3 MHz; (AV) 1M/3M detector RMS trace AV)
4. All modes of operation were investigated and the worst-case emissions are reported.

4.1.4 Deviation from Test Standard

No deviation.

4.1.5 Test Setup

For Radiated emission below 30MHz

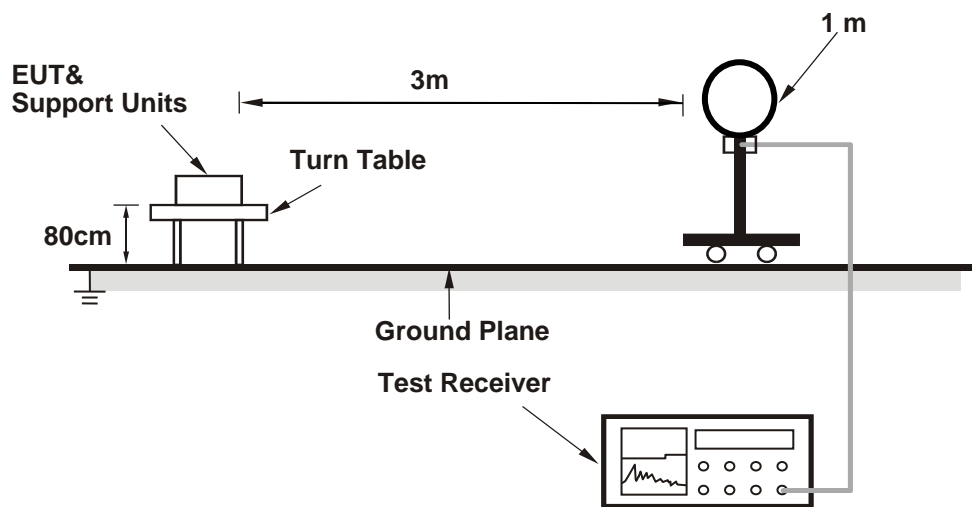

For Radiated emission 30MHz to 1GHz

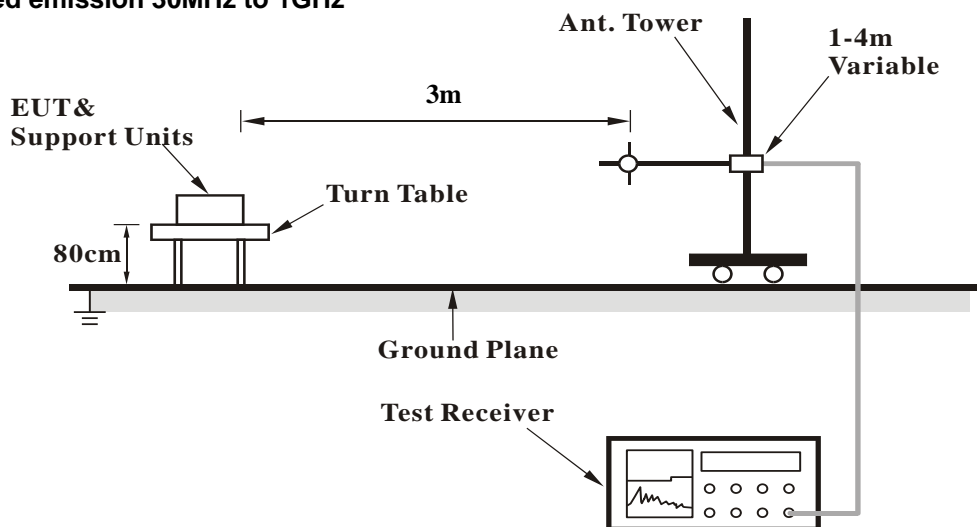

For Radiated emission above 1GHz

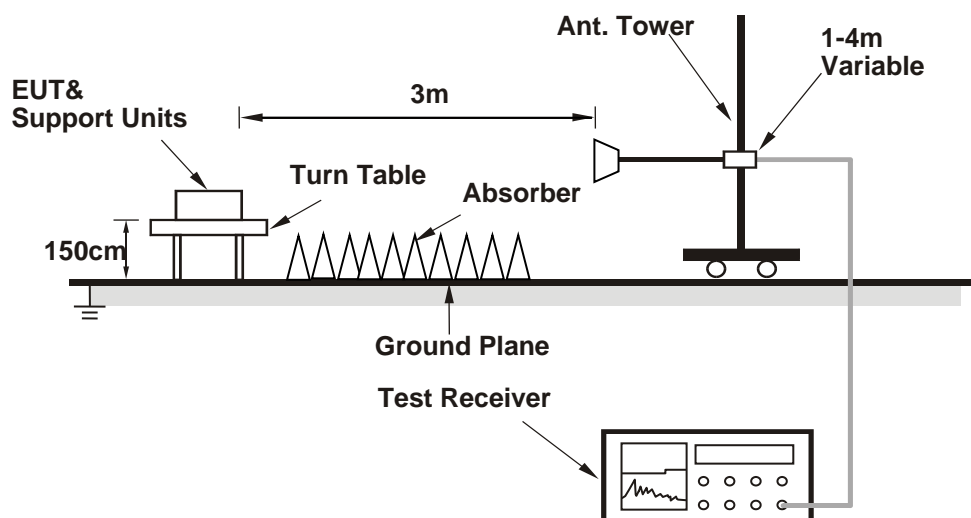

For the actual test configuration, please refer to the attached file (Test Setup Photo).

4.1.6 EUT Operating Conditions

- a. Placed the EUT on the testing table.
- b. Prepared a notebook to act as a communication partner and placed it outside of testing area.
- c. The communication partner connected with EUT via a RJ45 cable and ran a test program (provided by manufacturer) to enable EUT under transmission condition continuously at specific channel frequency.
- d. The communication partner sent data to EUT by command "PING".

4.1.7 Test Results

Above 1GHz data:

Mode 1

802.11b: CH 1+ BT EDR (GFSK): CH 78

Frequency Range	1GHz ~ 25GHz	Detector Function	Peak (PK) Average (AV)
-----------------	--------------	-------------------	---------------------------

Antenna Polarity & Test Distance : Horizontal at 3 m								
No	Frequency (MHz)	Emission Level (dBuV/m)	Limit (dBuV/m)	Margin (dB)	Antenna Height (m)	Table Angle (Degree)	Raw Value (dBuV)	Correction Factor (dB/m)
1	2390.00	59.03 PK	74.00	-14.97	1.51 H	347	57.68	1.35
2	2390.00	46.18 AV	54.00	-7.82	1.51 H	347	44.83	1.35
3	2483.50	61.45 PK	74.00	-12.55	1.51 H	347	59.62	1.83
4	2483.50	45.99 AV	54.00	-8.01	1.51 H	347	44.16	1.83
5	4824.00	50.15 PK	74.00	-23.85	3.65 H	130	40.73	9.42
6	4824.00	39.14 AV	54.00	-14.86	3.65 H	130	29.72	9.42
7	4960.00	50.95 PK	74.00	-23.05	2.98 H	360	41.39	9.56
8	4960.00	40.11 AV	54.00	-13.89	2.98 H	360	30.55	9.56

Antenna Polarity & Test Distance : Vertical at 3 m								
No	Frequency (MHz)	Emission Level (dBuV/m)	Limit (dBuV/m)	Margin (dB)	Antenna Height (m)	Table Angle (Degree)	Raw Value (dBuV)	Correction Factor (dB/m)
1	2390.00	66.30 PK	74.00	-7.70	3.85 V	266	64.95	1.35
2	2390.00	47.77 AV	54.00	-6.23	3.85 V	266	46.42	1.35
3	2483.50	63.05 PK	74.00	-10.95	3.85 V	266	61.22	1.83
4	2483.50	46.13 AV	54.00	-7.87	3.85 V	266	44.30	1.83
5	4824.00	49.58 PK	74.00	-24.42	2.34 V	168	40.16	9.42
6	4824.00	38.65 AV	54.00	-15.35	2.34 V	168	29.23	9.42
7	4960.00	50.44 PK	74.00	-23.56	2.74 V	187	40.88	9.56
8	4960.00	39.64 AV	54.00	-14.36	2.74 V	187	30.08	9.56

Remarks:

1. Emission Level(dBuV/m) = Raw Value(dBuV) + Correction Factor(dB/m)
2. Correction Factor(dB/m) = Antenna Factor(dB/m) + Cable Factor(dB) – Pre-Amplifier Factor(dB)
3. The other emission levels were very low against the limit.
4. Margin value = Emission Level – Limit value

Mode 2

802.11ax (40MHz): CH 159 + BT EDR (GFSK): CH 78

Frequency Range	1GHz ~ 25GHz	Detector Function	Peak (PK) Average (AV)
-----------------	--------------	-------------------	---------------------------

Antenna Polarity & Test Distance : Horizontal at 3 m								
No	Frequency (MHz)	Emission Level (dBuV/m)	Limit (dBuV/m)	Margin (dB)	Antenna Height (m)	Table Angle (Degree)	Raw Value (dBuV)	Correction Factor (dB/m)
1	2483.50	61.45 PK	68.20	-6.75	1.51 H	347	59.62	1.83
2	2483.50	45.99 AV	54.00	-8.01	1.51 H	347	44.16	1.83
3	4960.00	50.95 PK	74.00	-23.05	2.98 H	357	41.39	9.56
4	4960.00	40.11 AV	54.00	-13.89	2.98 H	357	30.55	9.56
5	#5622.68	63.20 PK	68.20	-5.00	3.35 H	33	52.31	10.89
6	#6013.12	62.98 PK	68.20	-5.22	3.35 H	33	52.01	10.97
7	11590.00	59.47 PK	74.00	-14.53	2.84 H	153	40.61	18.86
8	11590.00	48.83 AV	54.00	-5.17	2.84 H	153	29.97	18.86

Antenna Polarity & Test Distance : Vertical at 3 m								
No	Frequency (MHz)	Emission Level (dBuV/m)	Limit (dBuV/m)	Margin (dB)	Antenna Height (m)	Table Angle (Degree)	Raw Value (dBuV)	Correction Factor (dB/m)
1	2483.50	66.72 PK	68.20	-1.48	3.83 V	265	64.89	1.83
2	2483.50	48.27 AV	54.00	-5.73	3.83 V	265	46.44	1.83
3	4960.00	50.37 PK	74.00	-23.63	2.71 V	184	40.81	9.56
4	4960.00	39.50 AV	54.00	-14.50	2.71 V	184	29.94	9.56
5	#5609.85	61.92 PK	68.20	-6.28	3.58 V	177	50.99	10.93
6	#5968.95	63.66 PK	68.20	-4.54	3.58 V	177	52.79	10.87
7	11590.00	59.23 PK	74.00	-14.77	2.63 V	204	40.37	18.86
8	11590.00	48.65 AV	54.00	-5.35	2.63 V	204	29.79	18.86

Remarks:

1. Emission Level(dBuV/m) = Raw Value(dBuV) + Correction Factor(dB/m)
2. Correction Factor(dB/m) = Antenna Factor(dB/m) + Cable Factor(dB) – Pre-Amplifier Factor(dB)
3. The other emission levels were very low against the limit.
4. Margin value = Emission Level – Limit value
5. " # ": The radiated frequency is out of the restricted band.

Below 1GHz data:

Mode 1

802.11b: CH 1+ BT EDR (GFSK): CH 78

Frequency Range	9kHz ~ 1GHz	Detector Function	Quasi-Peak (QP)
-----------------	-------------	-------------------	-----------------

Antenna Polarity & Test Distance : Horizontal at 3 m								
No	Frequency (MHz)	Emission Level (dBuV/m)	Limit (dBuV/m)	Margin (dB)	Antenna Height (m)	Table Angle (Degree)	Raw Value (dBuV)	Correction Factor (dB/m)
1	57.94	26.49 QP	40.00	-13.51	1.78 H	321	34.16	-7.67
2	191.75	27.20 QP	43.50	-16.30	1.34 H	266	36.20	-9.00
3	229.92	26.81 QP	46.00	-19.19	1.91 H	246	35.49	-8.68
4	343.46	28.94 QP	46.00	-17.06	1.05 H	246	32.39	-3.45
5	491.82	29.31 QP	46.00	-16.69	2.19 H	0	29.47	-0.16
6	617.72	31.85 QP	46.00	-14.15	1.65 H	147	29.18	2.67

Remarks:

1. Emission Level(dBuV/m) = Raw Value(dBuV) + Correction Factor(dB/m)
2. Correction Factor(dB/m) = Antenna Factor(dB/m) + Cable Factor(dB) – Pre-Amplifier Factor(dB)
3. Margin value = Emission Level – Limit value
4. The other emission levels were very low against the limit of frequency range 30MHz~1000MHz.
5. The emission levels were very low against the limit of frequency range 9kHz~30MHz: the amplitude of spurious emissions attenuated more than 20 dB below the permissible value to be report.

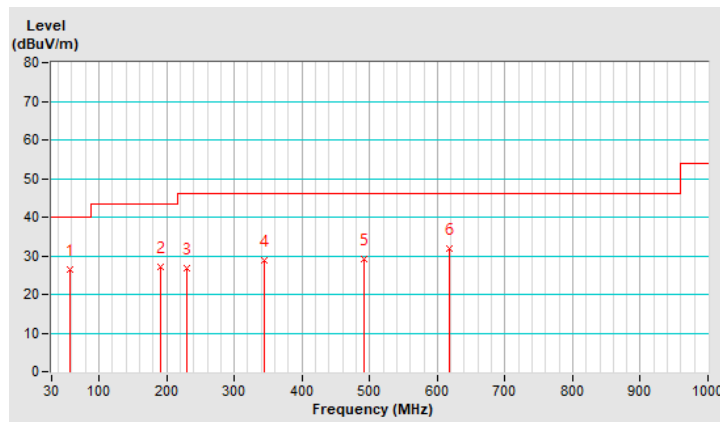

Frequency Range	9kHz ~ 1GHz	Detector Function	Quasi-Peak (QP)
-----------------	-------------	-------------------	-----------------

Antenna Polarity & Test Distance : Vertical at 3 m								
No	Frequency (MHz)	Emission Level (dBuV/m)	Limit (dBuV/m)	Margin (dB)	Antenna Height (m)	Table Angle (Degree)	Raw Value (dBuV)	Correction Factor (dB/m)
1	44.84	33.00 QP	40.00	-7.00	1.36 V	149	40.34	-7.34
2	68.31	31.05 QP	40.00	-8.95	1.55 V	63	39.99	-8.94
3	114.92	25.43 QP	43.50	-18.07	1.18 V	17	35.15	-9.72
4	342.34	29.53 QP	46.00	-16.47	1.90 V	226	32.96	-3.43
5	494.05	28.27 QP	46.00	-17.73	2.12 V	171	28.41	-0.14
6	628.20	30.53 QP	46.00	-15.47	1.83 V	3	27.60	2.93

Remarks:

1. Emission Level(dBuV/m) = Raw Value(dBuV) + Correction Factor(dB/m)
2. Correction Factor(dB/m) = Antenna Factor(dB/m) + Cable Factor(dB) – Pre-Amplifier Factor(dB)
3. Margin value = Emission Level – Limit value
4. The other emission levels were very low against the limit of frequency range 30MHz~1000MHz.
5. The emission levels were very low against the limit of frequency range 9kHz~30MHz: the amplitude of spurious emissions attenuated more than 20 dB below the permissible value to be report.

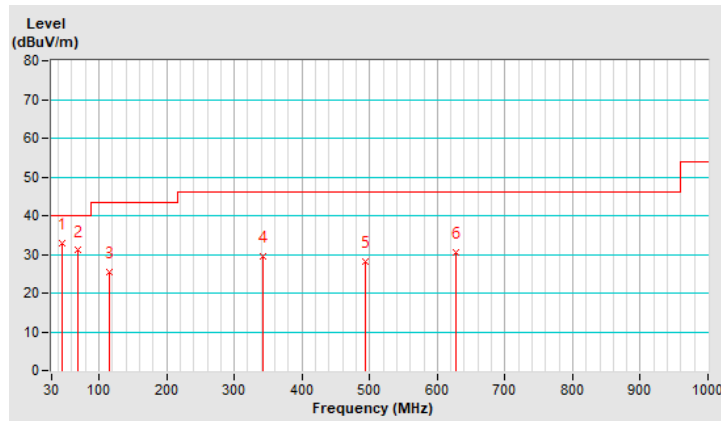

Mode 2

802.11ax (40MHz): CH 159 + BT EDR (GFSK): CH 78

Frequency Range	9kHz ~ 1GHz	Detector Function	Quasi-Peak (QP)
-----------------	-------------	-------------------	-----------------

Antenna Polarity & Test Distance : Horizontal at 3 m								
No	Frequency (MHz)	Emission Level (dBuV/m)	Limit (dBuV/m)	Margin (dB)	Antenna Height (m)	Table Angle (Degree)	Raw Value (dBuV)	Correction Factor (dB/m)
1	50.85	26.34 QP	40.00	-13.66	1.43 H	340	33.59	-7.25
2	169.29	26.60 QP	43.50	-16.90	1.91 H	76	33.28	-6.68
3	229.77	26.38 QP	46.00	-19.62	1.80 H	242	35.07	-8.69
4	344.81	27.15 QP	46.00	-18.85	1.45 H	227	30.63	-3.48
5	499.96	27.92 QP	46.00	-18.08	2.06 H	311	27.99	-0.07
6	648.76	31.91 QP	46.00	-14.09	1.78 H	234	28.88	3.03

Remarks:

1. Emission Level(dBuV/m) = Raw Value(dBuV) + Correction Factor(dB/m)
2. Correction Factor(dB/m) = Antenna Factor(dB/m) + Cable Factor(dB) – Pre-Amplifier Factor(dB)
3. Margin value = Emission Level – Limit value
4. The other emission levels were very low against the limit of frequency range 30MHz~1000MHz.
5. The emission levels were very low against the limit of frequency range 9kHz~30MHz: the amplitude of spurious emissions attenuated more than 20 dB below the permissible value to be report.

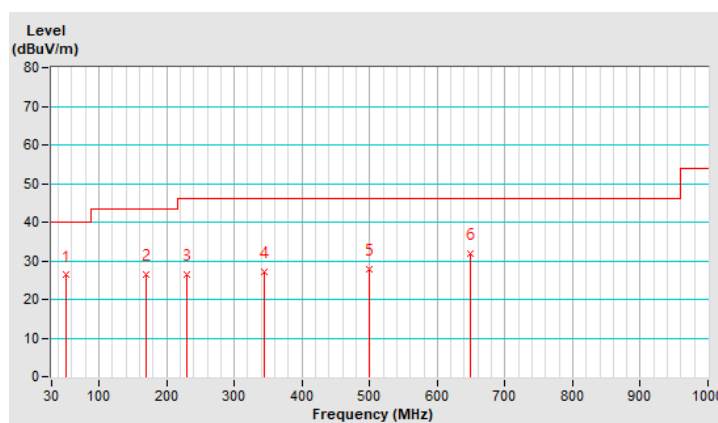

Frequency Range	9kHz ~ 1GHz	Detector Function	Quasi-Peak (QP)
-----------------	-------------	-------------------	-----------------

Antenna Polarity & Test Distance : Vertical at 3 m								
No	Frequency (MHz)	Emission Level (dBuV/m)	Limit (dBuV/m)	Margin (dB)	Antenna Height (m)	Table Angle (Degree)	Raw Value (dBuV)	Correction Factor (dB/m)
1	44.80	32.62 QP	40.00	-7.38	1.56 V	288	39.97	-7.35
2	55.46	31.15 QP	40.00	-8.85	1.72 V	360	38.52	-7.37
3	114.05	24.84 QP	43.50	-18.66	1.07 V	182	34.60	-9.76
4	167.30	23.42 QP	43.50	-20.08	1.53 V	291	30.03	-6.61
5	343.50	29.44 QP	46.00	-16.56	2.17 V	196	32.89	-3.45
6	612.68	30.50 QP	46.00	-15.50	1.61 V	271	27.95	2.55

Remarks:

1. Emission Level(dBuV/m) = Raw Value(dBuV) + Correction Factor(dB/m)
2. Correction Factor(dB/m) = Antenna Factor(dB/m) + Cable Factor(dB) – Pre-Amplifier Factor(dB)
3. Margin value = Emission Level – Limit value
4. The other emission levels were very low against the limit of frequency range 30MHz~1000MHz.
5. The emission levels were very low against the limit of frequency range 9kHz~30MHz: the amplitude of spurious emissions attenuated more than 20 dB below the permissible value to be report.

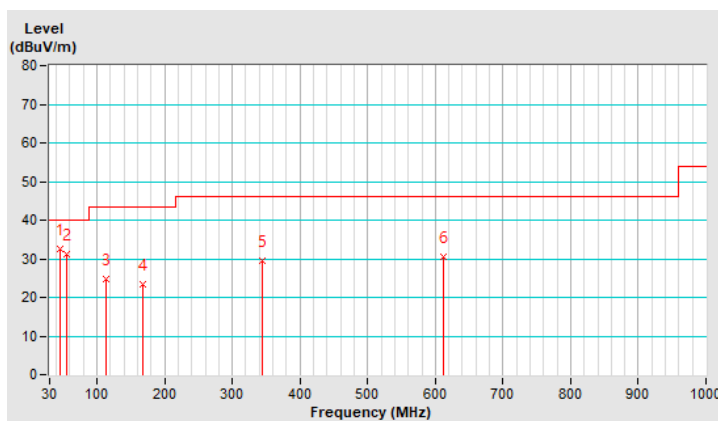

5 Pictures of Test Arrangements

Please refer to the attached file (Test Setup Photo).

Appendix – Information of the Testing Laboratories

We, Bureau Veritas Consumer Products Services (H.K.) Ltd., Taoyuan Branch, were founded in 1988 to provide our best service in EMC, Radio, Telecom and Safety consultation. Our laboratories are accredited and approved according to ISO/IEC 17025.

If you have any comments, please feel free to contact us at the following:

Lin Kou EMC/RF Lab

Tel: 886-2-26052180

Fax: 886-2-26051924

Hsin Chu EMC/RF/Telecom Lab

Tel: 886-3-6668565

Fax: 886-3-6668323

Hwa Ya EMC/RF/Safety Lab

Tel: 886-3-3183232

Fax: 886-3-3270892

Email: service.adt@tw.bureauveritas.com

Web Site: www.bureauveritas-adt.com

The address and road map of all our labs can be found in our web site also.

--- END ---