

## FCC Test Report (Co-Located)

**Report No.:** RF181129D01-4

**FCC ID:** P27-SRE4105T

**Test Model:** SRE4105T-B41

**Series Model:** SRE4105Txxxxxx  
(1st x should be "blank" or "-", the rest x should be 0 to 9, A to Z, a to z, "blank" or "-", for marketing purpose.)

**Received Date:** Nov. 29, 2018

**Test Date:** Jan. 22, 2019

**Issued Date:** Jan. 23 2019

**Applicant:** Sercomm Corp.

**Address:** 8F, No. 3-1, YuanQu St., NanKang, Taipei 115, Taiwan, R.O.C. (NanKang Software Park)

**Issued By:** Bureau Veritas Consumer Products Services (H.K.) Ltd., Taoyuan Branch

**Lab Address:** No. 47-2, 14th Ling, Chia Pau Vil., Lin Kou Dist., New Taipei City, Taiwan (R.O.C.)

**FCC Registration /  
Designation Number:** 198487 / TW2021



This report is for your exclusive use. Any copying or replication of this report to or for any other person or entity, or use of our name or trademark, is permitted only with our prior written permission. This report sets forth our findings solely with respect to the test samples identified herein. The results set forth in this report are not indicative or representative of the quality or characteristics of the lot from which a test sample was taken or any similar or identical product specifically and expressly noted. Our report includes all of the tests requested by you and the results thereof based upon the information that you provided to us. You have 60 days from date of issuance of this report to notify us of any material error or omission caused by our negligence, provided, however, that such notice shall be in writing and shall specifically address the issue you wish to raise. A failure to raise such issue within the prescribed time shall constitute your unqualified acceptance of the completeness of this report, the tests conducted and the correctness of the report contents. Unless specific mention, the uncertainty of measurement has been explicitly taken into account to declare the compliance or non-compliance to the specification. The report must not be used by the client to claim product certification, approval, or endorsement by TAF or any government agencies.

## Table of Contents

<b>Release Control Record</b> .....	<b>3</b>
<b>1 Certificate of Conformity</b> .....	<b>4</b>
<b>2 Summary of Test Results</b> .....	<b>5</b>
2.1 Measurement Uncertainty.....	5
2.2 Modification Record.....	5
<b>3 General Information</b> .....	<b>6</b>
3.1 General Description of EUT.....	6
3.2 Test Mode Applicability and Tested Channel Detail.....	8
3.3 Description of Support Units.....	9
3.3.1 Configuration of System under Test.....	9
3.4 General Description of Applied Standard.....	10
<b>4 Test Types and Results</b> .....	<b>11</b>
4.1 Radiated Emission and Bandedge Measurement.....	11
4.1.1 Limits of Radiated Emission and Bandedge Measurement.....	11
4.1.2 Test Instruments.....	12
4.1.3 Test Procedure.....	13
4.1.4 Deviation from Test Standard.....	13
4.1.5 Test Setup.....	14
4.1.6 EUT Operating Condition.....	15
4.1.7 Test Results.....	16
<b>5 Pictures of Test Arrangements</b> .....	<b>22</b>
<b>Appendix – Information of the Testing Laboratories</b> .....	<b>23</b>

### Release Control Record

Issue No.	Description	Date Issued
RF181129D01-4	Original release.	Jan. 23 2019

## 1 Certificate of Conformity

**Product:** SOHO Magic Box

**Brand:** Sprint

**Test Model:** SRE4105T-B41

**Series Model:** SRE4105Txxxxxx  
(1st x should be "blank" or "-", the rest x should be 0 to 9, A to Z, a to z, "blank" or "-", for marketing purpose.)

**Sample Status:** Engineering sample

**Applicant:** Sercomm Corp.

**Test Date:** Jan. 22, 2019

**Standard:** 47 CFR FCC Part 15, Subpart C (Section 15.247)  
FCC Part 27, Subpart C, M  
FCC Part 24, Subpart E  
ANSI C63.10: 2013

The above equipment has been tested by **Bureau Veritas Consumer Products Services (H.K.) Ltd., Taoyuan Branch**, and found compliance with the requirement of the above standards. The test record, data evaluation & Equipment Under Test (EUT) configurations represented herein are true and accurate accounts of the measurements of the sample's RF characteristics under the conditions specified in this report.

**Prepared by :** Annie Chang, **Date:** Jan. 23 2019  
Annie Chang / Senior Specialist

**Approved by :** Rex Lai, **Date:** Jan. 23 2019  
Rex Lai / Associate Technical Manager

## 2 Summary of Test Results

47 CFR FCC Part 15, Subpart C (Section 15.247), FCC Part 27, Subpart C, M, FCC Part 24, Subpart E			
FCC Clause	Test Item	Result	Remarks
15.205 15.209 15.247(d) 2.1053 27.53(m)(4)(6) 24.238	Radiated Emissions Measurement	Pass	Meet the requirement of limit. Minimum passing margin is -1.13dB at 4804.00MHz.

Note: Determining compliance based on the results of the compliance measurement, not taking into account measurement instrumentation uncertainty.

### 2.1 Measurement Uncertainty

Where relevant, the following measurement uncertainty levels have been estimated for tests performed on the EUT as specified in CISPR 16-4-2:

Measurement	Frequency	Expanded Uncertainty (k=2) ( $\pm$ )
Radiated Emissions up to 1 GHz	9kHz ~ 30MHz	2.38 dB
	30MHz ~ 1000MHz	5.54 dB
Radiated Emissions above 1 GHz	Above 1GHz	5.48 dB

### 2.2 Modification Record

There were no modifications required for compliance.

### 3 General Information

#### 3.1 General Description of EUT

Product	SOHO Magic Box	
Brand	Sprint	
Test Model	SRE4105T-B41	
Series Model	SRE4105Txxxxxxx (1st x should be "blank" or "-", the rest x should be 0 to 9, A to Z, a to z, "blank" or "-", for marketing purpose.)	
Model Difference	For marketing purpose	
Status of EUT	Engineering sample	
Power Supply Rating	12Vdc from adapter	
Modulation Type	BT LE	GFSK
	LTE	QPSK, 16QAM, 64QAM
Transfer Rate	BT LE	Up to 1Mbps
Operating Frequency	BT LE	2402MHz ~2480MHz
Frequency Range	LTE Band 25	Channel Bandwidth 5MHz: 1852.5~1912.5MHz Channel Bandwidth 10MHz: 1855~1910MHz
	LTE Band 41 (CPE)	Channel Bandwidth 5MHz: 2502.5~2567.5MHz, 2622.5~2687.5MHz Channel Bandwidth 10MHz: 2505.0~2565.0MHz, 2625.0~2685.0MHz Channel Bandwidth 15MHz: 2507.5~2562.5MHz, 2627.5~2682.5MHz Channel Bandwidth 20MHz: 2510.0~2560.0MHz, 2630.0~2680.0MHz
	LTE Band 41 (BTS)	Channel Bandwidth 20MHz: 2510~2560MHz, 2630~2680MHz
Number of Channel	BT LE	40
Output Power	BT LE	1.371mW
Max. EIRP Power	LTE Band 25	Channel Bandwidth 5MHz: 901.571mW (29.55dBm) Channel Bandwidth 10MHz: 937.562mW (29.72Bm)
	LTE Band 41 (CPE)	Channel Bandwidth: 5MHz: 2123.245mW (33.27dBm) Channel Bandwidth: 10MHz: 3655.948mW (35.63dBm) Channel Bandwidth: 15MHz: 3639.150mW (35.61dBm) Channel Bandwidth: 20MHz: 3647.539mW (35.62dBm)
	LTE Band 41 (BTS)	Channel Bandwidth 20MHz: 2510~2560MHz: 1798.871mW (32.55dBm), 2630~2680MHz: 1782.379mW (32.51dBm)

Antenna Type	BT LE	Ant. 11: Dipole antenna with 2.87dBi gain
	LTE Band 25	Ant. 2: Dipole antenna with 5.16dBi gain Ant. 8: Dipole antenna with 5.69dBi gain
	LTE Band 41 (CPE)	Ant. 2: Dipole antenna with 4.87dBi gain Ant. 1: Dipole antenna with 4.89dBi gain Ant. 6: Dipole antenna with 5.52dBi gain Ant. 5: Dipole antenna with 5.45dBi gain
	LTE Band 41 (BTS)	Ant. 9: Dipole antenna with 6.03dBi gain Ant. 10: Dipole antenna with 6.01dBi gain
Antenna Connector	I-PEX	
Accessory Device	Refer to user's manual	
Data Cable Supplied	N/A	

Note:

1. The EUT uses following adapter.

Brand	APD
Model	WA-30P12FU
AC Input Power	100-240V, 50-60Hz, 0.9A
DC Output Power	12V, 2.5A
Power Line	Non-shielded DC cable (2.0m)

2. The TX function of antennas is as follows:

Antenna port		TX Function	
Ant. 2	Ant. 1	MIMO	CDD
Ant. 6	Ant. 5	MIMO	

3. BTS Band 41 low band and CPE Band 41 low band cannot transmit at same time.  
 BTS Band 41 high band and CPE Band 41 high band cannot transmit at same time.  
 CPE Band 25 and CPE Band 41 cannot transmit at same time.

4. The above EUT information is declared by manufacturer and for more detailed features description, please refer to the manufacturer's specifications or user's manual.

### 3.2 Test Mode Applicability and Tested Channel Detail

EUT Configure Mode	Applicable To		Description
	RE $\geq$ 1G	RE<1G	
-	√	√	-

Where **RE $\geq$ 1G**: Radiated Emission above 1GHz **RE<1G**: Radiated Emission below 1GHz

#### Radiated Emission Test (Above 1GHz):

- Pre-Scan has been conducted to determine the worst-case mode from all possible combinations between available modulations, data rates and antenna ports (if EUT with antenna diversity architecture).
- Following channel(s) was (were) selected for the final test as listed below.

EUT Configure Mode	Mode
-	BTS Band 41 (Low) + CPE Band 25 +Bluetooth LE
-	BTS Band 41 (Low) + CPE Band 41 (High) +Bluetooth LE

#### Radiated Emission Test (Below 1GHz):

- Pre-Scan has been conducted to determine the worst-case mode from all possible combinations between available modulations, data rates and antenna ports (if EUT with antenna diversity architecture).
- Following channel(s) was (were) selected for the final test as listed below.

EUT Configure Mode	Mode
-	BTS Band 41 (Low) + CPE Band 25 +Bluetooth LE
-	BTS Band 41 (Low) + CPE Band 41 (High) +Bluetooth LE

#### Test Condition:

Applicable To	Environmental Conditions	Input Power	Tested By
<b>RE<math>\geq</math>1G</b>	27deg. C, 75%RH	120Vac, 60Hz	Ian Chang
<b>RE&lt;1G</b>	29deg. C, 75%RH	120Vac, 60Hz	Ian Chang



### 3.3 Description of Support Units

The EUT has been tested as an independent unit together with other necessary accessories or support units. The following support units or accessories were used to form a representative test configuration during the tests.

ID	Descriptions	Qty.	Length (m)	Shielding (Yes/No)	Cores (Qty.)	Remarks
1.	DC cable	1	2.0	N	0	Supplied by client

Note: The core(s) is(are) originally attached to the cable(s).

#### 3.3.1 Configuration of System under Test

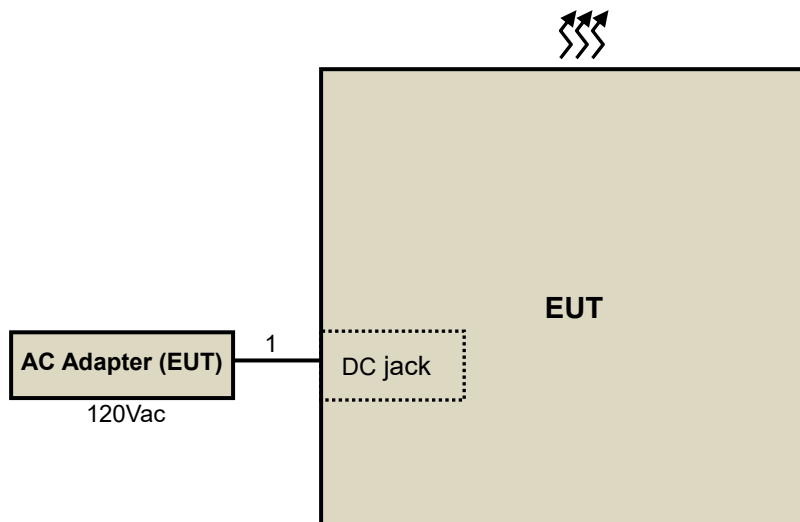

### 3.4 General Description of Applied Standard

The EUT is a RF Product. According to the specifications of the manufacturer, it must comply with the requirements of the following standards:

**FCC Part 15, Subpart C (15.247)**  
**KDB 558074 D01 15.247 Meas Guidance v05**  
**ANSI C63.10-2013**

**FCC 47 CFR Part 2**  
**FCC 47 CFR Part 24**  
**KDB 971168 D01 Power Meas License Digital Systems v03r01**  
**ANSI/TIA/EIA-603-E 2016**  
**ANSI 63.26-2015**

**FCC 47 CFR Part 2**  
**FCC 47 CFR Part 27**  
**KDB 971168 D01 Power Meas License Digital Systems v03r01**  
**ANSI/TIA/EIA-603-E 2016**  
**ANSI 63.26-2015**

All test items have been performed and recorded as per the above standards.

## 4 Test Types and Results

### 4.1 Radiated Emission and Bandedge Measurement

#### 4.1.1 Limits of Radiated Emission and Bandedge Measurement

Radiated emissions which fall in the restricted bands must comply with the radiated emission limits specified as below table.

Frequencies (MHz)	Field Strength (microvolts/meter)	Measurement Distance (meters)
0.009 ~ 0.490	2400/F(kHz)	300
0.490 ~ 1.705	24000/F(kHz)	30
1.705 ~ 30.0	30	30
30 ~ 88	100	3
88 ~ 216	150	3
216 ~ 960	200	3
Above 960	500	3

**NOTE:**

1. The lower limit shall apply at the transition frequencies.
2. Emission level (dBuV/m) = 20 log Emission level (uV/m).
3. For frequencies above 1000MHz, the field strength limits are based on average detector, however, the peak field strength of any emission shall not exceed the maximum permitted average limits, specified above by more than 20dB under any condition of modulation.

## 4.1.2 Test Instruments

DESCRIPTION & MANUFACTURER	MODEL NO.	SERIAL NO.	CALIBRATED DATE	CALIBRATED UNTIL
HP Preamplifier	8447D	2432A03504	Feb. 21, 2018	Feb. 20, 2019
HP Preamplifier	8449B	3008A01201	Feb. 22, 2018	Feb. 21, 2019
MITEQ Preamplifier	AMF-6F-260400-33-8P	892164	Feb. 21, 2018	Feb. 20, 2019
Agilent TEST RECEIVER	N9038A	MY51210129	Feb. 6, 2018	Feb. 5, 2019
Schwarzbeck Antenna	VULB 9168	139	Nov. 26, 2018	Nov. 25, 2019
Schwarzbeck Antenna	VHBA 9123	480	May 19, 2017	May 18, 2019
Schwarzbeck Horn Antenna	BBHA-9170	212	Nov. 25, 2018	Nov. 24, 2019
Schwarzbeck Horn Antenna	BBHA 9120-D1	D130	Nov. 25, 2018	Nov. 24, 2019
ADT. Turn Table	TT100	0306	NA	NA
ADT. Tower	AT100	0306	NA	NA
Software	Radiated_V7.6.15.9.5	NA	NA	NA
SUHNER RF cable With 4dB PAD	SF102	Cable-CH6-01	Aug. 13, 2018	Aug. 12, 2019
SUHNER RF cable With 3/4dB PAD	SF102	Cable-CH8-3.6m	Aug. 13, 2018	Aug. 12, 2019
KEYSIGHT MIMO Powermeasurement Test set	U2021XA	U2021XA-001	Jun. 4, 2018	Jun. 3, 2019
KEYSIGHT Spectrum Analyzer	N9030A	MY54490260	Aug. 3, 2018	Aug. 2, 2019
Loop Antenna EMCI	LPA600	270	Aug. 11, 2017	Aug. 10, 2019
EMCO Horn Antenna	3115	00028257	Nov. 25, 2018	Nov. 24, 2019
Highpass filter Wainwright Instruments	WHK 3.1/18G-10SS	SN 8	NA	NA
ROHDE & SCHWARZ Spectrum Analyzer	FSV40	101042	Sep. 27, 2018	Sep. 26, 2019
Anritsu Power Sensor	MA2411B	0738404	Apr. 26, 2018	Apr. 25, 2019
Anritsu Power Meter	ML2495A	0842014	Apr. 26, 2018	Apr. 25, 2019

- NOTE:**
1. The calibration interval of the above test instruments is 12/24 months. And the calibrations are traceable to NML/ROC and NIST/USA.
  2. The horn antenna and HP preamplifier (model: 8449B) are used only for the measurement of emission frequency above 1GHz if tested.
  3. The test was performed in Chamber No. 6.
  4. The Industry Canada Reference No. IC 7450E-6.

#### 4.1.3 Test Procedure

##### **For Radiated emission below 30MHz**

- a. The EUT was placed on the top of a rotating table 0.8 meters above the ground at a 3 meter chamber room. The table was rotated 360 degrees to determine the position of the highest radiation.
- b. The EUT was set 3 meters away from the interference-receiving antenna, which was mounted on the top of a variable-height antenna tower.
- c. Parallel, Perpendicular and Ground-parallel of the antenna are set to make the measurement.
- d. For each suspected emission, the EUT was arranged to its worst case and the rotatable table was turned from 0 degrees to 360 degrees to find the maximum reading.
- e. The test-receiver system was set to Quasi-Peak Detect Function and Specified Bandwidth with Maximum Hold Mode.

##### **NOTE:**

1. The resolution bandwidth and video bandwidth of test receiver/spectrum analyzer is 9kHz at frequency below 30MHz.

##### **For Radiated emission above 30MHz**

- a. The EUT was placed on the top of a rotating table 0.8 meters (for 30MHz ~ 1GHz) / 1.5 meters (for above 1GHz) above the ground at 3 meter chamber room for test. The table was rotated 360 degrees to determine the position of the highest radiation.
- b. The EUT was set 3 meters away from the interference-receiving antenna, which was mounted on the top of a variable-height antenna tower.
- c. The height of antenna is varied from one meter to four meters above the ground to determine the maximum value of the field strength. Both horizontal and vertical polarizations of the antenna are set to make the measurement.
- d. For each suspected emission, the EUT was arranged to its worst case and then the antenna was tuned to heights from 1 meter to 4 meters and the rotatable table was turned from 0 degrees to 360 degrees to find the maximum reading.
- e. The test-receiver system was set to quasi-peak detect function and specified bandwidth with maximum hold mode when the test frequency is below 1 GHz.
- f. The test-receiver system was set to peak and average detect function and specified bandwidth with maximum hold mode when the test frequency is above 1 GHz. If the peak reading value also meets average limit, measurement with the average detector is unnecessary.

##### **Note:**

1. The resolution bandwidth and video bandwidth of test receiver/spectrum analyzer is 120kHz for Quasi-peak detection (QP) at frequency below 1GHz.
2. The resolution bandwidth of test receiver/spectrum analyzer is 1 MHz and the video bandwidth is 3 MHz for Peak detection (PK) at frequency above 1GHz.
3. The resolution bandwidth of test receiver/spectrum analyzer is 1MHz and the video bandwidth is  $\geq 1/T$  (Duty cycle < 98%) or 10Hz (Duty cycle  $\geq 98\%$ ) for Average detection (AV) at frequency above 1GHz.
4. All modes of operation were investigated and the worst-case emissions are reported.

#### 4.1.4 Deviation from Test Standard

No deviation.

#### 4.1.5 Test Setup

##### For Radiated emission below 30MHz

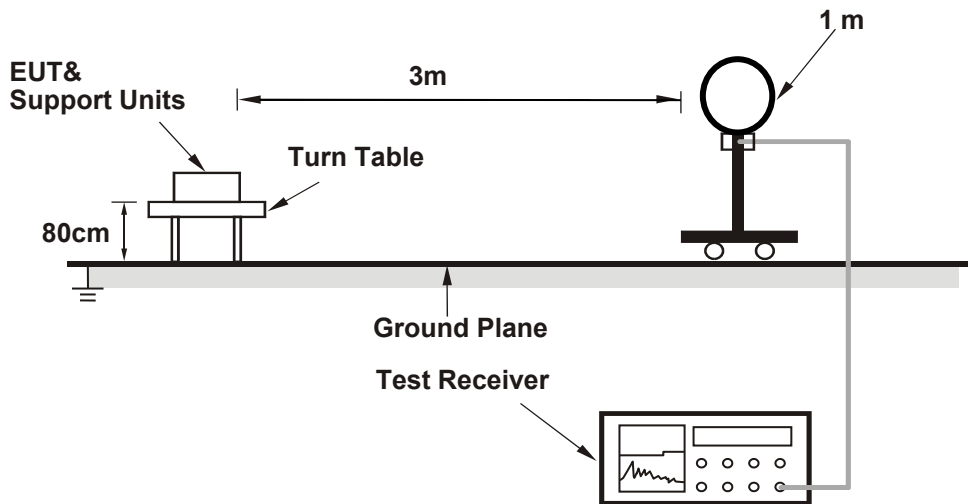

##### For Radiated emission 30MHz to 1GHz

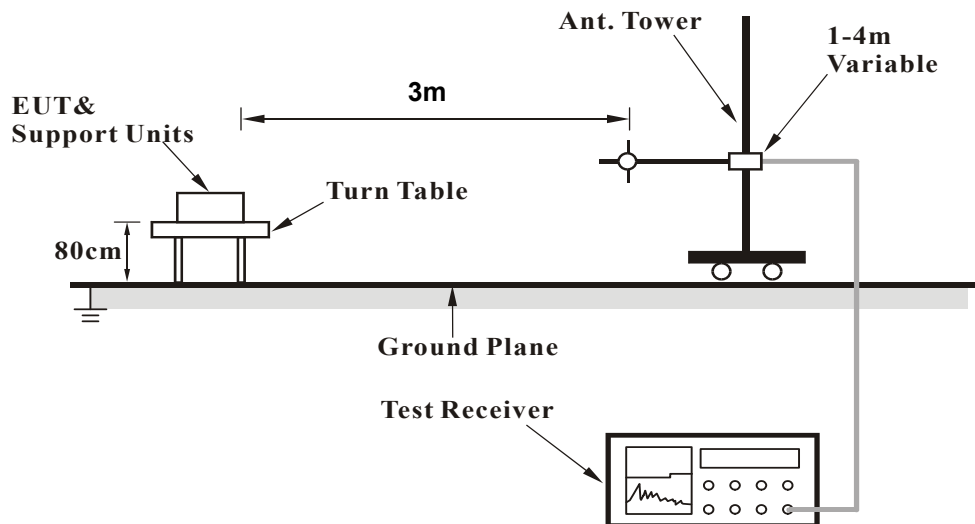

### For Radiated emission above 1GHz

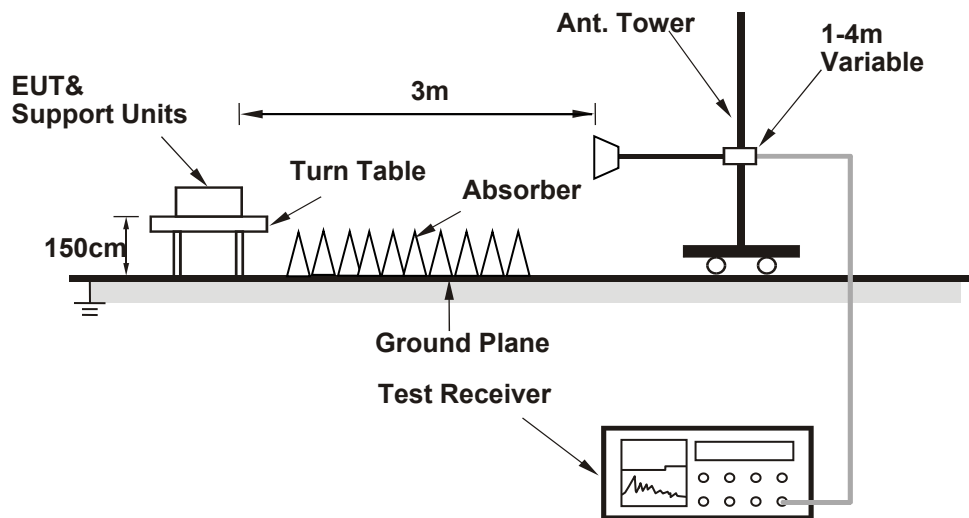

For the actual test configuration, please refer to the attached file (Test Setup Photo).

#### 4.1.6 EUT Operating Condition

Set the EUT under transmission condition continuously at specific channel frequency continuously.

#### 4.1.7 Test Results

#### ABOVE 1GHz DATA

#### BTS Band 41 (Low) + CPE Band 25 +Bluetooth LE

<b>Frequency Range</b>	1GHz ~ 40GHz	<b>Detector Function</b>	Peak (PK) Average (AV)
------------------------	--------------	--------------------------	---------------------------

#### ANTENNA POLARITY & TEST DISTANCE: HORIZONTAL AT 3 M

NO.	FREQ. (MHz)	EMISSION LEVEL (dBuV/m)	LIMIT (dBuV/m)	MARGIN (dB)	ANTENNA HEIGHT (m)	TABLE ANGLE (Degree)	RAW VALUE (dBuV)	CORRECTION FACTOR (dB/m)
1	2390.00	54.53 PK	74.00	-19.47	2.29 H	241	55.68	-1.15
2	2390.00	39.86 AV	54.00	-14.14	2.29 H	241	41.01	-1.15
3	3820.00	47.12 PK	70.20	-23.08	2.04 H	154	43.72	3.40
4	3820.00	36.36 AV	54.00	-17.64	2.04 H	154	32.96	3.40
5	4804.00	57.24 PK	74.00	-16.76	1.61 H	130	51.90	5.34
6	4804.00	52.68 AV	54.00	-1.32	1.61 H	130	47.34	5.34
7	5010.00	55.42 PK	70.20	-14.78	1.24 H	341	50.25	5.17
8	5010.00	51.82 AV	54.00	-2.18	1.24 H	341	46.65	5.17

#### ANTENNA POLARITY & TEST DISTANCE: VERTICAL AT 3 M

NO.	FREQ. (MHz)	EMISSION LEVEL (dBuV/m)	LIMIT (dBuV/m)	MARGIN (dB)	ANTENNA HEIGHT (m)	TABLE ANGLE (Degree)	RAW VALUE (dBuV)	CORRECTION FACTOR (dB/m)
1	2390.00	59.68 PK	74.00	-14.32	1.47 V	215	60.83	-1.15
2	2390.00	40.85 AV	54.00	-13.15	1.47 V	215	42.00	-1.15
3	3820.00	45.36 PK	70.20	-24.84	1.84 V	138	41.96	3.40
4	3820.00	32.59 AV	54.00	-21.41	1.84 V	138	29.19	3.40
5	4804.00	47.88 PK	74.00	-26.12	1.60 V	41	42.54	5.34
6	4804.00	38.76 AV	54.00	-15.24	1.60 V	41	33.42	5.34
7	5010.00	53.68 PK	70.20	-16.52	2.44 V	142	48.51	5.17
8	5010.00	50.94 AV	54.00	-3.06	2.44 V	142	45.77	5.17

#### REMARKS:

1. Emission Level(dBuV/m) = Raw Value(dBuV) + Correction Factor(dB/m)
2. Correction Factor(dB/m) = Antenna Factor(dB/m) + Cable Factor(dB) – Pre-Amplifier Factor(dB)
3. The other emission levels were very low against the limit.
4. Margin value = Emission Level – Limit value



**BTS Band 41 (Low) + CPE Band 41 (High) +Bluetooth LE**

<b>Frequency Range</b>	1GHz ~ 40GHz	<b>Detector Function</b>	Peak (PK) Average (AV)
------------------------	--------------	--------------------------	---------------------------

**ANTENNA POLARITY & TEST DISTANCE: HORIZONTAL AT 3 M**

NO.	FREQ. (MHz)	EMISSION LEVEL (dBuV/m)	LIMIT (dBuV/m)	MARGIN (dB)	ANTENNA HEIGHT (m)	TABLE ANGLE (Degree)	RAW VALUE (dBuV)	CORRECTION FACTOR (dB/m)
1	2390.00	54.68 PK	74.00	-19.32	2.34 H	252	55.83	-1.15
2	2390.00	40.03 AV	54.00	-13.97	2.34 H	252	41.18	-1.15
3	4804.00	57.55 PK	74.00	-16.45	1.57 H	124	52.21	5.34
<b>4</b>	<b>4804.00</b>	<b>52.87 AV</b>	<b>54.00</b>	<b>-1.13</b>	<b>1.57 H</b>	<b>124</b>	<b>47.53</b>	<b>5.34</b>
5	5010.00	55.64 PK	70.20	-14.56	1.34 H	352	50.47	5.17
<b>6</b>	5010.00	51.94 AV	54.00	-2.06	1.34 H	352	46.77	5.17
7	#5250.00	46.15 PK	70.20	-24.05	2.34 H	164	41.52	4.63
8	#5250.00	35.75 AV	54.00	-18.25	2.34 H	164	31.12	4.63

**ANTENNA POLARITY & TEST DISTANCE: VERTICAL AT 3 M**

NO.	FREQ. (MHz)	EMISSION LEVEL (dBuV/m)	LIMIT (dBuV/m)	MARGIN (dB)	ANTENNA HEIGHT (m)	TABLE ANGLE (Degree)	RAW VALUE (dBuV)	CORRECTION FACTOR (dB/m)
1	2390.00	60.34 PK	74.00	-13.66	1.42 V	206	61.49	-1.15
2	2390.00	41.03 AV	54.00	-12.97	1.42 V	206	42.18	-1.15
3	4804.00	48.76 PK	74.00	-25.24	1.58 V	29	43.42	5.34
4	4804.00	39.33 AV	54.00	-14.67	1.58 V	29	33.99	5.34
5	5010.00	53.89 PK	70.20	-16.31	2.47 V	154	48.72	5.17
6	5010.00	51.22 AV	54.00	-2.78	2.47 V	154	46.05	5.17
7	#5250.00	44.75 PK	70.20	-25.45	1.66 V	128	40.12	4.63
8	#5250.00	31.43 AV	54.00	-22.57	1.66 V	128	26.80	4.63

**REMARKS:**

1. Emission Level(dBuV/m) = Raw Value(dBuV) + Correction Factor(dB/m)
2. Correction Factor(dB/m) = Antenna Factor(dB/m) + Cable Factor(dB) – Pre-Amplifier Factor(dB)
3. The other emission levels were very low against the limit.
4. Margin value = Emission Level – Limit value
5. "#": The radiated frequency is out of the restricted band.

## BELOW 1GHz WORST-CASE DATA

### BTS Band 41 (Low) + CPE Band 25 +Bluetooth LE

Frequency Range	9kHz ~ 1GHz	Detector Function	Quasi-Peak (QP)
-----------------	-------------	-------------------	-----------------

ANTENNA POLARITY & TEST DISTANCE: HORIZONTAL AT 3 M								
NO.	FREQ. (MHz)	EMISSION LEVEL (dBuV/m)	LIMIT (dBuV/m)	MARGIN (dB)	ANTENNA HEIGHT (m)	TABLE ANGLE (Degree)	RAW VALUE (dBuV)	CORRECTION FACTOR (dB/m)
1	45.03	19.48 QP	40.00	-20.52	2.10 H	147	26.97	-7.49
2	105.95	18.03 QP	43.50	-25.47	2.09 H	291	28.77	-10.74
3	174.17	26.39 QP	43.50	-17.11	1.88 H	266	34.09	-7.70
4	231.03	24.93 QP	46.00	-21.07	2.37 H	312	33.45	-8.52
5	467.08	23.10 QP	46.00	-22.90	1.52 H	166	25.07	-1.97
6	702.02	26.35 QP	46.00	-19.65	1.32 H	67	23.96	2.39

#### REMARKS:

1. Emission Level(dBuV/m) = Raw Value(dBuV) + Correction Factor(dB/m)
2. Correction Factor(dB/m) = Antenna Factor(dB/m) + Cable Factor(dB) – Pre-Amplifier Factor(dB)
3. The other emission levels were very low against the limit.
4. Margin value = Emission Level – Limit value
5. The emission levels were very low against the limit of frequency range 9kHz ~ 30MHz :the amplitude of spurious emissions attenuated more than 20 dB below the permissible value to be report.

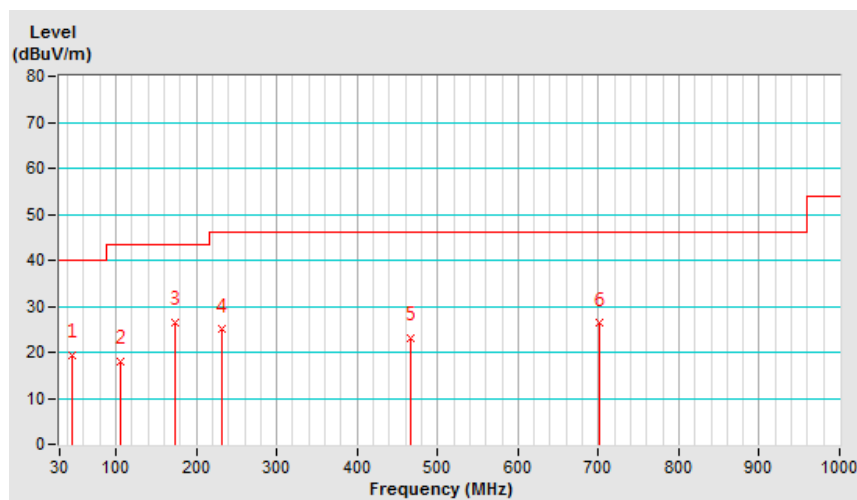

<b>Frequency Range</b>	9kHz ~ 1GHz	<b>Detector Function</b>	Quasi-Peak (QP)
------------------------	-------------	--------------------------	-----------------

**ANTENNA POLARITY & TEST DISTANCE: VERTICAL AT 3 M**

NO.	FREQ. (MHz)	EMISSION LEVEL (dBuV/m)	LIMIT (dBuV/m)	MARGIN (dB)	ANTENNA HEIGHT (m)	TABLE ANGLE (Degree)	RAW VALUE (dBuV)	CORRECTION FACTOR (dB/m)
1	30.24	25.63 QP	40.00	-14.37	1.52 V	183	34.70	-9.07
2	98.53	23.05 QP	43.50	-20.45	1.62 V	300	34.83	-11.78
3	157.07	29.15 QP	43.50	-14.35	1.45 V	191	36.07	-6.92
4	212.31	26.34 QP	43.50	-17.16	2.18 V	307	35.33	-8.99
5	484.78	23.79 QP	46.00	-22.21	2.31 V	274	25.39	-1.60
6	648.42	25.69 QP	46.00	-20.31	1.74 V	136	24.01	1.68

**REMARKS:**

1. Emission Level(dBuV/m) = Raw Value(dBuV) + Correction Factor(dB/m)
2. Correction Factor(dB/m) = Antenna Factor(dB/m) + Cable Factor(dB) – Pre-Amplifier Factor(dB)
3. The other emission levels were very low against the limit.
4. Margin value = Emission Level – Limit value
5. The emission levels were very low against the limit of frequency range 9kHz ~ 30MHz :the amplitude of spurious emissions attenuated more than 20 dB below the permissible value to be report.

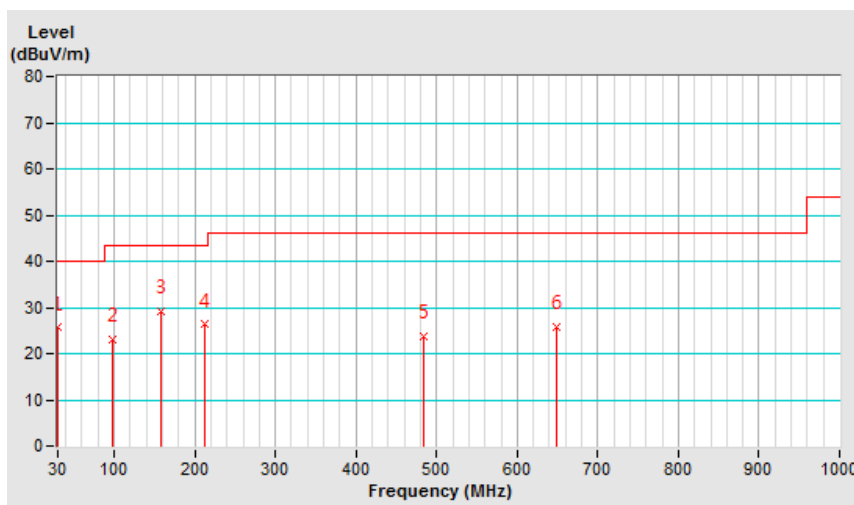

### BTS Band 41 (Low) + CPE Band 41 (High) +Bluetooth LE

Frequency Range	9kHz ~ 1GHz	Detector Function	Quasi-Peak (QP)
-----------------	-------------	-------------------	-----------------

#### ANTENNA POLARITY & TEST DISTANCE: HORIZONTAL AT 3 M

NO.	FREQ. (MHz)	EMISSION LEVEL (dBuV/m)	LIMIT (dBuV/m)	MARGIN (dB)	ANTENNA HEIGHT (m)	TABLE ANGLE (Degree)	RAW VALUE (dBuV)	CORRECTION FACTOR (dB/m)
1	67.88	20.12 QP	40.00	-19.88	1.34 H	224	29.02	-8.90
2	129.04	24.30 QP	43.50	-19.20	2.15 H	115	32.87	-8.57
3	174.14	25.19 QP	43.50	-18.31	2.21 H	266	32.89	-7.70
4	245.15	24.80 QP	46.00	-21.20	1.87 H	318	32.17	-7.37
5	306.16	22.01 QP	46.00	-23.99	1.69 H	305	27.10	-5.09
6	509.08	24.13 QP	46.00	-21.87	2.62 H	153	25.29	-1.16
7	676.99	26.53 QP	46.00	-19.47	1.08 H	360	24.58	1.95

#### REMARKS:

1. Emission Level(dBuV/m) = Raw Value(dBuV) + Correction Factor(dB/m)
2. Correction Factor(dB/m) = Antenna Factor(dB/m) + Cable Factor(dB) – Pre-Amplifier Factor(dB)
3. The other emission levels were very low against the limit.
4. Margin value = Emission Level – Limit value
5. The emission levels were very low against the limit of frequency range 9kHz ~ 30MHz :the amplitude of spurious emissions attenuated more than 20 dB below the permissible value to be report.

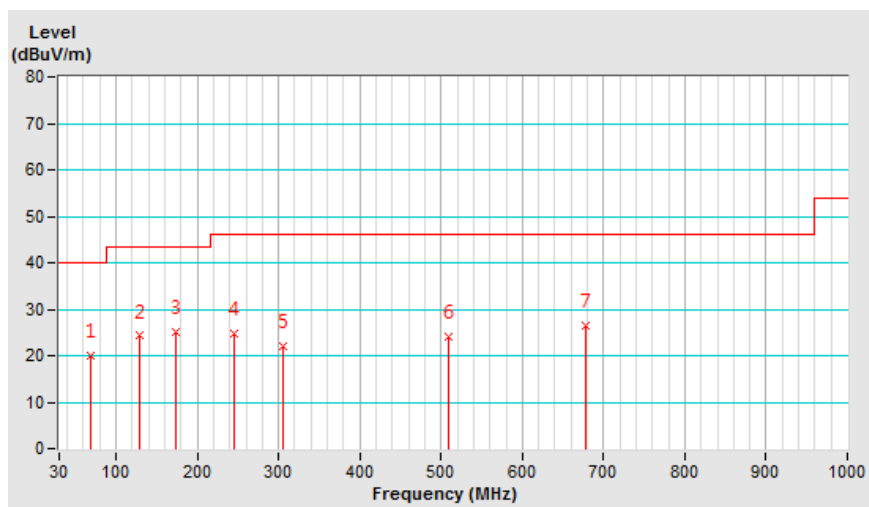

<b>Frequency Range</b>	9kHz ~ 1GHz	<b>Detector Function</b>	Quasi-Peak (QP)
------------------------	-------------	--------------------------	-----------------

**ANTENNA POLARITY & TEST DISTANCE: VERTICAL AT 3 M**

NO.	FREQ. (MHz)	EMISSION LEVEL (dBuV/m)	LIMIT (dBuV/m)	MARGIN (dB)	ANTENNA HEIGHT (m)	TABLE ANGLE (Degree)	RAW VALUE (dBuV)	CORRECTION FACTOR (dB/m)
1	30.24	25.63 QP	40.00	-14.37	1.84 V	183	34.70	-9.07
2	174.58	28.45 QP	43.50	-15.05	1.74 V	149	36.17	-7.72
3	224.49	26.55 QP	46.00	-19.45	1.53 V	144	35.47	-8.92
4	296.56	23.84 QP	46.00	-22.16	1.79 V	130	29.24	-5.40
5	546.04	25.22 QP	46.00	-20.78	1.20 V	168	25.93	-0.71
6	669.38	27.46 QP	46.00	-18.54	1.28 V	71	25.56	1.90

**REMARKS:**

1. Emission Level(dBuV/m) = Raw Value(dBuV) + Correction Factor(dB/m)
2. Correction Factor(dB/m) = Antenna Factor(dB/m) + Cable Factor(dB) – Pre-Amplifier Factor(dB)
3. The other emission levels were very low against the limit.
4. Margin value = Emission Level – Limit value
5. The emission levels were very low against the limit of frequency range 9kHz ~ 30MHz :the amplitude of spurious emissions attenuated more than 20 dB below the permissible value to be report.

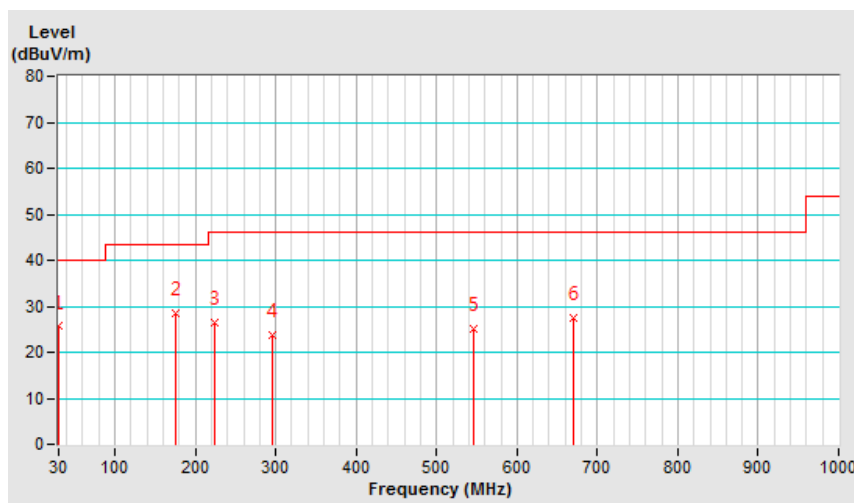

## 5 Pictures of Test Arrangements

Please refer to the attached file (Test Setup Photo).

## Appendix – Information of the Testing Laboratories

We, Bureau Veritas Consumer Products Services (H.K.) Ltd., Taoyuan Branch, were founded in 1988 to provide our best service in EMC, Radio, Telecom and Safety consultation. Our laboratories are accredited and approved according to ISO/IEC 17025.

If you have any comments, please feel free to contact us at the following:

**Lin Kou EMC/RF Lab**

Tel: 886-2-26052180

Fax: 886-2-26051924

**Hsin Chu EMC/RF/Telecom Lab**

Tel: 886-3-6668565

Fax: 886-3-6668323

**Hwa Ya EMC/RF/Safety**

Tel: 886-3-3183232

Fax: 886-3-3270892

**Email:** [service.adt@tw.bureauveritas.com](mailto:service.adt@tw.bureauveritas.com)

**Web Site:** [www.bureauveritas-adt.com](http://www.bureauveritas-adt.com)

The address and road map of all our labs can be found in our web site also.

--- END ---