

# FCC Test Report

## (PART 27: LTE Band 41\_BTS)

**Report No.:** RF180919D02-2

**FCC ID:** P27-SOR4105T

**Test Model:** SOR4105T

**Received Date:** Sep. 19, 2018

**Test Date:** Oct. 11 ~ Nov. 5, 2018

**Issued Date:** Dec. 12, 2018

**Applicant:** Sercomm Corp.

**Address:** 8F, No. 3-1, YuanQu St., NanKang, Taipei 115, Taiwan, R.O.C. (NanKang Software Park)

**Issued By:** Bureau Veritas Consumer Products Services (H.K.) Ltd., Taoyuan Branch

**Lab Address:** No. 47-2, 14th Ling, Chia Pau Vil., Lin Kou Dist., New Taipei City, Taiwan, R.O.C.

**FCC Registration /  
Designation Number:** 198487 / TW2021



This report is for your exclusive use. Any copying or replication of this report to or for any other person or entity, or use of our name or trademark, is permitted only with our prior written permission. This report sets forth our findings solely with respect to the test samples identified herein. The results set forth in this report are not indicative or representative of the quality or characteristics of the lot from which a test sample was taken or any similar or identical product unless specifically and expressly noted. Our report includes all of the tests requested by you and the results thereof based upon the information that you provided to us. You have 60 days from date of issuance of this report to notify us of any material error or omission caused by our negligence, provided, however, that such notice shall be in writing and shall specifically address the issue you wish to raise. A failure to raise such issue within the prescribed time shall constitute your unqualified acceptance of the completeness of this report, the tests conducted and the correctness of the report contents. Unless specific mention, the uncertainty of measurement has been explicitly taken into account to declare the compliance or non-compliance to the specification. The report must not be used by the client to claim product certification, approval, or endorsement by TAF or any government agencies

## Table of Contents

<b>Release Control Record</b> .....	<b>4</b>
<b>1 Certificate of Conformity</b> .....	<b>5</b>
<b>2 Summary of Test Results</b> .....	<b>6</b>
2.1 Measurement Uncertainty.....	6
2.2 Test Site And Instruments.....	7
<b>3 General Information</b> .....	<b>8</b>
3.1 General Description of EUT.....	8
3.2 Configuration of System Under Test.....	9
3.2.1 Description Of Support Units.....	9
3.3 Test Mode Applicability and Tested Channel Detail.....	10
3.4 EUT Operating Conditions.....	11
3.5 General Description of Applied Standards.....	11
<b>4 Test Types and Results</b> .....	<b>12</b>
4.1 Output Power Measurement.....	12
4.1.1 Limits of Output Power Measurement.....	12
4.1.2 Test Procedures.....	12
4.1.3 Test Setup.....	13
4.1.4 Test Results.....	14
4.2 Modulation characteristics Measurement.....	18
4.2.1 Limits of Modulation characteristics.....	18
4.2.2 Test Procedure.....	18
4.2.3 Test Setup.....	18
4.2.4 Test Results.....	19
4.3 Frequency Stability Measurement.....	20
4.3.1 Limits of Frequency Stability Measurement.....	20
4.3.2 Test Procedure.....	20
4.3.3 Test Setup.....	20
4.3.4 Test Results.....	21
4.4 Emission Bandwidth Measurement.....	22
4.4.1 Limits Of Emission Bandwidth Measurement.....	22
4.4.2 Test Procedure.....	22
4.4.3 Test Setup.....	22
4.4.4 Test Result.....	23
4.5 Band Edge Measurement.....	25
4.5.1 Limits of Band Edge Measurement.....	25
4.5.2 Test Setup.....	25
4.5.3 Test Procedures.....	25
4.5.4 Test Results.....	26
4.6 Peak to Average Ratio.....	30
4.6.1 Limits of Peak to Average Ratio Measurement.....	30
4.6.2 Test Setup.....	30
4.6.3 Test Procedures.....	30
4.6.4 Test Results.....	31
4.7 Conducted Spurious Emissions.....	32
4.7.1 Limits of Conducted Spurious Emissions Measurement.....	32
4.7.2 Test Setup.....	32
4.7.3 Test Procedure.....	32
4.7.4 Test Results.....	33
4.8 Radiated Emission Measurement.....	39
4.8.1 Limits of Radiated Emission Measurement.....	39
4.8.2 Test Procedure.....	39
4.8.3 Deviation from Test Standard.....	39

4.8.4 Test Setup.....	40
4.8.5 Test Results .....	41
<b>5 Pictures of Test Arrangements.....</b>	<b>46</b>
<b>Appendix – Information on the Testing Laboratories .....</b>	<b>47</b>

### Release Control Record

Issue No.	Description	Date Issued
RF180919D02-2	Original release.	Dec. 12, 2018

## 1 Certificate of Conformity

**Product:** Harman Magic Box

**Brand:** Sprint & Harman Kardon

**Test Model:** SOR4105T

**Sample Status:** Engineering sample

**Applicant:** Sercomm Corp.

**Test Date:** Oct. 11 ~ Nov. 5, 2018

**Standards:** FCC Part 27, Subpart M

The above equipment has been tested by **Bureau Veritas Consumer Products Services (H.K.) Ltd., Taoyuan Branch**, and found compliance with the requirement of the above standards. The test record, data evaluation & Equipment Under Test (EUT) configurations represented herein are true and accurate accounts of the measurements of the sample's RF characteristics under the conditions specified in this report.

**Prepared by :**

*Annie Chang*

**Date:** Dec. 12, 2018

Annie Chang / Senior Specialist

**Approved by :**

*Rex Lai*

**Date:** Dec. 12, 2018

Rex Lai / Associate Technical Manager

## 2 Summary of Test Results

Applied Standard: FCC Part 27 & Part 2			
FCC Clause	Test Item	Result	Remarks
2.1046 27.50 (h)	Equivalent Isotropically Radiated Power	PASS	Meet the requirement of limit.
2.1047	Modulation characteristics	PASS	Meet the requirement
2.1055 27.54	Frequency Stability Stay with the authorized bands of operation	PASS	Meet the requirement of limit.
2.1049 27.53 (m)(6)	Emission Bandwidth	PASS	Meet the requirement of limit.
2.1051 27.53(m)	Band Edge Measurements	PASS	Meet the requirement of limit.
----	Peak To Average Ratio	PASS	Meet the requirement
2.1051 27.53(h)	Conducted Spurious Emissions	PASS	Meet the requirement of limit.
2.1053 27.53(m)(4)(6)	Radiated Spurious Emissions	PASS	Meet the requirement of limit. Minimum passing margin is -34.21dB at 5310.46MHz.

### 2.1 Measurement Uncertainty

Where relevant, the following measurement uncertainty levels have been estimated for tests performed on the EUT as specified in CISPR 16-4-2:

Measurement	Frequency	Expanded Uncertainty (k=2) ( $\pm$ )
Conducted Emissions at mains ports	150kHz ~ 30MHz	2.79 dB
Radiated Emissions up to 1 GHz	9kHz ~ 30MHz	2.38 dB
	30MHz ~ 1000MHz	5.54 dB
Radiated Emissions above 1 GHz	Above 1GHz	5.48 dB

## 2.2 Test Site And Instruments

DESCRIPTION & MANUFACTURER	MODEL NO.	SERIAL NO.	CALIBRATED DATE	CALIBRATED UNTIL
HP Preamplifier	8447D	2432A03504	Feb. 21, 2018	Feb. 20, 2019
HP Preamplifier	8449B	3008A01201	Feb. 22, 2018	Feb. 21, 2019
MITEQ Preamplifier	AMF-6F-260400-33-8P	892164	Feb. 21, 2018	Feb. 20, 2019
Agilent TEST RECEIVER	N9038A	MY51210129	Feb. 6, 2018	Feb. 5, 2019
Schwarzbeck Antenna	VULB 9168	139	Nov. 29, 2017	Nov. 28, 2018
Schwarzbeck Antenna	VHBA 9123	480	May 19, 2017	May 18, 2019
Schwarzbeck Horn Antenna	BBHA-9170	212	Dec. 1, 2017	Nov. 30, 2018
Schwarzbeck Horn Antenna	BBHA 9120-D1	D130	Dec. 1, 2017	Nov. 30, 2018
ADT. Turn Table	TT100	0306	NA	NA
ADT. Tower	AT100	0306	NA	NA
Software	Radiated_V7.6.15.9.5	NA	NA	NA
SUHNER RF cable With 4dB PAD	SF102	Cable-CH6-01	Aug. 13, 2018	Aug. 12, 2019
SUHNER RF cable With 3/4dB PAD	SF102	Cable-CH8-3.6m	Aug. 13, 2018	Aug. 12, 2019
KEYSIGHT MIMO Powermeasurement Test set	U2021XA	U2021XA-001	Jun. 4, 2018	Jun. 3, 2019
KEYSIGHT Spectrum Analyzer	N9030A	MY54490260	Aug. 3, 2018	Aug. 2, 2019
Loop Antenna EMCI	LPA600	270	Aug. 11, 2017	Aug. 10, 2019
EMCO Horn Antenna	3115	00028257	Nov. 30, 2017	Nov. 29, 2018
Highpass filter Wainwright Instruments	WHK 3.1/18G-10SS	SN 8	NA	NA
ROHDE & SCHWARZ Spectrum Analyzer	FSV40	101042	Sep. 27, 2018	Sep. 26, 2019
Anritsu Power Sensor	MA2411B	0738404	Apr. 26, 2018	Apr. 25, 2019
Anritsu Power Meter	ML2495A	0842014	Apr. 26, 2018	Apr. 25, 2019
Temperature & Humidity Chamber	MHU-225AU	920409	May 25, 2018	May 24, 2019
Anritsu Radio Communication Analyzer	MT8820C	6201300638	Jun. 27, 2018	Jun. 8, 2019

- NOTE:**
1. The calibration interval of the above test instruments is 12/24 months. And the calibrations are traceable to NML/ROC and NIST/USA.
  2. The horn antenna and HP preamplifier (model: 8449B) are used only for the measurement of emission frequency above 1GHz if tested.
  3. The test was performed in Chamber No. 6.
  4. The Industry Canada Reference No. IC 7450E-6.

### 3 General Information

#### 3.1 General Description of EUT

Product	Harman Magic Box
Brand	Sprint & Harman Kardon
Test Model	SOR4105T
Status of EUT	Engineering sample
Power Supply Rating	12Vdc from Adapter
Modulation Type	QPSK, 16QAM, 64QAM
Operating Frequency	LTE Band 41 (Channel Bandwidth 20MHz): 2510~2560MHz, 2630~2680MHz
Max. EIRP Power	LTE Band 41 (Channel Bandwidth 20MHz): 2510~2560MHz: 887.156mW (29.48dBm), 2630~2680MHz: 887.156mW (29.48dBm)
Antenna Type	Ant. 1: Dipole antenna with 6.20dBi gain Ant. 2: Dipole antenna with 6.80dBi gain
Antenna Connector	I-PEX
Accessory Device	Refer to user's manual
Data Cable Supplied	N/A

Note:

1. The EUT uses following adapter.

Brand	CWT
Model	2ABF060F
AC Input Power	100-240V, 50/60H, 1.7A
DC Output Power	12V, 5A
Power Line	Non-shielded AC 3-Pin cable (3.5m) Non-shielded DC cable (1.5m)

2. The Cross-Polarized antennas is as follows:

LTE Band 41	Antenna port
Vertical	Ant. 2
Horizontal	Ant. 1

3. The above EUT information is declared by manufacturer and for more detailed features description, please refers to the manufacturer's specifications or User's Manual.



### 3.2 Configuration of System Under Test

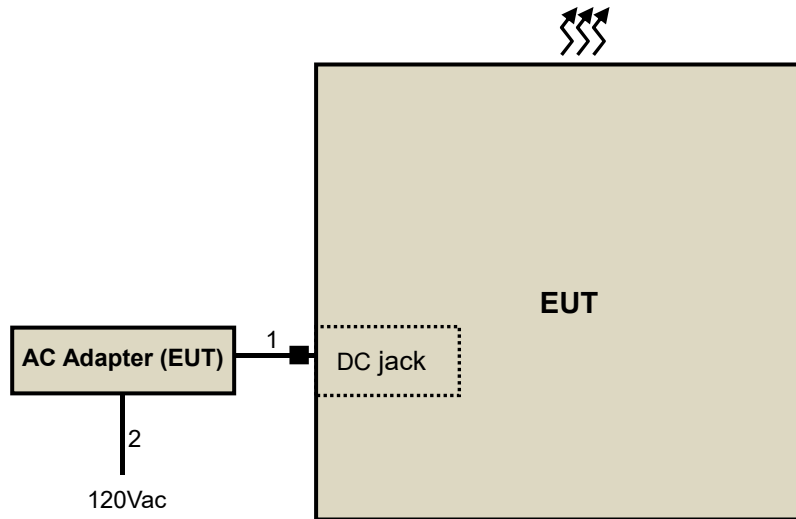

#### 3.2.1 Description Of Support Units

The EUT has been tested as an independent unit together with other necessary accessories or support units. The following support units or accessories were used to form a representative test configuration during the tests.

ID	Descriptions	Qty.	Length (m)	Shielding (Yes/No)	Cores (Qty.)	Remarks
1.	DC cable	1	1.5	N	1	Supplied by client
2.	AC cable	1	3.5	N	0	Supplied by client

Note: The core(s) is(are) originally attached to the cable(s).

### 3.3 Test Mode Applicability and Tested Channel Detail

Test Item	Available Channel	Tested Channel	Channel Bandwidth	Modulation
Output Power	39790 to 40290, 40990 to 41490	39790, 40040, 40290, 40990, 41240, 41490	20MHz	QPSK / 16QAM / 64QAM
Modulation characteristics	39790 to 40290, 40990 to 41490	40040, 41240	20MHz	QPSK / 16QAM / 64QAM
Frequency Stability	39790 to 40290, 40990 to 41490	40040, 41240	20MHz	QPSK
Emission Bandwidth	39790 to 40290, 40990 to 41490	39790, 40040, 40290, 40990, 41240, 41490	20MHz	QPSK / 16QAM / 64QAM
Band Edge	39790 to 40290, 40990 to 41490	39790, 40290, 40990, 41490	20MHz	QPSK / 16QAM / 64QAM
Peak To Average Ratio	39790 to 40290, 40990 to 41490	39790, 40040, 40290, 40990, 41240, 41490	20MHz	QPSK
Conducted Emission	39790 to 40290, 40990 to 41490	39790, 40040, 40290, 40990, 41240, 41490	20MHz	QPSK
Radiated Emission Below 1GHz	39790 to 40290, 40990 to 41490	40040, 41240	20MHz	QPSK
Radiated Emission Above 1GHz	39790 to 40290, 40990 to 41490	39790, 40040, 40290, 40990, 41240, 41490	20MHz	QPSK

**NOTE:**

1. For radiated emission below 1 GHz, the low, mid and high channels were pre-tested in chamber. The low channel was the worst case and chosen for final test.
2. The conducted output power for QPSK, 16QAM and 64QAM, measured value of QPSK is higher than other mode. Therefore, the Frequency Stability, Peak To Average Ratio, Conducted Emission and Radiated Emission were performed under QPSK mode only.

**Test Condition:**

Test Item	Environmental Conditions	Input Power	Tested By
Output Power	22deg. C, 70%RH	120Vac, 60Hz	Dalen Dai
Modulation characteristics	22deg. C, 70%RH	120Vac, 60Hz	Dalen Dai
Frequency Stability	22deg. C, 70%RH	120Vac, 60Hz	Dalen Dai
Occupied Bandwidth	22deg. C, 70%RH	120Vac, 60Hz	Dalen Dai
Band Edge	22deg. C, 70%RH	120Vac, 60Hz	Dalen Dai
Peak To Average Ratio	22deg. C, 70%RH	120Vac, 60Hz	Dalen Dai
Conducted Emission	22deg. C, 70%RH	120Vac, 60Hz	Dalen Dai
Radiated Emission	25deg. C, 76%RH	120Vac, 60Hz	Ian Chang

### 3.4 EUT Operating Conditions

The EUT makes a call to the communication simulator. The communication simulator station system controlled a EUT to export maximum output power under transmission mode and specific channel frequency

### 3.5 General Description of Applied Standards

The EUT is a RF Product. According to the specifications of the manufacturer, it must comply with the requirements of the following standards:

**FCC 47 CFR Part 2**

**FCC 47 CFR Part 27**

**KDB 971168 D01 Power Meas License Digital Systems v03r01**

**ANSI/TIA/EIA-603-E 2016**

**ANSI 63.26-2015**

**NOTE:** All test items have been performed and recorded as per the above standards.

## 4 Test Types and Results

### 4.1 Output Power Measurement

#### 4.1.1 Limits of Output Power Measurement

According FCC Part 27 Clause 27.50(h)(1), Main, booster and base stations. The maximum EIRP of a main, booster or base station shall not exceed  $33 \text{ dBW} + 10\log(X/Y) \text{ dBW}$ .

#### 4.1.2 Test Procedures

EIRP / ERP Measurement:

- a. All measurements were done at low, middle and high operational frequency range. RBW and VBW is 5MHz for LTE mode.
- b. Substitution method is used for E.I.R.P measurement. In the semi-anechoic chamber, EUT placed on the 0.8m(below or equal 1GHz) and/or 1.5m(above 1GHz) height of Turn Table, rotated the table around 360 degrees to search the maximum radiation power and receiver antenna shall be rotated vertical and horizontal polarization and moved height from 1m to 4m to find the maximum polar radiated power. The "Read Value" is the spectrum reading the maximum power value.
- c. The substitution horn antenna is substituted for EUT at the same position and signals generator export the CW signal to the substitution antenna via a tx cable. Rotated the Turn Table and moved receiving antenna to find the maximum radiation power. Adjust output power level of S.G to get a Value of spectrum reading equal to "Read Value" of step b. Record the power level of S.G
- d.  $\text{EIRP} = \text{Output power level of S.G} - \text{TX cable loss} + \text{Antenna gain of substitution horn}$ . E.R.P power can be calculated form E.I.R.P power by subtracting the gain of dipole,  $\text{E.R.P power} = \text{E.I.P.R power} - 2.15\text{dBi}$ .

Conducted Power Measurement:

A power sensor was used on the output port of the EUT. A power meter was used to read the response of the power sensor. Record the power level.

### 4.1.3 Test Setup

#### EIRP / ERP MEASUREMENT:

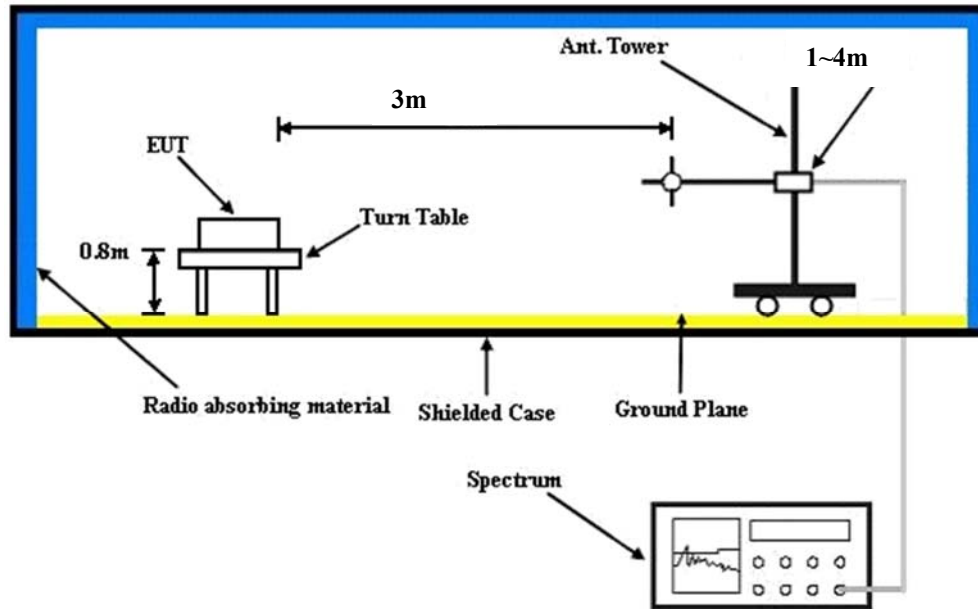

For the actual test configuration, please refer to the attached file (Test Setup Photo).

#### CONDUCTED POWER MEASUREMENT:

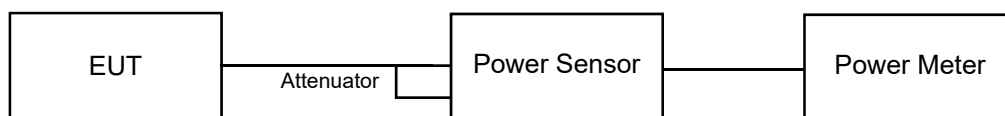

For the actual test configuration, please refer to the attached file (Test Setup Photo).

#### 4.1.4 Test Results

#### CONDUCTED OUTPUT POWER (dBm)

CH	Frequency (MHz)	CONDUCTED OUTPUT POWER (dBm)								
		QPSK			16QAM			64QAM		
		Chain 0	Chain 1	Total	Chain 0	Chain 1	Total	Chain 0	Chain 1	Total
39790	2510	20.94	20.96	23.96	20.93	20.92	23.94	20.57	20.71	23.65
40040	2535	20.72	20.74	23.74	20.68	20.81	23.76	20.56	20.87	23.73
40290	2560	20.84	20.82	23.84	20.91	20.93	23.93	20.38	20.54	23.47
40990	2630	20.96	20.95	23.97	20.92	20.92	23.93	20.58	20.47	23.54
41240	2655	20.78	20.80	23.80	20.89	20.93	23.92	20.68	20.80	23.75
41490	2680	20.98	20.80	23.90	20.56	20.68	23.63	20.81	20.77	23.80

EIRP Power (dBm)

**Modulation Type: QPSK**

MODE		TX channel 39790					
Test Distance: 3 M							
No.	Freq. (MHz)	Reading (dBm)	S.G Power Value (dBm)	Correction Factor (dB)	EIRP (dBm)	Limit (dBm)	Margin (dB)
1	2510.00	26.12	-11.33	40.79	29.46	68.23	-38.77

MODE		TX channel 40040					
Test Distance: 3 M							
No.	Freq. (MHz)	Reading (dBm)	S.G Power Value (dBm)	Correction Factor (dB)	EIRP (dBm)	Limit (dBm)	Margin (dB)
1	2535.00	25.87	-11.50	40.77	29.27	68.23	-38.96

MODE		TX channel 40290					
Test Distance: 3 M							
No.	Freq. (MHz)	Reading (dBm)	S.G Power Value (dBm)	Correction Factor (dB)	EIRP (dBm)	Limit (dBm)	Margin (dB)
1	2560.00	25.87	-11.48	40.81	29.33	68.23	-38.90

MODE		TX channel 40990					
Test Distance: 3 M							
No.	Freq. (MHz)	Reading (dBm)	S.G Power Value (dBm)	Correction Factor (dB)	EIRP (dBm)	Limit (dBm)	Margin (dB)
1	2630.00	25.96	-11.70	41.18	<b>29.48</b>	68.23	-38.75

MODE		TX channel 41240					
Test Distance: 3 M							
No.	Freq. (MHz)	Reading (dBm)	S.G Power Value (dBm)	Correction Factor (dB)	EIRP (dBm)	Limit (dBm)	Margin (dB)
1	2655.00	25.85	-11.90	41.23	29.33	68.23	-38.90

MODE		TX channel 41490					
Test Distance: 3 M							
No.	Freq. (MHz)	Reading (dBm)	S.G Power Value (dBm)	Correction Factor (dB)	EIRP (dBm)	Limit (dBm)	Margin (dB)
1	2680.00	25.98	-11.60	41.02	29.42	68.23	-38.81

Note: EIRP (dBm) = S.G Power Value (dBm) + Correction Factor (dB).

**Modulation Type: 16QAM**

Channel Bandwidth: 20MHz

MODE		TX channel 39790					
Test Distance: 3 M							
No.	Freq. (MHz)	Reading (dBm)	S.G Power Value (dBm)	Correction Factor (dB)	EIRP (dBm)	Limit (dBm)	Margin (dB)
1	2510.00	26.13	-11.32	40.79	29.47	68.23	-38.76

MODE		TX channel 40040					
Test Distance: 3 M							
No.	Freq. (MHz)	Reading (dBm)	S.G Power Value (dBm)	Correction Factor (dB)	EIRP (dBm)	Limit (dBm)	Margin (dB)
1	2535.00	25.84	-11.53	40.77	29.24	68.23	-38.99

MODE		TX channel 40290					
Test Distance: 3 M							
No.	Freq. (MHz)	Reading (dBm)	S.G Power Value (dBm)	Correction Factor (dB)	EIRP (dBm)	Limit (dBm)	Margin (dB)
1	2560.00	26.02	-11.33	40.81	<b>29.48</b>	68.23	-38.75

MODE		TX channel 40990					
Test Distance: 3 M							
No.	Freq. (MHz)	Reading (dBm)	S.G Power Value (dBm)	Correction Factor (dB)	EIRP (dBm)	Limit (dBm)	Margin (dB)
1	2630.00	25.93	-11.73	41.18	29.45	68.23	-38.78

MODE		TX channel 41240					
Test Distance: 3 M							
No.	Freq. (MHz)	Reading (dBm)	S.G Power Value (dBm)	Correction Factor (dB)	EIRP (dBm)	Limit (dBm)	Margin (dB)
1	2655.00	25.96	-11.79	41.23	29.44	68.23	-38.79

MODE		TX channel 41490					
Test Distance: 3 M							
No.	Freq. (MHz)	Reading (dBm)	S.G Power Value (dBm)	Correction Factor (dB)	EIRP (dBm)	Limit (dBm)	Margin (dB)
1	2680.00	25.71	-11.87	41.02	29.15	68.23	-39.08

Note: EIRP (dBm) = S.G Power Value (dBm) + Correction Factor (dB).



**Modulation Type: 64QAM**

Channel Bandwidth: 20MHz

MODE		TX channel 39790					
Test Distance: 3 M							
No.	Freq. (MHz)	Reading (dBm)	S.G Power Value (dBm)	Correction Factor (dB)	EIRP (dBm)	Limit (dBm)	Margin (dB)
1	2510.00	25.84	-11.61	40.79	29.18	68.23	-39.05

MODE		TX channel 40040					
Test Distance: 3 M							
No.	Freq. (MHz)	Reading (dBm)	S.G Power Value (dBm)	Correction Factor (dB)	EIRP (dBm)	Limit (dBm)	Margin (dB)
1	2535.00	4.99	-36.28	65.49	29.21	68.23	-39.02

MODE		TX channel 40290					
Test Distance: 3 M							
No.	Freq. (MHz)	Reading (dBm)	S.G Power Value (dBm)	Correction Factor (dB)	EIRP (dBm)	Limit (dBm)	Margin (dB)
1	2560.00	25.47	-11.88	40.81	28.93	68.23	-39.30

MODE		TX channel 40990					
Test Distance: 3 M							
No.	Freq. (MHz)	Reading (dBm)	S.G Power Value (dBm)	Correction Factor (dB)	EIRP (dBm)	Limit (dBm)	Margin (dB)
1	2630.00	25.56	-12.10	41.18	29.08	68.23	-39.15

MODE		TX channel 41240					
Test Distance: 3 M							
No.	Freq. (MHz)	Reading (dBm)	S.G Power Value (dBm)	Correction Factor (dB)	EIRP (dBm)	Limit (dBm)	Margin (dB)
1	2655.00	25.76	-11.99	41.23	29.24	68.23	-38.99

MODE		TX channel 41490					
Test Distance: 3 M							
No.	Freq. (MHz)	Reading (dBm)	S.G Power Value (dBm)	Correction Factor (dB)	EIRP (dBm)	Limit (dBm)	Margin (dB)
1	2680.00	25.88	-11.70	41.02	29.32	68.23	-38.91

Note: EIRP (dBm) = S.G Power Value (dBm) + Correction Factor (dB).

## 4.2 Modulation characteristics Measurement

### 4.2.1 Limits of Modulation characteristics

N/A

### 4.2.2 Test Procedure

Connect the EUT to Spectrum via the antenna connector, The frequency band is set as EUT supported Modulation and Channels, the EUT output is matched with 50 ohm load, the waveform quality and constellation of the EUT was tested.

### 4.2.3 Test Setup

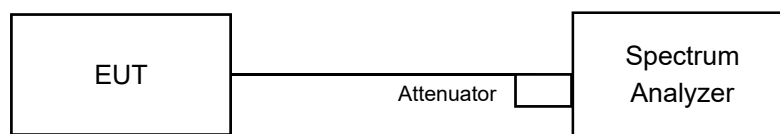

### 4.2.4 Test Results

#### Spectrum Plot of Measurement Value

Channel: 40040 / Frequency (MHz): 2535 MHz

Channel: 41240 / Frequency (MHz): 2655 MHz

QPSK

QPSK

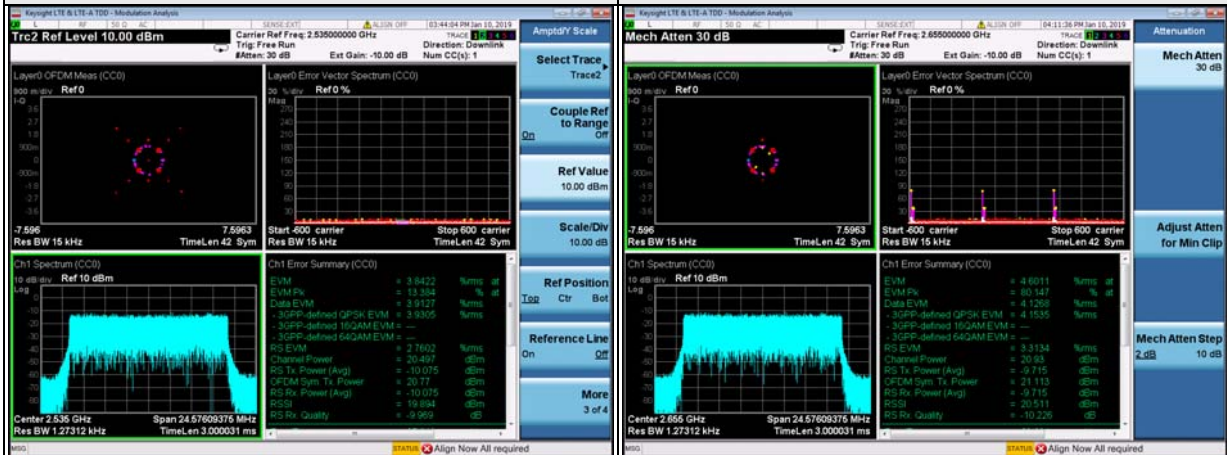

16QAM

16QAM

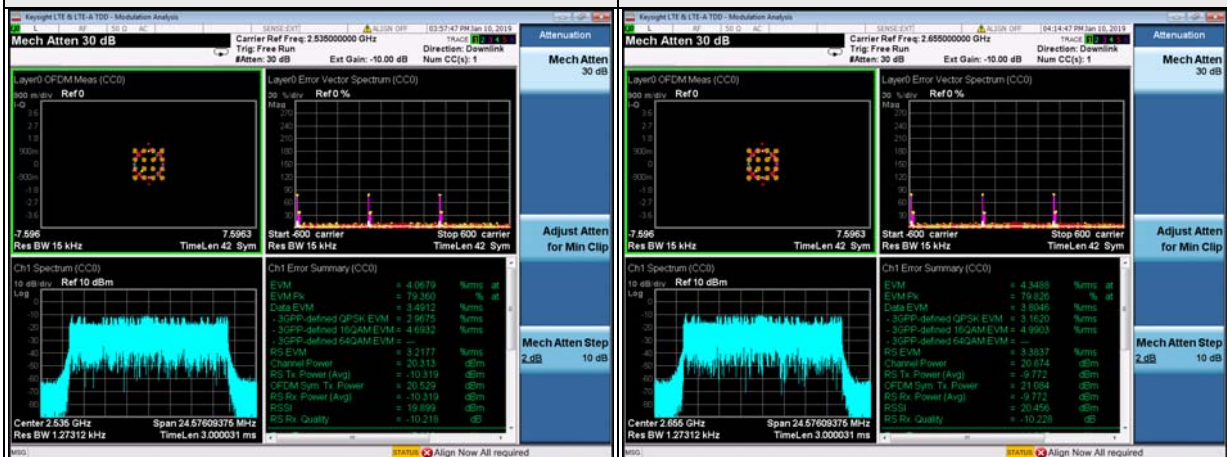

64QAM

64QAM

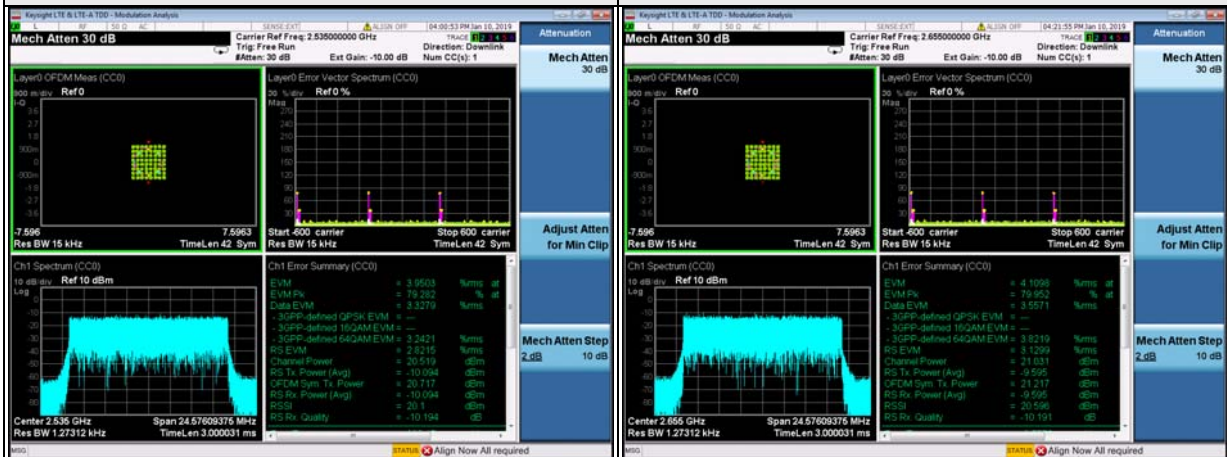

### 4.3 Frequency Stability Measurement

#### 4.3.1 Limits of Frequency Stability Measurement

The frequency stability shall be sufficient to ensure that the fundamental emission stays within the authorized frequency block.

#### 4.3.2 Test Procedure

- a. Device is placed at the oven room. The oven room could control the temperatures and humidity. Power warm up is at least 15 min and power applied should perform before recording frequency error.
- b. EUT is connected the external power supply to control the AC input power. The test voltage range is from minimum to maximum working voltage. Each step shall be record the frequency error rate.
- c. The temperature range step is 10 degrees in this test items. All temperature levels shall be hold the  $\pm 0.5$  °C during the measurement testing. The each temperature step shall be at least 0.5 hours, consider the EUT could be test under the stability condition.

#### 4.3.3 Test Setup

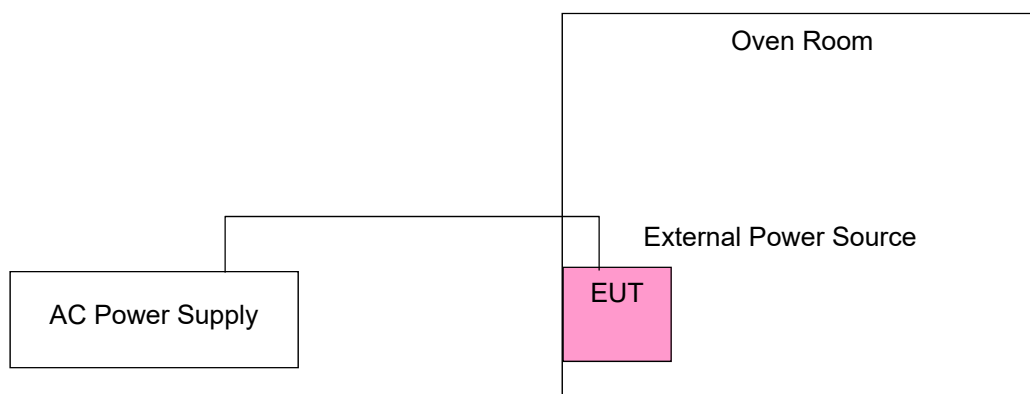

#### 4.3.4 Test Results

##### Frequency Error vs. Voltage

Voltage (Volts)	Frequency Error (ppm)		Limit (ppm)
	Channel: 40040 (Frequency: 2535 MHz)	Channel: 41240 (Frequency: 2655 MHz)	
	20MHz	20MHz	
132	0.0138067061	0.0146892655	2.5
120	0.0189349112	0.0192090395	2.5
108	0.0114398421	0.0120527307	2.5

**NOTE:** The applicant defined the normal working voltage is from 108Vac to 132Vac.

##### Frequency Error vs. Temperature.

TEMP. (°C)	Frequency Error (ppm)		Limit (ppm)
	Channel: 40040 (Frequency: 2535 MHz)	Channel: 41240 (Frequency: 2655 MHz)	
	20MHz	20MHz	
75	0.0134122289	0.0143126178	2.5
70	0.0122287969	0.0128060264	2.5
60	0.0142011834	0.0131826742	2.5
50	0.0173570019	0.0180790960	2.5
40	0.0110453649	0.0173258004	2.5
30	0.0142011834	0.0128060264	2.5
20	0.0161735699	0.0188323918	2.5
10	0.0157790927	0.0109227871	2.5
0	0.0094674556	0.0124293785	2.5
-10	0.0126232741	0.0116760829	2.5
-20	0.0134122289	0.0139359698	2.5
-30	0.0122287969	0.0128060264	2.5

## 4.4 Emission Bandwidth Measurement

### 4.4.1 Limits Of Emission Bandwidth Measurement

According to FCC 27.53(m)(6) specified that emission bandwidth is defined as the width of the signal between two points, one below the carrier center frequency and one above the carrier center frequency, outside of which all emissions are attenuated at least 26dB below the transmitter power.

### 4.4.2 Test Procedure

The transmitter output was connected to the spectrum analyzer through an attenuator. The bandwidth of the fundamental frequency was measured by spectrum analyzer with RBW = 200kHz and VBW = 620kHz (Channel Bandwidth: 20MHz). The 26dB bandwidth is defined as the total spectrum the power of which is higher than peak power minus 26dB.

### 4.4.3 Test Setup

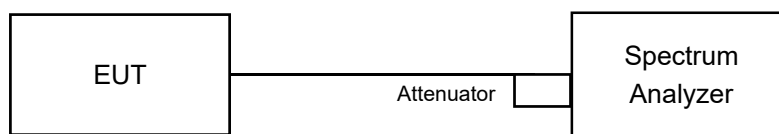

#### 4.4.4 Test Result

Channel Bandwidth: 20MHz							
Channel	Frequency (MHz)	-26dBc Bandwidth (MHz)					
		QPSK		16QAM		64QAM	
		Chain 0	Chain 1	Chain 0	Chain 1	Chain 0	Chain 1
39790	2510	18.67	18.65	18.59	18.55	18.72	18.65
40040	2535	18.69	18.66	18.59	18.57	18.68	18.67
40290	2560	18.67	18.66	18.56	18.58	18.63	18.63
40990	2630	18.66	18.70	18.58	18.57	18.63	18.64
41240	2655	18.67	18.66	18.59	18.56	18.67	18.66
41490	2680	18.66	18.67	18.60	18.57	18.65	18.64

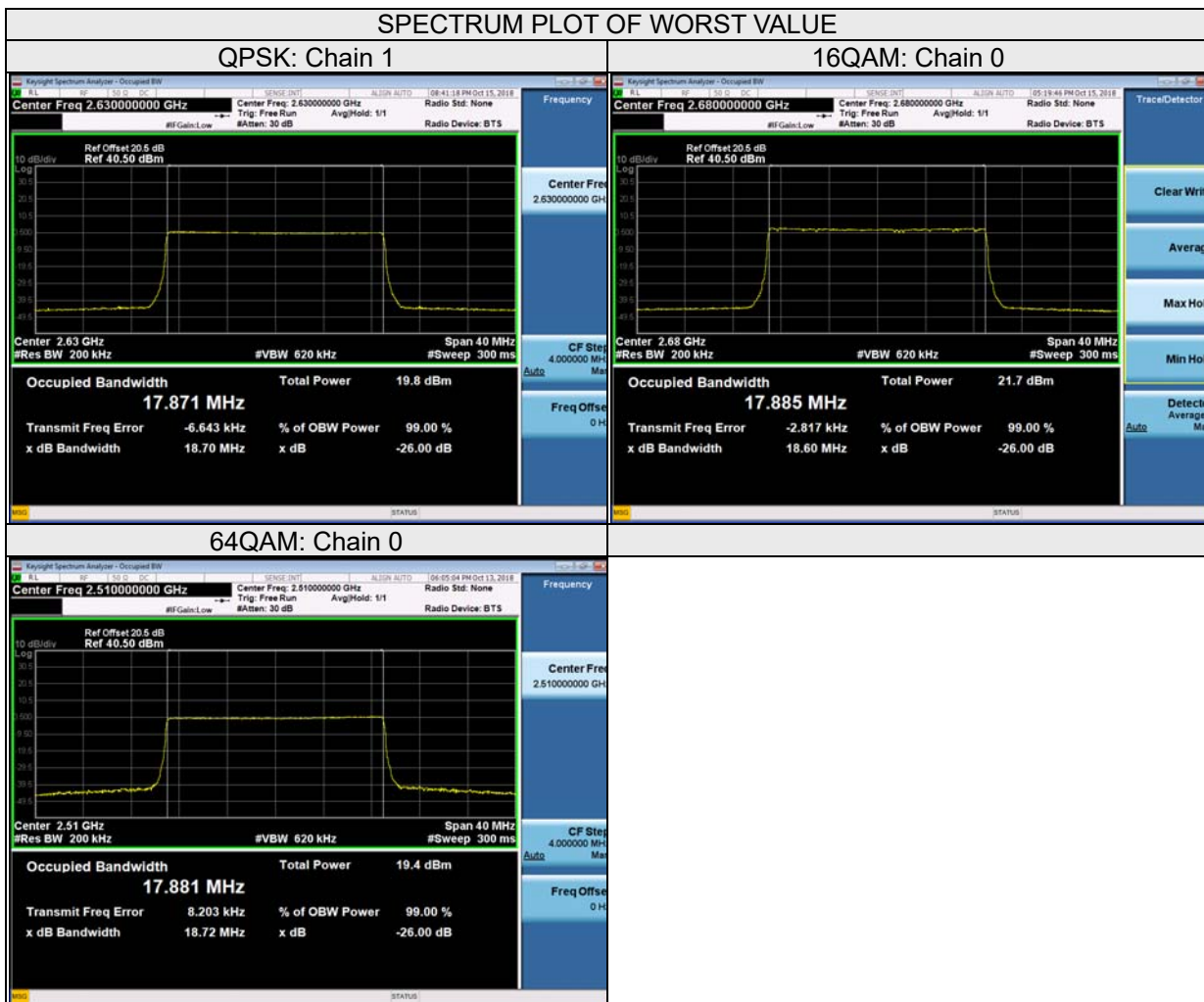

Channel Bandwidth: 20MHz							
Channel	Frequency (MHz)	Occupied Bandwidth (MHz)					
		QPSK		16QAM		64QAM	
		Chain 0	Chain 1	Chain 0	Chain 1	Chain 0	Chain 1
39790	2510	17.869	17.872	17.875	17.870	17.881	17.870
40040	2535	17.872	17.870	17.873	17.873	17.871	17.874
40290	2560	17.863	17.865	17.862	17.868	17.861	17.864
40990	2630	17.867	17.871	17.875	17.877	17.870	17.872
41240	2655	17.859	17.860	17.865	17.871	17.867	17.861
41490	2680	17.882	17.882	17.885	17.887	17.882	17.886





## 4.5 Band Edge Measurement

### 4.5.1 Limits of Band Edge Measurement

According to FCC 27.53(m)(2)(v) specified for all fixed digital user stations, the attenuation factor shall be not less than  $43 + 10 \log (P)$  dB at the channel edge.

### 4.5.2 Test Setup

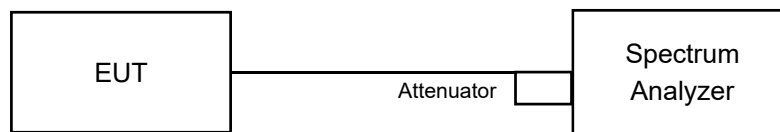

### 4.5.3 Test Procedures

- The EUT was set up for the rated peak power. The power was measured with Spectrum Analyzer. All measurements were done at 3 channels: low, middle and high operational frequency range.
- The center frequency of spectrum is the band edge frequency. RBW = 430kHz and VBW = 1.3MHz (Channel Bandwidth: 20MHz).
- Record the max trace plot into the test report.

### 4.5.4 Test Results

#### Chain 0

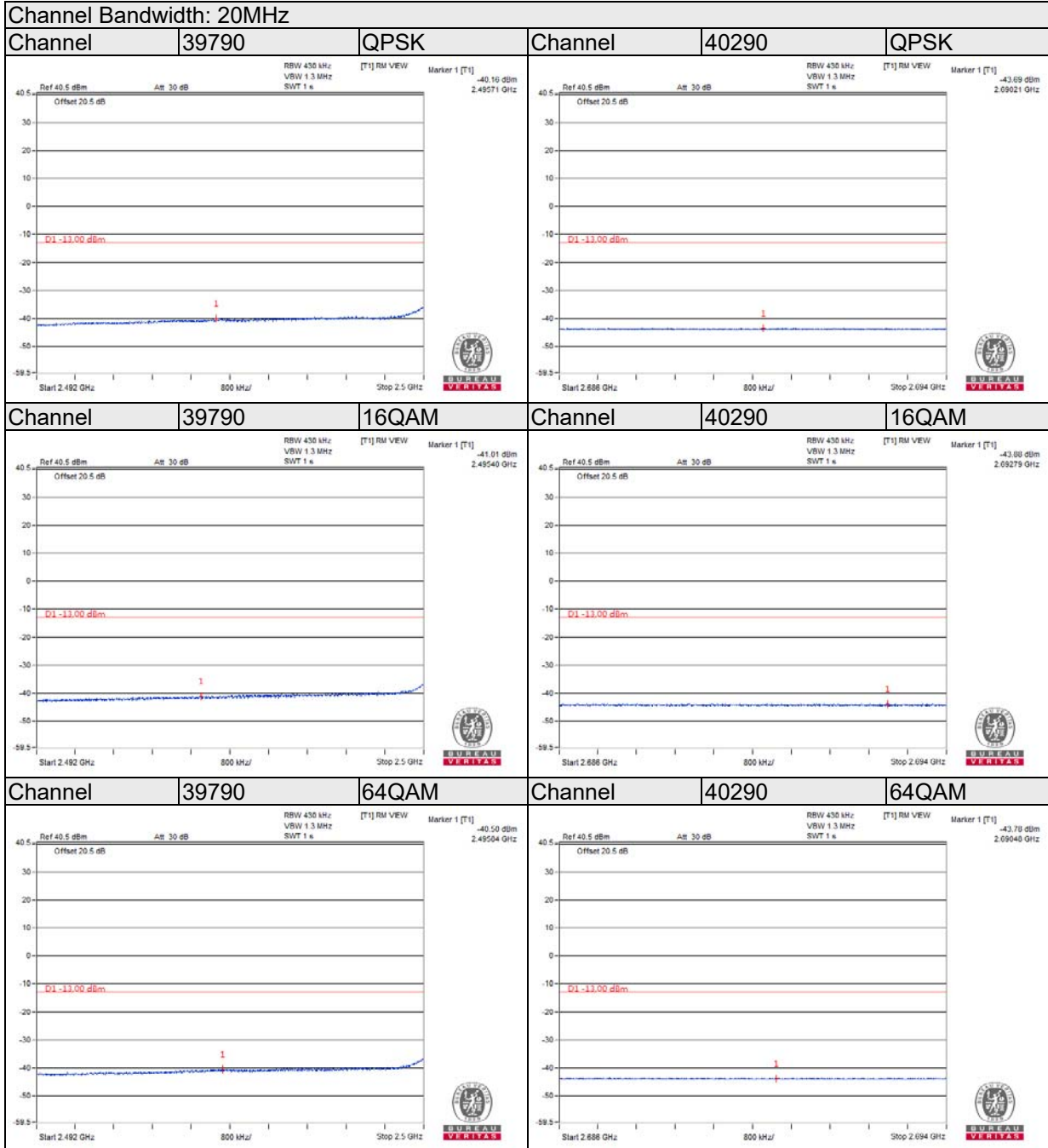

Channel Bandwidth: 20MHz

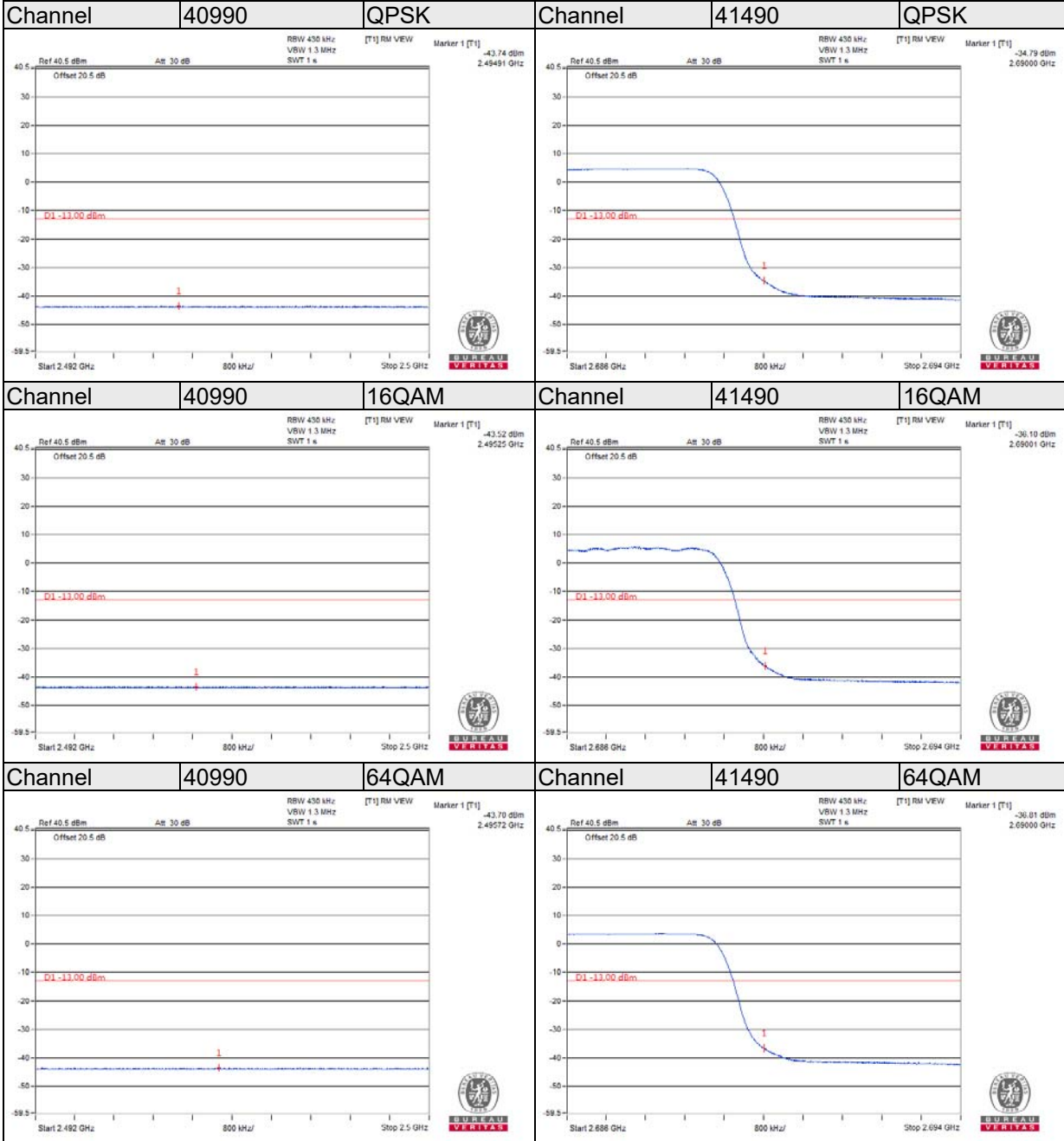

### Chain 1

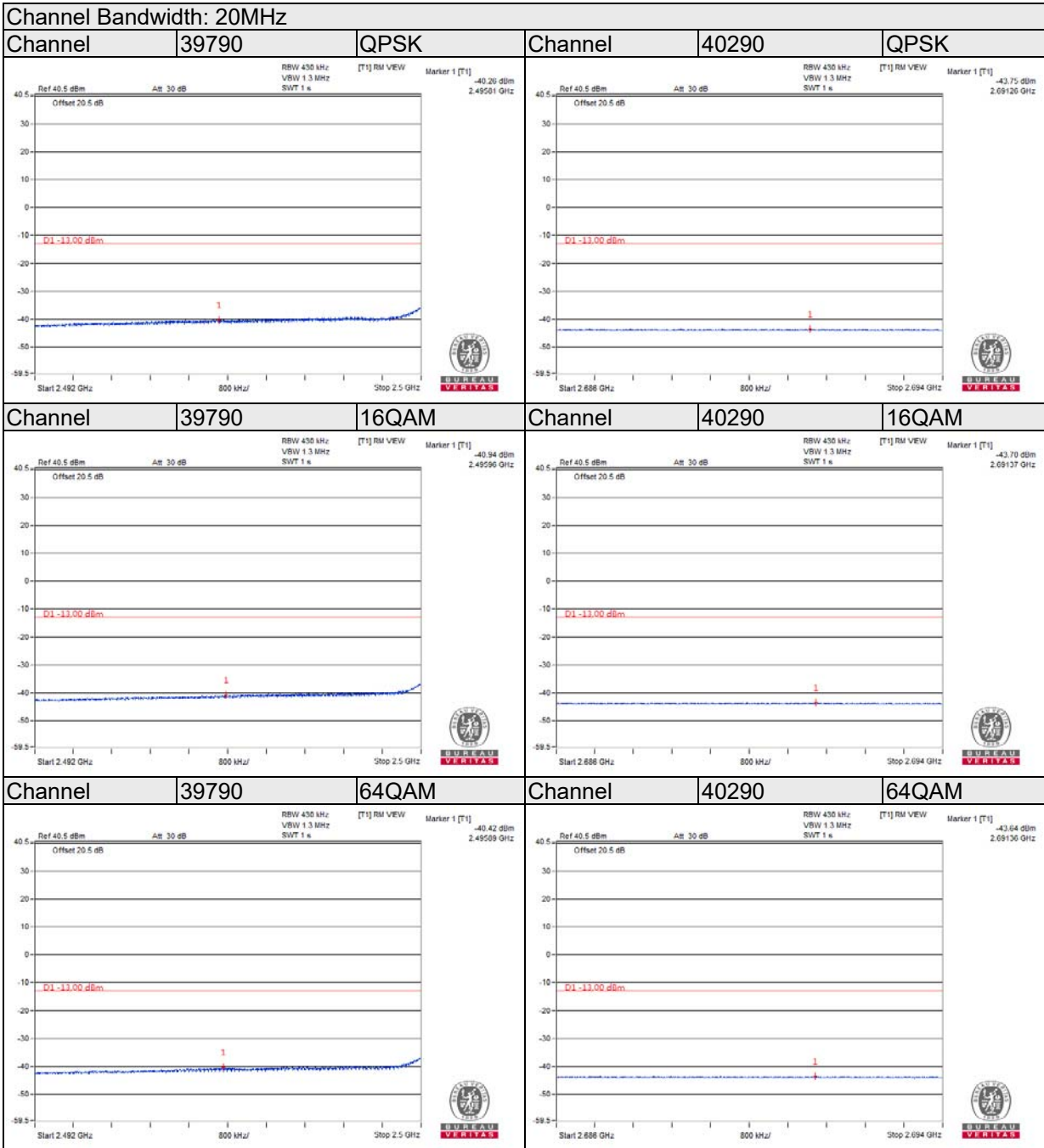

Channel Bandwidth: 20MHz

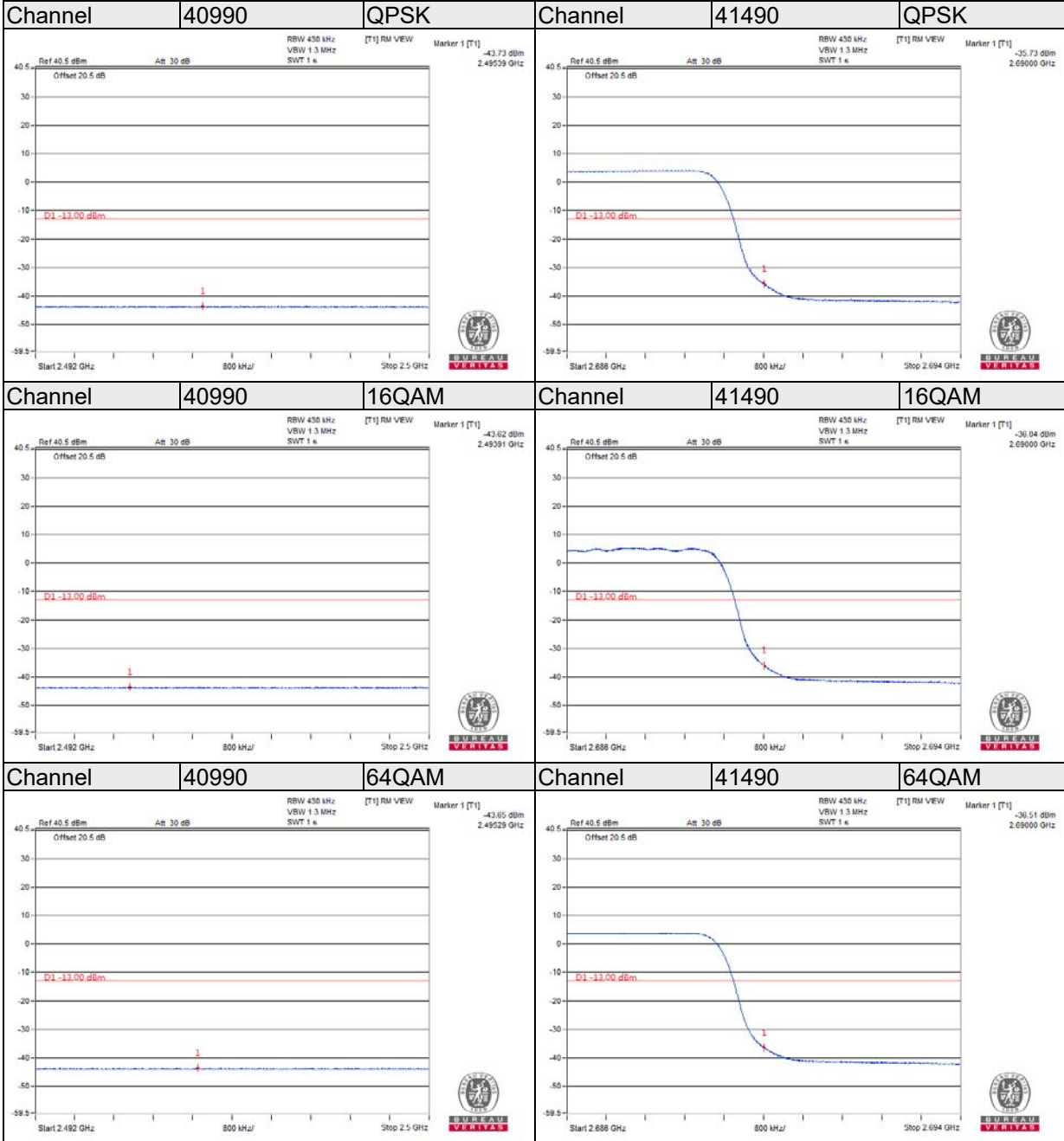

## 4.6 Peak to Average Ratio

### 4.6.1 Limits of Peak to Average Ratio Measurement

In measuring transmissions in this band using an average power technique, the peak to-average ratio (PAR) of the transmission may not exceed 13 dB

### 4.6.2 Test Setup

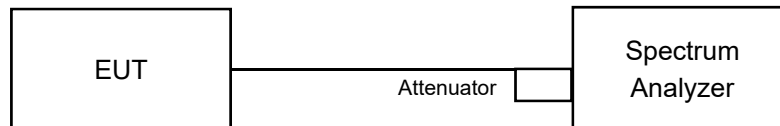

### 4.6.3 Test Procedures

- a. Set resolution/measurement bandwidth  $\geq$  signal's occupied bandwidth;
- b. Set the number of counts to a value that stabilizes the measured CCDF curve;
- c. Record the maximum PAPR level associated with a probability of 0.1%.

#### 4.6.4 Test Results

Channel Bandwidth: 20MHz			
Channel	Frequency (MHz)	Peak To Average Ratio (dB)	
		QPSK	
		Chain 0	Chain 1
39790	2510	8.80	8.85
40040	2535	9.11	8.85
40290	2560	9.70	9.52
40990	2630	9.27	9.25
41240	2655	9.25	8.96
41490	2680	9.27	8.64

#### Spectrum Plot Of Worst Value

Channel: 40290 (Chain 0)

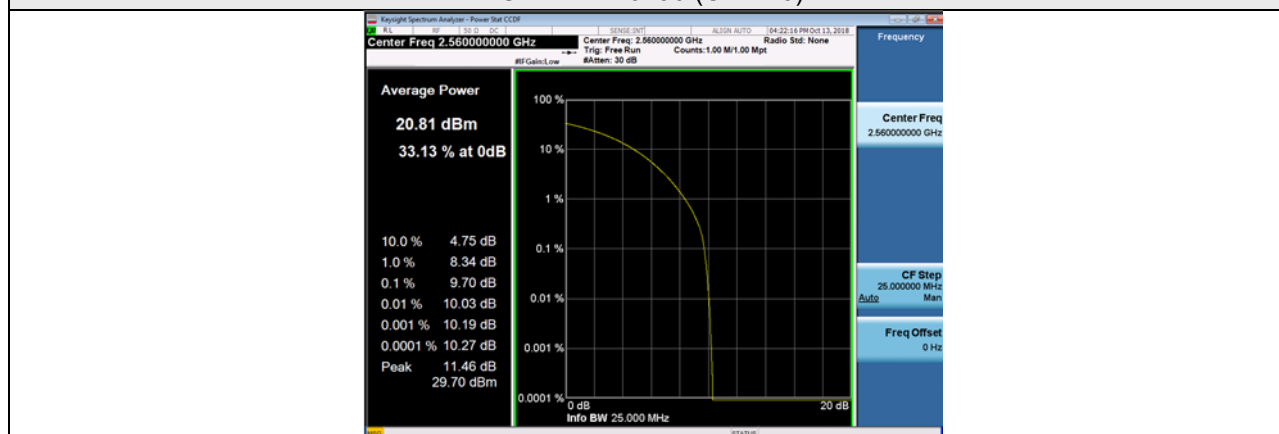

## 4.7 Conducted Spurious Emissions

### 4.7.1 Limits of Conducted Spurious Emissions Measurement

According to FCC 27.53(m)(2)(v) specified for all fixed digital user stations, the attenuation factor shall be not less than  $43 + 10 \log (P)$  dB at the channel edge.

### 4.7.2 Test Setup

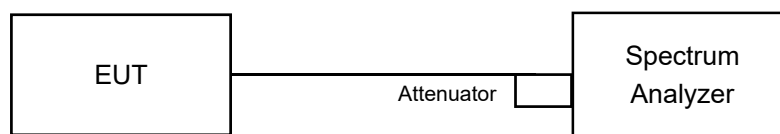

### 4.7.3 Test Procedure

- a. All measurements were done at 3 channels: low, middle and high operational frequency range.
- b. When the spectrum scanned from 9kHz to 27GHz, it shall be connected to the 20dB pad attenuated the carried frequency. The spectrum set RB = 1MHz, VB = 3MHz.



#### 4.7.4 Test Results

#### Modulation Type: QPSK

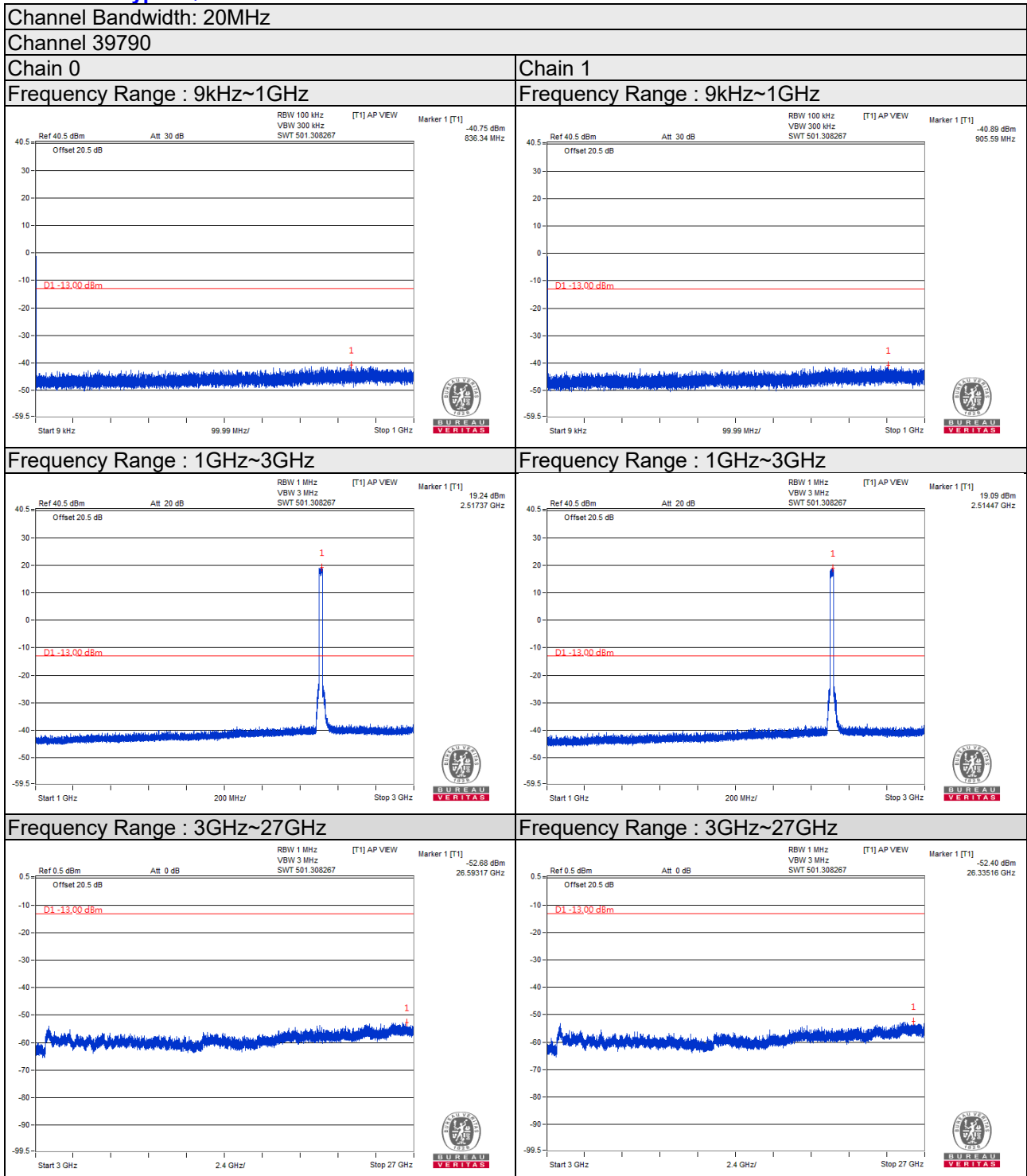

Channel Bandwidth: 20MHz

Channel 40040

Chain 0

Frequency Range : 9kHz~1GHz

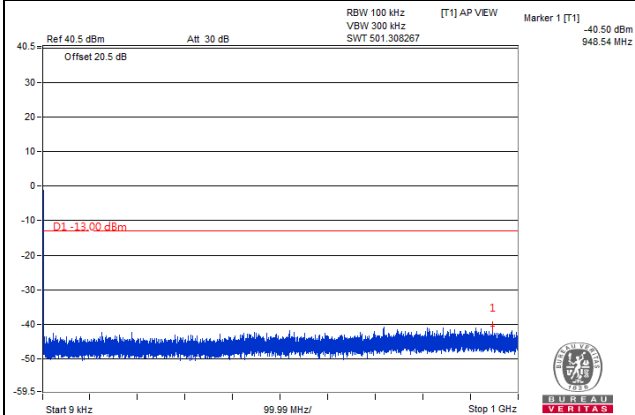

Chain 1

Frequency Range : 9kHz~1GHz

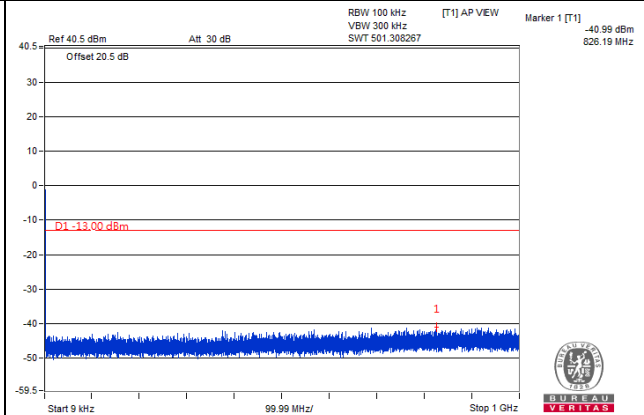

Frequency Range : 1GHz~3GHz

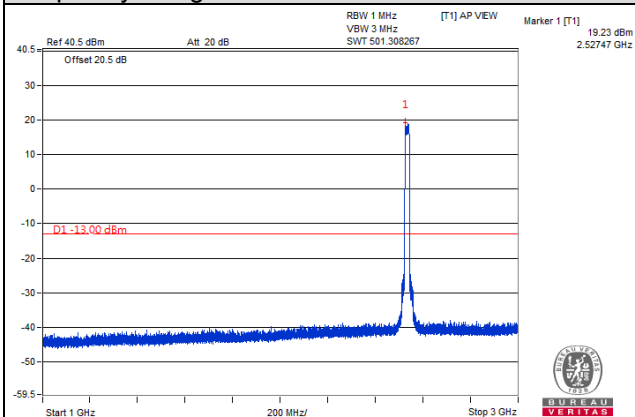

Frequency Range : 1GHz~3GHz

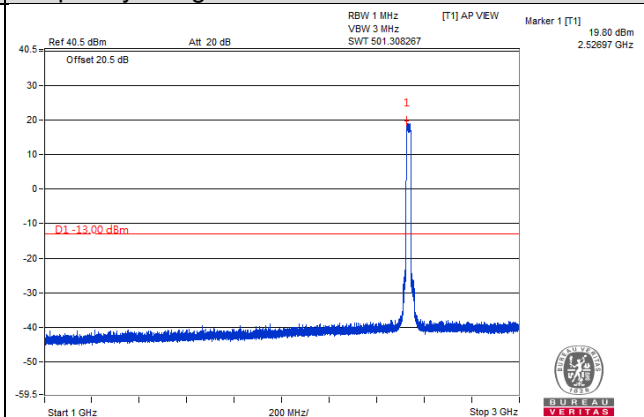

Frequency Range : 3GHz~27GHz

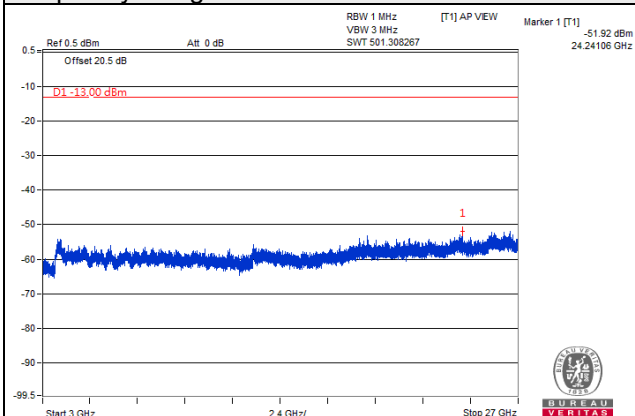

Frequency Range : 3GHz~27GHz

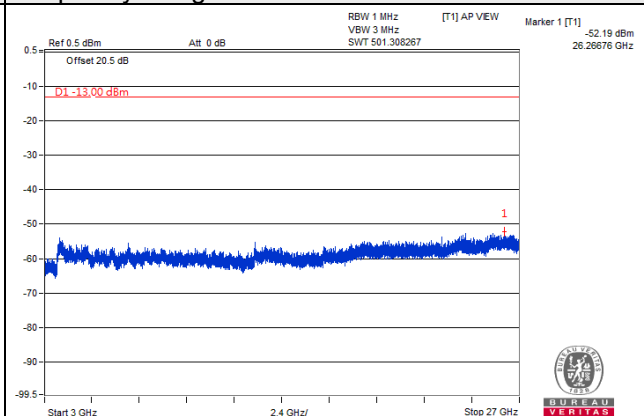

Channel Bandwidth: 20MHz

Channel 40290

Chain 0

Frequency Range : 9kHz~1GHz

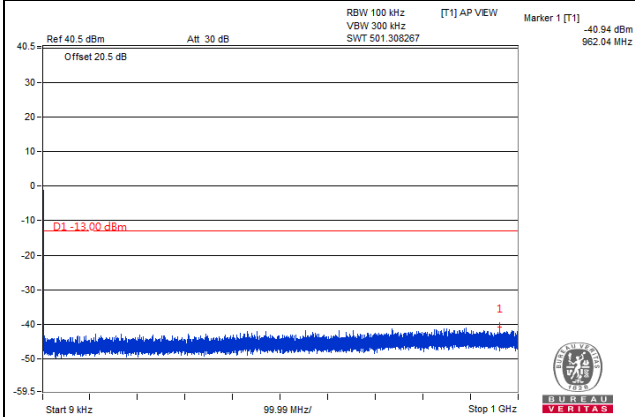

Chain 1

Frequency Range : 9kHz~1GHz

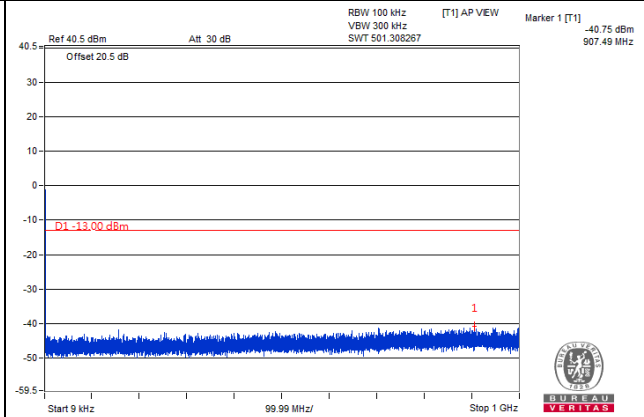

Frequency Range : 1GHz~3GHz

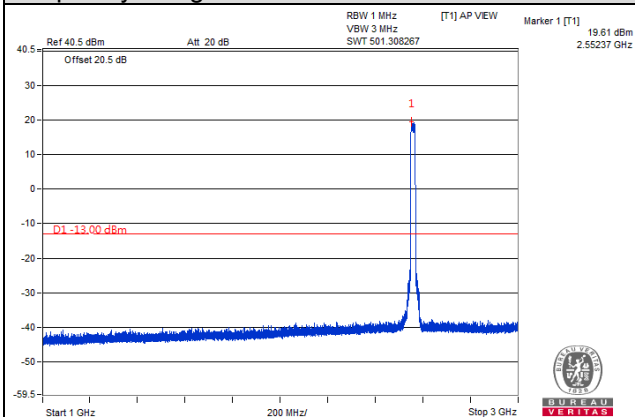

Frequency Range : 1GHz~3GHz

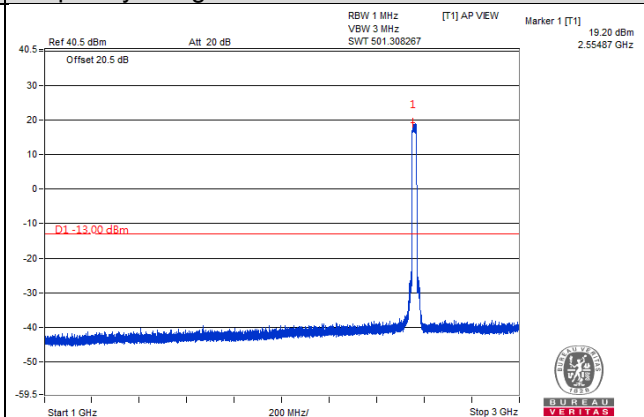

Frequency Range : 3GHz~27GHz

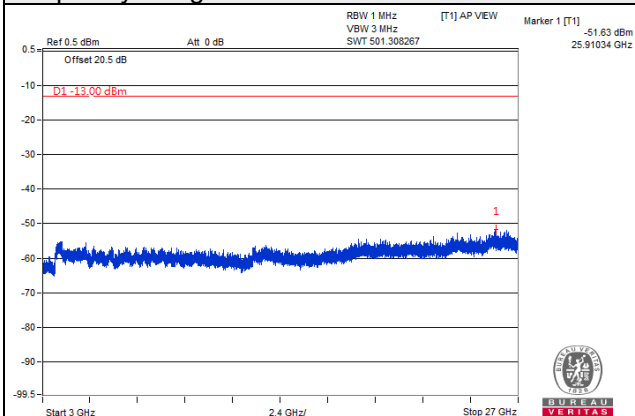

Frequency Range : 3GHz~27GHz

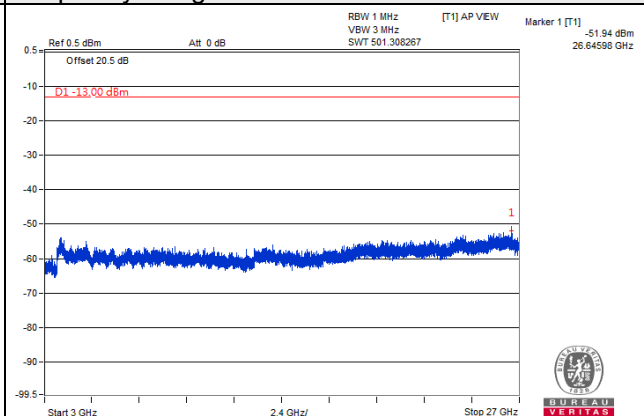

Channel Bandwidth: 20MHz

Channel 40990

Chain 0

Frequency Range : 9kHz~1GHz

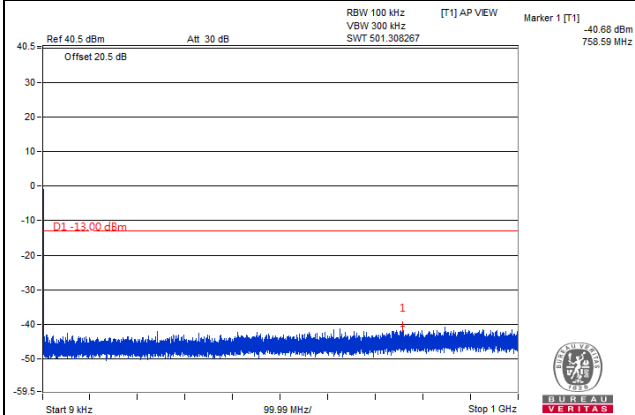

Chain 1

Frequency Range : 9kHz~1GHz

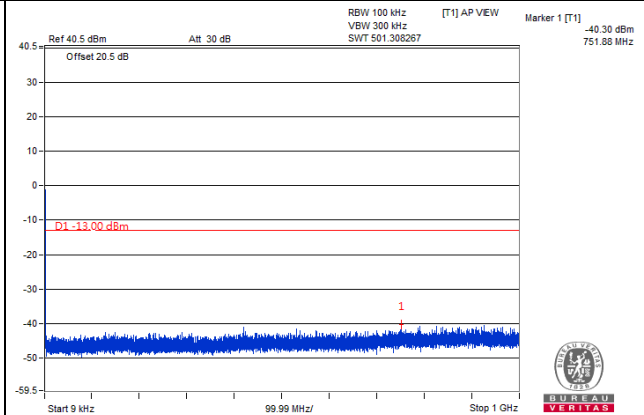

Frequency Range : 1GHz~3GHz

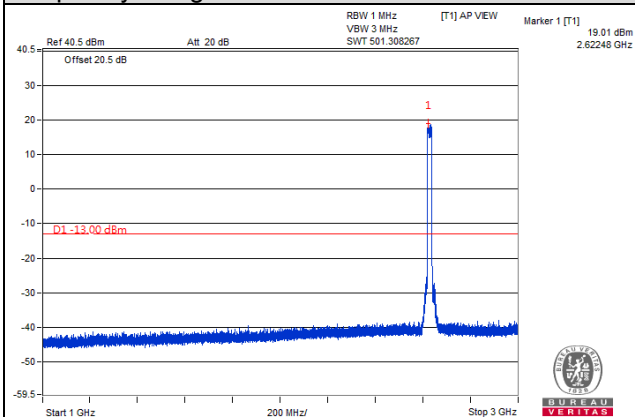

Frequency Range : 1GHz~3GHz

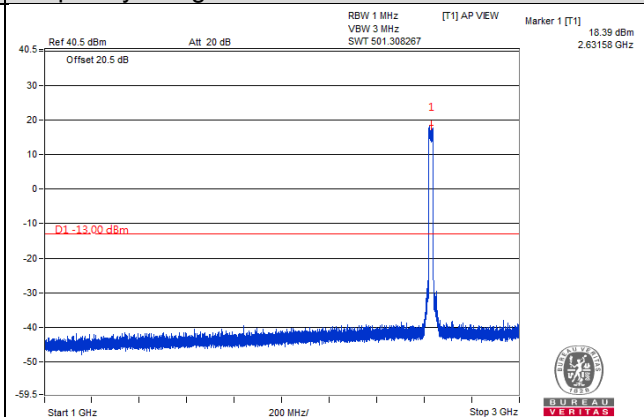

Frequency Range : 3GHz~27GHz

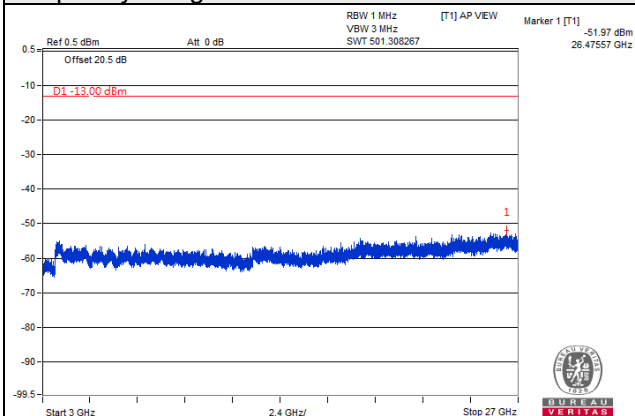

Frequency Range : 3GHz~27GHz

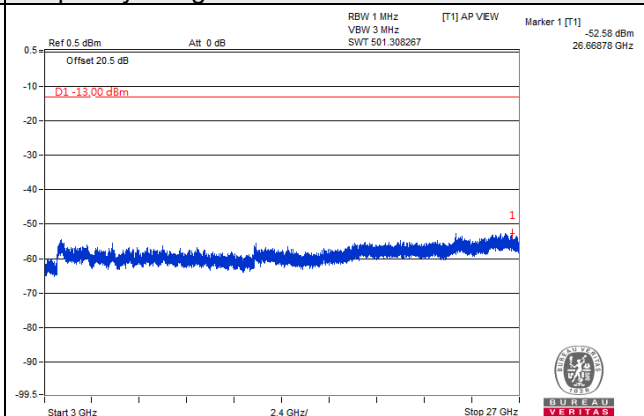

Channel Bandwidth: 20MHz

Channel 41240

Chain 0

Frequency Range : 9kHz~1GHz

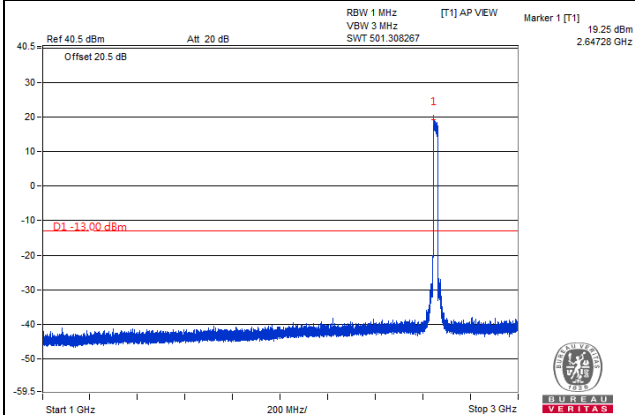

Chain 1

Frequency Range : 9kHz~1GHz

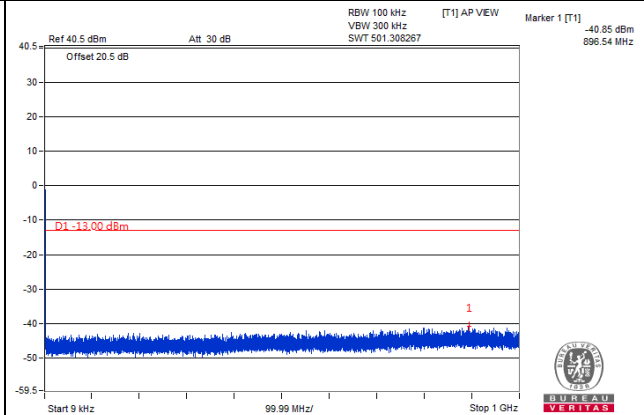

Frequency Range : 1GHz~3GHz

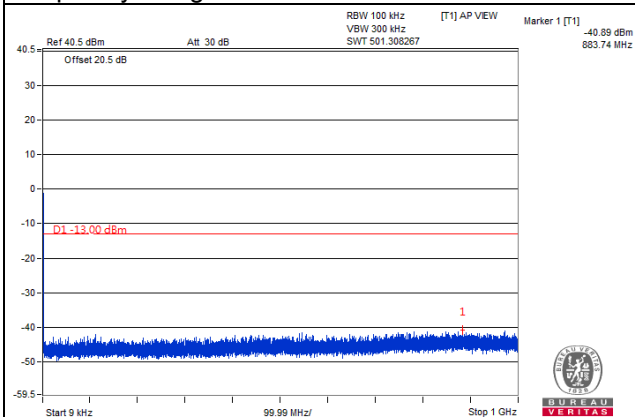

Frequency Range : 1GHz~3GHz

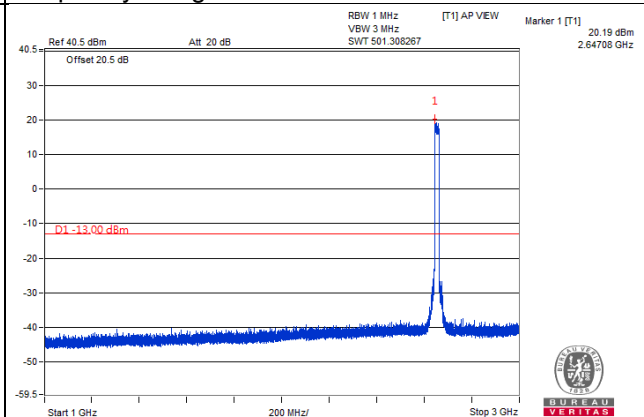

Frequency Range : 3GHz~27GHz

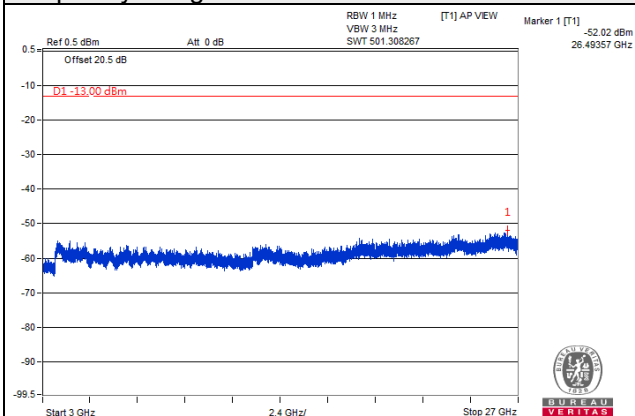

Frequency Range : 3GHz~27GHz

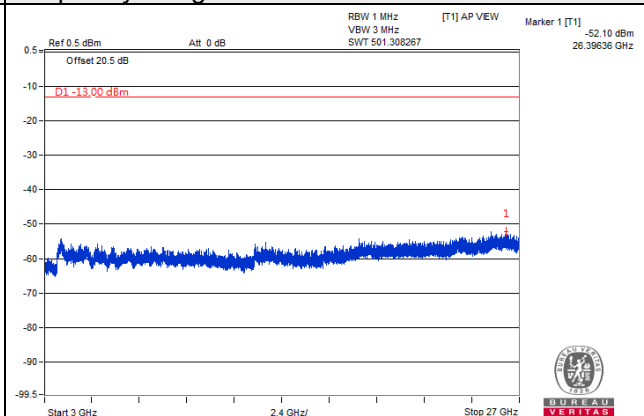

Channel Bandwidth: 20MHz

Channel 41490

Chain 0

Frequency Range : 9kHz~1GHz

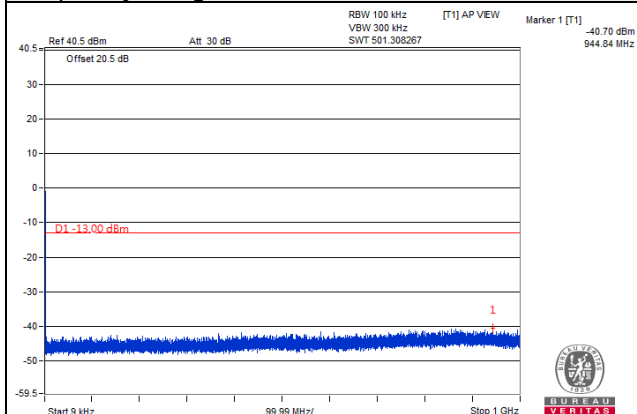

Chain 1

Frequency Range : 9kHz~1GHz

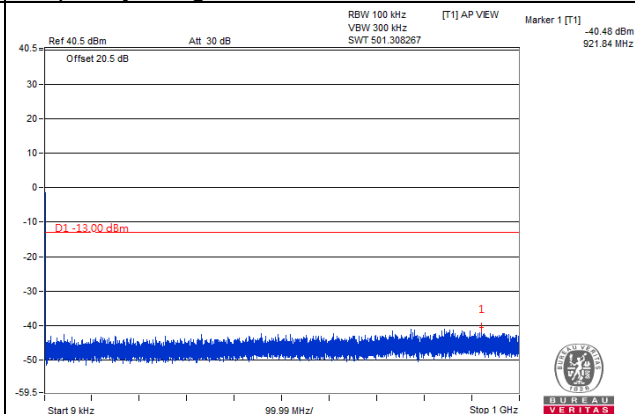

Frequency Range : 1GHz~3GHz

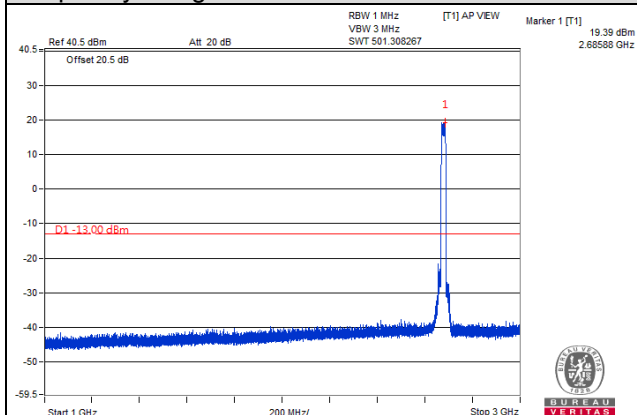

Frequency Range : 1GHz~3GHz

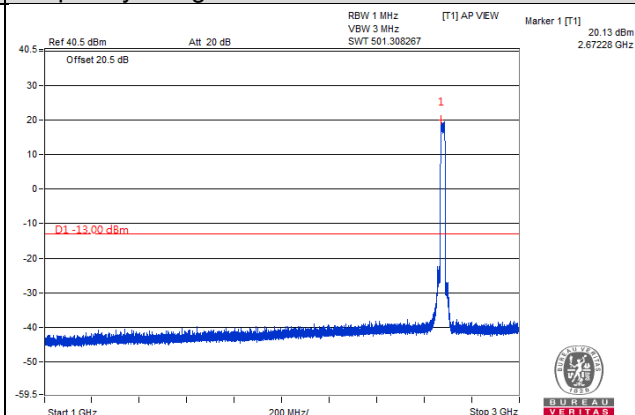

Frequency Range : 9kHz~1GHz

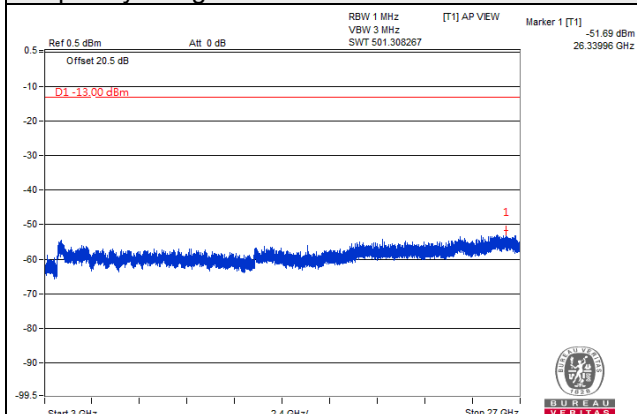

Frequency Range : 3GHz~27GHz

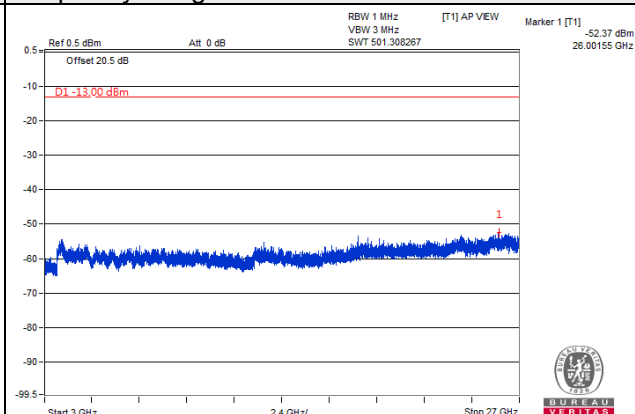

## 4.8 Radiated Emission Measurement

### 4.8.1 Limits of Radiated Emission Measurement

According to FCC 27.53(m)(2)(v) specified for all fixed digital user stations, the attenuation factor shall be not less than  $43 + 10 \log (P)$  dB at the channel edge.

### 4.8.2 Test Procedure

- a. The power was measured with R&S Spectrum Analyzer. All measurements were done at 3 channels (low, middle and high channel of operational frequency range.)
- b. Substitution method is used for E.I.R.P measurement. In the semi-anechoic chamber, EUT placed on the 0.8m height of Turn Table, rotated the table around 360 degrees to search the maximum radiation power and receiver antenna shall be rotated vertical and horizontal polarization and moved height from 1m to 4m to find the maximum polar radiated power. The "Read Value" is the spectrum reading the maximum power value.
- c. The substitution antenna is substituted for EUT at the same position and signals generator export the CW signal to the substitution antenna via a TX cable. Rotated the Turn Table and moved receiving antenna to find the maximum radiation power. Adjust output power level of S.G to get a Value of spectrum reading equal to "Read Value " of step b. Record the power level of S.G
- d.  $EIRP = \text{Output power level of S.G} - \text{TX cable loss} + \text{Antenna gain of substitution antenna}$ .

**NOTE:** The resolution bandwidth and video bandwidth of test receiver/spectrum analyzer is 1MHz/3MHz.

### 4.8.3 Deviation from Test Standard

No deviation.

#### 4.8.4 Test Setup

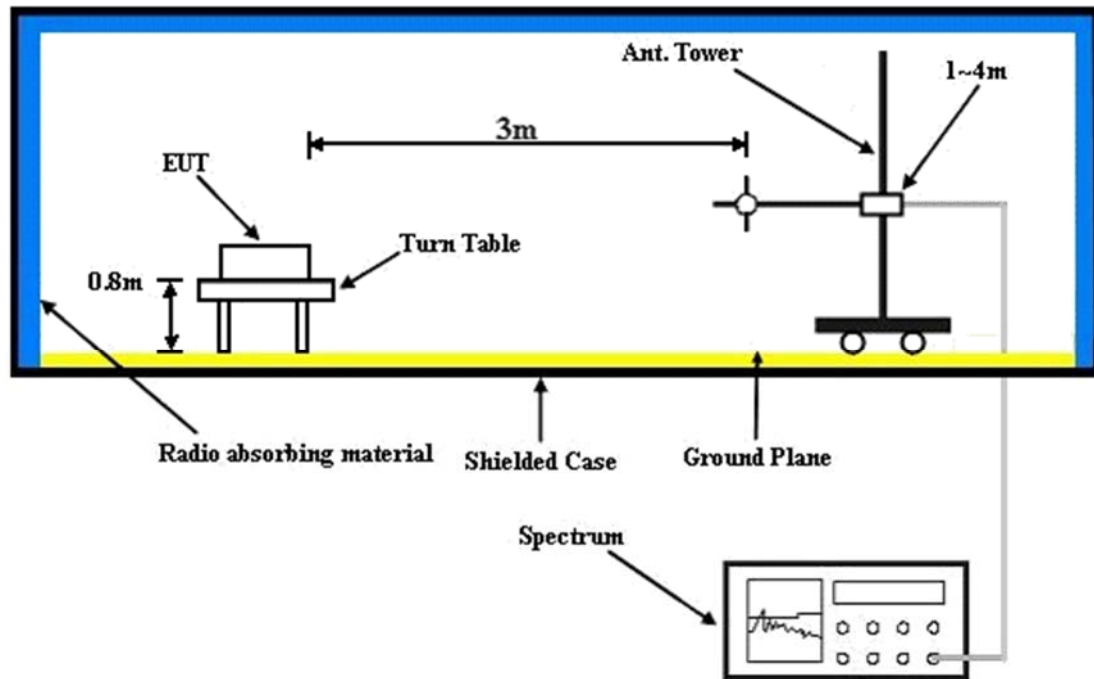

For the actual test configuration, please refer to the attached file (Test Setup Photo).



#### 4.8.5 Test Results

Below 1GHz

Mode	TX channel 40040 (2535MHz)	Frequency Range	Below 1000 MHz
Environmental Conditions	25deg. C, 76%RH	Input Power	120Vac, 60Hz
Tested By	Ian Chang		

Antenna Polarity & Test Distance: Horizontal at 3 M							
No.	Freq. (MHz)	Reading (dBm)	S.G Power Value (dBm)	Correction Factor (dB)	EIRP (dBm)	Limit (dBm)	Margin (dB)
1	59.22	-66.05	-84.66	14.37	-70.29	-13.00	-57.29
2	119.00	-54.49	-71.80	12.70	-59.10	-13.00	-46.10
3	183.62	-65.41	-83.29	13.26	-70.03	-13.00	-57.03
4	231.28	-57.67	-76.23	12.63	-63.60	-13.00	-50.60
5	294.32	-70.18	-89.07	16.08	-72.99	-13.00	-59.99
6	366.59	-62.11	-82.60	18.00	-64.60	-13.00	-51.60
7	404.30	-62.92	-83.62	18.97	-64.65	-13.00	-51.65
8	470.74	-68.67	-90.33	20.83	-69.50	-13.00	-56.50

Antenna Polarity & Test Distance: Vertical at 3 M							
No.	Freq. (MHz)	Reading (dBm)	S.G Power Value (dBm)	Correction Factor (dB)	EIRP (dBm)	Limit (dBm)	Margin (dB)
1	55.70	-54.75	-72.18	14.50	-57.68	-13.00	-44.68
2	117.18	-56.45	-73.10	12.52	-60.58	-13.00	-47.58
3	236.49	-64.05	-82.55	13.42	-69.13	-13.00	-56.13
4	370.23	-61.01	-81.27	18.16	-63.11	-13.00	-50.11
5	402.24	-66.32	-86.98	18.93	-68.05	-13.00	-55.05
6	499.96	-66.27	-88.38	21.41	-66.97	-13.00	-53.97

Remarks:

1. Output Power (dBm) = S.G Value (dBm) + Correction Factor (dB).
2. Correction Factor (dB) = Substitution Antenna Gain (dB) + Cable Loss (dB).

Mode	TX channel 41240 (2655MHz)	Frequency Range	Below 1000 MHz
Environmental Conditions	25deg. C, 76%RH	Input Power	120Vac, 60Hz
Tested By	Ian Chang		

Antenna Polarity & Test Distance: Horizontal at 3 M							
No.	Freq. (MHz)	Reading (dBm)	S.G Power Value (dBm)	Correction Factor (dB)	EIRP (dBm)	Limit (dBm)	Margin (dB)
1	58.01	-65.07	-83.35	14.41	-68.94	-13.00	-55.94
2	119.72	-55.02	-72.37	12.81	-59.56	-13.00	-46.56
3	183.62	-67.11	-84.99	13.26	-71.73	-13.00	-58.73
4	232.97	-55.82	-74.57	12.92	-61.65	-13.00	-48.65
5	295.30	-70.10	-89.03	16.11	-72.92	-13.00	-59.92
6	368.17	-61.06	-81.57	18.06	-63.51	-13.00	-50.51
7	404.18	-62.99	-83.69	18.97	-64.72	-13.00	-51.72
8	469.05	-69.21	-90.88	20.80	-70.08	-13.00	-57.08
9	515.85	-76.53	-98.44	21.86	-76.58	-13.00	-63.58

Antenna Polarity & Test Distance: Vertical at 3 M							
No.	Freq. (MHz)	Reading (dBm)	S.G Power Value (dBm)	Correction Factor (dB)	EIRP (dBm)	Limit (dBm)	Margin (dB)
1	56.31	-54.42	-72.04	14.47	-57.57	-13.00	-44.57
2	118.03	-56.44	-73.21	12.57	-60.64	-13.00	-47.64
3	235.03	-63.92	-82.50	13.27	-69.23	-13.00	-56.23
4	370.35	-61.67	-81.93	18.16	-63.77	-13.00	-50.77
5	399.81	-67.32	-87.93	18.87	-69.06	-13.00	-56.06
6	464.20	-71.64	-93.63	20.73	-72.90	-13.00	-59.90
7	499.96	-69.02	-91.13	21.41	-69.72	-13.00	-56.72
8	624.97	-74.68	-97.30	24.30	-73.00	-13.00	-60.00

Remarks:

1. Output Power (dBm) = S.G Value (dBm) + Correction Factor (dB).
2. Correction Factor (dB) = Substitution Antenna Gain (dB) + Cable Loss (dB).

ABOVE 1GHz

Mode	TX channel 39790 (2510MHz)	Frequency Range	Above 1000MHz
Environmental Conditions	25deg. C, 76%RH	Input Power	120Vac, 60Hz
Tested By	Ian Chang		

Antenna Polarity & Test Distance: Horizontal at 3 M							
No.	Freq. (MHz)	Reading (dBm)	S.G Power Value (dBm)	Correction Factor (dB)	EIRP (dBm)	Limit (dBm)	Margin (dB)
1	5019.37	-60.98	-101.09	45.93	-55.16	-13.00	-42.16
Antenna Polarity & Test Distance: Vertical at 3 M							
No.	Freq. (MHz)	Reading (dBm)	S.G Power Value (dBm)	Correction Factor (dB)	EIRP (dBm)	Limit (dBm)	Margin (dB)
1	5020.02	-58.23	-97.75	45.93	-51.82	-13.00	-38.82

Remarks:

1. Output Power (dBm) = S.G Value (dBm) + Correction Factor (dB).
2. Correction Factor (dB) = Substitution Antenna Gain (dB) + Cable Loss (dB).

Mode	TX channel 40040 (2535MHz)	Frequency Range	Above 1000MHz
Environmental Conditions	25deg. C, 76%RH	Input Power	120Vac, 60Hz
Tested By	Ian Chang		

Antenna Polarity & Test Distance: Horizontal at 3 M							
No.	Freq. (MHz)	Reading (dBm)	S.G Power Value (dBm)	Correction Factor (dB)	EIRP (dBm)	Limit (dBm)	Margin (dB)
1	5070.02	-59.57	-99.82	46.14	-53.68	-13.00	-40.68
Antenna Polarity & Test Distance: Vertical at 3 M							
No.	Freq. (MHz)	Reading (dBm)	S.G Power Value (dBm)	Correction Factor (dB)	EIRP (dBm)	Limit (dBm)	Margin (dB)
1	5070.05	-55.48	-95.15	46.14	-49.01	-13.00	-36.01

Remarks:

1. Output Power (dBm) = S.G Value (dBm) + Correction Factor (dB).
2. Correction Factor (dB) = Substitution Antenna Gain (dB) + Cable Loss (dB).

Mode	TX channel 40290 (2560MHz)	Frequency Range	Above 1000MHz
Environmental Conditions	25deg. C, 76%RH	Input Power	120Vac, 60Hz
Tested By	Ian Chang		

Antenna Polarity & Test Distance: Horizontal at 3 M							
No.	Freq. (MHz)	Reading (dBm)	S.G Power Value (dBm)	Correction Factor (dB)	EIRP (dBm)	Limit (dBm)	Margin (dB)
1	5119.96	-57.03	-97.38	46.37	-51.01	-13.00	-38.01
Antenna Polarity & Test Distance: Vertical at 3 M							
No.	Freq. (MHz)	Reading (dBm)	S.G Power Value (dBm)	Correction Factor (dB)	EIRP (dBm)	Limit (dBm)	Margin (dB)
1	5121.40	-54.72	-94.48	46.37	-48.11	-13.00	-35.11

Remarks:

1. Output Power (dBm) = S.G Value (dBm) + Correction Factor (dB).
2. Correction Factor (dB) = Substitution Antenna Gain (dB) + Cable Loss (dB).

Mode	TX channel 40990 (2630MHz)	Frequency Range	Above 1000MHz
Environmental Conditions	25deg. C, 76%RH	Input Power	120Vac, 60Hz
Tested By	Ian Chang		

Antenna Polarity & Test Distance: Horizontal at 3 M							
No.	Freq. (MHz)	Reading (dBm)	S.G Power Value (dBm)	Correction Factor (dB)	EIRP (dBm)	Limit (dBm)	Margin (dB)
1	5259.99	-57.65	-97.61	46.69	-50.92	-13.00	-37.92
Antenna Polarity & Test Distance: Vertical at 3 M							
No.	Freq. (MHz)	Reading (dBm)	S.G Power Value (dBm)	Correction Factor (dB)	EIRP (dBm)	Limit (dBm)	Margin (dB)
1	5259.95	-54.58	-94.00	46.69	-47.31	-13.00	-34.31

Remarks:

1. Output Power (dBm) = S.G Value (dBm) + Correction Factor (dB).
2. Correction Factor (dB) = Substitution Antenna Gain (dB) + Cable Loss (dB).

Mode	TX channel 41240 (2655MHz)	Frequency Range	Above 1000MHz
Environmental Conditions	25deg. C, 76%RH	Input Power	120Vac, 60Hz
Tested By	Ian Chang		

Antenna Polarity & Test Distance: Horizontal at 3 M							
No.	Freq. (MHz)	Reading (dBm)	S.G Power Value (dBm)	Correction Factor (dB)	EIRP (dBm)	Limit (dBm)	Margin (dB)
1	5310.09	-58.35	-97.80	46.47	-51.33	-13.00	-38.33
Antenna Polarity & Test Distance: Vertical at 3 M							
No.	Freq. (MHz)	Reading (dBm)	S.G Power Value (dBm)	Correction Factor (dB)	EIRP (dBm)	Limit (dBm)	Margin (dB)
<b>1</b>	<b>5310.46</b>	<b>-54.72</b>	<b>-93.68</b>	<b>46.47</b>	<b>-47.21</b>	<b>-13.00</b>	<b>-34.21</b>

Remarks:

1. Output Power (dBm) = S.G Value (dBm) + Correction Factor (dB).
2. Correction Factor (dB) = Substitution Antenna Gain (dB) + Cable Loss (dB).

Mode	TX channel 41490 (2680MHz)	Frequency Range	Above 1000MHz
Environmental Conditions	25deg. C, 76%RH	Input Power	120Vac, 60Hz
Tested By	Ian Chang		

Antenna Polarity & Test Distance: Horizontal at 3 M							
No.	Freq. (MHz)	Reading (dBm)	S.G Power Value (dBm)	Correction Factor (dB)	EIRP (dBm)	Limit (dBm)	Margin (dB)
1	5359.85	-58.01	-97.34	46.69	-50.65	-13.00	-37.65
Antenna Polarity & Test Distance: Vertical at 3 M							
No.	Freq. (MHz)	Reading (dBm)	S.G Power Value (dBm)	Correction Factor (dB)	EIRP (dBm)	Limit (dBm)	Margin (dB)
1	5358.37	-55.91	-94.80	46.68	-48.12	-13.00	-35.12

Remarks:

1. Output Power (dBm) = S.G Value (dBm) + Correction Factor (dB).
2. Correction Factor (dB) = Substitution Antenna Gain (dB) + Cable Loss (dB).

## 5 Pictures of Test Arrangements

Please refer to the attached file (Test Setup Photo).

## Appendix – Information on the Testing Laboratories

We, Bureau Veritas Consumer Products Services (H.K.) Ltd., Taoyuan Branch, were founded in 1988 to provide our best service in EMC, Radio, Telecom and Safety consultation. Our laboratories are FCC recognized accredited test firms and accredited according to ISO/IEC 17025.

If you have any comments, please feel free to contact us at the following:

**Linkou EMC/RF Lab**

Tel: 886-2-26052180

Fax: 886-2-26051924

**Hsin Chu EMC/RF/Telecom Lab**

Tel: 886-3-6668565

Fax: 886-3-6668323

**Hwa Ya EMC/RF/Safety Lab**

Tel: 886-3-3183232

Fax: 886-3-3270892

**Email:** [service.adt@tw.bureauveritas.com](mailto:service.adt@tw.bureauveritas.com)

**Web Site:** [www.bureauveritas-adt.com](http://www.bureauveritas-adt.com)

The address and road map of all our labs can be found in our web site also.

--- END ---