

Figure 9
Inside of the EUT

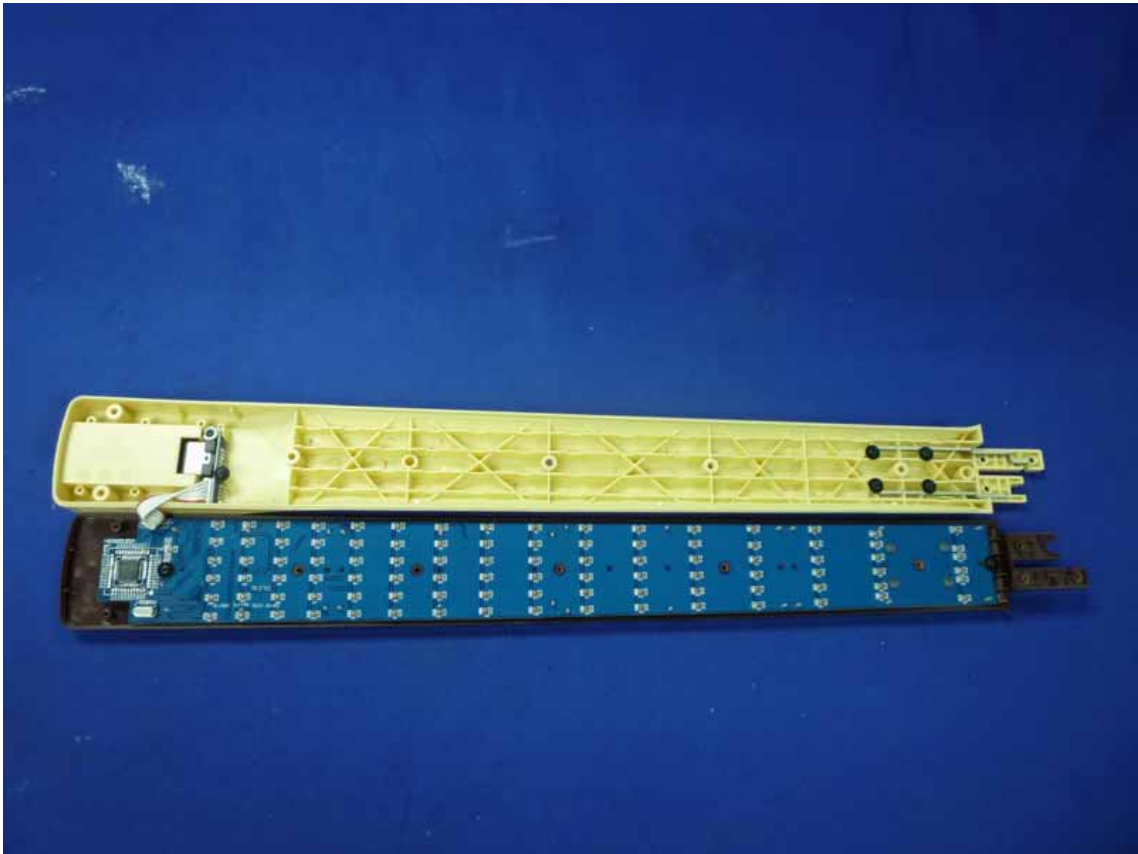

Figure 10
Inside of the EUT

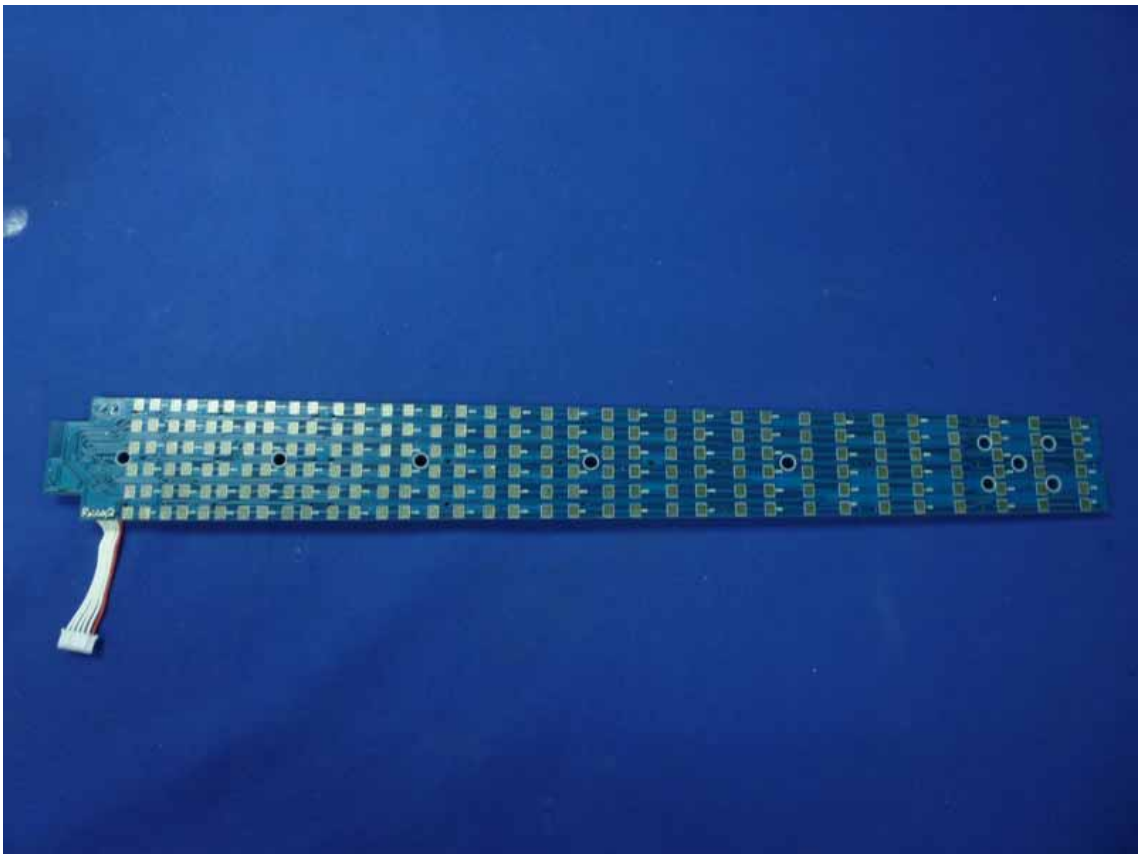

Figure 11
Inside of the EUT

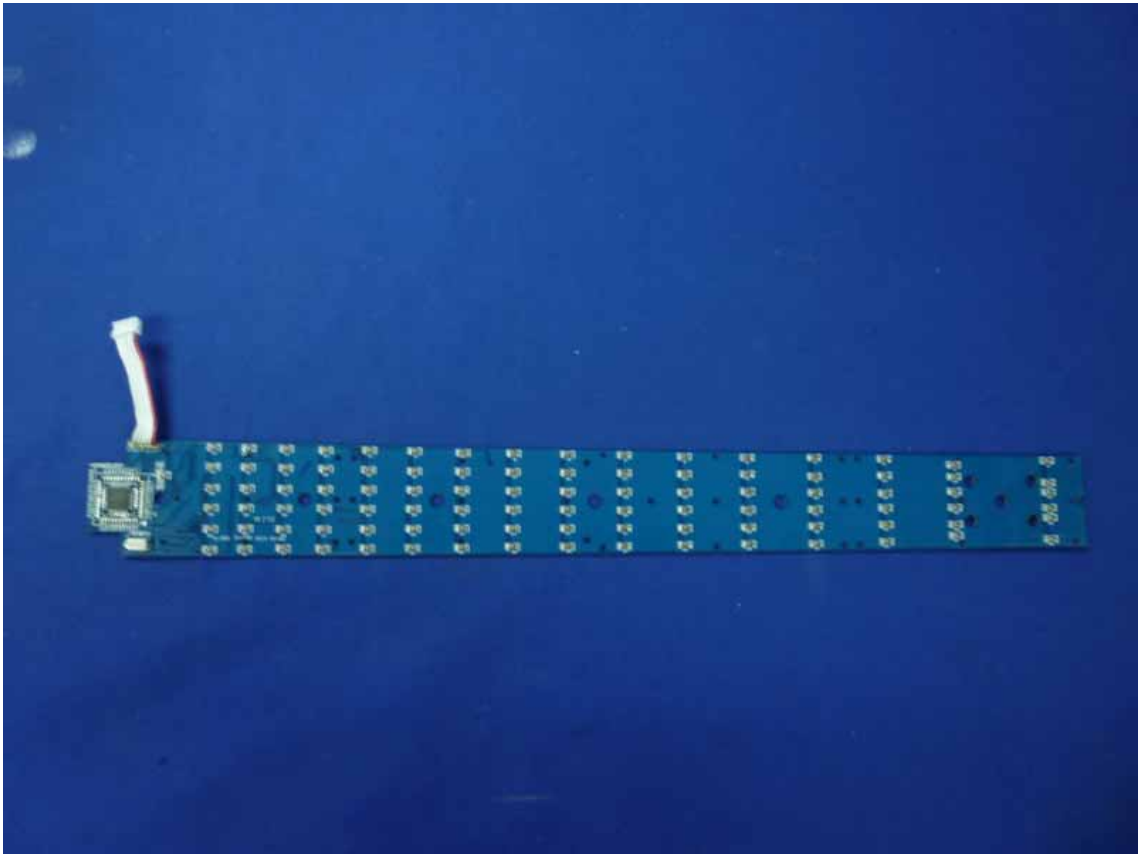

Figure 12
Inside of the EUT

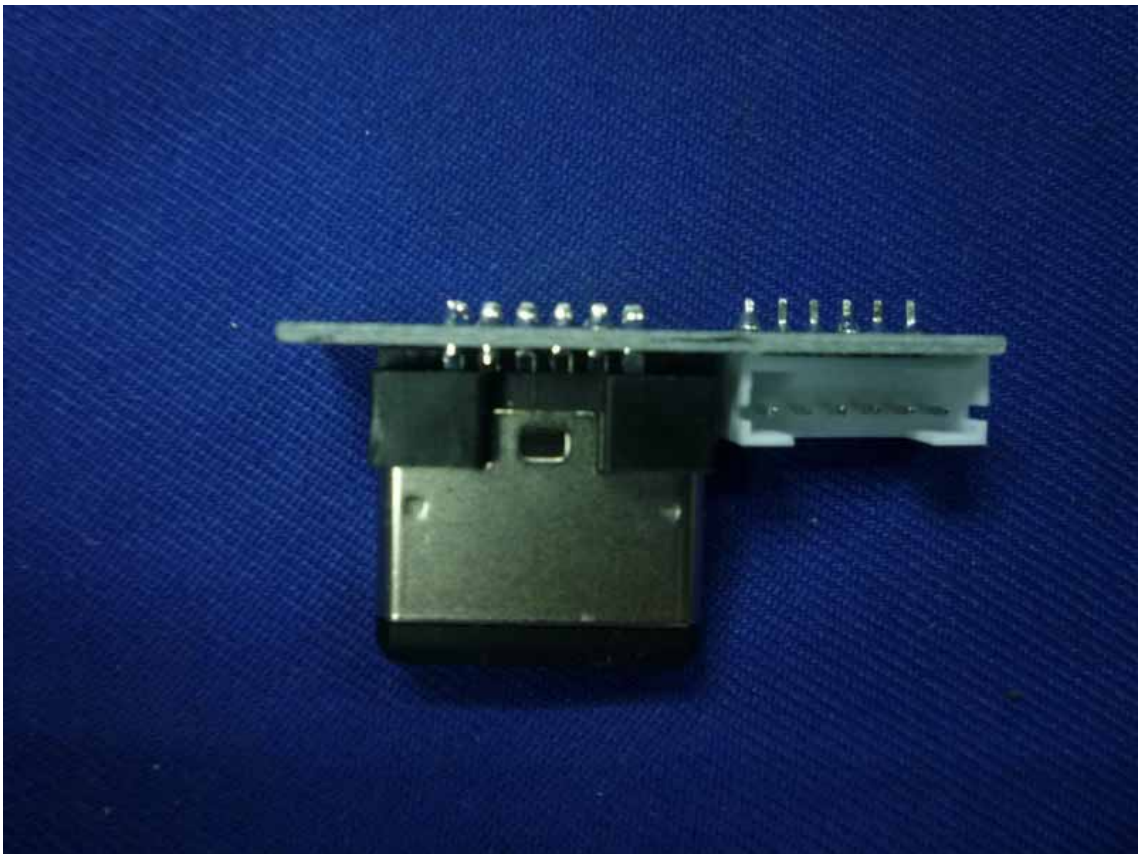

Figure 13
Inside of the EUT

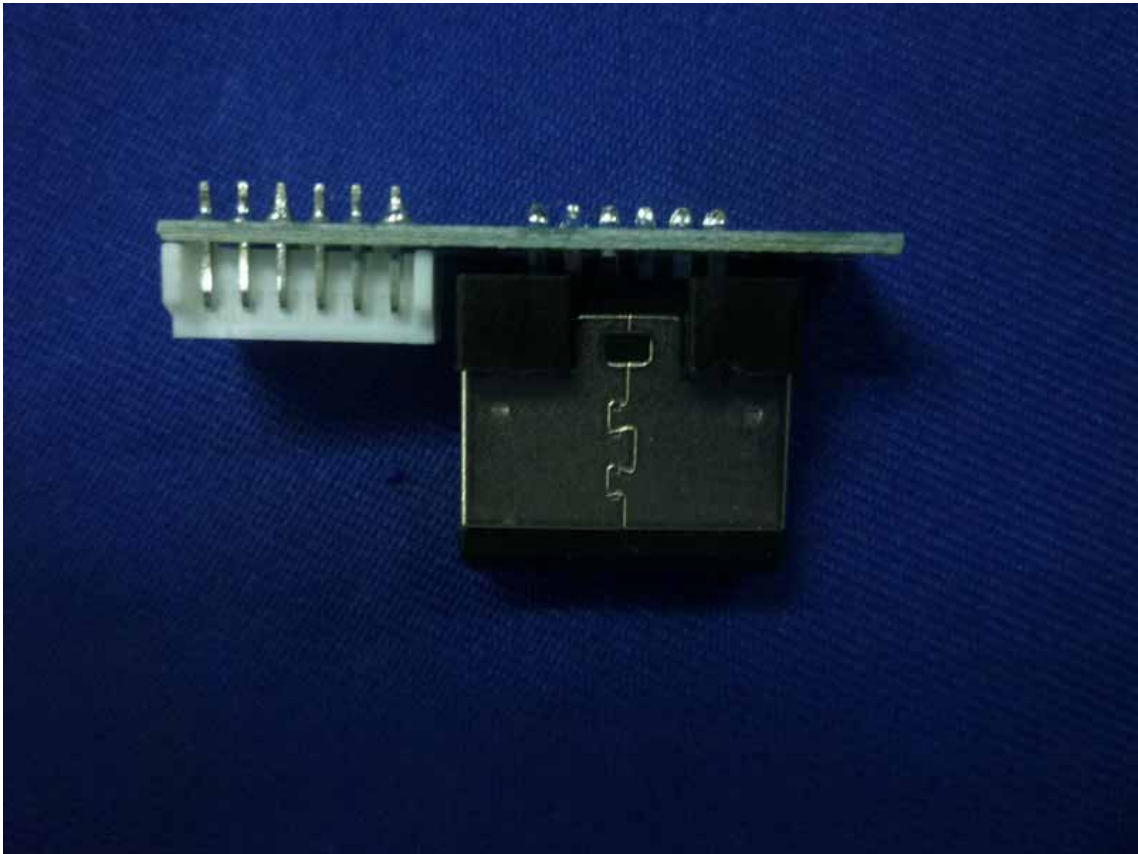

Figure 14
Inside of the EUT



Figure 15
Inside of the EUT

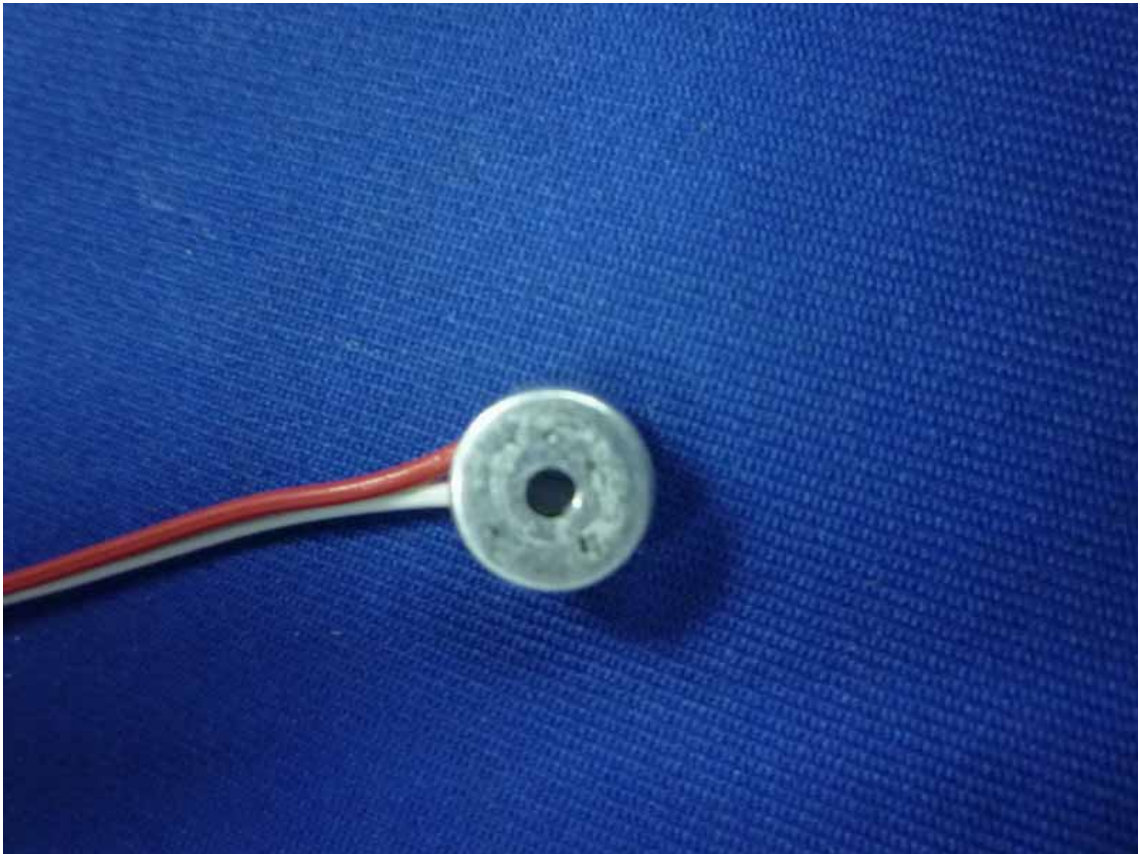

Figure 16
Inside of the EUT

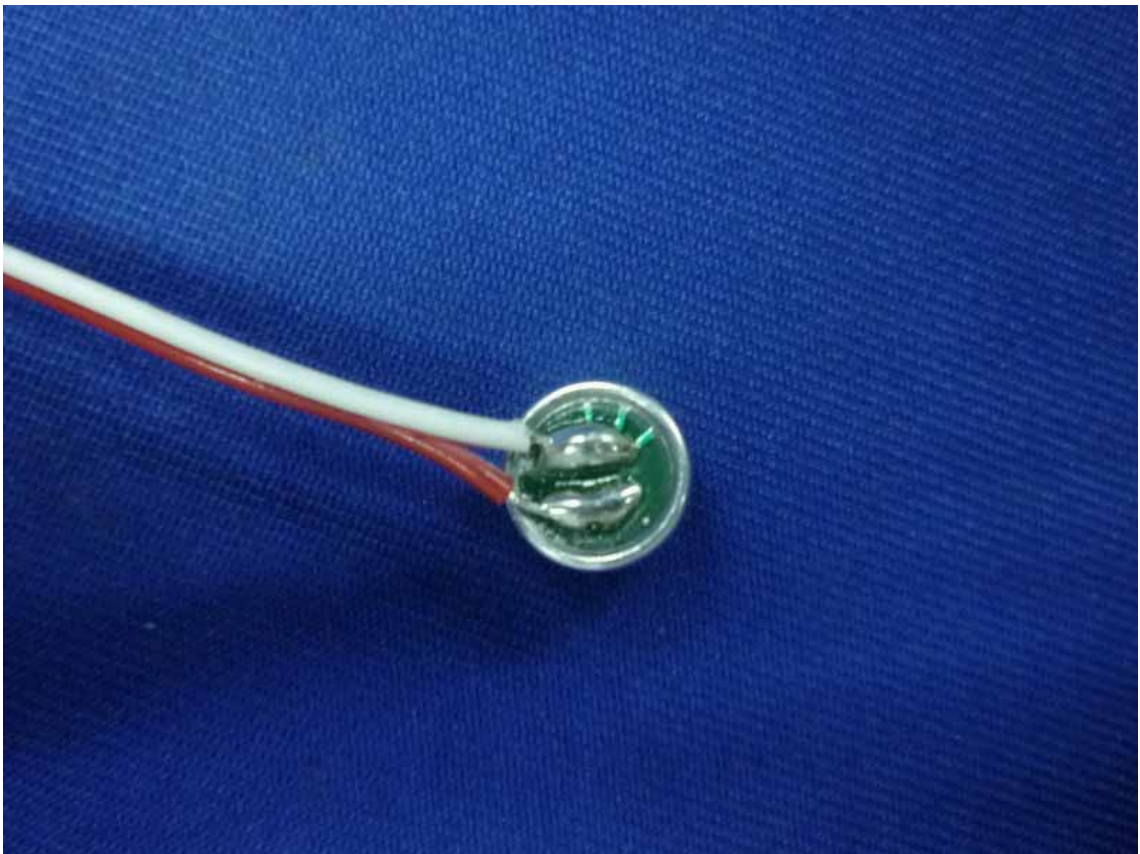

Figure 17
Inside of the EUT



Figure 18
Inside of the EUT

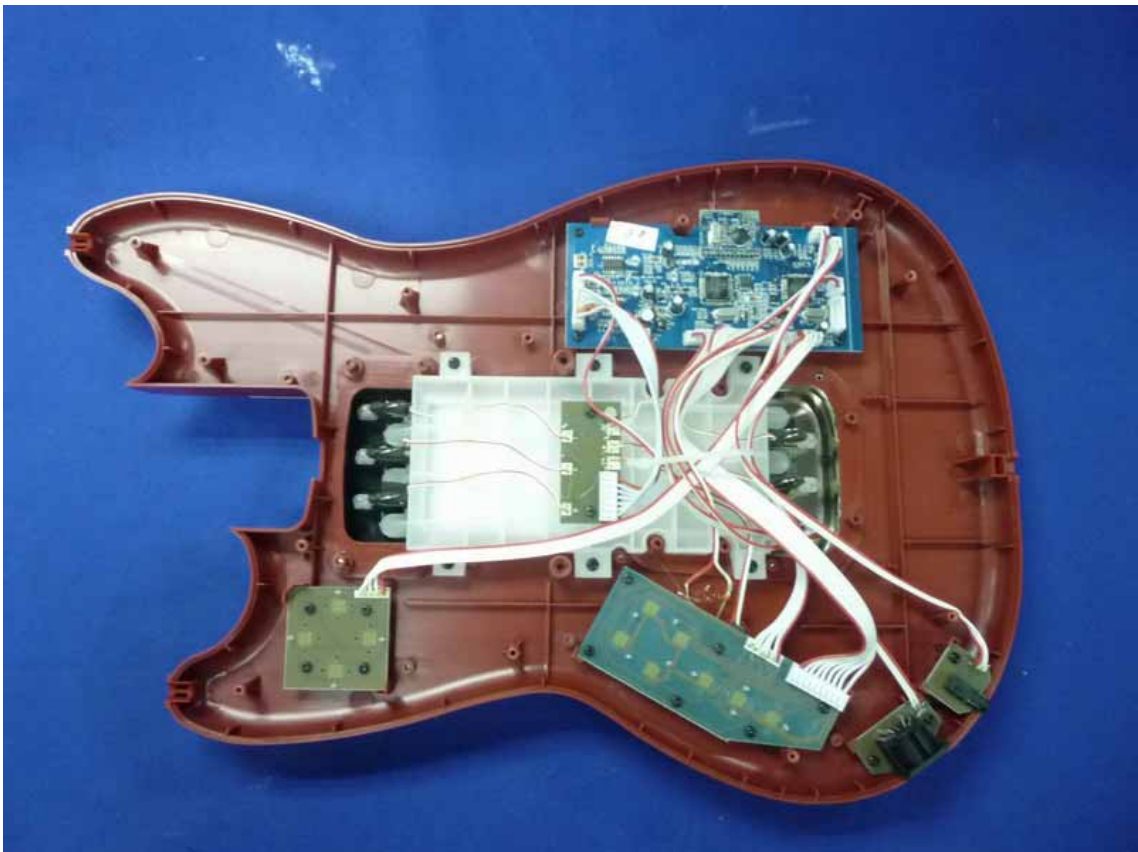

Figure 19
Inside of the EUT

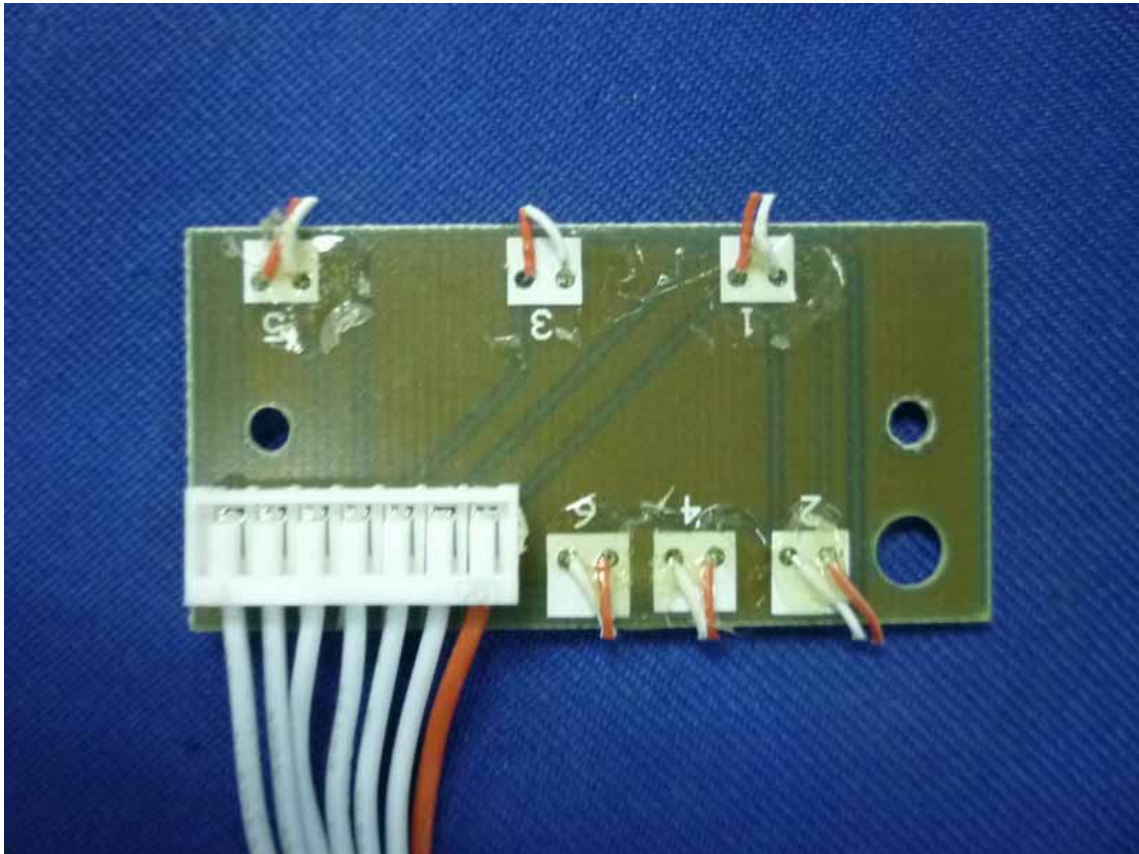

Figure 20
Inside of the EUT

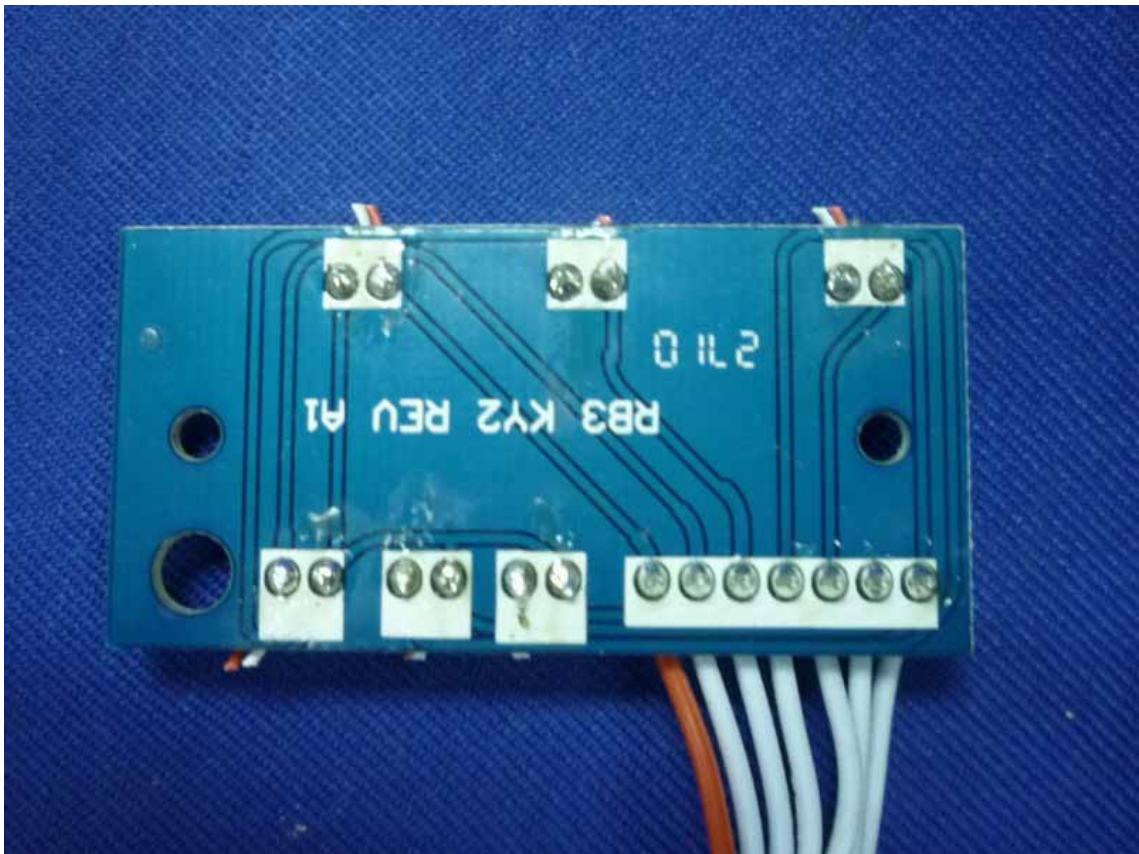

Figure 21
Inside of the EUT

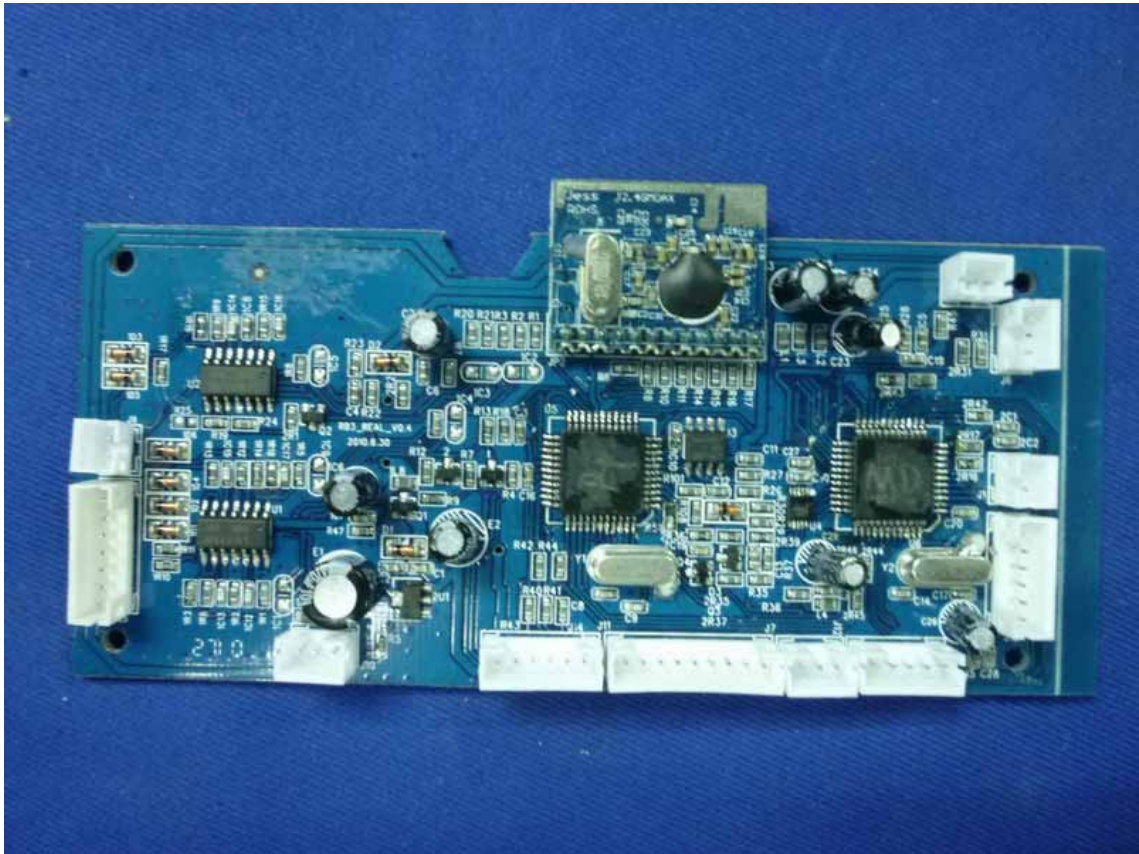

Figure 22
Inside of the EUT

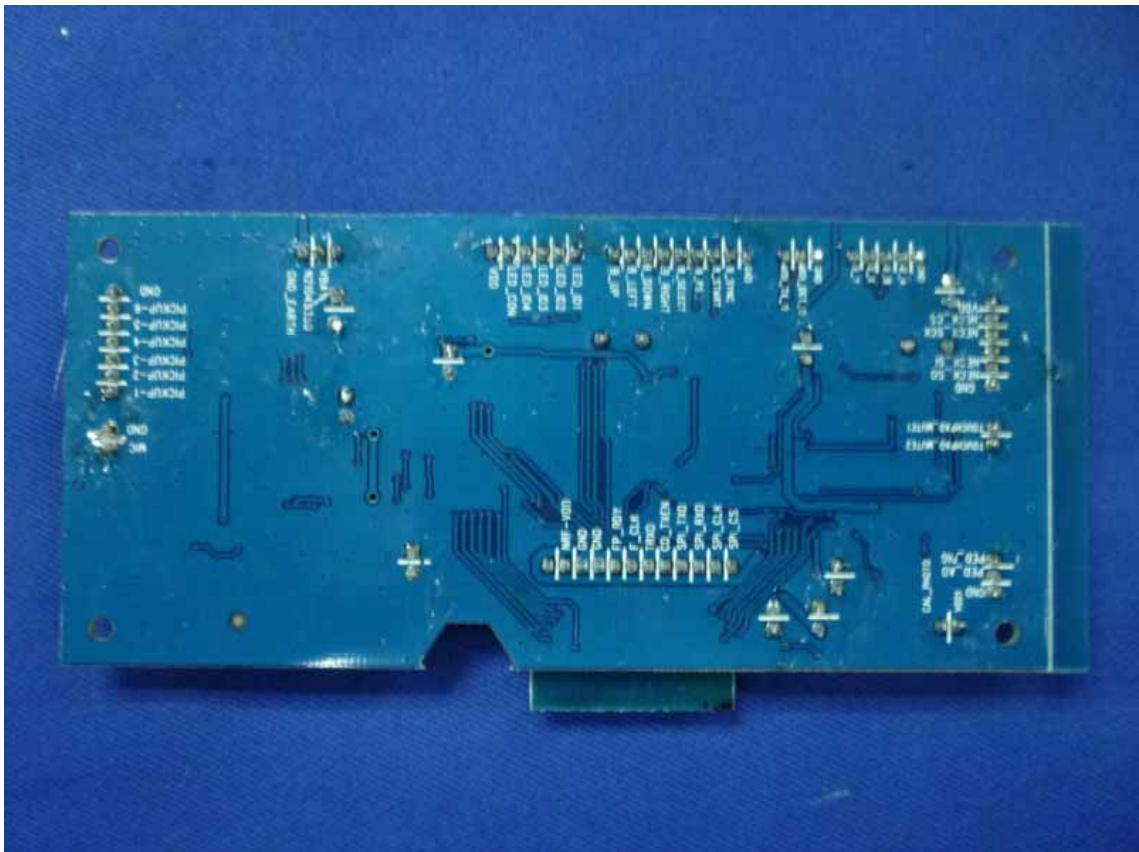

Figure 23
Inside of the EUT

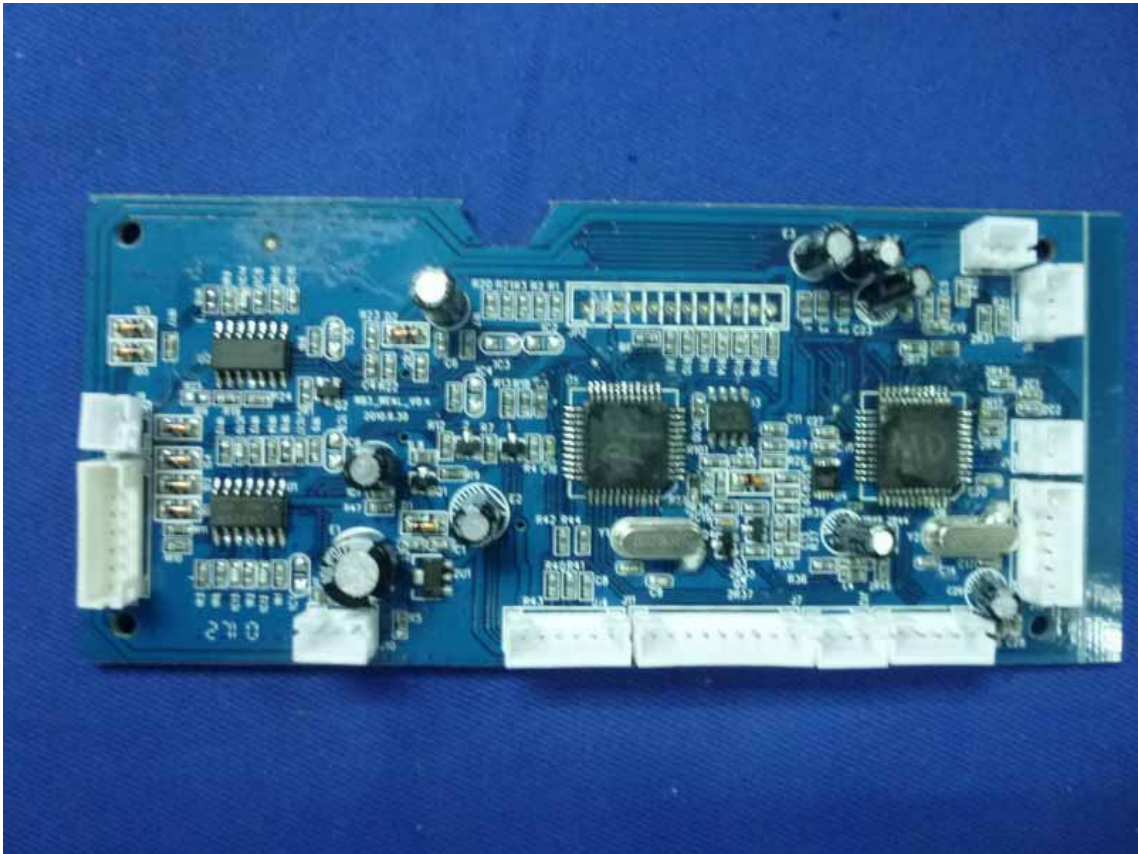

Figure 24
Inside of the EUT

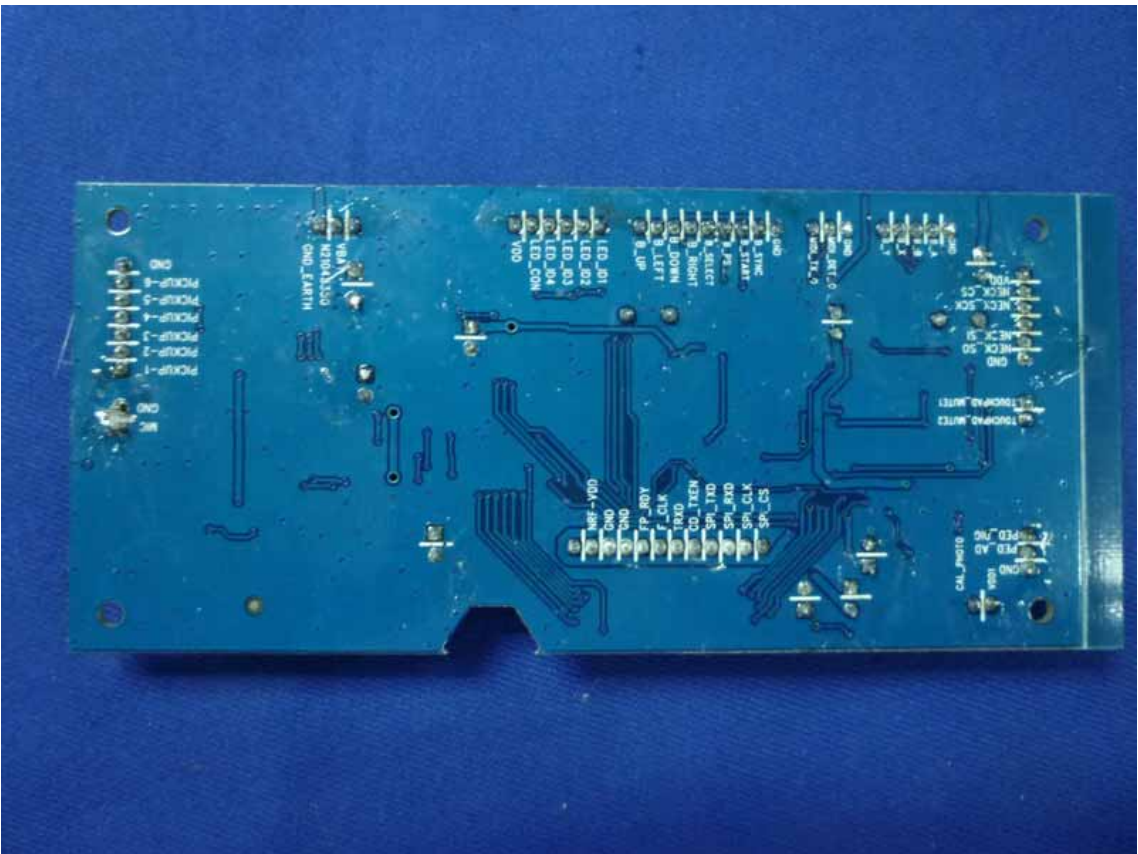

Figure 25
Inside of the EUT

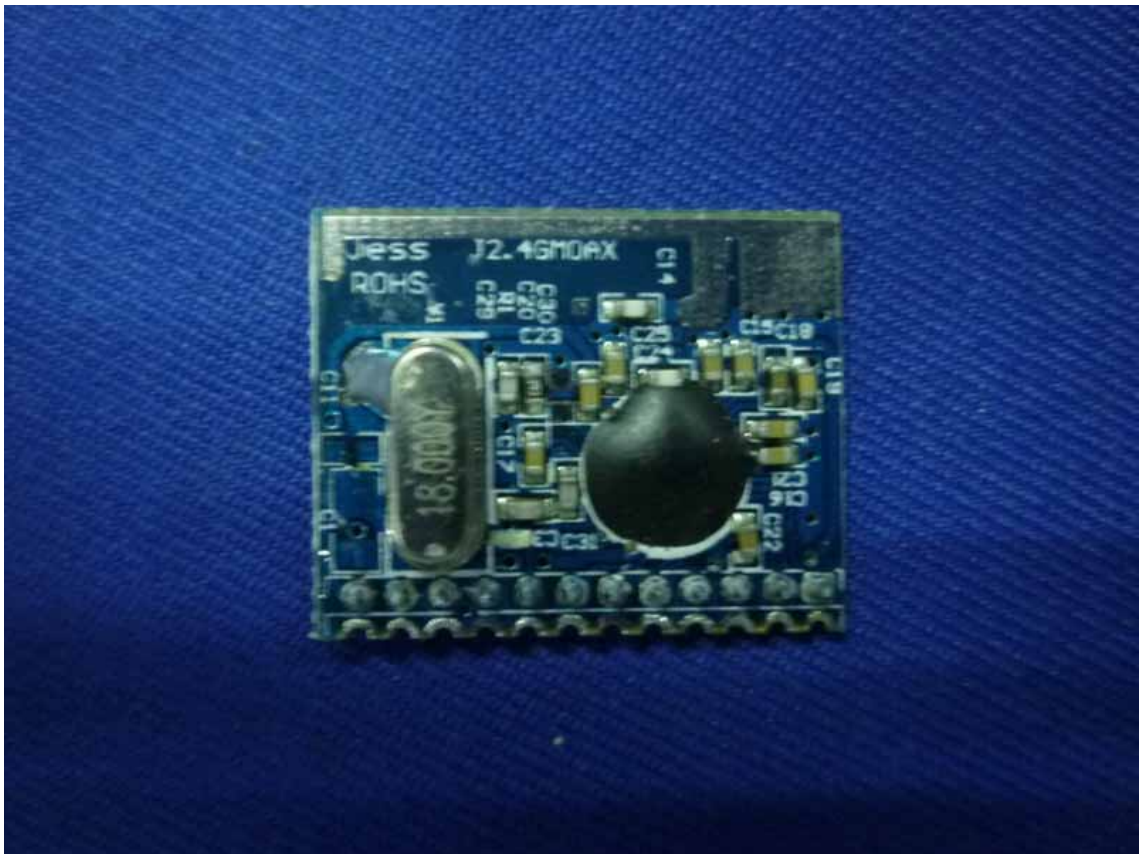

Figure 26
Inside of the EUT



Figure 27
Inside of the EUT

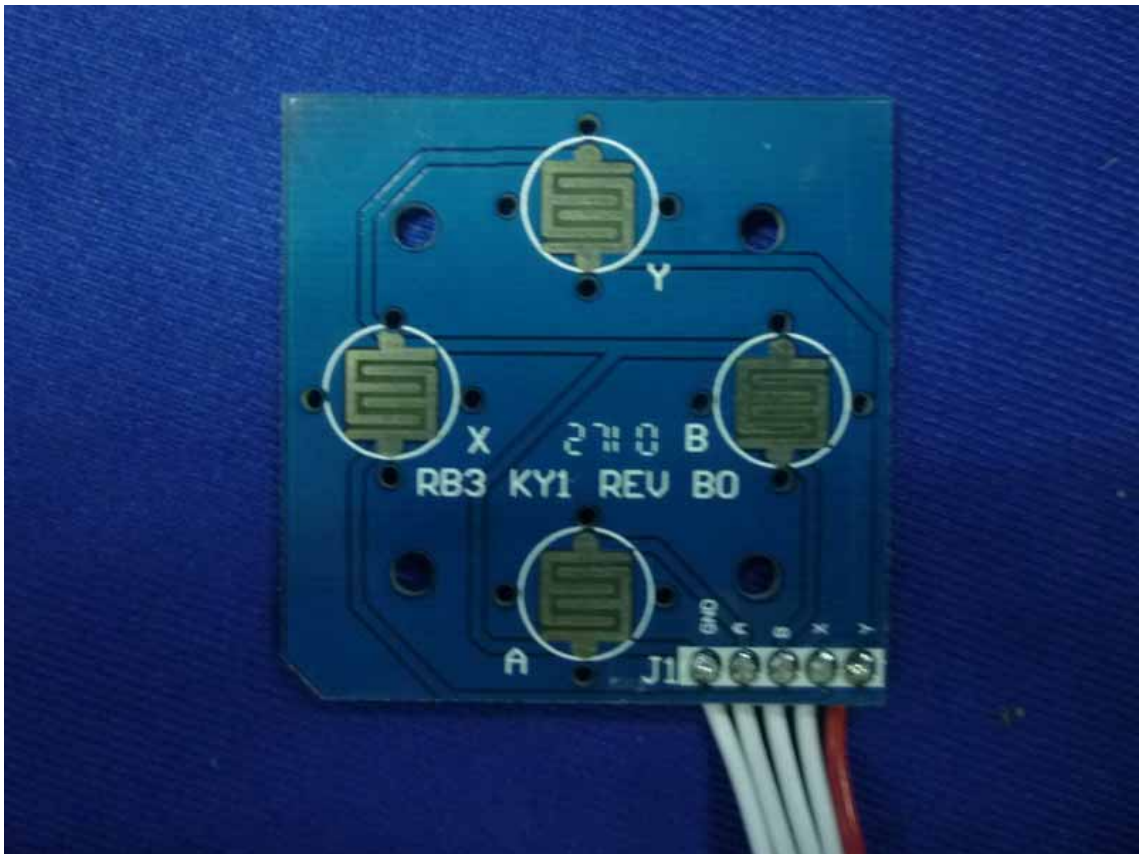

Figure 28
Inside of the EUT

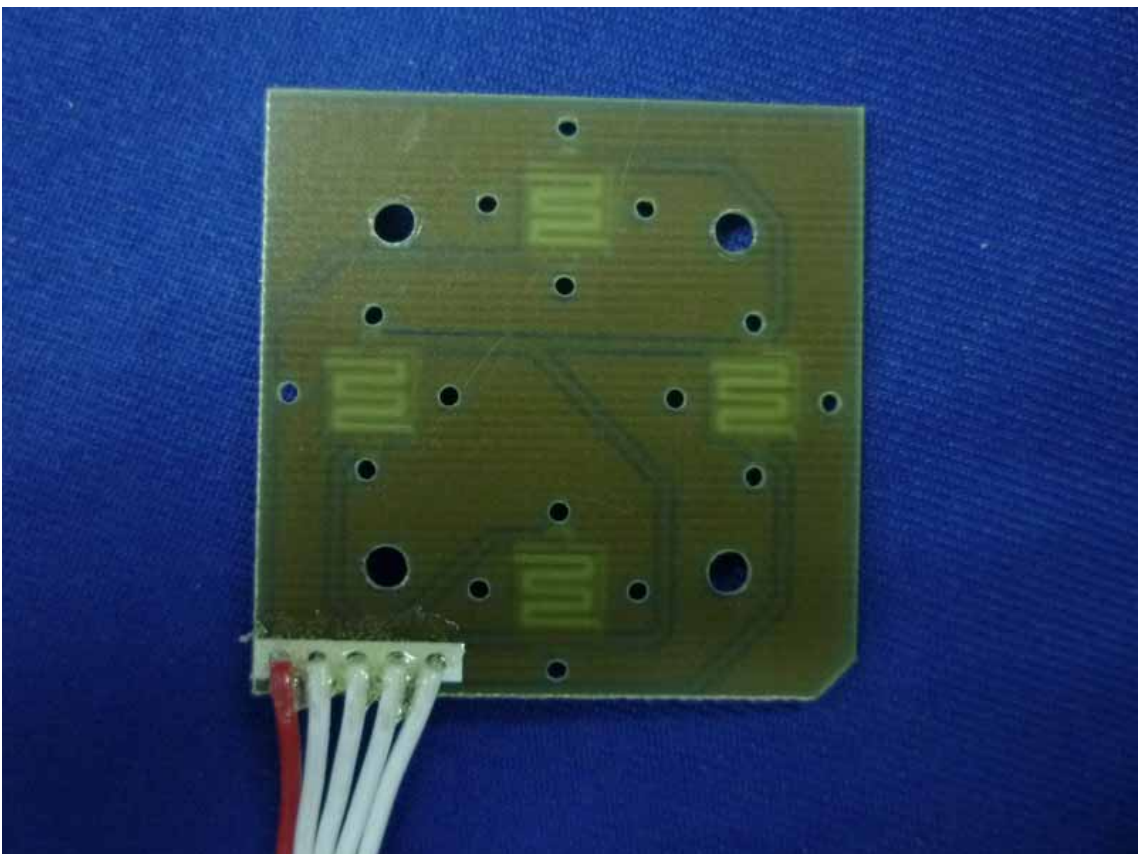

Figure 29
Inside of the EUT

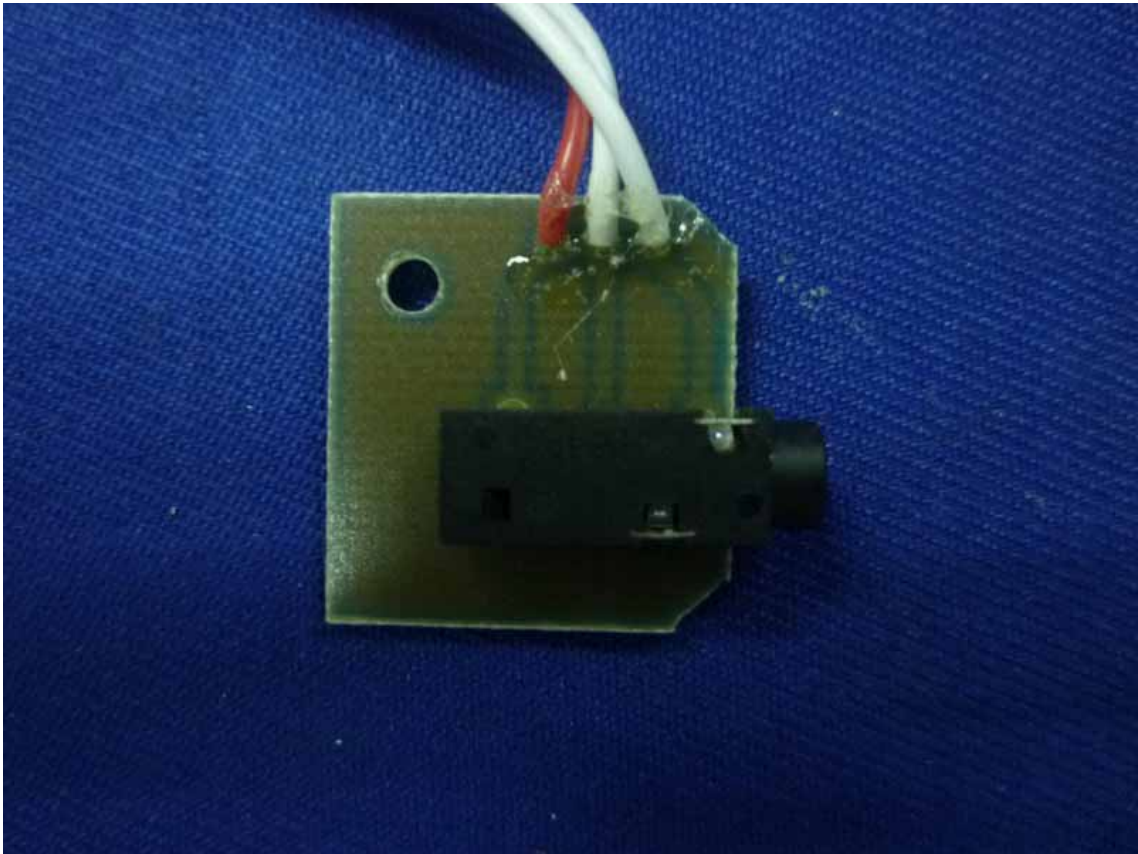

Figure 30
Inside of the EUT

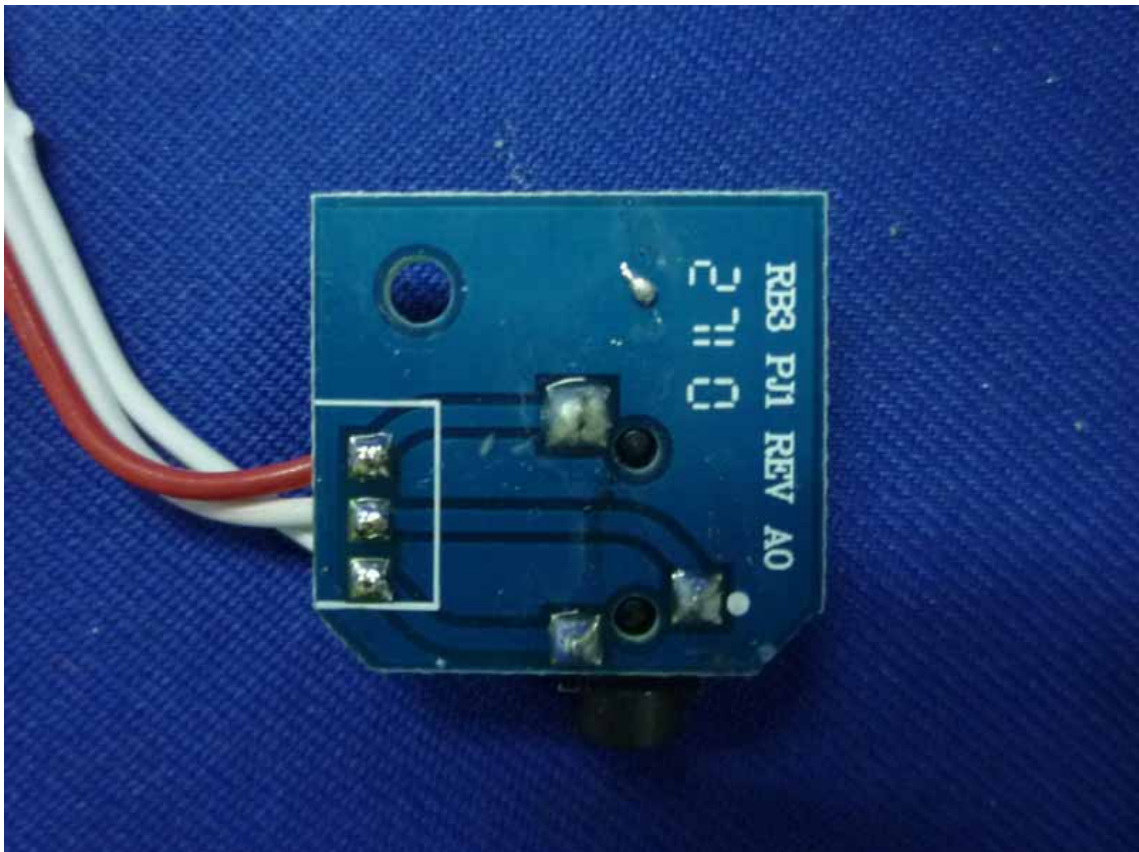

Figure 31
Inside of the EUT

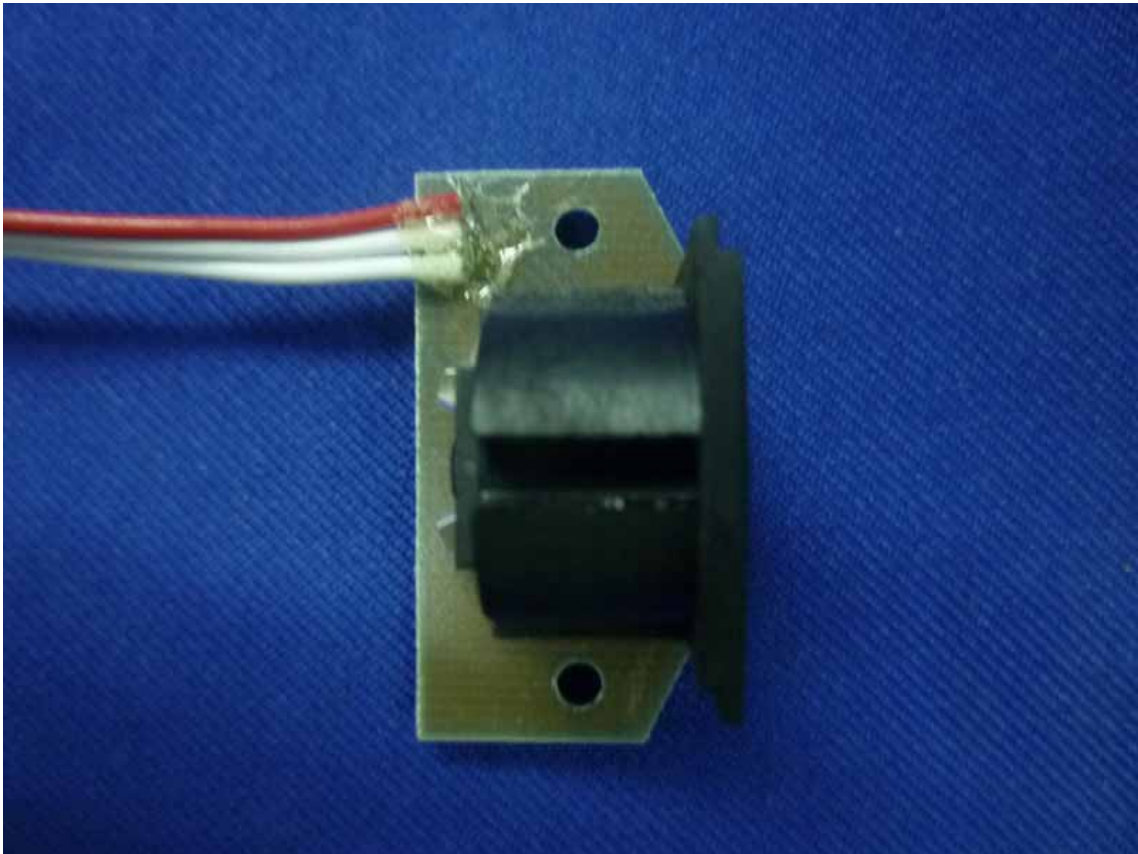

Figure 32
Inside of the EUT

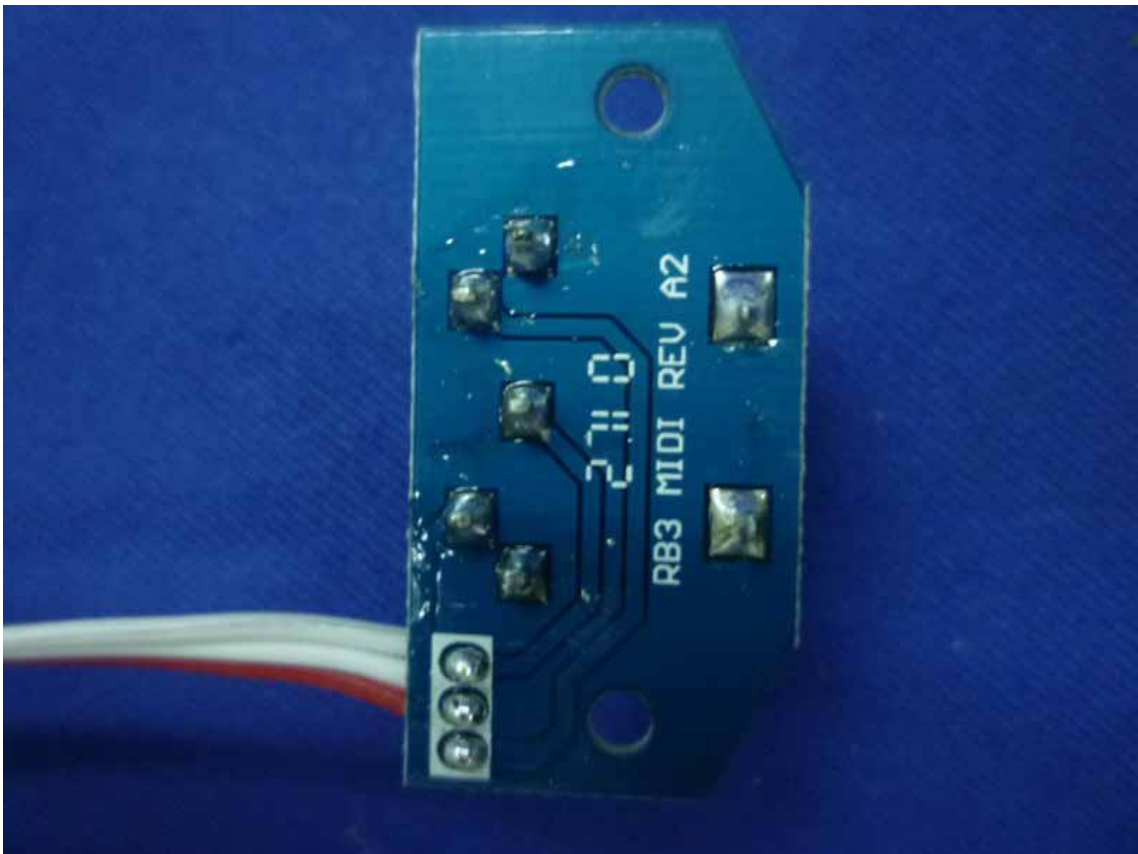

Figure 33
Inside of the EUT

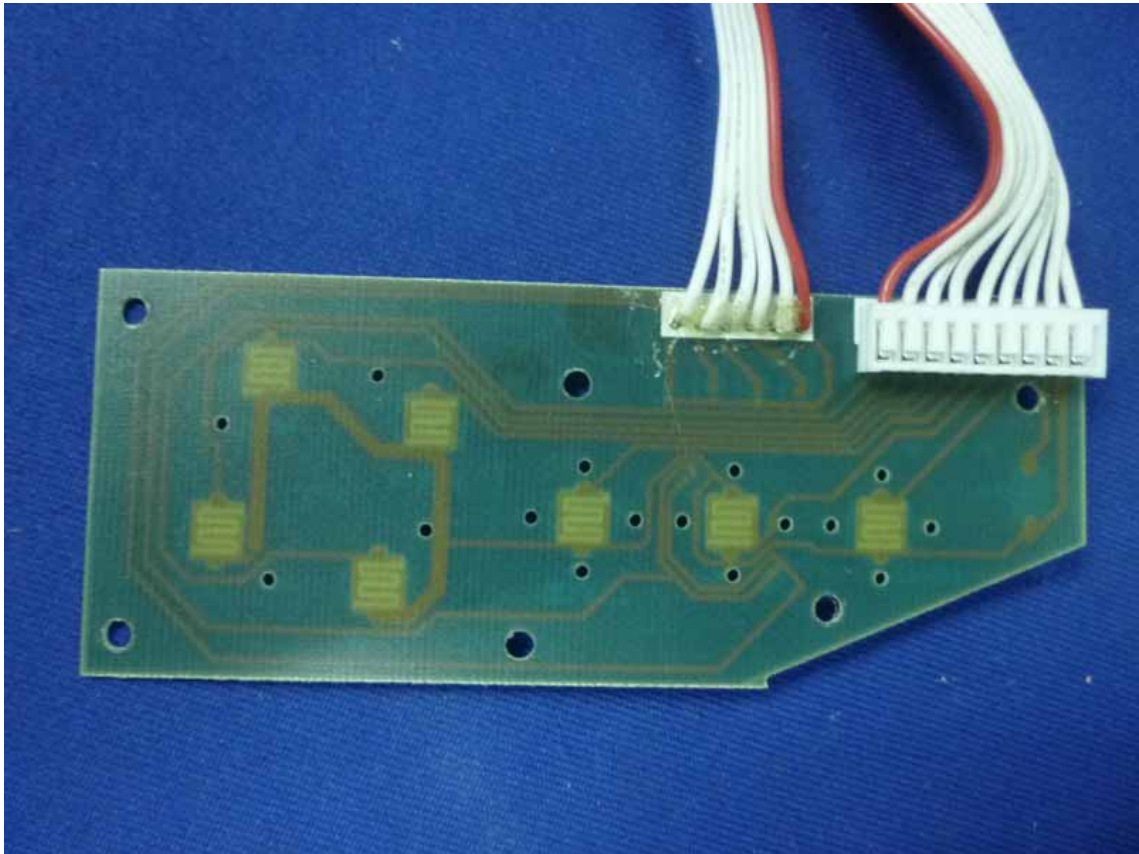

Figure 34
Inside of the EUT

