

# Atlas Compliance & Engineering, Inc.

## FCC Test Report

**FCC CFR 47 Part 15.209 and 15.249 COMPLIANCE**

• • • • • • • • • •

*Mad Catz Interactive Inc.  
7480 Mission Valley Rd. Suite 101  
San Diego, CA 92108 USA*

*Product:  
XBox 2.4 GHz RF Controller Joypad  
Model:  
4556S*

FCC ID: P25CPMC4556D1904C  
Test Report Number: 0424MDC4556Sc\_subc  
Date of Report: June 11, 2004

This report contains 31 pages and may be reproduced in full only.  
Partial reproduction may only be done with the written consent of  
Atlas Compliance & Engineering, Inc.



## Table of Contents

Table of Contents .....	2
General Information .....	3
Test Equipment.....	4
Block Diagram .....	5
Test Configuration.....	6
EUT Description / Note:.....	6
EUT Support Program.....	6
EUT Modifications for Compliance .....	6
EUT Support Devices.....	7
I/O Ports and Cables.....	7
Equipment Under Test.....	8
Equipment Block Diagram .....	15
Test Setup (Radiated Emissions).....	16
Test Methods for Emissions .....	21
Conducted Emission Testing.....	21
Temperature and Humidity.....	22
Sample Calculations .....	22
FCC Part 15 Subpart C 15.207 and 15.209 Limits .....	23
Report of Measurements 15.249 Radiated Data .....	25
Part 15.249 Setup .....	26
Frequency Hopping System.....	27
Frequency Separation .....	28
20dB Bandwidth Measurement .....	29
Report of Measurements 15.209 Radiated Data .....	30
COMPLIANCE VERIFICATION REPORT .....	31
Table 1 - Support Equipment Used For Test .....	7
Table 2 - EUT Port Termination's.....	7
Table 3 - Host Port Termination's.....	7
Table 4 - Radiated Emission Limits, General Requirements.....	23
Table 5 - Radiated Emission Limits, Operation within the bands 902 – 928 MHz, 2400 – 2483.5 MHz, 5725 – 5875 MHz, and 24.0 – 24.25 GHz.....	24
Table 6 - Radiated Emission Level.....	25
Table 7 - Radiated Emission Level Below 30 MHz .....	30
Table 8 - Radiated Emission Level Below 2000 MHz .....	30
Figure 1 - Test Setup Diagram .....	15

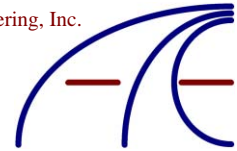

## General Information

Test Report Number: 0424MDC4556Sc\_subc  
Date Product Tested: April 19 - 25, 2004  
Date of Report: June 11, 2004  
Applicant: Mad Catz Interactive Inc.  
7480 Mission Valley Rd. Suite 101  
San Diego, CA 92108 USA  
Contact Person: Dave Preller  
Equipment Tested: XBox 2.4 GHz RF Controller Joypad  
Trade Name: 4556S Joypad  
Model: 4556S  
Purpose Of Test: To demonstrate the compliance of the XBox 2.4 GHz RF Controller Joypad, 4556S, with the requirements of FCC CFR 47 Part 15 Rules and Regulations to the limits of Subpart C, 15.209 and 15.249 using the procedure stated in ANSI C63.4-1992.  
Frequency Range Investigated: 8 MHz to 22,000 MHz  
FCC ID: P25CPMC4556D1904C  
Test Site Locations: Field Strength Measurement Facility:  
Atlas Compliance & Engineering, Inc.  
726 Hidden Valley Road  
Royal Oaks, California 95076  
Test Personnel: Mario E. Baraona Sr.  
EMC Engineer

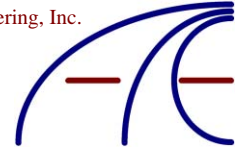

## Test Equipment

The following list contains the test equipment that was utilized in making the measurements in this report.

Description _ Model	Serial	Manufacturer	Calibrated	Calibration Due
BiLog Antenna_CBL6141	4034	Chase/Schaffner	7/6/03	7/6/04
Horn Antenna _ 3115	9003-3340	EMCO	1/23/04	1/23/05
Active Loop Antenna_ 6502	9108-2669	EMCO	12/13/03	12/13/04
Pre amp 9 kHz – 2 GHz _ CPA9231A	3323	Schaffner	5/20/04	5/20/05
Pre amp 1 – 26.5 GHz _ 8449B	3008A00910	HP	5/20/04	5/20/05
EMI Test Receiver 9 kHz - 2500 MHz _ ESPC	DE15934	Rohde & Schwarz	6/11/03	6/11/04
EMI Test Receiver 9 kHz - 2500 MHz _ ESPC	DE14459	Rohde & Schwarz	11/29/03	11/29/04
EMI Receiver 100 Hz – 22 GHz _ 8566B	2542A13058 (IF) 2637A03426 (RF)	HP	5/20/04	5/20/05

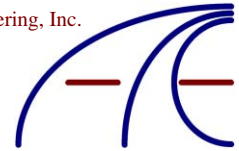

## Block Diagram

### 1. Controller side

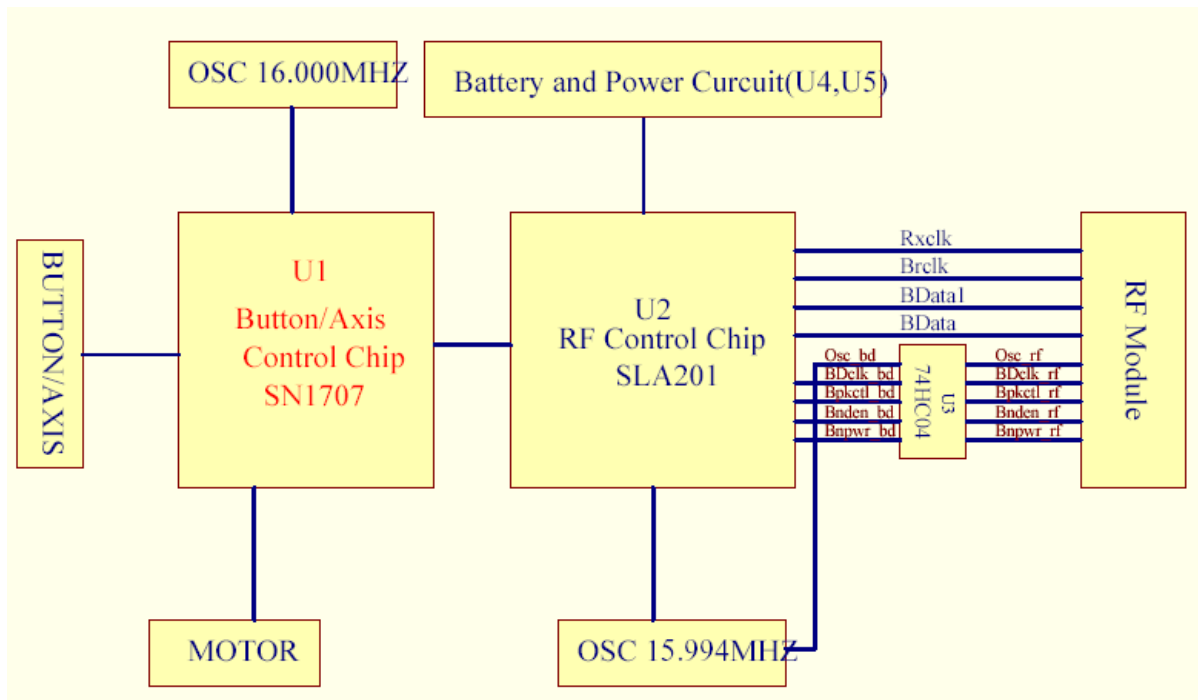

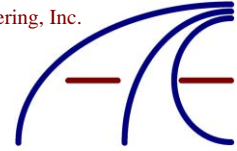

## Test Configuration

Customer: Mad Catz Interactive Inc.  
Test Date: April 19 - 25, 2004  
Specification: FCC CRF 47 Part 15.207 and 15.247  
Limits, ANSI C63.4-1992 Methods

### EUT Description / Note:

The EUT, 4556S, a XBox 2.4 GHz RF Controller Joypad, was powered up and in a continuous transmitting mode. The EUT is powered through the host game console. EUT frequencies of operation are 2401 MHz to 2480 MHz with 1 MHz spacing.

### EUT Support Program

The EUT was tested stopped at channel 1, 2401 MHz, channel 39, 2440 MHz, and channel 80, 2480 MHz. 2401 MHz was where the maximum emission level was observed. Band edge measurements were taken with the EUT operating throughout 2401 MHz and 2480 MHz with FSK modulation.

### EUT Modifications for Compliance

There were no modifications performed on the EUT. The test results state the emission levels of the EUT in the condition as it was received on April 19, 2004.

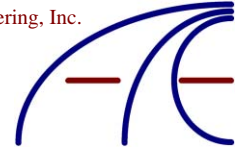

## EUT Support Devices

*Table 1 - Support Equipment Used For Test*

<b>Model:</b>	<b>Description:</b>	<b>S/N</b>	<b>FCC ID#</b>
X00290-001	Microsoft XBOX Video Game System	3230175 22102	DoC
14AF-41	Toshiba Color TV	15611401 A	DoC

## I/O Ports and Cables

*Table 2 - EUT Port Termination's*

<b>I/O Port</b>	<b>Cable Type</b>	<b>Length</b>	<b>Connector</b>	<b>Termination</b>
Player port 1	N/A			

*Table 3 - Host Port Termination's*

<b>I/O Port</b>	<b>Cable Type</b>	<b>Length</b>	<b>Connector</b>	<b>Termination</b>
AV	Triple Coax, Ferrite Bead	8 FT	RCA (3x)	Monitor
Power	Non-Shielded	7 FT	IEC	Power Mains

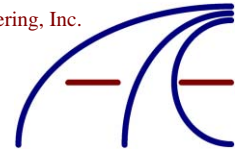

## Equipment Under Test

The photographs below show the condition of the EUT for test.









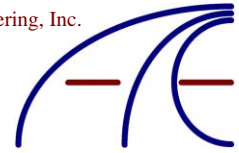

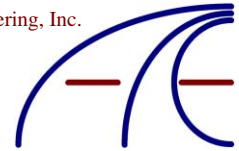

The antenna is an embedded PCB antenna, Type is Inverted F Antenna

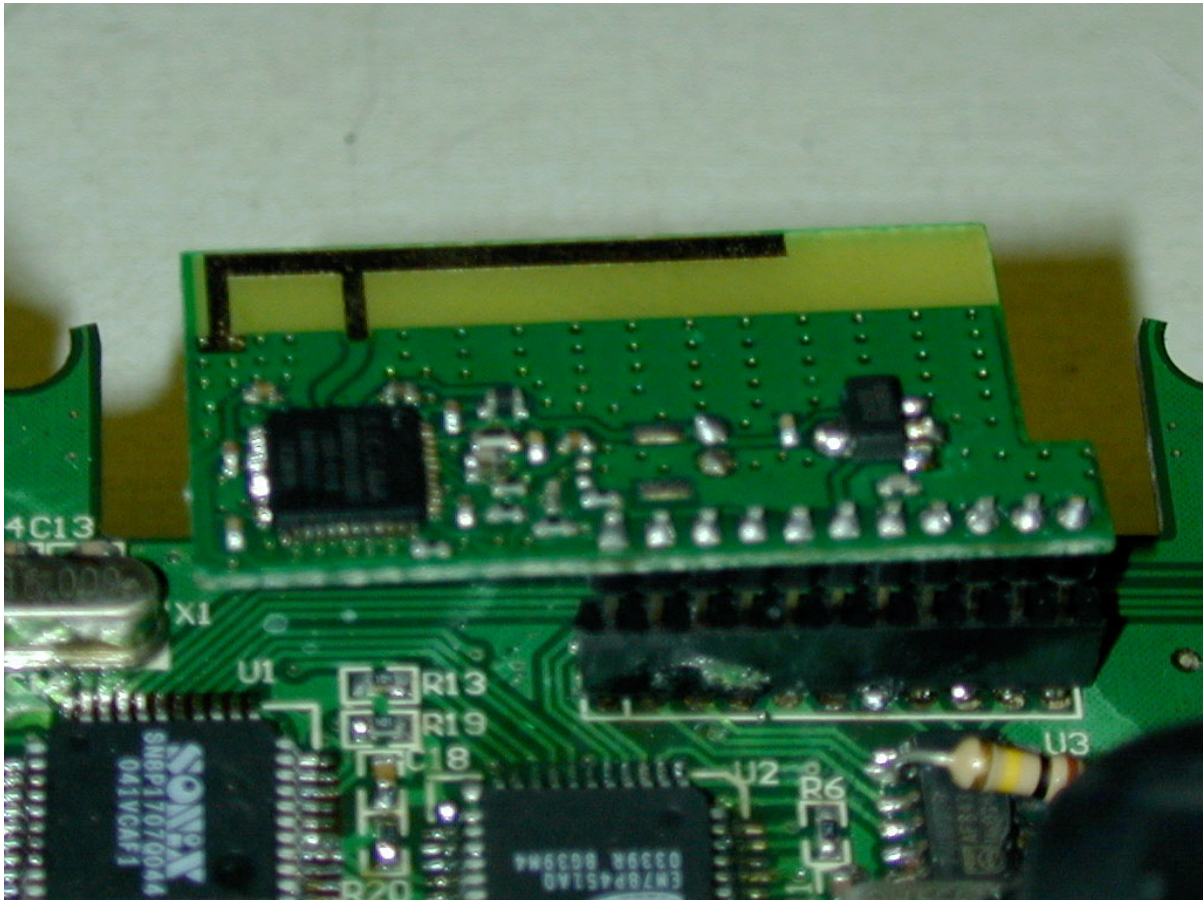

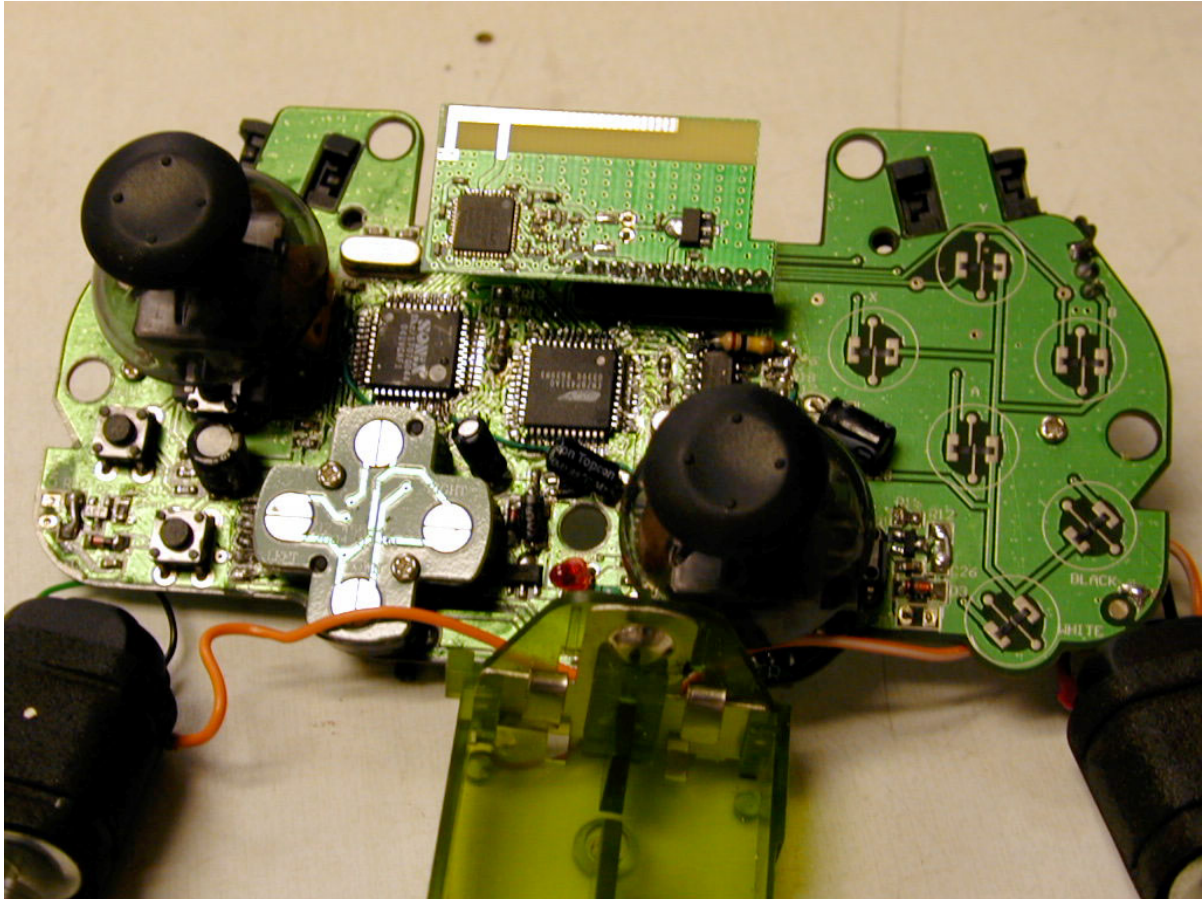

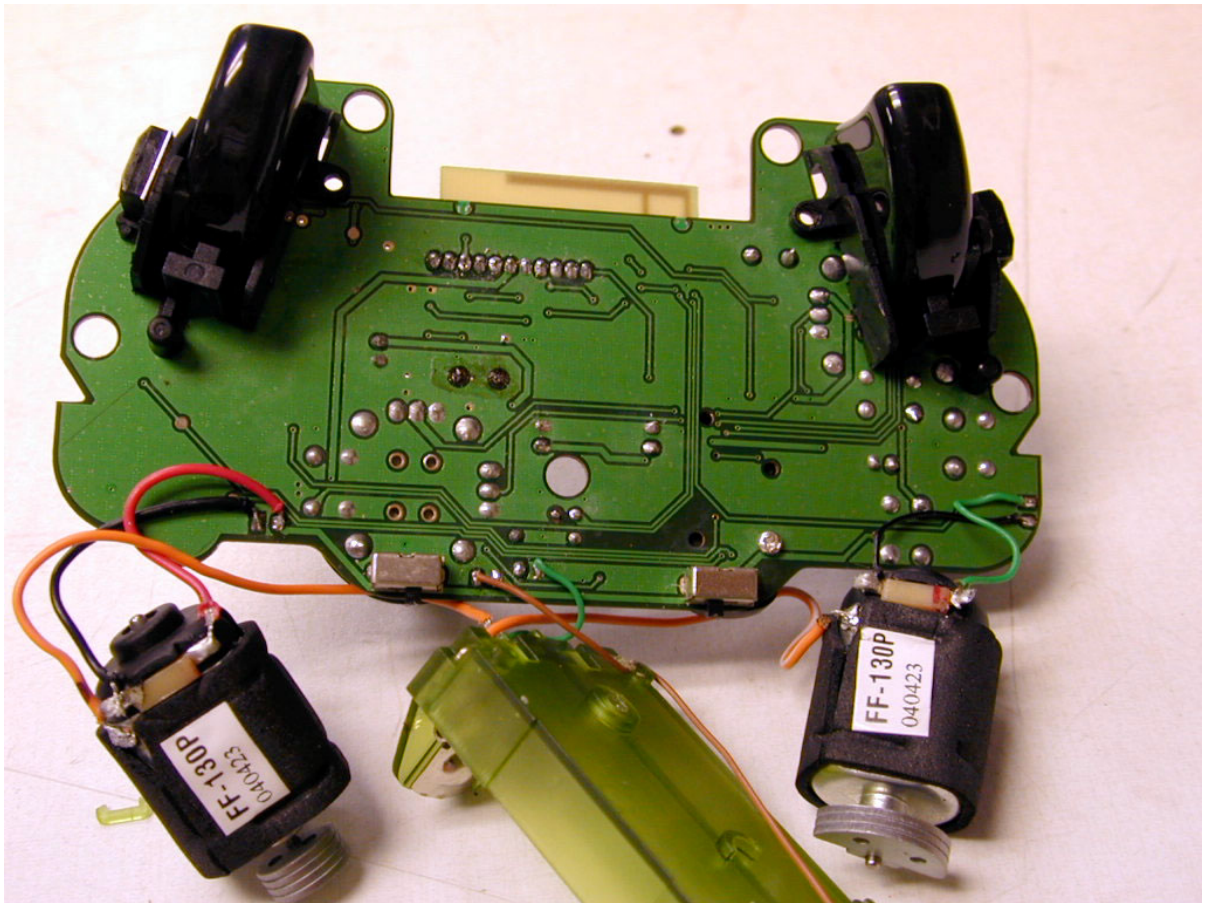

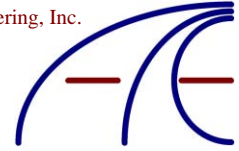

## Equipment Block Diagram

Following is the block diagram of the test setup. Refer to TEST CONFIGURATION pages for port connections and information.

*Figure 1 - Test Setup Diagram*

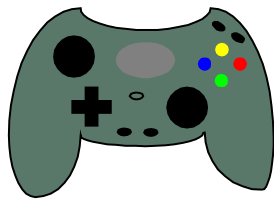
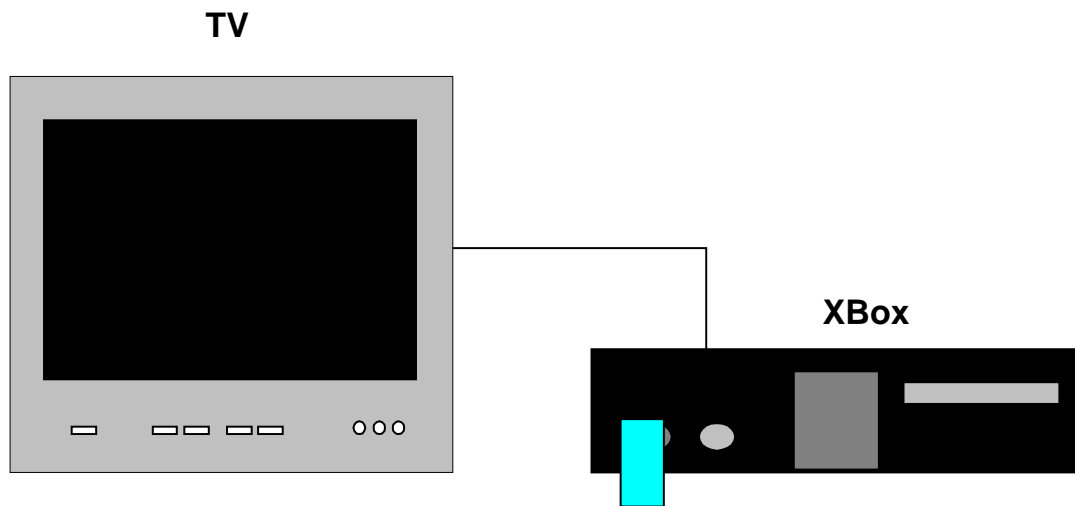

**EUT: 4556S  
RF Controller JoyPad**

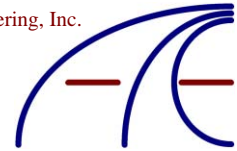

## Test Setup (Radiated Emissions)

The photographs below show worst case setup for radiated emission testing at 10 Meters with a Bicon Antenna.

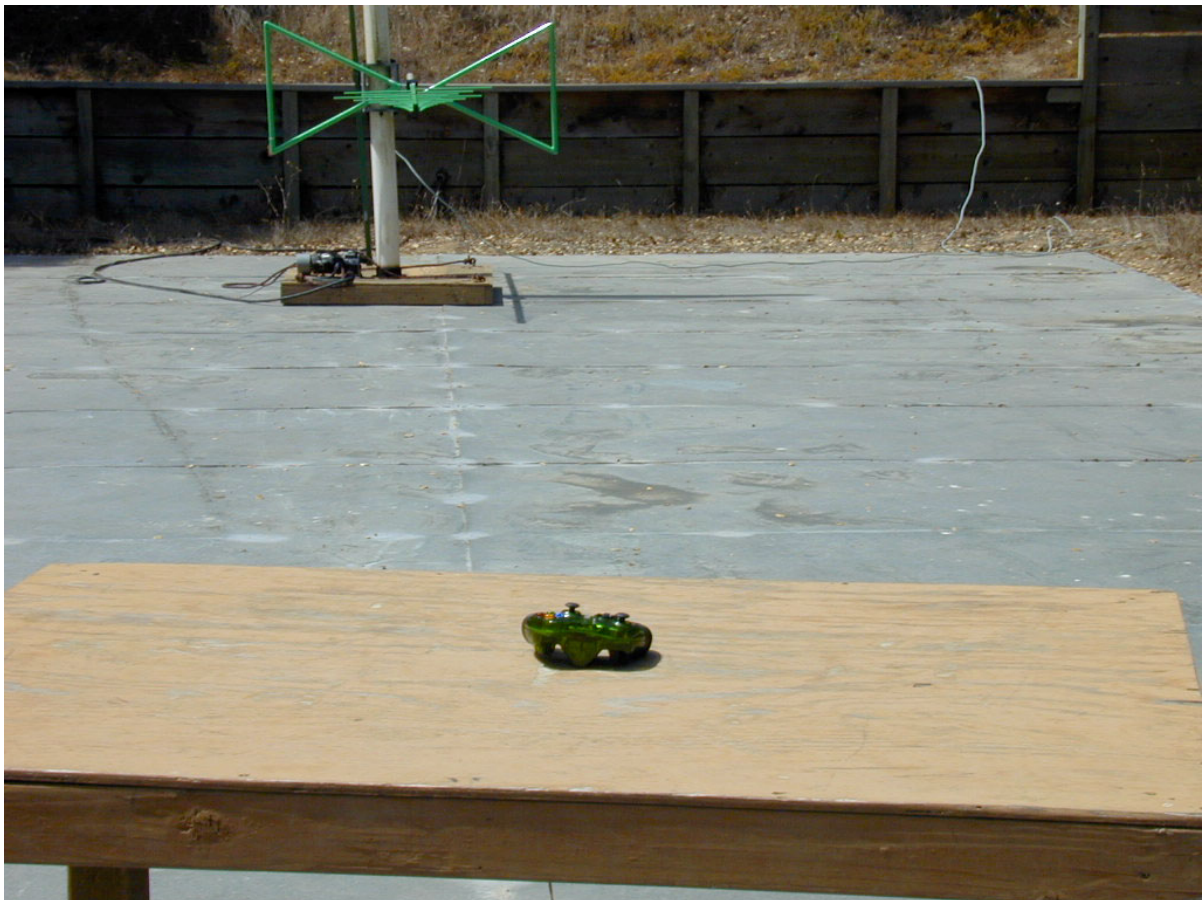





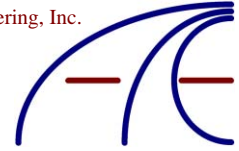

The photographs below show worst case setup for radiated emission testing at 3 Meters.



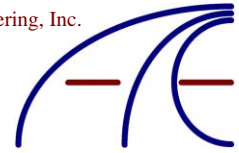

The photographs below show worst case setup for radiated emission testing at 3 Meters and 10 Meters with a loop antenna.

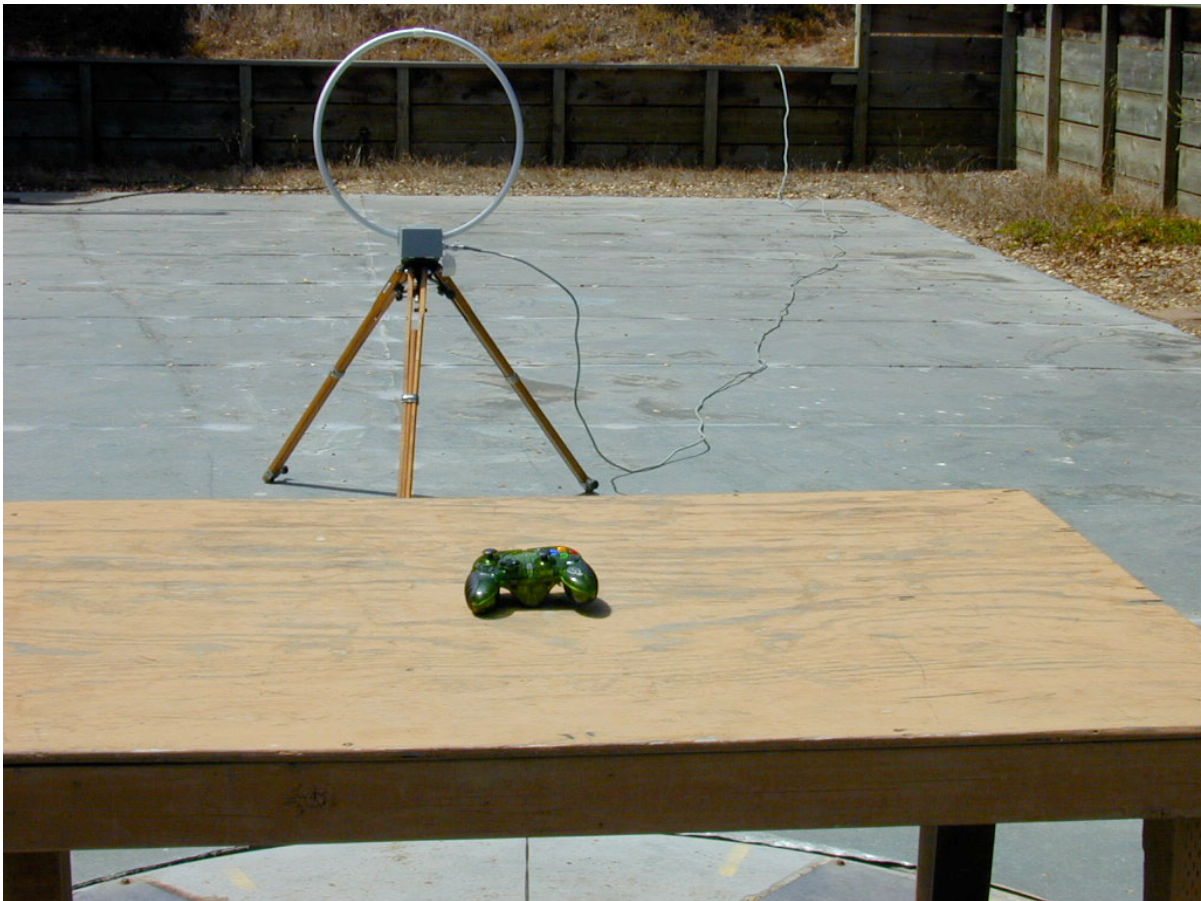





## Test Methods for Emissions

The test procedure stated in ANSI C63.4-1992 was used to collect the test data. The radiated emission data of the EUT was taken with the Rohde & Schwarz EMI Test Receiver or HP 8566B. Incorporating the application of correction factors programmed into the Test Receiver and verified for distance, antenna, cable loss, and amplifier gain, the data was reduced as shown in the Sample Calculations. These correction factors are available upon request. The corrected data was then compared to the emission limits to determine compliance.

During radiated emission testing, the EUT was placed on a nonconductive rotating table 0.8 meter above the conductive grid. The nonconductive table dimensions were 1 meter deep by 1.5 meters wide at 0.8 meter high. The EUT is centered on the tabletop and the measurement antenna was placed 3 meters from the EUT as noted in the test data.

For radiated emissions testing, scans in the frequency range of 6 MHz to 22000 MHz were made. Each frequency between 9 kHz and 150 kHz was measured at a bandwidth of 200 Hz, between 150 kHz and 30 MHz was measured at a bandwidth of 10 kHz, between 30 MHz and 1000 MHz was measured at a bandwidth of 120 kHz and between 1000 MHz and above was measured at a bandwidth of 1 MHz. Measurements were made employing a CISPR quasi-peak detector except for the frequency bands 9-90 kHz, 110-490 kHz, and above 1GHz which employed an average detector. All readings within 10 dB of the limits were recorded, and those emissions were then measured using the appropriate detector and bandwidth for a 2-second measurement time.

RF Measurements were made at a distance of 3 meters.

## Conducted Emission Testing

For the conducted emissions testing, the EMCO LISN, Model No. 3825/2, was used for the EUT and the EMCO LISN, Model No. 4825/2, was used for the support equipment. During conducted emission testing the EUT was located on a wooden test bench measuring 0.8 meter high, 1 meter deep, and 1.5 meters in width. The vertical conducting surface was 0.4 meter from the back of the test bench. The LISNs were placed on the ground plane of the test area in accordance with ANSI C63.4-1992.

The metal plane used for conducted emission testing was grounded to the earth by a heavy gage braided wire attached to the plane. All other objects were kept a minimum of 1 meter away from the EUT during the conducted test.

For conducted emissions testing a scan of the frequency band 150 kHz to 30 MHz was made stepping every 5 kHz. Each frequency was measured at a bandwidth of 10 kHz for 20 msec. Due to the narrow specification of a 6 dB drop, the 10 kHz bandwidth meets the requirements of CISPR 16, band B (150 kHz to 30 MHz) and VDE 0876 as well as of various military standards that require tolerances of 10% for a 10 kHz measurement bandwidth. All readings within 25 dB of the limits were recorded, and

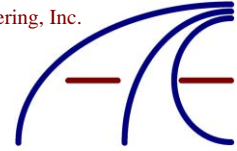

those emissions were then measured using the CISPR quasi-peak detector at a bandwidth of 10 kHz for a 2 second measurement time. All emissions within 6 dB of the limit were examined with additional measurements to ensure compliance with the FCC 15.207 limits.

The Joypad is battery operated, conducted was not necessary.

## Temperature and Humidity

The ambient temperature of the actual EUT was within the range of 10° to 40° C (50° to 104° F) unless the particular equipment requirements specify testing over a different temperature range. The humidity levels were within the range of 10% to 90% relative humidity unless the EUT operating requirements call for a different level.

## Sample Calculations

An example of how the EMI Test Receiver reading is converted using correction factors is given for the emissions recorded in Table 6. These correction factors are programmed into the EMI Test Receiver and verified. For radiated emissions in dB $\mu$ V/m, the EMI Test Receiver reading in dB $\mu$ V is corrected by using the following formula:

$$\begin{aligned} & \text{Meter Reading (dB}\mu\text{V/m)} \\ & - \text{Pre amp Gain (dB)} \\ & + \text{Cable Loss (dB)} \\ & + \text{Antenna Factor (dB)} \\ & = \text{Corrected Reading (dB}\mu\text{V/m)} \end{aligned}$$

This reading is then compared to the applicable specification limits and the difference will determine compliance. For conducted emissions, no correction factors are needed when a 50  $\mu$ H LISN is used.

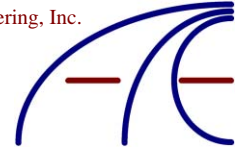

## FCC Part 15 Subpart C 15.207 and 15.209 Limits

*Table 4 - Radiated Emission Limits, General Requirements*

Frequency MHz	Field Strength $\mu\text{V/m}$	Measurement Distance Meters
0.009 – 0.490	2400/F(kHz)	300
0.490 – 1.705	24000/F(kHz)	30
1.705 – 30	30	30
30 – 88	100	3
88 – 216	150	3
216 – 960	200	3
Above 960	500	3

**NOTE:**

1. The lower limit shall apply at the transition frequencies.
2. Distance refers to the distance in meters between the measuring instrument antenna and the closest point of any part of the device or system.
3. The level of any unwanted emissions from an intentional radiator operating under these general provisions shall not exceed the level of the fundamental emission.
4. The emission limits shown are based on measurements employing a CISPR quasi-peak detector except for the frequency bands 9-90 kHz, 110-490 kHz and above 1000 MHz. Radiated emission limits in these three bands are based on measurements employing an average detector.

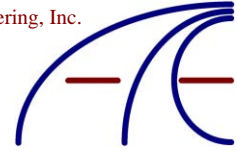

*Table 5 - Radiated Emission Limits,  
 Operation within the bands 902 – 928 MHz, 2400 – 2483.5 MHz,  
 5725 – 5875 MHz, and 24.0 – 24.25 GHz.*

<b>Frequency MHz</b>	<b>Field Strength of fundamental millivolts/meter</b>	<b>Field Strength of harmonics microvolts/meter</b>
902 – 928	50	500
2400 – 2483.5	50	500
5725 – 5875	50	500
24000 – 24250	250	2500

**NOTE:**

5. Field strength limits are specified at a distance of 3 meters..
6. Emissions radiated outside of the specified frequency bands, except for harmonics, shall be attenuated by at least 50 dB below the level of the fundamental or to the general radiated emission limits in 15.209, whichever is the lesser attenuation.
7. As shown in 15.35(b), for frequencies above 1000 MHz, the above field strength limits are based on average limits. However, the peak field strength of any emission shall not exceed the maximum permitted average limits specified above by more than 20 dB under any condition of modulation.





## Report of Measurements 15.249 Radiated Data

The following tables reports the results of the radiated measurements for the XBox 2.4 GHz RF Controller Joypad, 4556S.

*Table 6 - Radiated Emission Level*

15.249Limit dB $\mu$ V/m	Fundamental Frequency MHz	Level dB $\mu$ V/m	Detector	Azimuth, Height	Antenna	Polarity	Margin dB
94 @ 3 meters	2401	92.09 Y	PK	95, 1.3M	Horn	V	-1.91
		92.79 X	PK	315, 1.3M	Horn	H	-1.21

15.249Limit dB $\mu$ V/m	Harmonic Frequency MHz	Level dB $\mu$ V	Detector	Test Distance	Antenna	Polarity	Margin dB
54 @ 3 meters	4802	48.34	PK	270, 1.2M	Horn	H	-5.66
		45.34	PK	15, 1M	Horn	V	-8.66
54 @ 3 meters	7203	43.48	PK	310, 1M	Horn	H	-10.52
		41.48	PK	100, 1.1M	Horn	V	-12.52
54 @ 3 meters	9604	42.12	PK	210, 1.2M	Horn	H	-11.86
		41.84	PK	175, 1.1M	Horn	V	-12.16
54 @ 3 meters	12005	45.94	PK	0, 1M	Horn	H	-8.06
		45.64	PK	180, 1M	Horn	V	-8.36
54 @ 3 meters	14406	47.64	PK	0, 1M	Horn	H	-6.36
		47.64	PK	180, 1M	Horn	V	-6.36
54 @ 3 meters	16807	24<					
		24<					
54 @ 3 meters	19208	24<					
		24<					
54 @ 3 meters	22609	24<					
		24<					
54 @ 3 meters	24010	24<					
		24<					

54 @ 3 meters	Bandedge 2398	30.48	AV	130, 1.2M	Horn	V	-23.52
54 @ 3 meters	Bandedge 2482	30.75	AV	120, 1.2M	Horn	H	-23.25

Test Method: ANSI C63.4-1992  
 Spec Limit: FCC 15.249  
 No other emissions were observed.

PK = Peak, Y = Y Plane, X = X Plane  
 AV = Average  
 V = Vertical, H = Horizontal

COMMENTS: System continuously running. 2401 MHz was observed as the worst case emissions. Ambient temperature 67°F and relative humidity of 54%. Test distance of 3 meters. Quasi-peak and average detectors were not used since the peak readings were under the limits (unless noted otherwise). **No emissions observed after the third harmonic**, measurements taken are baseline measurements after the forth harmonic. Band edge measurements were taken with FSK modulation.

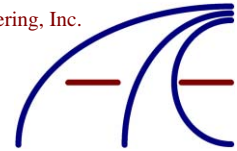

## Part 15.249 Setup

Measurements were performed in the frequency range of 1 GHz to 10 GHz at 3-meter distance. The Horn antenna was searched from 1 to 4 meters in height in both horizontal and vertical orientation. The EUT was also rotated 360 degrees in front of the antenna, all three orthogonal planes were scanned. Only the third harmonic of the transmitter was observed. The fourth to tenth harmonics of the transmitter were measured and the levels recorded are the baseline of the noise floor.

Exploratory radiated emissions measurements of all transmitter frequencies were made in all three orthogonal planes to determine the maximum transmit level of the EUT. The transmit frequencies of the EUT was tested stopped at channel 1, 2401 MHz, channel 39, 2440 MHz, and channel 80, 2480 MHz. 2401 MHz was where the maximum emission level was determined to be the highest level. With the antenna in horizontal orientation and the EUT in the x-plane, as shown below, the highest level was recorded. With the antenna in the vertical orientation and the EUT in the y-plane, as shown below, the highest level was recorded.



X-Plane



Y-Plane



Z-Plane

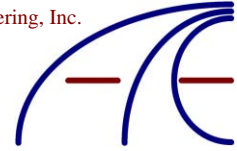

## Frequency Hopping System

Frequency Range:	2401 MHz – 2480 MHz
Number of Channels:	79 Channels
Channel Separation:	1 MHz
Occupancy:	1/320 sec over 1sec. period
Transmitting Method:	Pseudo-random, Frequency Hopping Spread Spectrum
Transmitting Power:	1.0 Watt (Max Allowable), 38 $\mu$ W (Actual Peak)
Antenna Type:	Inverted F
Power Source:	3 AA Batteries, 4.5 VDC, 3.3 VDC down regulated
Battery Life:	Above 50 Hours continuously on average

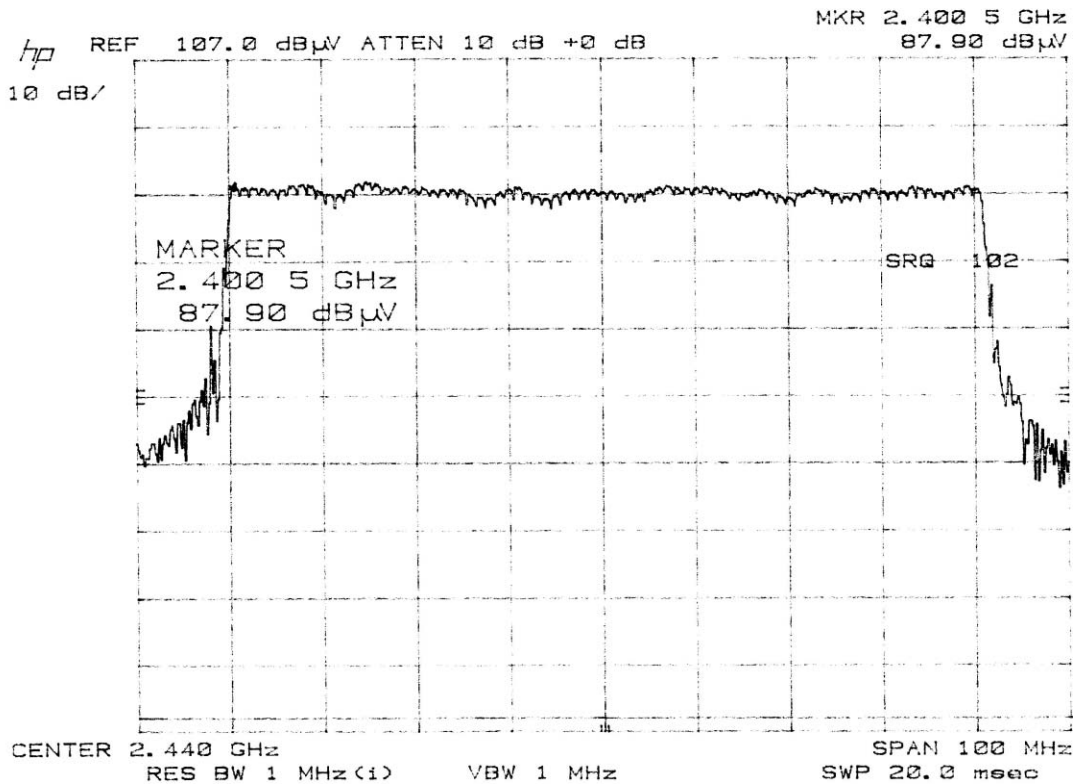

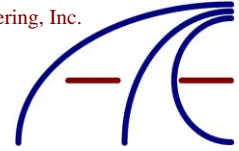

## Frequency Separation

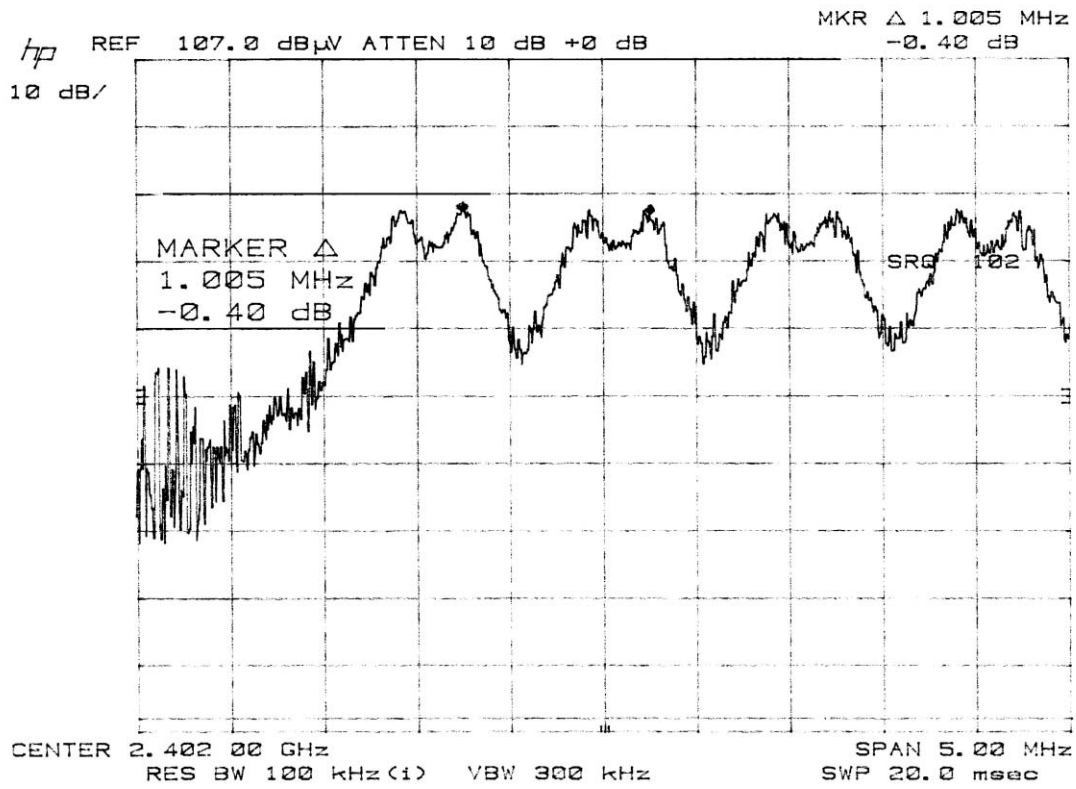

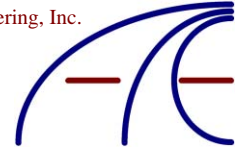

## 20dB Bandwidth Measurement

Channel 1, 20 dB Bandwidth at 1.2 MHz

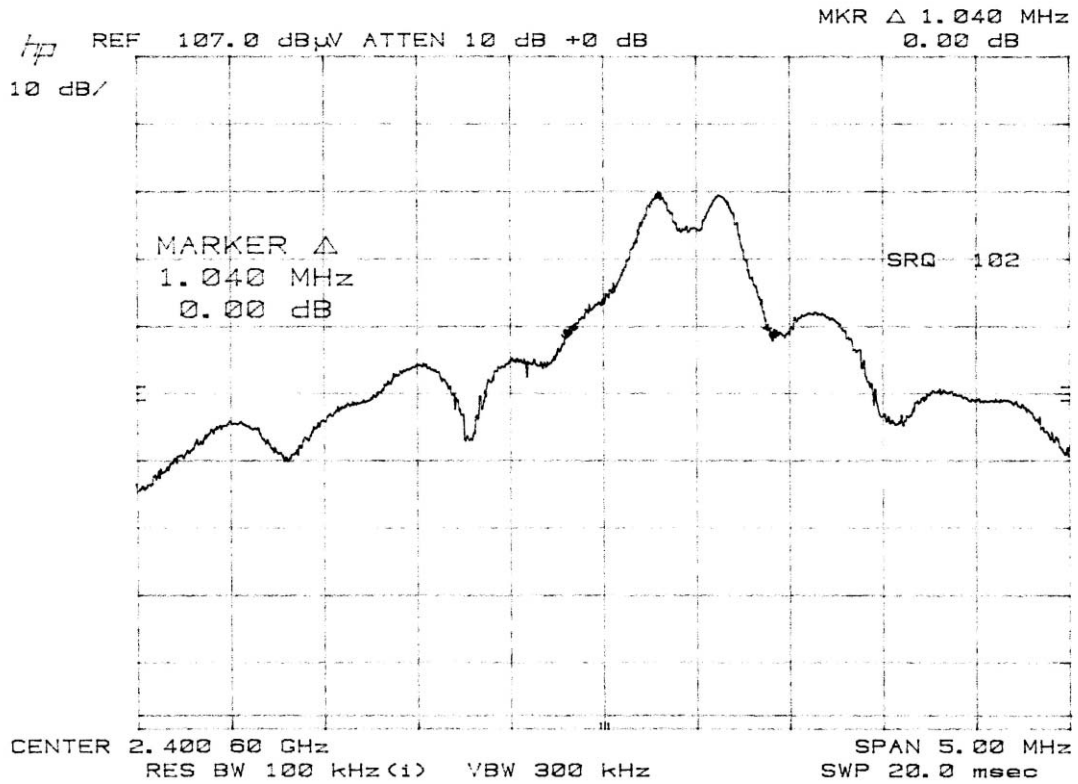



## Report of Measurements 15.209 Radiated Data

*Table 7 - Radiated Emission Level Below 30 MHz*

15.209 Limit dB $\mu$ V/M	Unwanted Frequency MHz	Level dB $\mu$ V	Detector	Test Distance in Meters	Margin dB	Antenna
49.5 @ 10 meters	12.45	12.64	QP	10	-33.86	Loop
49.5 @ 10 meters	16.01	14.23	QP	10	-35.27	Loop

Exploratory radiated emissions measurements were performed from 6 MHz to 30 MHz at 10 Meter and 3 Meter distances. The loop antenna was placed at 1 Meter height and was rotated about its vertical axis. The EUT was also rotated 360 degrees in front of the antenna.

Limit was extrapolated at 40 db/decade for measurement at 10 Meters. Emissions were at the noise floor. No other emissions were observed.

*Table 8 - Radiated Emission Level Below 2000 MHz*

Frequency MHz	QP Level dB $\mu$ V	QP Limit dB $\mu$ V	Margin dB	Azimuth, Height	Antenna, Polarization
48.12	25.27	30.00	-4.73	265, 2M	Bicon, V
71.92	24.01	30.00	-5.99	250, 1.7M	Bicon, V
143.7	22.55	30.00	-7.45	292.5, 3.5M	Bicon, V
144.3	23.65	30.00	-6.35	292.5, 3.5M	Bicon, V
600.18	25.94	37.00	-11.06	210, 1.1M	Bilog, V
1459	23.56	44.00	-20.44	125, 1.1M	Bilog, V
48.1	18.78	30.00	-11.22	270, 3.9M	Bicon, H
71.9	22.39	30.00	-7.61	225, 4M	Bicon, H
143.74	20.88	30.00	-9.12	280, 3.7M	Bicon, H
144.26	21.60	30.00	-8.40	280, 3.7M	Bicon, H
191.68	25.85	30.00	-4.15	0, 3.9M	Bicon, H
600.18	25.94	37.00	-11.06	210, 1.1M	Bilog, H
1473	30.85	44.00	-13.15	25, 1.1M	Bilog, H
1586	34.67	44.00	-9.33	10, 1.1M	Bilog, H

Start Freq. 30MHz      Stop Freq. 2000MHz      Step 25kHz      IF BW 120kHz      Detector PK      Scan-Time 10msec      Atten. 0dB

Test Method: ANSI C63.4-1992  
 Spec Limit: FCC 15.209

Note: AV = Average  
 QP = Quasi Peak



1007.01

Atlas Compliance & Engineering, Inc.  
1792 Little Orchard St.  
San Jose, CA 95125  
Phone 408.971.9743  
Fax 831.761.3223



## COMPLIANCE VERIFICATION REPORT

# TEST CERTIFICATE

APPLICANT: Mad Catz Interactive Inc.  
7480 Mission Valley Rd. Suite 101  
San Diego, CA 92108 USA

Trade Name: XBox 2.4 GHz RF Controller Joypad

Model: 4556S

### I HEREBY CERTIFY THAT:

The measurements shown in this report were made in accordance with the procedures indicated and that the energy emitted by this equipment, as received, was found to be within the FCC CFR 47 Part 15 Subpart C section 15.249 and 15.209 for Radiated emissions. Additionally, it should be noted that the results in this report apply only to the items tested, as identified herein.

### I FURTHER CERTIFY THAT:

On the basis of the measurements taken at the test site, the equipment tested is capable of operation in compliance with the requirements set forth in FCC CFR 47 Part 15.209 and 15.249 Rules and Regulations. FCC measurement facility registration number 90452, Industry Canada test site file number IC 4929

On this Date: June 11, 2004

Mario E. Baraona Sr.  
Atlas Compliance & Engineering, Inc.

\_\_\_\_\_  
Printed Name

\_\_\_\_\_  
Signature

Mad Catz Interactive Inc. Representative