

Tantalus Systems Corp.

RT-2200

Report of Measurements

Per

CFR47, FCC Part 15, Subpart B and FCC Part 90 Subpart I and T

Revision 1.3

August 27, 2003

Approvals		
Written By:	<hr/> Craig Long	<hr/> Date
Checked by	<hr/> Robert Stirling, P.Eng.	<hr/> Date

Protocol Labs, Abbotsford B.C., Canada
FCC Registration Number 96437
Industry Canada Registration Number IC3384

Index

FCC CFR47 Part 15/B Report of Measurements	3
Equipment Under Test:.....	5
Part 1 - Radiated Emission Testing	7
Part 2 - Conducted Emissions	8
Part 3 - Radiated Spurious Emissions.....	9
Part 4 - Occupied Bandwidth	10
Part 5 - Frequency Stability Over Supply Voltage Variation	11
Part 6 - Frequency Stability Over Temperature Variation.....	12
Appendix A: Photos	14
Appendix B: FCC Part 15/B Measurement Data and Plots.....	16
Measurement Data	16
Emissions Plots	18
Appendix C: Radiated Spurious Emissions.....	23
Appendix D: Occupied Bandwidth.....	26
Appendix E: Harmonic Measurements	30
Appendix F: Frequency Stability Over Temperature Variation.....	33
Appendix G: Frequency Stability Over Supply Voltage Variation	36

FCC CFR47 Part 15/B Report of Measurements

Testing Details:

TESTED BY: Robert Stirling
 TEST CONDITIONS: Temperature and Humidity: 24°C, 60%
 TEST VOLTAGE: 208 VAC 60 Hz

Test Facilities:

Protocol Labs
 28945 McTavish Rd.
 Abbotsford B.C., Canada, V4X 2E7
 FCC Registration Number 96437
 Industry Canada Registration Number IC3384

Test Equipment List:

EMISSIONS:

Device	Model Number	Serial No.	Last Cal.	Next Cal
Antenna	EMCO 3141 Bilog	1127	09/13/01	09/13/02
Antenna	EMCO 3105	2024	09/10/01	09/10/02
Spectrum Analyzer	Hewlett Packard 8566B	2241A02102	01/10/02	01/10/03
RF-Preselector	Hewlett Packard 85685A	3107A01222	01/10/02	01/10/03
Quasi-Peak Adapter	Hewlett Packard 85650A	2043A00240	01/10/02	01/10/03
Power Meter	Marconi 6960B	237087/007	02/11/02	02/11/03
Power Sensor	Marconi	961823/002	02/11/02	02/11/03
Tower	Rhientech Labs	Custom	N/A	N/A
Turntable	Protocol	Custom	N/A	N/A

The following set of equipment was used for the occupied bandwidth, frequency stability over supply voltage variation, and frequency stability over temperature variation.

EMISSIONS:

Device	Model Number	Serial No.	Last Cal.	Next Cal
Thermotron	Thermotron S1.2	16576	N/A	N/A
Signal Generator	Rohde and Schwartz SMIQ Q3	DE23617	02/25/02	02/25/05
Spectrum Analyzer	Hewlett Packard E4402B	962588	12/11/01	12/11/02
Thermometer	Omega HH501DK Type K	905	19/03/02	19/03/02
Network Analyzer	Hewlett Packard 8753D	3410A	31/10/01	31/10/02
Directional Ccoupler	MECA KS-21603L 3	1918	Swept with calibrated HP network Analyzer	
30 Db Attenuator	Bird 8306-300-N	MFC709 98	Swept with calibrated HP network Analyzer	
True RMS Multimeter	Fluke 179	8080071 0	12/08/02	12/08/03
Converter	Form S meter box assembly with Linear 120 – 240 VAC Step up converter	2917011 A-0758	12/06/02	12/06/03
Variable Autotransformer	PowerSat 116B	100001	N/A	N/A

Equipment Under Test:**THE TEST SYSTEM:****EUT** RT-2200 Series 220 MHz Remote Transceiver

Manufacturer Tantalus Systems Corp.

Part Number RT- 2200

Serial Number Prototype

Emissions Designator: 4k0F1D

Part90.209(b)(5)

 $B_n = 2(\text{Data rate} / 2) + DK$

Data rate = 3200 baud

D = 750 Hz

K = 1

CABLING:

Cable	Description	Shielded	Ferrite
Power	AC Input Power Cable	No	No

TEST SETUP:

For the unintentional radiator portion of the testing the EUT was placed in receive mode, and for the Spurious emissions testing the EUT was placed in transmit mode for the duration of the testing.

TEST SUMMARY:

Test	Standard	Description	Result
Conducted Emissions	FCC 15.107 ,15.207 Class B Limits	The Conducted Emissions are measured on the phase and Neutral Power lines in the 0.15 - 30.0 MHz range.	Complies
Radiated Emissions	FCC15.109 15.209 Class B Limits	The Radiated Emissions are measured from 30 MHz to 1000 MHz	Complies
Radiated Spurious	FCC 2.103/ 2.1053	The radiated emissions are measured up to the 10 th Harmonic	Complies
Frequency Stability over Temperature	FCC 90.213/ 2.1055	Radiated Emissions on the fundamental form -30°C to +60°C	Complies
Occupied Bandwidth	FCC 2.1049	A Radiated measurement of the fundamental	Complies

MODIFICATIONS:

This unit requires no modifications for it to pass.

CONCLUSION:

RT-2200 tested complies with the requirements of FCC CFR47 part 15/B and FCC Part 90 Subpart I and T (Private land mobile radio servises)

Part 1 - Radiated Emission Testing

DATE: July 23, 2002

TEST STANDARD: FCC CFR47, Part 15, Subpart B section 15.109/ 15.209 Class B

DEVICE DESCRIPTIONS: Refer to the Equipment Under Test Section, above, for EUT Descriptions.

TEST SETUP: The equipment was set up in a 3 meter open field test site. Emissions in both horizontal and vertical polarization's were measured while rotating the EUT on a turntable to maximize the emissions signal strength and the results recorded on the attached plots.

CABLING DETAILS: The EUT was set up using the manufacturer's specified normal cabling configuration.

CABLE DESCRIPTIONS

Cable	Name	Ferrite	Shielded
Power	AC Input Power Cable	No	No

MINIMUM STANDARD: Class B Limits:

Frequency (MHz)	Maximum Field Strength dBuV/m at 3m
30 - 88	39.0
88 - 216	43.5
216 - 960	46.5
960 - up	49.5

MEASUREMENT DATA: See Appendix B for Plots, The blue trace represents all emissions, including ambient noise. 'All Suspects' are marked in purple. FCC Class B limits are marked in solid purple.

EMISSIONS DATA: See Table 7 and 8 in Appendix B for corresponding frequencies.

PERFORMANCE: Complies.

Part 2 - Conducted Emissions

DATE: July 23, 2002

TEST STANDARD: FCC CFR47, Part 15, Subpart B section 15.107/ 15.207 Class B

DEVICE DESCRIPTIONS: Refer to the Equipment Under Test Section, above, for EUT Descriptions.

TEST SETUP: The EUT was connected to the conducted emissions LISN apparatus.

METHOD OF MEASUREMENT: Measurements were made using a spectrum analyzer, Peak detector. Any emissions that are close to the limit are measured using a test receiver, CISPR Quasi-Peak detector. The RT-2200 was tested for conducted emission in receiving and transmitting mode at 208 VAC 60 Hz.

CABLING DETAILS: The EUT was set up using the manufacturer's specified normal cabling configuration.

CABLE DESCRIPTIONS

Cable	Name	Ferrite	Shielded
Power	AC Input Power Cable	No	No

MINIMUM STANDARD: Class B Limits:

Frequency (MHz)	Maximum Level (dBuV)	Maximum Level (dBuV)
	Quasi-Peak	Average
0.45 – 30.0	51.0	48.0

MEASUREMENT DATA: See Appendix B for Plots,

EMISSIONS DATA: See Table 1 , 2, 3, 4, 5 and 6 in Appendix B for corresponding frequencies.

PERFORMANCE: Complies.

Part 3 - Radiated Spurious Emissions

DATE:	July 23, 2002
TEST STANDARD:	FCC CFR47, Part 2, 103, and 1053
DEVICE DESCRIPTIONS:	Refer to the Equipment Under Test Section, above, for EUT Descriptions.
TEST SETUP:	The equipment was set up at a 3 m measurement distance, and. Spurious emissions we measured in both horizontal and vertical polarization's with signal strength and the results recorded on the attached graph and tables. This testing was performed with a 6 dB attenuator on the input of the spectrum analyzer. A notch filter was used for all frequencies but the fundamental and for any frequencies in close proximity to the fundamental.
CABLING DETAILS:	The EUT was Set up using the manufacturer's specified normal cabling configuration.
MINIMUM STANDARD:	Spurious Attenuation = $55 + 10\log(\text{Power})\text{dB}$.Power is specified in Watts. $\text{ERP} = (\text{S/G} - \text{loss}) + (\text{G}_{\text{SUB}} - \text{G}_d)$ $\text{ERP} = (\text{S/G} - \text{loss}) + [(20\log F - \text{AF}_S - 29.79) - (20\log F - \text{AF}_D - 29.79)]$ $\text{ERP} = (\text{S/G} - \text{loss}) - \text{AF}_S + \text{AF}_D$
MEASUREMENT DATA:	See Appendix C for Graphs and Data
EMISSIONS DATA:	See Appendix E, for Harmonics Data and Plots
MEASUREMENT PROCEDURE:	A bilog and horn antenna located 3 meters away from the transmitter picks up any signal radiated from the transmitter. A spectrum analyzer covering the necessary frequency range is used to detect and measure any radiation picked up by the antenna. The testing procedure is repeated for both horizontal and vertical polarization's of the receiving antenna. Relative signal strength is indicated on the spectrum analyzer connected to this antenna, and the cable losses, amplifier gain and antenna correction factor are added to calculate the signal strength. Actual measurements are recorded on the attached graphs.
PERFORMANCE:	Complies.

Part 4 - Occupied Bandwidth

DATE: August 12 2002

TEST STANDARD: FCC CFR47, Part 2.1049

DEVICE DESCRIPTIONS: Refer to the Equipment Under Test Section, above, for EUT Descriptions.

TEST SETUP:

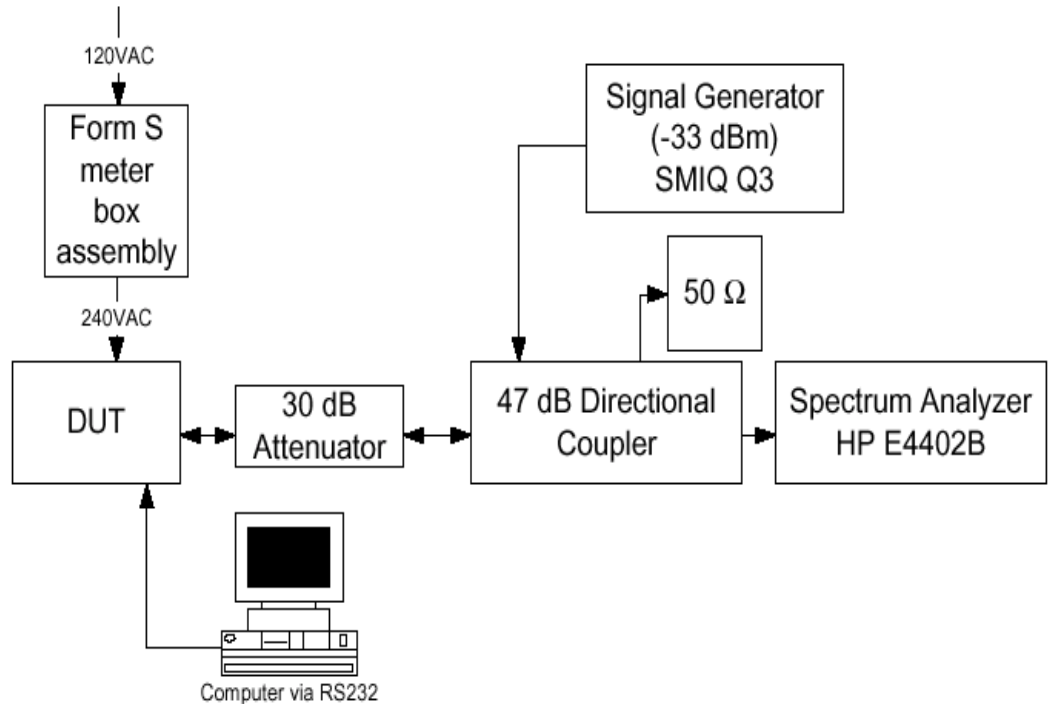

CABLING DETAILS: The EUT was Set up using the manufacturer's specified normal cabling configuration.

MEASUREMENT DATA: See Appendix D for Graphs and Data

EMISSIONS DATA: See Appendix D for corresponding frequencies

MEASUREMENT PROCEDURE: 1) The test setup in Figure 2 is used to test the Occupied Bandwidth at room temperature. This is measured to be at 25°C using the Omega HH501DK Type K Thermometer.

2) The occupied bandwidth is measured using the "Occupied Bandwidth" function of the HP Model E4402B Spectrum Analyzer. Both data speeds were measured and the data plotted.

The occupied bandwidth plots were performed for the three separate frequencies; 221.00247 MHz, 221.4975 MHz and 221.99747 MHz. The testing was performed at 1600 bps and 3200 bps. This test was performed at 25°C.

PERFORMANCE: Complies.

Part 5 - Frequency Stability Over Supply Voltage Variation

DATE: August 12 2002

TEST STANDARD: FCC CFR47, Part 90.213

DEVICE DESCRIPTIONS: Refer to the Equipment Under Test Section, above, for EUT Descriptions.

TEST SETUP: Test Setup for Occupied Bandwidth and Supply Variation tests.

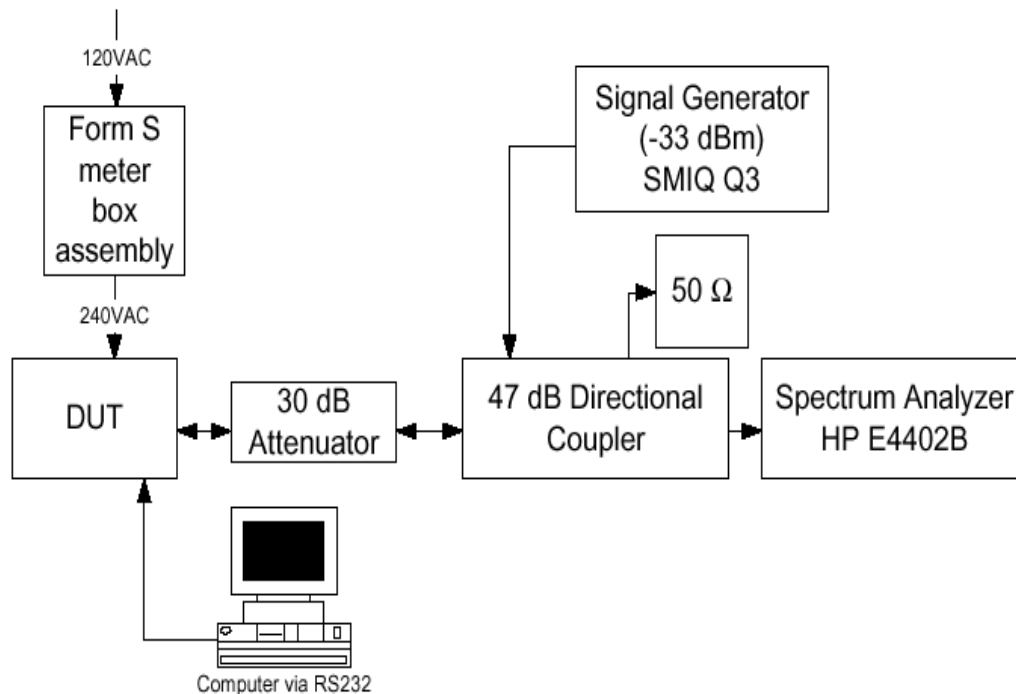

CABLING DETAILS: The EUT was Set up using the manufacturer's specified normal cabling configuration.

MEASUREMENT DATA: See Appendix G for Graphs and Data

EMISSIONS DATA: See Appendix G, for corresponding frequencies.

MEASUREMENT PROCEDURE: 1) The test setup in Figure 2 is used to test the Frequency Stability at room temperature. This is measured to be at 25°C using the Omega HH501DK Type K Thermometer.

2) The 120VAC supply is varied by the autotransformer and the supply voltage to the DUT is measured at the DUT supply input pins by the Fluke 179 True RMS Multi-meter.

3) Measurements are made on all three test frequencies as per the instructions stated in "Procedure – Mask versus Temperature" above.

The frequency stability over supply voltage variation plots was performed for the three-separate frequencies; 221.00247 MHz, 221.4975 MHz and 221.99747 MHz. The testing was performed at 1600 bps and 3200 bps. This test was performed at 25°C

PERFORMANCE: Complies.

Part 6 - Frequency Stability Over Temperature Variation

DATE: August 12 2002

TEST STANDARD: FCC CFR47, Part 90.213

DEVICE DESCRIPTIONS: Refer to the Equipment Under Test Section, above, for EUT Descriptions.

TEST SETUP: Test equipment setup for mask verses temperature tests.

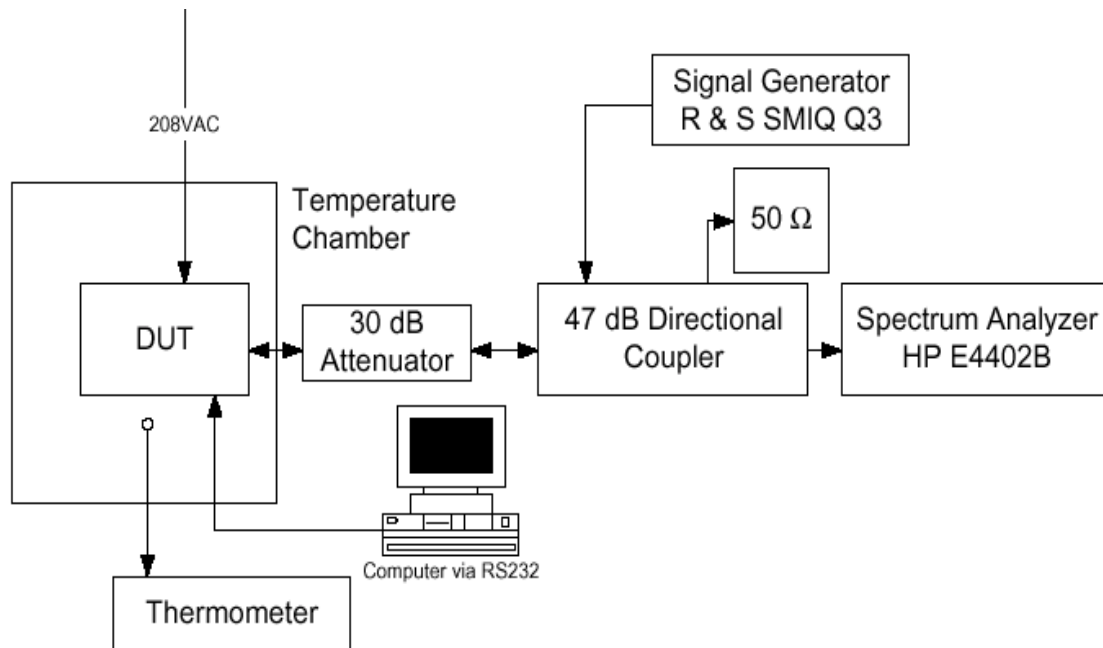

CABLING DETAILS: The EUT was Set up using the manufacturer's specified normal cabling configuration.

MEASUREMENT DATA: See Appendix F for Graphs and Data

EMISSIONS DATA: See Appendix F, for corresponding frequencies.

MEASUREMENT PROCEDURE:

- 1) The RT with its associated plastic enclosure is placed in the temperature chamber. The RT is powered on and the software allowed to initialize. The temperature chamber is programmed for the target temperature. After the calibrated digital thermometer reached the target temperature the RT is given time to reach thermal equilibrium.
- 2) The RT's normal operation is to disable its transmitter when it detects a temperature change of five degrees or more. It then will wait for a frequency correction command from the Base station. The laptop computer mimics the base station by issuing these commands through its serial port. At this time the RT is given the command to frequency correct by the laptop computer.
- 3) The RT receives the signal from the RF generator at a level of -110dBm which mimics the Base station and corrects its internal oscillator by a measurement and comparison method. The transmitter is keyed on with constant carrier and the peak of the signal adjusted to the top of the mask on the spectrum analyzer. Then the modulation is applied at the

appropriate data rate. The transmitter power and deviation is measured and calibrated before being put in the chamber with the calibrated attenuator and spectrum analyzer for 37dBm (5 Watts) and +/- 750 Hz. respectively.

4) The modulated data is taken with maximum hold function of the spectrum analyzer enabled. Then the transmitter is keyed off.

5) This procedure is repeated for the low, middle and high channels at all the measured temperatures.

The Frequency Stability Over Temperature Variation plots and data were performed for the three sperate frequencies; 221.00247 MHz, 221.4975 MHz and 221.99747 MHz. The testing was performed at 1600 bps and 3200 bps.

PERFORMANCE:

Complies.

Appendix A: Photos



Emissions Test Setup Front View



Emissions Test Setup Rear View

Appendix B: FCC Part 15/B Measurement Data and Plots

Measurement Data

Conducted Emissions

Non Transmitting

Table 1: Line 1 FCC Class B

Frequency (MHz)	Peak (dBuV)	DelLim-Pk (dB)
13.14	43.8	-4.2
13.28	43.8	-4.2
13.56	43	-5.0
12.86	42.6	-5.4
22.54	41.8	-6.2

Table 2: Line 2 FCC Class B

Frequency (MHz)	Peak (dBuV)	DelLim-Pk (dB)
13.28	41.6	-6.4
22.42	41	-7.0
.8203	40.1	-7.9
.5429	39.5	-8.5
.7263	39.5	-8.5

Transmitting

Table 3: Line 1 FCC Class B

Frequency (MHz)	Peak (dBuV)	DelLim-Pk (dB)
13	47.5	-0.5
12.86	47.2	-0.8
13.28	47	-1.0
13.56	45.6	-2.4
12.39	44.6	-3.4

Table 4: Line 2 FCC Class B

Frequency (MHz)	Peak (dBuV)	DelLim-Pk (dB)
1.28	46.9	-1.1
.8203	46.6	-1.4
1.182	46.6	-1.4
1.182	46.6	-1.4
2.184	46.6	-1.4

**Table 5: Line 1 FCC Class B
AVG**

Frequency (MHz)	Peak (dBuV)	DelLim-Pk (dB)
13.14	42.8	-5.2
13.28	42.7	-5.3
12.66	41.1	-6.9
13.56	40.3	-7.7
12.01	36.5	-11.5

**Table 6: Line 2 FCC Class B
AVG**

Frequency (MHz)	Peak (dBuV)	DelLim-Pk (dB)
1.293	44.9	-3.1
1.749	44.9	-3.1
1.844	44.8	-3.2
1.385	44.4	-3.6
.8291	44.3	-3.7

Table 7: Radiated Emissions sorted by frequency

Frequency (MHz)	Pol	Height (cm)	Angle (deg)	Un Corr Pk (dB)	Tot Corr (dB)	Peak (dBuV/m)	DelLim- Pk (dB)
36.087427	Vert	100	0	14.10	6.53	20.63	-19.37
37.502363	Vert	100	70	13.80	5.89	19.69	-20.31
39.566032	Vert	100	195	16.50	4.97	21.47	-18.53
40.332653	Vert	100	180	13.40	4.82	18.22	-21.78
42.168850	Vert	100	180	16.90	5.06	21.96	-18.04
107.074953	Vert	100	180	15.10	10.43	25.53	-17.97
114.574077	Vert	100	107	14.10	9.90	24.00	-19.50
129.753589	Vert	100	100	15.40	9.75	25.15	-18.35
133.949789	Vert	100	0	12.50	9.93	22.43	-21.07
141.936621	Vert	100	0	13.10	10.31	23.41	-20.09
400.029338	Vert	100	180	11.80	19.00	30.80	-15.20

Table 8: Radiated Emissions sorted by amplitude

Frequency (MHz)	Pol	Height (cm)	Angle (deg)	Un Corr Pk (dB)	Tot Corr (dB)	Peak (dBuV/m)	DelLim- Pk (dB)
400.029338	Vert	100	180	11.80	19.00	30.80	-15.20
107.074953	Vert	100	180	15.10	10.43	25.53	-17.97
42.168850	Vert	100	180	16.90	5.06	21.96	-18.04
129.753589	Vert	100	100	15.40	9.75	25.15	-18.35
39.566032	Vert	100	195	16.50	4.97	21.47	-18.53
36.087427	Vert	100	0	14.10	6.53	20.63	-19.37
114.574077	Vert	100	107	14.10	9.90	24.00	-19.50
141.936621	Vert	100	0	13.10	10.31	23.41	-20.09
37.502363	Vert	100	70	13.80	5.89	19.69	-20.31
133.949789	Vert	100	0	12.50	9.93	22.43	-21.07

Emissions Plots

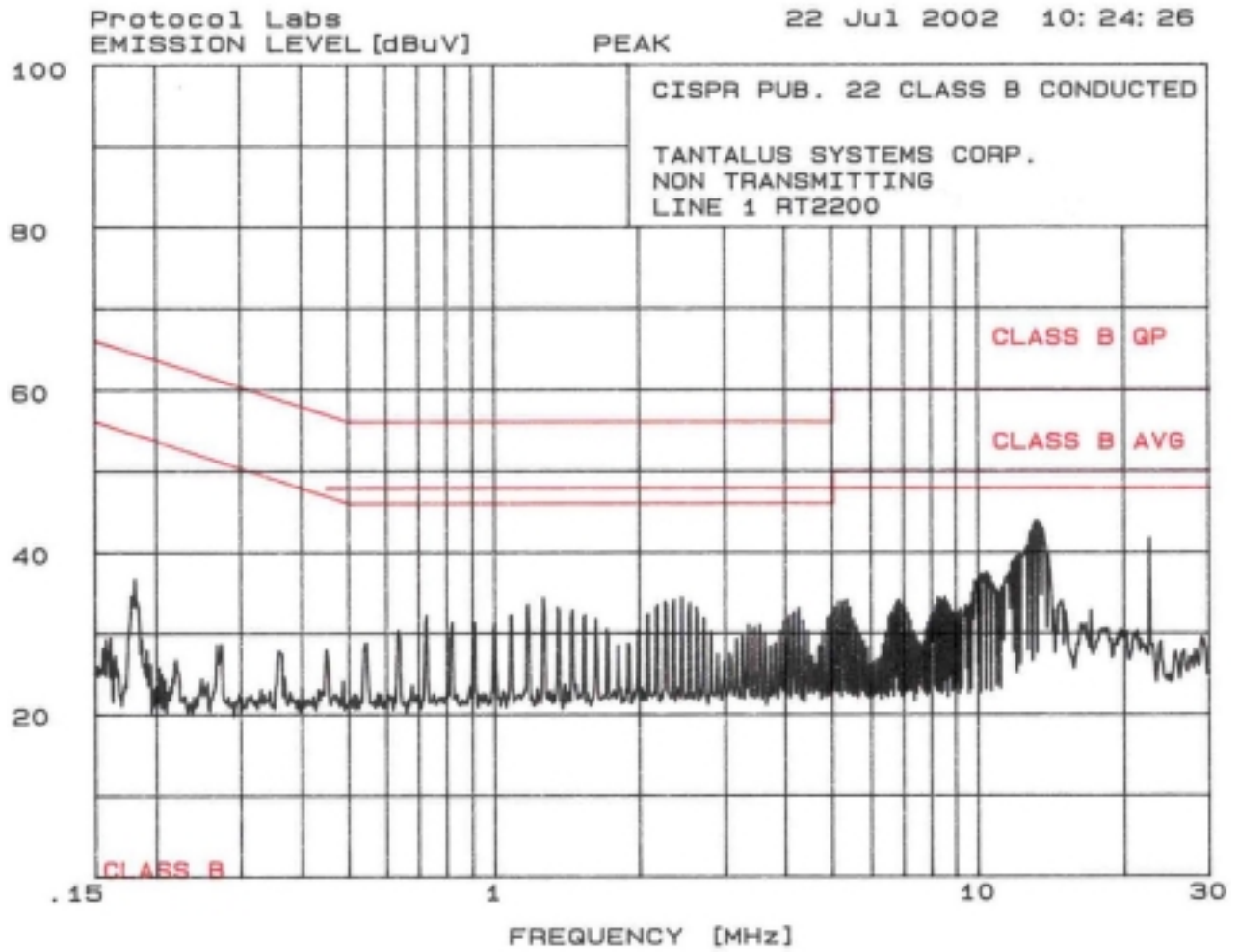

Receiving Line 1

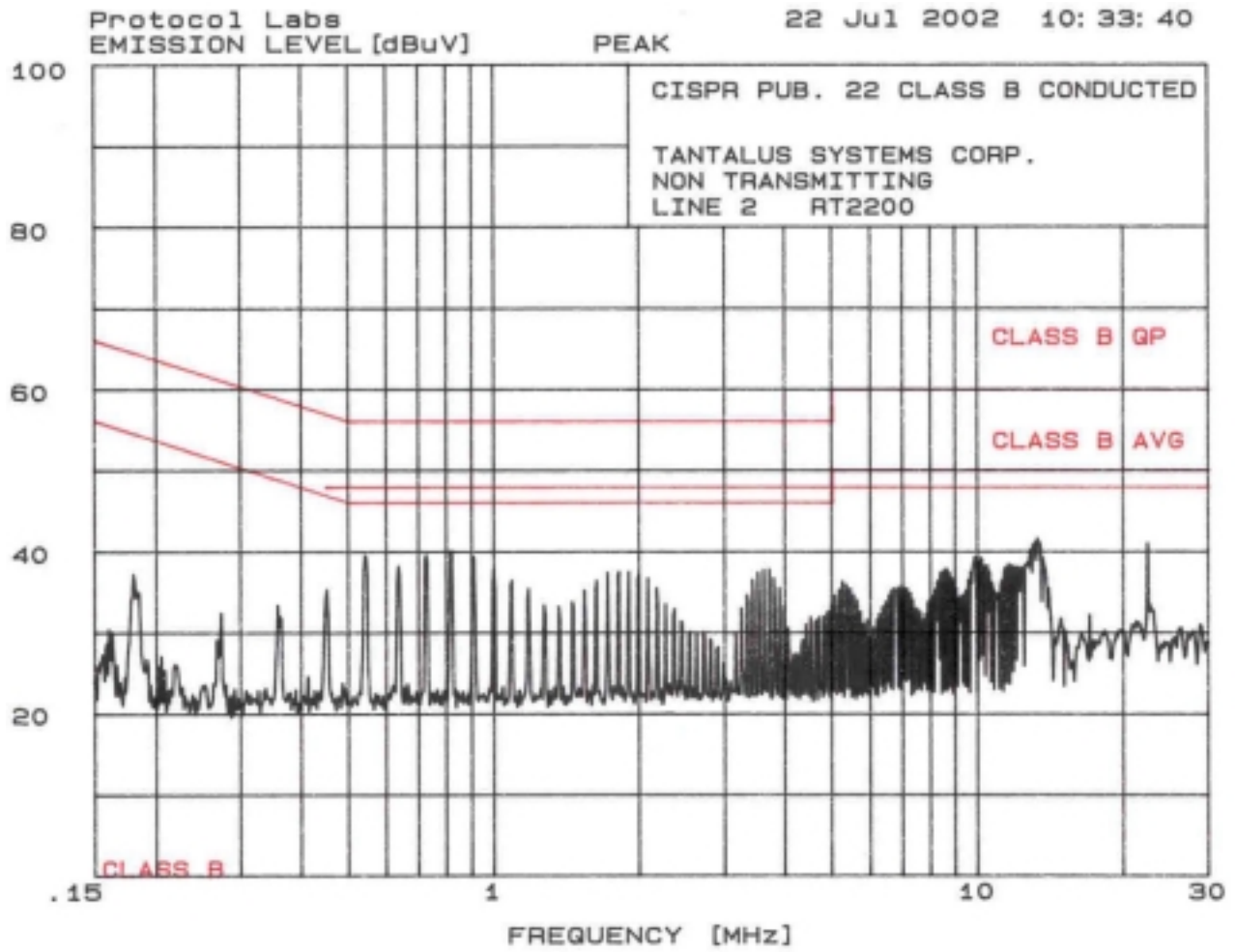

Receiving Line 2

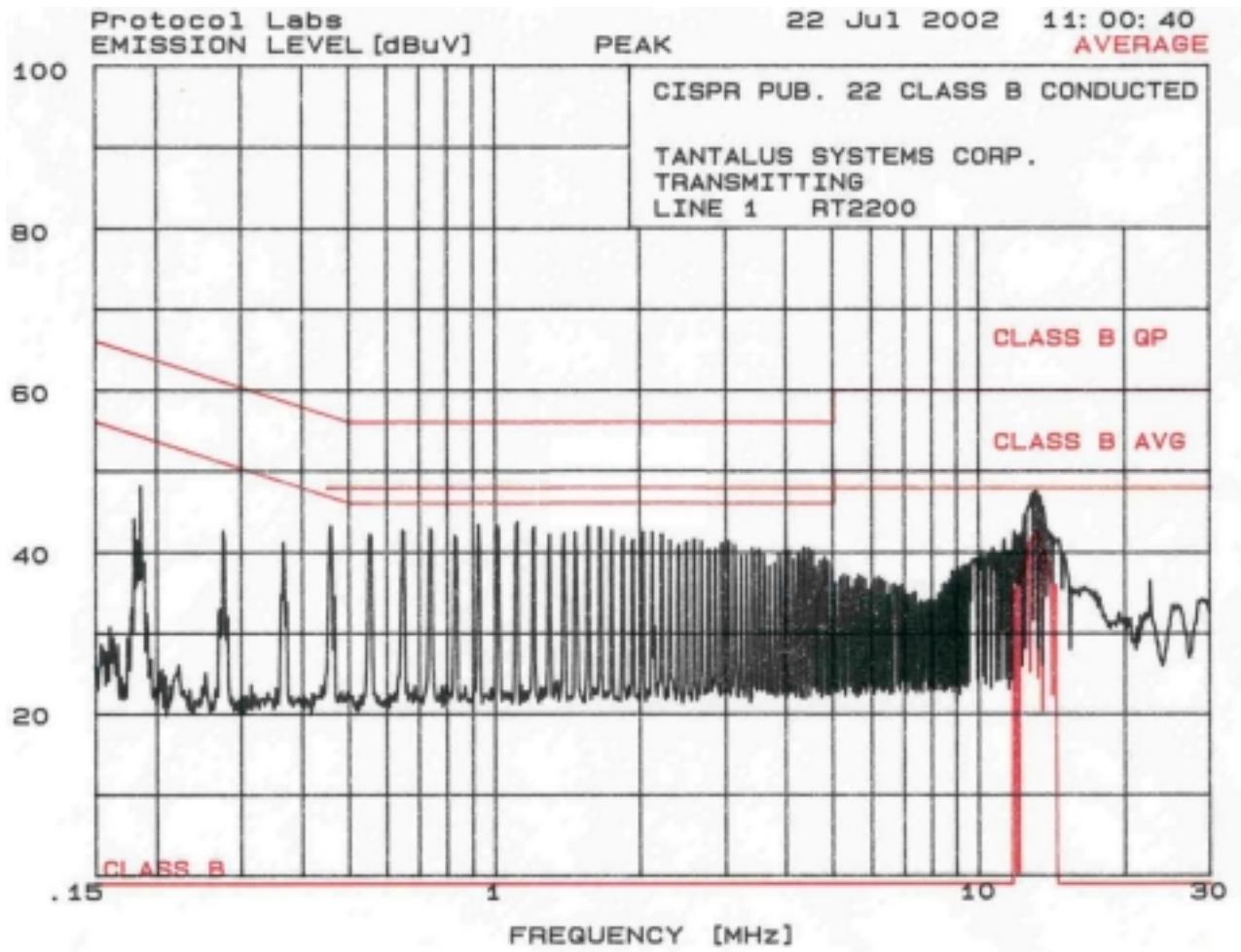

Transmitting Line 1

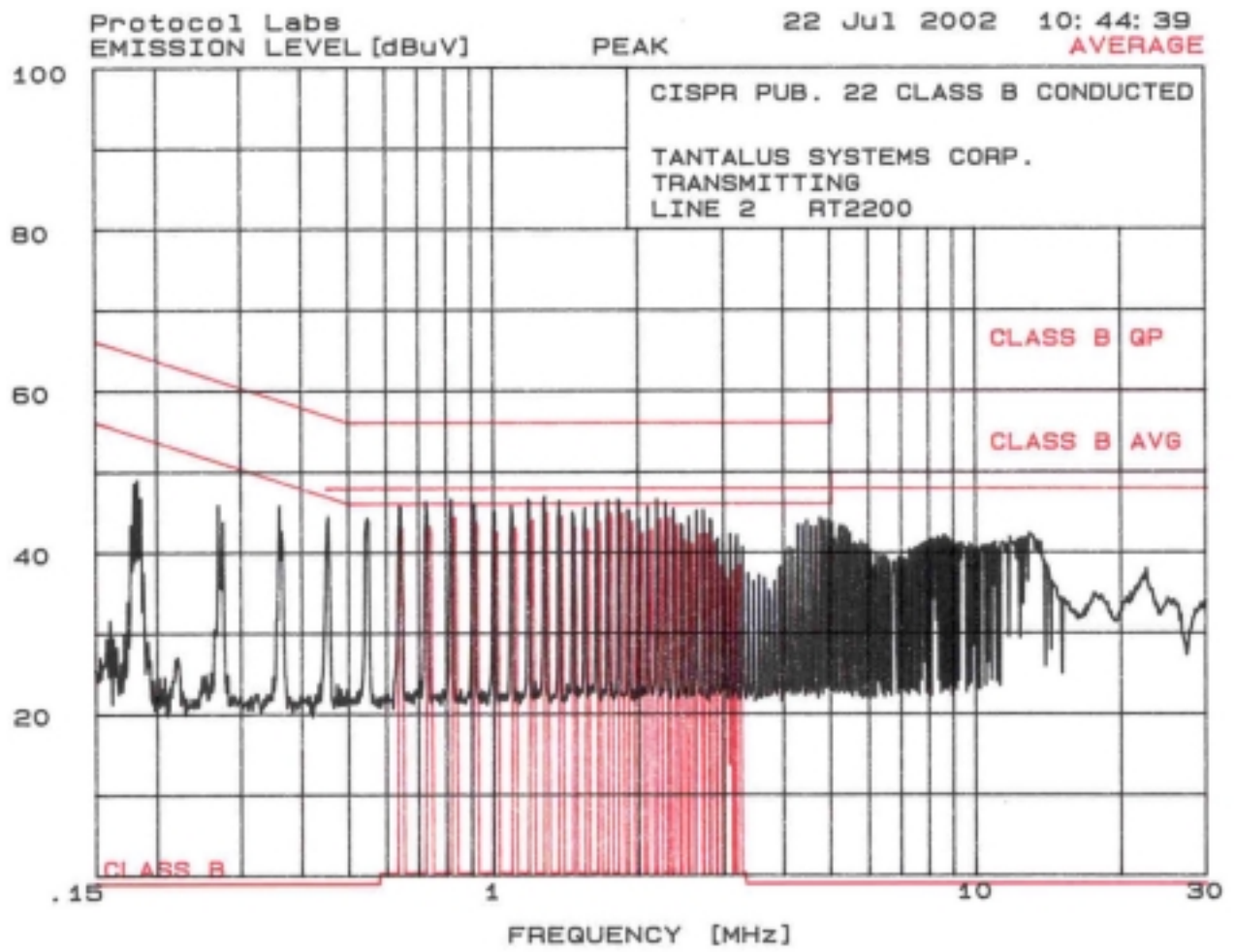

Transmitting Line 2

7/4/02 12:37:27

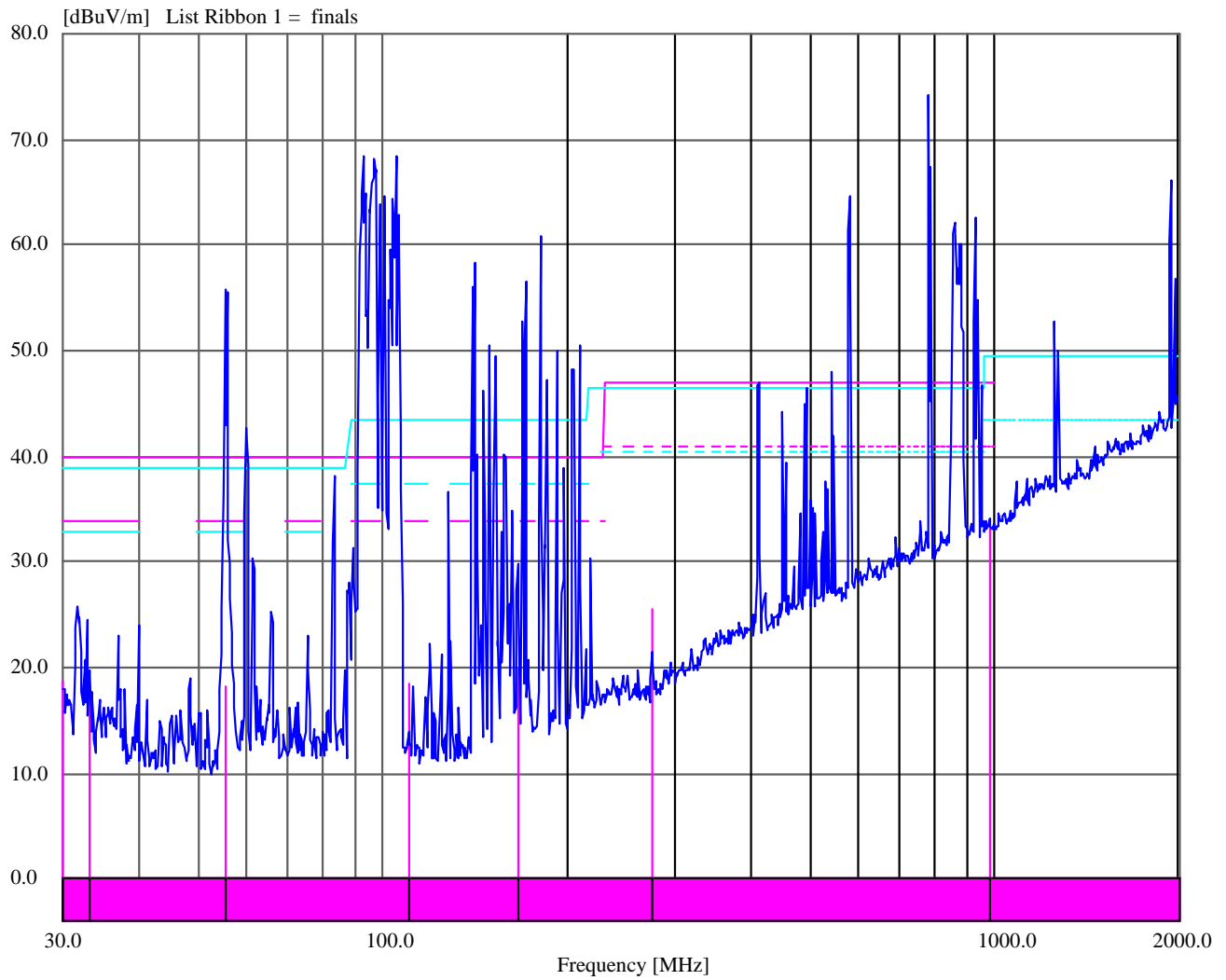

— FCC Limit

- - - 10 dB below FCC Limit

— CISPR Limit

- - - 10 dB below CISPR Limit



(Dark Blue Traces) All Emissions including ambient noise.



(Vertical Pink Line) – Markings of each Suspect Frequency
("X") – indicates Quasi-Peak

Radiated Emission

Appendix C: Radiated Spurious Emissions

Spurious Emissions For 221.00247 MHz

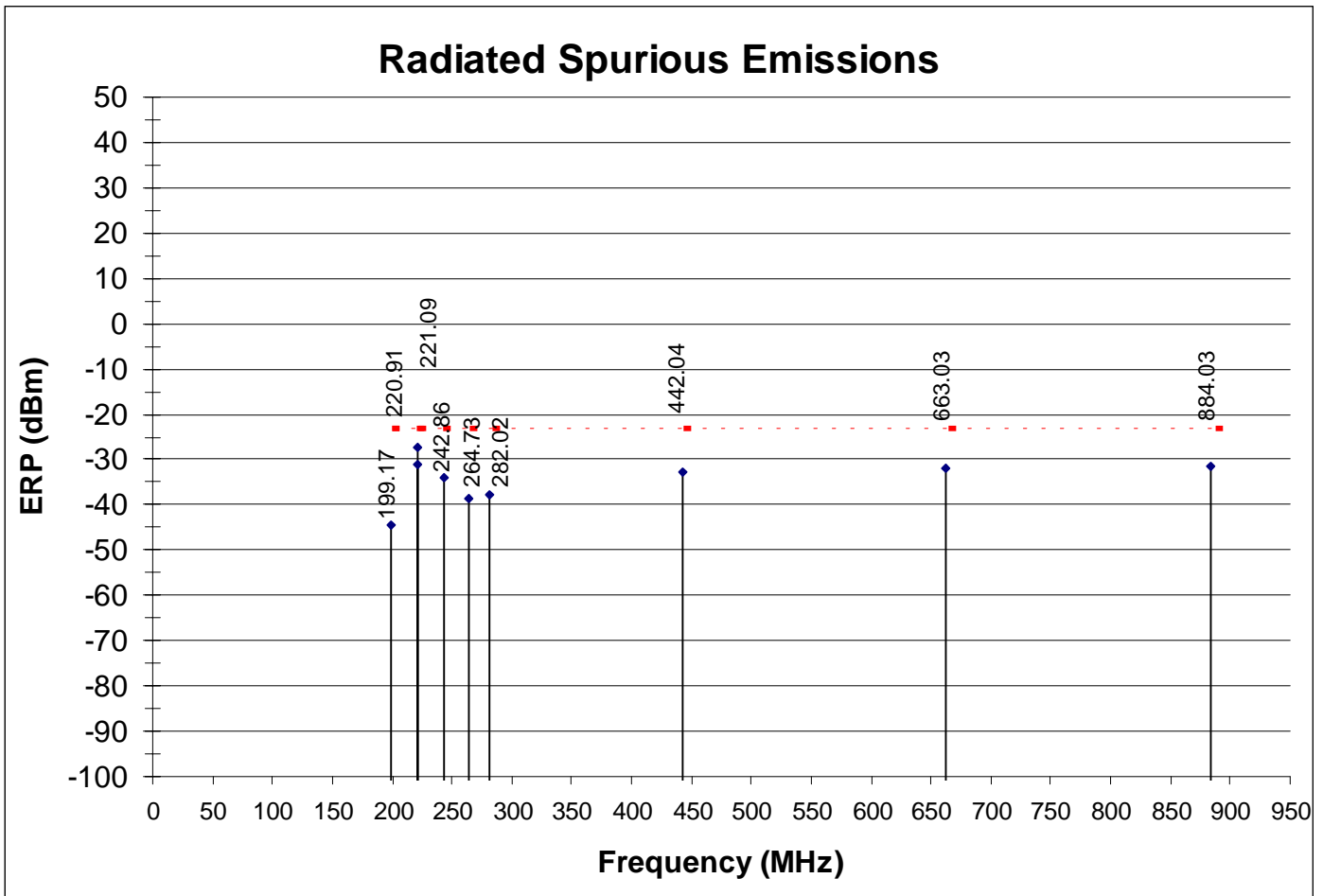

Frequency (MHz)	Polarity	Uncor Pk (dBuV)	Tot Corr (dB)	Peak (dbuV/m)	Limit (dBm)	subs AF	dipole AF	ERP	dBc
199.1711	V	26.4	24.1	50.5	-23	11.8	16.20	-44.35	-84.35
220.9096	V	45.4	19.06	64.46	-23	11.2	17.10	-30.99	-70.99
221.0996	V	49.2	19.06	68.26	-23	11.2	17.11	-27.20	-67.20
242.8617	V	36.6	25.87	62.47	-23	11.75	17.92	-33.80	-73.80
264.7338	V	32.3	25.74	58.04	-23	12.85	18.67	-38.70	-78.70
282.0253	V	32.1	26.19	58.29	-23	13.4	19.22	-37.73	-77.73
442.0402	V	33.1	31.57	64.67	-23	16.4	23.12	-32.85	-72.85
663.0344	V	25.4	35.86	61.26	-23	19.95	26.65	-31.74	-71.74
884.0322	V	22.9	38.41	61.31	-23	22.55	29.14	-31.38	-71.38

Spurious Emissions For 221.497500 MHz

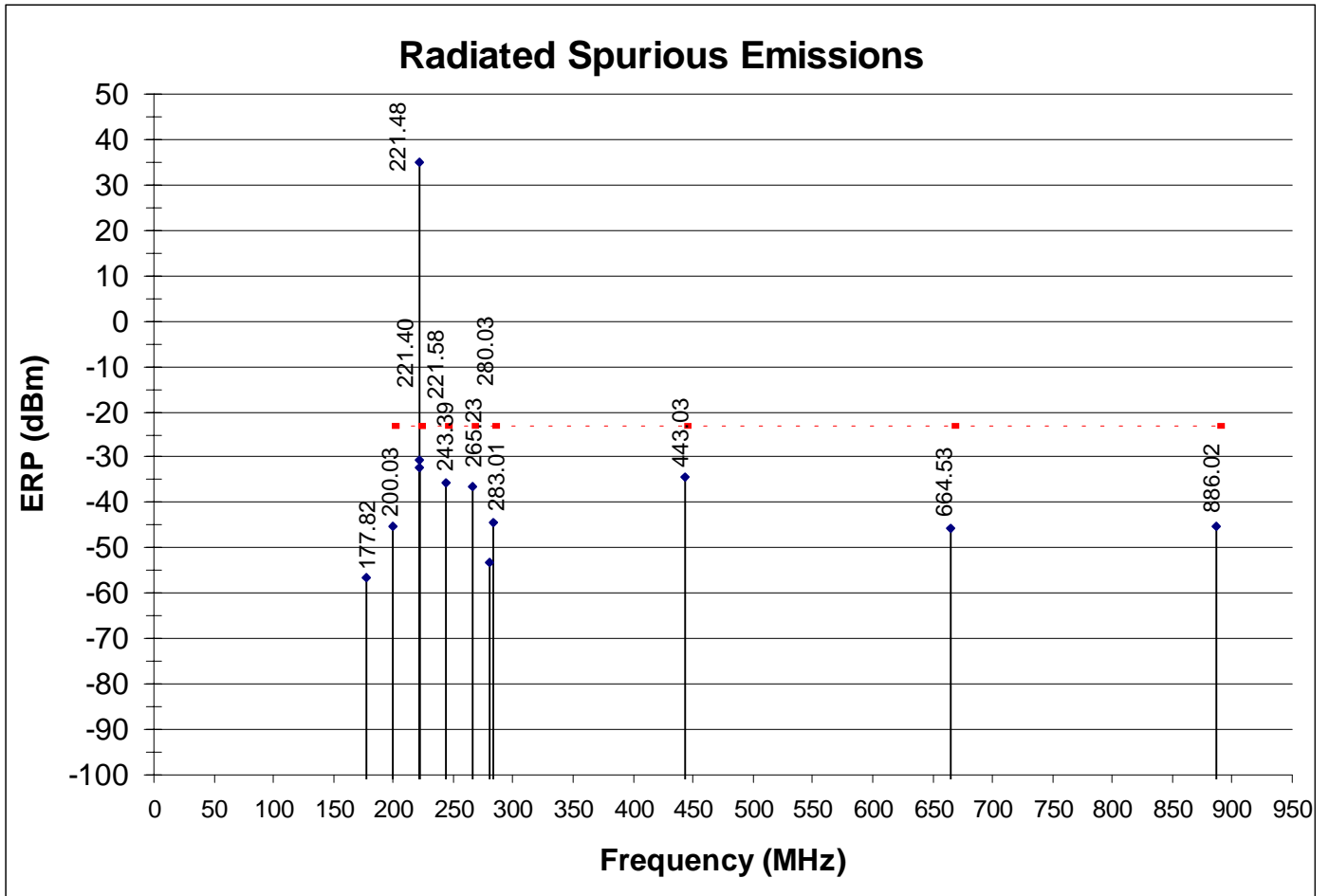

Frequency (MHz)	Polarity	Uncorr Pk (dBuV)	Tot Corr (dB)	Peak (dbuV/m)	Limit dBc (dBm)	subs AF	dipole AF	ERP	dBc
177.8268	V	13.40	23.79	37.19	-23	11.8	15.21	-56.67	-96.67
200.0346	V	26.30	23.5	49.80	-23	11.8	16.24	-45.09	-85.09
221.404	V	44.10	19.06	63.16	-23	11.2	17.12	-32.31	-72.31
221.588	V	45.90	19.06	64.96	-23	11.2	17.13	-30.52	-70.52
243.395	V	35.10	25.49	60.59	-23	11.75	17.94	-35.69	-75.69
265.235	V	35.80	25.38	61.18	-23	12	18.69	-36.43	-76.43
280.027	V	17.20	25.65	42.85	-23	13.4	19.16	-53.10	-93.10
283.0057	V	25.50	25.93	51.43	-23	13.4	19.25	-44.61	-84.61
443.026	V	32.00	31.34	63.34	-23	16.4	23.14	-34.20	-74.20
664.534	V	12.10	35.23	47.33	-23	19.95	26.67	-45.68	-85.68
886.0238	V	8.90	38.59	47.49	-23	22.55	29.16	-45.22	-85.22

Spurious Emissions For 221.997470 MHz

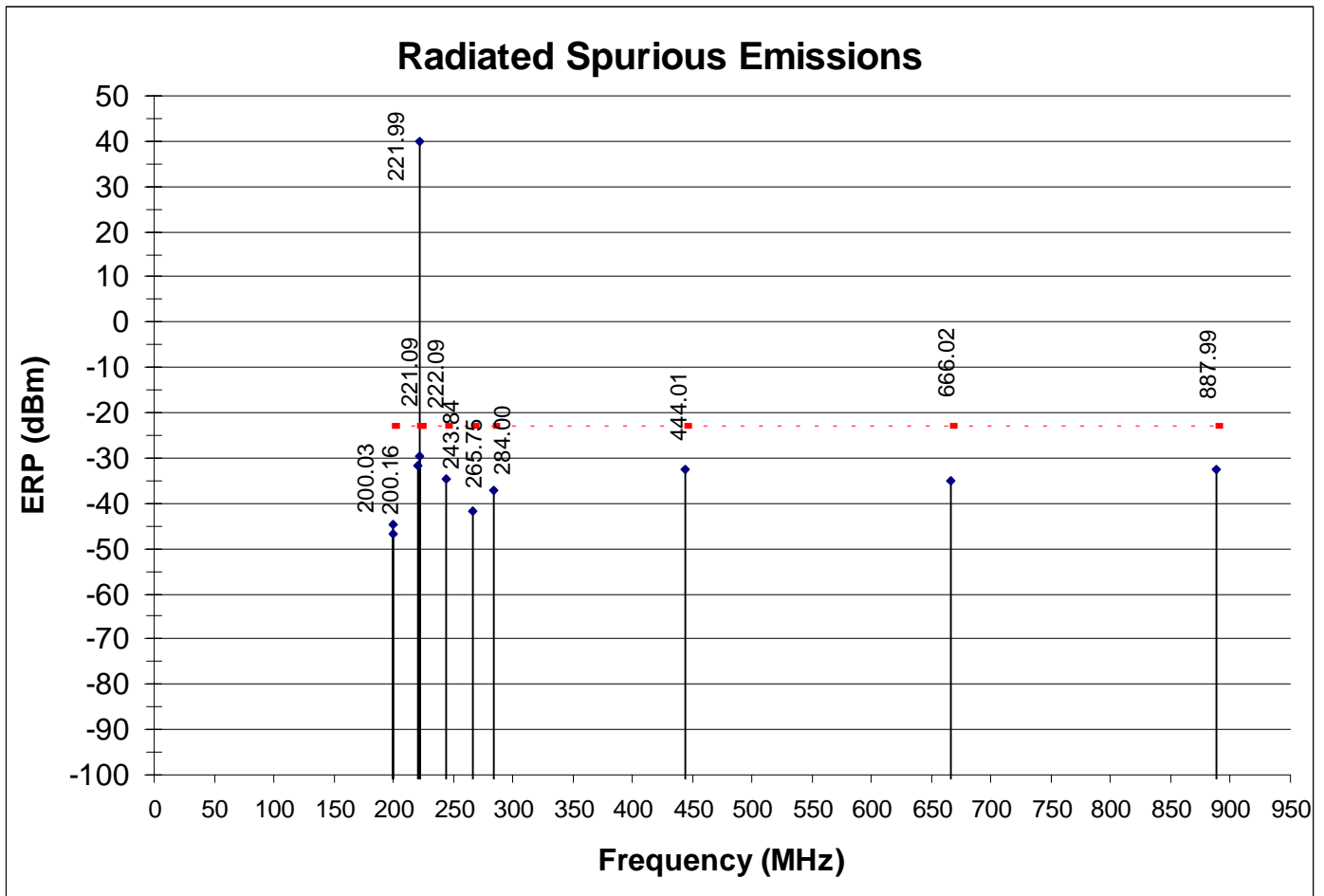

Frequency (MHz)	Polarity	Uncor Pk (dBuV)	Tot Corr (dB)	Peak (dbuV/m)	Limit dBc (dBm)	Subs AF	Dipole AF	ERP	dBc
200.034	V	23.9	24	47.9	-23	11.8	16.24	-46.99	-86.99
200.16	V	26.1	24.01	50.11	-23	11.8	16.24	-44.78	-84.78
221.092	V	44.5	19.09	63.59	-23	11.2	17.11	-31.87	-71.87
222.097	V	46.9	19.09	65.99	-23	11.2	17.15	-29.51	-69.51
243.846	V	35.6	25.9	61.5	-23	11.75	17.96	-34.81	-74.81
265.755	V	29.5	25.72	55.22	-23	12.85	18.70	-41.55	-81.55
284.001	V	32.5	26.37	58.87	-23	13.4	19.28	-37.21	-77.21
444.015	V	33.3	31.71	65.01	-23	16.4	23.16	-32.55	-72.55
666.0247	V	22.2	35.93	58.13	-23	19.95	26.68	-34.90	-74.90
887.997	V	21.8	38.34	60.14	-23	22.55	29.18	-32.59	-72.59

Appendix D: Occupied Bandwidth

Occupied Bandwidth for 221.00247 MHz

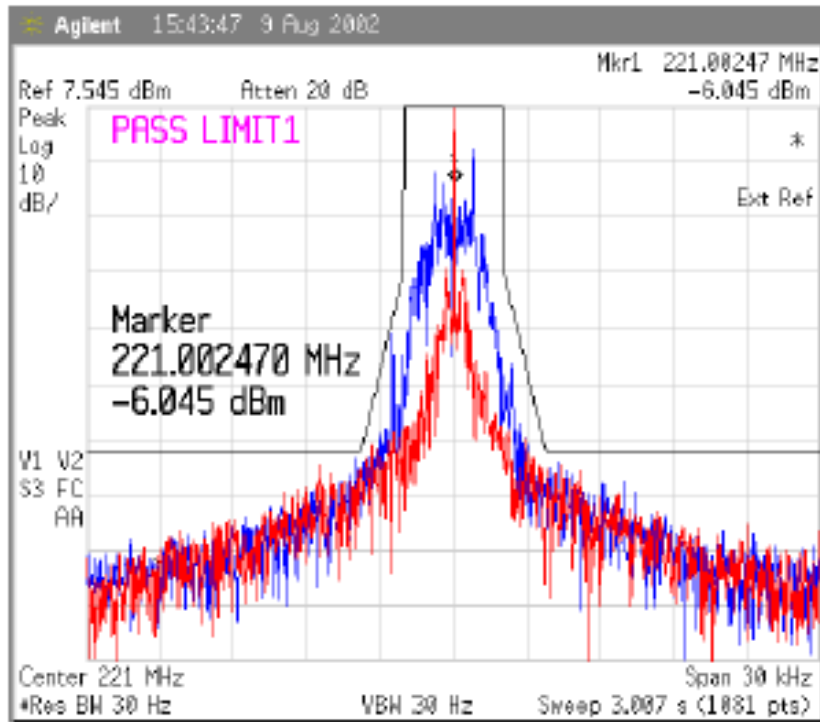

1600 bps

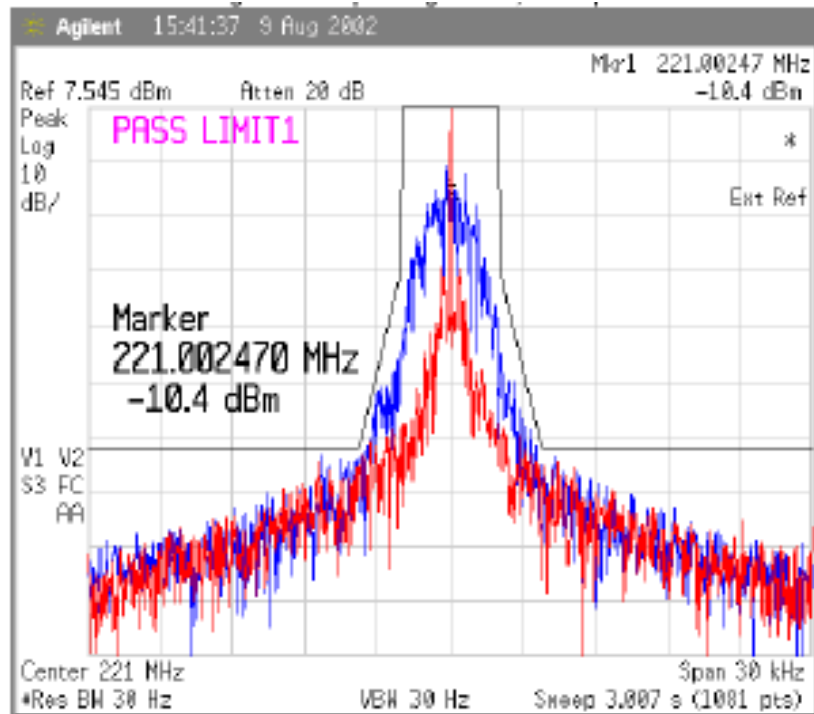

3200 bps

Occupied Bandwidth for 221.497470 MHz

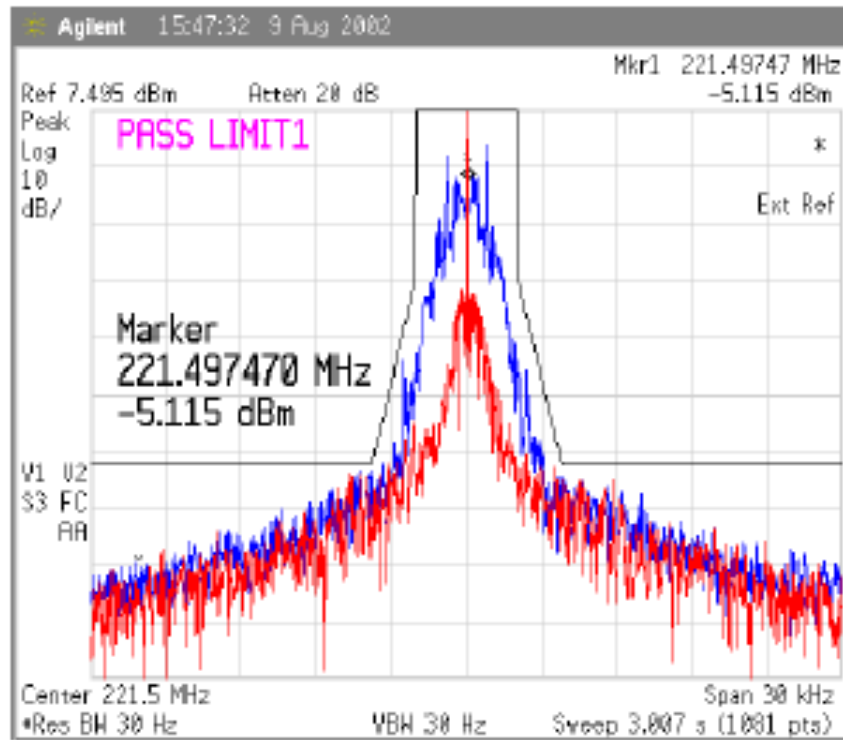

1600 bps

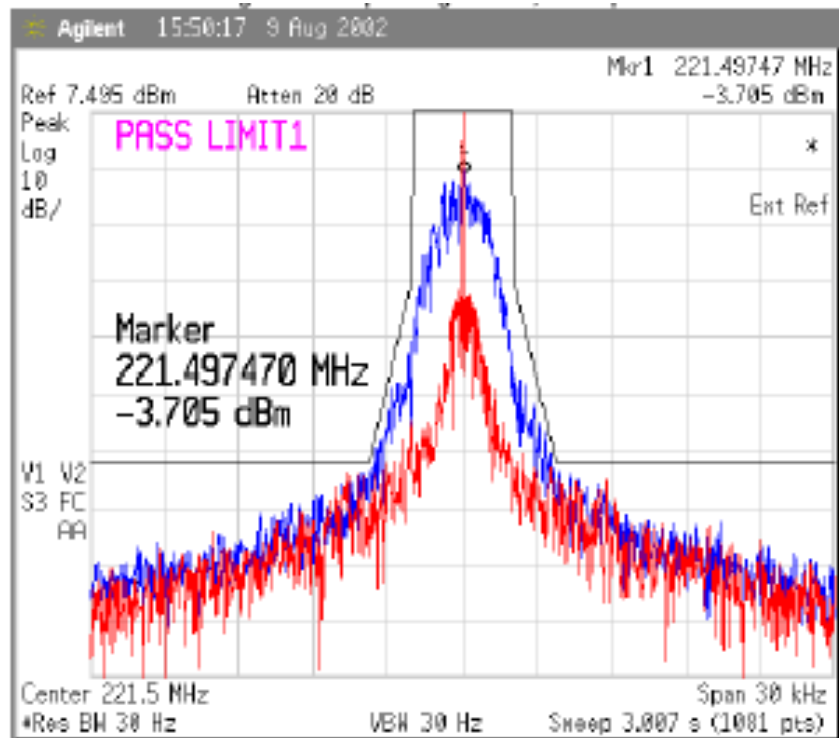

3200 bps

Occupied Bandwidth for 221.997470 MHz

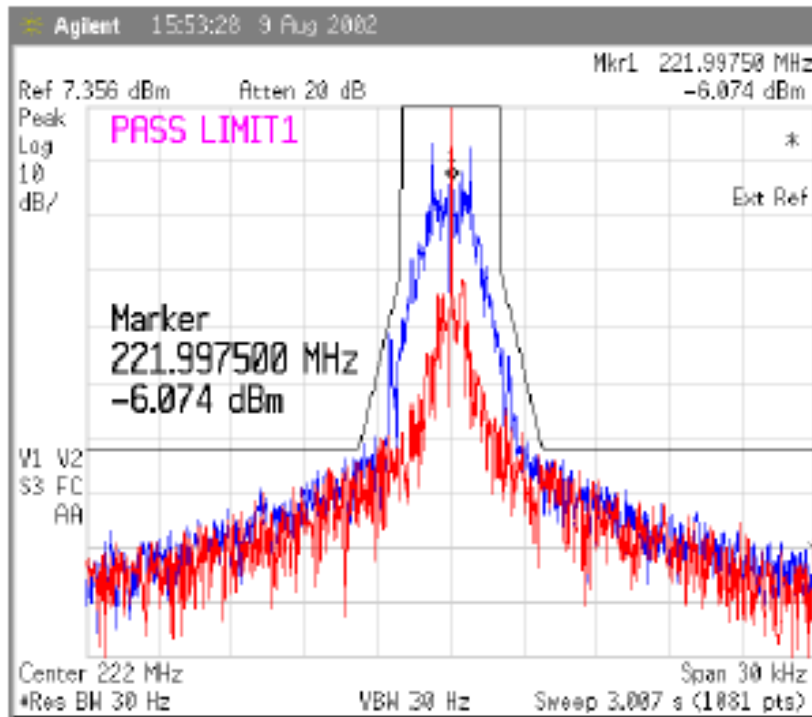

1600 bps

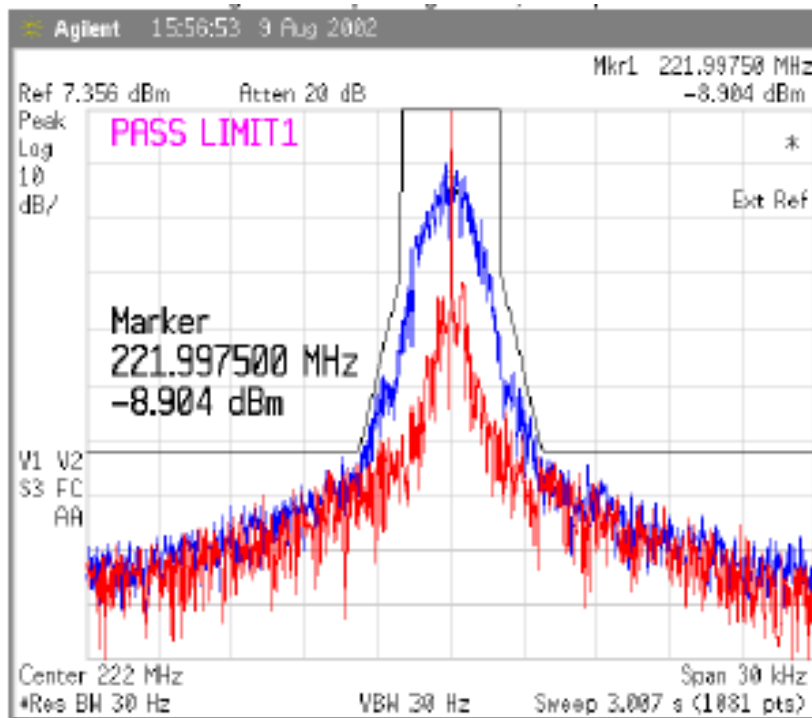

3200 bps

Low Channel Fundamental

Harmonic	Frequency (MHz)	Polarity	Uncor Pk (dBuV)	Tot Corr (dB)	Peak (dbuV/m)	Subs AF	Dipole AF	ERP
1	221.02	Vert	112.8	19.46	132.26	11.2	17.10	36.80

Mid Channel Fundamental

Harmonic	Frequency (MHz)	Polarity	Uncor Pk (dBuV)	Tot Corr (dB)	Peak (dbuV/m)	Subs AF	Dipole AF	ERP
1	221.4975	Vert	111.2	19.5	130.7	11.2	17.12	35.22

High Channel Fundamental

Harmonic	Frequency (MHz)	Polarity	Uncor Pk (dBuV)	Tot Corr (dB)	Peak (dbuV/m)	Subs AF	Dipole AF	ERP
1	221.9975	Vert	112.94	19.53	132.47	11.2	17.14	36.97

Appendix E: Harmonic Measurements

Harmonics for 221.00247 MHz

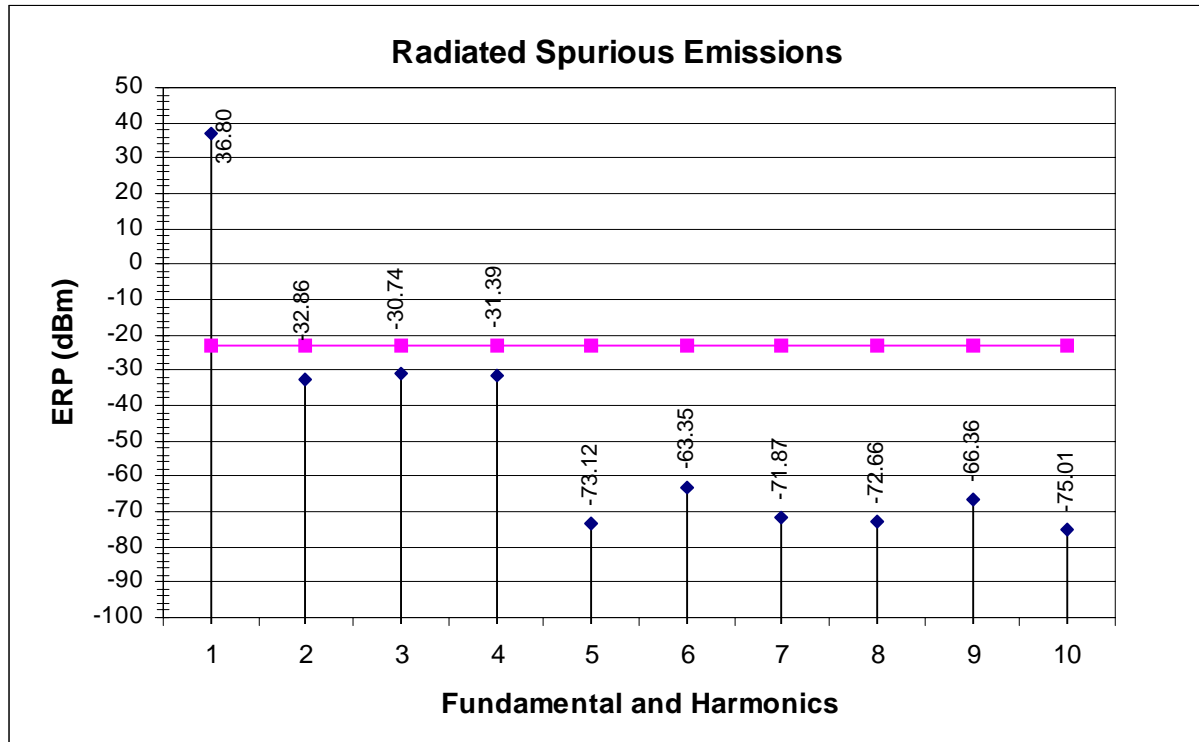

Harmonic	Frequency (MHz)	Polarity	Uncorr Pk (dBuV)	Tot Corr (dB)	Peak (dbuV/m)	Limit dBc (dBm)	Subs AF	Dipole AF	ERP	dBc
2nd	442.04	V	33.1	31.57	64.67	-23	16.4	23.12	-32.85	-72.85
3rd	663.06	V	25.4	36.86	62.26	-23	19.95	26.65	-30.74	-70.74
4th	884.08	V	22.9	38.41	61.31	-23	22.55	29.14	-31.38	-71.38
5th	1105.1	V	-12	40.96	28.96	-23	26.2	31.08	-73.12	-113.12
6th	1326.12	V	-12	51.96	39.96	-23	26.7	32.67	-63.35	-103.35
7th	1547.14	V	-12	44.54	32.54	-23	27.2	34.01	-71.87	-111.87
8th	1768.16	V	-12	44.16	32.16	-23	28.35	35.17	-72.66	-112.66
9th	1989.18	V	-12	49.13	37.13	-23	29.5	36.19	-66.36	-106.36
10th	2210.2	V	-12	52	40	-23	7.4	37.10	-73.50	-113.50

Harmonics for 221.49750 MHz

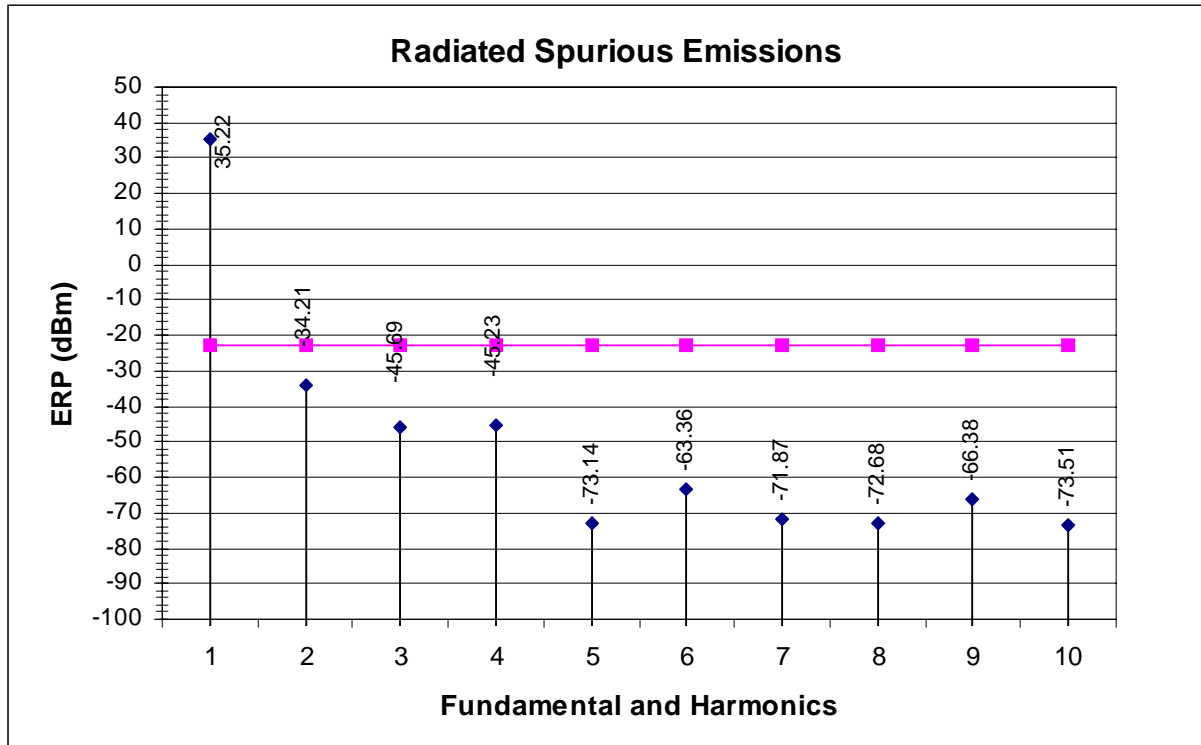

Harmonic	Frequency (MHz)	Polarity	Uncorr Pk (dBUV)	Tot Corr (dB)	Peak (dbuV/m)	Limit dBc (dBm)	Subs AF	Dipole AF	ERP	dBc
2nd	442.9949	V	32	31.341	63.341	-23	16.4	23.14781	-34.2068	-74.2068
3rd	664.4924	V	12.1	35.231	47.331	-23	19.95	26.66963	-45.6886	-85.6886
4th	885.9899	V	8.9	38.59	47.49	-23	22.55	29.16841	-45.2284	-85.2284
5th	1107.487	V	-12	40.96	28.96	-23	26.2	31.1066	-73.1406	-113.141
6th	1328.985	V	-12	51.96	39.96	-23	26.7	32.69023	-63.3642	-103.364
7th	1550.482	V	-12	44.56	32.56	-23	27.2	34.02917	-71.8693	-111.869
8th	1771.98	V	-12	44.16	32.16	-23	28.35	35.18901	-72.679	-112.679
9th	1993.477	V	-12	49.13	37.13	-23	29.5	36.21206	-66.3824	-106.382
10th	2214.975	V	-12	52	40	-23	7.4	37.10846	-73.5085	-113.508

Harmonics for 221.997470 MH

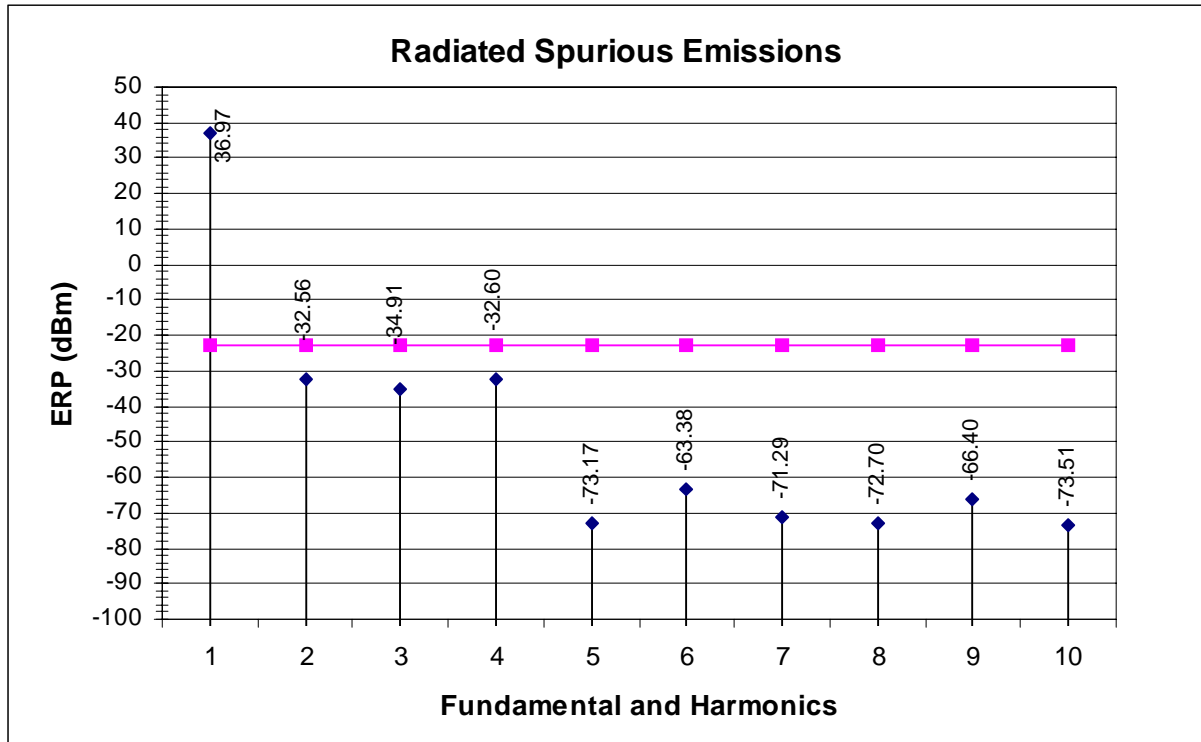

Harmonic	Frequency (MHz)	Polarity	Uncorr Pk (dBUV)	Tot Corr (dB)	Peak (dbuV/m)	Limit dBc (dBm)	Subs AF	Dipole AF	ERP	dBc
2nd	443.995	V	33.3	31.71	65.01	-23	16.4	23.16739	-32.5574	-72.5574
3rd	665.9925	V	22.2	35.93	58.13	-23	19.95	26.68922	-34.9092	-74.9092
4th	887.99	V	21.8	38.34	60.14	-23	22.55	29.18799	-32.598	-72.598
5th	1109.988	V	-12	40.96	28.96	-23	26.2	31.1262	-73.1656	-113.166
6th	1331.985	V	-12	51.96	39.96	-23	26.7	32.70982	-63.3838	-103.384
7th	1553.983	V	-12	44.56	32.56	-23	27.2	34.04876	-71.2898	-111.29
8th	1775.98	V	-12	44.16	32.16	-23	28.35	35.20859	-72.6986	-112.699
9th	1997.978	V	-12	49.13	37.13	-23	29.5	36.23165	-66.4019	-106.402
10th	2219.975	V	-12	52	40	-23	7.4	37.10846	-73.5085	-113.508

Appendix F: Frequency Stability Over Temperature Variation

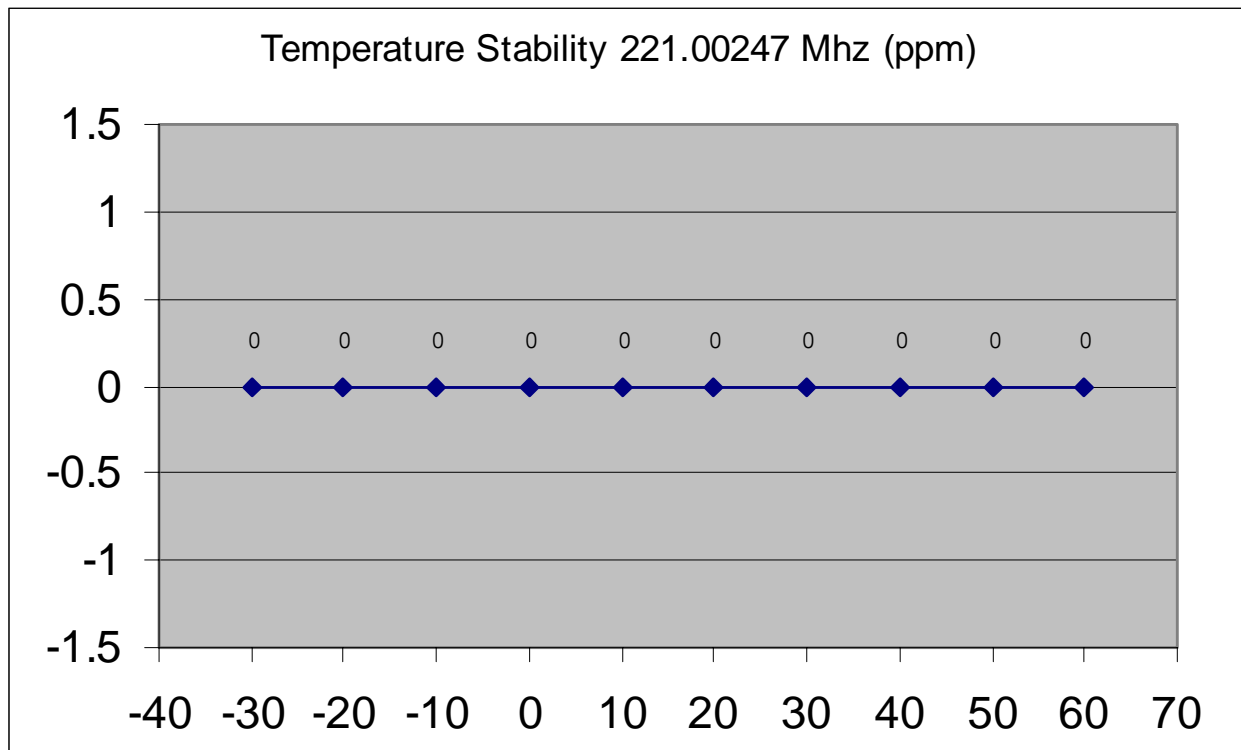

Frequency Stability VS. Temperature
 Specified Limits: +/- 1.5 ppm (-30°C to +60°C)

Temp (°C)	Stability (ppm)	Deviation (MHz)
-30	0.00	0.00
-20	0.00	0.00
-10	0.00	0.00
0	0.00	0.00
10	0.00	0.00
20	0.00	0.00
30	0.00	0.00
40	0.00	0.00
50	0.00	0.00
60	0.00	0.00

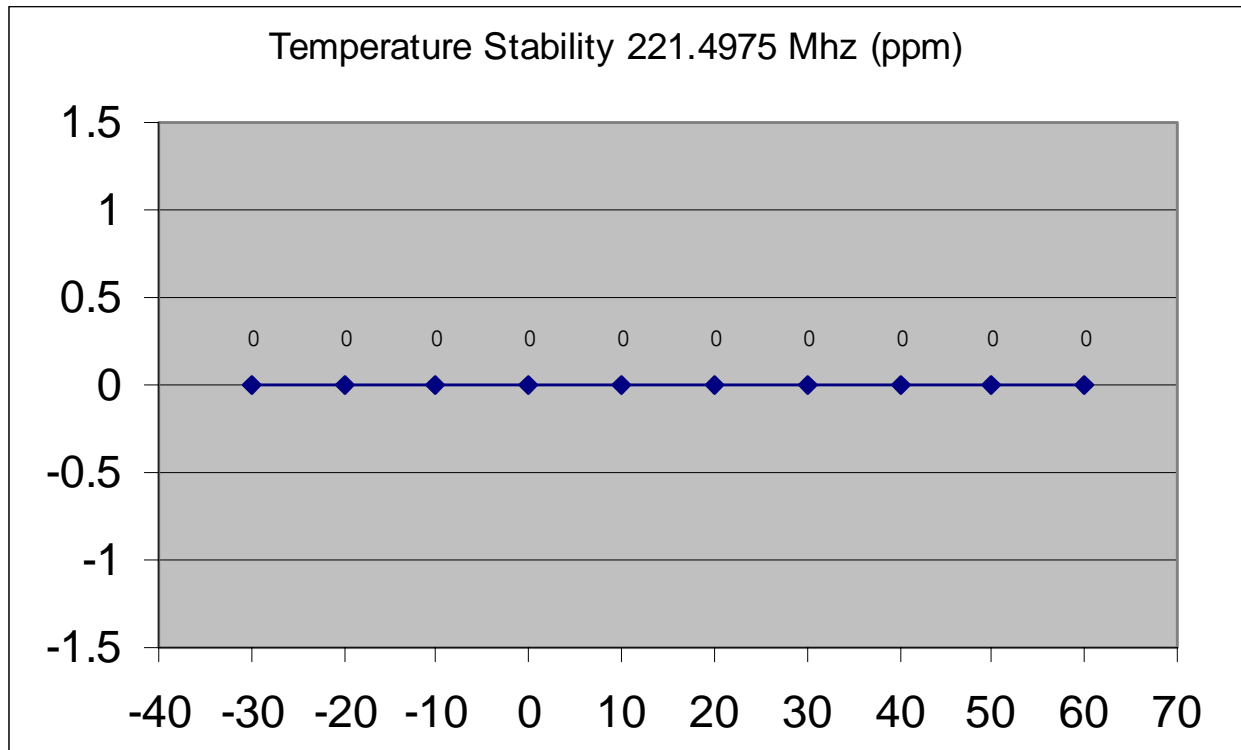

Frequency Stability VS. Temperature
 Specified Limits: +/- 1.5 ppm (-30°C to +60°C)

Temp (°C)	Stability (ppm)	Deviation (MHz)
-30	0.00	0.00
-20	0.00	0.00
-10	0.00	0.00
0	0.00	0.00
10	0.00	0.00
20	0.00	0.00
30	0.00	0.00
40	0.00	0.00
50	0.00	0.00
60	0.00	0.00

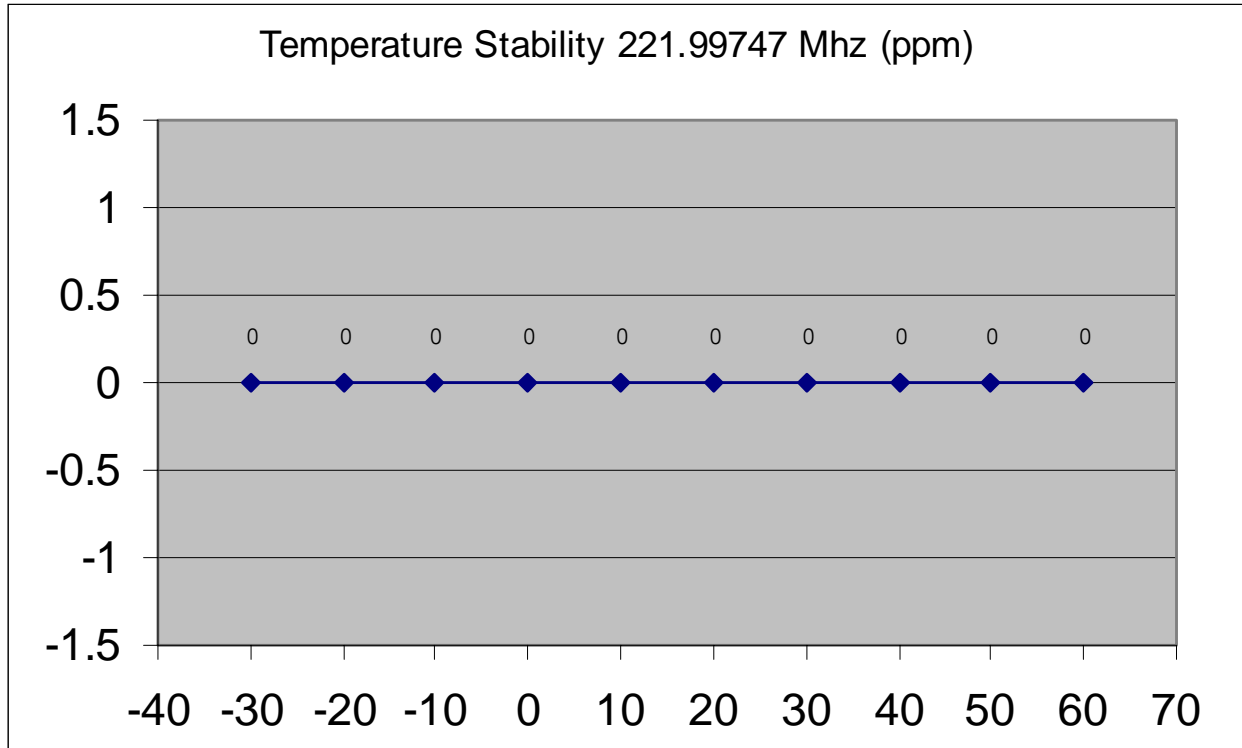

Frequency Stability VS. Temperature
 Specified Limits: +/- 1.5 ppm (-30°C to +60°C)

Temp (°C)	Stability (ppm)	Deviation (MHz)
-30	0.00	0.00
-20	0.00	0.00
-10	0.00	0.00
0	0.00	0.00
10	0.00	0.00
20	0.00	0.00
30	0.00	0.00
40	0.00	0.00
50	0.00	0.00
60	0.00	0.00

Appendix G: Frequency Stability Over Supply Voltage Variation

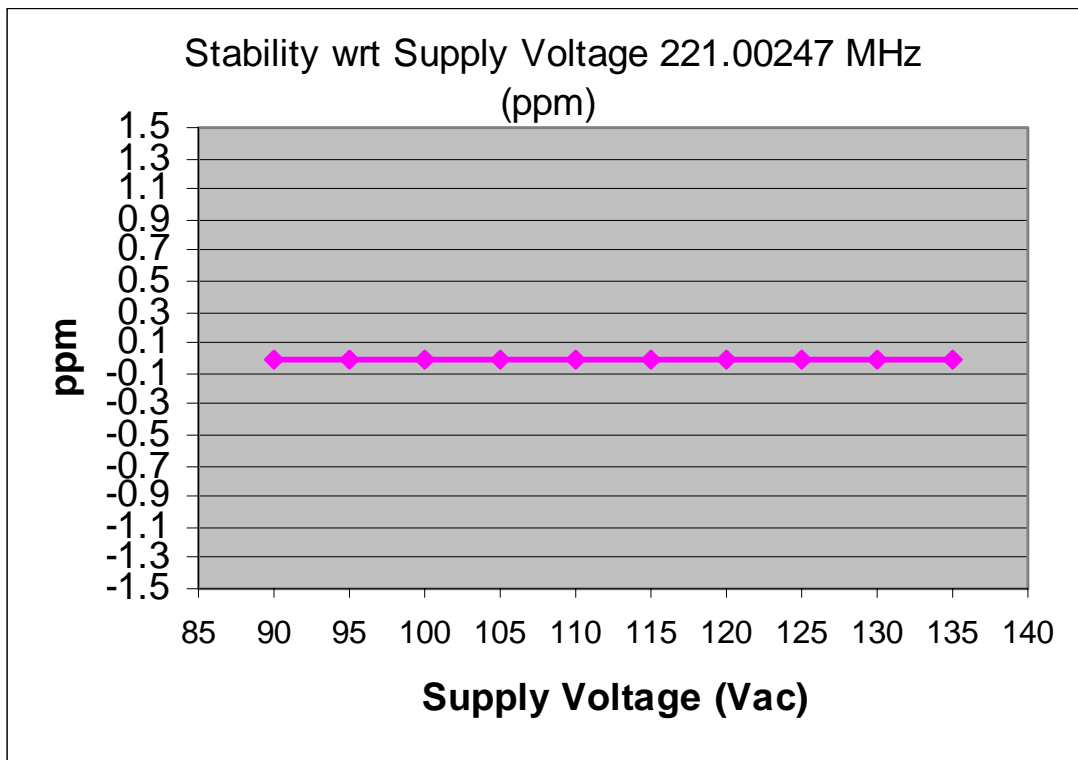

Frequency Stability VS. Supply Voltage

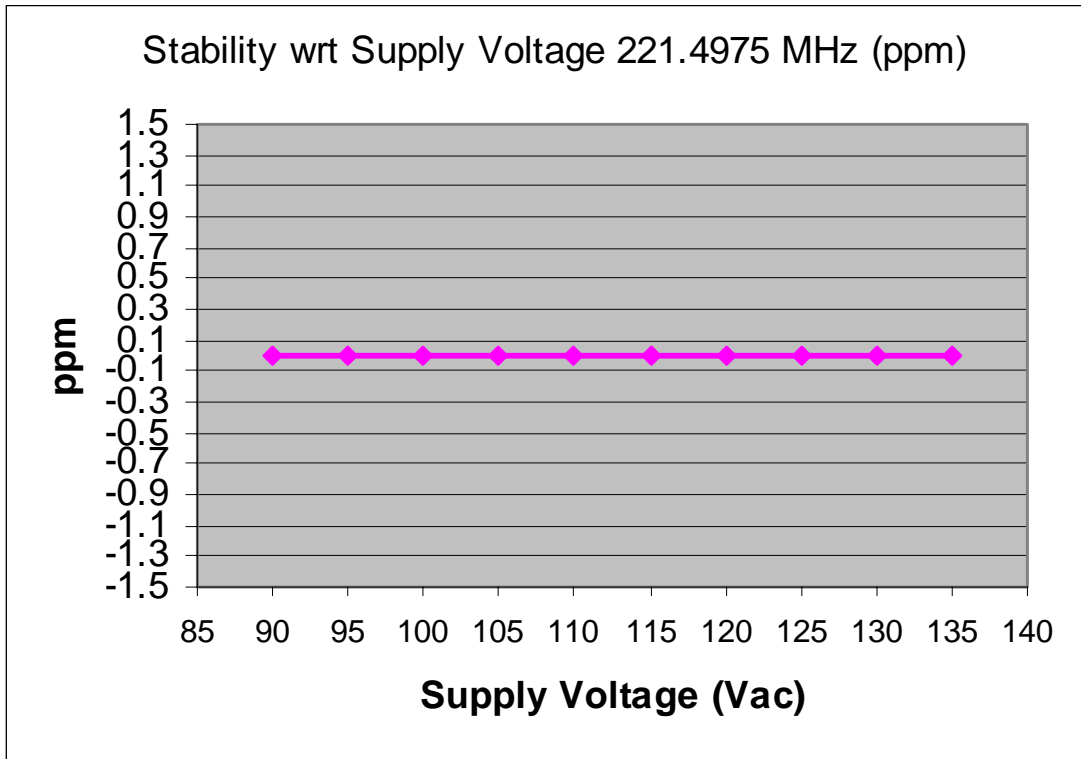

Frequency Stability VS. Supply Voltage

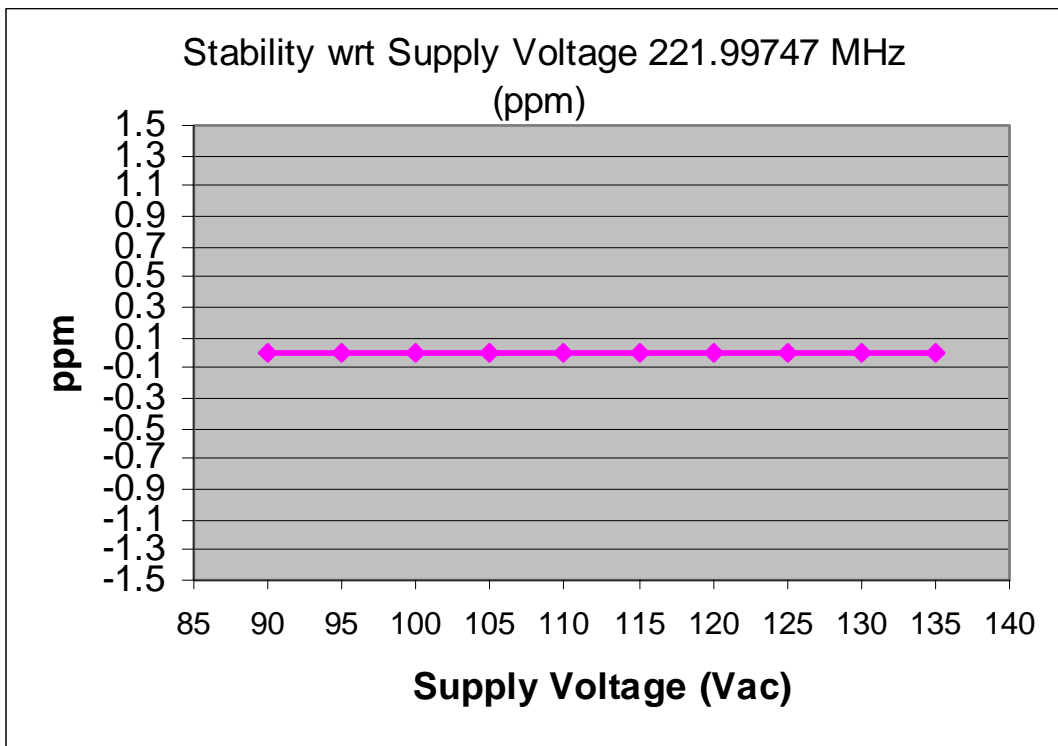

Frequency Stability VS. Supply Voltage