

# Tantalus

**Certification Application for FCC ID  
OZFN22002**

**FCC Test Report for the Tantalus  
TUNet NC-2202 Network Controller.**

**Prepared by:  
Tantalus Systems Corp.  
100-2955 Virtual Way  
Vancouver, BC Canada  
V5M 4X6**

**Document number 960-0005-FCC02**

**Version 1.0**

**Note:** Copyright 1989 – 2006 © **Tantalus Systems Corp.** All rights reserved. No part of this publication, or any software included with it may be reproduced, stored in a retrieval system, or transmitted in any form or by any means including photocopying, electronic, mechanical, recording or otherwise without the prior written permission of the copyright holder. This document contains proprietary information of Tantalus Systems Corporation. The contents are confidential and any disclosure to persons other than the officers, employees, agents or subcontractors of the owner or licensee of this document, without the prior written consent of Tantalus Systems Corp. is strictly prohibited.

## Table of Contents

<b>1</b>	<b>OBJECTIVE.....</b>	<b>3</b>
1.1	General Information.....	3
<b>2</b>	<b>VERIFICATION OF COMPLIANCE .....</b>	<b>4</b>
<b>3</b>	<b>GENERAL INFORMATION .....</b>	<b>5</b>
<b>4</b>	<b>RESULTS SUMMARY .....</b>	<b>6</b>
<b>5</b>	<b>TEST EQUIPMENT LIST .....</b>	<b>7</b>
5.1	Measurement Uncertainty for Power Measurements .....	7
<b>6</b>	<b>TEST RESULTS .....</b>	<b>8</b>
6.1	RF Output Power .....	8
6.2	Occupied Bandwidth .....	9
6.3	Frequency Stability Over Temperature.....	12
6.4	Frequency Stability versus Variation In Primary Supply Voltage.....	25
6.5	Conducted Spurious Emissions At Antenna Terminal .....	30
	<b>REVISION HISTORY.....</b>	<b>34</b>
	<b>APPENDIX A PROTOCOL EMC TEST REPORT .....</b>	<b>35</b>

## 1 Objective

The purpose of this document is to present measured data and technical documentation that demonstrates compliance to the requirements listed in Part 15 of the FCC Rules and Regulations.

### 1.1 General Information

The TUNet NC2202 Network Controller is two-channel transceiver that is an extension of the TUNet NC2200 Network controller (FCC ID: OZFN22001) that operates over a single channel.

The TUNet Network Controller is the heart of the TUNet 220 MHz Wide Area Network. It controls all radio communications over the 220 MHz WAN. The TUNet NC2202 is an intelligent router that receives and buffers upstream messages from 220 MHz WAN Portals and forwards these to the TUNet NS2000 Network Server. Similarly, it also receives downstream messages from the TUNet NS2000 Network Server and transmits these over the 220 MHz WAN to the appropriate endpoint(s). The TUNet NC2202 will have sufficient transmit power and receive sensitivity to communicate with TUNet 3205 WAN Portals within a radius of 20 miles.

The TUNet NC2202 Network Controller communicates over the narrowband 5kHz channel spacing channels allocated in the 220 MHz to 222 MHz frequency band.

The TUNet NC2202 Network Controller is designed to work in conjunction with the TUNet NS2000 Network Server. Messages are received from the 220 MHz WAN and forwarded to the Network Server and vice versa. The TUNet NC2202 assumes a full-time TCP/IP link of sufficient bandwidth to handle the volume of messages received/sent (19,200 baud, full duplex for each active 220 MHz channel). It is acknowledged that in certain harsh installation environments, this TCP/IP link will not always be available; therefore the TUNet NC2202 must be designed in such a way as to operate autonomously when this link is “down”. This means that the TUNet NC2202 will continue to arbitrate communications on the 220 MHz WAN and receive upstream messages until such time as the available storage is exhausted. At this point the TUNet NC2202 will shut down the 220 MHz WAN until the TCP/IP link has been restored.

## 2 Verification of Compliance

Equipment Under Test: Tantalus Utility Network Controller

Model Number: TUNet NC-2202

Serial Number: 00001

Applicant: Tantalus Systems Corp.  
100-2955 Virtual Way.  
Vancouver BC, Canada.  
V5M 4X6.

Tested as Per FCC Rules: FCC Part 15  
FCC Part 90 Subpart I and Subpart T

Date of Tests: June and July 2004.  
March 2006.

Tested By: Robert DeAngelis and Maurizio Nicolletti, Tantalus Systems Corporation.  
David Johansson, Protocol Labs.

The above equipment was tested by Tantalus Systems Corporation and Protocol Labs and is in compliance with the requirements in Part 15 and Part 90 of the FCC Rules and Regulations.

Mark Fairburn  
RF Design Engineer  
Tantalus Systems Corp.

### 3 General Information

Applicant: Tantalus Systems Corp.  
100-2955 Virtual Way.  
Vancouver BC, Canada. V5M 4X6

Contact: Mark Fairburn  
Phone: 604-299-0458  
Fax: 604-451-4111

Equipment Under Test: Tantalus Utility Network Controller.

Model Number: TUNet NC-2202

Serial Number: 00001

Manufacturer: Tantalus Systems Corporation.

Emissions Designator: F1D

FCC ID: OZFN2202

All power line conducted and radiated emission measurements are conducted at the approved test facility mentioned below:

Test Facility: Protocol Labs  
28945 McTavish Road.  
Abbotsford BC, Canada V4X 2E7  
FCC Registration Number 96437  
Industry Canada Registration Number IC3384

Contact: David Johansson  
Phone: 604-607-0012  
Fax: 604-607-0019

## 4 Results Summary

The following is a summary of the tests and measurements performed to demonstrate compliance.

Test	Standard	Description	Result
RF Output Power	2.1046	The RF output power is measured at the lowest and highest power levels being certified for.	Required Measurement
Occupied Bandwidth	2.1049	The occupied bandwidth is measured and defined as the bandwidth where 99% of the emission power is contained.	Required Measurement
Frequency Stability Over Temperature	2.1055(a)/90.210(f)	The frequency stability is measured over the temperature range of – 30 to 50 degrees C and must comply to the emission mask defined in Part 90.210(f)	Complies
Frequency Stability Over Variation in Primary Supply Voltage	2.1055(d)/90.210(f)	The frequency stability is measured over variation in primary supply voltage from 85% to 115% of nominal. The emission must comply to the emission mask defined in part 90.210(f)	Complies
Conducted Spurious Emissions At Antenna Terminal	2.1051/90.210(f)	The conducted spurious emissions at the antenna terminal of the DUT must be less than the limit defined in Part 90.210(f). The level of the spurious emissions with respect to and below the carrier must be $55 + 10\log(P)$	Complies

## 5 Test Equipment List

The following is the list of test equipment used for the conducted RF measurements in this report.

Test Site	Test Equipment	Model Number	Serial Number	Last Calibration	Next Calibration.
Tantalus Engineering Lab.	Rubidium* Frequency Standard	Stanford Research Systems FS725/1	65279	June 10, 2004	
Tantalus Engineering Lab.	Vector Signal Analyzer	Hewlett Packard 89441A	3416A03552	Sept. 22, 2005	Sept.22, 2006
Tantalus Engineering Lab.	30 dB Attenuator	Bird Coaxial Attenuator 8323	2156	Purchased July, 2004	
Tantalus Engineering Lab.	Multimeter*	Keithly 2002 DMM	0943593	April 29, 2004	
Tantalus Engineering Lab	Temperature* Chamber	Burnsco BTHC-3P-3/4-3/4	03-10	April 5, 2004	
Tantalus Engineering Lab	VARIAC*	Superior Electric Co. 116B	N/A	Output set with calibrated multimeter	

\* These instruments were used for the measurements in the test report submitted to the FCC for the single channel Network Controller, NC2200. (FCC ID: OZFN2201). They are re-listed here for completeness, since some of the measurements in this test report cross-reference the measurements submitted in the test report for FCC ID: OZFN2201.

The test equipment list for the radiated measurements is included in the Protocol Labs test report.

### 5.1 Measurement Uncertainty for Power Measurements

Frequency Range	Measurement Uncertainty
200 MHz to 300 MHz	+/- 0.2 dB

## 6 Test Results

### 6.1 RF Output Power

**Requirement:**

Measured as per the requirement of section 2.1046

**Test Procedure:**

The output of the transmitter is coupled to the HP 89441A Vector Signal Analyzer through an attenuator and cable that has its insertion loss precisely measured with the HP 8735D Network Analyzer. The measurements are taken at the lowest and highest channel frequencies and at the lowest and highest power settings.

**Test Set Up:**

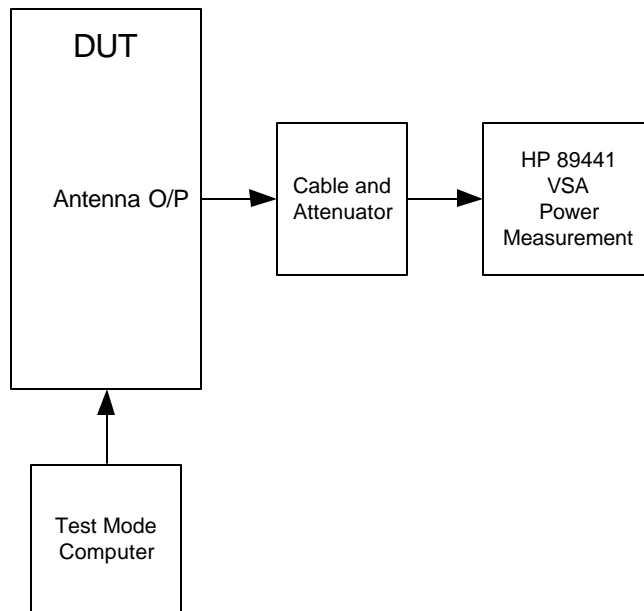

**Measurement Data:**

Frequency, MHz	Low Power, W	High Power, W
220.0025	19.07	49.44
220.9975	20.83	52.12



## 6.2 Occupied Bandwidth

### Requirement:

Measured as per the requirement of Part 2.1049

### Test Procedure:

The output of the DUT transmitter is coupled through an attenuator, directly into the HP89441A Vector Signal Analyzer. The bandwidth where 99% of the mean power is transmitted is determined through measurement. The measurement is performed at the lowest and highest channel frequency.

### Test Set Up:

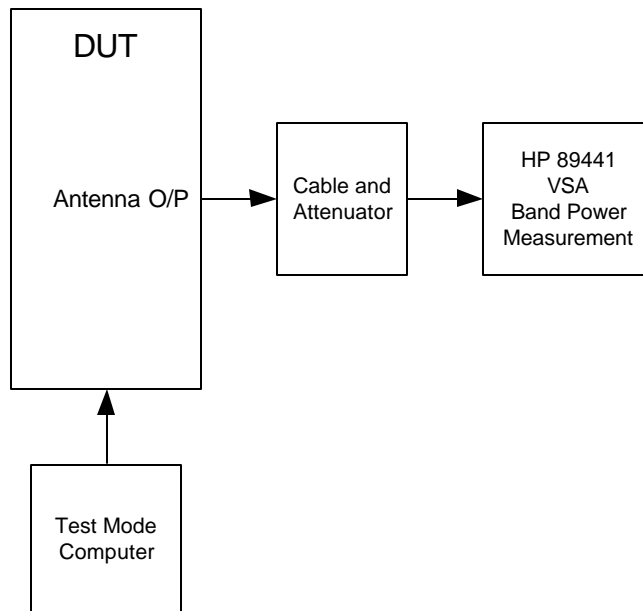

**Measurement Plots:**

Total power reference with the modulation disabled is measured at the lowest channel frequency:

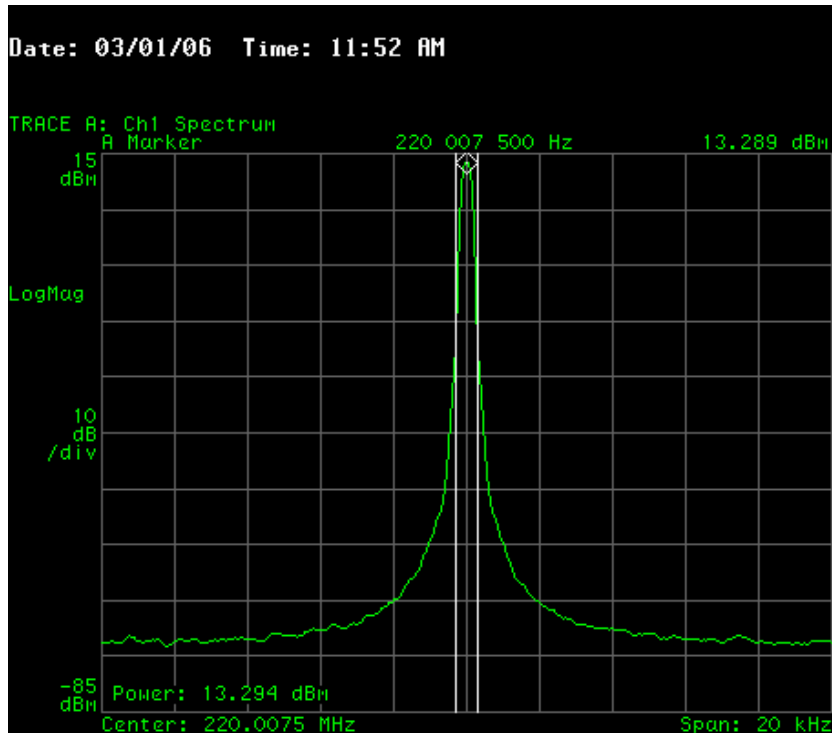

Settings:

Acquisition Mode: Normal  
 RBW: 300 Hz  
 Detector type: Positive Peak  
 Trigger type: Free running  
 Center: 220.0025 MHz  
 Span: 20 kHz

Measurement Result:

The constant envelope power is measured as a reference with the modulation disabled. The relative reference level is 13.294 dBm.

The modulation is enabled and the bandwidth where 99% of the total emission power is determined using the band power marker function of the Vector Signal Analyzer.

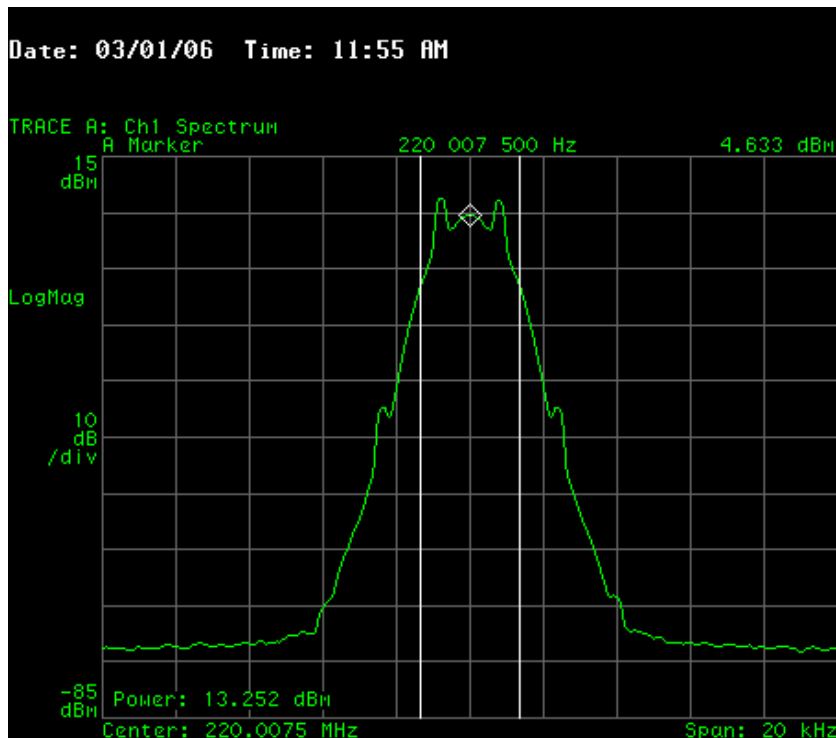

Settings:

Acquisition Mode: Normal  
 RBW: 300 Hz  
 Detector type: Positive Peak  
 Trigger type: Free running  
 Center: 220.0025 MHz  
 Span: 20 kHz

Measurement Result:

The 1% of the power not contained in the occupied bandwidth represents a ratio of 0.0436 dB. The bandwidth where 99% of the total emission power is contained is 2.775 kHz. This occurs where the band power is equal to 13.294 dBm – 0.0436 dB.

Total power reference with the modulation disabled is measured at the highest channel frequency:

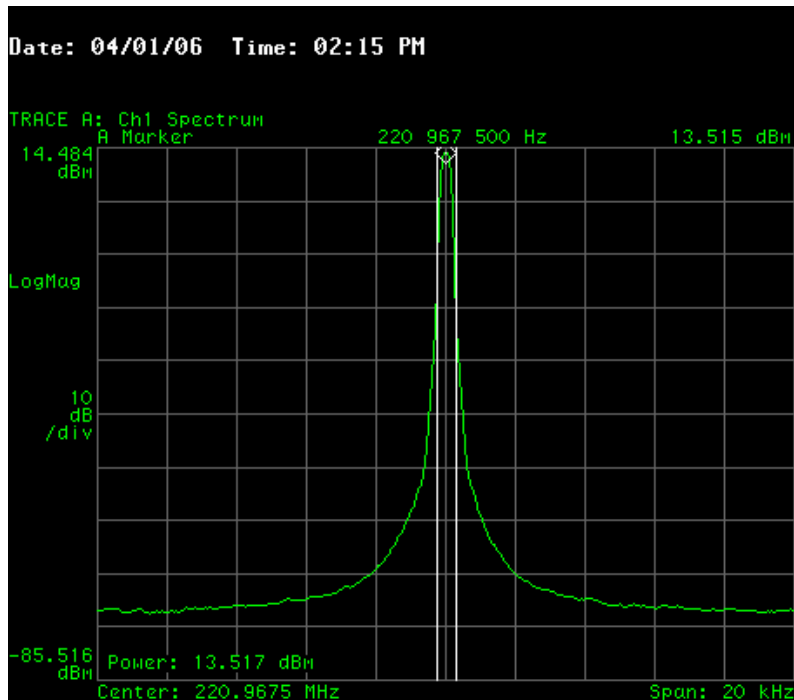

Settings:

- Acquisition Mode: Normal
- RBW: 300 Hz
- Detector type: Positive Peak
- Trigger type: Free running
- Center: 220.9975 MHz
- Span: 20 kHz

Measurement Result:

The constant envelope power is measured as a reference with the modulation disabled. The relative reference level is 13.517dBm.

The modulation is enabled and the bandwidth where 99% of the total emission power is determined using the band power marker function of the Vector Signal Analyzer.

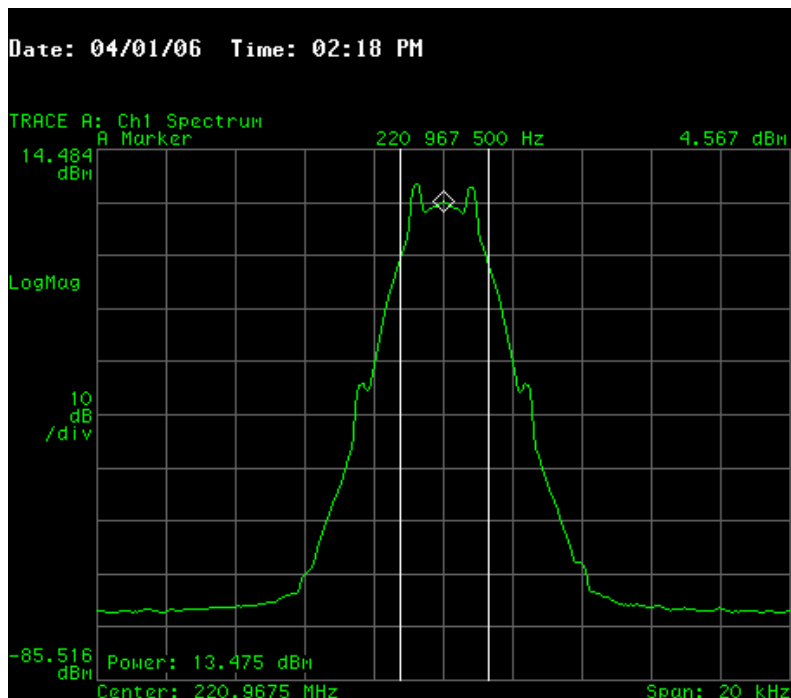

Settings:

- Acquisition Mode: Normal
- RBW: 300 Hz
- Detector type: Positive Peak
- Trigger type: Free running
- Center: 220.9975 MHz
- Span: 20 kHz

Measurement Result:

The 1% of the power not contained in the occupied bandwidth represents a ratio of 0.0436 dB. The bandwidth where 99% of the total emission power is contained is 2.775 kHz. This occurs where the band power is equal to 13.517dBm – 0.0436 dB.

**Result:**

The occupied bandwidth is 2.775 kHz.

### 6.3 Frequency Stability Over Temperature

**Requirement:**

Measured as per the requirement of Part 2.1055 and Part 90.210 emission mask F. Since the bandwidth of the emission is less than 4kHz, the frequency stability requirement is that the emission must comply with the emission mask over a temperature range of -30 to 50 degrees C.

**Measurement Information:**

The dual-channel Network Controller, NC2202, uses the identical frequency stabilizing network as in the single channel Network Controller NC2200 that has been approved by the FCC (FCC ID: OZFN2201). This measurement report has been extracted from the test report for the NC2200 Network controller submitted to the FCC in August 2004.

**Test Procedure:**

The frequency determining and stabilizing circuitry of the DUT is placed in a temperature chamber and interfaced back to the main DUT rack via extender RF and interface cables. The antenna output of the DUT is connected to the Vector Signal Analyzer via cables and a high power attenuator. The frequency reference for the Vector Signal Analyzer is a precision rubidium frequency standard. The Vector Signal Analyzer display is calibrated to display the emission mask limit of Part 90.210 mask F. Measurements that show compliance to the emission mask are performed at the lowest and highest channels of operation and at the highest power level where the emission mask is the most stringent.

**Test Set Up:**

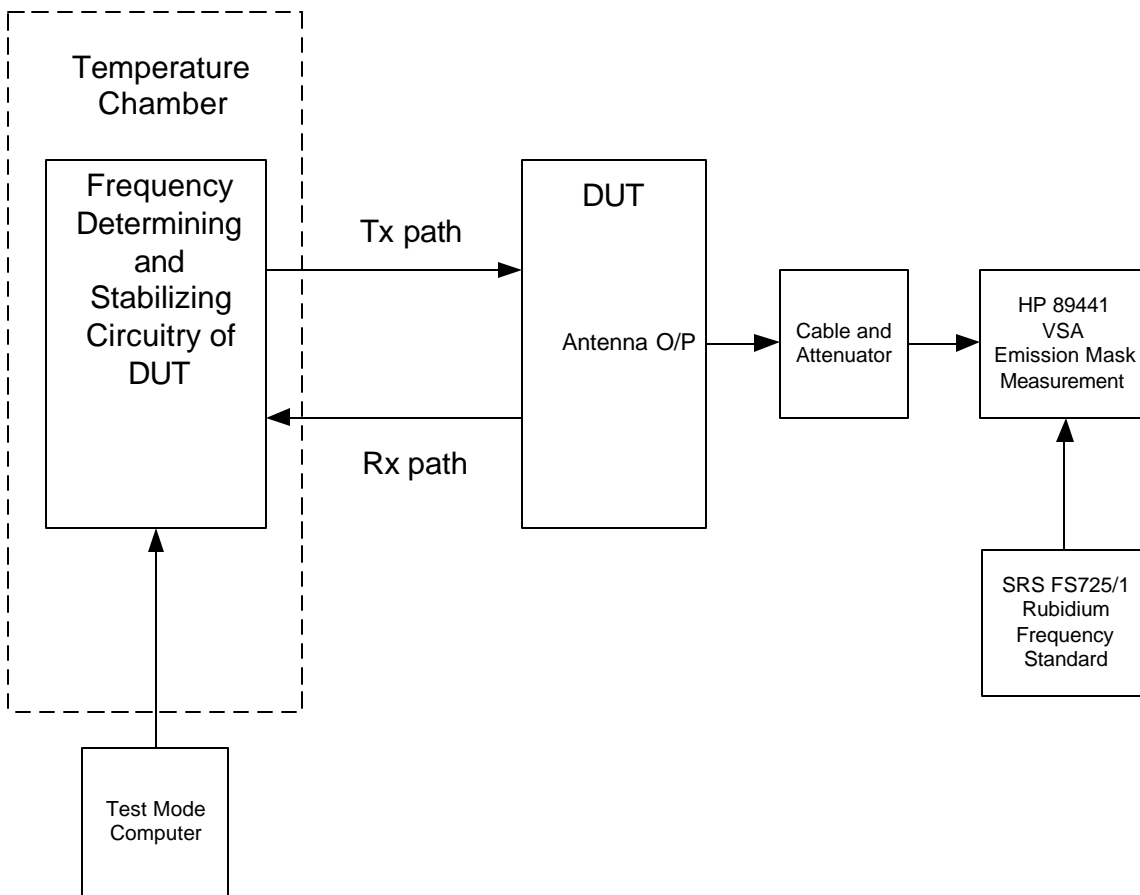

**The settings for the Vector Signal Analyzer are as follows for all the emission mask measurements:**

Settings:

Acquisition Mode: Continuous Peak Hold  
 RBW: 30 Hz  
 Detector type: Positive Peak  
 Trigger type: Free running  
 Center: 220.0025 MHz for the lowest channel. 220.9975 MHz for the highest channel  
 Span: 20 kHz  
 Part 90.210 emission mask F with ultimate attenuation based on 69 Watts at the antenna terminal.

**Measurement Plots At The Highest Channel:  
 -30 degrees C.**

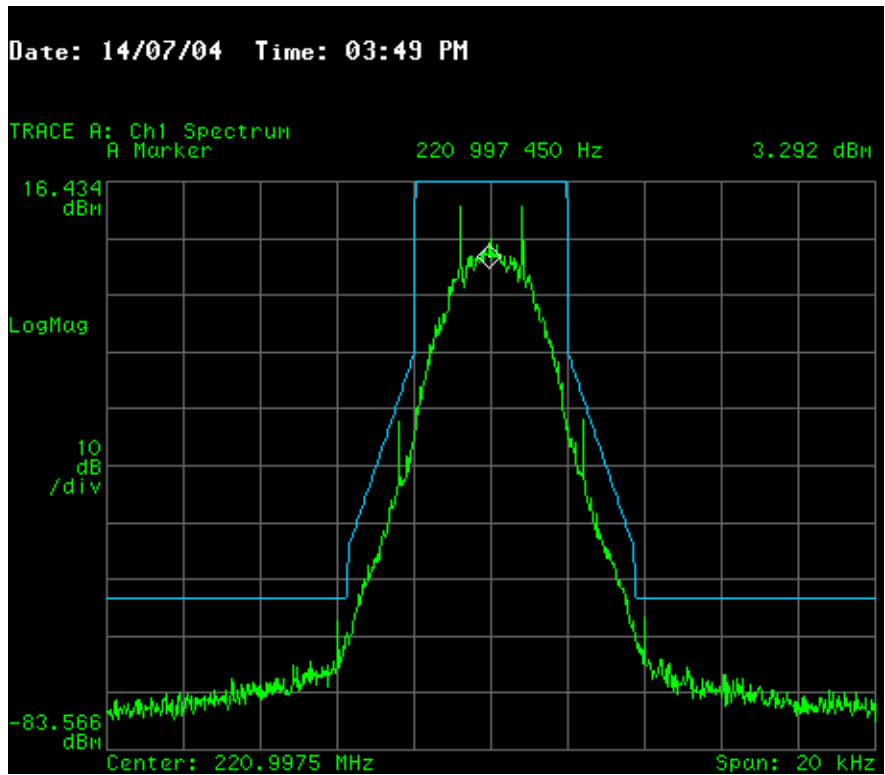

**-25 degrees C**

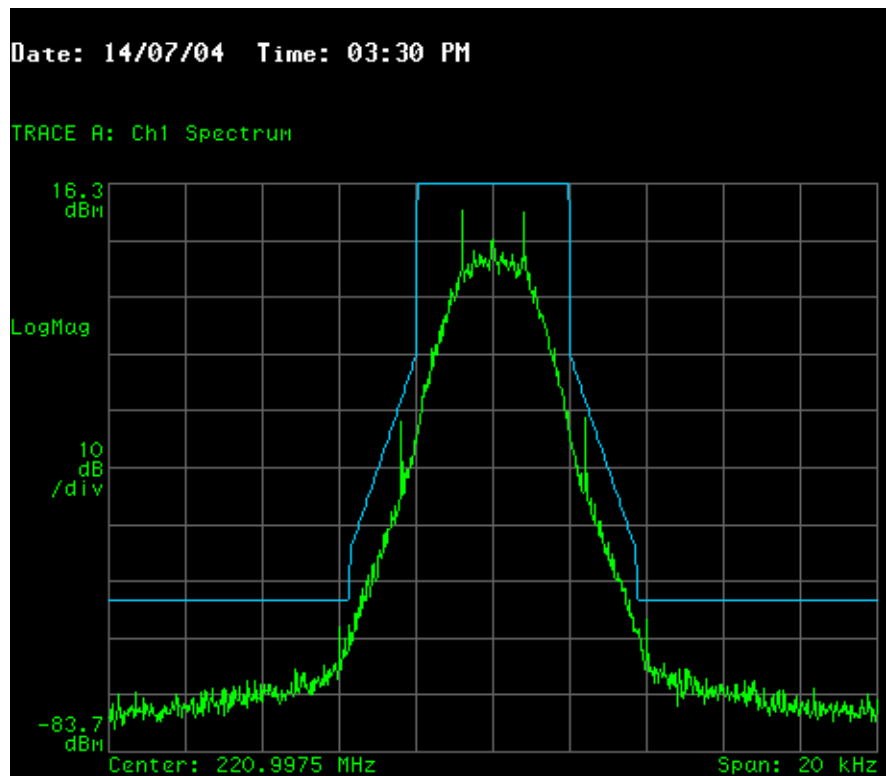

**-15 degrees C.**

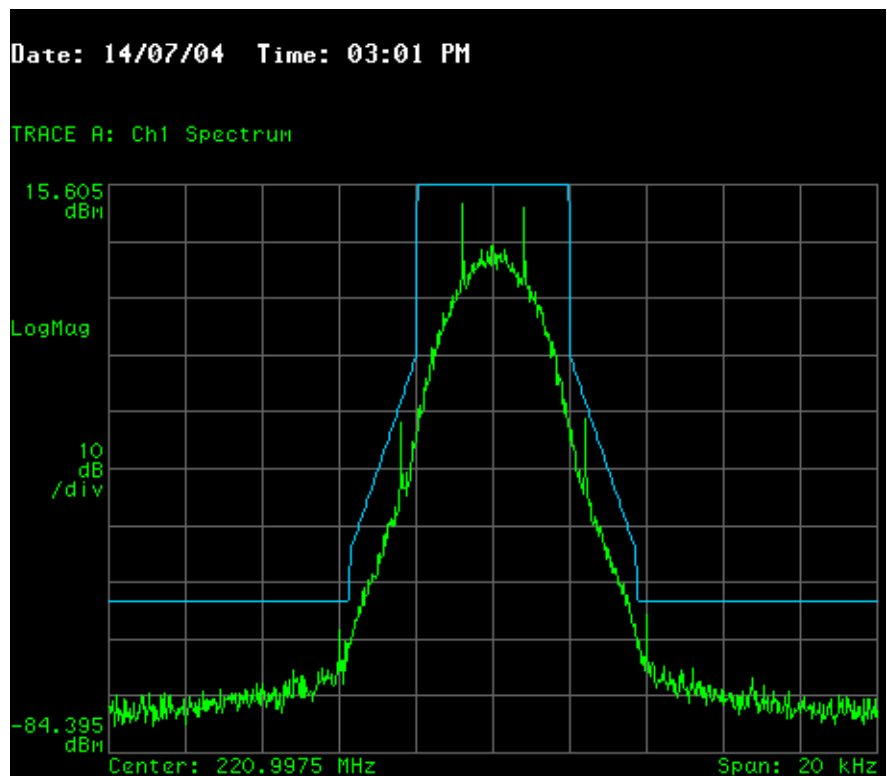

### -5 degrees C

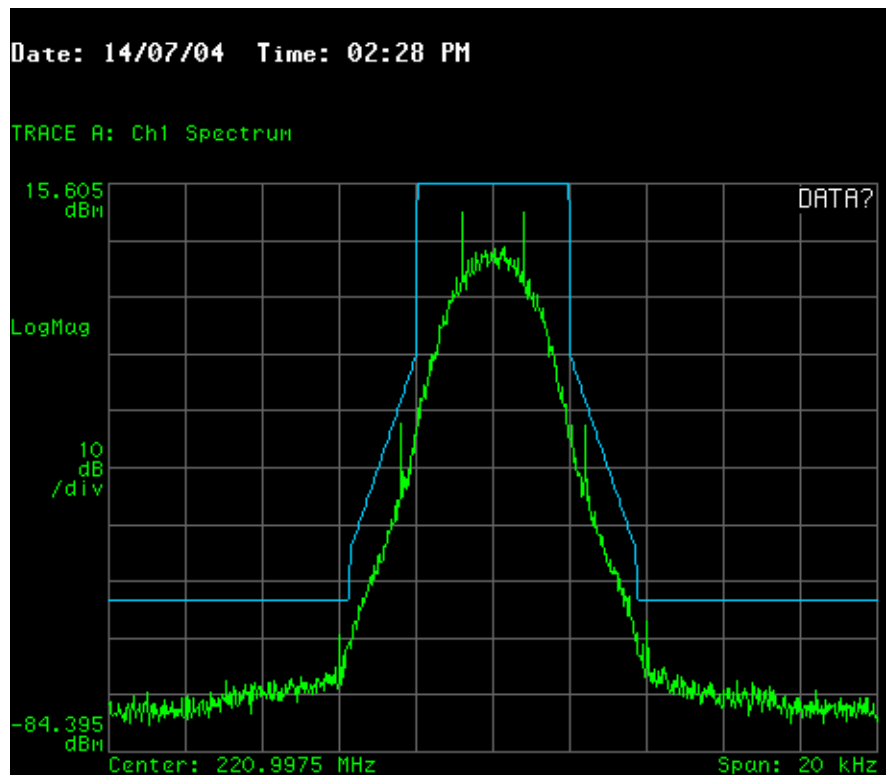

### 5 degrees C

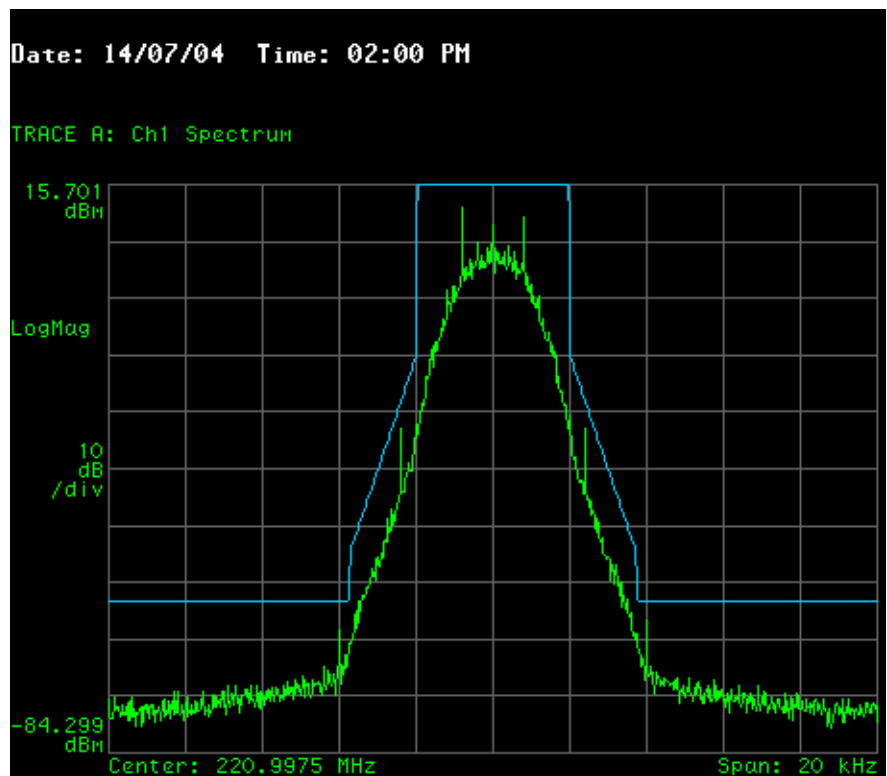



### 15 degrees C

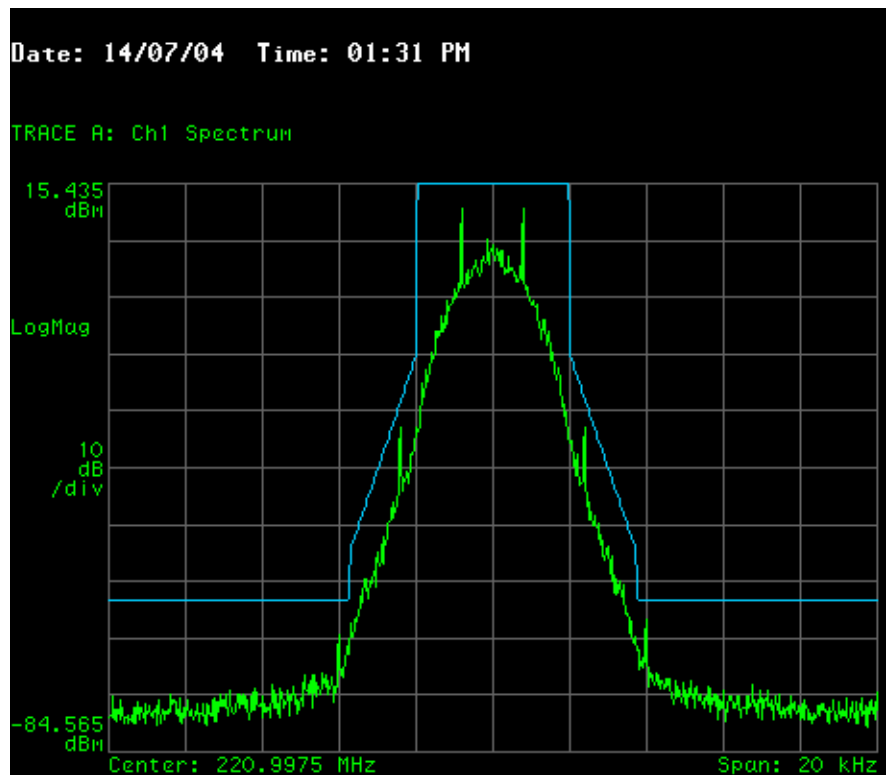

### 25 degrees C

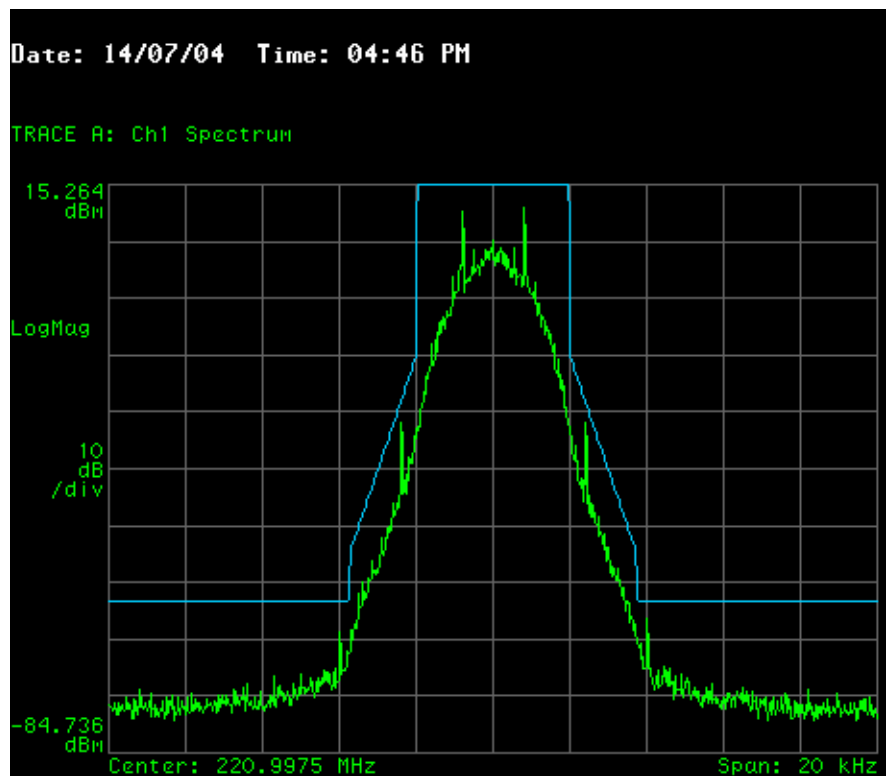

### 35 degrees C

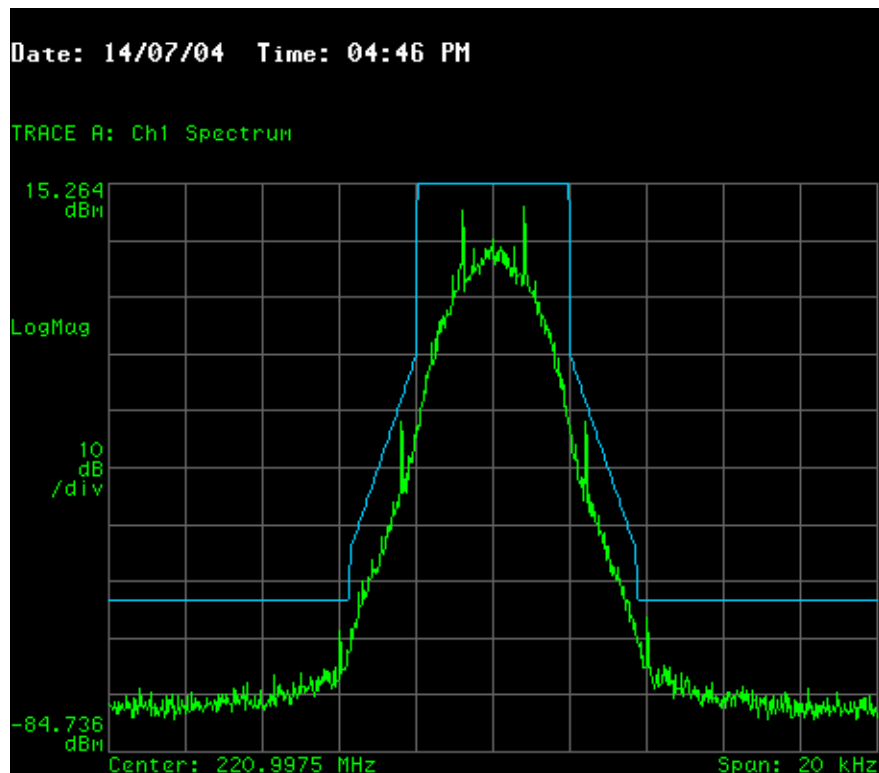

### 45 degrees C

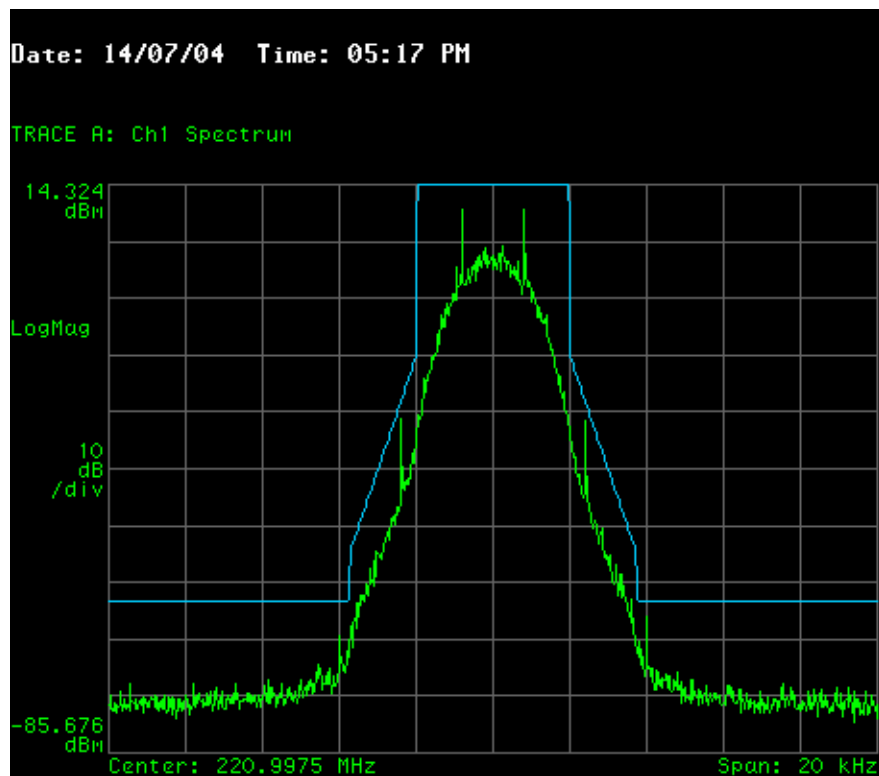

### 50 degrees C

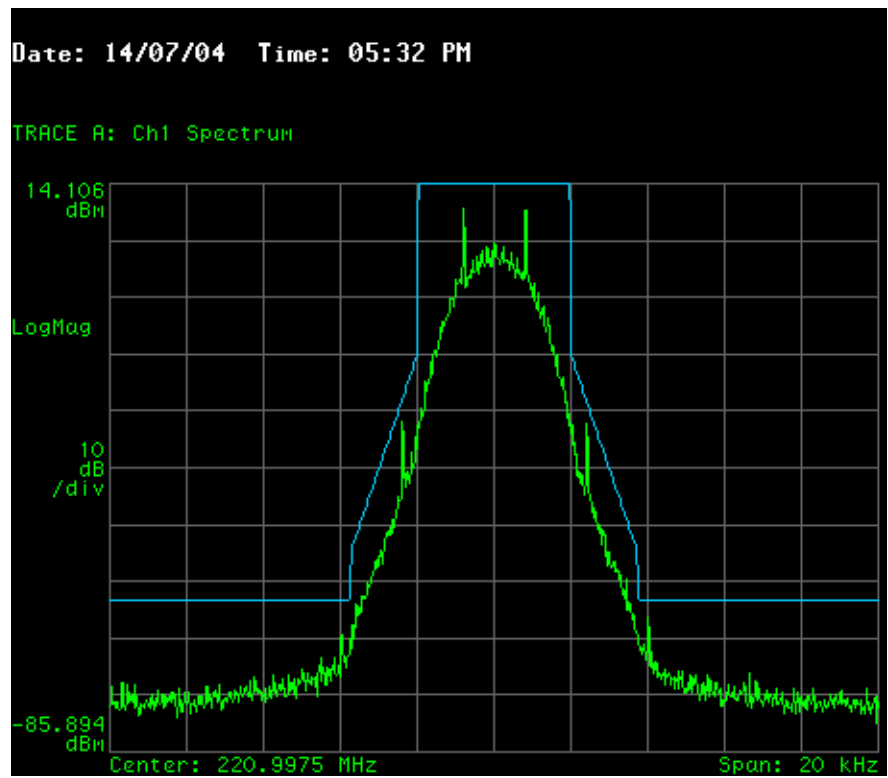

### Measurement Plots At The Lowest Channel

-30 degrees C

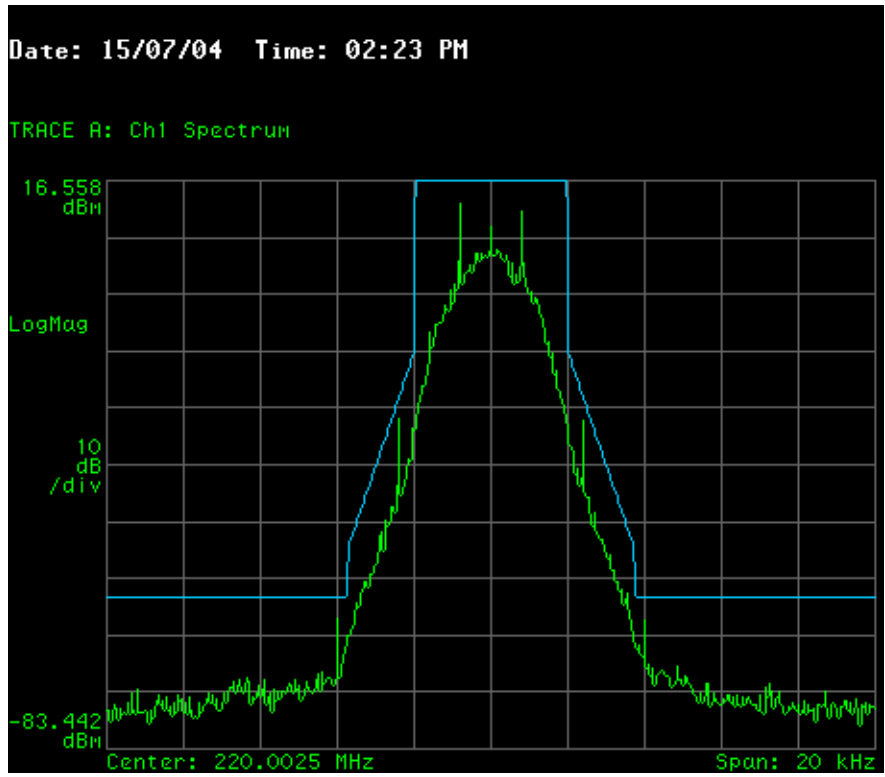

-25 degrees C

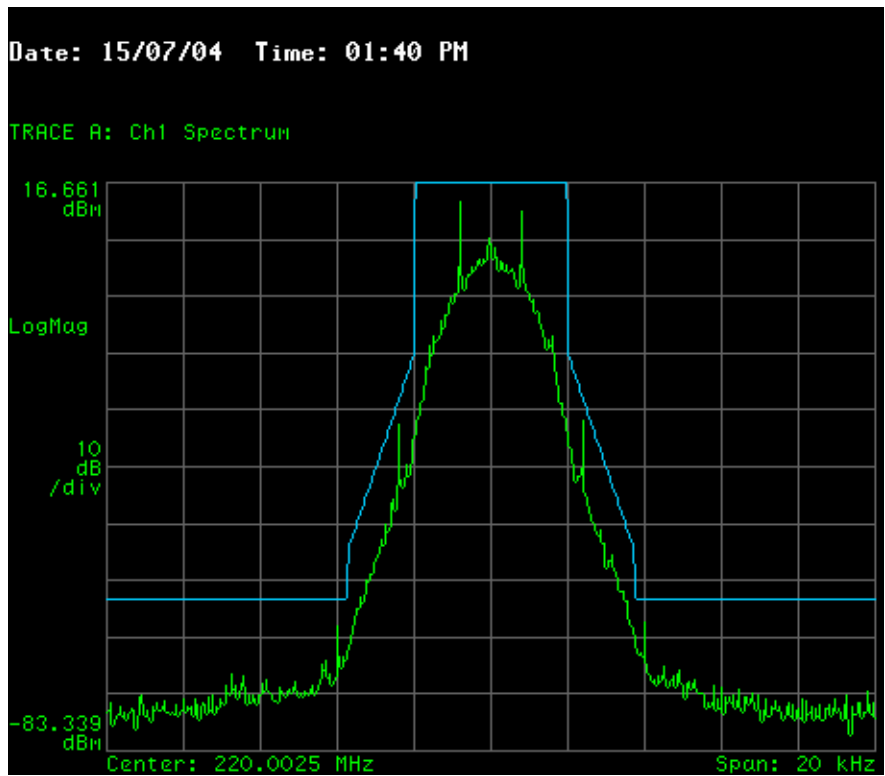

**-15 degrees C**

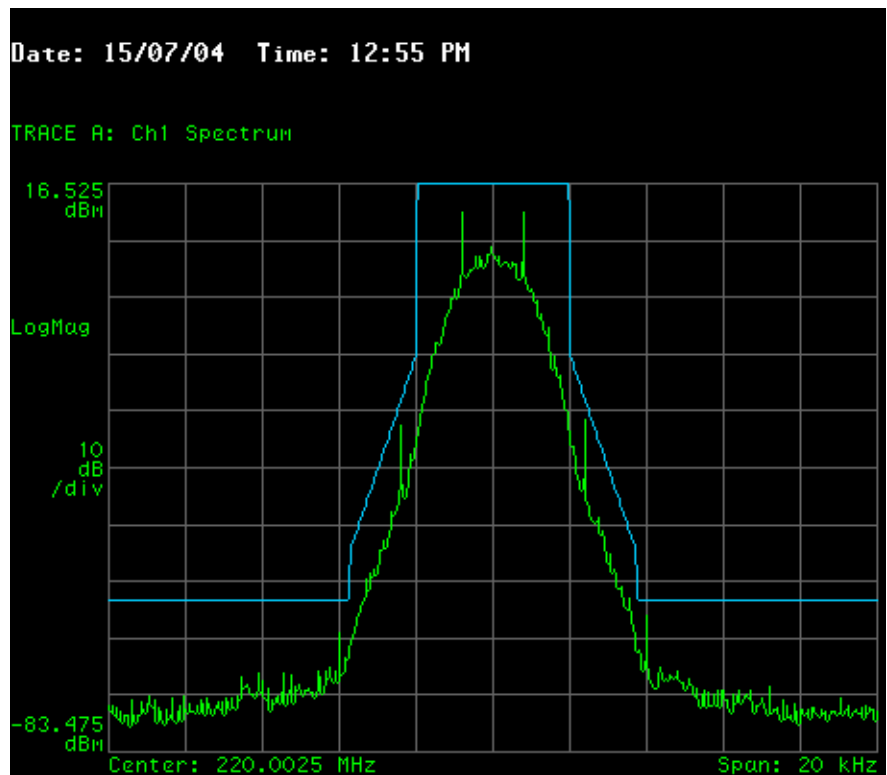

**-5 degrees C**

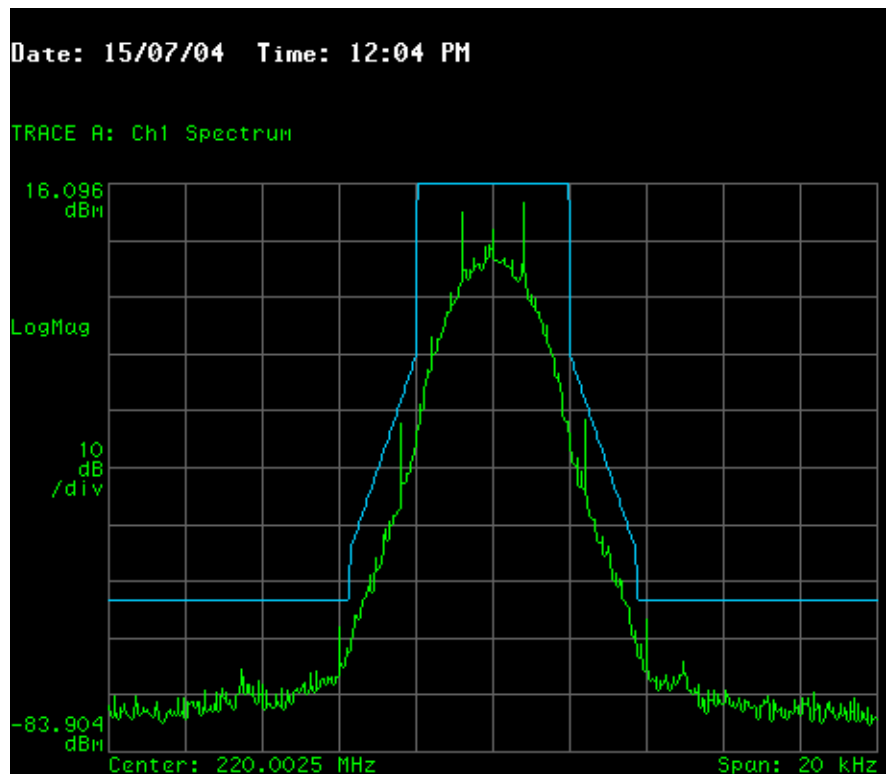

### 15 degrees C

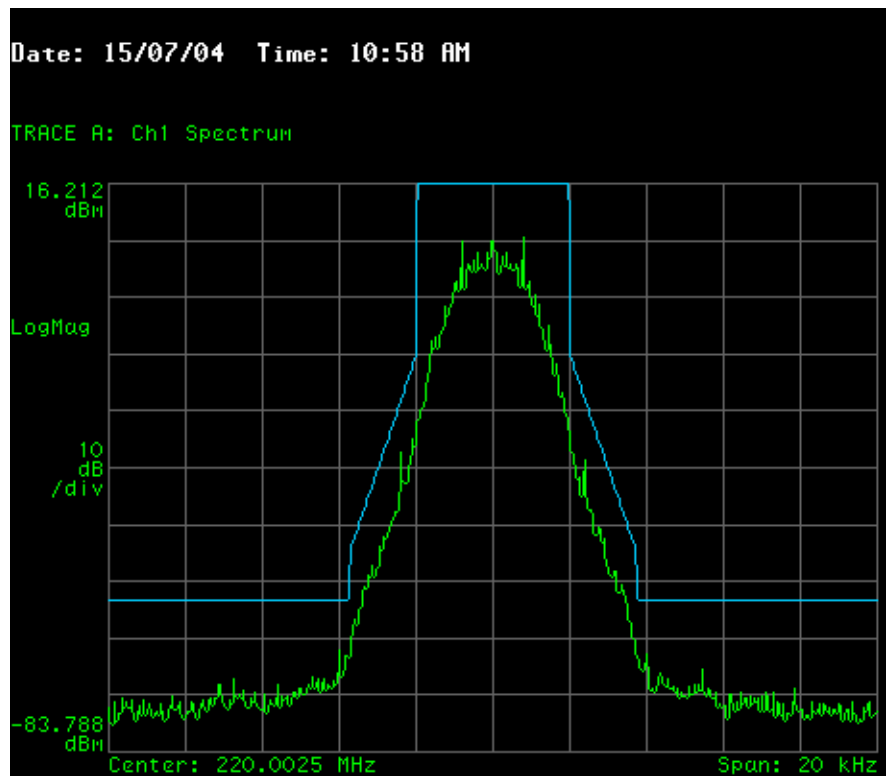

### 25 degrees C

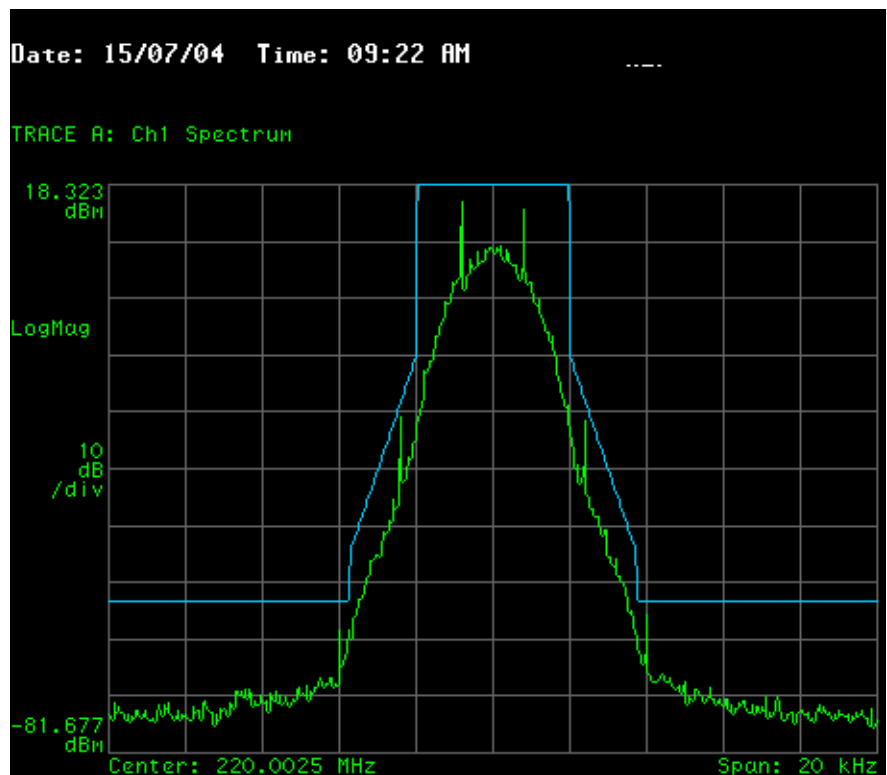

### 35 degrees C

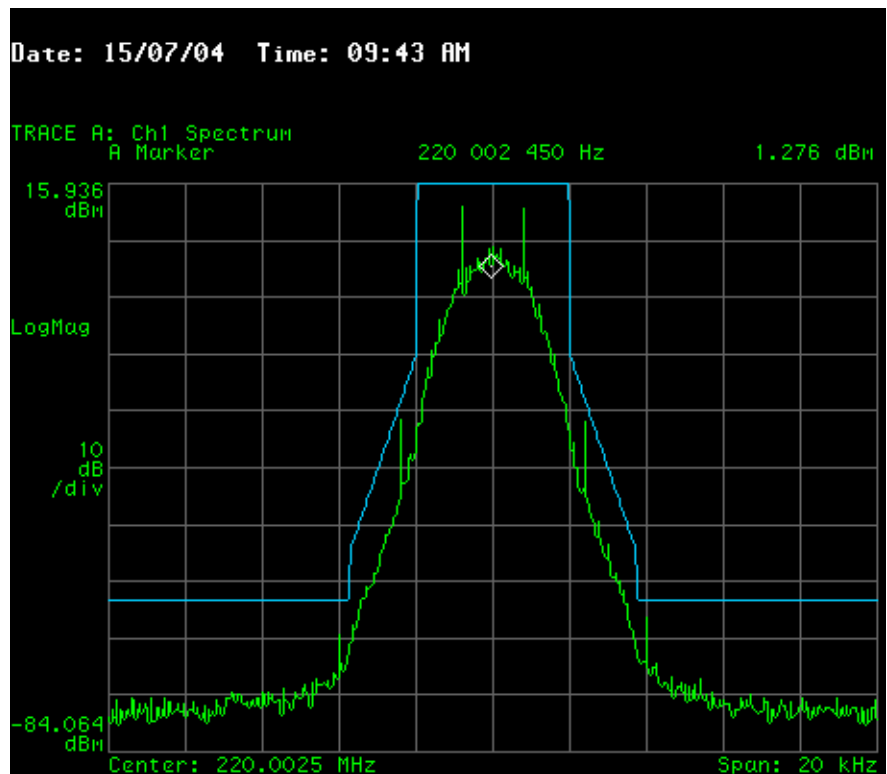

### 45 degrees C

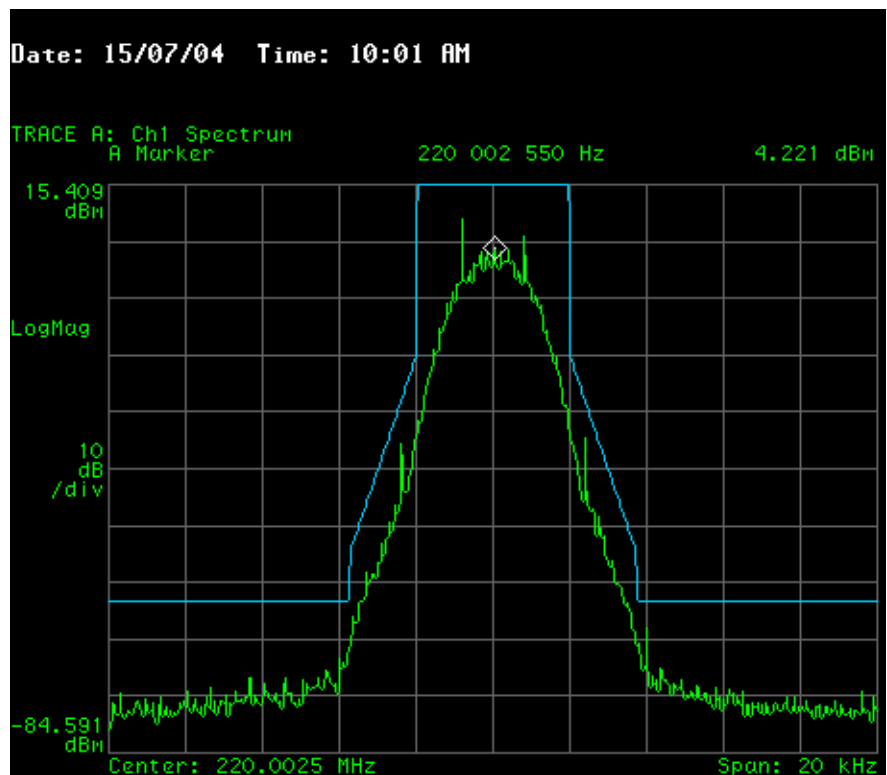

**50 degrees C**

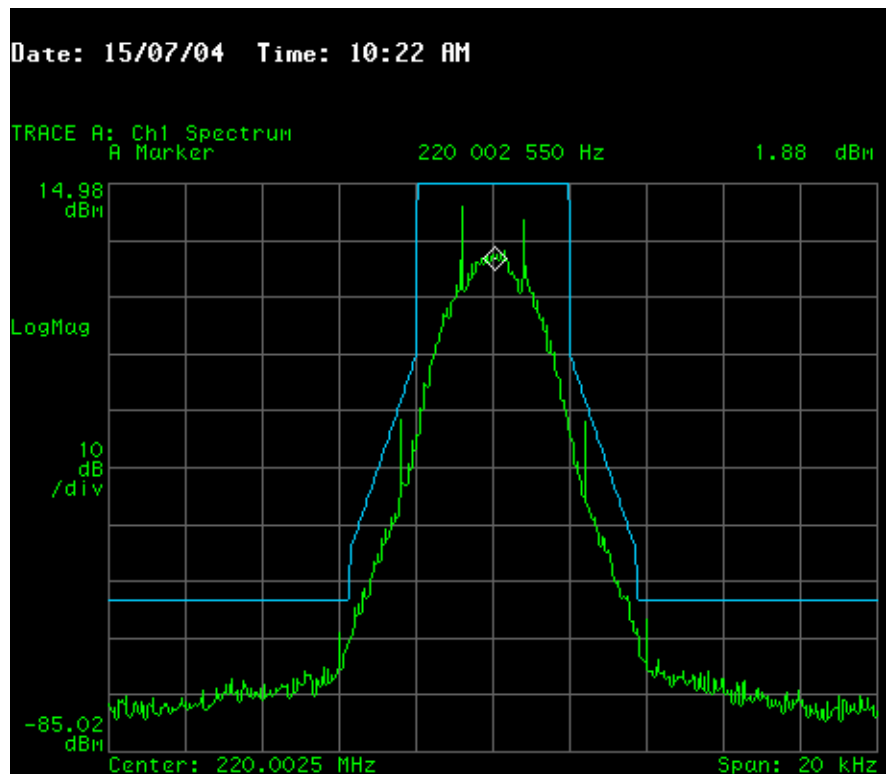

**Result:**

Requirement	Measured Result
The frequency stability over temperature must comply with the requirement in Part 90.210 for the emission to fit under emission mask F.	<b>Complies</b>



## 6.4 Frequency Stability versus Variation In Primary Supply Voltage

### Requirement:

As per part 2.1055, the frequency stability is verified over variation in primary supply voltage. The frequency stability requirement is that the emission complies with the emission mask defined in Part 90.210, mask F. Measurement of compliance to the emission mask shall be performed at 85% and 115% of the primary supply voltage.

### Measurement Information:

The dual-channel Network Controller, NC2202, uses the identical primary supply network as in the single channel Network Controller NC2200 that has been approved by the FCC (FCC ID: OZFN2201). This measurement report has been extracted from the test report for the NC2200 Network controller submitted to the FCC in August 2004.

### Test Procedure:

The antenna output of the DUT is connected to the Vector Signal Analyzer via cables and a high power attenuator. The frequency reference for the Vector Signal Analyzer is a precision rubidium frequency standard. The Vector Signal Analyzer display is calibrated to display the emission mask limit of Part 90.210 mask F. Measurements that show compliance to the emission mask are performed at the lowest and highest channels of operation and at the highest power level where the emission mask is the most stringent. The primary supply voltage is adjusted by the means of a variac to enable measurements at 85% and 115% of the primary supply voltage. The temperature chamber is set to nominal room temperature.

**Test Setup:**

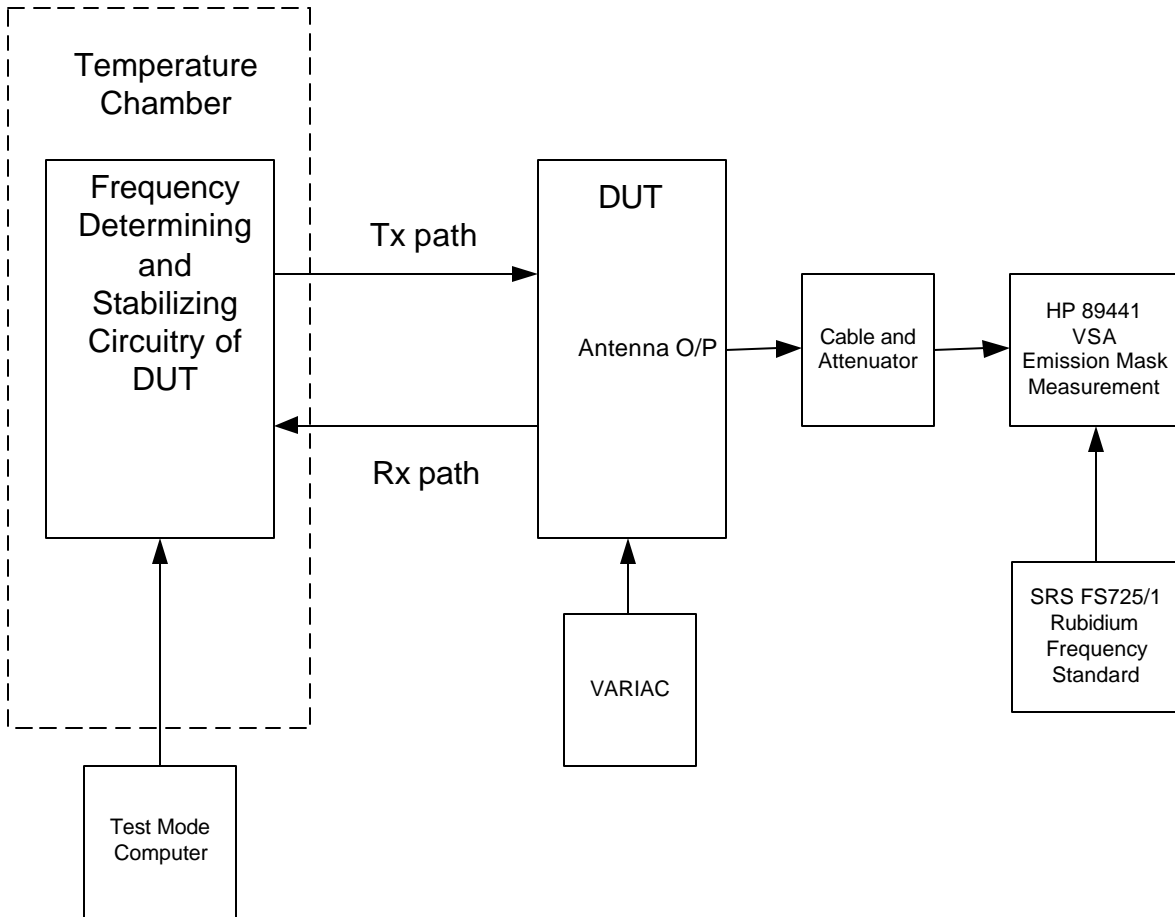

**The settings for the Vector Signal Analyzer are as follows for all the emission mask measurements:**

Settings:

Acquisition Mode: Continuous Peak Hold  
 RBW: 30 Hz  
 Detector type: Positive Peak  
 Trigger type: Free running  
 Center: 220.0025 MHz for the lowest channel. 220.9975 MHz for the highest channel  
 Span: 20 kHz  
 Part 90.210 emission mask F with ultimate attenuation based on 69 Watts at the antenna terminal.

**Measurement Results At The Highest Channel:**

**85% of primary supply voltage, 97 VAC**

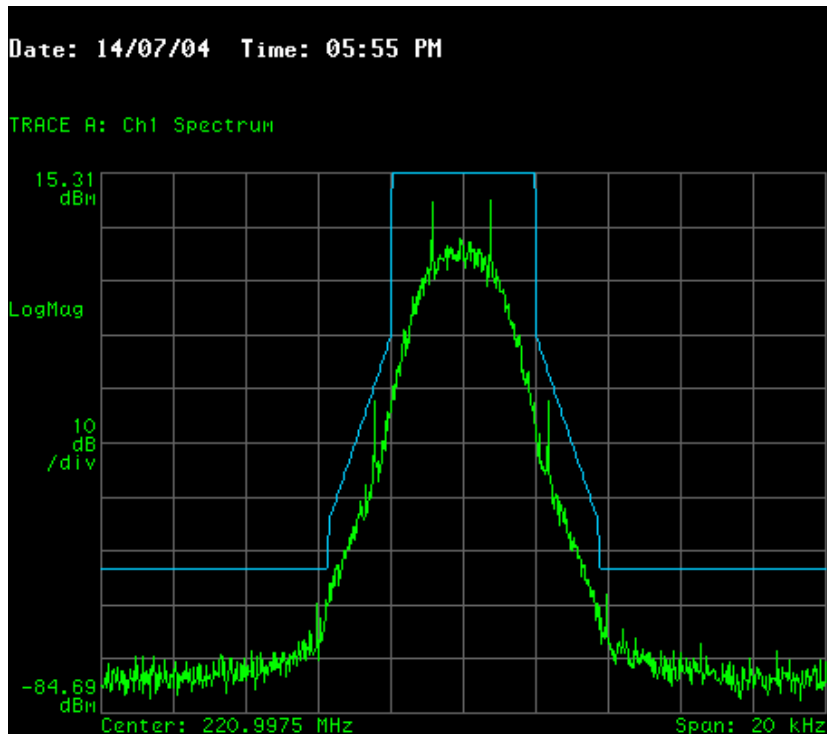

**115% of primary supply voltage, 133 VAC**

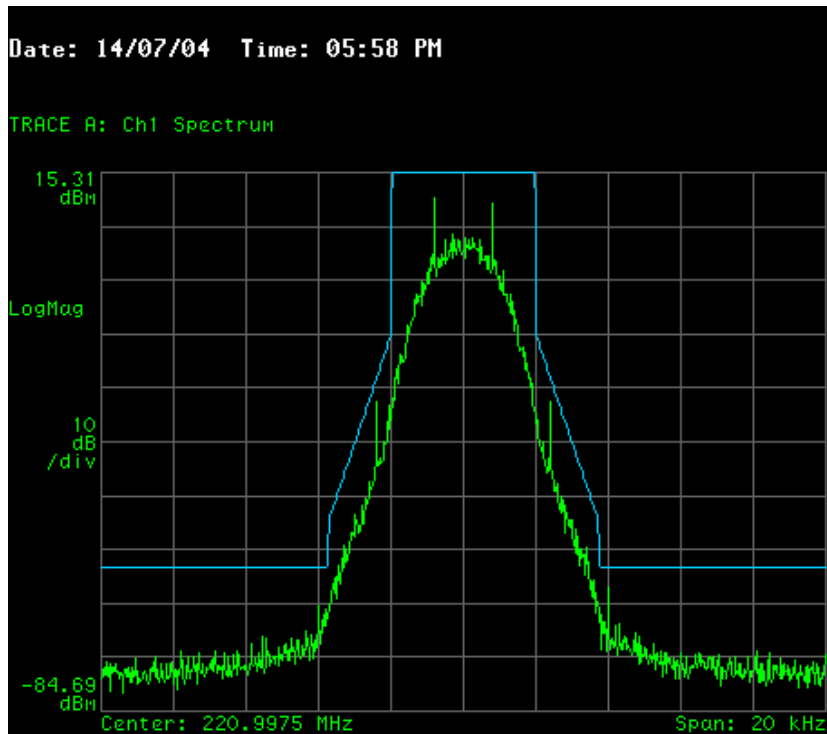

**Measurement Results At The Lowest Channel**

**85% of primary supply voltage, 97 VAC**

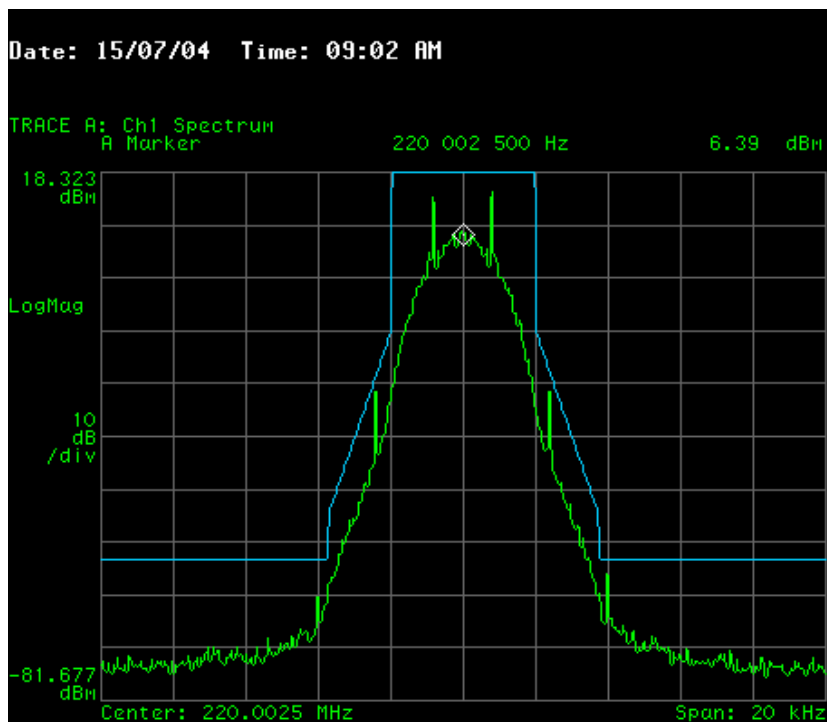

**115% of primary supply voltage, 133 VAC**

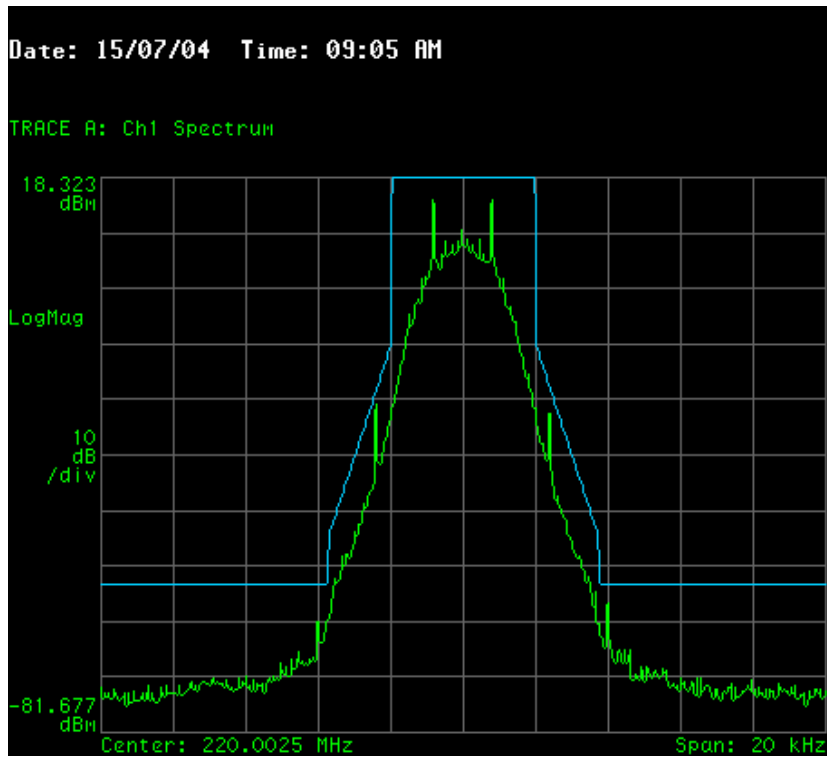

**Result:**

Requirement	Measured Result
The frequency stability over variation in primary supply voltage must comply with the requirement in Part 90.210 for the emission to fit under emission mask F.	<b>Complies</b>

## 6.5 Conducted Spurious Emissions At Antenna Terminal

### Requirement:

Conducted spurious emissions are measured as per the requirement in 2.1051. The limits for the conducted spurious emissions are calculated by using the formulas as follows:

For High Power:  $55+10\log(P_{high}) = 55+10\log(52.12) = 72.17\text{dBc}$

For Low Power:  $55+10\log(P_{low}) = 55+10\log(19.07) = 67.80\text{dBc}$

### Test Procedure for measuring harmonics:

The output of the DUT transmitter is coupled through an attenuator, directly into the HP89441A Vector Signal Analyzer. The spectrum is searched from 100 kHz to 2.65 GHz. This range exceeds the minimum requirement of search up to the 10<sup>th</sup> harmonic of the fundamental emission. The measurement is performed at the highest and lowest power levels measured in section 6.1 of this report at the lowest channel frequency of 220.0025 MHz. Both channels were transmitting, but the values in the table below only show the highest level of the associated harmonic of the 2 channels.

### Test Procedure for measuring Inter-modulation Products:

The output of the DUT transmitter is coupled through an attenuator, directly into the HP89441A Vector Signal Analyzer. Both channels are transmitting and the measurement is performed at the highest power level measured in section 6.1 of this report at both the low and high range of the allocated frequency band of 220-221MHz.

**Test Setup:**

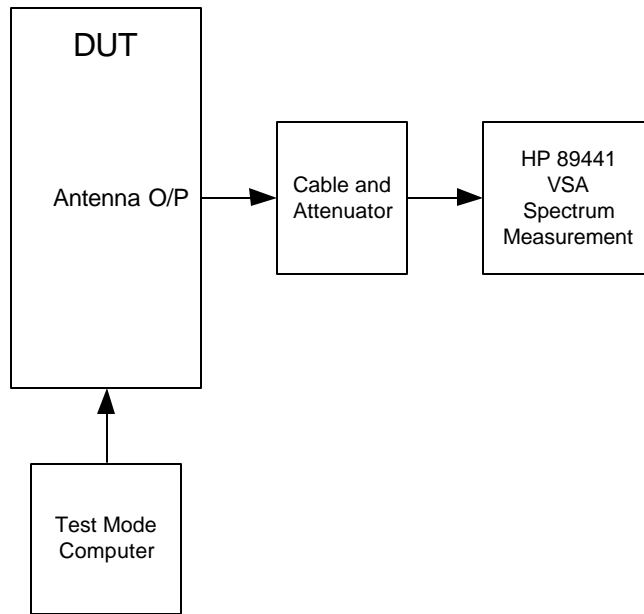

**Harmonically related conducted spurious measurement Data:**

In all cases the conducted spurious and/or harmonics are greater than 20 dB below the permissible value.

FREQUENCY, MHz	dB WITH RELATIVE TO CARRIER, LOW POWER, dB c	dB RELATIVE TO CARRIER, HIGH POWER, dBc
220.0025	0	0
440.0005	-114	-104
660.0075	-119	-105
880.0100	<-120	-113
1100.0125	<-120	-114
1320.0150	<-120	-114
1540.0175	<-120	-114
1670.0200	<-120	<-115
1980.0225	<-120	<-115
2200.0250	<-120	<-115
2420.0275	<-120	<-115

**Inter-modulation related measurement Data:**

**Low Band:**

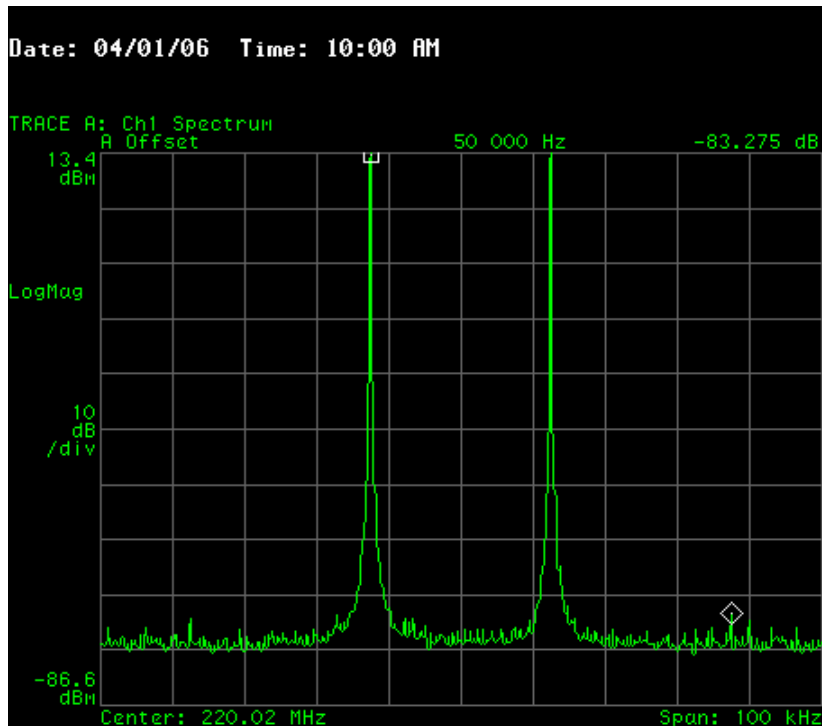

Measurement Result:  
 The inter-modulation products when both transmitters are transmitting at their maximum output power at the low part of the allocated frequency band is equal to -83.275dBc.



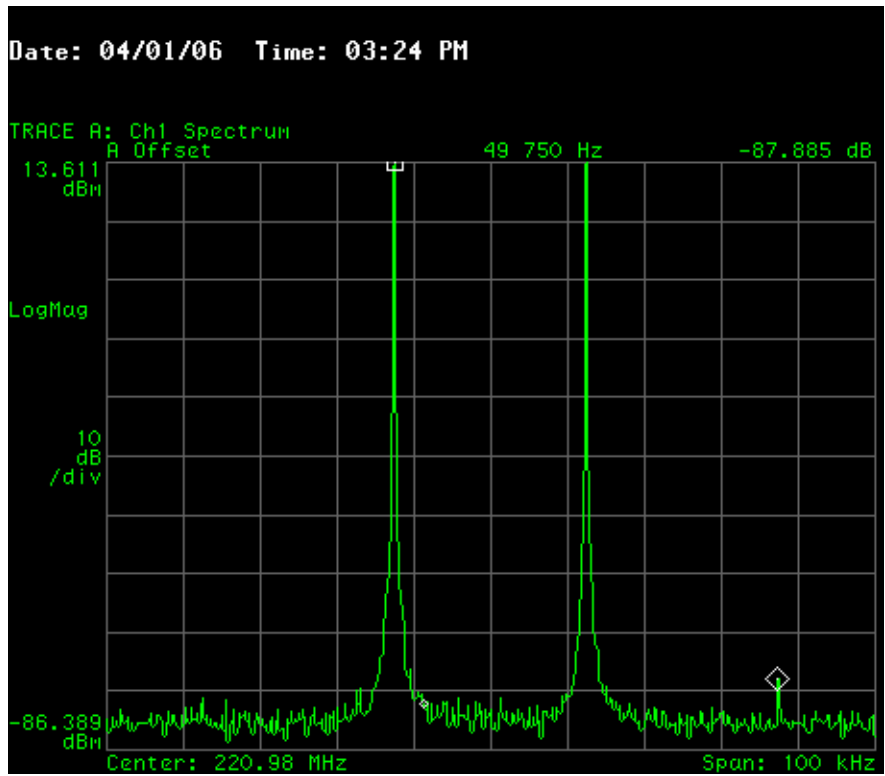

Measurement Result:

The inter-modulation products when both transmitters are transmitting at their maximum output power at the high end of the allocated frequency band is equal to -87.885dBc.

Requirement	Measured Result
The conducted spurious emissions at the antenna terminal of the DUT must be less than the limit defined in Part 90.210(f). The level of the spurious emissions with respect to and below the carrier must be $55 + 10\log(P)$	<b>Complies</b>

## Revision History

The following table shows the revision history of this document.

<b>Date dd/mm/yy</b>	<b>Author</b>	<b>Changes</b>	<b>Version</b>
17/03/06	Mark Fairburn	Original	1.0

## **Appendix A Protocol EMC Test Report**

The test report prepared by Protocol for all radiated measurements that require an open area test site has been files as “(NC-2202) TestRpt2.pdf”.

Protocol has enabled security features in their test report document that prevented it from being merged with this one.