

FCC EVALUATION REPORT FOR CERTIFICATION

Manufacturer: OHSUNG ELECTRONICS CO., LTD.

Date of Issue: July 20, 2011

#181 Gongdan-dong, Gumi-si, Gyeongbuk

Order Number: GETEC-C1-11-129

Republic of Korea.

Test Report Number: GETEC-E3-11-053

Attn : Mr. Hak-Ki Kim / General Manager

Test Site: Gumi College EMC Center

FCC Registration Number: (100749, 443957)

FCC ID. : OZ5URCMXW-920

Applicant : OHSUNG ELECTRONICS CO., LTD.

Rule Part(s) : FCC Part 15 Subpart C-Intentional Radiator § 15.231

Equipment Class : Remote Control Transmitter (DSC)

EUT Type : RF REMOTE CONTROLLER

Type of Authority : Certification

Model Name : MXW-920

Trade Name : UNIVERSAL Remote Control

This equipment has been shown to be in compliance with the applicable technical standards as indicated in the measurement report and was tested in accordance with the measurement procedures specified in ANSI C63.4-2003

I attest to the accuracy of data. All measurements reported herein were performed by me or were made under my supervision and are correct to the vest of my knowledge and belief. I assume full responsibility for the completeness of these measurements and vouch for the qualifications of all persons taking them.

Tested by,

Reviewed by,

Hyoung-Seop Kim, Senior Engineer
GUMI College EMC center

Jae-Hoon Jeong, Senior Manager
GUMI College EMC center



CONTENTS

1. GENERAL INFORMATION	4
2. INTRODUCTION	5
3. PRODUCT INFORMATION	6
3.1 DESCRIPTION OF EUT	6
3.2 SUPPORT EQUIPMENT / CABLES USED	7
3.3 MODIFICATION ITEM(S)	7
4. ANTENNA REQUIREMENT - §15.203	8
4.1 DESCRIPTION OF ANTENNA	8
5. DESCRIPTION OF TESTS	8
5.1 TEST CONDITION	8
5.2 CONDUCTED EMISSION	9
5.3 RADIATED EMISSION	10
5.4 DUTY CYCLE CORRECTION	11
5.5 OCCUPIED BANDWIDTH	11
6. DUTY CYCLE CORRECTION	12
6.1 OPERATING ENVIRONMENT	12
6.2 TEST SET-UP	12
6.3 TEST EQUIPMENT USED	12
6.4 TEST RESULT OF DUTY CYCLE	12
7. ACTIVATION TIME	13
7.1 OPERATING ENVIRONMENT	13
7.2 LIMIT	13
7.3 TEST EQUIPMENT USED	13
7.4 TEST RESULT OF ACTIVATION TIME	13
8. RADIATED EMISSION	14
8.1 OPERATING ENVIRONMENT	14
8.2 TEST SET-UP	14
8.3 MEASUREMENT UNCERTAINTY	14
8.4 LIMIT	15
8.5 TEST EQUIPMENT USED	15
8.6 TEST DATA FOR RADIATED EMISSION	16
9. OCCUPIED BANDWIDTH MEASUREMENT	18
9.1 OPERATING ENVIRONMENT	18
9.2 TEST SET-UP	18
9.3 LIMIT	18
9.4 TEST EQUIPMENT USED	18
9.5 TEST RESULT OF OCCUPIED BANDWIDTH	18
10. SAMPLE CALCULATIONS	19
10.1 EXAMPLE 1 :.....	19
10.2 EXAMPLE 2 :.....	19
11. RECOMMENDATION & CONCLUSION	20



APPENDIX A – ATTESTATION STATEMENT
APPENDIX B – TEST PLOTS
APPENDIX C – ID SAMPLE LABEL & LOCATION
APPENDIX D – BLOCK DIAGRAM
APPENDIX E – SCHEMATIC DIAGRAM
APPENDIX F – TEST SET-UP PHOTOGRAPHS
APPENDIX G – EXTERNAL PHOTOGRAPHS
APPENDIX H – INTERNAL PHOTOGRAPHS
APPENDIX I – USER’S MANUAL
APPENDIX J – OPERATIONAL DESCRIPTION



Scope: Measurement and determination of electromagnetic emissions (EME) of radio frequency devices including intentional and / or unintentional radiators for compliance with technical rules and regulations of the Federal Communications Commission.

1. General Information

Applicant: OHSUNG ELECTRONICS CO., LTD.

Applicant Address: #181 Gongdan-dong, Gumi-si, Gyeongbuk, Republic of Korea.

Manufacturer: OHSUNG ELECTRONICS CO., LTD.

Manufacturer Address: #181 Gongdan-dong, Gumi-si, Gyeongbuk, Republic of Korea.

Contact Person: Mr. Hak-Ki Kim / General Manager

Tel. Number: +82-54-468-0831 Fax Number: +82-54-461-8368

- **FCC ID.** OZ5URCMXW-920
- **Equipment Class** Remote Control Transmitter (DSC)
- **EUT Type** RF REMOTE CONTROLLER
- **Model Name** MXW-920
- **Trade Name** UNIVERSAL Remote Control
- **Serial Number** Prototype
- **Rule Part(s)** FCC Part 15 Subpart C
- **Type of Authority** Certification
- **Test Procedure(s)** ANSI C63.4 (2003)
- **Dates of Test** July 5, 2011
- **Place of Test** **Gumi College EMC Center** (FCC Registration No.: 100749, 443957)
407, Bugok-dong, Gumi-si, Gyeongbuk, Korea.
- **Test Report Number** GETEC-E3-11-053
- **Dates of Issue** July 20, 2011

EUT Type: RF REMOTE CONTROLLER

FCC ID.: OZ5URCMXW-920



2. Introduction

The measurement procedure described in American National Standard for Methods of Measurement of Radio-Nose Emissions From Low-Voltage Electrical and Electronic Equipment in the Range of 9 kHz to 40 GHz (ASNI C63.4-2003) was used in determining radiated and conducted emissions emanating from **OHSUNG ELECTRONICS CO., LTD. RF REMOTE CONTROLLER(Model Name: MXW-920) FCC ID.: OZ5URCMXW-920**

These measurement tests were conducted at **Gumi College EMC Center**.

The site address is 407, Bugok-dong, Gumi-si, Gyeongbuk, Korea.

This test site is one of the highest point of Gumi 1 college at about 200 km away from Seoul city and 40 km away from Daegu city. It is located in the valley surrounded by mountains in all directions where ambient radio signal conditions are quiet and a favorable area to measure the radio frequency interference on open field test site for the computing and ISM devices manufactures. The detailed description of the measurement facility was found to be in compliance with the requirements of FCC §2.948 according to ANSI C63.4 (2003)

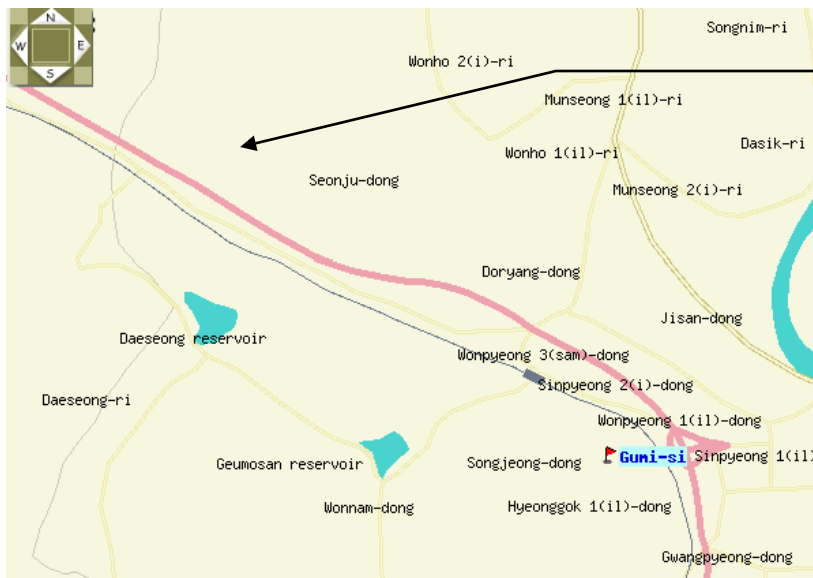

GUMI COLLEGE EMC CENTER
407, Bugok-dong, Gumi-si,
Gyeongbuk 730-711, Korea.
Tel: +82-54-440-1195
Fax: +82-54-440-1199

Fig 1. The map above shows the Gumi College in vicinity area.



3. Product Information

3.1 Description of EUT

The Equipment under Test (EUT) is the **OHSUNG ELECTRONICS CO., LTD. RF REMOTE CONTROLLER (Model Name: MXW-920) FCC ID.: OZ5URCMXW-920**

Specifications

Memory: 4 Megabits of Flash Memory (for User Configuration)

Devices: Flexible, typically can support up to 40 Devices

Pages: Flexible, typically can support up to 40 Pages on each Device

Learning Capability: Standard frequencies (15kHz to 460kHz)

Macro Capability: Up to 255 steps each, however nesting is allowed

IR Range (Line of Sight via Infrared): 30-50 feet, depending on the environment

RF Range (radio frequency): 50 to 100 feet, depending upon the environment

RF Frequency: 418MHz

Weight: 5.68 ounces (without batteries)

Size: 8.9" H x 2.34" W x 1.1" D

Batteries: 4 AAA Batteries

RF Frequency : Main board: 8 MHz, 18.432 MHz
RF module board: 13.062 5 MHz



3.2 Support Equipment / Cables used

3.2.1 Used Support Equipment

Description	Manufacturer	Model Name	S/N & FCC ID
None.	-	-	S/N: - FCC ID: -

See "Appendix D- Test Setup Photographs" for actual system test set-up

3.2.2 System configuration

Description	Manufacturer	Model Name	S/N & FCC ID.
None.	-	-	S/N: - FCC ID.: -

3.2.3 Used Cable(s)

Cable Name	Condition	Description
None.	-	-

3.3 Modification Item(s)

- None



4. Antenna Requirement - §15.203

An intentional radiator antenna shall be designed to ensure that no antenna other than that furnished by the applicant can be used with the device. The use of permanently attached antenna or of an antenna that uses a unique coupling to the intentional radiator shall be considered sufficient to comply with this requirement.

4.1 Description of Antenna

The **OHSUNG ELECTRONICS CO., LTD. / RF Transmitter Universal Remote Control** comply with the requirement of §15.203 with a built-in looped antenna permanently attached to the transmitter.

5. Description of tests

5.1 Test Condition

- Test Voltage / Frequency : DC 6 V supplied from the four DC 1.5 V AAA size batteries
- Test Mode(s): Continuous RF transmitting mode



5.2 Conducted Emission

The Line conducted emission test facility is inside a 4 m × 8 m × 2.5 m shielded enclosure. (FCC Registration No.: 100749)

The EUT was placed on a non-conducting 1.0 m by 1.5 m table, which is 0.8 m in height and 0.4 m away from the vertical wall of the shielded enclosure.

The EUT is powered from the Rohde & Schwarz LISN (ESH2-Z5) and the support equipment is powered from the Rohde & Schwarz LISN (ESH3-Z5). Powers to the LISN are filtered by high-current high insertion loss power line filter.

Sufficient time for EUT, support equipment, and test equipment was allowed in order for them to warm up to their normal operating condition.

The RF output of the LISN was connected to the EMI test receiver (Rohde & Schwarz, ESCS30).

The EMI test receiver was scanned from 150 kHz to 30 MHz with 20 ms sweep time to determine the frequency producing the maximum EME from the EUT. The frequency producing the maximum level was re-examined using Quasi-Peak mode of the EMI test receiver.

The bandwidth of Quasi-peak mode was set to 9 kHz. Each emission was maximized consistent with typical applications by varying the configuration of the test sample. Interface cables were connected to the available interface ports of the test unit. The effect of varying the position of cables was investigated to find the configuration that produces maximum diagram emission. Excess cable lengths were bundled at center with 30 cm ~ 40 cm.

Each EME reported was calibrated using the R/S signal generator

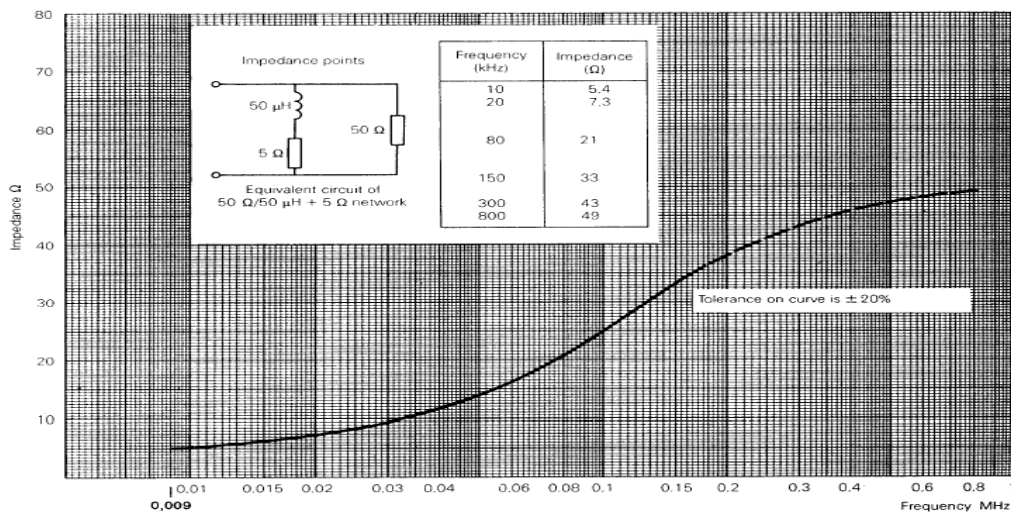

Fig 2. Impedance of LISN



5.3 Radiated Emission

Preliminary measurements were conducted 3 m semi anechoic chamber using broadband antennas to determine the frequency producing the maximum EME. Appropriate precaution was taken to ensure that all EME from the EUT were maximized and investigated. The technology configuration, mode of operation and turntable azimuth with respect to antenna was note for each frequency found.

Final measurements were made 3 m chamber (FCC registration No.: 443957) and/or 10 m OATS (FCC registration No.: 100749).

Sufficient time for the EUT, support equipment, and test equipment was allowed in order for them to warm up to their normal operating condition.

Each frequency found during pre-scan measurements was re-examined and investigated using EMI test receiver. The detector function was set to CISPR quasi-peak mode average mode and the bandwidth of the receiver was set to 120 kHz or 1 MHz depending on the frequency or type of signal.

The EUT, support equipment and interconnecting cables were reconfigured to the setup producing the maximum emission for the frequency and were placed on top of a 0.8 m high non-metallic 1.0 m × 1.5 m table.

The turntable containing the test sample was rotated; the antenna height was varied 1 to 4 meter and stopped at the azimuth or height producing the maximum emission.

Each EME reported was calibrated using the R/S signal generator

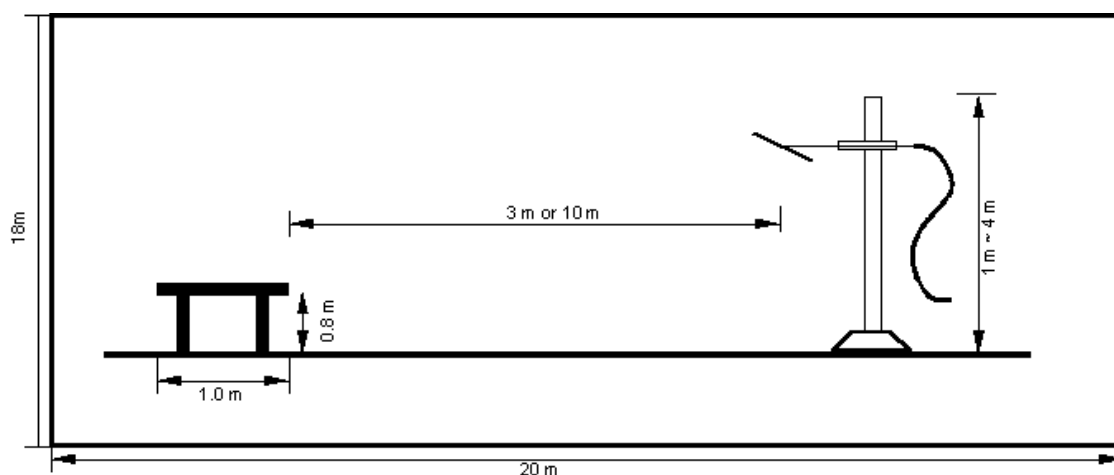

Fig 3. Dimensions of test site.



5.4 Duty Cycle Correction

Measurements may be adjusted where pulsed RF is utilized to find the average level associated with a quantity. This calculation is applied to limits for pulsed licensed and unlicensed devices.

For unlicensed intentional radiator under 47CFR Part 15 §15.35, all duty cycle measurements are compared to a 100 millisecond period.

On time = $N_1L_1 + N_2L_2 + \dots + N_nL_n$, where N_1 is number of type 1 pulses, L_1 is length of type 1 pulses, etc.

Duty Cycle = On time/100 millisecond.

5.5 Occupied Bandwidth

Occupied bandwidth was performed by coupling the output of the EUT to the input of a spectrum analyzer.

The bandwidth of the emission shall be no wider than 0.25 % of the center frequency for device operating above 70 MHz and below 900 MHz. For device operating above 900 MHz, the emission shall be no wider than 0.5 % of the center frequency. The bandwidth is determined at the points 20 dB down from the modulated carrier.



6. Duty Cycle Correction

6.1 Operating Environment

Temperature : 24.0 °C
 Relative humidity : 42.0 % R.H.

6.2 Test Set-up

The spectrum analyzer was set to Zero span and the video triggered to collect the pulse train of the modulation. Calculations of the duty cycle correction factor were obtained from time data provided by the plots.

6.3 Test Equipment used

Model Name	Manufacturer	Description	Serial Number	Due to Calibration
■ - ESIB26	Rohde & Schwarz	EMI Test Receiver	830482/010	12. 10. 2011
■ - VULB9160	Schwarzbeck	Broadband Test Antenna	3193	03. 15. 2012

6.4 Test result of Duty Cycle

- Test Date : July 5, 2011
 - Reference Standard : Part 15 Subpart C, Sec. 15.231 (a)(1)
 - Operating Condition : RF transmitting mode
 - Spectrum Resolution Bandwidth (6 dB) : 100 kHz

6.4.1 Test Frequency: 418 MHz

Define of duty cycle

- Number of Code groups per 100 ms = 1
- Number of Wide Pulse = 335
- Width of Pulses = 0.006 ms
- Number of Narrow Pulse = 693
- Width of Pulses = 0.006 ms

Calculation of duty cycle

- Total width of pulse train: $(335 \times 0.006 \text{ ms}) + (693 \times 0.006 \text{ ms}) = 6.17 \text{ ms}$
- Duty Cycle (%): $6.168 \text{ ms} / 100 \text{ ms} = 6.17 \%$
- Duty Cycle (dB): - 24.20 dB

Fundamental Frequency	Total width of ON-Time	Duty Cycle (%)	Duty Cycle (dB)
418 MHz	6.17 ms	6.17 %	- 24.20 dB

Refer to APPENDIX B: Test Plots of complete Pulse Train



7. Activation time

7.1 Operating Environment

Temperature : 24.0 °C
 Relative humidity : 42.0 % R.H.

7.2 Limit

A manually operated transmitter shall employ a switch that will automatically deactivate the transmitter within not more than 5 seconds of being released.

7.3 Test Equipment used

Model Name	Manufacturer	Description	Serial Number	Due to Calibration
■ - ESIB26	Rohde & Schwarz	EMI Test Receiver	830482/010	12. 10. 2011
■ - VULB9160	Schwarzbeck	Broadband Test Antenna	3193	03. 15. 2012

7.4 Test result of Activation time

- Test Date : July 5, 2011
- Reference Standard : Part 15 Subpart C, Sec. 15.35
- Operating Condition : RF transmitting mode
- Spectrum Resolution Bandwidth (6 dB) : 300 kHz

Fundamental Frequency	Activate ON-Time	Limit	Result
418 MHz	4.78 s	< 5 s	PASS

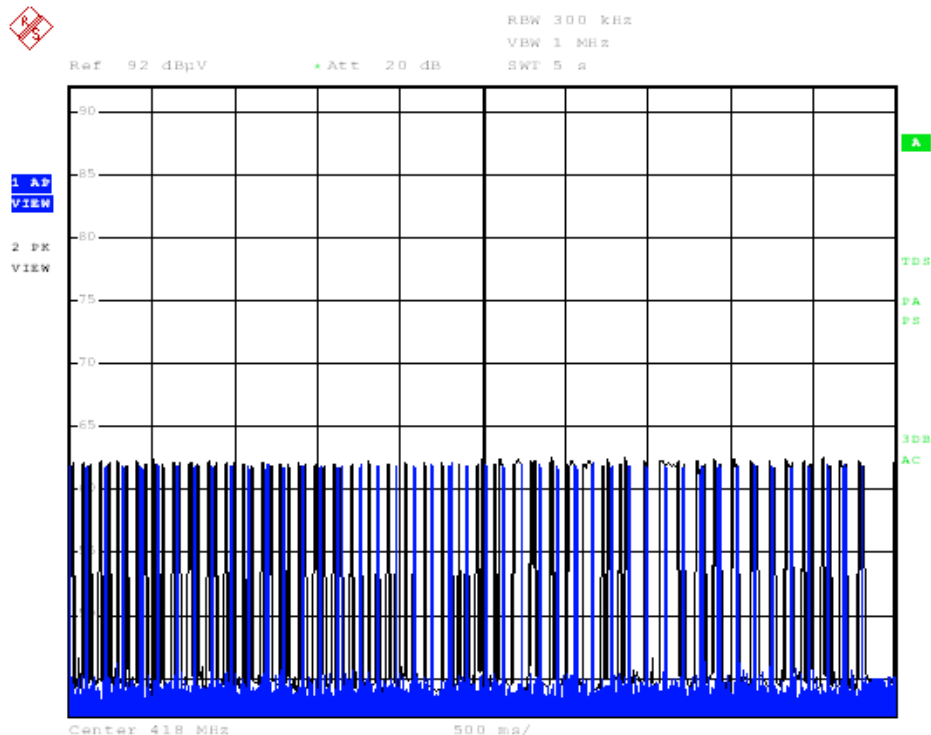



8. Radiated Emission

8.1 Operating environment

Temperature : 24.0 °C
Relative humidity : 42.0 % R.H.

8.2 Test set-up

A preliminary and final measurement was at 3 m anechoic chamber.

The EUT was placed on a non-conductive turntable approximately 0.8 m above the ground plane.

The turntable with EUT was rotated 360°, and the antenna was varied in height between 1.0 m and 4.0 m in order to determine the maximum emission levels.

This procedure was performed for both horizontal and vertical polarization of the receiving antenna.

8.3 Measurement uncertainty

The measurement uncertainty was calculated in accordance with ISO “Guide to the expression of uncertainty in measurement”.

The measurement uncertainty was given with a confidence of 95 %.

Test items(Anechoic Chamber)	Uncertainty	Remark
Radiated emission (30 MHz ~ 300 MHz, 3 m, Vertical)	± 4.38 dB	Confidence levels of 95 % ($k = 2$)
Radiated emission (30 MHz ~ 300 MHz, 3 m, Horizontal)	± 3.50 dB	Confidence levels of 95 % ($k = 2$)
Radiated emission (300 MHz ~ 1 000 MHz, 3 m, Vertical)	± 3.75 dB	Confidence levels of 95 % ($k = 2$)
Radiated emission (300 MHz ~ 1 000 MHz, 3 m, Horizontal)	± 3.59 dB	Confidence levels of 95 % ($k = 2$)



8.4 Limit

Fundamental Frequency (MHz)	Field strength of Fundamental			Field strength of Spurious Emission	
	$\mu\text{V/m}$	dB $\mu\text{V/m}$	$\mu\text{V/m}$	$\mu\text{V/m}$	dB $\mu\text{V/m}$
40.66 ~ 40.7	2 250	67.04		225	47.04
70 ~ 130	1 250	61.94		125	41.94
130 ~ 174	1 250 to 3 750	61.94 to 71.48	56.818 18(F)-6136.363 6	125 to 375	41.94 to 51.48
174 ~ 260	3 750	71.48		375	51.48
260 ~ 470	3 750 to 12 500	71.48 to 81.94	41.666 7(F)-7083.333 3	375 to 1 250	51.48 to 61.94
Above 470	12 500	81.94		1 250	61.94
Restricted Band	N/A			500	54.0

8.5 Test Equipment used

Model Name	Manufacturer	Description	Serial Number	Due to Calibration
■ - ESIB26	Rohde & Schwarz	EMI Test Receiver	830482/010	12. 10. 2011
■ - VULB9160	Schwarzbeck	Broadband Test Antenna	3193	03. 15. 2012
■ - BBHA9120D	Schwarzbeck	Horn Antenna	207	12. 22. 2011
■ - MCU066	maturo GmbH	Position Controller	1390306	N/A
■ - TT2.5SI	maturo GmbH	Turntable	1390307	N/A
■ - AM 4.0	maturo GmbH	Antenna Mast	1390308	N/A
■ - AFS 44 00101800-25-10P-44	MITEQ	Preamplifier	1258943	11. 12. 2011



8.6 Test data for Radiated Emission

- Test Date : July 5, 2011
- Reference Standard : Part 15 Subpart C, Sec.15.231
- Measuring Distance : 3 m
- Spectrum Resolution Bandwidth (6 dB): 120 kHz/1 MHz
- Note : Through three orthogonal axes were investigated and the worst case is reported.

8.6.1 Operating condition: Continuous RF transmitting mode (418 MHz)

- ♦ Field Strength of the fundamental & harmonic frequencies.
 Detector mode: Peak detector mode / Average detector mode

Frequency (MHz)	Measurement Level					Limit		Margin		Positioning System		
	Reading (dBuV)	Tranduce (dB/m)	Duty cycle (dB)	Peak (dBuV/m)	Average (dBuV/m)	Peak (dBuV/m)	Aveage (dBuV/m)	Peak (dBuV/m)	Average (dBuV/	Pol. (H/V)	Height (cm)	Angle (deg)
Fundamental												
418.00	77.94	20.06	-24.20	98.00	73.80	100.28	80.28	2.28	6.48	H	100	270
Spurious												
836.00	30.20	27.90	-24.20	58.10	33.90	80.28	60.28	22.18	26.38	H	100	20
1254.00	74.72	-13.72	-24.20	61.00	36.80	80.28	60.28	19.28	23.48	V	100	184
1672.00	84.96	-12.56	-24.20	72.40	48.20	74.00	54.00	1.60	5.80	H	100	219
2090.00	71.16	-11.26	-24.20	59.90	35.70	80.28	60.28	20.38	24.58	H	150	357
2508.00	77.08	-9.48	-24.20	67.60	43.40	80.28	60.28	12.68	16.88	V	116	237
2926.00				<<	<<					-	-	-
3344.00	65.28	-5.98	-24.20	59.30	35.10	80.28	60.28	20.98	25.18	H	112	172
3762.00	68.10	-4.30	-24.20	63.80	39.60	74.00	54.00	10.20	14.40	H	100	296
4180.00	59.9	-2.94	-24.20	57.00	32.80	74.00	54.00	17.00	21.20	H	125	200

*Comment ; below 1GHz : Tranduce = ANT factor + cable loss
 above 1GHz : Tranduce = ANT factor + cable loss + AMP gain

<<: The magin is more than 30 dB

Note: "H": Horizontal, "V": Vertical



♦ Field Strength of the spurious emission except the harmonic frequencies
 Detector mode: Quasi-peak detector mode

Frequency (MHz)	Measurement Level				Limit (dB μ V/m)	Margin (dB)	Positioning System		
	Reading Value(dB μ V)	Antenna Factor(dB/m)	Cable Loss(dB)	Test Result (dB μ V/m)			Pol. (H/V)	Height (cm)	Angle (°)
100.24	16.76	9.42	1.82	28.00	43.50	15.50	V	126	37
132.26	16.82	11.90	2.08	30.80	43.50	12.70	H	229	288
192.20	22.33	9.53	2.54	34.40	43.50	9.10	H	146	95
240.00	24.39	10.76	2.85	38.00	46.00	8.00	H	125	89

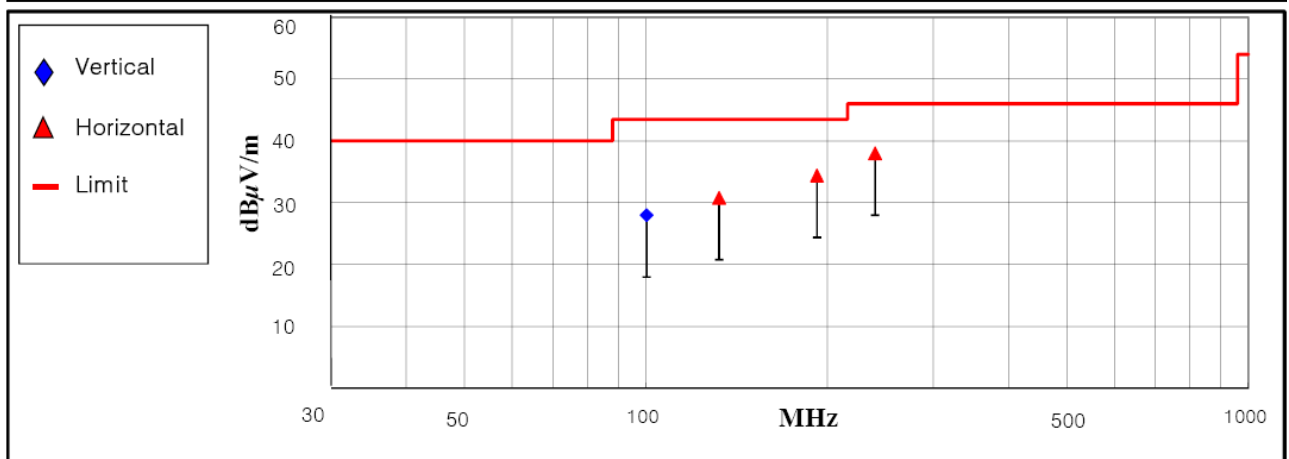

< Fig 4. Radiated emission result (30 MHz ~ 1 000 MHz) >



9. Occupied Bandwidth Measurement

9.1 Operating Environment

Temperature : 24.0 °C
 Relative humidity : 42.0 %R.H.

9.2 Test Set-up

This measurement is performed with the antenna located close enough to give a full-scale deflection of the modulated carrier on the spectrum analyzer. The plot is taken at 200 kHz/division frequency span, 100 kHz 3 dB resolution bandwidth and 5 dB/division logarithmic display from an ESI spectrum analyzer.

The measuring bandwidth shall be set to a value greater than 5 % of the allowed bandwidth (ANSI C63.4-1992 I6)

9.3 Limit

Frequency Range(MHz)	Occupied Bandwidth Limit
70 ~ 900	0.25 %
> 900	0.5 %

9.4 Test Equipment used

Model Name	Manufacturer	Description	Serial Number	Due to Calibration
■ - ESIB26	Rohde & Schwarz	EMI Test Receiver	830482/010	12. 10. 2011
■ - VULB9160	Schwarzbeck	Bi-log antenna	3193	03. 15. 2012

9.5 Test result of occupied bandwidth

- Test Date : July 5, 2011
 - Reference standard : Part 15 Subpart C, Sec. 15.231
 - Operating condition : RF transmitting mode
 - Spectrum resolution bandwidth(3dB) : 100 kHz

9.5.1 Test Frequency: 418 MHz

Allowed Bandwidth: $418 \times 0.0025 = 1045$ kHz

Fundamental Frequency	Bandwidth	Allowed Bandwidth	Result
418 MHz	953.9 kHz	1045 kHz	PASS

Refer to APPENDIX B: Test Plots of occupied bandwidth



10. Sample Calculations

$$\begin{aligned} \text{dB}\mu\text{V} &= 20 \text{ Log}_{10}(\mu\text{V}/\text{m}) \\ \text{dB}\mu\text{V} &= \text{dBm} + 107 \\ \mu\text{V} &= 10^{(\text{dB}\mu\text{V}/20)} \end{aligned}$$

10.1 Example 1 :

■ 20.3 MHz

Class B Limit	= 250 μV = 48 $\text{dB}\mu\text{V}$
Reading	= 39.2 $\text{dB}\mu\text{V}$
$10^{(39.2\text{dB}\mu\text{V}/20)}$	= 91.2 μV
Margin	= 48 $\text{dB}\mu\text{V}$ - 39.2 $\text{dB}\mu\text{V}$ = 8.8 dB

10.2 Example 2 :

■ 66.7 MHz

Class B Limit	= 100 $\mu\text{V}/\text{m}$ = 40.0 $\text{dB}\mu\text{V}/\text{m}$
Reading	= 31.0 $\text{dB}\mu\text{V}$
Antenna Factor + Cable Loss	= 5.8 dB
Total	= 36.8 $\text{dB}\mu\text{V}/\text{m}$
Margin	= 40.0 $\text{dB}\mu\text{V}/\text{m}$ - 36.8 $\text{dB}\mu\text{V}/\text{m}$ = 3.2 dB



11. Recommendation & Conclusion

The data collected shows that the **OHSUNG ELECTRONICS CO., LTD. RF REMOTE CONTROLLER (Model Name: MXW-920)** was complies with §15.231 of the FCC Rules.