

FCC EVALUATION REPORT FOR CERTIFICATION

Manufacturer: Ohsung Electronics Co., Ltd.

Date of Issue: March 24, 2017

#181 Gongdan-dong, Gumi-si, Gyeongsangbuk-Do

Order Number: GETEC-C1-17-118

South Korea

Test Report Number: GETEC-E3-17-006

Attn: Mr. Hak Ki, Kim / General Manager

Test Site: GUMI UNIVERSITY EMC CENTER

(Test firm Registration Number: 269701)

FCC ID. : OZ5URCMXHPR500

Applicant : Ohsung Electronics Co., Ltd.

Rule Part(s) : FCC Part 15 Subpart C-Intentional Radiator § 15.247
Test Method : ANSI C63.10 (2013)
Equipment Class : Digital Transmission System(DTS)
EUT Type : RF Remote Controller
Type of Authority : Certification
Model Name : MXHP-R500
Trade Mark : URC

This equipment has been shown to be in compliance with the applicable technical standards as indicated in the measurement report and was tested in accordance with the measurement procedures specified in ANSI C63.10 (2013)

I attest to the accuracy of data. All measurements reported herein were performed by me or were made under my supervision and are correct to the vest of my knowledge and belief. I assume full responsibility for the completeness of these measurements and vouch for the qualifications of all persons taking them.

Tested by,

Reviewed by,

Soon Hoon

Soon-Hoon Jeong, Senior Engineer
GUMI UNIVERSITY EMC CENTER

Jae-Hoon Jeong

Jae-Hoon Jeong, Technical Manager
GUMI UNIVERSITY EMC CENTER



CONTENTS

1. GENERAL INFORMATION	4
2. INTRODUCTION	5
3. PRODUCT INFORMATION	6
3.1 DESCRIPTION OF EUT.....	6
3.2 DEFINITION OF MODELS.....	6
3.3 SUPPORT EQUIPMENT / CABLES USED	7
3.4 MODIFICATION ITEM(S).....	7
4. ANTENNA REQUIREMENT - §15.203	8
4.1 DESCRIPTION OF ANTENNA.....	8
5. DESCRIPTION OF TESTS.....	8
5.1 TEST CONDITION.....	8
6. REFERENCES STANDARDS	8
7. SUMMARY OF TEST RESULTS	9
8. 6 DB BANDWIDTH MEASUREMENT	10
8.1 OPERATING ENVIRONMENT	10
8.2 TEST SET-UP (LAYOUT)	10
8.3 LIMIT	10
8.4 TEST EQUIPMENT USED.....	10
8.5 TEST TEST PROCEDURE	10
8.6 TEST RESULT	11
9. CONDUCTED MAXIMUM PEAK OUTPUT POWER MEASUREMENT	18
9.1 OPERATING ENVIRONMENT	18
9.2 TEST SET-UP (LAYOUT)	18
9.3 LIMIT	18
9.4 TEST EQUIPMENT USED.....	18
9.5 TEST PROCEDURE	18
9.6 TEST RESULT	19
10. POWER SPECTRAL DENSITY MEASUREMENT.....	20
10.1 OPERATING ENVIRONMENT	20
10.2 TEST SET-UP (LAYOUT)	20
10.3 LIMIT	20
10.4 TEST EQUIPMENT USED.....	20
10.5 TEST PROCEDURE	20
10.6 TEST RESULT	21
11. CONDUCTED SPURIOUS EMISSION & OUT OF BAND EMISSION	28
11.1 OPERATING ENVIRONMENT.....	28
11.2 TEST SET-UP (LAY-OUT).....	28
11.3 LIMIT	28
11.4 TEST EQUIPMENT USED	28
11.5 TEST PROCEDURE.....	28
11.6 TEST RESULT	29





12. AC POWER LINE CONDUCTED EMISSION	38
12.1 OPERATING ENVIRONMENT	39
12.2 TEST SET-UP	39
12.3 MEASUREMENT UNCERTAINTY.....	39
12.4 LIMIT	40
12.5 TEST EQUIPMENT USED.....	40
12.6 TEST DATA FOR CONDUCTED EMISSION	40
12.7 TEST RESULT	41
13. RADIATED SPURIOUS & RESTRICTED BAND EDGE EMISSION.....	44
13.1 OPERATING ENVIRONMENT	45
13.2 TEST SET-UP.....	45
13.3 MEASUREMENT UNCERTAINTY	45
13.4 LIMIT	46
13.5 TEST EQUIPMENT USED.....	46
13.6 TEST DATA FOR RADIATED SPURIOUS EMISSION.....	47
13.7 TEST DATA FOR RADIATED RESTRICTED BAND EDGE EMISSION	51
14. SAMPLE CALCULATIONS.....	52
14.1 EXAMPLE 1 :	52
14.2 EXAMPLE 2 :	52
15. RECOMMENDATION & CONCLUSION.....	53
APPENDIX A – ATTESTATION STATEMENT	
APPENDIX B – LABELLING	
APPENDIX C – BLOCK DIAGRAM	
APPENDIX D – SCHEMATIC DIAGRAM	
APPENDIX E – TEST SETUP PHOTOGRAPH	
APPENDIX F – EXTERNAL PHOTOGRAPH	
APPENDIX G – INTERNAL PHOTOGRAPH	
APPENDIX H – USER’S MANUAL	
APPENDIX I – OPERATIONAL DESCRIPTION	
APPENDIX J – ANTENNA SPECIFICATION	
APPENDIX K – PART LIST	
APPENDIX L – RF EXPOSURE EVALUATION	





Scope: Measurement and determination of electromagnetic emissions (EME) of radio frequency devices including intentional and / or unintentional radiators for compliance with technical rules and regulations of the Federal Communications Commission.

1. General Information

Applicant: Ohsung Electronics Co., Ltd.

Applicant Address: #141 Gongdan-dong, Gumi-si, Gyeongbuk, Republic of Korea

Manufacturer: Ohsung Electronics Co., Ltd.

Manufacturer Address: #141 Gongdan-dong, Gumi-si, Gyeongbuk, Republic of Korea

Contact Person: Hak Ki, Kim / General Manager

Telephone Number: +82-54-468-7281 Fax Number: +82-54-461-8368

- **FCC ID.** OZSURCMXHPR500
- **Equipment Class** Digital Transmission System (DTS)
- **EUT Type** RF Remote Controller
- **Model Name** MXHP-R500
- **Rule Part(s)** FCC Part 15 Subpart C-Intentional Radiator § 15.247
- **Test Method** ANSI C63.10 (2013)
- **Type of Authority** Certification
- **Test Procedure(s)** ANSI C63.10 (2013), KDB558074 D01 DTS Meas Guidance v03r05(April 8,2016)
- **Dates of Test** February 22~ March 10, 2017
- **Place of Test** GUMI UNIVERSITY EMC CENTER (FCC Test firm Registration No.: 269701)
37 Yaeun-ro, Gumi-si, Gyeongsangbuk-do, 730-711, Republic of Korea
- **Test Report Number** GETEC-E3-17-006
- **Dates of Issue** March 24, 2017

EUT Type: RF Remote Controller

FCC ID.: OZSURCMXHPR500





2. Introduction

The measurement procedure described in American National Standard for Methods of Measurement of Radio-Nose Emissions From Low-Voltage Electrical and Electronic Equipment in the Range of 9 kHz to 40 GHz (ANSI C63.4-2009) was used in determining radiated and conducted emissions emanating from **Ohsung Electronics Co., Ltd. RF Remote Controller (Model name: MXHP-R500)**

These measurement tests were conducted at **GUMI UNIVERSITY EMC CENTER**.

The site address is 37 Yaeun-ro, Gumi-si, Gyeongsangbuk-do, 730-711, Gyeongnam 641-713, Korea

This test site is one of the highest point of GUMI UNIVERSITY at about 200 kilometers away from Seoul city and 40 kilometers away from Daegu city. It is located in the valley surrounded by mountains in all directions where ambient radio signal conditions are quiet and a favorable area to measure the radio frequency interference on open field test site for the computing and ISM devices manufactures. The detailed description of the measurement facility was found to be in compliance with the requirements of §2.948 according to ANSI C63.10 (2013)

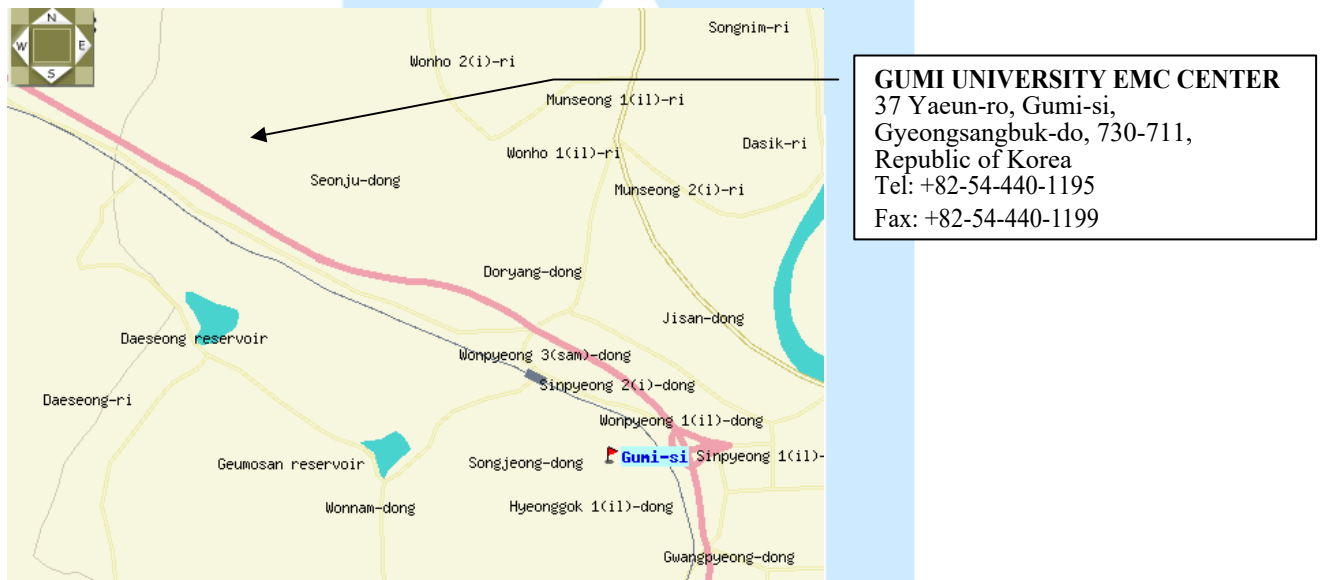

Fig 1. The map above shows the Gumi University in vicinity area.





3. Product Information

3.1 Description of EUT

The Equipment under Test (EUT) is the **Ohsung Electronics Co., Ltd. RF Remote Controller (Model Name: MXHP-R500) FCC ID.: OZ5URCMXHPR500**

- Equipment	: RF Remote Controller
- Model name	: MXHP-R500
- Brand name	: UNIVERSAL REMOTE CONTROLLER
- Serial number	: Proto type
- Electrical Rating	: DC 3.7 V
- Size	: 8.66" H x 1.19" D x 2.04" W
- Manufacturer	: Ohsung electronics Co., Ltd.
- Channel Separations	: 5 MHz
- Type of Modulation	: DSSS, OFDM
- Channel frequency	: 2 412 MHz ~ 2 462 MHz
- Number of channel	: 11
- Type of chain	: One
- Antenna specification	: Manufacturer: Ohsung Electronics Co., Ltd. Antenna type : PCB pattern antenna Gain : 0.67 dBi
- Hardware version	: V0.3.0.0
- Software version	: V1.2.3.5

3.2 Definition of models

-None.





3.3 Support Equipment / Cables used

3.3.1 Used Support Equipment

Description	Manufacturer	Model Name	S/N & FCC ID.
Notebook Computer ¹⁾	SAMSUNG	NT-Q45	S/N: CNBA4300168AI00682D5800 FCC ID.: N/A
Uart board	Ohsung Electronics Co., Ltd.	Proto type	S/N : None. FCC ID.: None.

Note)

1) The Support Equipment use only setting to the test mode.

3.3.2 System configuration

Description	Manufacturer	Model Name	S/N & FCC ID.
Wireless Remote Controller	Ohsung Electronics Co., Ltd.	MXHP-R500	S/N : None. FCC ID.: None.
AC/DC Adaptor	DEE VAN ENTERPRISE CO LTD	DSA-6PFE-05 FUS 050100	S/N: 5114HB FCC ID.: None.

3.3.3 Used Cable(s)

Cable Name	Condition	Description
Power cable	Connected between EUT and AC/DC Adaptor	1.5 m shielded with a ferrite core.

3.4 Modification Item(s)

- None

EUT Type: RF Remote Controller

FCC ID.: OZ5URCMXHPR500





4. Antenna Requirement - §15.203

An intentional radiator antenna shall be designed to ensure that no antenna other than that furnished by the applicant can be used with the device. The use of permanently attached antenna or of an antenna that uses a unique coupling to the intentional radiator shall be considered sufficient to comply with this requirement.

4.1 Description of Antenna

The **Ohsung Electronics Co., Ltd. RF Remote Controller**, comply with the requirement of §15.203 with a PCB printed antenna permanently attached to the transmitter.

5. Description of tests

5.1 Test Condition

The EUT was installed, arranged and operated in a manner that is most representative of equipment as typically used. The measurements were carried out while varying operating modes and cable positions within typically arrangement to determine maximum emission level.

The representative and worst test mode(s) were noted in the test report.

- Test Voltage / Frequency: 3.7 V / DC
- Operating condition during the test(s) :
 - Continuous RF transmitting mode with nominal maximum RF output power.
 - Operating channel frequency and modulation technology

Mode	Available channel	Frequency	Modulation Technology
IEEE 802.11b	1 ~ 11	2412 ~ 2462 MHz	DSSS
IEEE 802.11g	1 ~ 11	2412 ~ 2462 MHz	OFDM
IEEE 802.11n	1 ~ 11	2412 ~ 2462 MHz	OFDM

- EUT set condition (RF power setting value)

Test Software version	Channel	RF power setting value
Tera term v4.8.9	1 ~ 11	4

6. References Standards

- FCC Part 15 (2009) Subpart C-Intentional Radiator §15.247
- ANSI C 63.10 (2013): American National Standard for Testing Unlicensed Wireless Devices
- KDB 558074 D01 DTS meas Guidance v03r05 (April 08, 2016): Guidance for Performing Compliance Measurements on Digital Transmission Systems (DTS) Operating Under §15.247





7. SUMMARY OF TEST RESULTS

FCC Part Section(s)	Test Description	Test Result
§15.247(a)(2)	6 dB Bandwidth	Pass
§15.247(b)(3)	Conducted Maximum Peak Output Power	Pass
§15.247(e)	Power Spectral Density	Pass
§15.247(d)	Conducted Out of Band Emission Emissions	Pass
§15.207(a)	AC Power line Conducted Emissions	Pass
§15.205, 15.209	Radiated Spurious Emissions	Pass
§15.247(d), 15.205, 15.209	Radiated Restricted Band Edge	Pass





8. 6 dB Bandwidth Measurement

8.1 Operating environment

Temperature : 17.6 °C
 Relative Humidity : 26.3 % R.H.

8.2 Test Set-up (Layout)

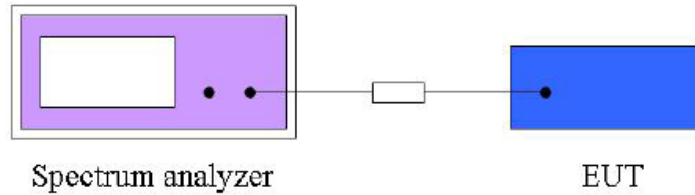

8.3 Limit

For digital modulation systems, the minimum 6 dB bandwidth shall be at least 500 kHz

8.4 Test Equipment used

Model Name	Manufacturer	Description	Serial Number	Due to Calibration
■ - FSV	Rohde & Schwarz	Signal Analyzer	101552	May. 23, 2017
■ - 56-10	Weinschel	10 dB Attenuator	53184	Apr. 20, 2017

8.5 Test Test Procedure

- Set RBW = 100 kHz.
- Set the video bandwidth (VBW) $\geq 3 \times$ RBW.
- Detector = Peak.
- Trace mode = max hold.
- Sweep = auto couple.
- Allow the trace to stabilize.
- Measure the maximum width of the emission that is constrained by the frequencies associated with the two outermost amplitude points (upper and lower frequencies) that are attenuated by 6 dB relative to the maximum level measured in the fundamental emission.





8.6 Test result

- Test Date : March 08, 2017
- Reference Standard : Part 15 Subpart C, Sec. 15.247(a)(2)
- Test Procedure(s) : ANSI C63.10 (2013), KDB558074 D01 DTS Meas Guidance v03r05(April 8,2016)
- Operating Condition : RF transmitting mode (1 ch: 2 412 MHz, 6 ch: 2 437 MHz, 11 ch: 2 462 MHz)
- Power Source : DC 3.7 V

IEEE 802.11b

Frequency (MHz)	6 dB Bandwidth (MHz)	Min. Limit (MHz)	Result
2 412	8.02	0.50	Complies
2 437	8.50	0.50	Complies
2 462	8.50	0.50	Complies

IEEE 802.11g

Frequency (MHz)	6 dB Bandwidth (MHz)	Min. Limit (MHz)	Result
2 412	15.09	0.50	Complies
2 437	15.09	0.50	Complies
2 462	15.09	0.50	Complies

IEEE 802.11n

Frequency (MHz)	6 dB Bandwidth (MHz)	Min. Limit (MHz)	Result
2 412	17.31	0.50	Complies
2 437	17.31	0.50	Complies
2 462	17.61	0.50	Complies





6 dB Bandwidth Plot on Configuration : IEEE 802.11b 1ch

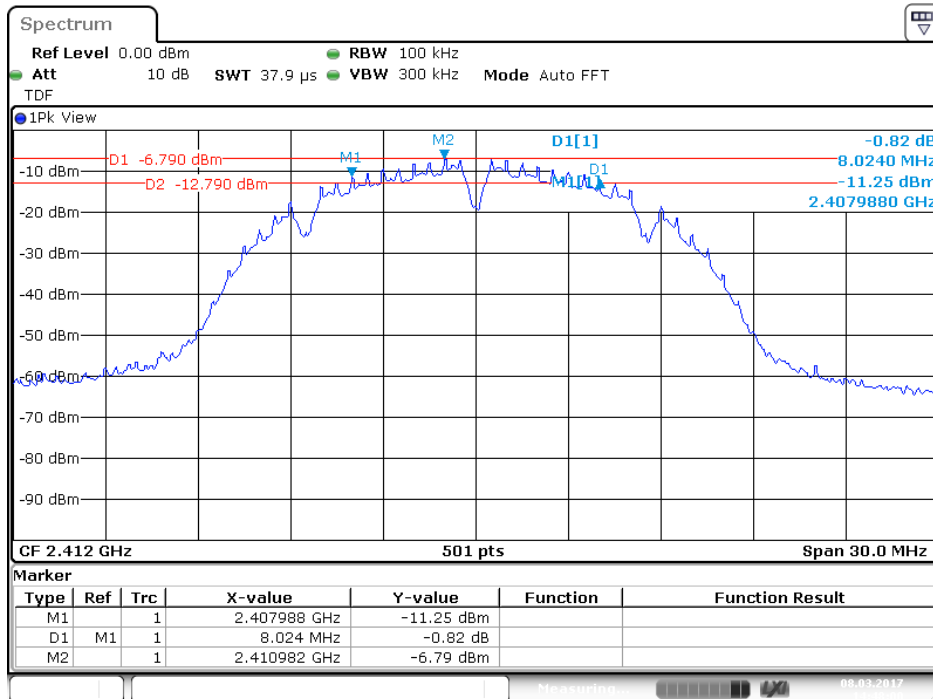

Date: 8 MAR 2017 14:48:00

6 dB Bandwidth Plot on Configuration : IEEE 802.11b 6ch

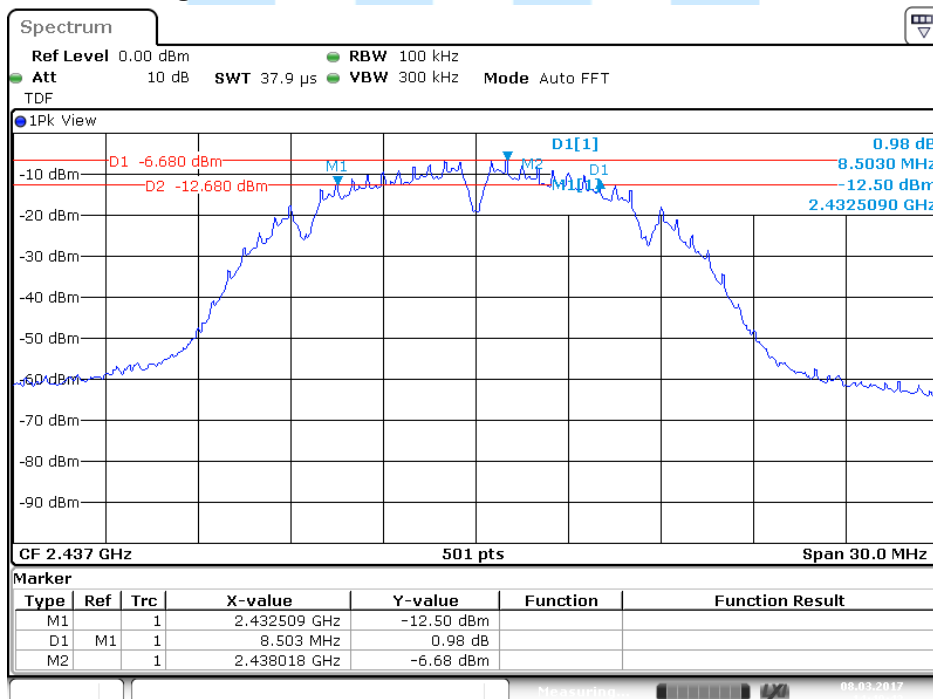

Date: 8 MAR 2017 14:49:44





6 dB Bandwidth Plot on Configuration : IEEE 802.11b 11ch

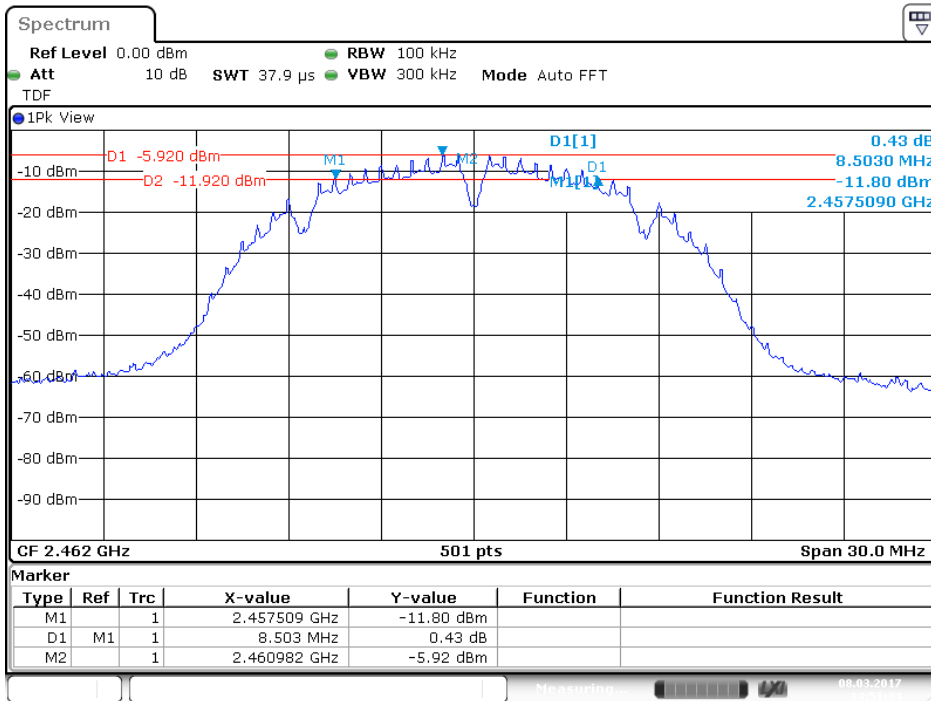

Date: 8 MAR 2017 14:51:34

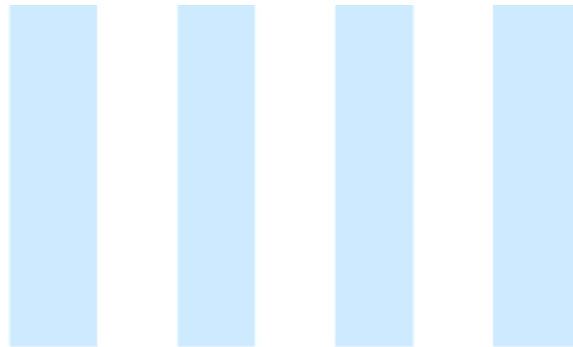



6 dB Bandwidth Plot on Configuration : IEEE 802.11g 1ch

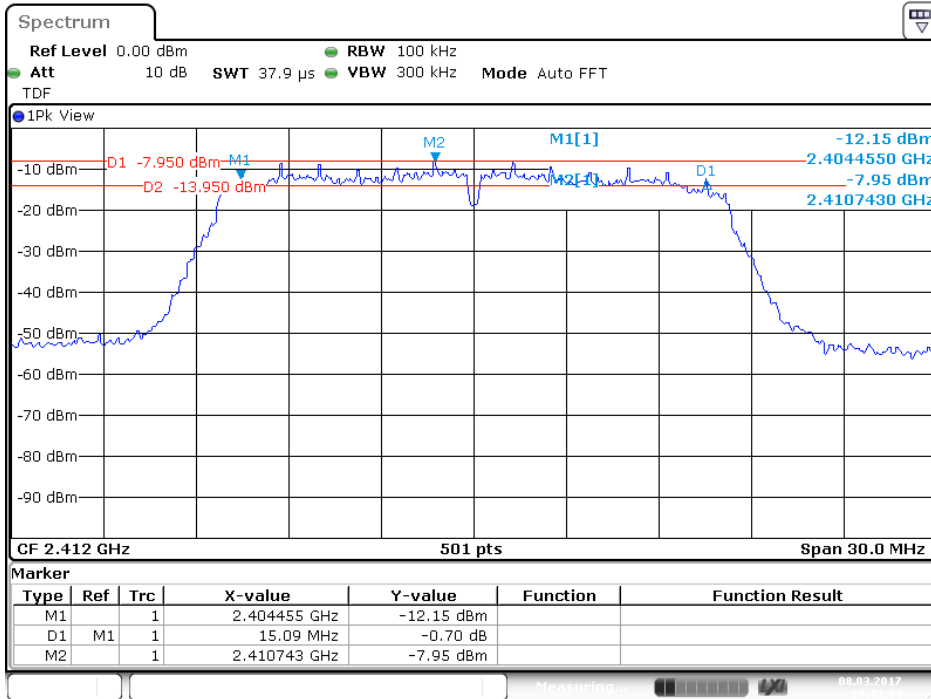

6 dB Bandwidth Plot on Configuration : IEEE 802.11g 6ch

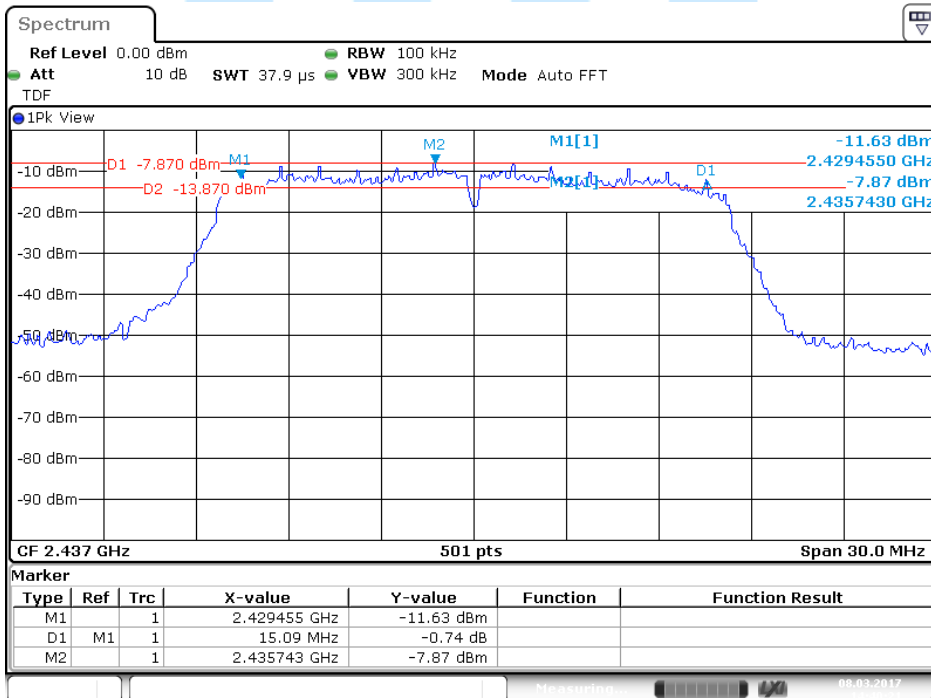



6 dB Bandwidth Plot on Configuration : IEEE 802.11g 11ch

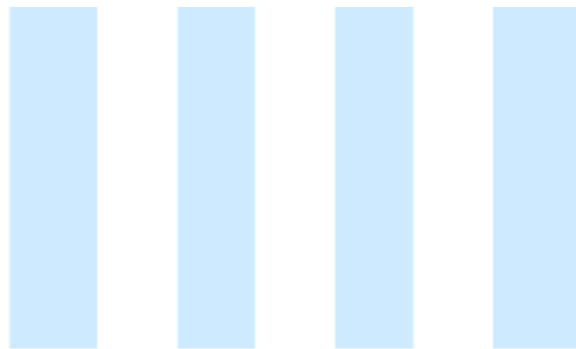
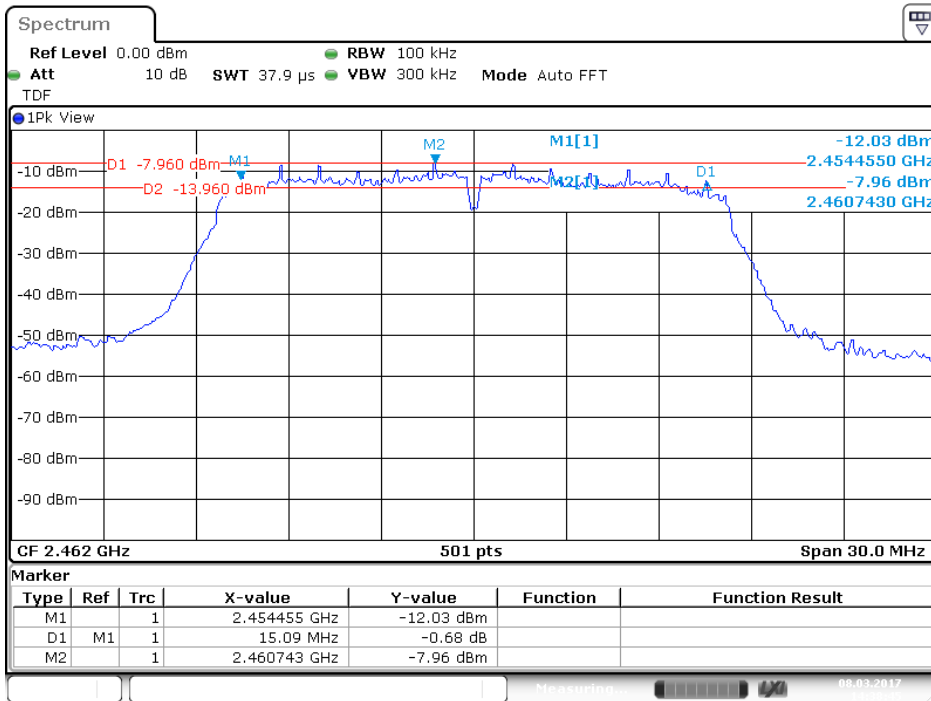



6 dB Bandwidth Plot on Configuration : IEEE 802.11n 1ch

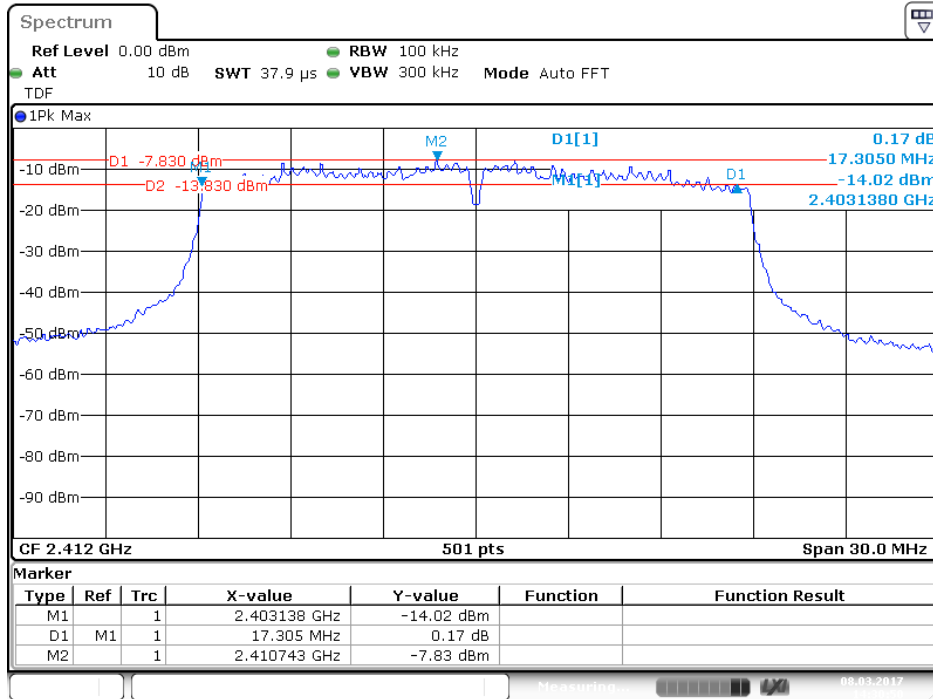

Date: 8 MAR 2017 14:30:50

6 dB Bandwidth Plot on Configuration : IEEE 802.11n 6ch

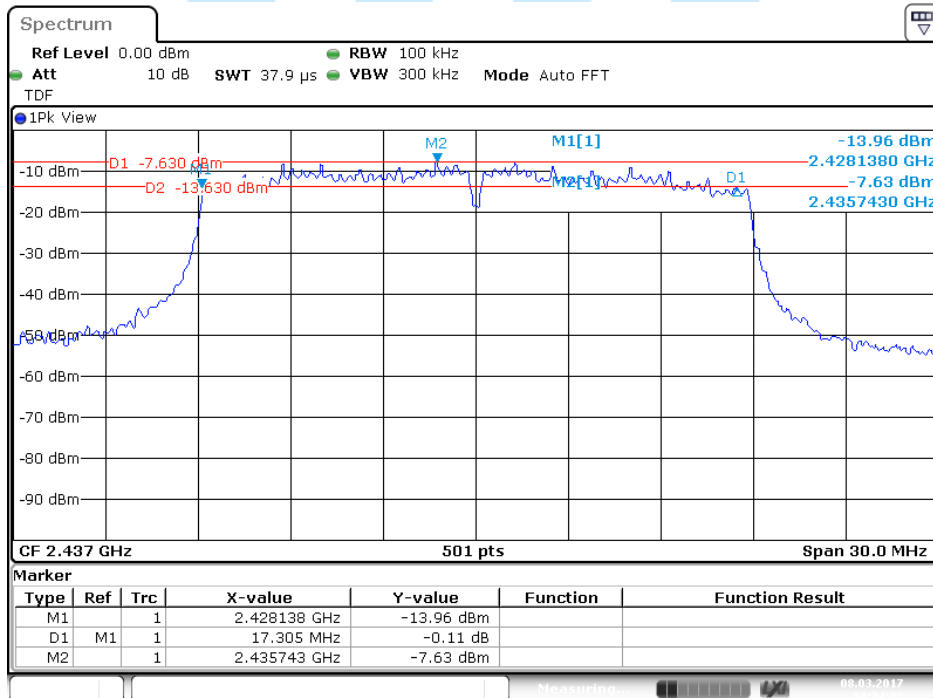

Date: 8 MAR 2017 14:34:04





6 dB Bandwidth Plot on Configuration : IEEE 802.11n 11ch

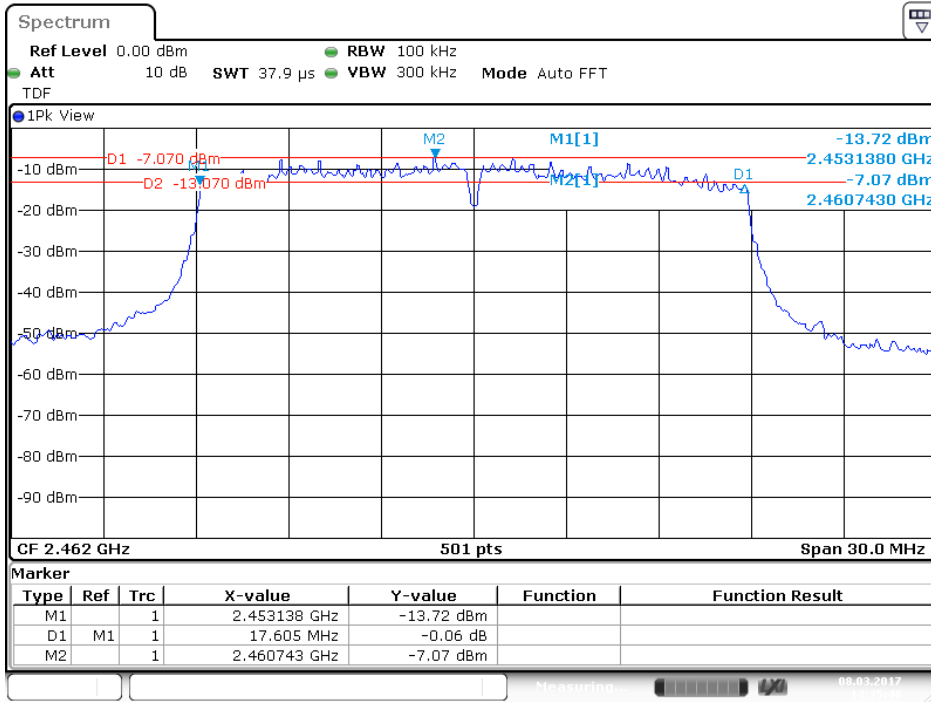

Date: 8 MAR 2017 14:35:48

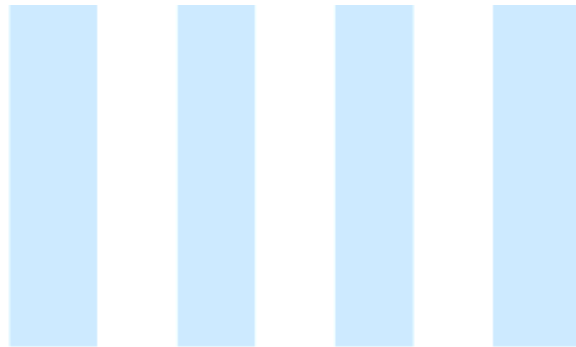



9. Conducted Maximum Peak Output Power Measurement

9.1 Operating environment

Temperature : 15.1 °C
 Relative Humidity : 26.4 % R.H.

9.2 Test Set-up (Layout)

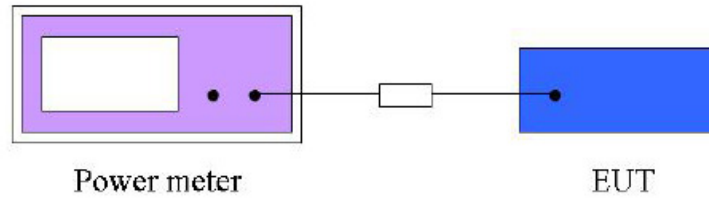

9.3 Limit

For systems using digital modulation in the (2 400~2 483.5) MHz, the limit for peak output power is 30 dBm. The limit has to be reduced by the amount in dB that the gain of the antenna exceeds 6 dBi. In case of point-to-point operation, the limit has to be reduced by 1 dB for every 3 dB that the directional gain of the antenna exceeds 6 dBi.

9.4 Test Equipment used

Model Name	Manufacturer	Description	Serial Number	Due to Calibration
■ - NRV-Z32	Rohde & Schwarz	Peak Power sensor	100049	Dec. 06, 2017
■ - NRVS	Rohde & Schwarz	Single Channel Power Meter	101008	Apr 19, 2017
■ - NRP-Z51	Rohde & Schwarz	Power sensor	1138.0005.02	Apr. 20, 2017
■ - 56-10	Weinschel	10 dB Attenuator	53184	Apr. 20. 2017

9.5 Test Procedure

A peak power sensor was used on the output port of the EUT. A power meter was used to read the response of the peak power sensor. Record the power level.





9.6 Test Result

- Test Date : March 08, 2017
- Reference Standard : Part 15 Subpart C, Sec. 15.247(a)(2)
- Test Procedure(s) : ANSI C63.10 (2013), KDB558074 D01 DTS Meas Guidance v03r05(April 8,2016)
- Operating Condition : RF transmitting mode (1 ch: 2 412 MHz, 6 ch: 2 437 MHz, 11 ch: 2 462 MHz)
- Power Source : DC 3.7 V

IEEE 802.11b

Frequency (MHz)	Average Conducted Power ¹⁾ (dBm)	Peak Conducted Power (dBm)	Max. Limit (dBm)	Result
2 412	1.22	2.48	30.00	Complies
2 437	1.52	2.88	30.00	Complies
2 462	2.25	3.55	30.00	Complies

Note: 1) The Average output power is reference data for RF Exposure.

IEEE 802.11g

Frequency (MHz)	Average Conducted Power ¹⁾ (dBm)	Peak Conducted Power (dBm)	Max. Limit (dBm)	Result
2 412	2.31	7.86	30.00	Complies
2 437	2.99	8.62	30.00	Complies
2 462	3.35	9.31	30.00	Complies

Note: 1) The Average output power is reference data for RF Exposure.

IEEE 802.11n

Frequency (MHz)	Average Conducted Power ¹⁾ (dBm)	Peak Conducted Power (dBm)	Max. Limit (dBm)	Result
2 412	2.15	7.18	30.00	Complies
2 437	2.55	7.76	30.00	Complies
2 462	3.16	8.77	30.00	Complies

Note: 1) The Average output power is reference data for RF Exposure.





10. Power Spectral Density Measurement

10.1 Operating Environment

Temperature : 17.5 °C
 Relative Humidity : 26.9 % R.H.

10.2 Test Set-up (Layout)

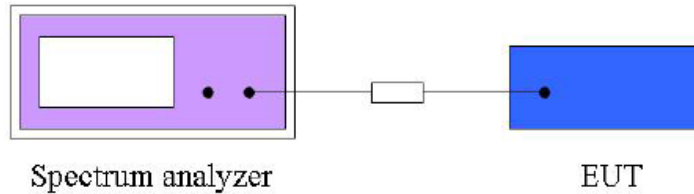

10.3 Limit

For digitally modulated systems, the power spectral density conducted from the intentional radiator to the antenna shall not be greater than 8 dBm in any 3 kHz band during any time interval of continuous transmission

10.4 Test Equipment used

Model Name	Manufacturer	Description	Serial Number	Due to Calibration
■ - FSV	Rohde & Schwarz	Signal Analyzer	101552	May. 23, 2017
■ - 56-10	Weinschel	10 dB Attenuator	53184	Apr. 20, 2017

10.5 Test Procedure

- a) Set analyzer center frequency to DTS channel center frequency.
- b) Set the span to 1.5 times the DTS bandwidth.
- c) Set the RBW to 3 kHz
- d) Set the VBW to 10 kHz
- e) Detector = peak.
- f) Sweep time = auto couple.
- g) Trace mode = max hold.
- h) Allow trace to fully stabilize.
- i) Use the peak marker function to determine the maximum amplitude level within the RBW.





10.6 Test Result

- Test Date : March 08, 2017
- Reference Standard : Part 15 Subpart C, Sec. 15.247(a)(2)
- Test Procedure(s) : ANSI C63.10 (2013), KDB558074 D01 DTS Meas Guidance v03r05(April 8,2016)
- Operating Condition : RF transmitting mode (1 ch: 2 412 MHz, 6 ch: 2 437 MHz, 11 ch: 2 462 MHz)
- Power Source : DC 3.7 V

IEEE 802.11b

Frequency	PSD (dBm/3kHz)	Max. Limit (dBm/3kHz)	Result
2 412 MHz	-19.60	8.00	Complies
2 437 MHz	-19.20	8.00	Complies
2 462 MHz	-18.91	8.00	Complies

IEEE 802.11g

Frequency	PSD (dBm/3kHz)	Max. Limit (dBm/3kHz)	Result
2 412 MHz	-19.69	8.00	Complies
2 437 MHz	-19.55	8.00	Complies
2 462 MHz	-19.24	8.00	Complies

IEEE 802.11n

Frequency	PSD (dBm/3kHz)	Max. Limit (dBm/3kHz)	Result
2 412 MHz	-20.38	8.00	Complies
2 437 MHz	-20.29	8.00	Complies
2 462 MHz	-20.57	8.00	Complies





Power Density Plot on configuration : IEEE 802.11b 1ch

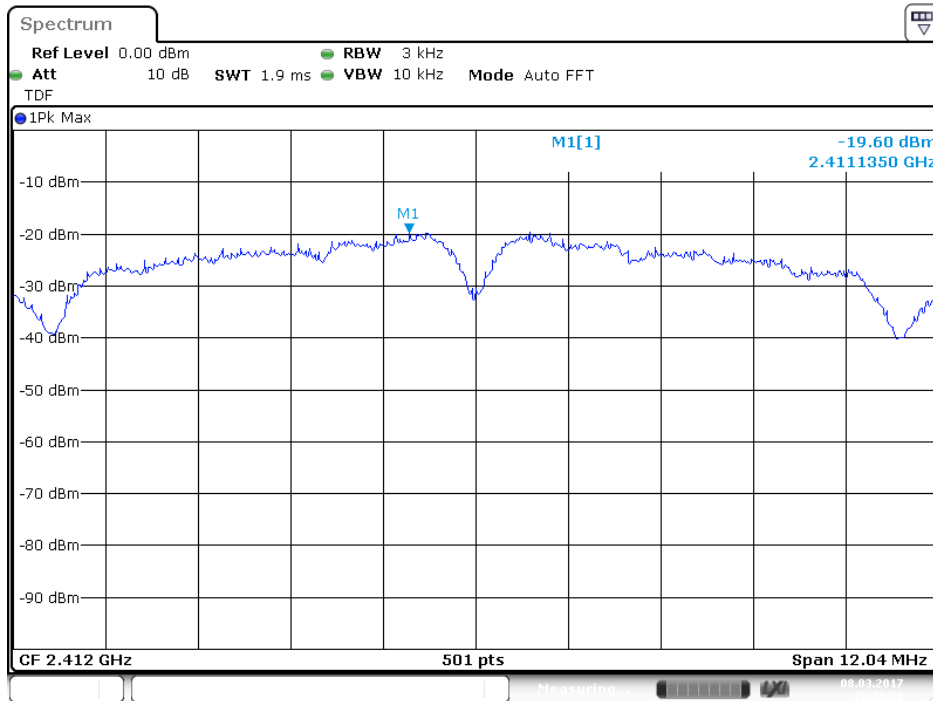

Power Density Plot on configuration : IEEE 802.11b 6ch

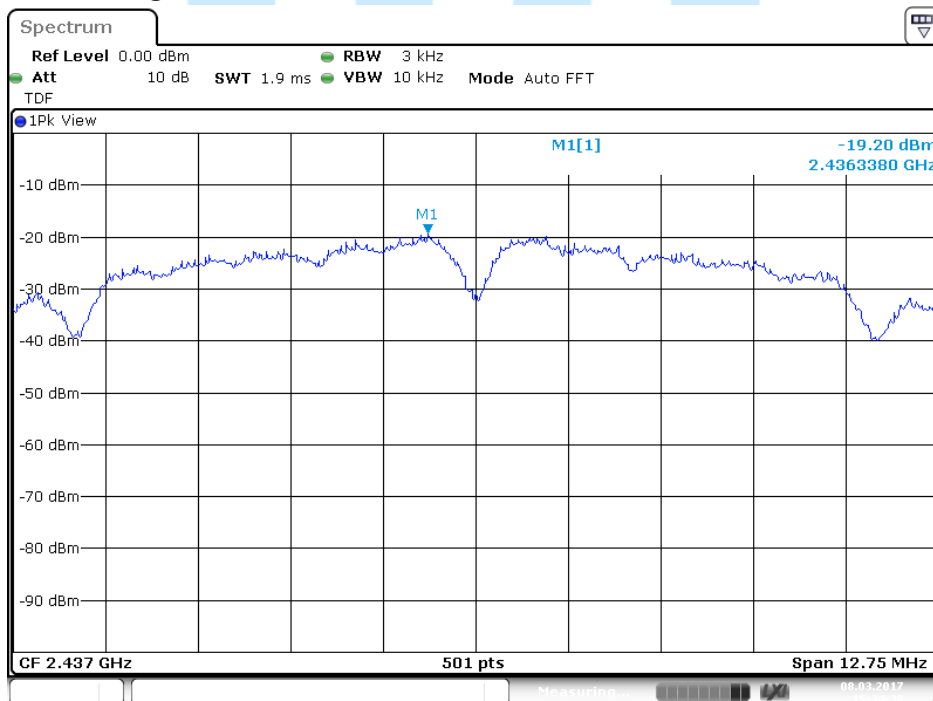



Power Density Plot on configuration : IEEE 802.11b 11ch

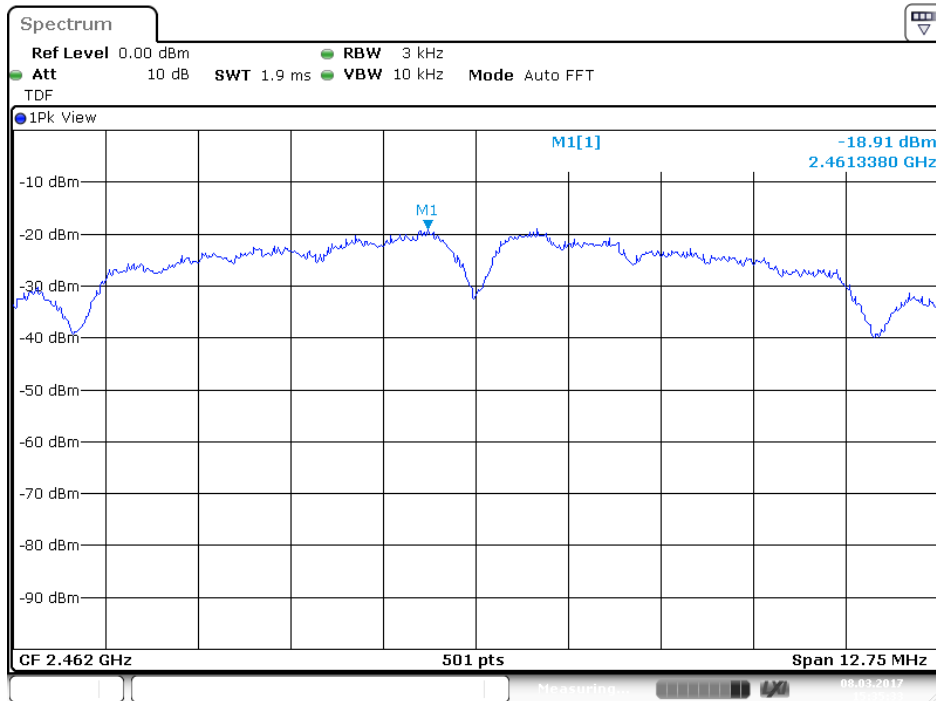

Date: 8 MAR 2017 15:35:34





Power Density Plot on configuration : IEEE 802.11g 1ch

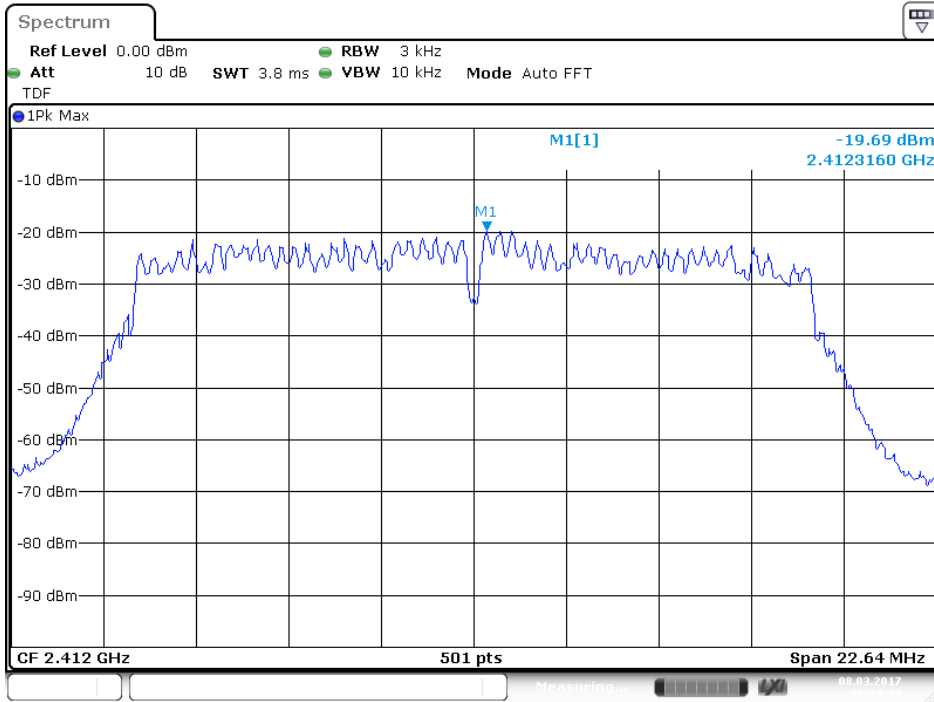

Power Density Plot on configuration : IEEE 802.11g 6ch

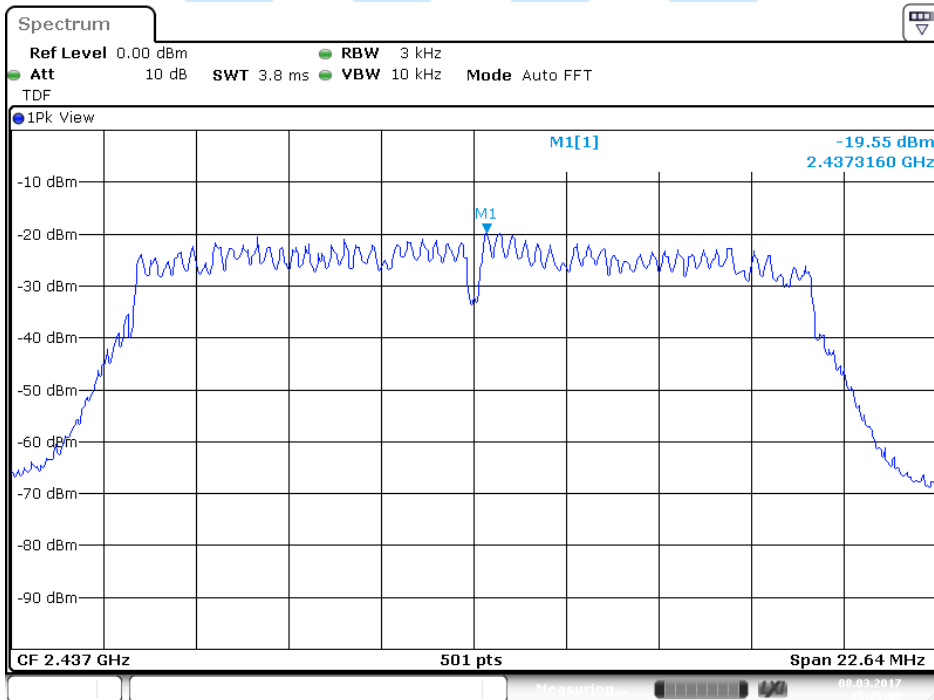

EUT Type: RF Remote Controller

FCC ID.: OZ5URCMXHP500





Power Density Plot on configuration : IEEE 802.11g 11ch

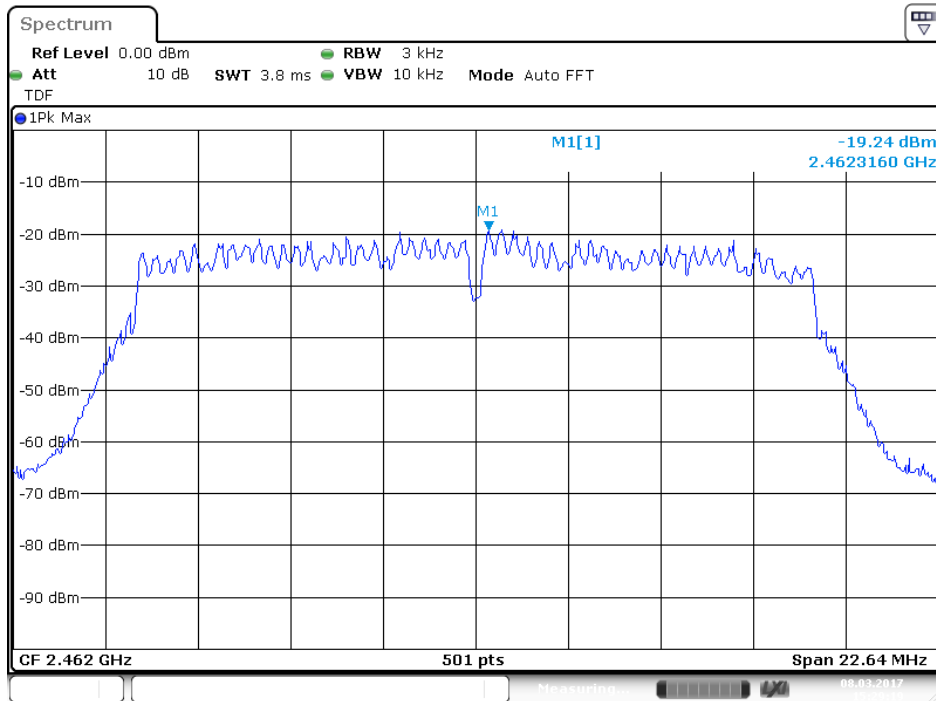

Date: 8 MAR 2017 15:29:20





Power Density Plot on configuration : IEEE 802.11n 1ch

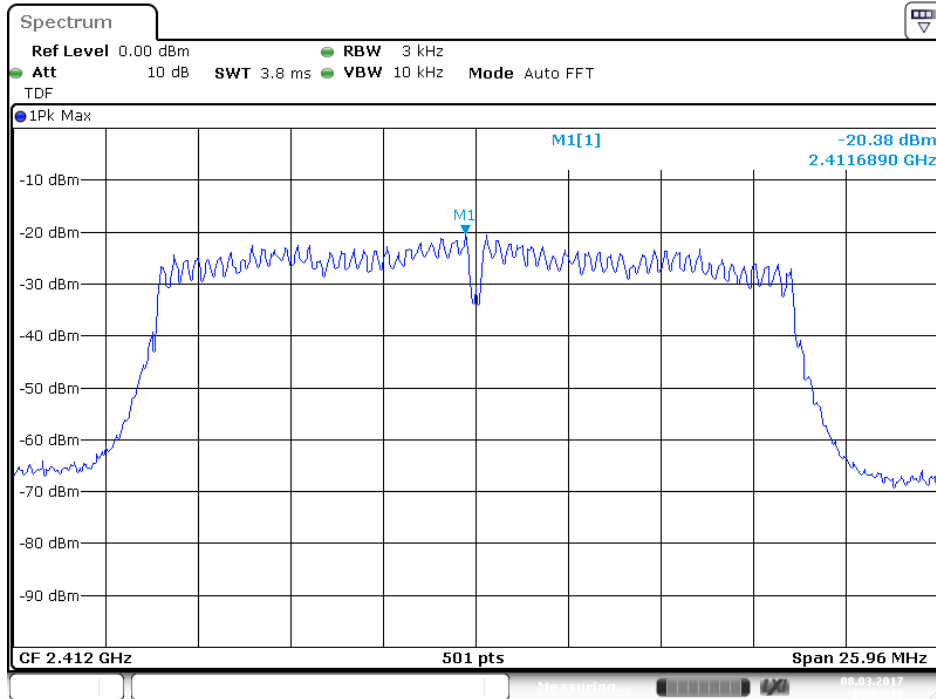

Power Density Plot on configuration : IEEE 802.11n 6ch

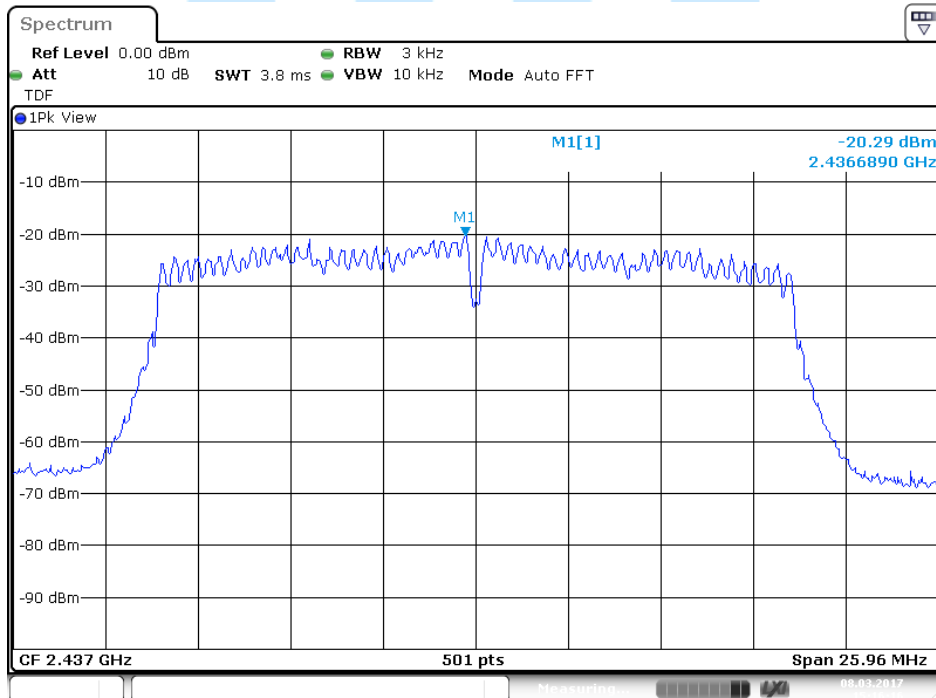

EUT Type: RF Remote Controller

FCC ID.: OZSURCMXHP500





Power Density Plot on configuration : IEEE 802.11n 11ch

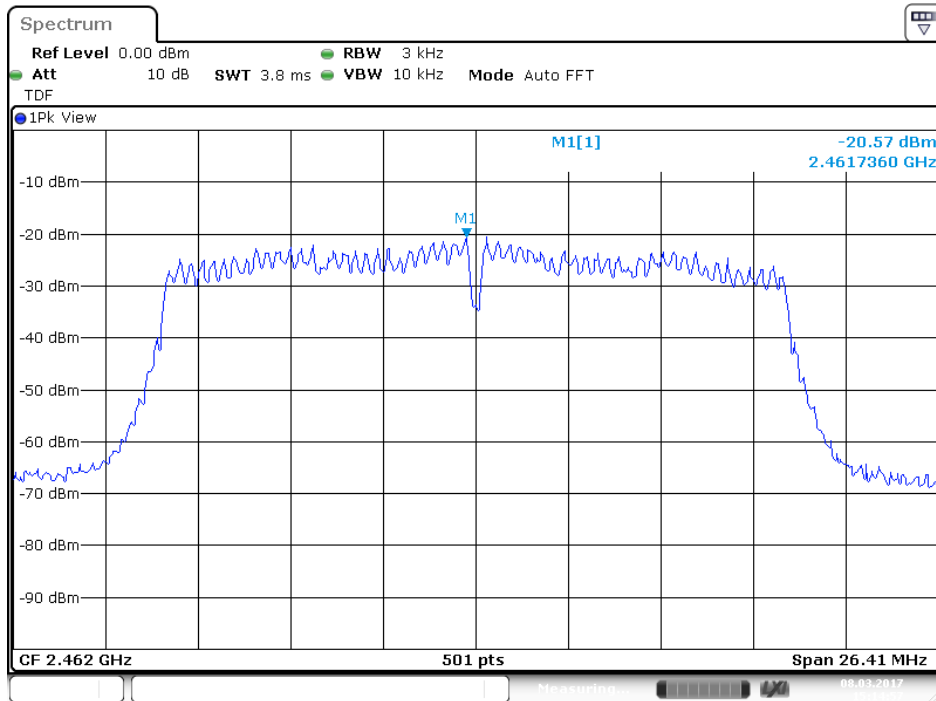

Date: 8 MAR 2017 15:14:57





11.6 Test Result

- Test Date : March 08, 2017
- Reference standard : Part 15 Subpart C, Sec. 15.247(a)(2)
- Test Procedure(s) : ANSI C63.10 (2013), KDB558074 D01 DTS Meas Guidance v03r05(April 8,2016)
- Operating condition : RF transmitting mode (1 ch: 2 412 MHz, 6 ch: 2 437 MHz, 11 ch: 2 462 MHz)
- Power Source : DC 3.7 V

**Conducted Spurious Emission
 IEEE 802.11b**

Operating Frequency	100 kHz PSD (dBm)	Spurious Level (dBm)	Deviation (dBc)	Limits (dBc)	Result
2 412 MHz	-5.59	-61.27	-55.68	-20.00	Complies
2 437 MHz	-5.55	-60.67	-55.12		Complies
2 462 MHz	-5.21	-61.58	-56.37		Complies

IEEE 802.11g

Operating Frequency	100 kHz PSD (dBm)	Spurious Level (dBm)	Deviation (dBc)	Limits (dBc)	Result
2 412 MHz	-8.04	-61.03	-52.99	-20.00	Complies
2 437 MHz	-7.30	-61.02	-53.72		Complies
2 462 MHz	-6.88	-60.89	-54.01		Complies

IEEE 802.11n

Operating Frequency	100 kHz PSD (dBm)	Spurious Level (dBm)	Deviation (dBc)	Limits (dBc)	Result
2 412 MHz	-7.78	-61.37	-53.59	-20.00	Complies
2 437 MHz	-7.51	-61.47	-53.96		Complies
2 462 MHz	-6.93	-61.08	-54.15		Complies





**Conducted Out of Band(Band Edge) Emission
 IEEE 802.11b**

Operating Frequency	100 kHz PSD (dBm)	Bandedge Level (dBm)	Deviation (dBc)	Limits (dBc)	Result
2 412 MHz	-5.59	-60.53	-54.94	-20.00	Complies
2 462 MHz	-5.21	-64.22	-59.01		Complies

IEEE 802.11g

Operating Frequency	100 kHz PSD (dBm)	Bandedge Level (dBm)	Deviation (dBc)	Limits (dBc)	Result
2 412 MHz	-8.04	-49.86	-41.82	-20.00	Complies
2 462 MHz	-6.88	-54.47	-47.59		Complies

IEEE 802.11n

Operating Frequency	100 kHz PSD (dBm)	Bandedge Level (dBm)	Deviation (dBc)	Limits (dBc)	Result
2 412 MHz	-7.78	-48.92	-41.14	-20.00	Complies
2 462 MHz	-6.93	-52.44	-45.51		Complies

Conducted spurious Emission Plot on Configuration : IEEE 802.11b 1ch

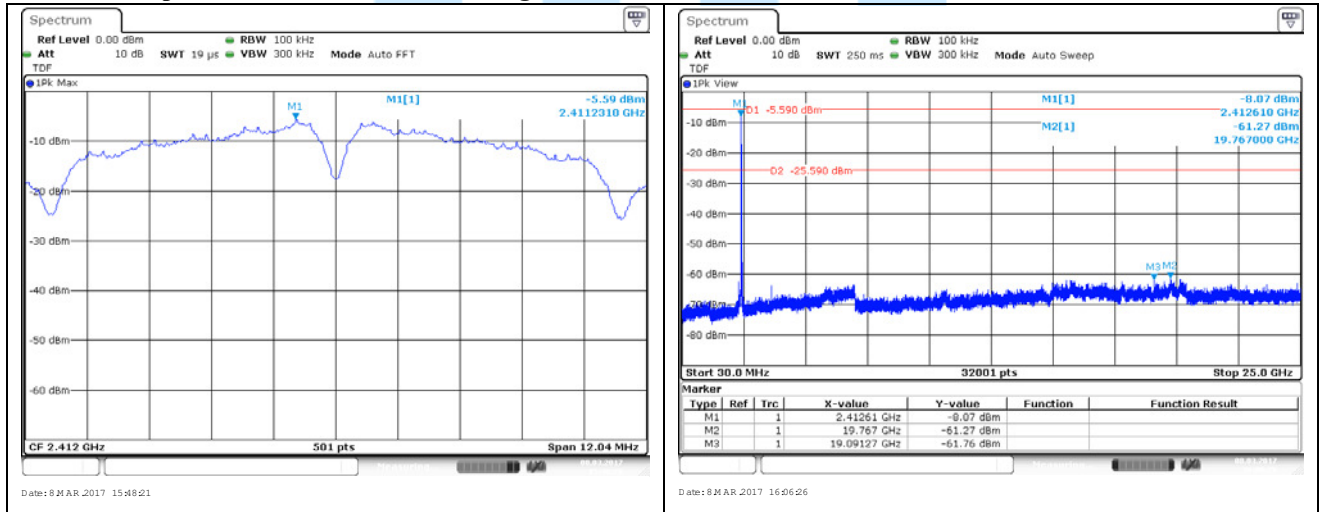



Conducted spurious Emission Plot on Configuration : IEEE 802.11b 6ch

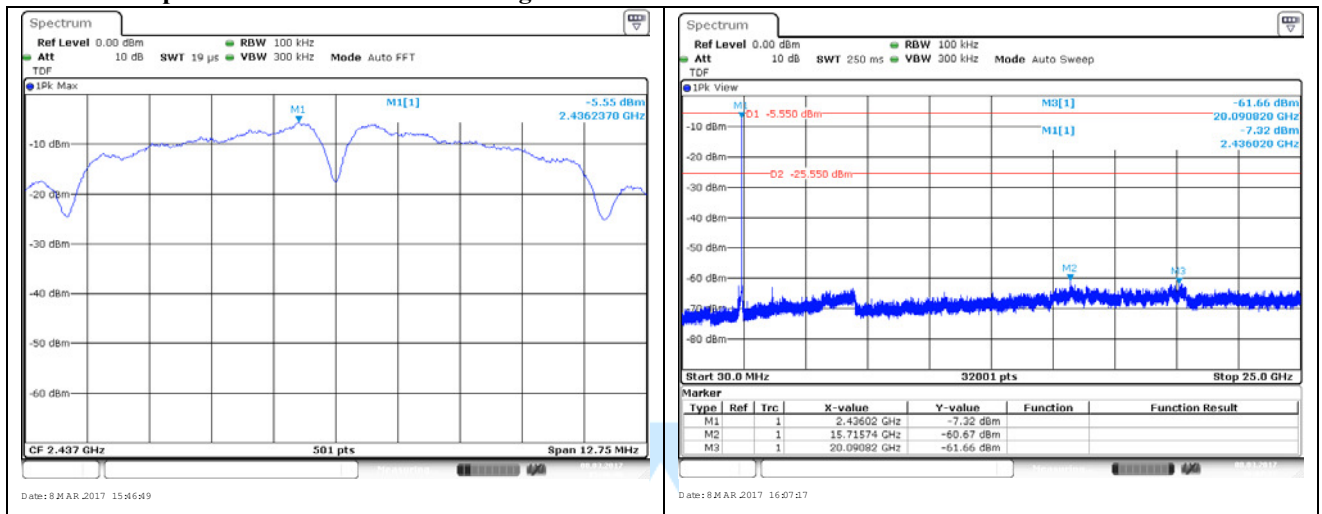

Conducted spurious Emission Plot on Configuration : IEEE 802.11b 11ch

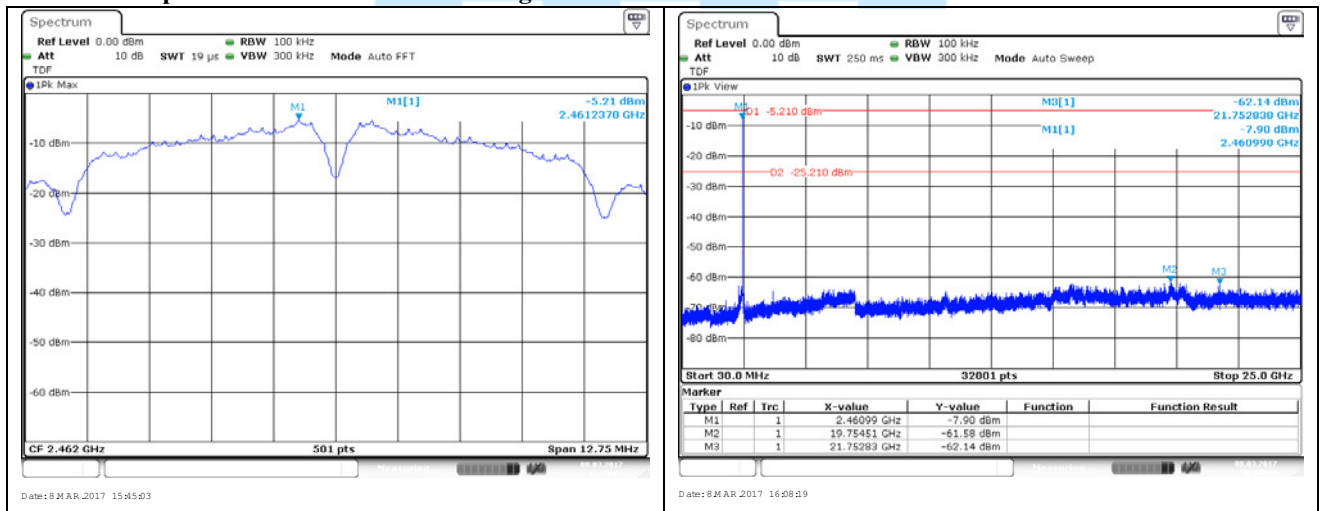



Conducted spurious Emission Plot on Configuration : IEEE 802.11g 1ch

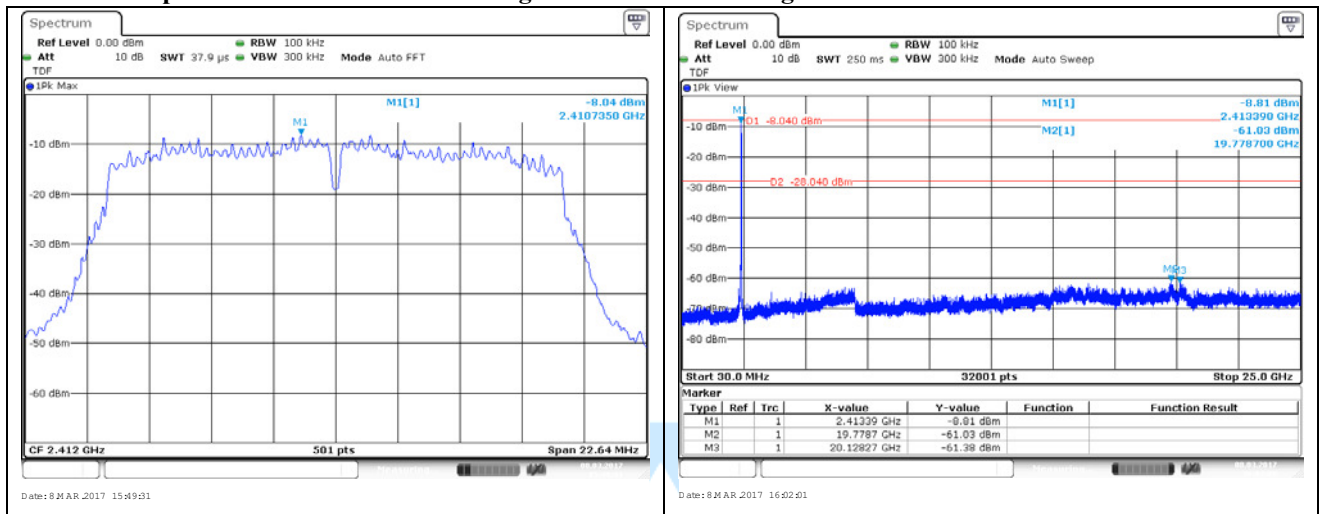

Conducted spurious Emission Plot on Configuration : IEEE 802.11g 6ch

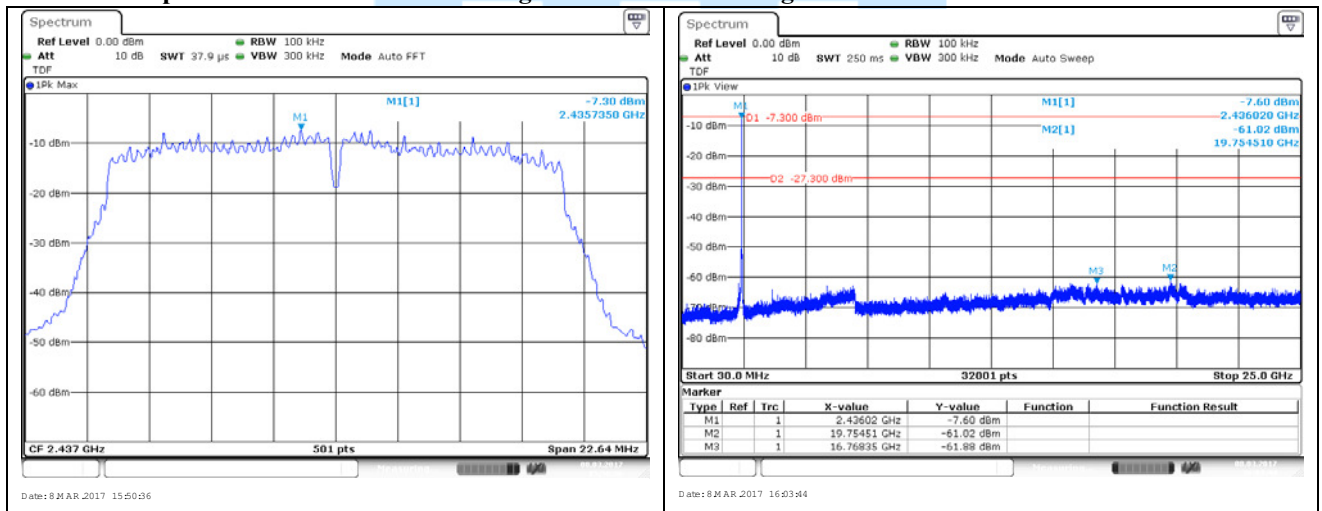



Conducted spurious Emission Plot on Configuration : IEEE 802.11g 11ch

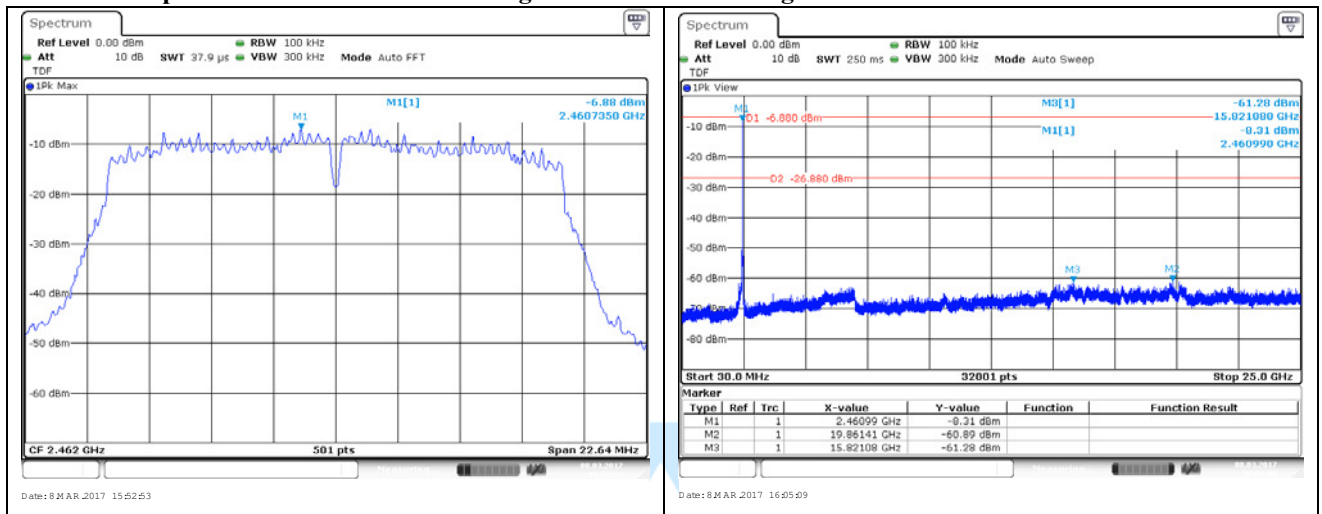

Conducted spurious Emission Plot on Configuration : IEEE 802.11n 1ch

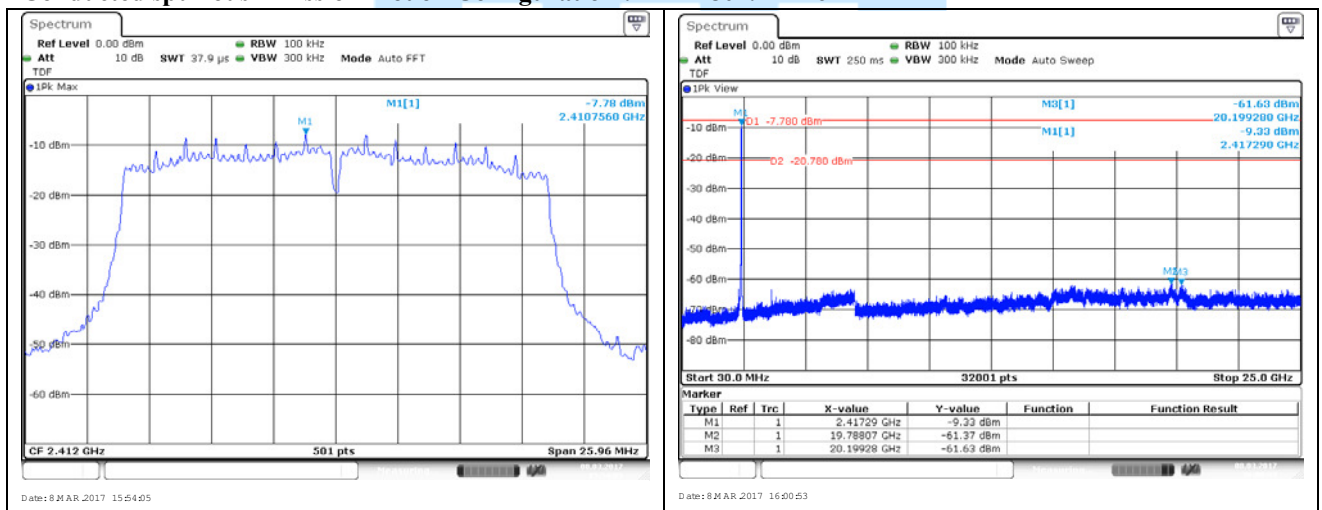



Conducted spurious Emission Plot on Configuration : IEEE 802.11b 6ch

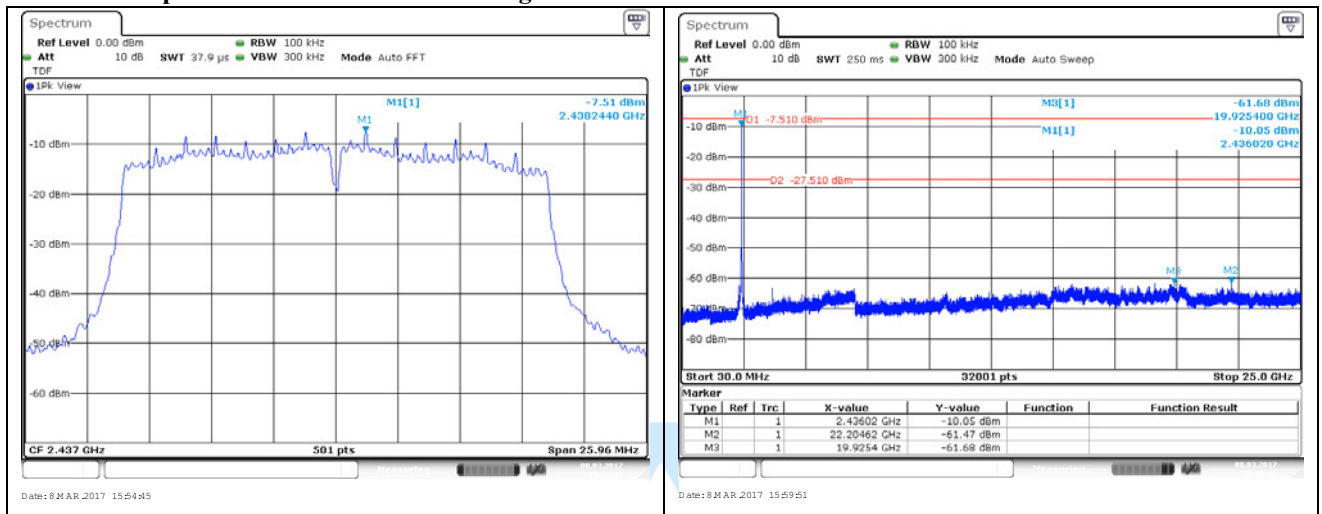

Conducted spurious Emission Plot on Configuration : IEEE 802.11b 11ch

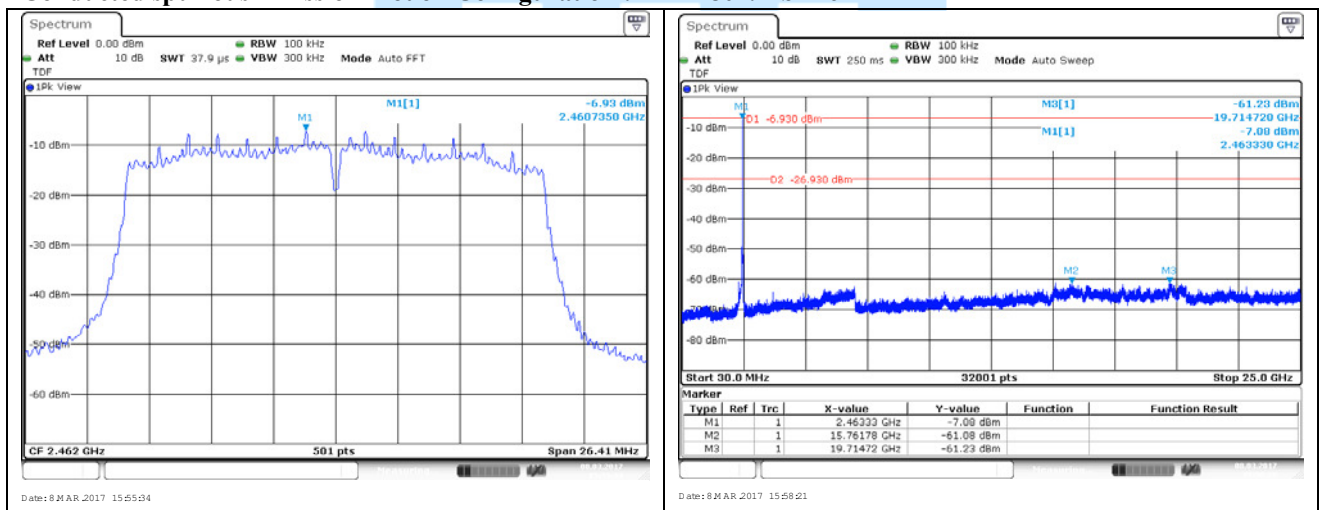



Low Band Edge Plot on Configuration : IEEE 802.11b 1ch

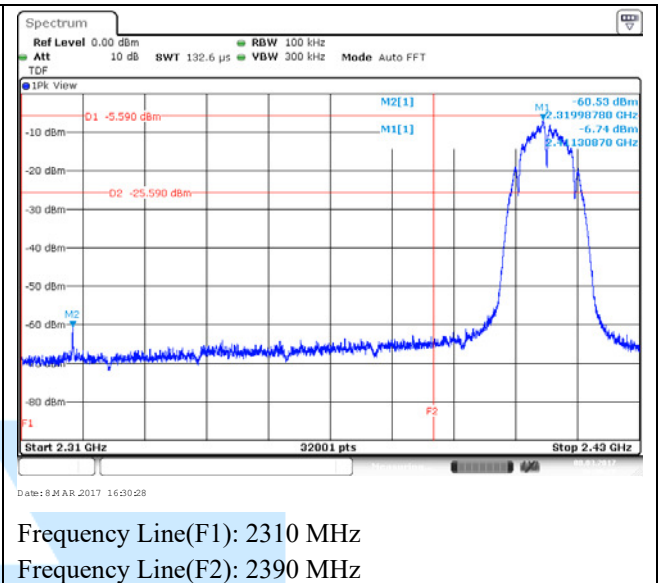
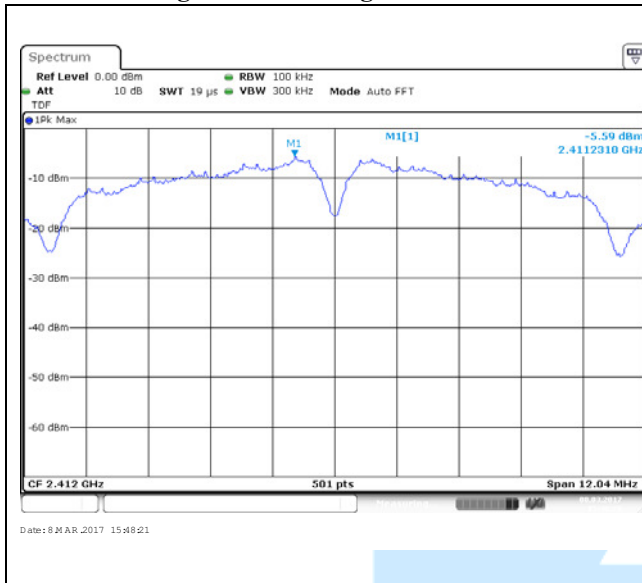

High Band Edge Plot on Configuration : IEEE 802.11b 11ch

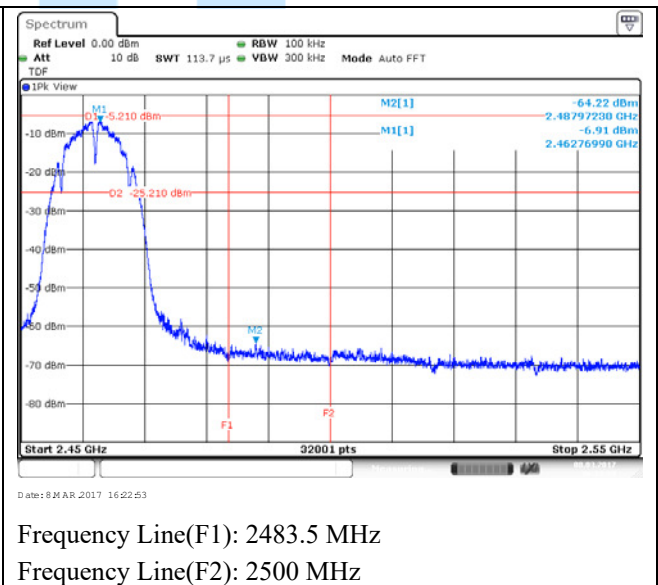
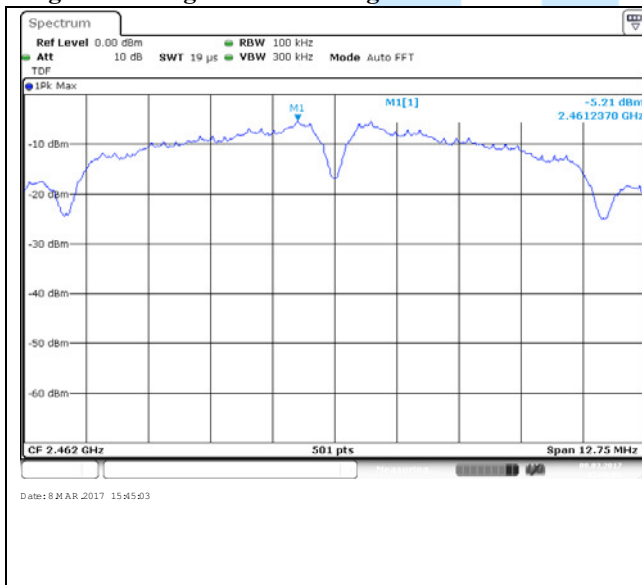



Low Band Edge Plot on Configuration : IEEE 802.11g 1ch

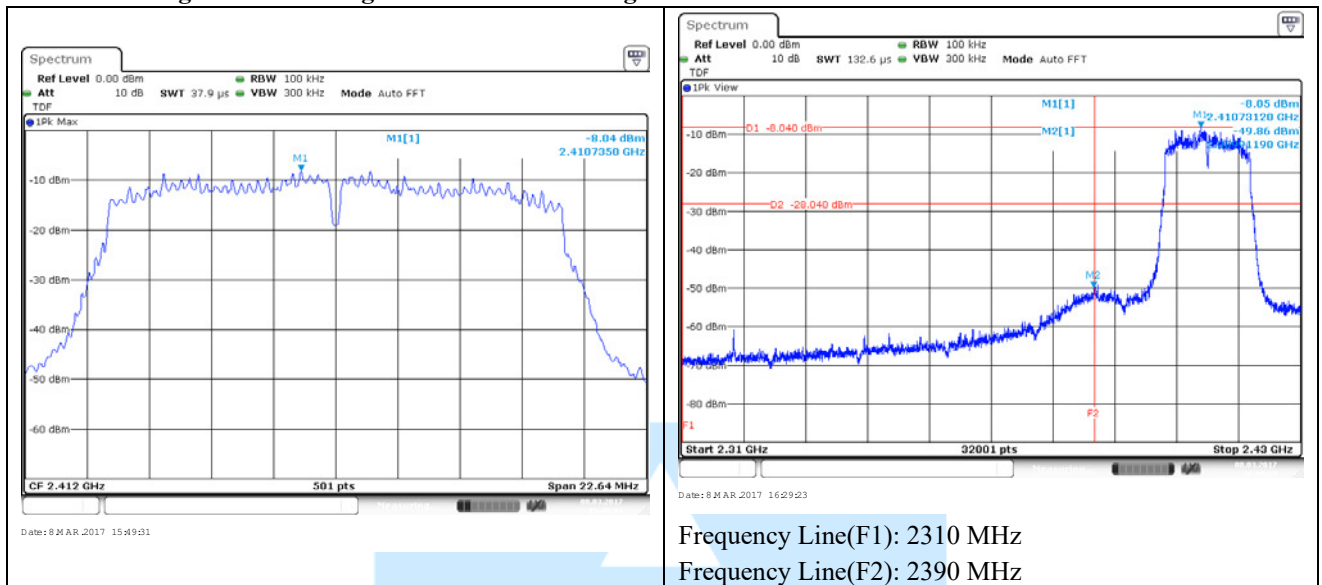

High Band Edge Plot on Configuration : IEEE 802.11g 11ch

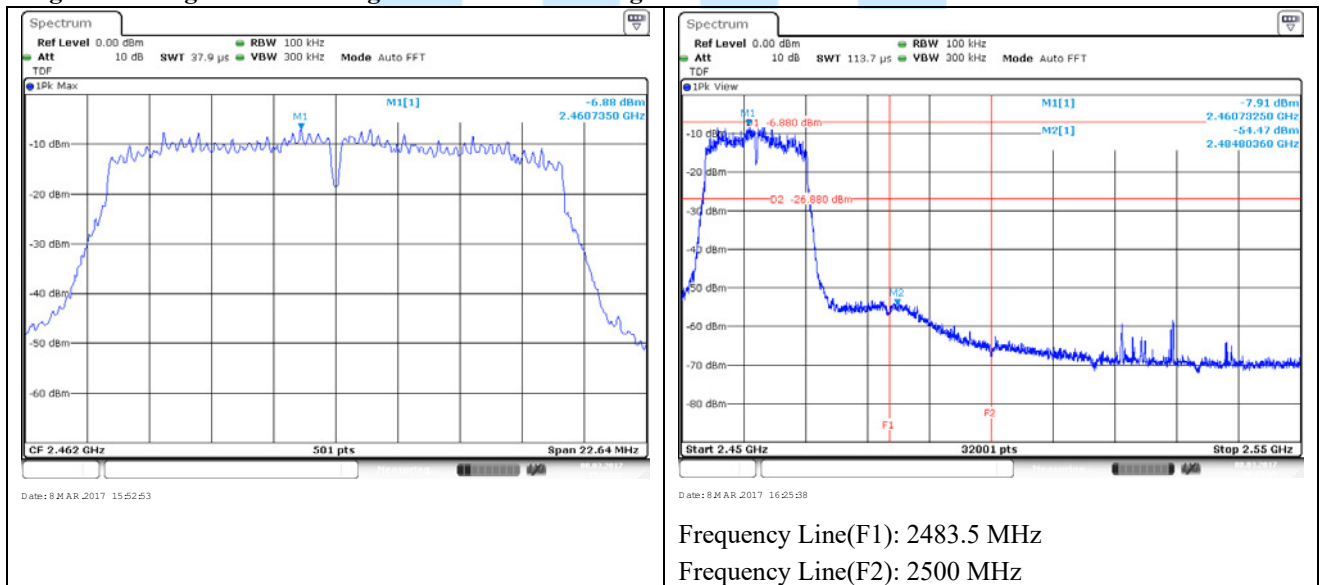



Low Band Edge Plot on Configuration : IEEE 802.11n 1ch

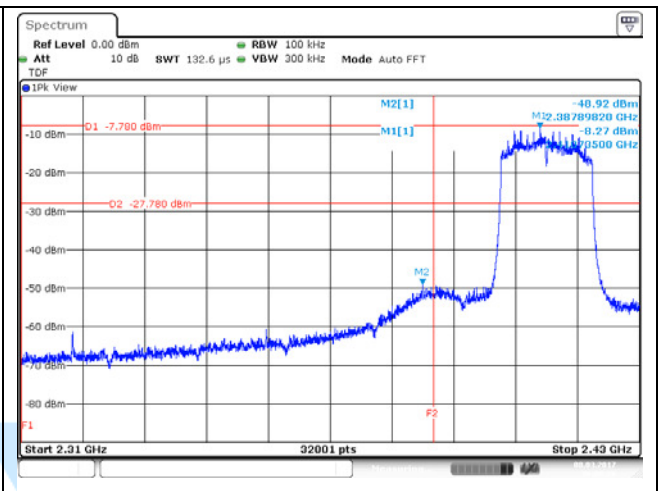
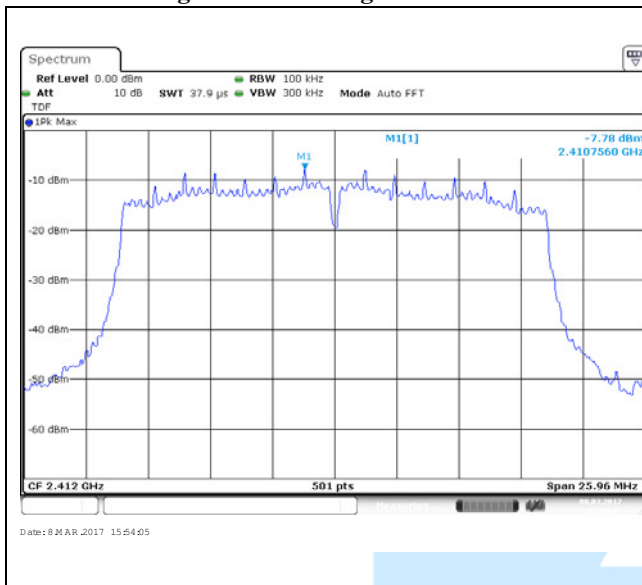

Frequency Line(F1): 2310 MHz
 Frequency Line(F2): 2390 MHz

High Band Edge Plot on Configuration : IEEE 802.11n 11ch

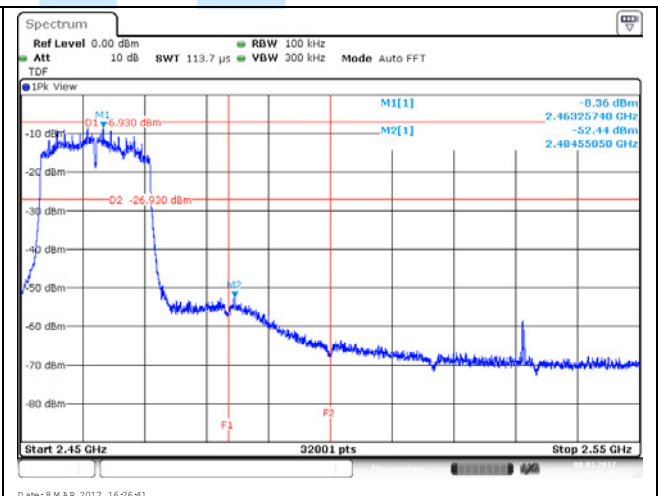
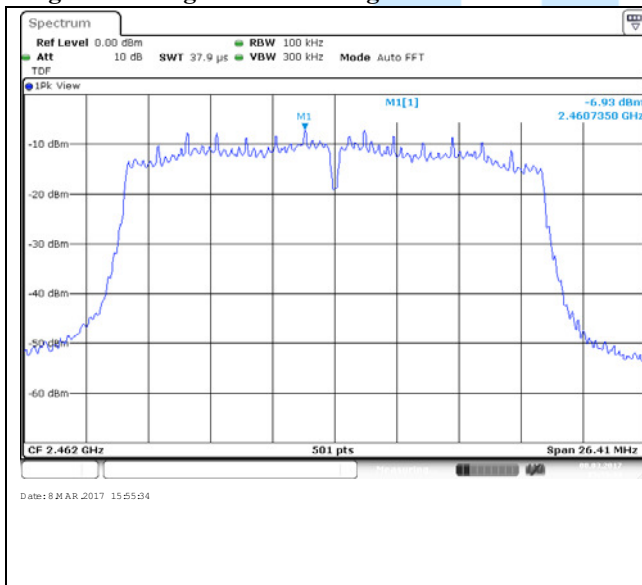

Frequency Line(F1): 2483.5 MHz
 Frequency Line(F2): 2500 MHz





12. AC Power line Conducted emission

-Test Description

The Line conducted emission test facility is inside a 4 m × 8 m × 2.5 m shielded enclosure. (Test firm Registration Number: 269701)

The EUT was placed on a non-conducting 1.0 m by 1.5 m table, which is 0.8 m in height and 0.4 m away from the vertical wall of the shielded enclosure.

The EUT is powered from the Rohde & Schwarz LISN (ENV216) and the support equipment is powered from the Rohde & Schwarz LISN (ENV216). Powers to the LISN are filtered by high-current high insertion loss power line filter.

Sufficient time for EUT, support equipment, and test equipment was allowed in order for them to warm up to their normal operating condition.

The RF output of the LISN was connected to the EMI test receiver (Rohde & Schwarz, ESCI).

Exploratory measurements were conducted to identify the highest emission by operating the EUT in a range of typical modes of operation, cable positions, system configuration and arrangement.

Based on exploratory measurements, the final measurements were conducted at the worst test conditions.

Exploratory measurements were scanned using Peak mode of EMI Test receiver from 150 kHz to 30 MHz with 20 ms sweep time. The final measurements were measured with Quasi-Peak and Average mode.

The bandwidth of EMI Test Receiver was set to 9 kHz. Interface cables were connected to the available interface ports of the test unit. Excess cable lengths were bundled at center with 30 cm ~ 40 cm.

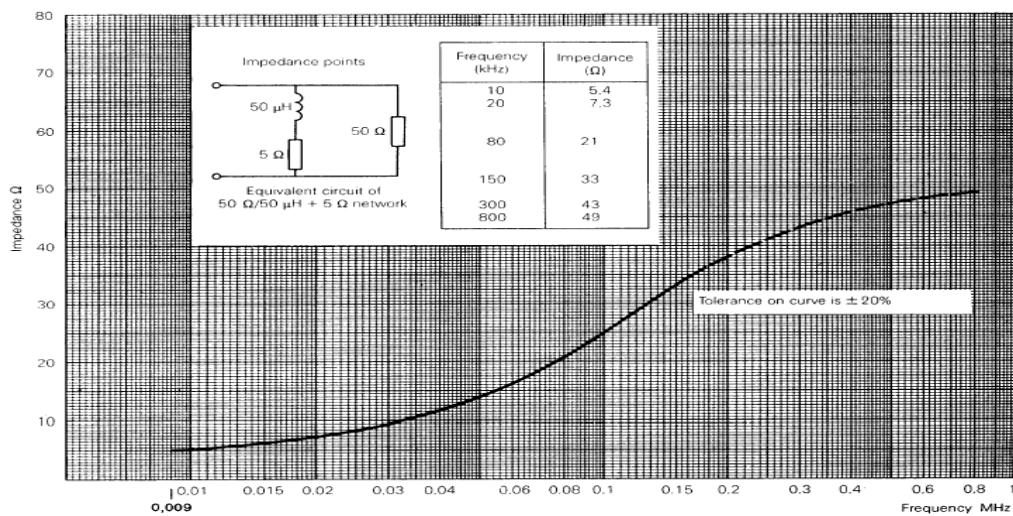

Fig 2. Impedance of LISN





12.1 Operating Environment

Temperature : 21.4 °C
 Relative Humidity : 40.6 % R.H.

12.2 Test Set-up

The conducted emission measurements were performed in the shielded room.

The EUT was placed on wooden table, 0.8 m heights above the floor, 0.4 m from the reference ground plane (GRP) wall and 0.8 m from AMN & ISN.

AMN is bonded on horizontal reference ground plane.

The ground plane, which was electrically bonded to the shield room, ground system and all power lines entering the shield room, were filtered.

12.3 Measurement Uncertainty

The measurement uncertainty was calculated in accordance with ISO “Guide to the expression of uncertainty in measurement.”

The measurement uncertainty was given with a confidence of 95 %.

Test Items	Uncertainty	Remark
Conducted emission (9 kHz ~ 150 kHz)	3.85 dB	Confidence level of approximately 95 % ($k = 2$)
Conducted emission (150 kHz ~ 30 MHz)	3.32 dB	Confidence level of approximately 95 % ($k = 2$)

Where relevant, the following measurement uncertainty levels have been estimated for tests performed on the EUT as specified in CISPR 16-4-2.

The listed uncertainties are the worst case uncertainty for the entire range of measurement. please note that the uncertainty values are provided for informational purposes only are not used in determining the PASS/FAIL results





12.4 Limit

RFI Conducted	FCC Limit(dBμV/m) Class B	
Freq. Range	Quasi-Peak	Average
150 kHz ~ 0.5 MHz	66 ~ 56*	56 ~ 46*
0.5 MHz ~ 5 MHz	56	46
5 MHz ~ 30 MHz	60	50

*Limits decreases linearly with the logarithm of frequency.

12.5 Test Equipment used

Model Name	Manufacturer	Description	Serial Number	Due to Calibration
■- ESCI	Rohde & Schwarz	EMI test receiver	100237	Apr 18. 2017
■- ENV216	Rohde & Schwarz	LISN	100172	Apr 19. 2017
□- ENV216	Rohde & Schwarz	LISN	100173	Apr 19. 2017
□ - ISN T8	TESEQ. GmbH	ISN	24568	Apr 22. 2017
■- EMC 32	Rohde & Schwarz	Testing Software	VER8.53	N/A

12.6 Test data for Conducted Emission

- Test Date : March 08, 2017
- Reference Standard : Part 15 Subpart C, Sec. 15.207
- Test Procedure(s) : ANSI C63.10 (2013)
- Operating Condition : RF transmitting mode
- Power Source : AC 120 V / 60 Hz
- Frequency rage : 0.15 MHz ~ 30 MHz
- Line : AC Power line(Live with Neutral)
- Comment : N/A





12.7 Test Result

Test Condition : IEEE 802.11b

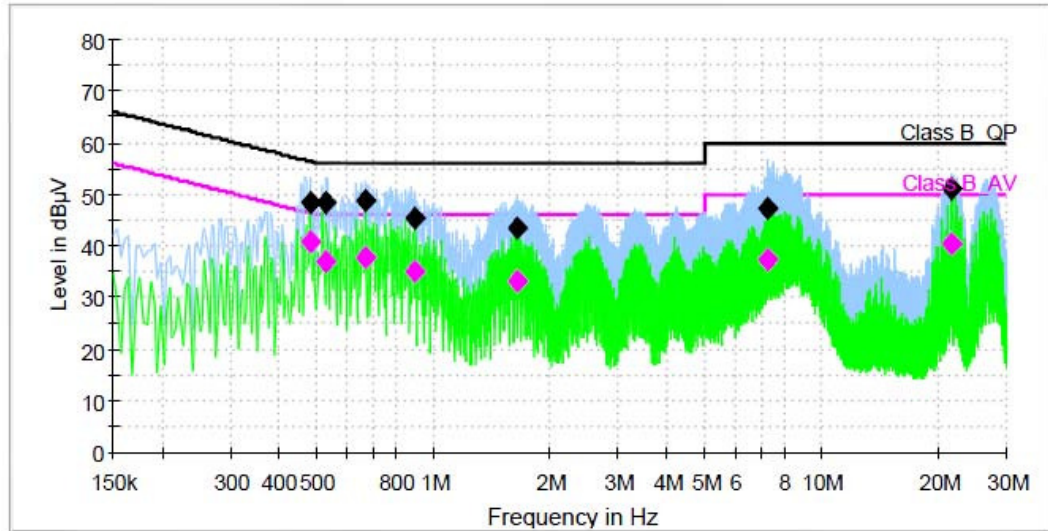

Final Result 1

Frequency (MHz)	QuasiPeak (dBµV)	Meas. Time (ms)	Bandwidth (kHz)	Filter	Line	Corr. (dB)	Margin (dB)	Limit (dBµV)	Comment
0.482081	48.6	200.0	9.000	Off	L1	9.6	7.7	56.3	
0.530588	48.6	200.0	9.000	Off	L1	9.7	7.4	56.0	
0.668644	48.7	200.0	9.000	Off	L1	9.7	7.3	56.0	
0.899981	45.2	200.0	9.000	Off	L1	9.7	10.8	56.0	
1.646231	43.4	200.0	9.000	Off	L1	9.7	12.6	56.0	
7.284150	47.1	200.0	9.000	Off	L1	9.8	12.9	60.0	
21.552450	50.9	200.0	9.000	Off	L1	10.0	9.1	60.0	

Final Result 2

Frequency (MHz)	CAverage (dBµV)	Meas. Time (ms)	Bandwidth (kHz)	Filter	Line	Corr. (dB)	Margin (dB)	Limit (dBµV)	Comment
0.482081	40.9	200.0	9.000	Off	L1	9.6	5.4	46.3	
0.530588	37.0	200.0	9.000	Off	L1	9.7	9.0	46.0	
0.668644	37.9	200.0	9.000	Off	L1	9.7	8.1	46.0	
0.899981	34.9	200.0	9.000	Off	L1	9.7	11.1	46.0	
1.646231	33.2	200.0	9.000	Off	L1	9.7	12.8	46.0	
7.284150	37.2	200.0	9.000	Off	L1	9.8	12.8	50.0	
21.552450	40.6	200.0	9.000	Off	L1	10.0	9.4	50.0	

※ Since only the highest value measured graph and list result are the cumulative measurement results indicated lower N is not expressed.





Test Condition : IEEE 802.11g

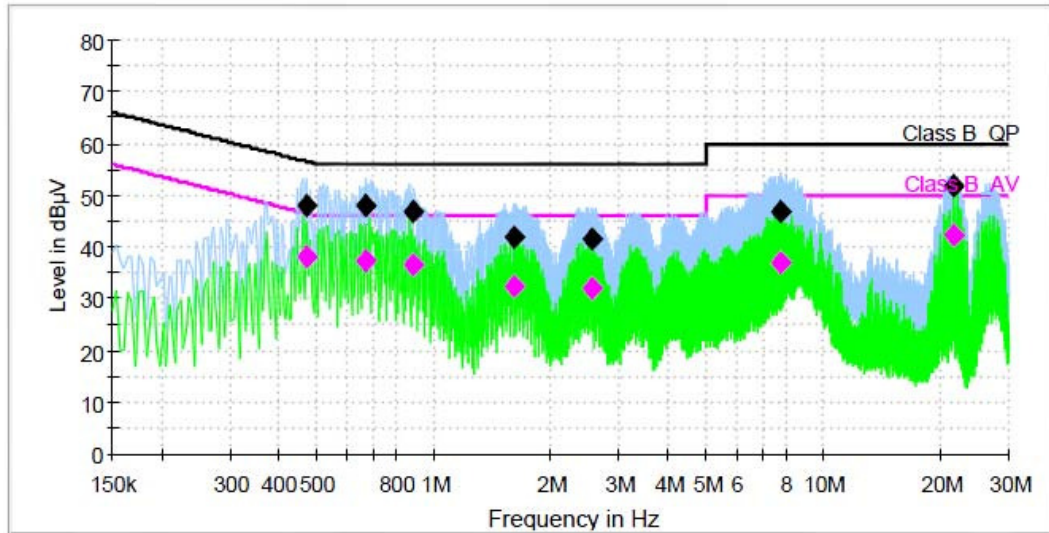

Final Result 1

Frequency (MHz)	QuasiPeak (dBµV)	Meas. Time (ms)	Bandwidth (kHz)	Filter	Line	Corr. (dB)	Margin (dB)	Limit (dBµV)	Comment
0.470888	48.0	200.0	9.000	Off	L1	9.6	8.5	56.5	
0.672375	48.2	200.0	9.000	Off	L1	9.7	7.8	56.0	
0.888788	46.7	200.0	9.000	Off	L1	9.7	9.3	56.0	
1.601456	42.0	200.0	9.000	Off	L1	9.7	14.0	56.0	
2.549194	41.7	200.0	9.000	Off	L1	9.7	14.3	56.0	
7.784138	46.7	200.0	9.000	Off	L1	9.8	13.3	60.0	
21.653194	51.7	200.0	9.000	Off	L1	10.0	8.3	60.0	

Final Result 2

Frequency (MHz)	CAverage (dBµV)	Meas. Time (ms)	Bandwidth (kHz)	Filter	Line	Corr. (dB)	Margin (dB)	Limit (dBµV)	Comment
0.470888	38.0	200.0	9.000	Off	L1	9.6	8.5	46.5	
0.672375	37.4	200.0	9.000	Off	L1	9.7	8.6	46.0	
0.888788	36.5	200.0	9.000	Off	L1	9.7	9.5	46.0	
1.601456	32.2	200.0	9.000	Off	L1	9.7	13.8	46.0	
2.549194	31.8	200.0	9.000	Off	L1	9.7	14.2	46.0	
7.784138	37.1	200.0	9.000	Off	L1	9.8	12.9	50.0	
21.653194	42.2	200.0	9.000	Off	L1	10.0	7.8	50.0	

※ Since only the highest value measured graph and list result are the cumulative measurement results indicated lower N is not expressed.





Test Condition : IEEE 802.11n

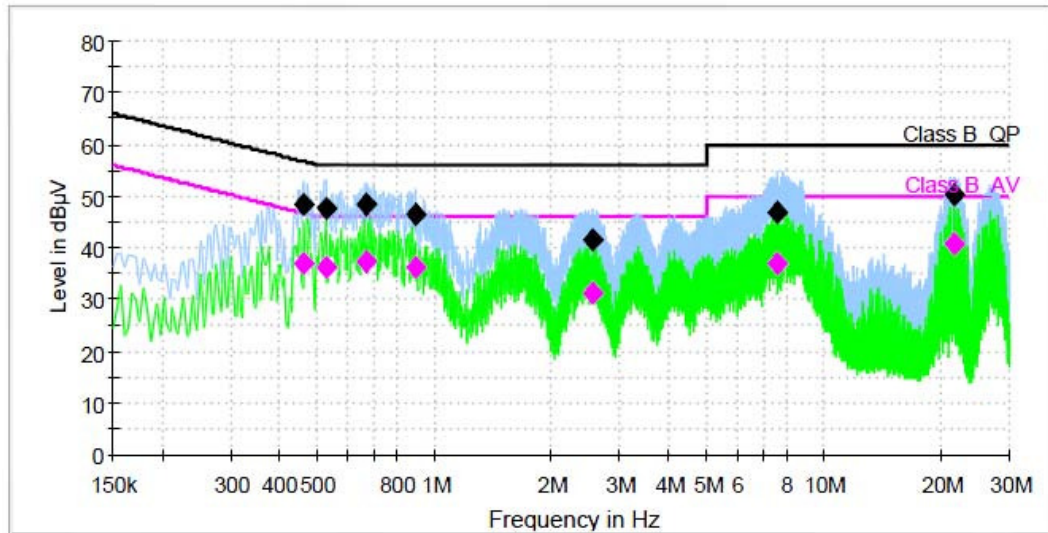

Final Result 1

Frequency (MHz)	QuasiPeak (dBµV)	Meas. Time (ms)	Bandwidth (kHz)	Filter	Line	Corr. (dB)	Margin (dB)	Limit (dBµV)	Comment
0.463425	48.6	200.0	9.000	Off	L1	9.6	8.1	56.6	
0.526856	47.6	200.0	9.000	Off	L1	9.6	8.4	56.0	
0.672375	48.3	200.0	9.000	Off	L1	9.7	7.7	56.0	
0.892519	46.5	200.0	9.000	Off	L1	9.7	9.5	56.0	
2.552925	41.5	200.0	9.000	Off	L1	9.7	14.5	56.0	
7.563994	46.7	200.0	9.000	Off	L1	9.8	13.3	60.0	
21.556181	50.1	200.0	9.000	Off	L1	10.0	9.9	60.0	

Final Result 2

Frequency (MHz)	CAverage (dBµV)	Meas. Time (ms)	Bandwidth (kHz)	Filter	Line	Corr. (dB)	Margin (dB)	Limit (dBµV)	Comment
0.463425	37.0	200.0	9.000	Off	L1	9.6	9.6	46.6	
0.526856	36.4	200.0	9.000	Off	L1	9.6	9.6	46.0	
0.672375	37.5	200.0	9.000	Off	L1	9.7	8.5	46.0	
0.892519	36.0	200.0	9.000	Off	L1	9.7	10.0	46.0	
2.552925	31.4	200.0	9.000	Off	L1	9.7	14.6	46.0	
7.563994	37.1	200.0	9.000	Off	L1	9.8	13.0	50.0	
21.556181	40.6	200.0	9.000	Off	L1	10.0	9.4	50.0	

※ Since only the highest value measured graph and list result are the cumulative measurement results indicated lower N is not expressed.





13. Radiated Spurious & Restricted Band Edge Emission

Exploratory Radiated measurements were conducted at the 3m semi anechoic chamber in order to identify the highest emission by operating the EUT in a range of typical modes of operation, cable positions, system configuration and arrangement.

Based on exploratory measurements, the final measurements were conducted at the worst test conditions.

Final measurements of below 1GHz were made at 3m or 10 m Chamber that complies with CISPR 16/ANSI C63.10. Above 1GHz final measurements were conducted at the 3m Chamber only.

For measurements above 1GHz, the bottom side of 3m chamber was installed with absorbers in order to meet SVSWR Limit.

Exploratory measurements were scanned using Peak mode of EMI Test receiver and final measurements were measured with Quasi-Peak mode (Below 1GHz) and Peak & Average mode (Above 1GHz).

The measurements were performed by rotating the EUT 360° and adjusting the receive antenna height from 1.0 m to 4.0 m. All frequencies were investigated in both horizontal and vertical antenna polarity.

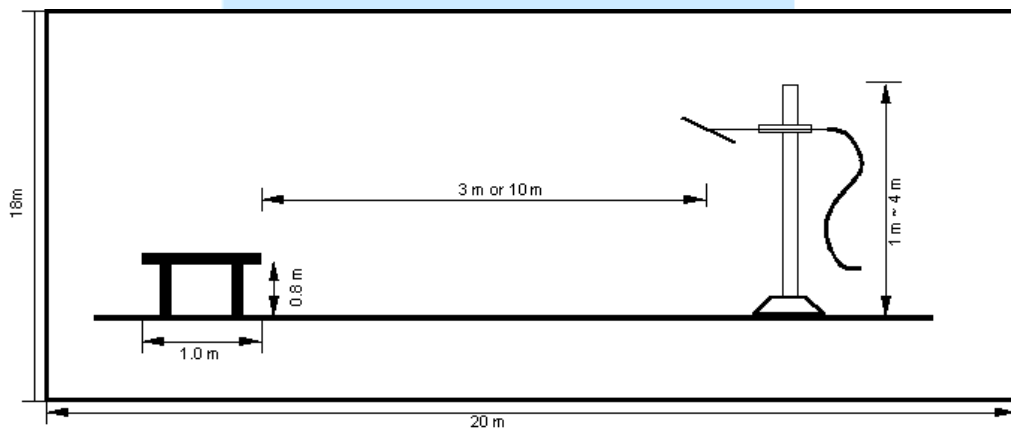

Fig 3. Dimensions of test site (Below 1GHz)

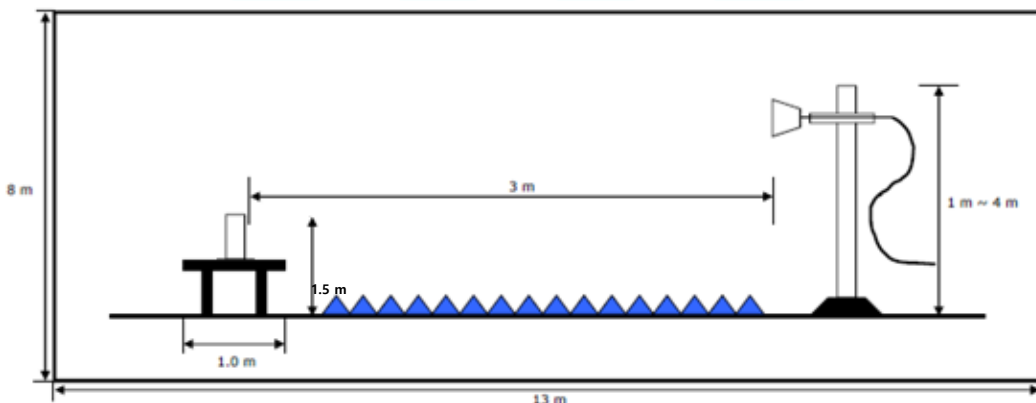

Fig 4. Dimensions of test site (Above 1GHz)





13.1 Operating environment

Temperature : 26.7 °C
 Relative humidity : 32.8 % R.H.

13.2 Test set-up

A preliminary and final measurement was at 3 m anechoic chamber.

The EUT was placed on a non-conducting table.

For emissions testing at or below 1 GHz, the table height is 80 cm above the reference ground plane.

For emission measurements above 1 GHz, the table height is 1.5 m above the reference ground plane.

The turntable with EUT was rotated 360°, and the antenna was varied in height between 1.0 m and 4.0 m in order to determine the maximum emission levels.

This procedure was performed for both horizontal and vertical polarization of the receiving antenna.

13.3 Measurement uncertainty

The measurement uncertainty was calculated in accordance with ISO “Guide to the expression of uncertainty in measurement”.

The measurement uncertainty was given with a confidence of 95 %.

Test items(Anechoic Chamber)	Uncertainty	Remark
Radiated emission (30 MHz ~ 300 MHz, 3 m, Vertical)	4.78 dB	Confidence level of approximately 95 % ($k = 2$)
Radiated emission (30 MHz ~ 300 MHz, 3 m, Horizontal)	4.77 dB	Confidence level of approximately 95 % ($k = 2$)
Radiated emission (300 MHz ~ 1 000 MHz, 3 m, Vertical)	5.06 dB	Confidence level of approximately 95 % ($k = 2$)
Radiated emission (300 MHz ~ 1 000 MHz, 3 m, Horizontal)	5.03 dB	Confidence level of approximately 95 % ($k = 2$)
Radiated emission (1 000 MHz ~ 6 000 MHz, 3 m, V/H)	5.42 dB	Confidence level of approximately 95 % ($k = 2$)
Radiated emission (6 000 MHz ~ 18 000 MHz, 3 m, V/H)	5.64 dB	Confidence level of approximately 95 % ($k = 2$)

Where relevant, the following measurement uncertainty levels have been estimated for tests performed on the EUT as specified in CISPR 16-4-2.

The listed uncertainties are the worst case uncertainty for the entire range of measurement. please note that the uncertainty values are provided for informational purposes only are not used in determining the PASS/FAIL results





13.4 Limit

20 dB in any 100 kHz bandwidth outside the operating frequency band. In case the emission fall within the restricted band specified on 15.205(a) limit in the table below has to be followed.

Frequencies (MHz)	Field Strength (microvolt/meter)	Measurement Distance (meters)
0.009 ~ 0.490	2 400/F (kHz)	300
0.490 ~ 1.705	2 400/F (kHz)	30
1.705 ~ 30.0	30	30
30 ~ 88	100	3
88 ~ 216	150	3
216 ~ 960	200	3
Above 960	500	3

13.5 Test Equipment used

Model Name	Manufacturer	Description	Serial Number	Due to Calibration
■ - ESU40	Rohde & Schwarz	EMI Test Receiver	100266	Jul. 20, 2017
■ - HFH2-Z2	Rohde & Schwarz	Loop Antenna	100041	Dec. 21, 2017
■ - VULB9160	Schwarzbeck	Broadband Test Antenna	3099	Aug. 03. 2017
■ - BBHA9120D	Schwarzbeck	Horn Antenna	207	Oct. 14. 2017
■ - 3160-09	Schwarzbeck	Horn Antenna	LM3981	Oct. 27. 2017
■ - MCU066	maturo GmbH	Position Controller	1390306	N/A
■ - TT2.5SI	maturo GmbH	Turntable	1390307	N/A
■ - AM 4.0	maturo GmbH	Antenna Mast	1390308	N/A
■ - AFS 44 00101800-25-10P-44	MITEQ	Preamplifier	1258943	Dec. 06. 2017
■ - SCU-F1826-G47-BZ42-CSS	BONN Elektronik	Preamplifier	10003	Dec. 09. 2017
■ - WHKX3.0/18G-10SS	WAINWRIGHT INSTRUMENTS	High pass filter	SN31	Apr. 19, 2017
■- EMC 32	Rohde & Schwarz	Testing Software	VER9.15	N/A





13.6 Test data for Radiated Spurious Emission

- Test Date : February. 22 ~ March. 10, 2017
- Reference Standard : Part 15 Subpart C, Sec. 15.247(d)
- Measuring Distance : 3 m
- Resolution Bandwidth : 200 Hz, 9 kHz(Below 30 MHz) / 120 kHz(30 MHz ~ 1GHz) / 1 MHz(Above 1GHz)
- Detector mode : Quasi Peak detector mode / Peak detector mode / Average detector mode
- Power Source : DC 3.7 V
- Note :

Radiated Spurious Emission (9 kHz to 30 MHz)

※ The emission level was not found.

Radiated Spurious Emission (30 MHz to 1 000 MHz)

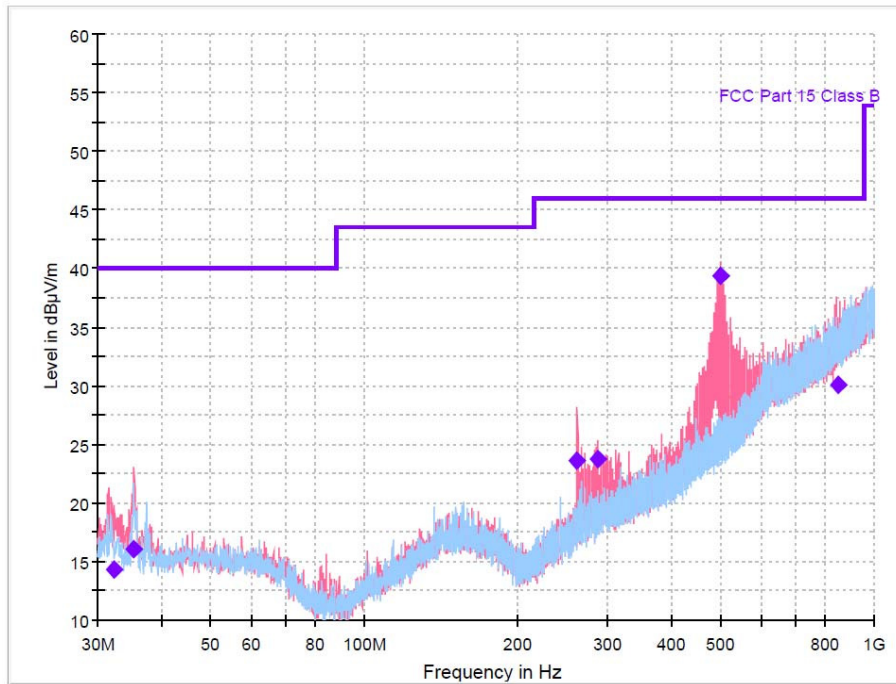

Final Result

Frequency (MHz)	QuasiPeak (dBµV/m)	Limit (dBµV/m)	Margin (dB)	Meas. Time (ms)	Bandwidth (kHz)	Height (cm)	Pol	Azimuth (deg)	Corr. (dB)
32.314375	14.38	40.00	25.62	1000.0	120.000	185.0	V	180.0	12.6
35.375000	16.05	40.00	23.95	1000.0	120.000	400.0	V	121.0	12.6
261.830000	23.61	46.00	22.39	1000.0	120.000	225.0	V	208.0	15.6
288.020000	23.72	46.00	22.28	1000.0	120.000	175.0	V	45.0	16.7
499.500625	39.34	46.00	6.66	1000.0	120.000	107.0	V	165.0	22.8
847.221250	30.10	46.00	15.90	1000.0	120.000	375.0	V	11.0	30.5





Radiated Spurious Emission (1 GHz to 25 GHz): IEEE 802.11b 1ch

Frequency (MHz)	Measurement Level					Limit (dBμV/m)	Margin (dB)	Positioning System						
	Reading Value (dBμV/m)		AF	AMP / CL	Duty Cycle collection			Test Result (dBμV/m)		Pol.	Height	Angle		
	Peak	Average	(dB/m)	(dB)	(dB)	Peak	Average	Peak	Average	(H/V)	(cm)	(°)		
1936.41	47.11	34.61	25.57	-37.33	-	35.35	22.85	74.00	54.00	38.65	31.15	V	125	320
2265.84	47.04	34.01	26.51	-37.11	-	36.44	23.41	74.00	54.00	37.56	30.59	V	125	224
2672.21	47.29	34.80	27.53	-36.87	-	37.95	25.46	74.00	54.00	36.05	28.54	H	175	173
2737.29	46.72	34.51	27.63	-36.71	-	37.64	25.43	74.00	54.00	36.36	28.57	V	100	48
14351.40	44.27	31.61	42.76	-34.10	-	52.93	40.27	74.00	54.00	21.07	13.73	H	185	4
17978.30	6.00	30.04	49.22	-34.10	-	57.98	45.16	74.00	54.00	16.02	8.84	H	125	72

Radiated Spurious Emission (1 GHz to 25 GHz): IEEE 802.11b 6ch

Frequency (MHz)	Measurement Level					Limit (dBμV/m)	Margin (dB)	Positioning System						
	Reading Value (dBμV/m)		AF	AMP / CL	Duty Cycle collection			Test Result (dBμV/m)		Pol.	Height	Angle		
	Peak	Average	(dB/m)	(dB)	(dB)	Peak	Average	Peak	Average	Peak	Average	(H/V)	(cm)	(°)
1975.60	47.10	34.96	25.62	-37.33	-	35.39	23.25	74.00	54.00	38.61	30.75	V	156	-10
2281.04	48.52	35.92	26.56	-37.11	-	37.97	25.37	74.00	54.00	36.03	28.63	H	156	27
2301.86	49.11	36.53	26.62	-36.94	-	38.79	26.21	74.00	54.00	35.21	27.79	H	153	15
2667.33	48.19	34.86	27.52	-36.87	-	38.84	25.51	74.00	54.00	35.16	28.49	V	114	319
14366.40	44.14	31.51	42.82	-34.10	-	52.86	40.23	74.00	54.00	21.14	13.77	V	175	93
17833.60	42.90	30.09	47.28	-34.10	-	56.08	43.27	74.00	54.00	17.92	10.73	H	107	124

Radiated Spurious Emission (1 GHz to 25 GHz): IEEE 802.11b 11ch

Frequency (MHz)	Measurement Level					Limit (dBμV/m)	Margin (dB)	Positioning System						
	Reading Value (dBμV/m)		AF	AMP / CL	Duty Cycle collection			Test Result (dBμV/m)		Pol.	Height	Angle		
	Peak	Average	(dB/m)	(dB)	(dB)	Peak	Average	Peak	Average	Peak	Average	(H/V)	(cm)	(°)
1997.47	47.59	35.05	25.64	-37.33	-	35.90	23.36	74.00	54.00	38.10	30.64	H	171	206
2301.89	54.55	40.96	26.62	-36.94	-	44.23	30.64	74.00	54.00	29.77	23.36	H	154	354
2663.48	48.05	34.78	27.52	-36.87	-	38.70	25.43	74.00	54.00	35.30	28.57	V	146	262
2714.57	46.89	34.59	27.60	-36.71	-	37.78	25.48	74.00	54.00	36.22	28.52	H	100	236
14833.72	50.50	37.42	42.85	-34.10	-	59.25	46.17	74.00	54.00	14.75	7.83	V	111	-21
17980.54	49.86	37.26	49.25	-34.10	-	65.01	52.41	74.00	54.00	8.99	1.59	V	157	187

Note:

If the maximized peak measured value complies with the average limit, then it is unnecessary to perform an average measurement.

Test result = Reading: + AF+AMP / CL

Where, AF : Antenna Collection Factor,

AMP / CL = Cable loss + Preamplifier gain + High Pass filter.

※ High Pass filter use to range of 3 GHz to 18 GHz

Pol.: H(Horizontal), V(Vertical)





Radiated Spurious Emission (1 GHz to 25 GHz): IEEE 802.11g 1ch

Frequency (MHz)	Measurement Level							Limit (dBµV/m)		Margin (dB)		Positioning System		
	Reading Value (dBµV/m)		AF (dB/m)	AMP / CL (dB)	Duty Cycle collection (dB)	Test Result (dBµV/m)						Pol. (H/V)	Height (cm)	Angle (°)
	Peak	Average				Peak	Average	Peak	Average					
1718.21	46.64	34.24	25.30	-37.46	-	34.48	22.08	74.00	54.00	39.52	31.92	V	166	120
1978.83	47.28	34.83	25.62	-37.33	-	35.57	23.12	74.00	54.00	38.43	30.88	V	120	211
2256.90	46.38	34.05	26.48	-37.11	-	35.75	23.42	74.00	54.00	38.25	30.58	V	106	81
2681.42	47.77	34.77	27.54	-36.87	-	38.44	25.44	74.00	54.00	35.56	28.56	V	175	2
14431.10	44.56	31.09	43.09	-34.10	-	53.55	40.08	74.00	54.00	20.45	13.92	H	114	-4
17999.90	6.00	30.18	49.51	-34.10	-	58.35	45.59	74.00	54.00	15.65	8.41	H	197	122

Radiated Spurious Emission (1 GHz to 25 GHz): IEEE 802.11g 6ch

Frequency (MHz)	Measurement Level							Limit (dBµV/m)		Margin (dB)		Positioning System		
	Reading Value (dBµV/m)		AF (dB/m)	AMP / CL (dB)	Duty Cycle collection (dB)	Test Result (dBµV/m)						Pol. (H/V)	Height (cm)	Angle (°)
	Peak	Average				Peak	Average	Peak	Average					
1555.41	46.90	34.25	25.10	-37.53	-	34.47	21.82	74.00	54.00	39.53	32.18	V	125	136
1987.65	47.51	35.05	25.63	-37.33	-	35.81	23.35	74.00	54.00	38.19	30.65	H	156	144
2636.69	48.25	34.83	27.48	-36.87	-	38.86	25.44	74.00	54.00	35.14	28.56	H	113	227
2719.46	47.21	34.64	27.60	-36.71	-	38.10	25.53	74.00	54.00	35.90	28.47	H	157	63
14896.80	44.37	31.85	42.76	-34.10	-	53.03	40.51	74.00	54.00	20.97	13.49	V	197	131
17973.40	42.83	30.21	49.16	-34.10	-	57.89	45.27	74.00	54.00	16.11	8.73	H	225	90

Radiated Spurious Emission (1 GHz to 25 GHz): IEEE 802.11g 11ch

Frequency (MHz)	Measurement Level							Limit (dBµV/m)		Margin (dB)		Positioning System		
	Reading Value (dBµV/m)		AF (dB/m)	AMP / CL (dB)	Duty Cycle collection (dB)	Test Result (dBµV/m)						Pol. (H/V)	Height (cm)	Angle (°)
	Peak	Average				Peak	Average	Peak	Average					
1982.50	47.77	34.92	25.62	-37.33	-	36.06	23.21	74.00	54.00	37.94	30.79	H	112	116
2306.40	50.53	38.24	26.64	-36.94	-	40.23	27.94	74.00	54.00	33.77	26.06	H	125	15
2502.72	47.81	35.12	27.27	-36.97	-	38.11	25.42	74.00	54.00	35.89	28.58	H	175	22
2889.92	47.72	34.10	27.87	-36.65	-	38.94	25.32	74.00	54.00	35.06	28.68	H	121	306
14494.20	50.20	37.20	43.35	-34.10	-	59.45	46.45	74.00	54.00	14.55	7.55	H	115	65
17981.11	50.47	37.27	49.26	-34.10	-	65.63	52.43	74.00	54.00	8.37	1.57	H	144	304

Note:

If the maximized peak measured value complies with the average limit, then it is unnecessary to perform an average measurement.

Test result = Reading: + AF+AMP / CL

Where, AF : Antenna Collection Factor,

AMP / CL = Cable loss + Preamplifier gain + High Pass filter.

※ High Pass filter use to range of 3 GHz to 18 GHz

Pol.: H(Horizontal), V(Vertical)





Radiated Spurious Emission (1 GHz to 25 GHz): IEEE 802.11n 1ch

Frequency (MHz)	Measurement Level						Limit (dBµV/m)		Margin (dB)		Positioning System			
	Reading Value (dBµV/m)		AF (dB/m)	AMP / CL (dB)	Duty Cycle collection (dB)	Test Result (dBµV/m)					Pol. (H/V)	Height (cm)	Angle (°)	
	Peak	Average				Peak	Average							
1567.62	47.03	34.23	25.12	-37.53	-	34.62	21.82	74.00	54.00	39.38	32.18	H	175	141
1954.11	47.47	34.89	25.59	-37.33	-	35.73	23.15	74.00	54.00	38.27	30.85	V	125	341
2267.38	46.53	34.11	26.51	-37.11	-	35.93	23.51	74.00	54.00	38.07	30.49	H	155	-2
2686.28	47.31	34.81	27.55	-36.87	-	37.99	25.49	74.00	54.00	36.01	28.51	H	112	281
14840.70	44.79	31.48	42.84	-34.10	-	53.53	40.22	74.00	54.00	20.47	13.78	H	125	162
17982.00	6.00	30.13	49.27	-34.10	-	58.13	45.30	74.00	54.00	15.87	8.70	H	153	305

Radiated Spurious Emission (1 GHz to 25 GHz): IEEE 802.11n 6ch

Frequency (MHz)	Measurement Level						Limit (dBµV/m)		Margin (dB)		Positioning System			
	Reading Value (dBµV/m)		AF (dB/m)	AMP / CL (dB)	Duty Cycle collection (dB)	Test Result (dBµV/m)					Pol. (H/V)	Height (cm)	Angle (°)	
	Peak	Average				Peak	Average							
1651.52	47.62	34.51	25.22	-37.53	-	35.31	22.20	74.00	54.00	38.69	31.80	H	125	265
1988.29	47.96	35.02	25.63	-37.33	-	36.26	23.32	74.00	54.00	37.74	30.68	H	120	48
2308.20	51.73	38.11	26.64	-36.94	-	41.43	27.81	74.00	54.00	32.57	26.19	H	147	353
2665.50	47.31	34.93	27.52	-36.87	-	37.96	25.58	74.00	54.00	36.04	28.42	H	137	255
14857.90	44.62	31.56	42.82	-34.10	-	53.34	40.28	74.00	54.00	20.66	13.72	H	196	295
17952.40	42.46	30.03	48.88	-34.10	-	57.24	44.81	74.00	54.00	16.76	9.19	V	120	215

Radiated Spurious Emission (1 GHz to 25 GHz): IEEE 802.11n 11ch

Frequency (MHz)	Measurement Level						Limit (dBµV/m)		Margin (dB)		Positioning System			
	Reading Value (dBµV/m)		AF (dB/m)	AMP / CL (dB)	Duty Cycle collection (dB)	Test Result (dBµV/m)					Pol. (H/V)	Height (cm)	Angle (°)	
	Peak	Average				Peak	Average							
2127.65	46.03	33.47	26.06	-37.04	-	35.05	22.49	74.00	54.00	38.95	31.51	H	125	111
2301.39	51.80	38.58	26.62	-36.94	-	41.48	28.26	74.00	54.00	32.52	25.74	H	149	4
2501.72	53.76	36.16	27.27	-36.97	-	44.06	26.46	74.00	54.00	29.94	27.54	H	114	339
2919.46	46.40	34.20	27.91	-36.59	-	37.72	25.52	74.00	54.00	36.28	28.48	V	107	17
14770.20	44.51	31.38	42.95	-34.10	-	53.36	40.23	74.00	54.00	20.64	13.77	V	161	-10
17973.47	42.59	30.06	49.16	-34.10	-	57.65	45.12	74.00	54.00	16.35	8.88	H	210	27

Note:

If the maximized peak measured value complies with the average limit, then it is unnecessary to perform an average measurement.

Test result = Reading: + AF+AMP / CL

Where, AF : Antenna Collection Factor,

AMP / CL = Cable loss + Preamplifier gain + High Pass filter.

※ High Pass filter use to range of 3 GHz to 18 GHz

Pol.: H(Horizontal), V(Vertical)





13.7 Test data for Radiated Restricted Band Edge Emission

- Test Date : February 22 ~ March 09, 2017
- Reference Standard : Part 15 Subpart C, Sec. 15.247(d)
- Measuring Distance : 3 m
- Resolution Bandwidth : 1 MHz
- Detector mode : Peak detector mode / Average detector mode
- Power Source : DC 3.7 V
- Note : Through three orthogonal axes were investigated and the worst case is report

IEEE 802.11b (1ch, 11ch)

Frequency (MHz)	Measurement Level							Limit (dBμV/m)		Margin (dB)		Positioning System		
	Reading Value (dBμV/m)		AF	AMP / CL	Duty Cycle collection	Test Result (dBμV/m)						Pol.	Height	Angle
	Peak	Average	(dB/m)	(dB)	(dB)	Peak	Average	Peak	Average	(H/V)	(cm)	(°)		
2389.99	62.53	40.73	26.91	-36.99	-	52.45	30.65	74.00	54.00	21.55	23.35	V	100	-88

Frequency (MHz)	Measurement Level							Limit (dBμV/m)		Margin (dB)		Positioning System		
	Reading Value (dBμV/m)		AF	AMP / CL	Duty Cycle collection	Test Result (dBμV/m)						Pol.	Height	Angle
	Peak	Average	(dB/m)	(dB)	(dB)	Peak	Average	Peak	Average	(H/V)	(cm)	(°)		
2484.72	50.20	37.31	27.22	-36.95	-	40.47	27.58	74.00	54.00	33.53	26.42	H	140	148

IEEE 802.11g(1ch, 11ch)

Frequency (MHz)	Measurement Level							Limit (dBμV/m)		Margin (dB)		Positioning System		
	Reading Value (dBμV/m)		AF	AMP / CL	Duty Cycle collection	Test Result (dBμV/m)						Pol.	Height	Angle
	Peak	Average	(dB/m)	(dB)	(dB)	Peak	Average	Peak	Average	(H/V)	(cm)	(°)		
2390.00	76.21	57.73	26.91	-36.99	-	66.13	47.65	74.00	54.00	7.87	6.35	H	131	5

Frequency (MHz)	Measurement Level							Limit (dBμV/m)		Margin (dB)		Positioning System		
	Reading Value (dBμV/m)		AF	AMP / CL	Duty Cycle collection	Test Result (dBμV/m)						Pol.	Height	Angle
	Peak	Average	(dB/m)	(dB)	(dB)	Peak	Average	Peak	Average	(H/V)	(cm)	(°)		
2483.51	75.06	56.80	27.21	-36.95	-	65.32	47.06	74.00	54.00	8.68	6.94	H	150	144

IEEE 802.11n(1ch, 11ch)

Frequency (MHz)	Measurement Level							Limit (dBμV/m)		Margin (dB)		Positioning System		
	Reading Value (dBμV/m)		AF	AMP / CL	Duty Cycle collection	Test Result (dBμV/m)						Pol.	Height	Angle
	Peak	Average	(dB/m)	(dB)	(dB)	Peak	Average	Peak	Average	(H/V)	(cm)	(°)		
2390.00	76.88	58.83	26.91	-36.99	-	66.80	48.75	74.00	54.00	7.20	5.25	H	124	3

Frequency (MHz)	Measurement Level							Limit (dBμV/m)		Margin (dB)		Positioning System		
	Reading Value (dBμV/m)		AF	AMP / CL	Duty Cycle collection	Test Result (dBμV/m)						Pol.	Height	Angle
	Peak	Average	(dB/m)	(dB)	(dB)	Peak	Average	Peak	Average	(H/V)	(cm)	(°)		
2483.53	76.45	56.80	27.21	-36.95	-	66.71	47.06	74.00	54.00	7.29	6.94	H	145	-5

Note:

Test result = Reading: + Transducer Factor.

Where, ACF : Antenna Collection Factor,

CL = Cable loss + Pre-amplifier gain + High Pass filter

※ High Pass filter use to range of 3 GHz to 18 GHz

Pol.: H(Horizontal), V(Vertical)





14. Sample Calculations

$$\begin{aligned} \text{dB}\mu\text{V} &= 20 \text{ Log}_{10}(\mu\text{V}/\text{m}) \\ \text{dB}\mu\text{V} &= \text{dBm} + 107 \\ \mu\text{V} &= 10^{(\text{dB}\mu\text{V}/20)} \end{aligned}$$

14.1 Example 1 :

■ 20.3 MHz

Class B Limit = 250 μV = 48 dB μV

Reading = 39.2 dB μV

$10^{(39.2\text{dB}\mu\text{V}/20)}$ = 91.2 μV

Margin = 48 dB μV - 39.2 dB μV
 = 8.8 dB

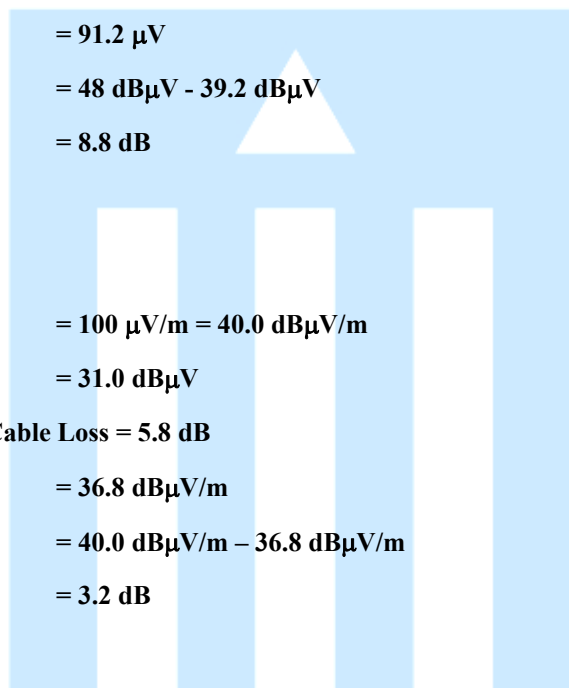

14.2 Example 2 :

■ 66.7 MHz

Class B Limit = 100 $\mu\text{V}/\text{m}$ = 40.0 dB $\mu\text{V}/\text{m}$

Reading = 31.0 dB μV

Antenna Factor + Cable Loss = 5.8 dB

Total = 36.8 dB $\mu\text{V}/\text{m}$

Margin = 40.0 dB $\mu\text{V}/\text{m}$ - 36.8 dB $\mu\text{V}/\text{m}$
 = 3.2 dB





15. Recommendation & Conclusion

The data collected shows that the **Ohsung Electronics Co., Ltd. RF Remote Controller (Model Name: MXHP-R500)** was complies with §15.247 of the FCC Rules.

- The end -

