

## ***FCC EVALUATION REPORT FOR CERTIFICATION***

**Manufacturer: OHSUNG ELECTRONICS CO., LTD.**

**#181 Gongdan-dong, Gumi-si, Gyeongbuk,**

**Republic of Korea.**

**Attn : Mr. Hak-Ki Kim / General Manager**

**Date of Issue: April 1, 2013**

**Order Number: GETEC-C1-13- 111**

**Test Report Number: GETEC-E3-13-027**

**Test Site: GUMI COLLEGE EMC CENTER**

**FCC Registration Number: (100749, 443957)**

**FCC ID. : OZ5URCMX-850**

**Applicant : OHSUNG ELECTRONICS CO., LTD.**

<b>Rule Part(s)</b>	<b>: FCC Part 15 Subpart C-Intentional Radiator § 15.231</b>
<b>Equipment Class</b>	<b>: Remote Control Transmitter (DSC)</b>
<b>EUT Type</b>	<b>: RF REMOTE CONTROLLER</b>
<b>Type of Authority</b>	<b>: Certification</b>
<b>Model Name</b>	<b>: MX-850 , ML-600</b>
<b>Trade Name</b>	<b>: UNIVERSAL Remote Control</b>

**This equipment has been shown to be in compliance with the applicable technical standards as indicated in the measurement report and was tested in accordance with the measurement procedures specified in ANSI C63.4 (2009)**

**I attest to the accuracy of data. All measurements reported herein were performed by me or were made under my supervision and are correct to the vest of my knowledge and belief. I assume full responsibility for the completeness of these measurements and vouch for the qualifications of all persons taking them.**

**Tested by,**

**Reviewed by,**

\_\_\_\_\_  
**Seung-Chul Lee, Senior Engineer**  
**GUMI COLLEGE EMC CENTER**

\_\_\_\_\_  
**Jae-Hoon Jeong, Technical Manager**  
**GUMI COLLEGE EMC CENTER**



## CONTENTS

<b>1. GENERAL INFORMATION</b>	<b>4</b>
<b>2. INTRODUCTION</b>	<b>5</b>
<b>3. PRODUCT INFORMATION</b>	<b>6</b>
3.1 DESCRIPTION OF EUT	6
3.2 SUPPORT EQUIPMENT / CABLES USED	7
3.3 MODIFICATION ITEM(S)	7
<b>4. ANTENNA REQUIREMENT - §15.203</b>	<b>8</b>
4.1 DESCRIPTION OF ANTENNA	8
<b>5. DESCRIPTION OF TESTS</b>	<b>8</b>
5.1 TEST CONDITION	8
5.2 RADIATED EMISSION	9
5.3 DUTY CYCLE CORRECTION	10
5.4 OCCUPIED BANDWIDTH	10
<b>6. DUTY CYCLE CORRECTION</b>	<b>11</b>
6.1 OPERATING ENVIRONMENT	11
6.2 TEST SET-UP	11
6.3 TEST EQUIPMENT USED	11
6.4 TEST RESULT OF DUTY CYCLE	11
<b>7. ACTIVATION TIME</b>	<b>15</b>
7.1 OPERATING ENVIRONMENT	15
7.2 LIMIT	15
7.3 TEST EQUIPMENT USED	15
7.4 TEST RESULT OF ACTIVATION TIME	15
<b>8. RADIATED EMISSION</b>	<b>16</b>
8.1 OPERATING ENVIRONMENT	16
8.2 TEST SET-UP	16
8.3 MEASUREMENT UNCERTAINTY	16
8.4 LIMIT	17
8.5 TEST EQUIPMENT USED	17
8.6 TEST DATA FOR RADIATED EMISSION	18
<b>9. OCCUPIED BANDWIDTH MEASUREMENT</b>	<b>20</b>
9.1 OPERATING ENVIRONMENT	20
9.2 TEST SET-UP	20
9.3 LIMIT	20
9.4 TEST EQUIPMENT USED	20
9.5 TEST RESULT OF OCCUPIED BANDWIDTH	20
<b>10. SAMPLE CALCULATIONS</b>	<b>22</b>
10.1 EXAMPLE 1 :	22
10.2 EXAMPLE 2 :	22
<b>11. RECOMMENDATION &amp; CONCLUSION</b>	<b>23</b>



- APPENDIX A – ATTESTATION STATEMENT**
- APPENDIX B – ID SAMPLE LABEL & LOCATION**
- APPENDIX C – BLOCK DIAGRAM**
- APPENDIX D – SCHEMATIC DIAGRAM**
- APPENDIX E – TEST SET-UP PHOTOGRAPHS**
- APPENDIX F – EXTERNAL PHOTOGRAPHS**
- APPENDIX G – INTERNAL PHOTOGRAPHS**
- APPENDIX H – USER’S MANUAL**
- APPENDIX I – OPERATIONAL DESCRIPTION**

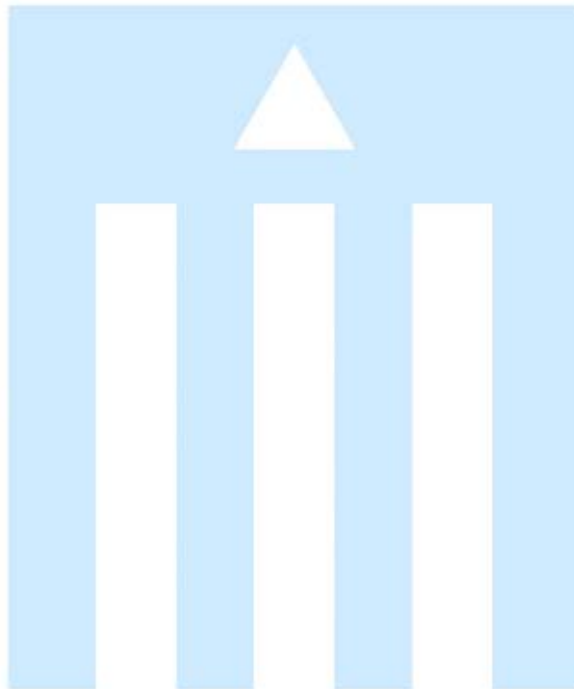



*Scope: Measurement and determination of electromagnetic emissions (EME) of radio frequency devices including intentional and / or unintentional radiators for compliance with technical rules and regulations of the Federal Communications Commission.*

**1. General Information**

**Applicant: OHSUNG ELECTRONICS CO., LTD.**  
**Applicant Address: #181 Gongdan-dong, Gumi-si, Gyeongbuk, Republic of Korea.**  
**Manufacturer: OHSUNG ELECTRONICS CO., LTD.**  
**Manufacturer Address: #181 Gongdan-dong, Gumi-si, Gyeongbuk, Republic of Korea.**  
**Contact Person: Mr. Hak-Ki Kim / General Manager**  
**Tel. Number: +82-54-468-0831 Fax Number: +82-54-461-8368**

- **FCC ID.** OZ5URCMX-850
- **Equipment Class** Remote Control Transmitter (DSC)
- **EUT Type** RF REMOTE CONTROLLER
- **Model Name** MX-850 , ML-600  
**The differences for all models are follow:**

Model Name	Changed Description
MX - 850	Basic model name
ML - 600	Customer's requirement
- **Trade Name** UNIVERSAL Remote Control
- **Serial Number** Prototype
- **Rule Part(s)** FCC Part 15 Subpart C
- **Type of Authority** Certification
- **Test Procedure(s)** ANSI C63.4 (2009)
- **Dates of Test** March 26, 2013
- **Place of Test** **GUMI COLLEGE EMC CENTER** (FCC Registration No.: 100749, 443957)  
 37 Yaeun-ro, Gumi-si, Gyeongsangbuk-do, 730-711, Republic of Korea
- **Test Report Number** GETEC-E3-13-027
- **Dates of Issue** April 1, 2013

**EUT Type: RF REMOTE CONTROLLER**

**FCC ID: OZ5URCMX-850**





## 2. Introduction

The measurement procedure described in American National Standard for Methods of Measurement of Radio-Nose Emissions From Low-Voltage Electrical and Electronic Equipment in the Range of 9 kHz to 40 GHz (ANSI C63.4-2009) was used in determining radiated and conducted emissions emanating from **OHSUNG ELECTRONICS CO., LTD. RF REMOTE CONTROLLER (Model Name: MX-850) FCC ID.: OZ5URCMX-850**

These measurement tests were conducted at **GUMI COLLEGE EMC CENTER**.

The site address is 37 Yaeun-ro, Gumi-si, Gyeongsangbuk-do, 730-711, Republic of Korea.

This test site is one of the highest point of Gumi 1 college at about 200 km away from Seoul city and 40 km away from Daegu city. It is located in the valley surrounded by mountains in all directions where ambient radio signal conditions are quiet and a favorable area to measure the radio frequency interference on open field test site for the computing and ISM devices manufactures. The detailed description of the measurement facility was found to be in compliance with the requirements of FCC §2.948 according to ANSI C63.4 (2009)



Fig 1. The map above shows the Gumi College in vicinity area.



### 3. Product Information

#### 3.1 Description of EUT

The Equipment under Test (EUT) is the **OHSUNG ELECTRONICS CO., LTD.**  
**RF REMOTE CONTROLLER (Model Name: MX-850) FCC ID.: OZ5URCMX-850**

- **Memory** : 4 Mbit Flash
- **Macro Capability** : Up to 255 steps each
- **RF Range** : 50 to 100 feet, depending upon the environment
- **IR Range** : 30 to 50 feet, depending upon the environment
- **Power** : Battery 1.5 V × 4 (SIZE:AAA) , DC 6 V
- **I/O Port** : RS 232 1EA
- **RF Frequency** : 418 MHz
- **Size** : 9.0 × 3.0 × 2.1
- **Crystal & Clock Frequency** : Main board: 12 MHz  
RF: 13.0625 MHz



### 3.2 Support Equipment / Cables used

#### 3.2.1 Used Support Equipment

Description	Manufacturer	Model Name	S/N & FCC ID
None.	-	-	S/N: - FCC ID: -

See "Appendix E- Test Setup Photographs" for actual system test set-up

#### 3.2.2 System configuration

Description	Manufacturer	Model Name	S/N & FCC ID.
None.	-	-	S/N: - FCC ID.: -

#### 3.2.3 Used Cable(s)

Cable Name	Condition	Description
None.	-	-

### 3.3 Modification Item(s)

- None



#### 4. Antenna Requirement - §15.203

An intentional radiator antenna shall be designed to ensure that no antenna other than that furnished by the applicant can be used with the device. The use of permanently attached antenna or of an antenna that uses a unique coupling to the intentional radiator shall be considered sufficient to comply with this requirement.

##### 4.1 Description of Antenna

The **OHSUNG ELECTRONICS CO., LTD. / RF Transmitter Universal Remote Control** comply with the requirement of §15.203 with a built-in looped antenna permanently attached to the transmitter.

#### 5. Description of tests

##### 5.1 Test Condition

- Test Voltage / Frequency : DC 6 V supplied from the four DC 1.5 V AAA size batteries
  - \* The EUT power is fed from battery. Therefore, the conducted emission test was skipped
- Test Mode(s): RF continuous transmitting mode

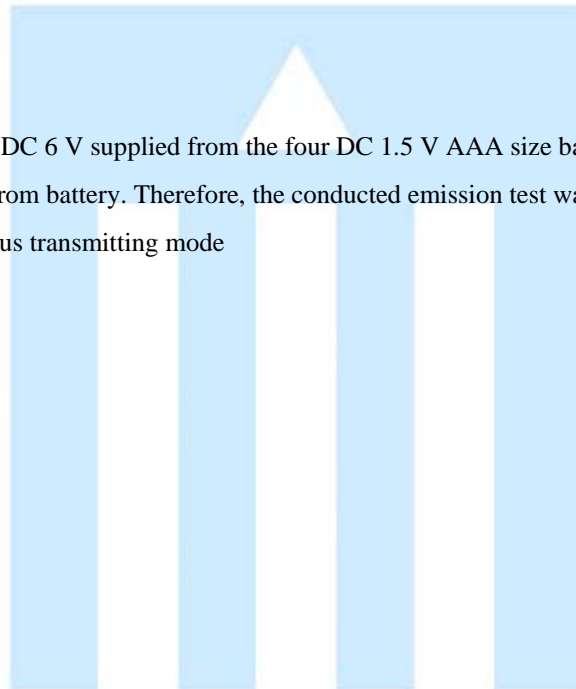





## 5.2 Radiated Emission

Exploratory Radiated measurements were conducted at the 3m semi anechoic chamber in order to identify the highest emission by operating the EUT in a range of typical modes of operation, cable positions, system configuration and arrangement.

Based on exploratory measurements, the final measurements were conducted at the worst test conditions.

Final measurements of below 1GHz were made at 3m Chamber (FCC Registration No.: 443957) or Open area test site (FCC Registration No.: 100749) that complies with CISPR 16/ANSI C63.4.

Above 1GHz final measurements were conducted at the 3m Chamber (FCC Registration No.: 443957) only.

For measurements above 1GHz, the bottom side of 3m chamber was installed with absorbers in order to meet SVSWR Limit.

Exploratory measurements were scanned using Peak mode of EMI Test receiver and final measurements were measured with Quasi-Peak mode (Below 1GHz) and Peak & Average mode (Above 1GHz).

The measurements were performed by rotating the EUT 360° and adjusting the receive antenna height from 1.0 m to 4.0 m. All frequencies were investigated in both horizontal and vertical antenna polarity.

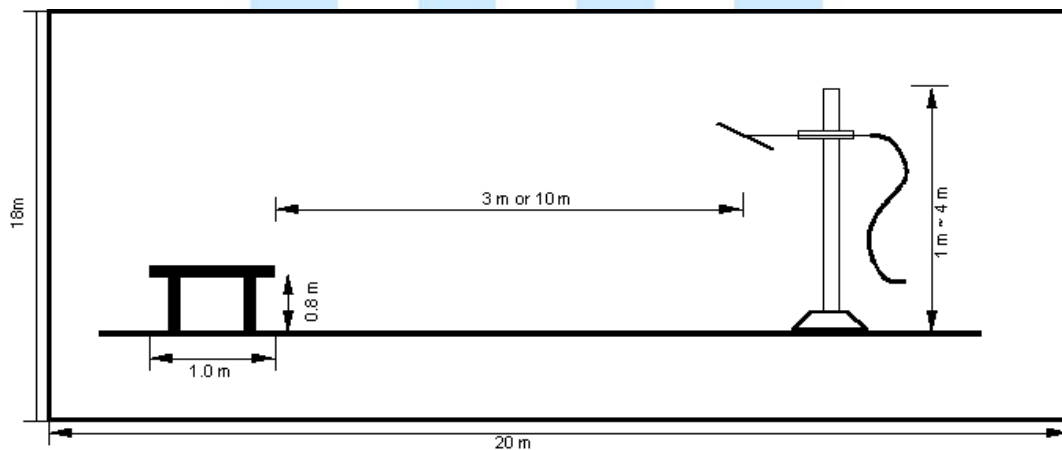

Fig 2. Dimensions of test site (Below 1GHz)

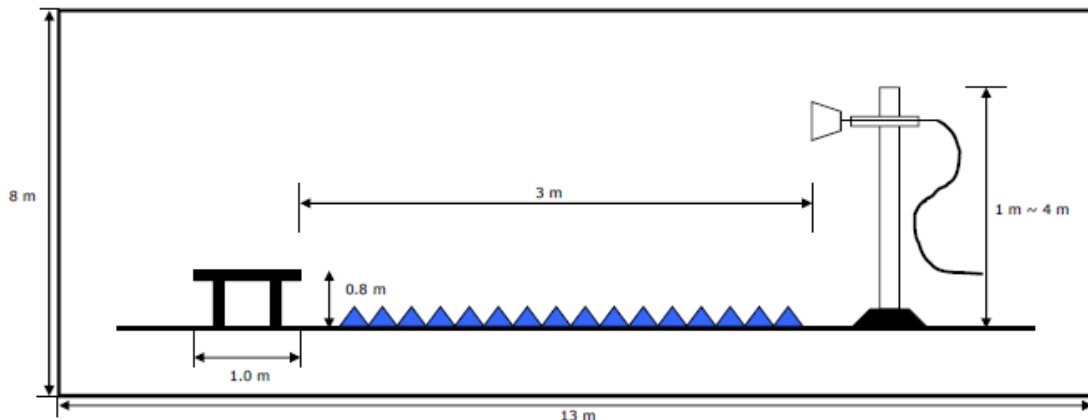

Fig 3. Dimensions of test site (Above 1GHz)



### 5.3 Duty Cycle Correction

Measurements may be adjusted where pulsed RF is utilized to find the average level associated with a quantity.

This calculation is applied to limits for pulsed licensed and unlicensed devices.

For unlicensed intentional radiator under 47CFR Part 15 §15.35, all duty cycle measurements are compared to a 100 millisecond period.

On time =  $N_1L_1 + N_2L_2 + \dots + N_nL_n$ , where  $N_1$  is number of type 1 pulses,  $L_1$  is length of type 1 pulses, etc.

**Duty Cycle = On time/100 millisecond.**

### 5.4 Occupied Bandwidth

Occupied bandwidth was performed by coupling the output of the EUT to the input of a spectrum analyzer.

The bandwidth of the emission shall be no wider than 0.25 % of the center frequency for device operating above 70 MHz and below 900 MHz. For device operating above 900 MHz, the emission shall be no wider than 0.5 % of the center frequency. The bandwidth is determined at the points 20 dB down from the modulated carrier.

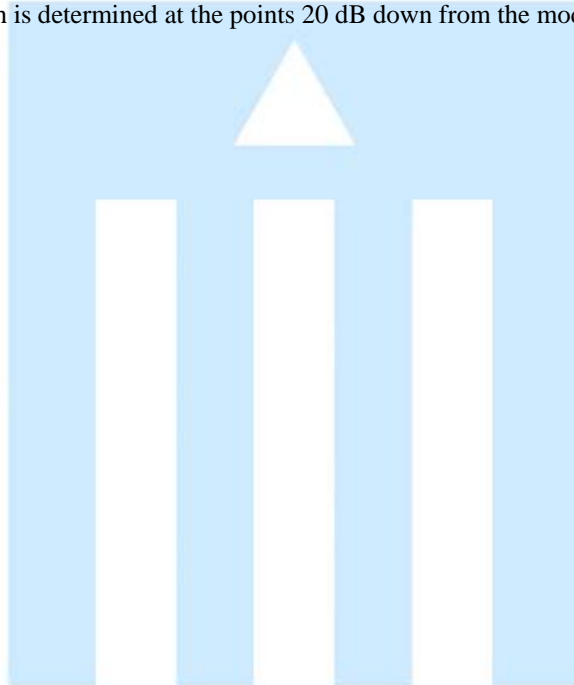



## 6. Duty Cycle Correction

### 6.1 Operating Environment

Temperature : 22.0 °C  
 Relative humidity : 41.0 % R.H.

### 6.2 Test Set-up

The spectrum analyzer was set to Zero span and the video triggered to collect the pulse train of the modulation. Calculations of the duty cycle correction factor were obtained from time data provided by the plots.

### 6.3 Test Equipment used

Model Name	Manufacturer	Description	Serial Number	Due to Calibration
■ - ESIB26	Rohde & Schwarz	EMI Test Receiver	830482/010	05. 23. 2013
■ - VULB9160	Schwarzbeck	Broadband Test Antenna	3193	03. 15. 2014

### 6.4 Test result of Duty Cycle

- Test Date : March 26,2013
- Reference Standard : Part 15 Subpart C, Sec. 15.231 (a)(1)
- Operating Condition : RF transmitting mode
- Spectrum Resolution Bandwidth (6 dB) : 100 kHz

#### 6.4.1 Test Frequency: 418 MHz

Define of duty cycle

- Number of Code groups per 100 ms = 1
- Number of Wide Pulse = 335
- Width of Pulses = 0.006 ms
- Number of Narrow Pulse = 693
- Width of Pulses = 0.006 ms

Calculation of duty cycle

- Total width of pulse train:  $(335 \times 0.006 \text{ ms}) + (693 \times 0.006 \text{ ms}) = 6.17 \text{ ms}$
- Duty Cycle (%):  $6.168 \text{ ms} / 100 \text{ ms} = 6.17 \%$
- Duty Cycle (dB): - 24.20 dB

Fundamental Frequency	Total width of ON-Time	Duty Cycle (%)	Duty Cycle (dB)
418 MHz	6.17 ms	6.17 %	- 24.20 dB



### 6.4.2 Complete Pulse Train / On-time of the Head

#### 1. NEC Format (15A\_002)

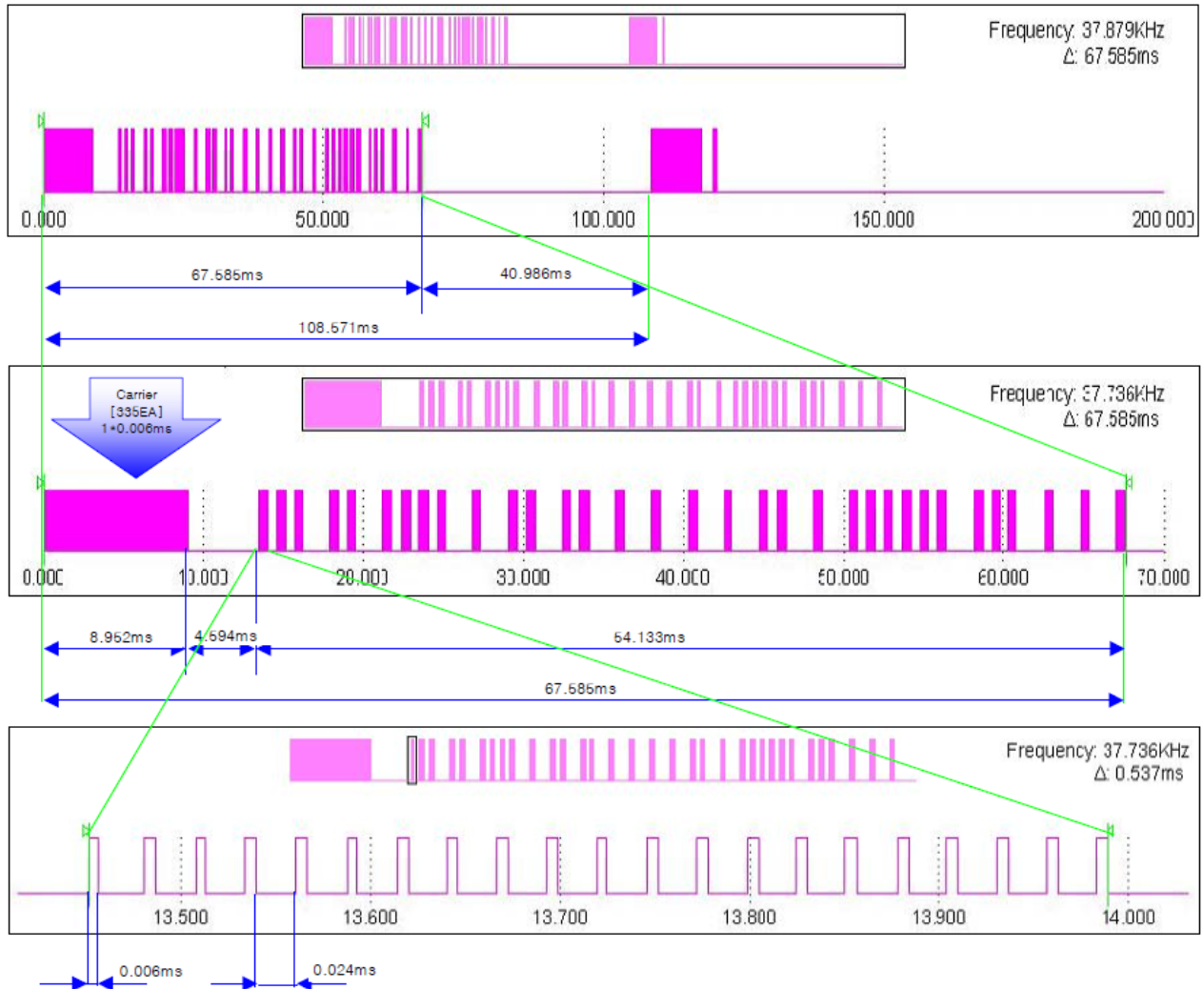

No. of code GR. Per 100ms	Head		Data		Total	Duty Cycle	
	No. of pulse	Width of pulse(ms)	No. of pulse	Width of pulse(ms)	Width(ms)	(%)	(dB)
	335	0.006ms	693	0.006ms	6.168	6.17%	-24.19

계산식 : (335\*0.006)+(693\*0.006) = 6.168 [693 = (1\*33\*21)]





2. TC9012 Format (14A\_044)

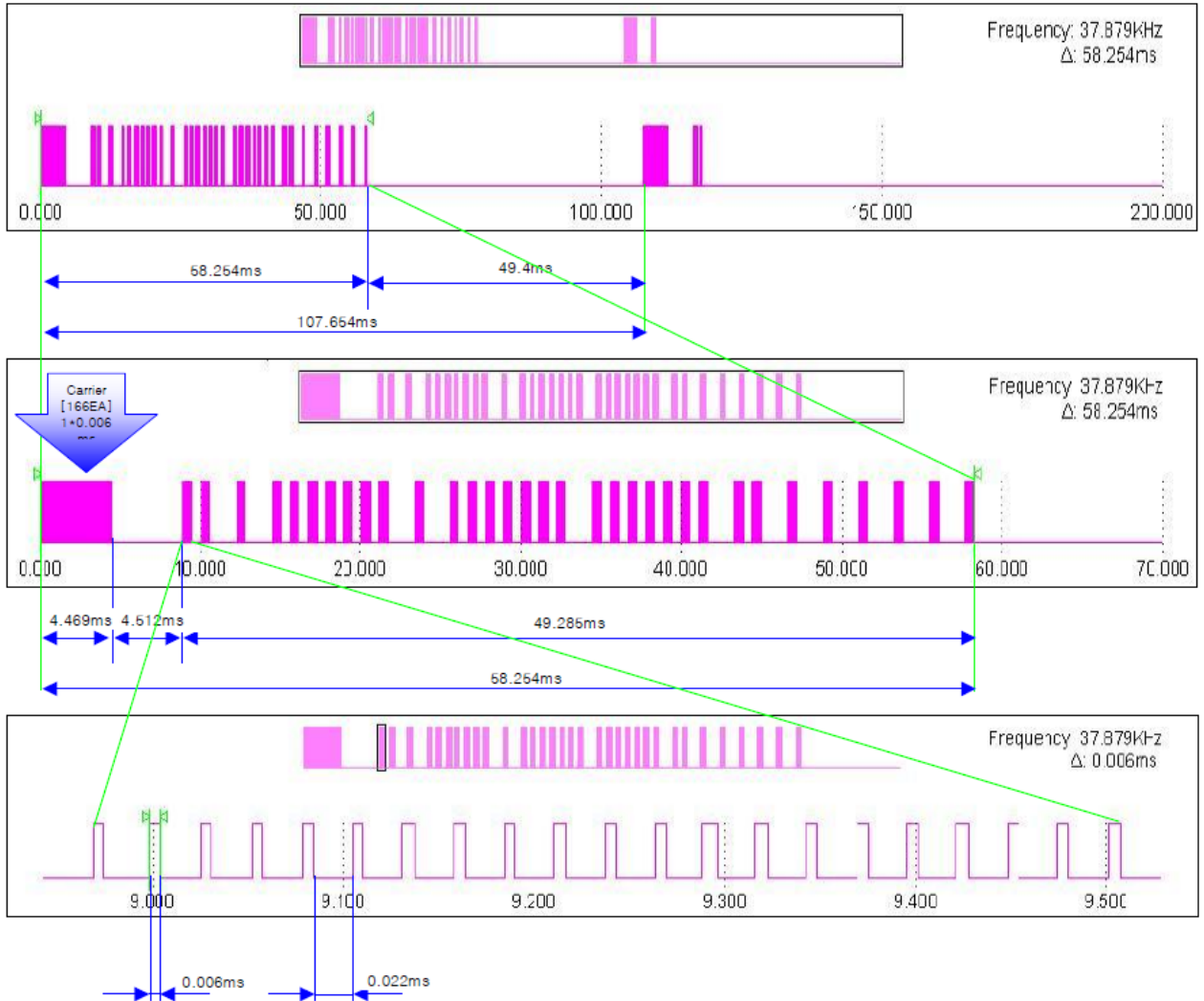

No. of code GR. Per 100ms	Head		Data		Total	Duty Cycle	
	No. of pulse	Width of pulse(ms)	No. of pulse	Width of pulse(ms)	Width(ms)	(%)	(dB)
	166	0.006ms	693	0.006ms	5.15	5.15%	-25.757

계산식 : (166\*0.006)+(693\*0.006) = 5.154 [693 = (1\*33\*21)]





3. MN6014 Format (18A\_052)

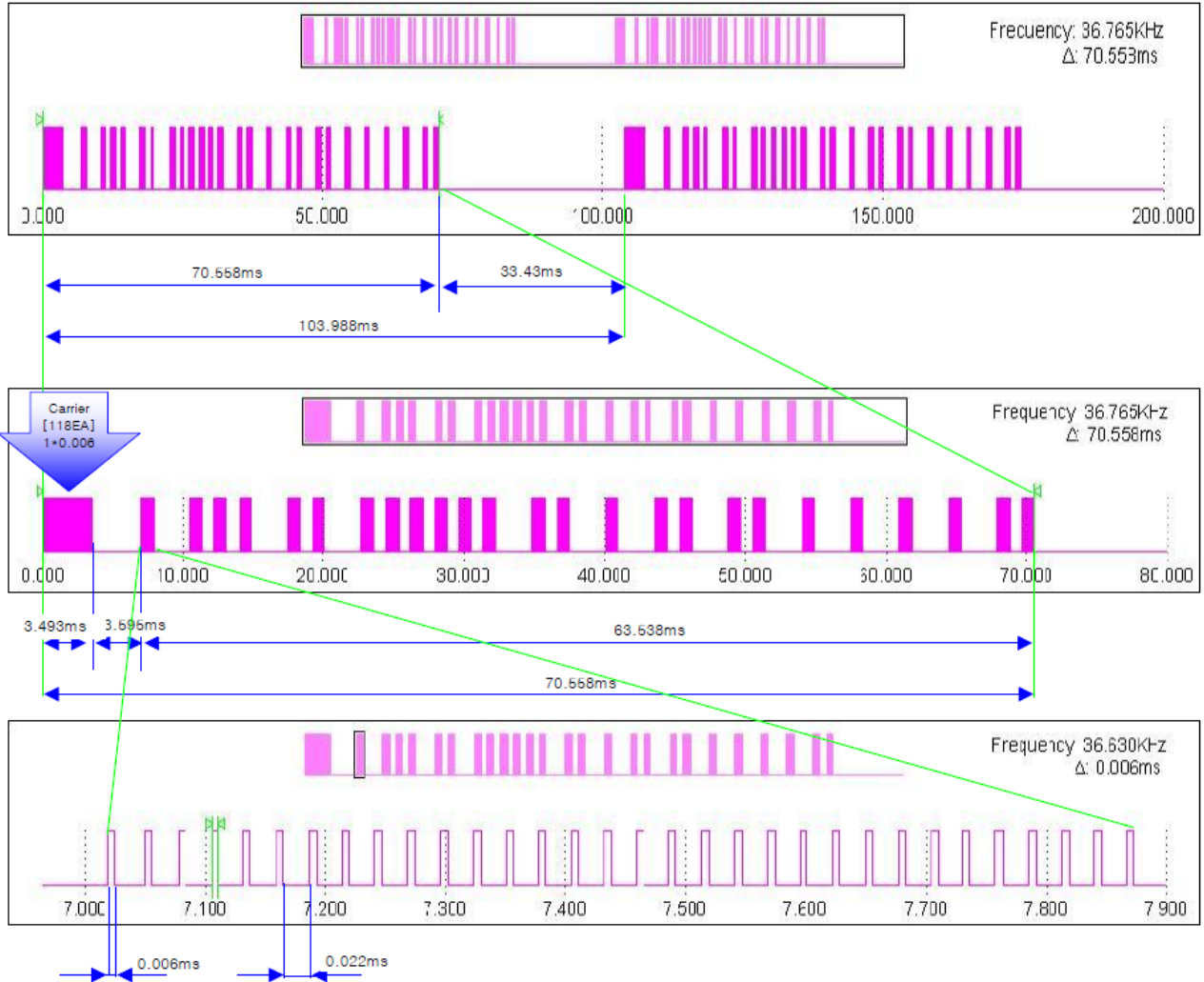

No. of code GR. Per 100ms	Head		Data		Total	Duty Cycle	
	No. of pulse	Width of pulse(ms)	No. of pulse	Width of pulse(ms)	Width(ms)	(%)	(dB)
	118	0.006ms	693	0.006ms	5.658	5.66%	-24.94

계산식 :  $(118 \times 0.006) + (825 \times 0.006) = 5.658$  [825 =  $(1 \times 33 \times 25)$ ]





## 7. Activation time

### 7.1 Operating Environment

Temperature : 22.0 °C  
 Relative humidity : 38.0 % R.H.

### 7.2 Limit

A manually operated transmitter shall employ a switch that will automatically deactivate the transmitter within not more than 5 seconds of being released.

### 7.3 Test Equipment used

Model Name	Manufacturer	Description	Serial Number	Due to Calibration
■ - FSP	Rohde & Schwarz	Spectrum Analyzer	101431	04.26.2013

### 7.4 Test result of Activation time

- Test Date : March 28, 2013
- Reference Standard : Part 15 Subpart C, Sec. 15.35
- Operating Condition : RF transmitting mode
- Spectrum Resolution Bandwidth (6 dB) : 1 MHz

Fundamental Frequency	Activate ON-Time	Limit	Result
418 MHz	4.71 s	< 5 s	PASS

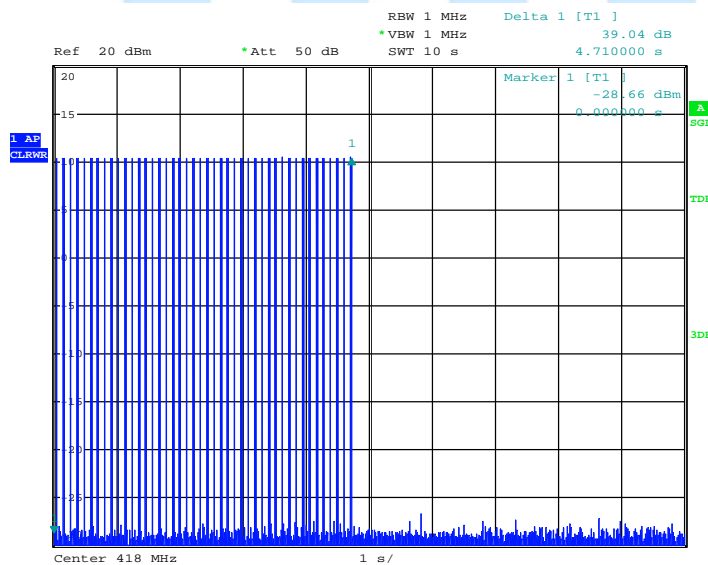

Date: 28.MAR.2013 09:16:24

< Fig 4. Activation time >



## 8. Radiated Emission

### 8.1 Operating environment

Temperature : 23.0 °C  
Relative humidity : 40.0 % R.H.

### 8.2 Test set-up

A preliminary and final measurement was at 3 m anechoic chamber.

The EUT was placed on a non-conductive turntable approximately 0.8 m above the ground plane.

The turntable with EUT was rotated 360°, and the antenna was varied in height between 1.0 m and 4.0 m in order to determine the maximum emission levels.

This procedure was performed for both horizontal and vertical polarization of the receiving antenna.

### 8.3 Measurement uncertainty

The measurement uncertainty was calculated in accordance with ISO “Guide to the expression of uncertainty in measurement”.

The measurement uncertainty was given with a confidence of 95 %.

Test items(Anechoic Chamber)	Uncertainty	Remark
Radiated emission (30 MHz ~ 300 MHz, 3 m, Vertical)	± 4.35 dB	Confidence level of approximately 95 % ( $k = 2$ )
Radiated emission (30 MHz ~ 300 MHz, 3 m, Horizontal)	± 4.29 dB	Confidence level of approximately 95 % ( $k = 2$ )
Radiated emission (300 MHz ~ 1 000 MHz, 3 m, Vertical)	± 4.43 dB	Confidence level of approximately 95 % ( $k = 2$ )
Radiated emission (300 MHz ~ 1 000 MHz, 3 m, Horizontal)	± 4.21 dB	Confidence level of approximately 95 % ( $k = 2$ )





### 8.4 Limit

Fundamental Frequency (MHz)	Field strength of Fundamental			Field strength of Spurious Emission	
	$\mu\text{V/m}$	$\text{dB}\mu\text{V/m}$	$\mu\text{V/m}$	$\mu\text{V/m}$	$\text{dB}\mu\text{V/m}$
40.66 ~ 40.7	2 250	67.04		225	47.04
70 ~ 130	1 250	61.94		125	41.94
130 ~ 174	1 250 to 3 750	61.94 to 71.48	56.818 18(F)-6136.363 6	125 to 375	41.94 to 51.48
174 ~ 260	3 750	71.48		375	51.48
260 ~ 470	3 750 to 12 500	71.48 to 81.94	41.666 7(F)-7083.333 3	375 to 1 250	51.48 to 61.94
Above 470	12 500	81.94		1 250	61.94
Restricted Band	N/A			500	54.0

### 8.5 Test Equipment used

Model Name	Manufacturer	Description	Serial Number	Due to Calibration
■ - ESIB26	Rohde & Schwarz	EMI Test Receiver	830482/010	05. 23. 2013
■ - VULB9160	Schwarzbeck	Broadband Test Antenna	3193	03. 15. 2014
■ - BBHA9120D	Schwarzbeck	Horn Antenna	597	02. 28. 2015
■ - MCU066	maturo GmbH	Position Controller	1390306	N/A
■ - TT2.5SI	maturo GmbH	Turntable	1390307	N/A
■ - AM 4.0	maturo GmbH	Antenna Mast	1390308	N/A
■ - AFS 44 00101800-25-10P-44	MITEQ	Preamplifier	1258943	01. 24. 2014





### 8.6 Test data for Radiated Emission

- Test Date : March 26, 2013
- Reference Standard : Part 15 Subpart C, Sec.15.231
- Measuring Distance : 3 m
- Note : 1. Through three orthogonal axes were investigated and the worst case is reported.  
 2. The signal bandwidth was measured around 40kHz and it less than 100 kHz.  
 Therefore, PDCF is not required the fundamental signal peak result.
- Measurement

Frequency range	30 MHz ~ 1 GHz	Above 1 GHz
Detector mode	Quasi peak	Peak / Average
Resolution bandwidth	120 kHz	1 MHz

#### 8.6.1 Operating condition: Continuous RF transmitting mode (418 MHz)

- ♦ Field Strength of the fundamental & harmonic frequencies.

Frequency (MHz)	Measurement Level					Limit		Margin		Positioning System		
	Reading (dBuV)	Tranduce (dB/m)	Duty cycle (dB)	Peak (dBuV/m)	Average (dBuV/m)	Peak (dBuV/m)	Aveage (dBuV/m)	Peak (dBuV/m)	Average (dBuV/m)	Pol. (H/V)	Height (cm)	Angle (deg)
<b>Fundamental</b>												
418.01	79.64	20.06	-24.20	99.70	75.50	100.29	80.29	0.59	4.78	H	115	95
<b>Spurious</b>												
835.99	40.50	27.90	-24.20	68.40	44.20	80.29	60.29	11.89	16.08	H	100	180
1253.50	69.02	-13.72	-24.20	55.30	31.10	80.29	60.29	24.99	29.18	V	100	268
1671.95	79.66	-12.56	-24.20	67.10	42.90	74.00	54.00	6.90	11.10	H	125	322
2090.38	83.56	-11.26	-24.20	72.30	48.10	80.29	60.29	7.99	12.18	H	100	353
2508.41	77.47	-9.47	-24.20	68.00	43.80	80.29	60.29	12.29	16.48	H	175	344
2926.45	84.78	-7.68	-24.20	77.10	52.90	80.29	60.29	3.19	7.38	H	100	135
3344.10	74.58	-5.98	-24.20	68.60	44.40	80.29	60.29	11.69	15.88	H	100	354
3762.13	73.00	-4.30	-24.20	68.70	44.50	74.00	54.00	5.30	9.50	H	100	220
4182.36	67.34	-2.94	-24.20	64.40	42.00	74.00	54.00	9.60	12.00	H	100	275

\*Comment ; below 1GHz : Tranduce = ANT factor + cable loss  
 above 1GHz : Tranduce = ANT factor + cable loss + AMP gain

Note: "H": Horizontal, "V": Vertical





♦ Field Strength of the spurious emission except the harmonic frequencies

Frequency (MHz)	Measurement Level				Limit (dBμV/m)	Margin (dB)	Positioning System		
	Reading Value (dBμV)	Antenna Factor (dB/m)	Cable Loss (dB)	Test Result (dBμV/m)			Pol. (H/V)	Height (cm)	Angle (°)
	30.00	2.50	10.29	1.01			13.80	40.00	26.20
51.13	-0.78	11.94	1.54	12.70	40.00	27.30	V	100	2332
64.17	1.92	10.80	1.58	14.30	40.00	25.70	V	100	359
161.72	-2.63	12.84	2.29	12.50	43.50	31.00	V	125	0
326.61	19.22	14.15	3.33	36.70	46.00	9.30	H	237	335
509.70	-1.01	17.50	4.21	20.70	46.00	25.30	H	145	338

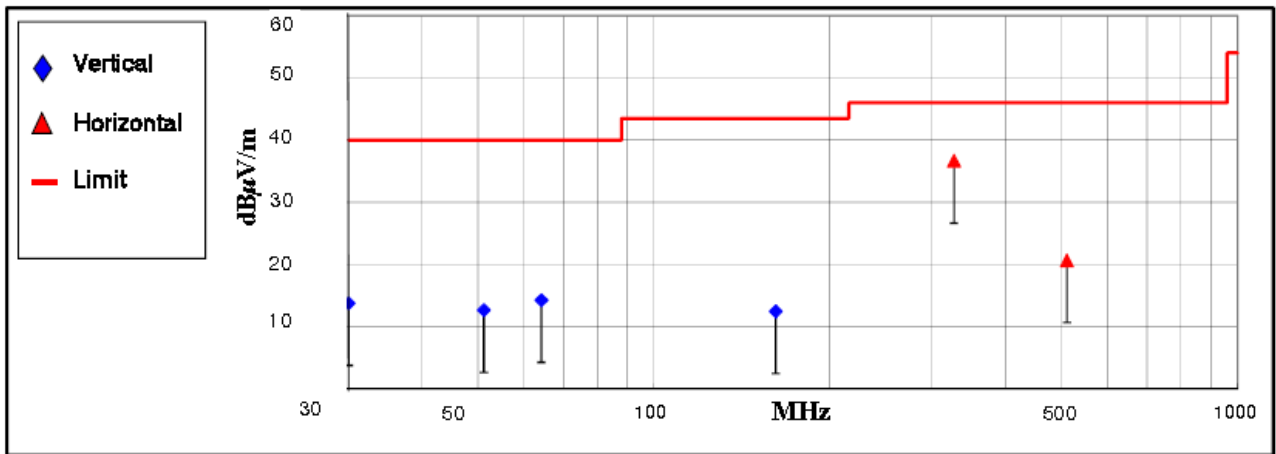

< Fig 5. Radiated emission result (30 MHz ~ 1 000 MHz) >

♦ Field Strength of the spurious emission except the harmonic frequencies

Frequency (MHz)	Measurement Level					Limit (dBμV/m)		Margin (dB)		Positioning System			
	Reading Value (dBμV/m)		AF (dB/m)	AMP / CL (dB)	Test Result (dBμV/m)		Peak	Average	Peak	Average	Pol. (H/V)	Height (cm)	Angle (°)
	Peak	Average	(dB/m)	(dB)	Peak	Average	-	-	-	-	-	-	-
All frequency	-	-	-	-	<<	<<	-	-	-	-	-	-	-

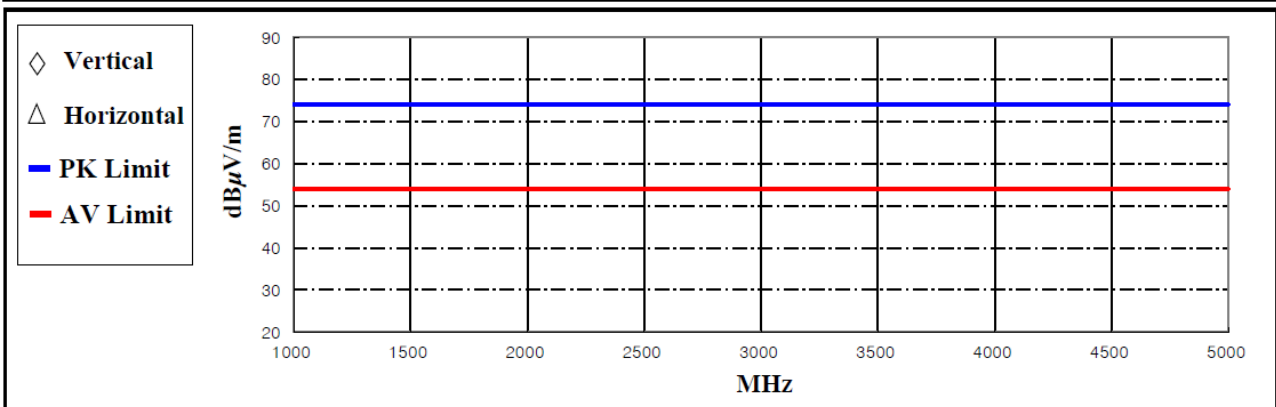

\*Comment : AMP/CL\_Cable loss value + AMP gain value  
 AF : Antenna factor value  
 Pol. : H(Horizontal), V(Vertical)

< Fig 6. Radiated emission result (1 GHz ~ 5 GHz) >





## 9. Occupied Bandwidth Measurement

### 9.1 Operating Environment

Temperature : 22.0 °C  
 Relative humidity : 41.0 %R.H.

### 9.2 Test Set-up

This measurement is performed with the antenna located close enough to give a full-scale deflection of the modulated carrier on the spectrum analyzer. The plot is taken at 200 kHz/division frequency span, 10 kHz 3 dB resolution bandwidth and 5 dB/division logarithmic display from an ESI spectrum analyzer.  
 The measuring bandwidth shall be set to a value greater than 5 % of the allowed bandwidth (ANSI C63.4-2009)

### 9.3 Limit

Frequency Range(MHz)	Occupied Bandwidth Limit
70 ~ 900	0.25 %
> 900	0.5 %

### 9.4 Test Equipment used

Model Name	Manufacturer	Description	Serial Number	Due to Calibration
■ - ESIB26	Rohde & Schwarz	EMI Test Receiver	830482/010	05. 23. 2013
■ - VULB9160	Schwarzbeck	Bi-log antenna	3193	03. 15. 2014

### 9.5 Test result of occupied bandwidth

- Test Date : March 26, 2013  
 - Reference standard : Part 15 Subpart C, Sec. 15.231  
 - Operating condition : RF transmitting mode  
 - Spectrum resolution bandwidth(3 dB) : 50 kHz



### 9.5.1 Test Frequency: 418 MHz

Allowed Bandwidth: Test frequency × 0.002 5

Fundamental Frequency	Bandwidth	Allowed Bandwidth	Result
418 MHz	831 kHz	1 045 kHz	PASS

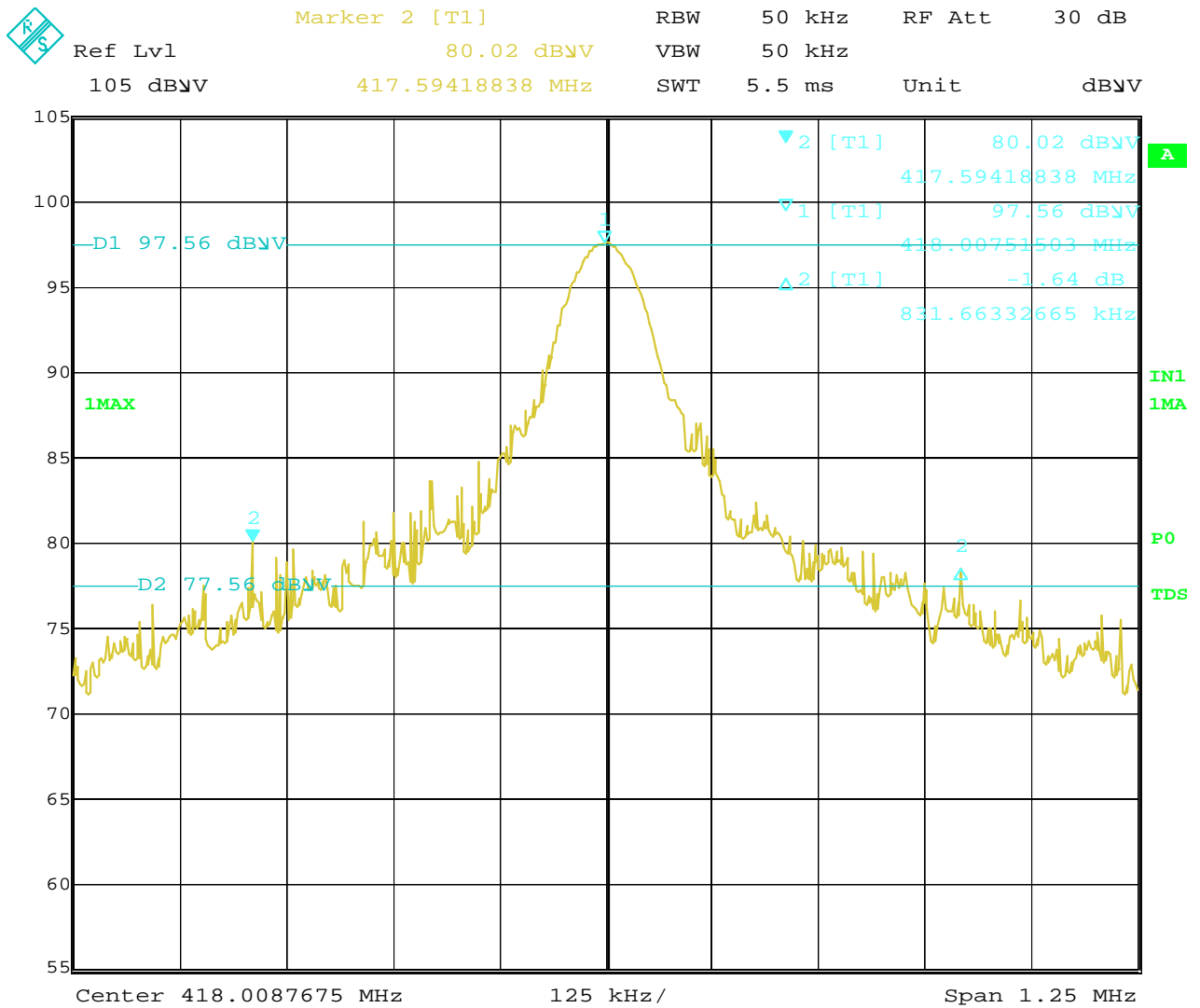

Date: 26.MAR.2013 12:13:29

< Fig 7. Occupied bandwidth >





## 10. Sample Calculations

$$\text{dB}\mu\text{V} = 20 \text{ Log}_{10}(\mu\text{V}/\text{m})$$

$$\text{dB}\mu\text{V} = \text{dBm} + 107$$

$$\mu\text{V} = 10^{(\text{dB}\mu\text{V}/20)}$$

### 10.1 Example 1 :

#### ■ 20.3 MHz

<b>Class B Limit</b>	<b>= 250 <math>\mu\text{V}</math> = 48 dB<math>\mu\text{V}</math></b>
<b>Reading</b>	<b>= 39.2 dB<math>\mu\text{V}</math></b>
<b><math>10^{(39.2\text{dB}\mu\text{V}/20)}</math></b>	<b>= 91.2 <math>\mu\text{V}</math></b>
<b>Margin</b>	<b>= 48 dB<math>\mu\text{V}</math> - 39.2 dB<math>\mu\text{V}</math></b>
	<b>= 8.8 dB</b>

### 10.2 Example 2 :

#### ■ 66.7 MHz

<b>Class B Limit</b>	<b>= 100 <math>\mu\text{V}/\text{m}</math> = 40.0 dB<math>\mu\text{V}/\text{m}</math></b>
<b>Reading</b>	<b>= 31.0 dB<math>\mu\text{V}</math></b>
<b>Antenna Factor + Cable Loss</b>	<b>= 5.8 dB</b>
<b>Total</b>	<b>= 36.8 dB<math>\mu\text{V}/\text{m}</math></b>
<b>Margin</b>	<b>= 40.0 dB<math>\mu\text{V}/\text{m}</math> - 36.8 dB<math>\mu\text{V}/\text{m}</math></b>
	<b>= 3.2 dB</b>





## 11. Recommendation & Conclusion

The data collected shows that the **OHSUNG ELECTRONICS CO., LTD. RF REMOTE CONTROLLER (Model Name: MX-850)** complies with §15.231 of the FCC Rules.

- The end -

