



EVALUATION REPORT

for Certification

Applicant : Ohsung Electronics Co.,Ltd.
#181 Gongdan-dong, Gumi-Si,
Gyeongsangbuk-Do, South Korea
Attn: Mr. Hak-Ki Kim / General Manager

Date of Issue: Sep. 01, 2022
Order Number: GETEC-C1-21-725
Test Report Number: GETEC-E3-21-101
Test Site: GUMI UNIVERSITY EMC CENTER
CAB Designation Number: KR0033

RESPONSIBLE PARTY : Ohsung Electronics Co.,Ltd.
ADDRESS : #181 Gongdan-dong, Gumi-Si, Gyeongsangbuk-Do, South Korea
CONTACT PERSON : Mr. Hak-Ki Kim / General Manager

Rule Part(s) : FCC Part 15 Subpart C-Intentional Radiator § 15.247
Test Method : ANSI C63.10 (2013)
Equipment Class : Digital Transmission System(DTS)
EUT Type : RF Remote Controller
Type of Authority : Certification
Model Name : MX-1400i

This equipment has been shown to be in compliance with the applicable technical standards as indicated in the measurement report and was tested in accordance with the measurement procedures specified in ANSI C63.10 (2013)

I attest to the accuracy of data. All measurements reported herein were performed by me or were made under my supervision and are correct to the vest of my knowledge and belief. I assume full responsibility for the completeness of these measurements and vouch for the qualifications of all persons taking them.

Tested by,



Jong-Wook Park / Senior Engineer
GUMI UNIVERSITY EMC CENTER

Reviewed by,



Hyun Kim / Technical Manager
GUMI UNIVERSITY EMC CENTER



Version

Test Report No.	Date	Description
GETEC-E3-21-101	Sep. 01, 2022	- First Approval Report





CONTENTS

1. GENERAL INFORMATION	5
2. INTRODUCTION	6
3. PRODUCT INFORMATION	7
3.1 DESCRIPTION OF EUT.....	7
3.2 DEFINITION OF MODELS.....	7
3.3 SUPPORT EQUIPMENT / CABLES USED	8
3.4 MODIFICATION ITEM(S).....	8
4. ANTENNA REQUIREMENT - §15.203	9
4.1 DESCRIPTION OF ANTENNA.....	9
5. DESCRIPTION OF TESTS.....	9
5.1 TEST CONDITION.....	9
6. REFERENCES STANDARDS	9
7. SUMMARY OF TEST RESULTS	10
8. 6 DB BANDWIDTH MEASUREMENT	11
8.1 OPERATING ENVIRONMENT.....	11
8.2 TEST SET-UP (LAYOUT)	11
8.3 LIMIT	11
8.4 TEST EQUIPMENT USED.....	11
8.5 TEST TEST PROCEDURE.....	11
8.6 TEST RESULT	12
9. CONDUCTED MAXIMUM OUTPUT POWER MEASUREMENT.....	16
9.1 OPERATING ENVIRONMENT.....	16
9.2 TEST SET-UP (LAYOUT)	16
9.3 LIMIT	16
9.4 TEST EQUIPMENT USED.....	16
9.5 TEST PROCEDURE	16
9.6 TEST RESULT	17
10. POWER SPECTRAL DENSITY MEASUREMENT.....	18
10.1 OPERATING ENVIRONMENT	18
10.2 TEST SET-UP (LAYOUT)	18
10.3 LIMIT	18
10.4 TEST EQUIPMENT USED.....	18
10.5 TEST PROCEDURE	18
10.6 TEST RESULT	19
11. CONDUCTED SPURIOUS EMISSION & OUT OF BAND EMISSION	23
11.1 OPERATING ENVIRONMENT.....	23
11.2 TEST SET-UP (LAY-OUT).....	23
11.3 LIMIT	23
11.4 TEST EQUIPMENT USED	23
11.5 TEST PROCEDURE.....	23
11.6 TEST RESULT	24
12. AC POWER LINE CONDUCTED EMISSION	33
12.1 OPERATING ENVIRONMENT	34





12.2 TEST SET-UP34
 12.3 MEASUREMENT UNCERTAINTY.....34
 12.4 LIMIT35
 12.5 TEST EQUIPMENT USED.....35
 12.6 TEST DATA FOR CONDUCTED EMISSION35
 13. RADIATED SPURIOUS & RESTRICTED BAND EDGE EMISSION.....37
 13.1 OPERATING ENVIRONMENT38
 13.2 TEST SET-UP.....38
 13.3 MEASUREMENT UNCERTAINTY38
 13.4 LIMIT39
 13.5 TEST EQUIPMENT USED.....39
 13.6 TEST DATA FOR RADIATED SPURIOUS EMISSION.....40
 13.7 TEST DATA FOR RADIATED RESTRICTED BAND EDGE EMISSION43
 14. SAMPLE CALCULATIONS.....45
 14.1 EXAMPLE 1 :45
 14.2 EXAMPLE 2 :45
 15. RECOMMENDATION & CONCLUSION.....46

APPENDIX A – ATTESTATION STATEMENT
 APPENDIX B – LABELLING
 APPENDIX C – BLOCK DIAGRAM
 APPENDIX D – SCHEMATIC DIAGRAM
 APPENDIX E – TEST SETUP PHOTOGRAPH
 APPENDIX F – EXTERNAL PHOTOGRAPH
 APPENDIX G – INTERNAL PHOTOGRAPH
 APPENDIX H – USER’S MANUAL
 APPENDIX I – OPERATIONAL DESCRIPTION
 APPENDIX J – ANTENNA SPECIFICATION
 APPENDIX K – PART LIST
 APPENDIX L – RF EXPOSURE EVALUATION





Scope: Measurement and determination of electromagnetic emissions (EME) of radio frequency devices including intentional and / or unintentional radiators for compliance with technical rules and regulations of the Federal Communications Commission.

1. General Information

Applicant: Ohsung Electronics Co.,Ltd.
Applicant Address: #181 Gongdan-dong, Gumi-Si, Gyeongsangbuk-Do, South Korea
Manufacturer: Ohsung Electronics Co.,Ltd.
Manufacturer Address: #181 Gongdan-dong, Gumi-Si, Gyeongsangbuk-Do, South Korea
Contact Person: Mr. Hak-Ki Kim/ General anager
Telephone Number: +82-54-468-7281

- **FCC ID.** OZSURCMX1400I
- **Equipment Class** Digital Transmission System (DTS)
- **EUT Type** RF Remote Controller
- **Model Name** MX-1400i
- **Rule Part(s)** FCC Part 15 Subpart C-Intentional Radiator § 15.247
- **Test Method** ANSI C63.10 (2013)
- **Type of Authority** Certification
- **Test Procedure(s)** ANSI C63.10 (2013), KDB558074 D01 DTS Meas Guidance v05r02(April 2,2019)
- **Dates of Test** Jan. 11, 2022 ~ Aug. 30, 2022
- **Place of Test** **GUMI UNIVERSITY EMC CENTER** (FCC Test firm Registration No.: 269701)
37 Yaeun-ro, Gumi-si, Gyeongsangbuk-do, 730-711, Republic of Korea
- **Test Report Number** GETEC-E3-21-101
- **Dates of Issue** Sep. 01, 2022



2. Introduction

The measurement procedure described in American National Standard for Methods of Measurement of Radio-Nose Emissions From Low-Voltage Electrical and Electronic Equipment in the Range of 9 kHz to 40 GHz (ANSI C63.4-2009) was used in determining radiated and conducted emissions emanating from **Ohsung Electronics Co.,Ltd. RF Remote Controller(Model name: MX-1400i)**.

These measurement tests were conducted at **GUMI UNIVERSITY EMC CENTER**.

The site address is 37 Yaeun-ro, Gumi-si, Gyeongsangbuk-do, 730-711, Republic of Korea

This test site is one of the highest point of GUMI UNIVERSITY at about 200 kilometers away from Seoul city and 40 kilometers away from Daegu city. It is located in the valley surrounded by mountains in all directions where ambient radio signal conditions are quiet and a favorable area to measure the radio frequency interference on open field test site for the computing and ISM devices manufactures. The detailed description of the measurement facility was found to be in compliance with the requirements of §2.948 according to ANSI C63.10 (2013)

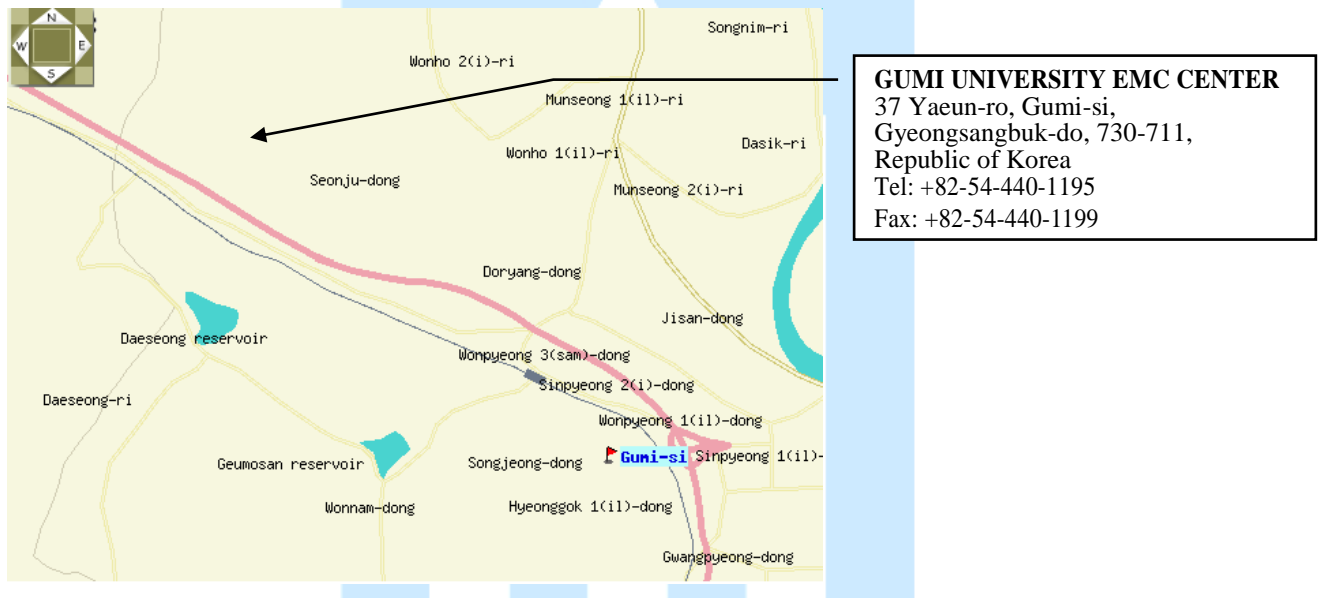

Fig 1. The map above shows the Gumi University in vicinity area.





3. Product Information

3.1 Description of EUT

The Equipment under Test (EUT) is the **Ohsung Electronics Co.,Ltd. RF Remote Controller (Model Name: MX-1400i) FCC ID.: OZ5URCMX1400I**

- Equipment	: RF Remote Controller
- Model name	: MX-1400i
- Serial number	: Proto type
- Electrical Rating	: DC 3.7 V
- Manufacturer	: Ohsung Electronics Co.,Ltd.
- Frequency Range	: 2412 MHz - 2462 MHz
- Modulation	: DSSS, OFDM
- Antenna Specification	: Antenna type : FPCB antenna Gain : 1.67 dBi

3.2 Definition of models

- None.



3.3 Support Equipment / Cables used

3.3.1 Used Support Equipment

Description	Manufacturer	Model Name	S/N & FCC ID.
Notebook Computer ¹⁾	SAMSUNG	NT500R3W	S/N: 0Q2V91JJ100096T FCC ID.: N/A

Note)

1) The Support Equipment use only setting to the test mode.

3.3.2 System configuration

Description	Manufacturer	Model Name	S/N & FCC ID.
-	-	-	-

3.3.3 Used Cable(s)

Cable Name	Condition	Description
-	-	-

3.4 Modification Item(s)

-. None





4. Antenna Requirement - §15.203

An intentional radiator antenna shall be designed to ensure that no antenna other than that furnished by the applicant can be used with the device. The use of permanently attached antenna or of an antenna that uses a unique coupling to the intentional radiator shall be considered sufficient to comply with this requirement.

4.1 Description of Antenna

The **Ohsung Electronics Co.,Ltd., RF Remote Controller**, comply with the requirement of §15.203 with a **FPCB antenna** permanently attached to the transmitter.

5. Description of tests

5.1 Test Condition

The EUT was installed, arranged and operated in a manner that is most representative of equipment as typically used. The measurements were carried out while varying operating modes and cable positions within typically arrangement to determine maximum emission level.

The representative and worst test mode(s) were noted in the test report.

- Test Voltage / Frequency: 3.7 V / DC
- Operating condition during the test(s) :
 - . Continuous RF transmitting mode with nominal maximum RF output power.
 - . Operating channel frequency and modulation technology

Mode	Available channel	Frequency	Modulation Technology
IEEE 802.11b	1 ~ 11	2412 ~ 2462 MHz	DSSS
IEEE 802.11g	1 ~ 11	2412 ~ 2462 MHz	OFDM
IEEE 802.11n	1 ~ 11	2412 ~ 2462 MHz	OFDM

- . EUT set condition (Test Software)

Test Software	WL4343WA1
Test Software version	-

6. References Standards

- FCC Part 15 (2009) Subpart C-Intentional Radiator §15.247
- ANSI C 63.10 (2013): American National Standard for Testing Unlicensed Wireless Devices
- KDB 558074 D01 DTS meas Guidance v05r02 (April 2, 2019): Guidance for Performing Compliance Measurements on Digital Transmission Systems (DTS) Operating Under §15.247





7. SUMMARY OF TEST RESULTS

FCC Part Section(s)	Test Description	Test Result
§15.247(a)(2)	6 dB Bandwidth	Pass
§15.247(b)(3)	Conducted Maximum Output Power	Pass
§15.247(e)	Power Spectral Density	Pass
§15.247(d)	Conducted Out of Band Emission Emissions	Pass
§15.207(a)	AC Power line Conducted Emissions	Pass
§15.205, 15.209	Radiated Spurious Emissions	Pass
§15.247(d), 15.205, 15.209	Radiated Restricted Band Edge	Pass



8. 6 dB Bandwidth Measurement

8.1 Operating environment

Temperature : 22.8 °C
 Relative Humidity : 19.1 % R.H.

8.2 Test Set-up (Layout)

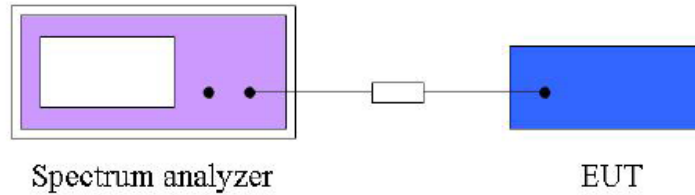

8.3 Limit

For digital modulation systems, the minimum 6 dB bandwidth shall be at least 500 kHz

8.4 Test Equipment used

Model Name	Manufacturer	Description	Serial Number	Due to Calibration
■ - FSV	Rohde & Schwarz	Spectrum Analyzer	101552	Apr. 09, 2022
■ - J12J102248-00-4	JUNFLON	RF Test Cable	SEP-10-14-084	N/A
■ - J12J102248-00-2	JUNFLON	RF Test Cable	SEP-10-14-046	N/A
■ - MODEL 2	Rohde & Schwarz	10 dB attenuator	SEP-10-14-046	Apr. 07, 2022
■ - OSP120	Rohde & Schwarz	Open Switch and control platform	101329	Apr. 09, 2022
■ - WMS 32	Rohde & Schwarz	Testing Software	VER10.40.10	N/A

8.5 Test Test Procedure

- a) Set RBW = 100 kHz.
- b) Set the video bandwidth (VBW) $\geq 3 \times$ RBW.
- c) Detector = Peak.
- d) Trace mode = max hold.
- e) Sweep = auto couple.
- f) Allow the trace to stabilize.
- g) Measure the maximum width of the emission that is constrained by the frequencies associated with the two outermost amplitude points (upper and lower frequencies) that are attenuated by 6 dB relative to the maximum level measured in the fundamental emission.





8.6 Test result

- Test Date : Jan. 11, 2022
- Reference Standard : Part 15 Subpart C, Sec. 15.247(a)(2)
- Test Procedure(s) : ANSI C63.10 (2013), KDB558074 D01 DTS Meas Guidance v05r02(April 2,2019)
- Operating Condition : RF transmitting mode (1 ch: 2 412 MHz, 6 ch: 2 437 MHz, 11 ch: 2 462 MHz)
- Power Source : DC 3.7 V

IEEE 802.11b

Frequency (MHz)	6 dB Bandwidth (MHz)	Band Edge Left (MHz)	Band Edge Right (MHz)	Min. Limit (MHz)	Result
2 412	9.00	2407.25	2416.25	0.50	Complies
2 437	8.30	2432.85	2441.15	0.50	Complies
2 462	9.20	2457.25	2466.45	0.50	Complies

IEEE 802.11g

Frequency (MHz)	6 dB Bandwidth (MHz)	Band Edge Left (MHz)	Band Edge Right (MHz)	Min. Limit (MHz)	Result
2 412	16.00	2404.25	2420.25	0.50	Complies
2 437	16.30	2428.95	2445.25	0.50	Complies
2 462	15.70	2454.25	2469.95	0.50	Complies

IEEE 802.11n

Frequency (MHz)	6 dB Bandwidth (MHz)	Band Edge Left (MHz)	Band Edge Right (MHz)	Min. Limit (MHz)	Result
2 412	15.30	2404.35	2419.65	0.50	Complies
2 437	15.30	2429.35	2444.65	0.50	Complies
2 462	15.30	2454.35	2469.65	0.50	Complies





IEEE 802.11b

6 dB Bandwidth Plot on Configuration : 1 ch

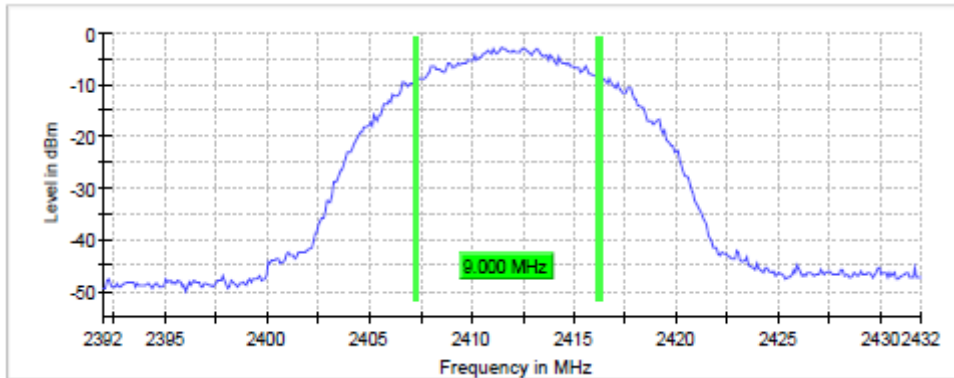

6 dB Bandwidth Plot on Configuration : 6 ch

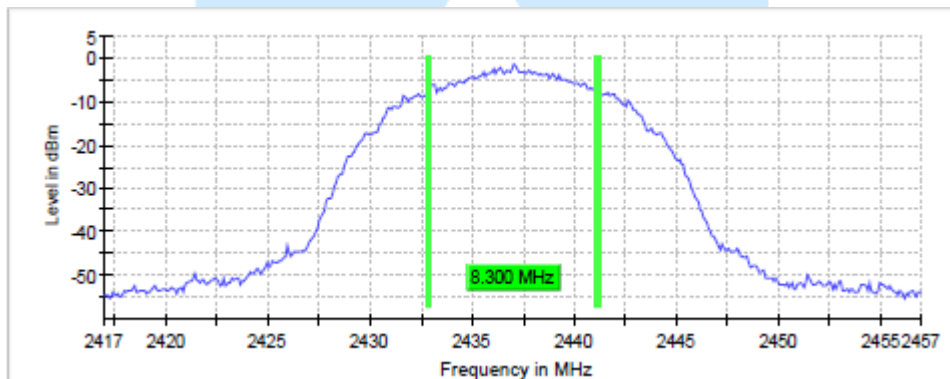

6 dB Bandwidth Plot on Configuration : 11 ch

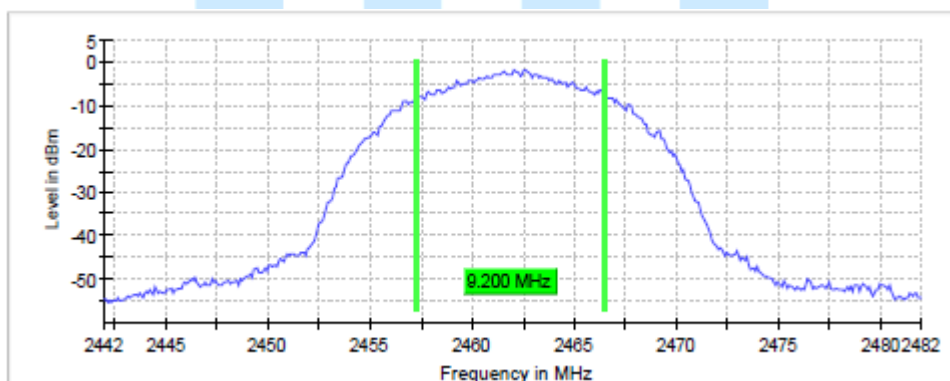



IEEE 802.11g

6 dB Bandwidth Plot on Configuration : 1 ch

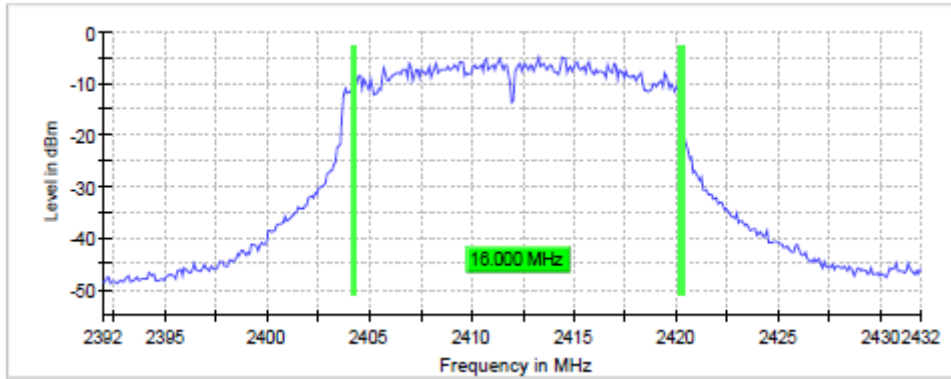

6 dB Bandwidth Plot on Configuration : 6 ch

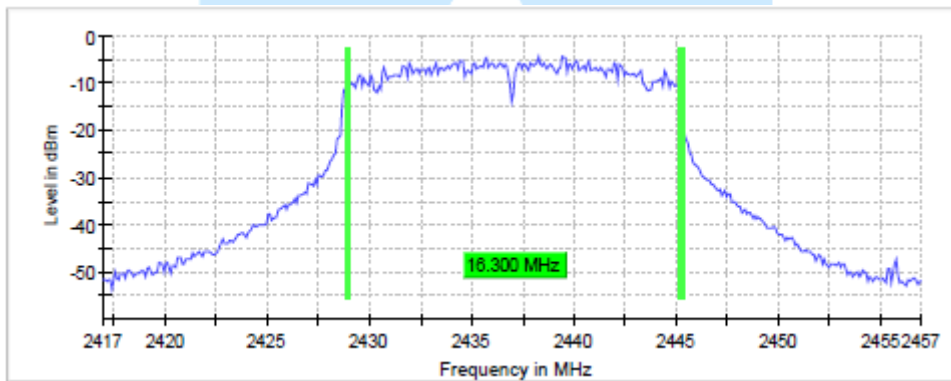

6 dB Bandwidth Plot on Configuration : 11 ch

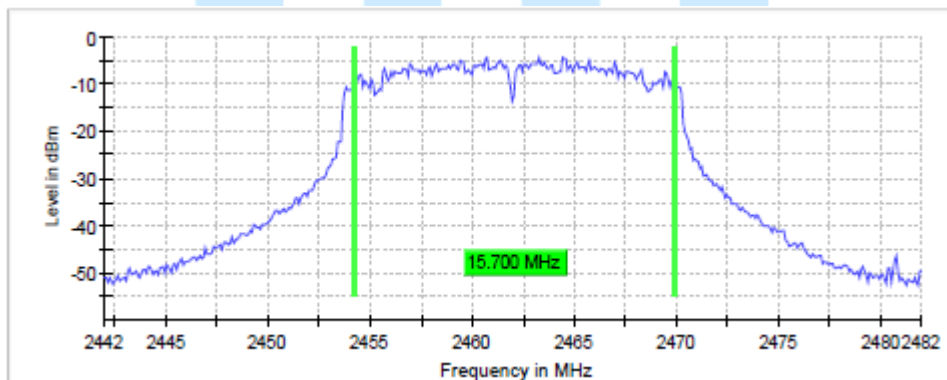



IEEE 802.11n

6 dB Bandwidth Plot on Configuration : 1 ch

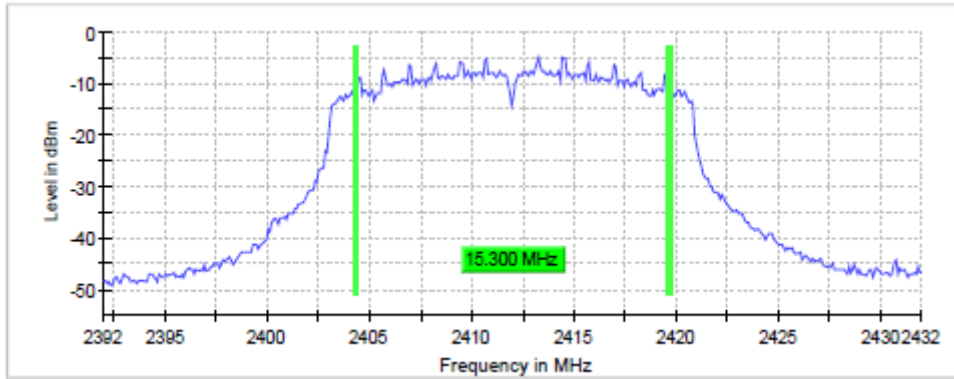

6 dB Bandwidth Plot on Configuration : 6 ch

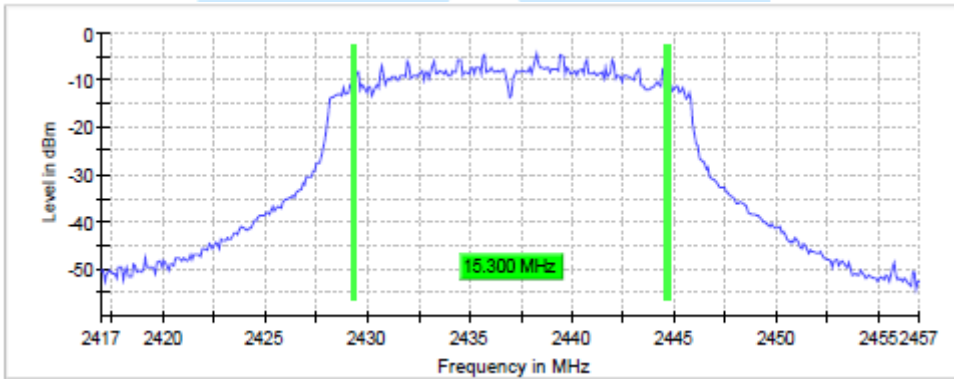

6 dB Bandwidth Plot on Configuration : 11 ch

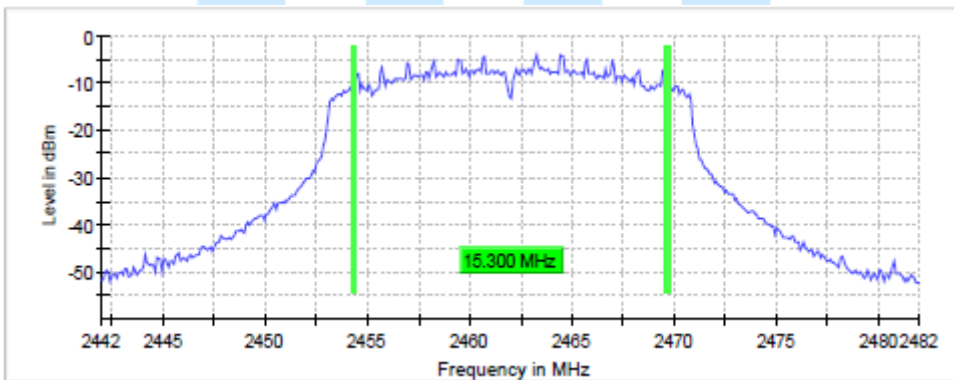



9. Conducted Maximum Output Power Measurement

9.1 Operating environment

Temperature : 22.8 °C
 Relative Humidity : 19.1 % R.H.

9.2 Test Set-up (Layout)

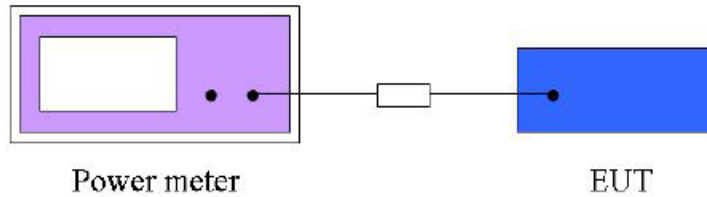

9.3 Limit

For systems using digital modulation in the (2 400~2 483.5) MHz, the limit for peak output power is 30 dBm. The limit has to be reduced by the amount in dB that the gain of the antenna exceeds 6 dBi. In case of point-to-point operation, the limit has to be reduced by 1 dB for every 3 dB that the directional gain of the antenna exceeds 6 dBi.

9.4 Test Equipment used

Model Name	Manufacturer	Description	Serial Number	Due to Calibration
■ - NRVD	Rohde & Schwarz	Dual Channel Power Meter	837794/048	Apr. 15, 2022
■ - NRV-Z32	Rohde & Schwarz	Peak power sensor	100049	Apr. 08, 2022
■ - NRP-Z51	Rohde & Schwarz	Power sensor	1138.0005.02	Apr. 08, 2022

9.5 Test Procedure

A peak power sensor was used on the output port of the EUT. A power meter was used to read the response of the peak power sensor. Record the power level.





9.6 Test Result

- Test Date : Jan. 11, 2022
- Reference Standard : Part 15 Subpart C, Sec. 15.247(b)(3)
- Test Procedure(s) : ANSI C63.10 (2013), KDB558074 D01 DTS Meas Guidance v05r02(April 2,2019)
- Operating Condition : RF transmitting mode (1 ch: 2 412 MHz, 6 ch: 2 437 MHz, 11 ch: 2 462 MHz)
- Power Source : DC 3.7 V

IEEE 802.11b

Frequency (MHz)	Peak Conducted Power (dBm)	Average Conducted Power ¹⁾ (dBm)	Max. Limit (dBm)	Result
2 412	6.7	4.5	30.00	Complies
2 437	7.3	4.7	30.00	Complies
2 462	7.3	5.1	30.00	Complies

Note: 1) The Average output power is reference data for RF Exposure.

IEEE 802.11g

Frequency (MHz)	Peak Conducted Power (dBm)	Average Conducted Power ¹⁾ (dBm)	Max. Limit (dBm)	Result
2 412	15.3	4.9	30.00	Complies
2 437	15.8	5.3	30.00	Complies
2 462	15.8	5.5	30.00	Complies

Note: 1) The Average output power is reference data for RF Exposure.

IEEE 802.11n

Frequency (MHz)	Peak Conducted Power (dBm)	Average Conducted Power ¹⁾ (dBm)	Max. Limit (dBm)	Result
2 412	16.1	4.8	30.00	Complies
2 437	16.5	5.1	30.00	Complies
2 462	16.8	5.5	30.00	Complies

Note: 1) The Average output power is reference data for RF Exposure.





10. Power Spectral Density Measurement

10.1 Operating Environment

Temperature : 22.8 °C
 Relative Humidity : 19.1 % R.H.

10.2 Test Set-up (Layout)

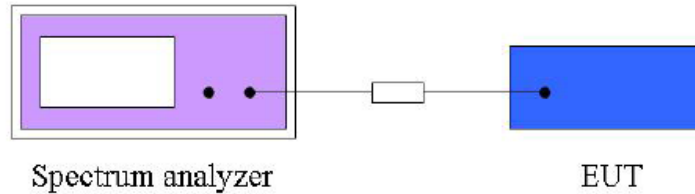

10.3 Limit

For digitally modulated systems, the power spectral density conducted from the intentional radiator to the antenna shall not be greater than 8 dBm in any 3 kHz band during any time interval of continuous transmission

10.4 Test Equipment used

Model Name	Manufacturer	Description	Serial Number	Due to Calibration
■ - FSV	Rohde & Schwarz	Spectrum Analyzer	101552	Apr. 09, 2022
■ - J12J102248-00-4	JUNFLON	RF Test Cable	SEP-10-14-084	N/A
■ - J12J102248-00-2	JUNFLON	RF Test Cable	SEP-10-14-046	N/A
■ - MODEL 2	Rohde & Schwarz	10 dB attenuator	SEP-10-14-046	Apr. 07, 2022
■ - OSP120	Rohde & Schwarz	Open Switch and control platform	101329	Apr. 09, 2022
■ - WMS 32	Rohde & Schwarz	Testing Software	VER10.40.10	N/A

10.5 Test Procedure

- a) Set analyzer center frequency to DTS channel center frequency.
- b) Set the span to 1.5 times the DTS bandwidth.
- c) Set the RBW to 3 kHz
- d) Set the VBW to 10 kHz
- e) Detector = peak.
- f) Sweep time = auto couple.
- g) Trace mode = max hold.
- h) Allow trace to fully stabilize.
- i) Use the peak marker function to determine the maximum amplitude level within the RBW.





10.6 Test Result

- Test Date : Jan. 11, 2022
- Reference Standard : Part 15 Subpart C, Sec. 15.247(e)
- Test Procedure(s) : ANSI C63.10 (2013), KDB558074 D01 DTS Meas Guidance v05r02(April 2,2019)
- Operating Condition : RF transmitting mode (1 ch: 2 412 MHz, 6 ch: 2 437 MHz, 11 ch: 2 462 MHz)
- Power Source : DC 3.7 V

IEEE 802.11b

Frequency (MHz)	PSD (dBm/3kHz)	Max. Limit (dBm/3kHz)	Result
2 412	-3.957	8.00	Complies
2 437	-3.951	8.00	Complies
2 462	-3.626	8.00	Complies

IEEE 802.11g

Frequency (MHz)	PSD (dBm/3kHz)	Max. Limit (dBm/3kHz)	Result
2 412	-6.716	8.00	Complies
2 437	-6.238	8.00	Complies
2 462	-6.120	8.00	Complies

IEEE 802.11n

Frequency (MHz)	PSD (dBm/3kHz)	Max. Limit (dBm/3kHz)	Result
2 412	-6.895	8.00	Complies
2 437	-6.420	8.00	Complies
2 462	-6.077	8.00	Complies





Power Density Plot on configuration : IEEE 802.11b 1 ch

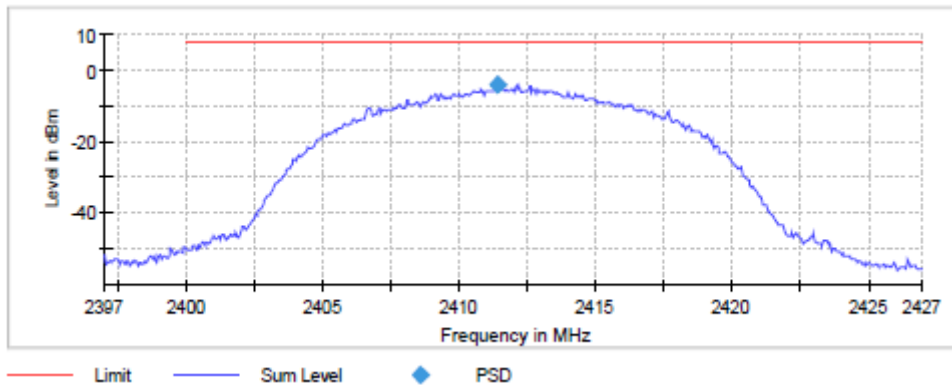

Power Density Plot on configuration : IEEE 802.11b 6 ch

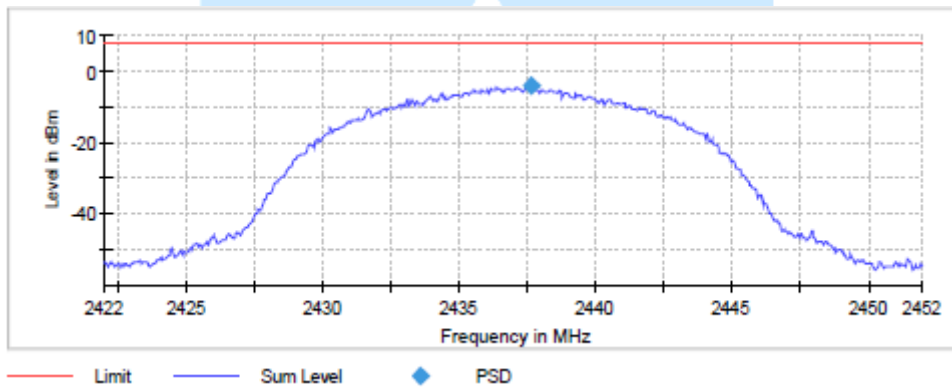

Power Density Plot on configuration : IEEE 802.11b 11 ch

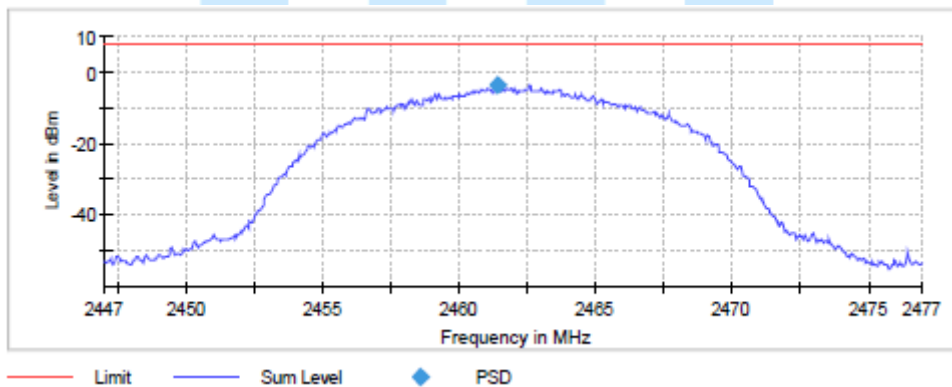



Power Density Plot on configuration : IEEE 802.11g 1 ch

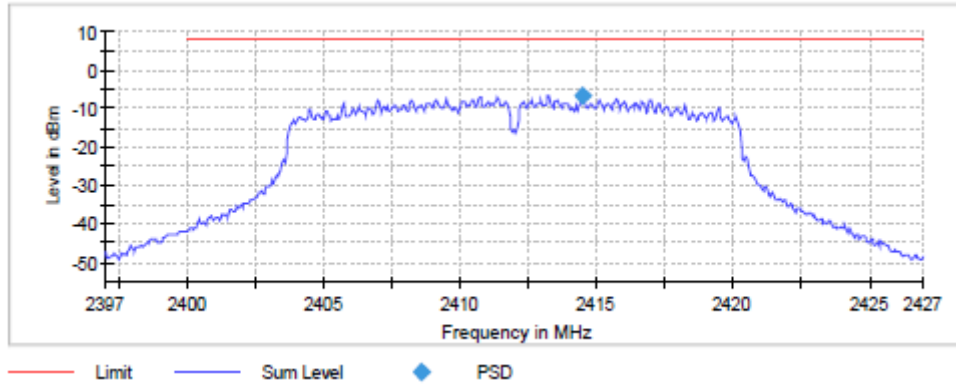

Power Density Plot on configuration : IEEE 802.11g 6 ch

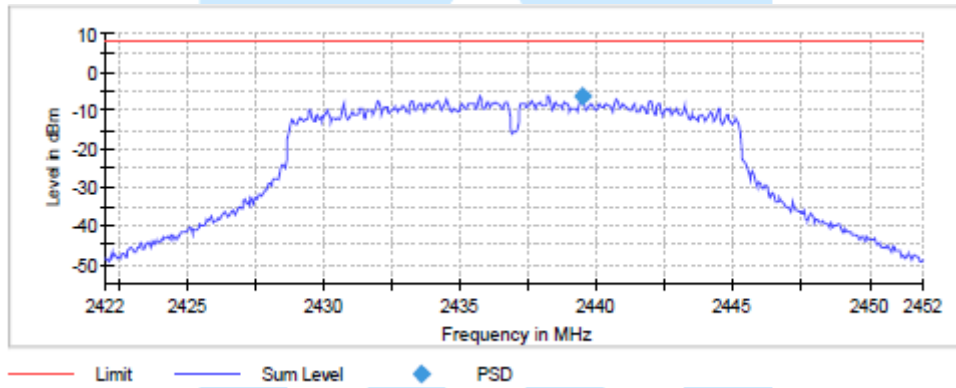

Power Density Plot on configuration : IEEE 802.11g 11 ch

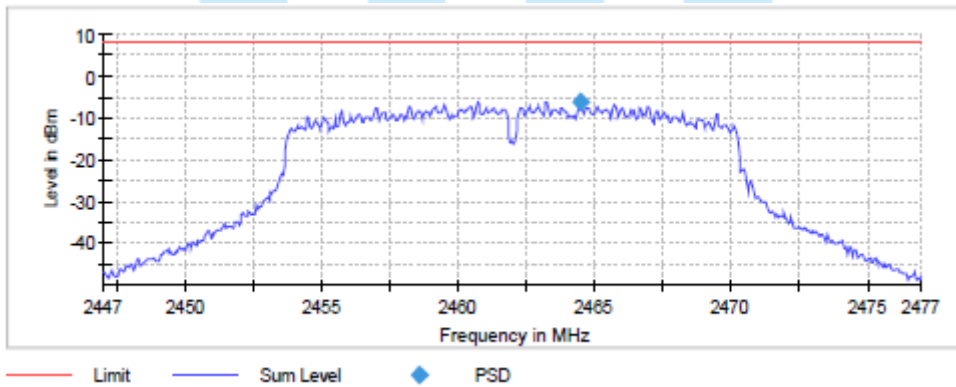



Power Density Plot on configuration : IEEE 802.11n 1 ch

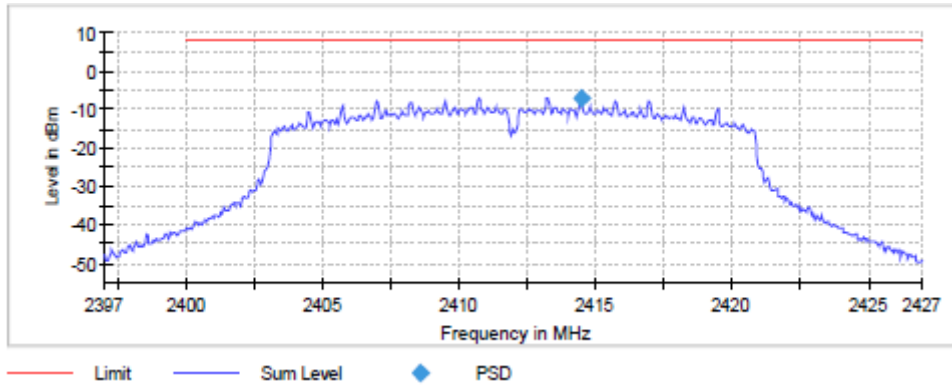

Power Density Plot on configuration : IEEE 802.11n 6 ch

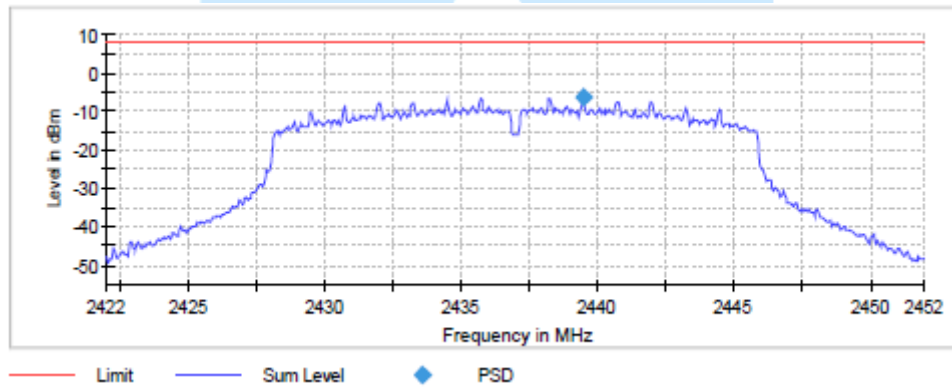

Power Density Plot on configuration : IEEE 802.11n 11 ch

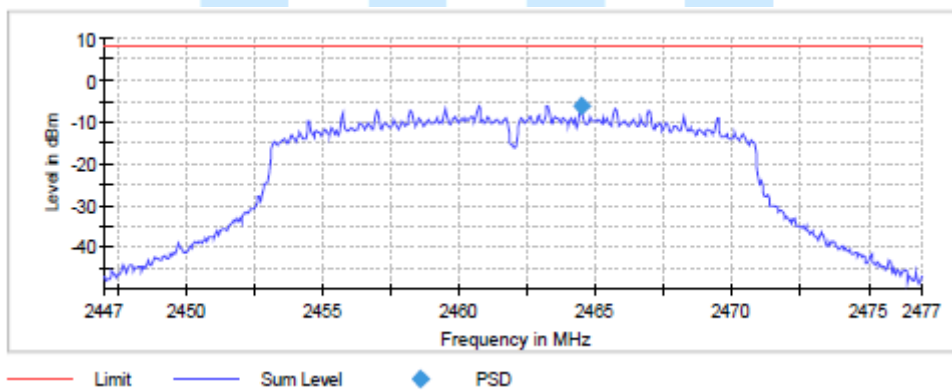



11. Conducted Spurious Emission & Out of Band Emission

11.1 Operating environment

Temperature : 22.8 °C
 Relative Humidity : 19.1 % R.H.

11.2 Test set-up (Lay-out)

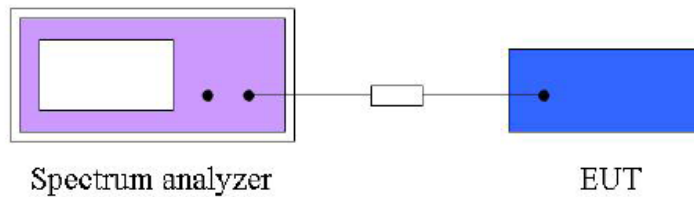

11.3 Limit

Below -20 dB of the highest emission level of operating band (in 100 kHz resolution band width)

11.4 Test equipment used

Model Name	Manufacturer	Description	Serial Number	Due to Calibration
■ - FSV	Rohde & Schwarz	Spectrum Analyzer	101552	Apr. 09, 2022
■ - J12J102248-00-5	JUNFLON	RF Test Cable	JUL-06-14-106	N/A
■ - 56-10	Weinschel	Attenuator	53184	Apr. 09, 2022

11.5 Test Procedure

- a) Set analyzer center frequency to DTS channel center frequency.
- b) Set the span to 1.5 times the DTS bandwidth.
- c) Set the RBW to 3 kHz
- d) Set the VBW to 10 kHz
- e) Detector = peak.
- f) Sweep time = auto couple.
- g) Trace mode = max hold.
- h) Allow trace to fully stabilize.
- i) Use the peak marker function to determine the maximum amplitude level within the RBW.





11.6 Test Result

- Test Date : Jan. 11, 2022
- Reference standard : Part 15 Subpart C, Sec. 15.247(d)
- Test Procedure(s) : ANSI C63.10 (2013), KDB558074 D01 DTS Meas Guidance v05r02(April 2,2019)
- Operating condition : RF transmitting mode (1 ch: 2 412 MHz, 6 ch: 2 437 MHz, 11 ch: 2 462 MHz)
- Power Source : DC 3.7 V

Conducted Spurious Emission

IEEE 802.11b

Operating Frequency (MHz)	Fundamental Level (dBm)	Spurious Level (dBm)	Deviation (dBc)	Limits (dBc)	Result
2 412	-1.47	-40.44	-38.97	-20.00	Complies
2 437	-1.77	-40.60	-38.83		Complies
2 462	-1.16	-40.64	-39.48		Complies

IEEE 802.11g

Operating Frequency (MHz)	Fundamental Level (dBm)	Spurious Level (dBm)	Deviation (dBc)	Limits (dBc)	Result
2 412	-4.17	-40.77	-36.60	-20.00	Complies
2 437	-3.55	-40.67	-37.12		Complies
2 462	-3.50	-40.30	-36.80		Complies

IEEE 802.11n

Operating Frequency (MHz)	Fundamental Level (dBm)	Spurious Level (dBm)	Deviation (dBc)	Limits (dBc)	Result
2 412	-4.35	-41.26	-36.91	-20.00	Complies
2 437	-3.74	-41.20	-37.46		Complies
2 462	-3.47	-39.47	-36.00		Complies





Conducted Out of Band(Band Edge) Emission

IEEE 802.11b

Operating Frequency (MHz)	Fundamental Level (dBm)	Bandedge Level (dBm)	Deviation (dBc)	Limits (dBc)	Result
2 412	-1.47	-46.29	-44.82	-20.00	Complies
2 462	-1.16	-48.60	-47.44		Complies

IEEE 802.11g

Operating Frequency (MHz)	Fundamental Level (dBm)	Bandedge Level (dBm)	Deviation (dBc)	Limits (dBc)	Result
2 412	-4.17	-38.98	-34.81	-20.00	Complies
2 462	-3.50	-47.41	-43.91		Complies

IEEE 802.11n

Operating Frequency (MHz)	Fundamental Level (dBm)	Bandedge Level (dBm)	Deviation (dBc)	Limits (dBc)	Result
2 412	-4.35	-38.50	-34.15	-20.00	Complies
2 462	-3.47	-47.85	-44.38		Complies

Conducted spurious Emission Plot on Configuration : IEEE 802.11b 1 ch

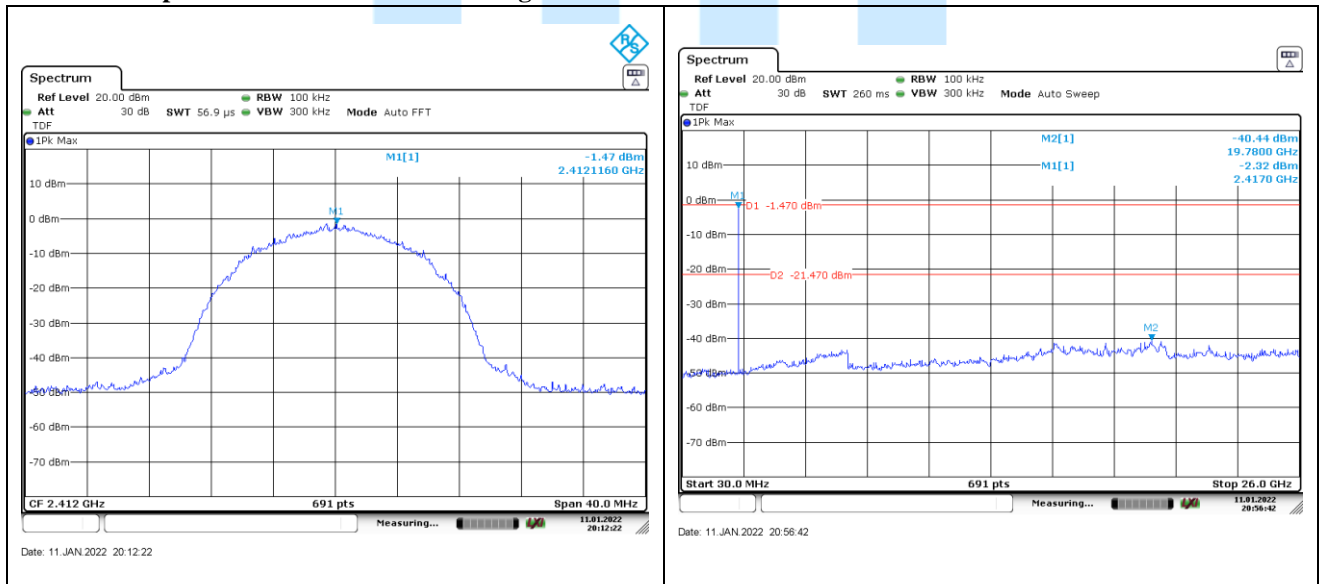



Conducted spurious Emission Plot on Configuration : IEEE 802.11b 6 ch

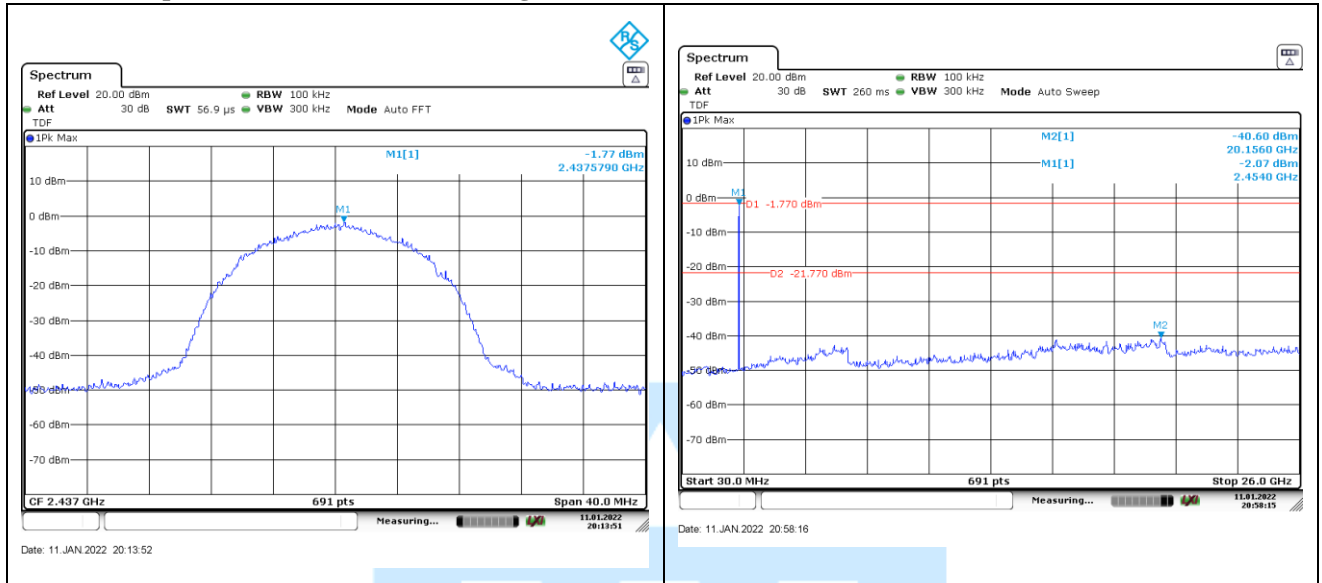

Conducted spurious Emission Plot on Configuration : IEEE 802.11b 11 ch

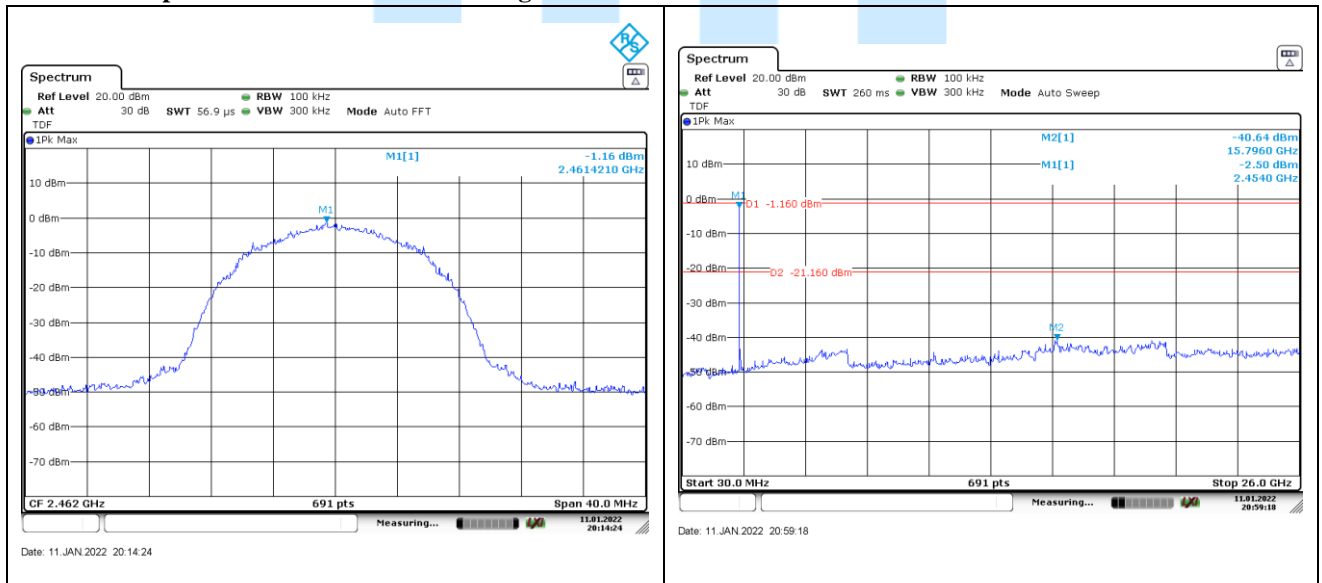



Conducted spurious Emission Plot on Configuration : IEEE 802.11g 1 ch

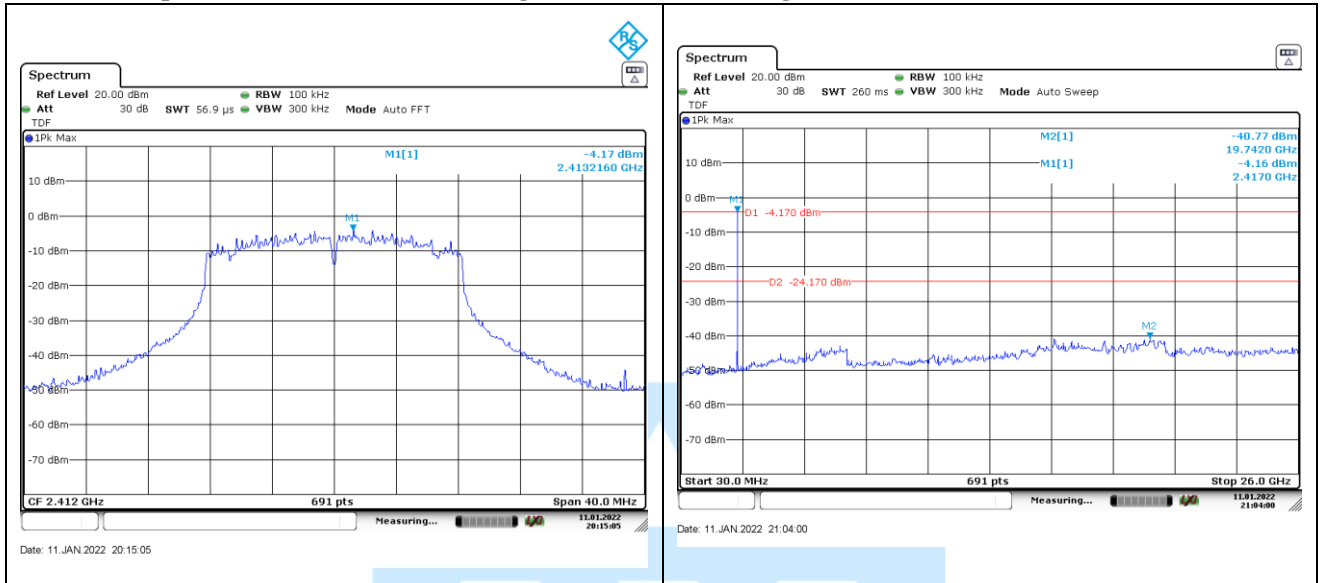

Conducted spurious Emission Plot on Configuration : IEEE 802.11g 6 ch

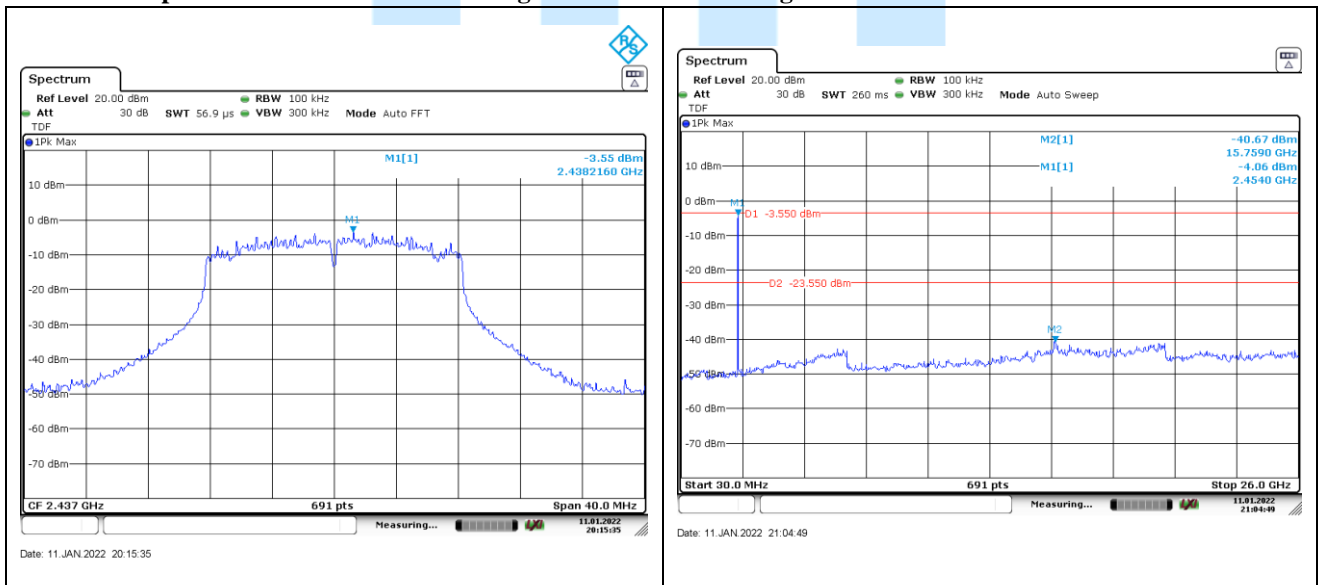



Conducted spurious Emission Plot on Configuration : IEEE 802.11g 11 ch

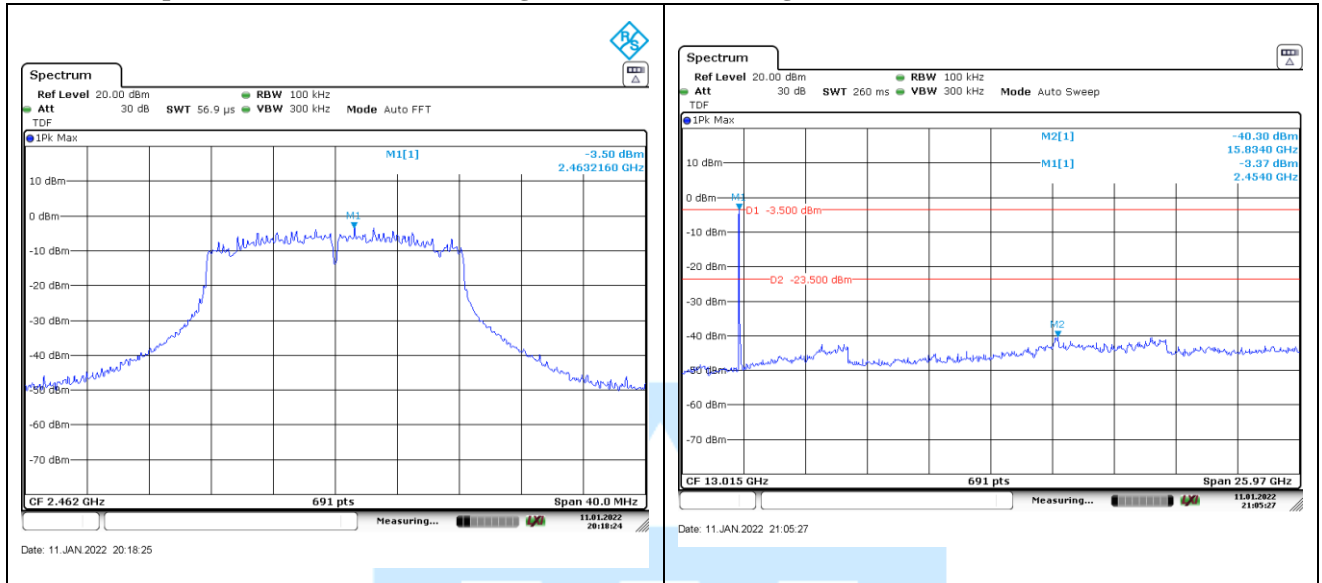

Conducted spurious Emission Plot on Configuration : IEEE 802.11n 1 ch

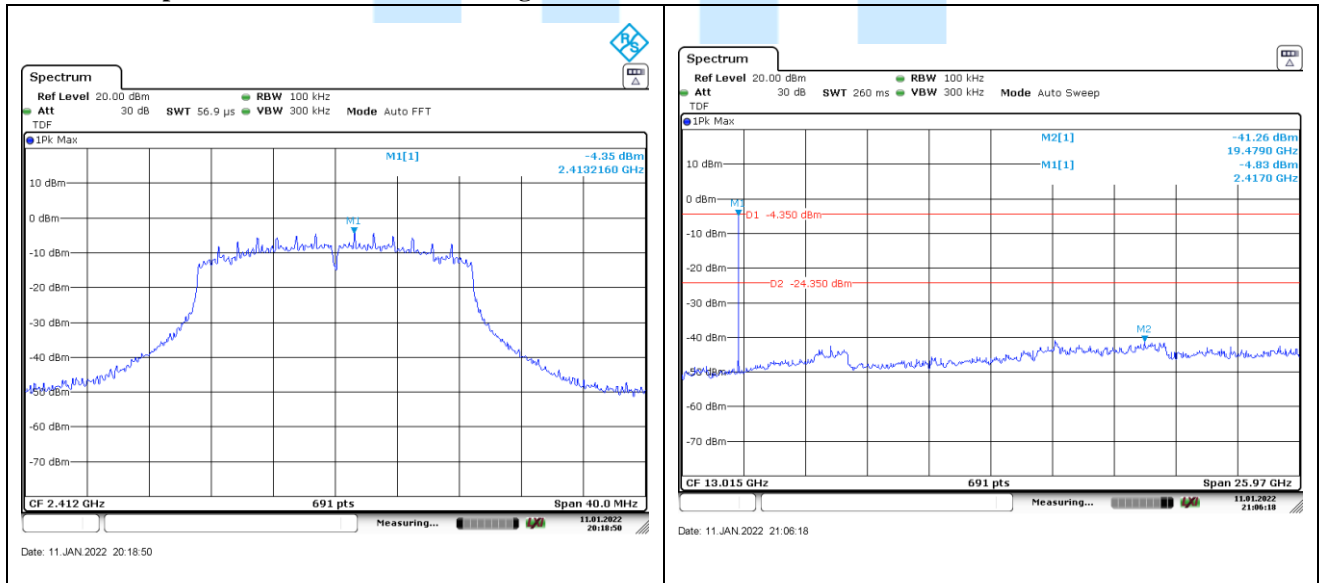



Conducted spurious Emission Plot on Configuration : IEEE 802.11n 6 ch

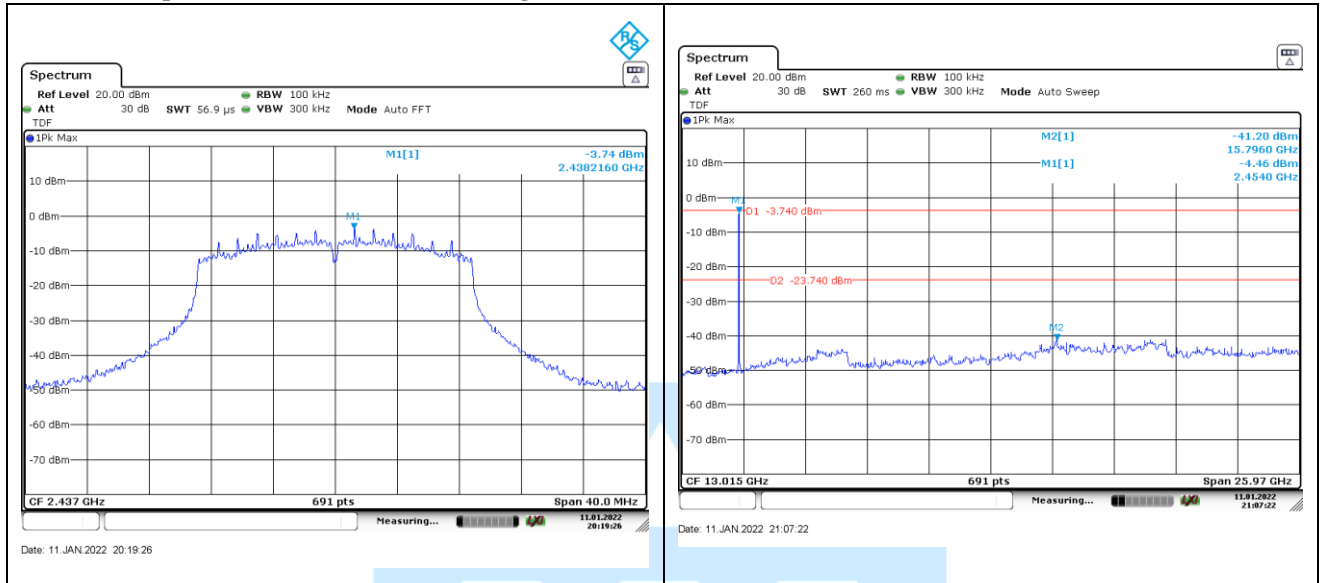

Conducted spurious Emission Plot on Configuration : IEEE 802.11n 11 ch

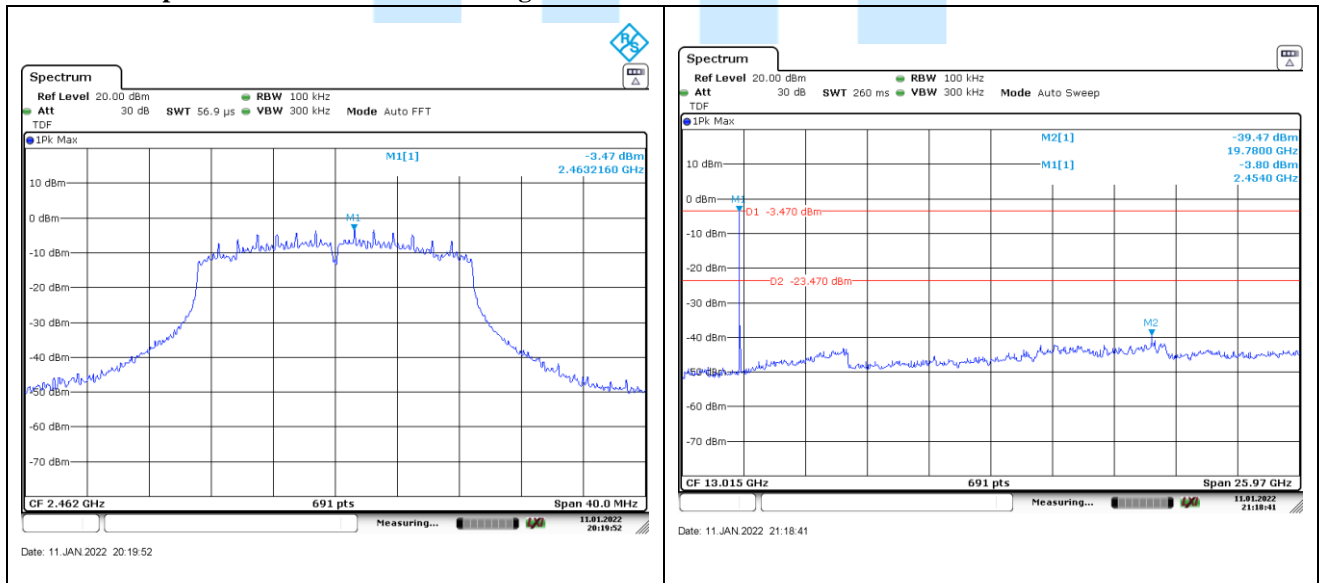



Low Band Edge Plot on Configuration : IEEE 802.11b 1 ch

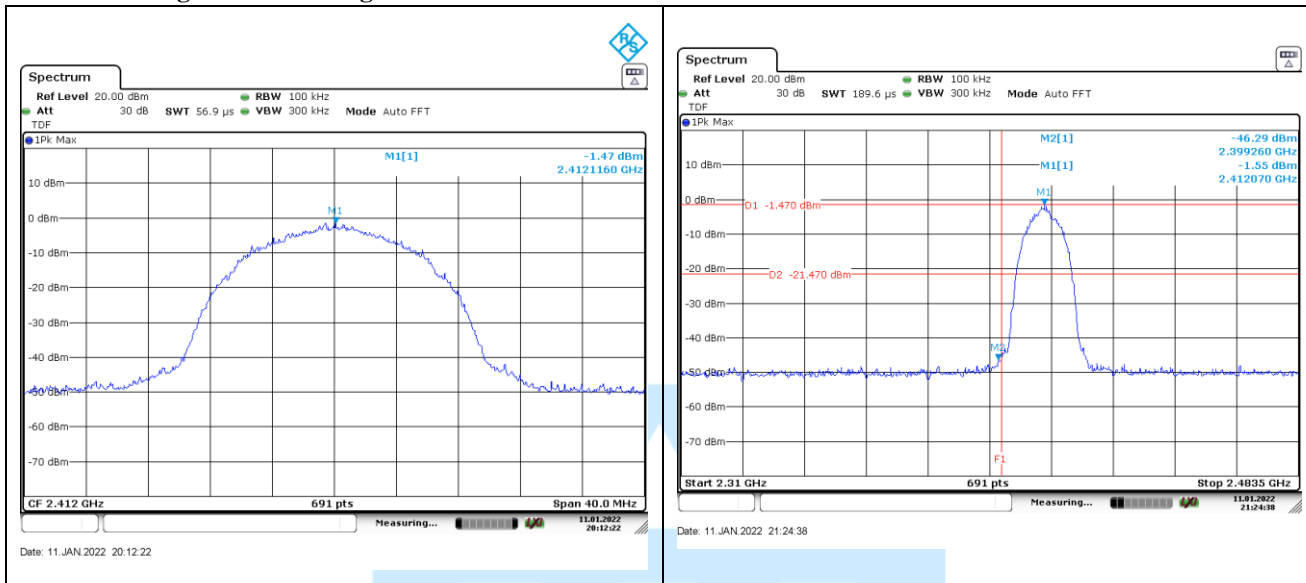

High Band Edge Plot on Configuration : IEEE 802.11b 11 ch

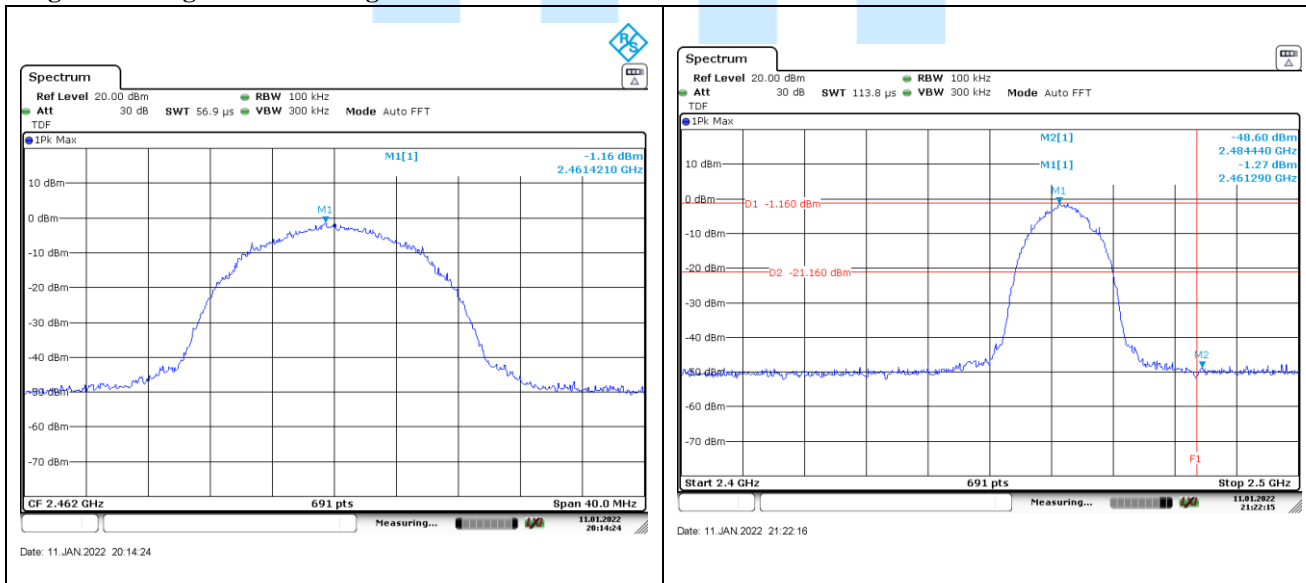



Low Band Edge Plot on Configuration : IEEE 802.11g 1 ch

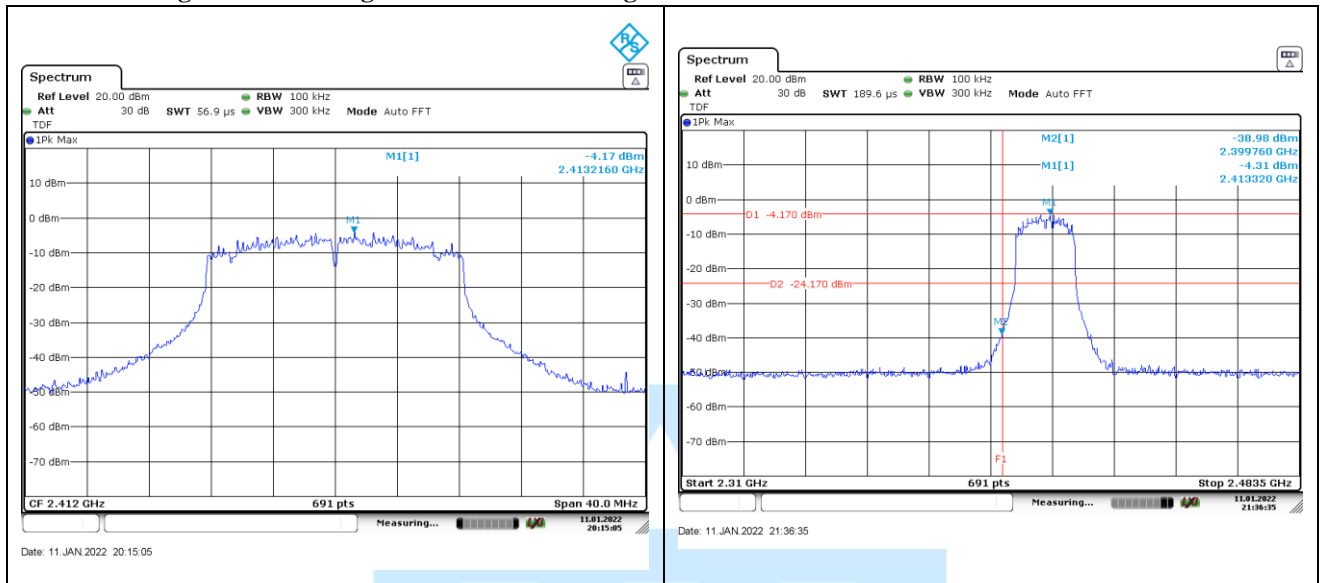

High Band Edge Plot on Configuration : IEEE 802.11g 11 ch

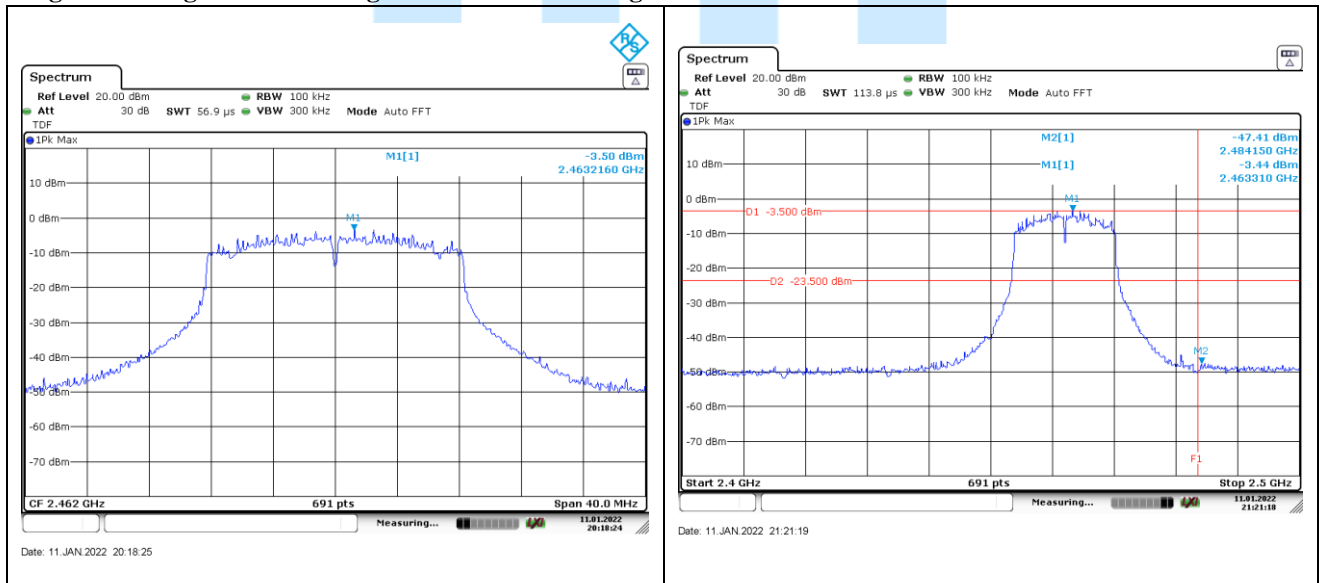



Low Band Edge Plot on Configuration : IEEE 802.11n 1 ch

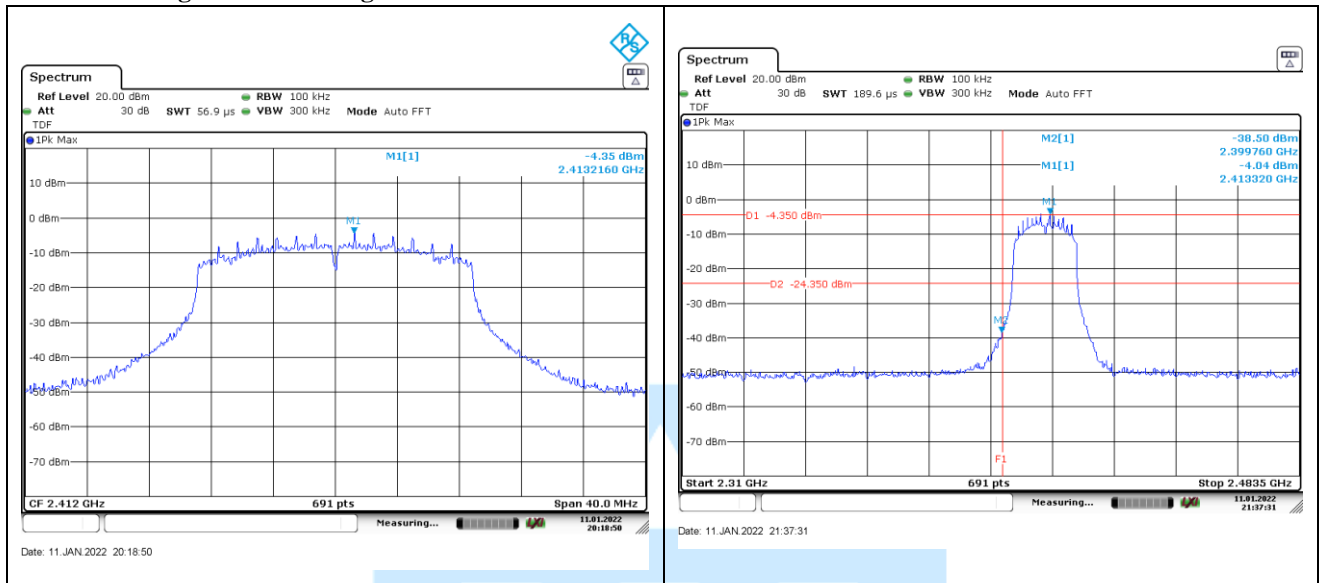

High Band Edge Plot on Configuration : IEEE 802.11n 11 ch

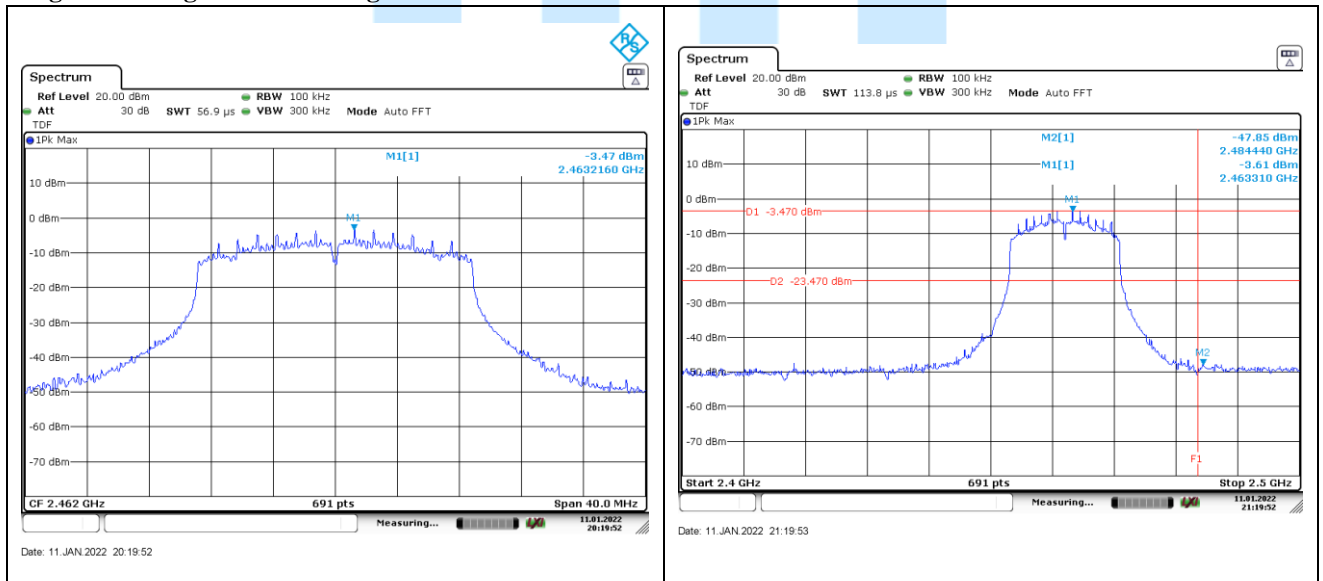



12. AC Power line Conducted emission

-Test Description

The Line conducted emission test facility is inside a 4 m × 8 m × 2.5 m shielded enclosure. (Test firm Registration Number: 269701)

The EUT was placed on a non-conducting 1.0 m by 1.5 m table, which is 0.8 m in height and 0.4 m away from the vertical wall of the shielded enclosure.

The EUT is powered from the Rohde & Schwarz LISN (ENV216) and the support equipment is powered from the Rohde & Schwarz LISN (ENV216). Powers to the LISN are filtered by high-current high insertion loss power line filter.

Sufficient time for EUT, support equipment, and test equipment was allowed in order for them to warm up to their normal operating condition.

The RF output of the LISN was connected to the EMI test receiver (Rohde & Schwarz, ESCI).

Exploratory measurements were conducted to identify the highest emission by operating the EUT in a range of typical modes of operation, cable positions, system configuration and arrangement.

Based on exploratory measurements, the final measurements were conducted at the worst test conditions.

Exploratory measurements were scanned using Peak mode of EMI Test receiver from 150 kHz to 30 MHz with 20 ms sweep time. The final measurements were measured with Quasi-Peak and Average mode.

The bandwidth of EMI Test Receiver was set to 9 kHz. Interface cables were connected to the available interface ports of the test unit. Excess cable lengths were bundled at center with 30 cm ~ 40 cm.

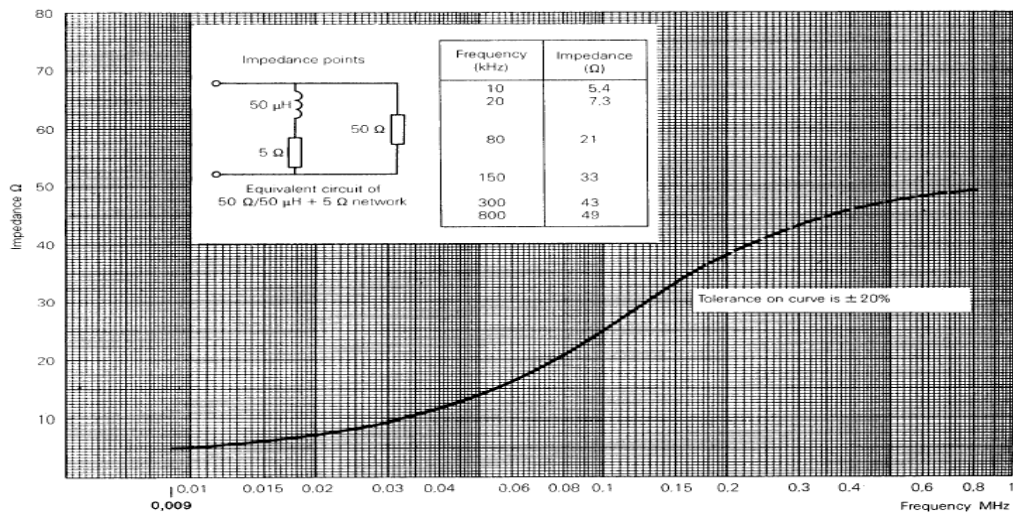

Fig 2. Impedance of LISN





12.1 Operating Environment

Temperature : 23.8 °C
Relative Humidity : 50.6 % R.H.

12.2 Test Set-up

The conducted emission measurements were performed in the shielded room.

The EUT was placed on wooden table, 0.8 m heights above the floor, 0.4 m from the reference ground plane (GRP) wall and 0.8 m from AMN & ISN.

AMN is bonded on horizontal reference ground plane.

The ground plane, which was electrically bonded to the shield room, ground system and all power lines entering the shield room, were filtered.

12.3 Measurement Uncertainty

The measurement uncertainty was calculated in accordance with ISO “Guide to the expression of uncertainty in measurement.”

The measurement uncertainty was given with a confidence of 95 %.

Test Items	Uncertainty	Remark
Conducted emission (9 kHz ~ 150 kHz)	3.78 dB	Confidence level of approximately 95 % ($k = 2$)
Conducted emission (150 kHz ~ 30 MHz)	3.31 dB	Confidence level of approximately 95 % ($k = 2$)

Where relevant, the following measurement uncertainty levels have been estimated for tests performed on the EUT as specified in CISPR 16-4-2.

The listed uncertainties are the worst case uncertainty for the entire range of measurement. please note that the uncertainty values are provided for informational purposes only are not used in determining the PASS/FAIL results



12.4 Limit

RFI Conducted	FCC Limit(dB μ V/m) Class B	
	Quasi-Peak	Average
150 kHz ~ 0.5 MHz	66 ~ 56*	56 ~ 46*
0.5 MHz ~ 5 MHz	56	46
5 MHz ~ 30 MHz	60	50

*Limits decreases linearly with the logarithm of frequency.

12.5 Test Equipment used

Model Name	Manufacturer	Description	Serial Number	Due to Calibration
<input checked="" type="checkbox"/> - ESCI	Rohde & Schwarz	EMI test receiver	100237	Apr. 05, 2023
<input type="checkbox"/> - ENV216	Rohde & Schwarz	LISN	100172	Apr. 05, 2023
<input checked="" type="checkbox"/> - ENV216	Rohde & Schwarz	LISN	100173	Apr. 05, 2023
<input type="checkbox"/> - EMC 32	Rohde & Schwarz	Testing Software	VER8.53	N/A

12.6 Test data for Conducted Emission

- Test Date : Aug. 30, 2022
- Reference Standard : FCC Part 15 subpart B, Sec. 15.207(a)
- Test Procedure(s) : ANSI C63.10 (2013)
- Operating Condition : Charge mode
- Power Source : AC 120 V / 60 Hz (EUT power: DC 3.7 V)
- Frequency rage : 0.15 MHz to 30 MHz
- Line : AC power line (L, N)
- Comment : -





AC power line Conducted Emission

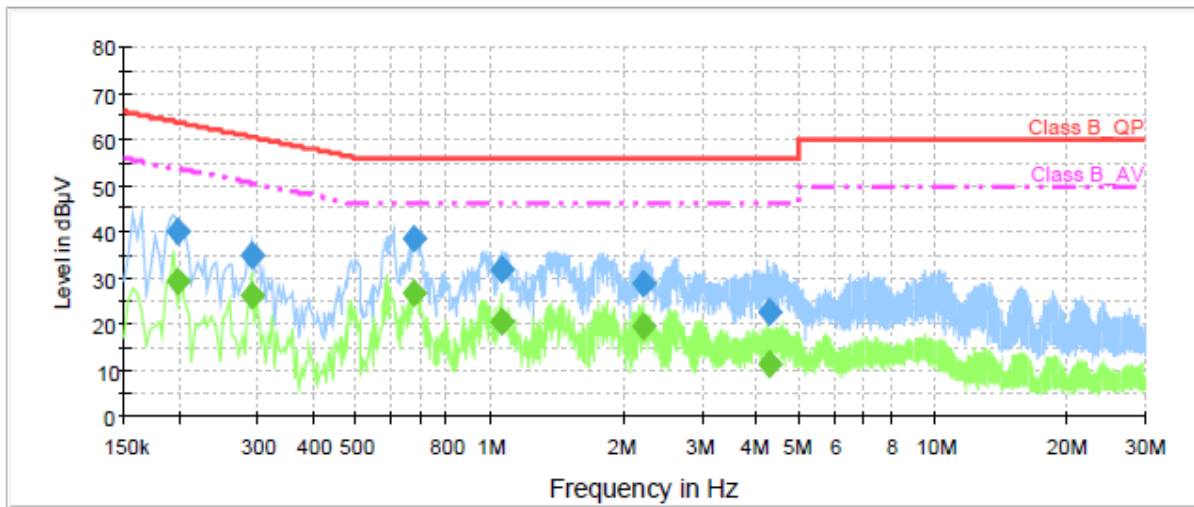

— Class B_QP [..EMI conducted]
- - - Class B_AV [..EMI conducted]
— Preview Result 1-PK+ [Preview Result 1.Result:2]
— Preview Result 2-AVG [Preview Result 2.Result:4]
◆ Final Result 1-QPK [Final Result 1.Result:1]
◆ Final Result 2-CAV [Final Result 2.Result:1]

Frequency (MHz)	QuasiPeak (dBµV)	Meas. Time (ms)	Bandwidth (kHz)	Filter	Line	Corr. (dB)	Margin (dB)	Limit (dBµV)	Comment
0.198000	40.2	1000.0	9.000	Off	L1	9.7	23.5	63.7	
0.291788	34.7	1000.0	9.000	Off	L1	9.7	25.9	60.6	
0.678375	38.2	1000.0	9.000	Off	L1	9.7	17.8	56.0	
1.061888	31.6	1000.0	9.000	Off	L1	9.7	24.4	56.0	
2.215919	28.6	1000.0	9.000	Off	L1	9.8	27.4	56.0	
4.257719	22.4	1000.0	9.000	Off	N	9.9	33.6	56.0	

Frequency (MHz)	CAverage (dBµV)	Meas. Time (ms)	Bandwidth (kHz)	Filter	Line	Corr. (dB)	Margin (dB)	Limit (dBµV)	Comment
0.198000	29.2	1000.0	9.000	Off	L1	9.7	24.5	53.7	
0.291788	26.3	1000.0	9.000	Off	L1	9.7	24.0	50.6	
0.678375	26.6	1000.0	9.000	Off	L1	9.7	19.4	46.0	
1.061888	20.7	1000.0	9.000	Off	L1	9.7	25.3	46.0	
2.215919	19.2	1000.0	9.000	Off	L1	9.8	26.8	46.0	
4.257719	11.5	1000.0	9.000	Off	N	9.9	34.5	46.0	





13. Radiated Spurious & Restricted Band Edge Emission

Exploratory Radiated measurements were conducted at the 3m semi anechoic chamber in order to identify the highest emission by operating the EUT in a range of typical modes of operation, cable positions, system configuration and arrangement.

Based on exploratory measurements, the final measurements were conducted at the worst test conditions.

Final measurements of below 1GHz were made at 3m or 10 m Chamber that complies with CISPR 16/ANSI C63.10. Above 1GHz final measurements were conducted at the 3m Chamber only.

For measurements above 1GHz, the bottom side of 3m chamber was installed with absorbers in order to meet SVSWR Limit.

Exploratory measurements were scanned using Peak mode of EMI Test receiver and final measurements were measured with Quasi-Peak mode (Below 1GHz) and Peak & Average mode (Above 1GHz).

The measurements were performed by rotating the EUT 360° and adjusting the receive antenna height from 1.0 m to 4.0 m. All frequencies were investigated in both horizontal and vertical antenna polarity.

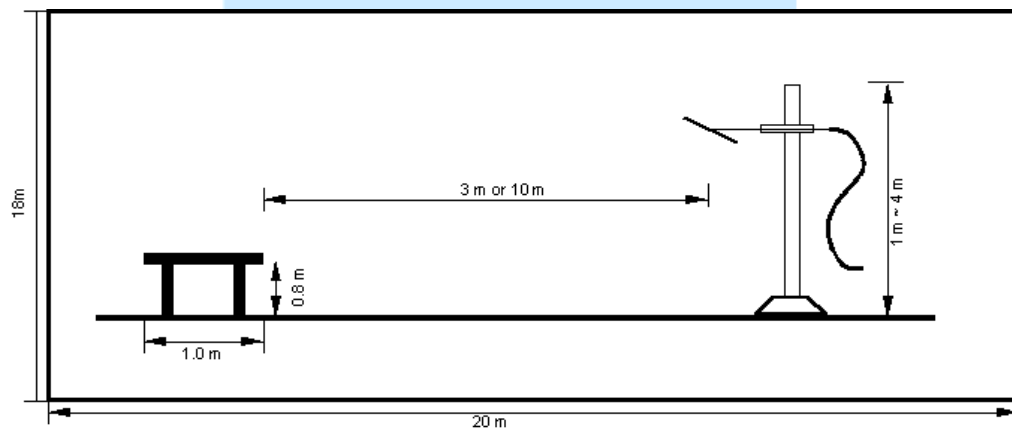

Fig 3. Dimensions of test site (Below 1GHz)

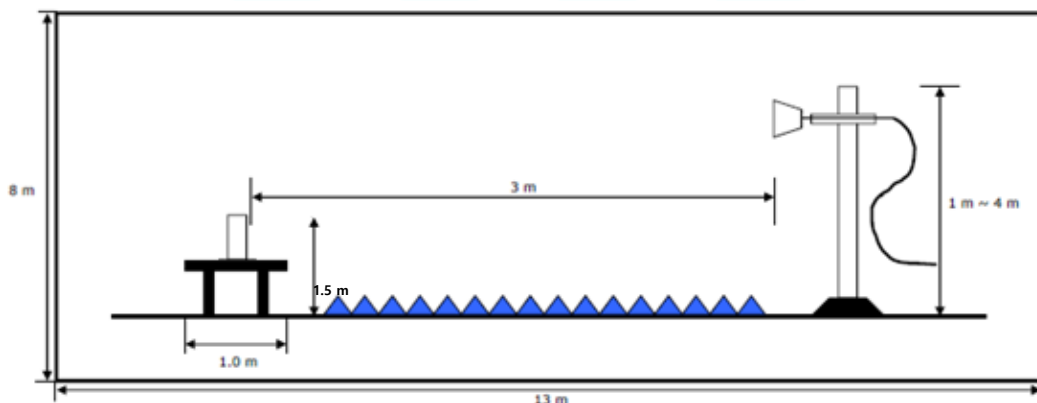

Fig 4. Dimensions of test site (Above 1GHz)





13.1 Operating environment

Temperature : 23.7 °C
 Relative humidity : 29.1 % R.H.

13.2 Test set-up

A preliminary and final measurement was at 3 m anechoic chamber.
 The EUT was placed on a non-conducting table.
 For emissions testing at or below 1 GHz, the table height is 80 cm above the reference ground plane.
 For emission measurements above 1 GHz, the table height is 1.5 m above the reference ground plane.

The turntable with EUT was rotated 360°, and the antenna was varied in height between 1.0 m and 4.0 m in order to determine the maximum emission levels.
 This procedure was performed for both horizontal and vertical polarization of the receiving antenna.

13.3 Measurement uncertainty

The measurement uncertainty was calculated in accordance with ISO “Guide to the expression of uncertainty in measurement”.
 The measurement uncertainty was given with a confidence of 95 %.

Test items(Anechoic Chamber)	Uncertainty	Remark
Radiated emission (30 MHz ~ 300 MHz, 3 m, Vertical)	5.14 dB	Confidence level of approximately 95 % ($k = 2$)
Radiated emission (30 MHz ~ 300 MHz, 3 m, Horizontal)	5.10 dB	Confidence level of approximately 95 % ($k = 2$)
Radiated emission (300 MHz ~ 1 000 MHz, 3 m, Vertical)	6.05 dB	Confidence level of approximately 95 % ($k = 2$)
Radiated emission (300 MHz ~ 1 000 MHz, 3 m, Horizontal)	5.19 dB	Confidence level of approximately 95 % ($k = 2$)
Radiated emission (1 000 MHz ~ 6 000 MHz, 3 m, V/H)	5.20 dB	Confidence level of approximately 95 % ($k = 2$)
Radiated emission (6 000 MHz ~ 18 000 MHz, 3 m, V/H)	5.20 dB	Confidence level of approximately 95 % ($k = 2$)
Radiated emission (18 000 MHz ~ 26 000 MHz, 3 m, V/H)	5.53 dB	Confidence level of approximately 95 % ($k = 2$)

Where relevant, the following measurement uncertainty levels have been estimated for tests performed on the EUT as specified in CISPR 16-4-2.

The listed uncertainties are the worst case uncertainty for the entire range of measurement. please note that the uncertainty values are provided for informational purposes only are not used in determining the PASS/FAIL results





13.4 Limit

20 dB in any 100 kHz bandwidth outside the operating frequency band. In case the emission fall within the restricted band specified on 15.205(a) limit in the table below has to be followed.

Frequencies (MHz)	Field Strength (microvolt/meter)	Measurement Distance (meters)
0.009 ~ 0.490	2 400/F (kHz)	300
0.490 ~ 1.705	2 400/F (kHz)	30
1.705 ~ 30.0	30	30
30 ~ 88	100	3
88 ~ 216	150	3
216 ~ 960	200	3
Above 960	500	3

13.5 Test Equipment used

Model Name	Manufacturer	Description	Serial Number	Due to Calibration
■ - ESU40	Rohde & Schwarz	EMI Test Receiver	100266	Apr. 08, 2022
■ - HFH2-Z2	Rohde & Schwarz	Loop Antenna	100041	Apr. 28, 2023
■ - VULB9160	Schwarzbeck	Broadband Test Antenna	3313	Sep. 28, 2023
■ - BBHA9120D	Schwarzbeck	Horn Antenna	207	Sep. 15, 2022
■ - BBHA9170	Schwarzbeck	Horn Antenna	766	Nov. 24, 2022
■ - MCU066	maturo GmbH	Position Controller	1390306	N/A
■ - TT2.5SI	maturo GmbH	Turntable	1390307	N/A
■ - CO3000	Innco system GmbH	Position Controller	CO3000/1804/4 2760218/P	N/A
■ - MA4640-XP-ET	Innco system GmbH	Antenna Mast	5580916	N/A
■ - TK-PA18H	TESTEK	Low Noise Amplifier	180001-L	Apr. 09, 2022
■ - TK-PA1840H	TESTEK	Amplifier	170007-L	Apr. 09, 2022
■ - WHKX3.0/18G-10SS	WAINWRIGHT INSTRUMENTS	High pass filter	SN31	Apr. 07, 2022
■- EMC 32	Rohde & Schwarz	Testing Software	VER10.50.10	N/A





13.6 Test data for Radiated Spurious Emission

- Test Date : Jan. 11 ~ 13, 2022
- Reference Standard : Part 15 Subpart C, Sec. 15.247(d)
- Measuring Distance : 3 m
- Resolution Bandwidth : 200 Hz, 9 kHz(Below 30 MHz) / 120 kHz(30 MHz ~ 1GHz) / 1 MHz(Above 1GHz)
- Detector mode : Quasi Peak detector mode / Peak detector mode / Average detector mode
- Power Source : DC 3.7 V
- Note : Through three orthogonal axes were investigated and the worst case is report

IEEE 802.11b

Radiated Spurious Emission (9 kHz to 1 000 MHz)

Ch.	Frequency [MHz]	Pol.	Reading [dBuV]	Transducer Factor [dB]	Test Result [dBuV/m]	Limits [dBuV/m]	Margin [dB]	Detector Type
1	0.82	V	23.82	19.40	43.22	49.23	6.00	QPK
	0.93	V	20.47	19.50	39.97	48.15	8.18	QPK
	599.98	H	13.98	25.90	39.88	46.02	6.14	QPK
6	0.82	V	23.78	19.40	43.18	49.22	6.04	QPK
	0.91	V	20.16	19.50	39.66	48.37	8.71	QPK
	599.98	H	13.44	25.90	39.34	46.02	6.68	QPK
	876.21	H	6.83	30.60	37.43	46.02	8.59	QPK
11	0.82	V	23.41	19.40	42.81	49.30	6.49	QPK
	0.87	V	20.31	19.50	39.81	48.73	8.91	QPK

Radiated Spurious Emission (1 GHz to 26 GHz)

Ch.	Frequency [MHz]	Pol.	Frequency Component	Reading [dBuV]	Transducer Factor [dB]	Test Result [dBuV/m]	Limits [dBuV/m]	Margin [dB]	Detector Type
1						N/A ¹⁾			
6						N/A ¹⁾			
11						N/A ¹⁾			

Note 1)

Since there is a margin of more than 10dB, the result value is expressed as N/A.

Note 2)

Test Result = Reading + Transducer Factor

Where, Transducer Factor = ACF + CL

ACF = Antenna Collection Factor

CL = Cable loss + Preamplifier gain + High Pass Filter

Pol.: H(Horizontal), V(Vertical)





IEEE 802.11g

Radiated Spurious Emission (9 kHz to 1 000 MHz)

Ch.	Frequency [MHz]	Pol.	Reading [dBuV]	Transducer Factor [dB]	Test Result [dBuV/m]	Limits [dBuV/m]	Margin [dB]	Detector Type
1	0.82	V	23.43	19.40	42.83	49.25	6.42	QPK
	0.91	V	20.06	19.50	39.56	48.35	8.79	QPK
	719.98	H	11.94	28.00	39.94	46.02	6.08	QPK
	822.85	H	10.10	29.60	39.70	46.02	6.32	QPK
	875.97	H	5.92	30.60	36.52	46.02	9.50	QPK
6	0.81	V	22.77	19.40	42.17	49.32	7.15	QPK
	0.87	V	19.85	19.50	39.35	48.74	9.39	QPK
	0.93	V	20.26	19.50	39.76	48.15	8.39	QPK
	205.71	V	23.95	13.30	37.25	43.52	6.27	QPK
	878.60	H	5.54	30.70	36.24	46.02	9.78	QPK
11	0.81	V	22.98	19.40	42.38	49.32	6.94	QPK
	0.87	V	19.38	19.50	38.88	48.76	9.87	QPK
	0.93	V	20.17	19.50	39.67	48.16	8.49	QPK
	205.69	H	20.33	13.30	33.63	43.52	9.89	QPK

Radiated Spurious Emission (1 GHz to 26 GHz)

Ch.	Frequency [MHz]	Pol.	Frequency Component	Reading [dBuV]	Transducer Factor [dB]	Test Result [dBuV/m]	Limits [dBuV/m]	Margin [dB]	Detector Type
1					N/A ¹⁾				
6					N/A ¹⁾				
11					N/A ¹⁾				

Note 1)

Since there is a margin of more than 10dB, the result value is expressed as N/A.

Note 2)

Test Result = Reading + Transducer Factor

Where, Transducer Factor = ACF + CL

ACF = Antenna Collection Factor

CL = Cable loss + Preamplifier gain + High Pass Filter

Pol.: H(Horizontal), V(Vertical)





IEEE 802.11n

Radiated Spurious Emission (9 kHz to 1 000 MHz)

Ch.	Frequency [MHz]	Pol.	Reading [dBuV]	Transducer Factor [dB]	Test Result [dBuV/m]	Limits [dBuV/m]	Margin [dB]	Detector Type
1	0.81	V	22.92	19.40	42.32	49.32	7.00	QPK
	0.93	V	20.52	19.50	40.02	48.16	8.14	QPK
	205.71	H	21.28	13.30	34.58	43.52	8.94	QPK
	308.56	H	20.00	17.70	37.70	46.02	8.32	QPK
	720.00	H	10.19	28.00	38.19	46.02	7.83	QPK
	877.24	V	7.93	30.70	38.63	46.02	7.39	QPK
6	0.83	V	23.54	19.50	43.04	49.20	6.16	QPK
	0.87	V	19.72	19.50	39.22	48.71	9.49	QPK
	0.93	V	19.60	19.50	39.10	48.12	9.02	QPK
	205.71	V	23.78	13.30	37.08	43.52	6.44	QPK
	599.98	H	10.88	25.90	36.78	46.02	9.24	QPK
11	0.82	V	23.76	19.40	43.16	49.22	6.05	QPK
	0.92	V	19.30	19.50	38.80	48.25	9.45	QPK
	205.72	V	23.51	13.30	36.81	43.52	6.71	QPK
	599.98	H	10.96	25.90	36.86	46.02	9.16	QPK
	876.25	H	7.54	30.60	38.14	46.02	7.88	QPK

Radiated Spurious Emission (1 GHz to 26 GHz)

Ch.	Frequency [MHz]	Pol.	Frequency Component	Reading [dBuV]	Transducer Factor [dB]	Test Result [dBuV/m]	Limits [dBuV/m]	Margin [dB]	Detector Type
1						N/A ¹⁾			
6						N/A ¹⁾			
11						N/A ¹⁾			

Note 1)

Since there is a margin of more than 10dB, the result value is expressed as N/A.

Note 2)

Test Result = Reading + Transducer Factor

Where, Transducer Factor = ACF + CL

ACF = Antenna Collection Factor

CL = Cable loss + Preamplifier gain + High Pass Filter

Pol.: H(Horizontal), V(Vertical)





13.7 Test data for Radiated Restricted Band Edge Emission

- Test Date : Jan. 12, 2022
- Reference Standard : Part 15 Subpart C, Sec. 15.247(d)
- Measuring Distance : 3 m
- Resolution Bandwidth : 1 MHz
- Detector mode : Peak detector mode / Average detector mode
- Power Source : DC 3.7 V
- Note : Through three orthogonal axes were investigated and the worst case is report

IEEE 802.11b

Ch.	Frequency [MHz]	Pol.	Reading [dBuV]	Transducer Factor [dB]	Test Result [dBuV/m]	Limits [dBuV/m]	Margin [dB]	Detector Type
1	2 382.86	V	12.87	37.40	50.27	54.00	3.73	CAV
11	2 498.12	V	13.07	37.70	50.77	54.00	3.23	CAV

Note 1)

Since there is a margin of more than 10dB, the result value is expressed as N/A.

Note 2)

Test Result = Reading + Transducer Factor

Where, Transducer Factor = ACF + CL

ACF = Antenna Collection Factor

CL = Cable loss + Preamplifier gain + High Pass Filter

Pol.: H(Horizontal), V(Vertical)

IEEE 802.11g

Ch.	Frequency [MHz]	Pol.	Reading [dBuV]	Transducer Factor [dB]	Test Result [dBuV/m]	Limits [dBuV/m]	Margin [dB]	Detector Type
1	2 387.69	V	12.94	37.40	50.34	54.00	3.66	CAV
11	2 485.30	H	13.24	37.60	50.84	54.00	3.16	CAV

Note 1)

Since there is a margin of more than 10dB, the result value is expressed as N/A.

Note 2)

Test Result = Reading + Transducer Factor

Where, Transducer Factor = ACF + CL

ACF = Antenna Collection Factor

CL = Cable loss + Preamplifier gain + High Pass Filter

Pol.: H(Horizontal), V(Vertical)





IEEE 802.11n

Ch.	Frequency [MHz]	Pol.	Reading [dBuV]	Transducer Factor [dB]	Test Result [dBuV/m]	Limits [dBuV/m]	Margin [dB]	Detector Type
1	2 382.28	H	12.88	37.40	50.28	54.00	3.72	CAV
11	2 486.35	H	13.46	37.60	51.06	54.00	2.94	CAV

Note 1)

Since there is a margin of more than 10dB, the result value is expressed as N/A.

Note 2)

Test Result = Reading + Transducer Factor

Where, Transducer Factor = ACF + CL

ACF = Antenna Collection Factor

CL = Cable loss + Preamplifier gain + High Pass Filter

Pol.: H(Horizontal), V(Vertical)

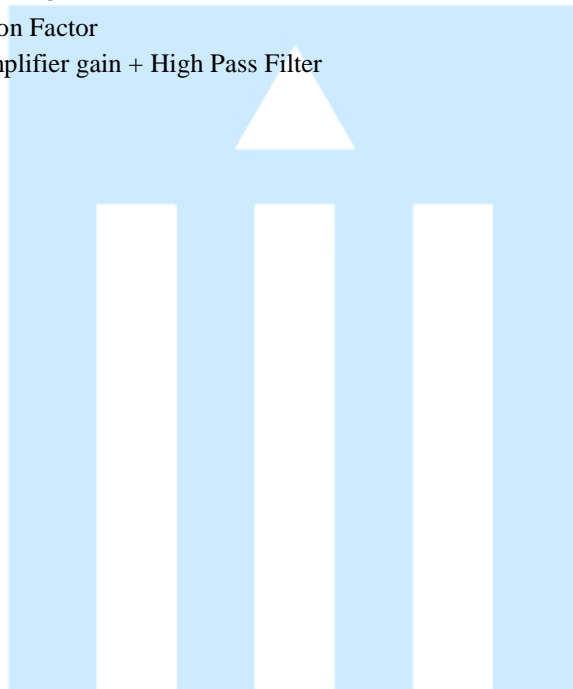



14. Sample Calculations

$$\begin{aligned} \text{dB}\mu\text{V} &= 20 \text{ Log}_{10}(\mu\text{V}/\text{m}) \\ \text{dB}\mu\text{V} &= \text{dBm} + 107 \\ \mu\text{V} &= 10^{(\text{dB}\mu\text{V}/20)} \end{aligned}$$

14.1 Example 1 :

■ 20.3 MHz

Class B Limit = 250 μV = 48 dB μV

Reading = 39.2 dB μV

10^(39.2dB μV /20) = 91.2 μV

Margin = 48 dB μV - 39.2 dB μV
 = 8.8 dB

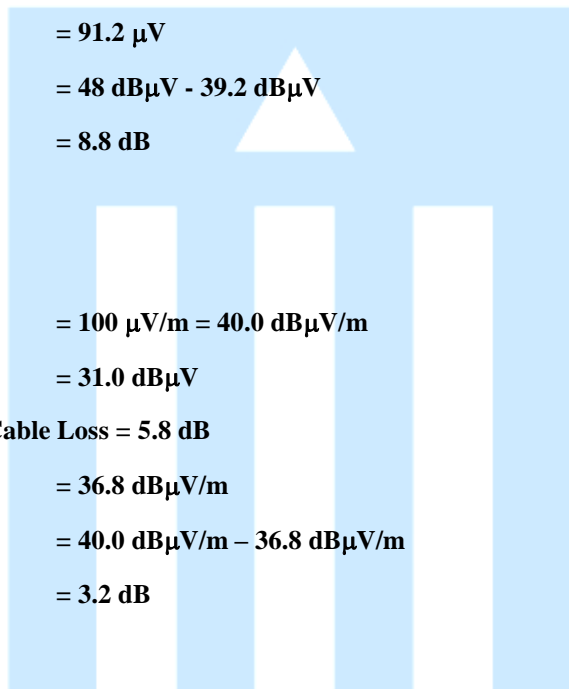

14.2 Example 2 :

■ 66.7 MHz

Class B Limit = 100 $\mu\text{V}/\text{m}$ = 40.0 dB $\mu\text{V}/\text{m}$

Reading = 31.0 dB μV

Antenna Factor + Cable Loss = 5.8 dB

Total = 36.8 dB $\mu\text{V}/\text{m}$

Margin = 40.0 dB $\mu\text{V}/\text{m}$ - 36.8 dB $\mu\text{V}/\text{m}$
 = 3.2 dB





15. Recommendation & Conclusion

The data collected shows that the **Ohsung Electronics Co.,Ltd., RF Remote Controller (Model Name: MX-1400i)** was complies with §15.247 of the FCC Rules.

- The end -

