

APPENDIX D
: BLOCK DIAGRAM(S)

D	C	B	A	NO.	DESCRIPTION	PART NO.	MATERIAL	Q'TY	SURFACE TREATMENT	REMARK
					BLOCK DIAGRAM	RF-20				

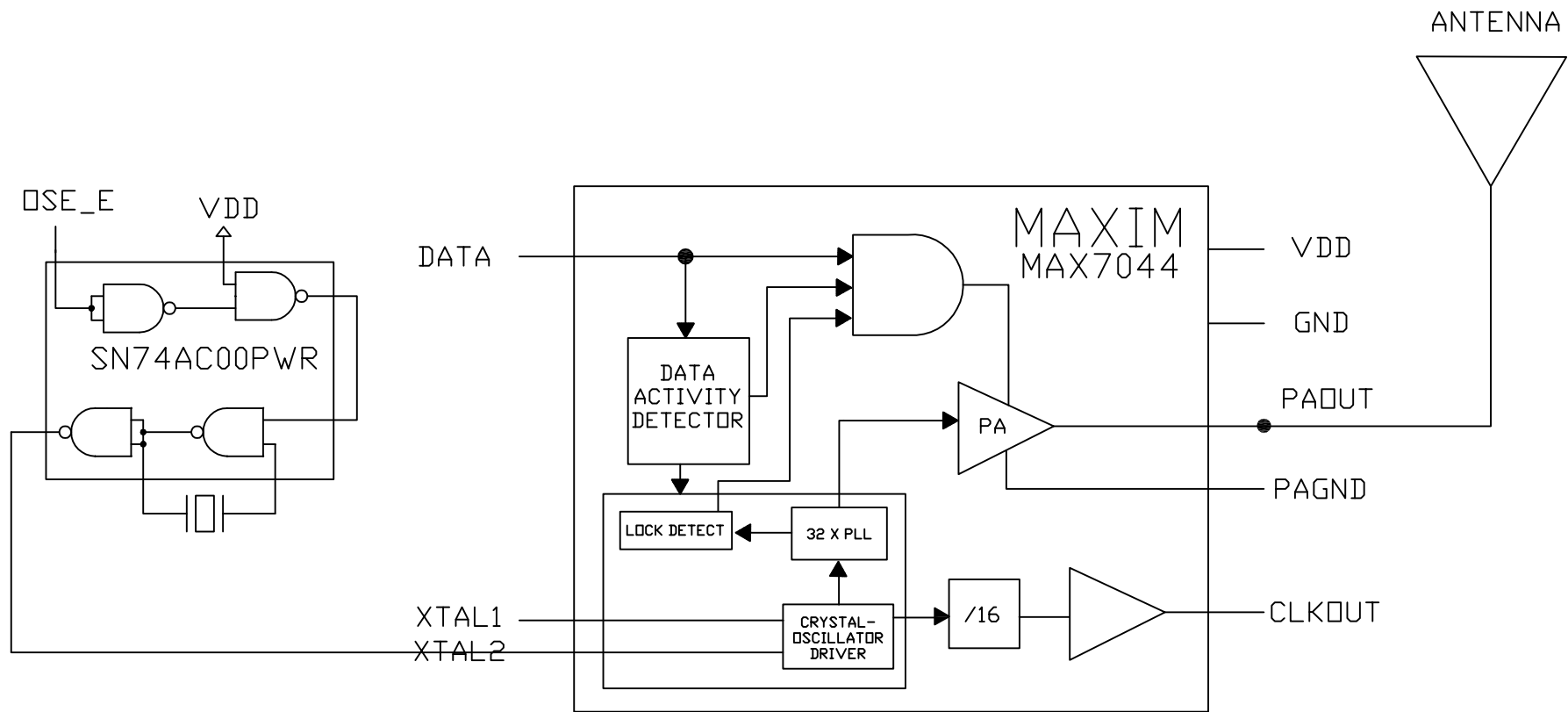

DATE	AUTHORIZED	CHANGED DETAILS			CHANGED BASIS	
SCALE	NS	UNIT	M/M	LIMIT	DESC- RPTION	BLOCK DIAGRAM (RF MODULE)
Drafter	Checked	Approved			P/NO.	ØTMF-A307 TYPE
OH SUNG ELECTRONICS CO., LTD.				REF. NO. STOCK NO.	DRAFT NO.	RF-20