

# ***EVALUATION REPORT*** ***for Certification***

**Applicant: Ohsung Electronics Co., Ltd.**  
**#181 Gongdan-dong, Gumi-si, Gyeongsangbuk-Do**  
**South Korea**  
**Attn: Mr. Hak Ki, Kim/ General Manager**

**Date of Issue: Sep. 14, 2023**  
**Order Number: GETEC-C1-23-543**  
**Test Report Number: GETEC-E3-23-053**  
**Test Site: GUMI UNIVERSITY EMC CENTER**  
**CAB Designation Number: KR0033**

<b>RESPONSIBLE PARTY</b>	<b>: Ohsung Electronics Co., Ltd.</b>
<b>ADDRESS</b>	<b>: #181 Gongdan-dong, Gumi-si, Gyeongsangbuk-do, South Korea</b>
<b>CONTACT PERSON</b>	<b>: Mr. Hak-Ki, Kim / General Manager</b>

<b>Rule Part(s)</b>	<b>: FCC Part 15 Subpart C-Intentional Radiator § 15.247</b>
<b>Test Method</b>	<b>: ANSI C63.10 (2013)</b>
<b>Equipment Class</b>	<b>: Digital Transmission System(DTS)</b>
<b>EUT Type</b>	<b>: Remote Controller</b>
<b>Type of Authority</b>	<b>: Certification</b>
<b>Model Name</b>	<b>: UR2-ST01</b>

**This equipment has been shown to be in compliance with the applicable technical standards as indicated in the measurement report and was tested in accordance with the measurement procedures specified in ANSI C63.10 (2013)**

**I attest to the accuracy of data. All measurements reported herein were performed by me or were made under my supervision and are correct to the vest of my knowledge and belief. I assume full responsibility for the completeness of these measurements and vouch for the qualifications of all persons taking them.**

**Tested by,**



**Jong-Wook Park, Senior Engineer**  
**GUMI UNIVERSITY EMC CENTER**

**Reviewed by,**



**Hyun Kim, Technical Manager**  
**GUMI UNIVERSITY EMC CENTER**



## Version

Test Report No.	Date	Description
GETEC-E3-23-053	Sep. 14, 2023	- First Approval Report





## CONTENTS

<b>1. GENERAL INFORMATION .....</b>	<b>5</b>
<b>2. INTRODUCTION .....</b>	<b>6</b>
<b>3. PRODUCT INFORMATION .....</b>	<b>7</b>
<b>3.1 DESCRIPTION OF EUT.....</b>	<b>7</b>
<b>3.2 DEFINITION OF MODELS.....</b>	<b>7</b>
<b>3.3 SUPPORT EQUIPMENT / CABLES USED .....</b>	<b>8</b>
<b>3.4 MODIFICATION ITEM(S).....</b>	<b>8</b>
<b>4. ANTENNA REQUIREMENT - §15.203 .....</b>	<b>9</b>
<b>4.1 DESCRIPTION OF ANTENNA.....</b>	<b>9</b>
<b>5. DESCRIPTION OF TESTS.....</b>	<b>9</b>
<b>5.1 TEST CONDITION.....</b>	<b>9</b>
<b>6. REFERENCES STANDARDS .....</b>	<b>9</b>
<b>8. SUMMARY OF TEST RESULTS .....</b>	<b>10</b>
<b>9. 6 DB BANDWIDTH MEASUREMENT .....</b>	<b>11</b>
<b>9.1 OPERATING ENVIRONMENT.....</b>	<b>11</b>
<b>9.2 TEST SET-UP (LAYOUT) .....</b>	<b>11</b>
<b>9.3 LIMIT .....</b>	<b>11</b>
<b>9.4 TEST EQUIPMENT USED.....</b>	<b>11</b>
<b>9.5 TEST PROCEDURE .....</b>	<b>11</b>
<b>9.6 TEST RESULT .....</b>	<b>12</b>
<b>10. CONDUCTED MAXIMUM PEAK OUTPUT POWER MEASUREMENT.....</b>	<b>14</b>
<b>10.1 OPERATING ENVIRONMENT .....</b>	<b>14</b>
<b>10.2 TEST SET-UP (LAYOUT) .....</b>	<b>14</b>
<b>10.3 LIMIT .....</b>	<b>14</b>
<b>10.4 TEST EQUIPMENT USED.....</b>	<b>14</b>
<b>10.5 TEST PROCEDURE .....</b>	<b>14</b>
<b>10.6 TEST RESULT .....</b>	<b>14</b>
<b>11. POWER SPECTRAL DENSITY MEASUREMENT .....</b>	<b>15</b>
<b>11.1 OPERATING ENVIRONMENT .....</b>	<b>15</b>
<b>11.2 TEST SET-UP (LAYOUT) .....</b>	<b>15</b>
<b>11.3 LIMIT .....</b>	<b>15</b>
<b>11.4 TEST EQUIPMENT USED.....</b>	<b>15</b>
<b>11.5 TEST PROCEDURE.....</b>	<b>15</b>
<b>11.6 TEST RESULT .....</b>	<b>16</b>
<b>12. CONDUCTED SPURIOUS EMISSION &amp; OUT OF BAND EMISSION .....</b>	<b>18</b>
<b>12.1 OPERATING ENVIRONMENT .....</b>	<b>18</b>
<b>12.2 TEST SET-UP (LAY-OUT).....</b>	<b>18</b>
<b>12.3 LIMIT .....</b>	<b>18</b>
<b>12.4 TEST EQUIPMENT USED .....</b>	<b>18</b>
<b>12.5 TEST PROCEDURE .....</b>	<b>18</b>
<b>12.6 TEST RESULT .....</b>	<b>19</b>
<b>13. AC POWER LINE CONDUCTED EMISSION .....</b>	<b>22</b>
<b>13.1 OPERATING ENVIRONMENT .....</b>	<b>23</b>



<b>13.2 TEST SET-UP .....</b>	<b>23</b>
<b>13.3 MEASUREMENT UNCERTAINTY.....</b>	<b>23</b>
<b>13.4 LIMIT .....</b>	<b>24</b>
<b>13.5 TEST EQUIPMENT USED.....</b>	<b>24</b>
<b>13.6 TEST DATA FOR CONDUCTED EMISSION .....</b>	<b>24</b>
<b>14. RADIATED SPURIOUS &amp; RESTRICTED BAND EDGE EMISSION.....</b>	<b>25</b>
<b>14.1 OPERATING ENVIRONMENT .....</b>	<b>26</b>
<b>14.2 TEST SET-UP.....</b>	<b>26</b>
<b>14.3 MEASUREMENT UNCERTAINTY .....</b>	<b>26</b>
<b>14.4 LIMIT .....</b>	<b>27</b>
<b>14.5 TEST EQUIPMENT USED.....</b>	<b>27</b>
<b>14.6 TEST DATA FOR RADIATED SPURIOUS EMISSION.....</b>	<b>28</b>
<b>14.7 TEST DATA FOR RADIATED RESTRICTED BAND EDGE EMISSION .....</b>	<b>30</b>
<b>15. SAMPLE CALCULATIONS.....</b>	<b>31</b>
<b>15.1 EXAMPLE 1 : .....</b>	<b>31</b>
<b>15.2 EXAMPLE 2 : .....</b>	<b>31</b>
<b>16. RECOMMENDATION &amp; CONCLUSION.....</b>	<b>32</b>
<b>APPENDIX A – ATTESTATION STATEMENT</b>	
<b>APPENDIX B – LABELLING</b>	
<b>APPENDIX C – BLOCK DIAGRAM</b>	
<b>APPENDIX D – SCHEMATIC DIAGRAM</b>	
<b>APPENDIX E – TEST SETUP PHOTOGRAPH</b>	
<b>APPENDIX F – EXTERNAL PHOTOGRAPH</b>	
<b>APPENDIX G – INTERNAL PHOTOGRAPH</b>	
<b>APPENDIX H – USER’S MANUAL</b>	
<b>APPENDIX I – OPERATIONAL DESCRIPTION</b>	
<b>APPENDIX J – ANTENNA SPECIFICATION</b>	
<b>APPENDIX K – PART LIST</b>	
<b>APPENDIX L – RF EXPOSURE EVALUATION</b>	



*Scope: Measurement and determination of electromagnetic emissions (EME) of radio frequency devices including intentional and / or unintentional radiators for compliance with technical rules and regulations of the Federal Communications Commission.*

### 1. General Information

**Applicant: Ohsung Electronics Co., Ltd.**  
**Applicant Address: #181 Gongdan-dong, Gumi-si, Gyeongsangbuk-do, South Korea**  
**Manufacturer: Ohsung Electronics Co., Ltd.**  
**Manufacturer Address: #181 Gongdan-dong, Gumi-si, Gyeongsangbuk-do, South Korea**  
**Contact Person: Mr. Hak ki, Kim/ General Manager**  
**Telephone Number: +82-54-468-7281      Fax Number: +82-54-461-8368**

- **FCC ID.** OZ5UR2ST01
- **Equipment Class** Digital Transmission System (DTS)
- **EUT Type** Remote Controller
- **Model Name** UR2-ST01
- **Rule Part(s)** FCC Part 15 Subpart C-Intentional Radiator § 15.247
- **Test Method** ANSI C63.10 (2013)
- **Type of Authority** Certification
- **Test Procedure(s)** ANSI C63.10 (2013), KDB558074 D01 DTS Meas Guidance v05r02
- **Dates of Test** Sep. 01, 2023 ~ Sep. 07, 2023
- **Place of Test** **GUMI UNIVERSITY EMC CENTER**  
37 Yaeun-ro, Gumi-si, Gyeongsangbuk-do, 730-711, Republic of Korea  
(FCC Test firm Registration No.: 269701)  
(ISED Test Site Registration No.: 7620A)
- **Test Report Number** GETEC-E3-23-053
- **Dates of Issue** Sep. 14, 2023



## 2. Introduction

The measurement procedure described in American National Standard for Methods of Measurement of Radio-Nose Emissions From Low-Voltage Electrical and Electronic Equipment in the Range of 9 kHz to 40 GHz (ANSI C63.4-2014) was used in determining radiated and conducted emissions emanating from **Ohsung Electronics Co., Ltd. Remote Controller. (Model name: UR2-ST01)**

These measurement tests were conducted at **GUMI UNIVERSITY EMC CENTER.**

The site address is 37 Yaeun-ro, Gumi-si, Gyeongsangbuk-do, 730-711, South Korea

This test site is one of the highest point of Gumi 1 college at about 200 kilometers away from Seoul city and 40 kilometers away from Daeje city. It is located in the valley surrounded by mountains in all directions where ambient radio signal conditions are quiet and a favorable area to measure the radio frequency interference on open field test site for the computing and ISM devices manufactures. The detailed description of the measurement facility was found to be in compliance with the requirements of §2.948 according to ANSI C63.10 (2013)

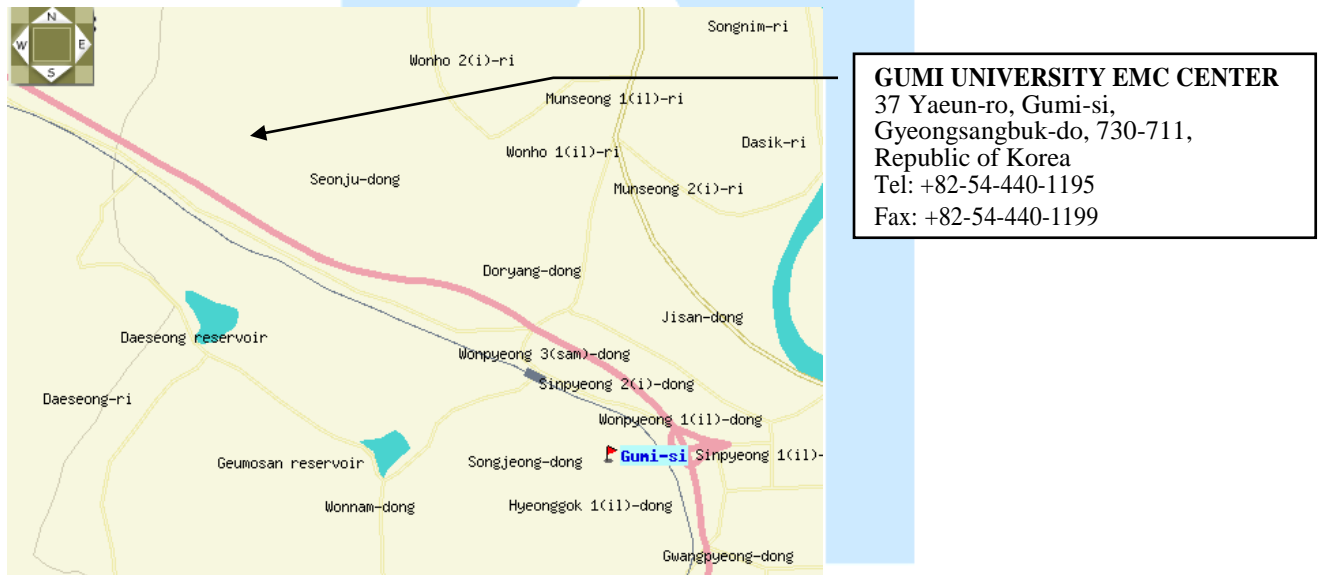

Fig 1. The map above shows the Gumi University in vicinity area.



### 3. Product Information

#### 3.1 Description of EUT

The Equipment under Test (EUT) is the **Ohsung Electronics Co., Ltd. Remote Controller. (Model name: UR2-ST01)**

**FCC ID.: OZ5UR2ST01**

- Equipment	: Remote Controller
- Model name	: UR2-ST01
- Brand name	: Ohsung Electronics Co., Ltd.
- Serial number	: Proto type
- Electrical Rating	: DC 3.0 V('AA' Battery x2)
- Channel Separations	: 2 MHz
- Type of Modulation	: GFSK
- Type of Technique	: Bluetooth LE
- Frequency range	: 2 402 MHz ~ 2 480 MHz
- Number of channel	: 40
- Type of chain	: One
- Antenna specification	: Manufacturer: Ohsung Electronics Co., Ltd. Antenna type : PCB Pattern antenna Peak Gain : 0.69 dBi

#### 3.2 Definition of models

-None.



### 3.3 Support Equipment / Cables used

#### 3.3.1 Used Support Equipment

Description	Manufacturer	Model Name	S/N & FCC ID.
None.	-	-	S/N: - FCC ID.: -

#### 3.3.2 System configuration

Description	Manufacturer	Model Name	S/N & FCC ID.
None.	-	-	S/N: - FCC ID.: -

#### 3.3.3 Used Cable(s)

Cable Name	Condition	Description
None.	-	-

### 3.4 Modification Item(s)

- None





#### 4. Antenna Requirement - §15.203

An intentional radiator antenna shall be designed to ensure that no antenna other than that furnished by the applicant can be used with the device. The use of permanently attached antenna or of an antenna that uses a unique coupling to the intentional radiator shall be considered sufficient to comply with this requirement.

##### 4.1 Description of Antenna

The **Ohsung Electronics Co., Ltd. Remote Controller**, comply with the requirement of §15.203 with a built-in PCB pattern antenna permanently attached to the transmitter.

#### 5. Description of tests

##### 5.1 Test Condition

The EUT was installed, arranged and operated in a manner that is most representative of equipment as typically used. The measurements were carried out while varying operating modes and cable positions within typically arrangement to determine maximum emission level.

The representative and worst test mode(s) were noted in the test report.

- Test Voltage / Frequency: 3 V / DC
- Operating condition during the test(s) :
  - . Continuous RF transmitting mode with maximum RF output power.
  - . Operating channel frequency and moderation technology

Mode	Available channel	Frequency	Type of Modulation
Bluetooth LE	0~39	2402 ~ 2480 MHz	GFSK

- . EUT set condition (Test Software)

Test Software	EMI TEST
Test Software version	1.5

#### 6. References Standards

- FCC Part 15 (2009) Subpart C-Intentional Radiator §15.247
- ANSI C 63.10 (2013): American National Standard for Testing Unlicensed Wireless Devices
- KDB 558074 D01 DTS meas Guidance v05r02: Guidance for Performing Compliance Measurements on Digital Transmission Systems (DTS) Operating Under §15.247



## 8. SUMMARY OF TEST RESULTS

FCC Part Section(s)	Test Description	Test Result
§15.247(a)(2)	6 dB Bandwidth	Pass
§15.247(b)(3)	Conducted Maximum Peak Output Power	Pass
§15.247(e)	Power Spectral Density	Pass
§15.247(d)	Conducted Out of Band Emission Emissions	Pass
§15.207(a)	AC Power line Conducted Emissions	N/A <sup>1)</sup>
§15.205, 15.209	Radiated Spurious Emissions	Pass
§15.247(d), 15.205, 15.209	Radiated Restricted Band Edge	Pass

Note)

1) The EUT is supplied power from battery. Therefore the test was not applicable.



## 9. 6 dB Bandwidth Measurement

### 9.1 Operating environment

Temperature : 24.0 °C  
 Relative Humidity : 58.8 % R.H.

### 9.2 Test Set-up (Layout)

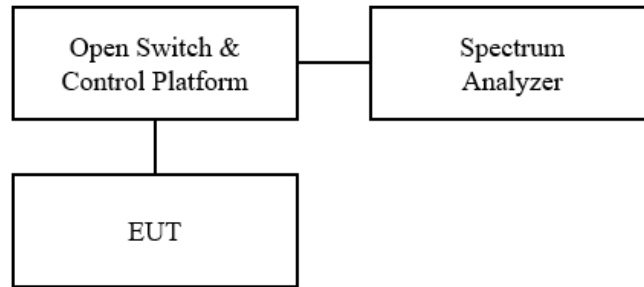

### 9.3 Limit

For digital modulation systems, the minimum 6 dB bandwidth shall be at least 500 kHz

### 9.4 Test Equipment used

Model Name	Manufacturer	Description	Serial Number	Due to Calibration
■ - FSV	Rohde & Schwarz	Spectrum Analyzer	101552	Apr. 06, 2024
■ - OSP120	Rohde & Schwarz	Open Switch and control platform	101329	Apr. 09. 2024
■ - J12J103539-00-2	JUNFLON	RF Test Cable (OSP_DUT1)	AUG-03-21-066	N/A
■ - J12J103539-00-3	JUNFLON	RF Test Cable (OSP_RX)	AUG-03-21-074	N/A
■ - WMS 32	Rohde & Schwarz	Testing Software	VER10.40.10	N/A

### 9.5 Test Procedure

- Set RBW = 100 kHz.
- Set the video bandwidth (VBW)  $\geq 3 \times$  RBW.
- Detector = Peak.
- Trace mode = max hold.
- Sweep = auto couple.
- Allow the trace to stabilize.
- Measure the maximum width of the emission that is constrained by the frequencies associated with the two outermost amplitude points (upper and lower frequencies) that are attenuated by 6 dB relative to the maximum level measured in the fundamental emission.



### 9.6 Test result

- Test Date : Sep. 05, 2023
- Reference Standard : Part 15 Subpart C, Sec. 15.247(a)(2)
- Test Procedure(s) : ANSI C63.10 (2013), KDB558074 D01 DTS Meas Guidance v05r02
- Operating Condition : RF transmitting mode (Low: 2 402 MHz, Middle: 2 440 MHz, High: 2 480 MHz)
- Power Source : DC 3 V

Frequency (MHz)	6 dB Bandwidth (MHz)	Band Edge Left (MHz)	Band Edge Right (MHz)	Min. Limit (MHz)	Result
2 402	0.71	2401.54	2402.26	0.50	Complies
2 440	0.70	2439.54	2440.24	0.50	Complies
2 480	0.70	2479.54	2480.24	0.50	Complies

6 dB Bandwidth Plot on Configuration : Lowest channel (2 402 MHz)

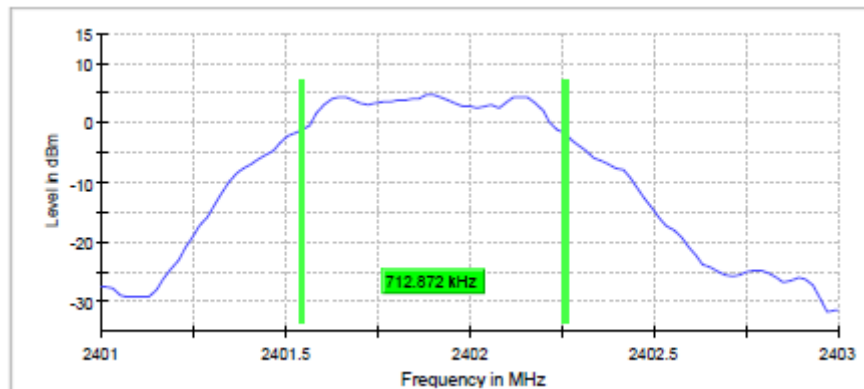



**6 dB Bandwidth Plot on Configuration : Middle channel (2 440 MHz)**

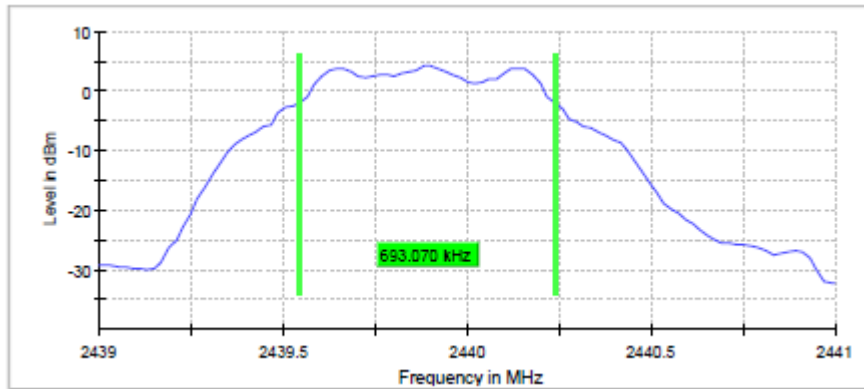

**6 dB Bandwidth Plot on Configuration : Highest channel (2 480 MHz)**

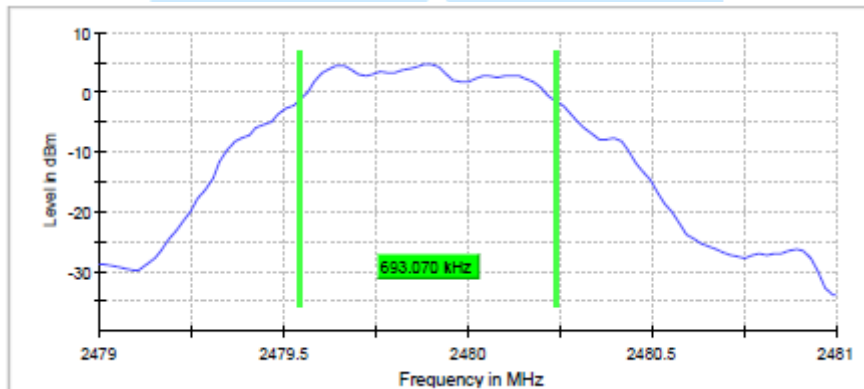



## 10. Conducted Maximum Peak Output Power Measurement

### 10.1 Operating environment

Temperature : 24.0 °C  
 Relative Humidity : 58.8 % R.H.

### 10.2 Test Set-up (Layout)

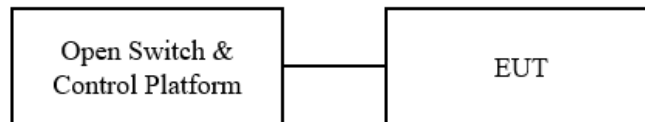

### 10.3 Limit

For systems using digital modulation in the (2 400~2 483.5) MHz, the limit for peak output power is 30 dBm. The limit has to be reduced by the amount in dB that the gain of the antenna exceeds 6 dBi. In case of point-to-point operation, the limit has to be reduced by 1 dB for every 3 dB that the directional gain of the antenna exceeds 6 dBi.

### 10.4 Test Equipment used

Model Name	Manufacturer	Description	Serial Number	Due to Calibration
■ - OSP120	Rohde & Schwarz	Open Switch and control platform	101329	Apr. 09. 2024
■ - J12J103539-00-2	JUNFLON	RF Test Cable (OSP_DUT1)	AUG-03-21-066	N/A
■ - WMS 32	Rohde & Schwarz	Testing Software	VER10.40.10	N/A

### 10.5 Test Procedure

A peak power sensor was used on the output port of the EUT. A power meter was used to read the response of the peak power sensor. Record the power level.

### 10.6 Test Result

- Test Date : Sep. 05, 2023
- Reference Standard : Part 15 Subpart C, Sec. 15.247(b)(3)
- Test Procedure(s) : ANSI C63.10 (2013), KDB558074 D01 DTS Meas Guidance v05r02
- Operating Condition : RF transmitting mode (Low: 2 402 MHz, Middle: 2 440 MHz, High: 2 480 MHz)
- Power Source : DC 3 V

Frequency (MHz)	Average Conducted Power <sup>1)</sup> (dBm)	Peak Conducted Power (dBm)	Max. Limit (dBm)	Result
2 402	5.6	7.0	30.00	Complies
2 440	5.1	6.5	30.00	Complies
2 480	5.6	7.0	30.00	Complies

Note: 1) The Average output power is reference data for RF Exposure.



## 11. Power Spectral Density Measurement

### 11.1 Operating Environment

Temperature : 24.0 °C  
 Relative Humidity : 58.8 % R.H.

### 11.2 Test Set-up (Layout)

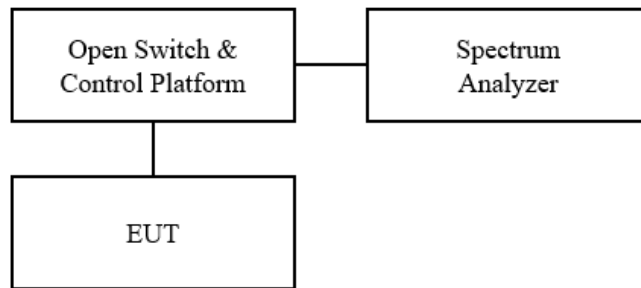

### 11.3 Limit

For digitally modulated systems, the power spectral density conducted from the intentional radiator to the antenna shall not be greater than 8 dBm in any 3 kHz band during any time interval of continuous transmission

### 11.4 Test Equipment used

Model Name	Manufacturer	Description	Serial Number	Due to Calibration
■ - FSV	Rohde & Schwarz	Spectrum Analyzer	101552	Apr. 06, 2024
■ - OSP120	Rohde & Schwarz	Open Switch and control platform	101329	Apr. 09, 2024
■ - J12J103539-00-2	JUNFLON	RF Test Cable (OSP_DUT1)	AUG-03-21-066	N/A
■ - J12J103539-00-3	JUNFLON	RF Test Cable (OSP_RX)	AUG-03-21-074	N/A
■ - WMS 32	Rohde & Schwarz	Testing Software	VER10.40.10	N/A

### 11.5 Test Procedure

- Set analyzer center frequency to DTS channel center frequency.
- Set span to at least 1.5 X OBW.
- Set the RBW to  $3 \text{ kHz} \leq \text{RBW} \leq 100 \text{ kHz}$
- Set the VBW  $\geq 3 \text{ X RBW}$
- Detector = power averaging (RMS) or sample detector (when RMS not available)
- Ensure that the number of measurement points in the sweep  $\geq 2 \text{ X span/RBW}$
- Sweep time = auto couple.
- Employ trace averaging (RMS) mode over a minimum of 100 trace.
- use the peak marker function to determine the maximum amplitude level.
- If measured value exceeds limit, reduce RBW (no less than 3 kHz) and repeat (note that this may require zooming in on the emission of interest and reducing the span in order to meet the minimum measurement point requirement as the RBW is reduce).



### 11.6 Test Result

- Test Date : Sep. 05, 2023
- Reference Standard : Part 15 Subpart C, Sec. 15.247(e)
- Test Procedure(s) : ANSI C63.10 (2013), KDB558074 D01 DTS Meas Guidance v05r02
- Operating Condition : RF transmitting mode (Low: 2 402 MHz, Middle: 2 440 MHz, High: 2 480 MHz)
- Power Source : DC 3 V

Frequency	PSD (dBm/3kHz)	Max. Limit (dBm/3kHz)	Result
2 402 MHz	1.09	8.00	Complies
2 440 MHz	0.47	8.00	Complies
2 480 MHz	0.85	8.00	Complies

Power Density Plot on configuration : Lowest channel (2 402 MHz)

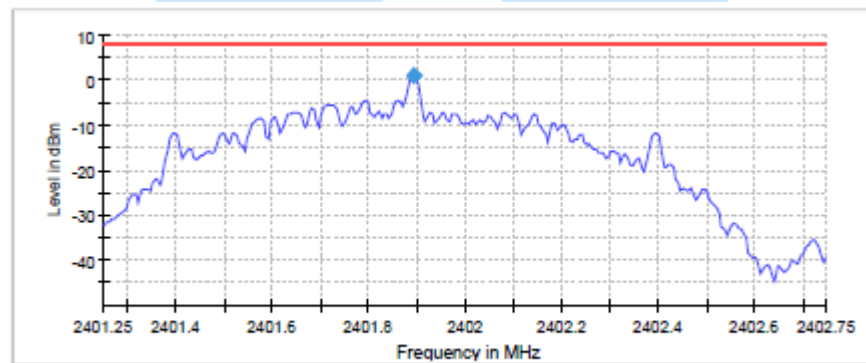





**Power Density Plot on configuration : Middle channel (2 440 MHz)**

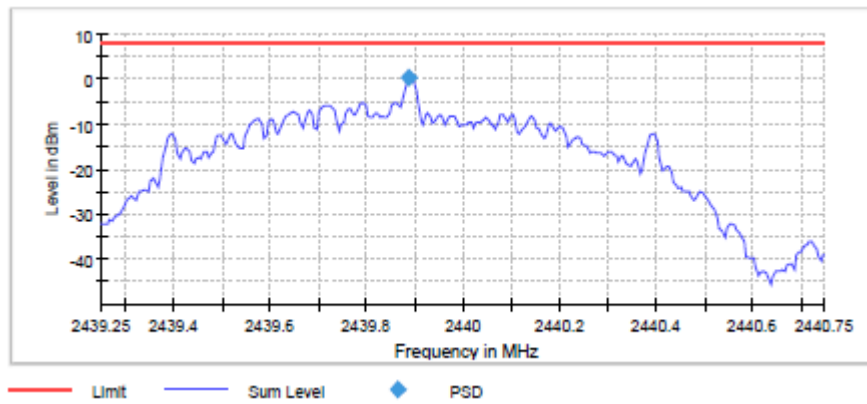

**Power Density Plot on configuration : Highest channel (2 480 MHz)**

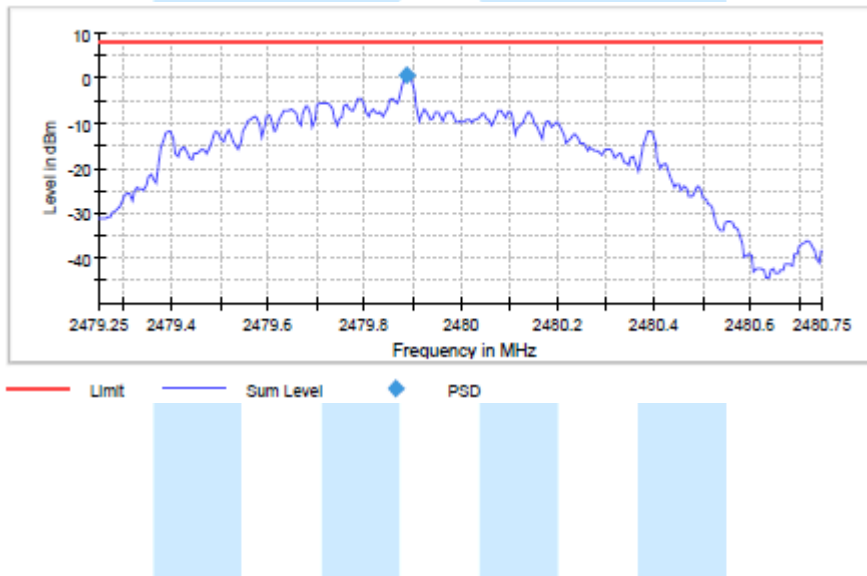



## 12. Conducted Spurious Emission & Out of Band Emission

### 12.1 Operating environment

Temperature : 29.9 °C  
 Relative Humidity : 31.7 % R.H.

### 12.2 Test set-up (Lay-out)

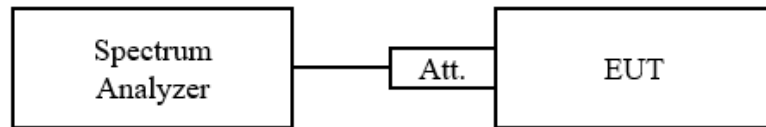

### 12.3 Limit

Below -20 dB of the highest emission level of operating band (in 100 kHz resolution band width)

### 12.4 Test equipment used

Model Name	Manufacturer	Description	Serial Number	Due to Calibration
■ - FSV	Rohde & Schwarz	Spectrum Analyzer	101552	Apr. 06, 2024
■ - 56-10	Weinschel	10 dB Attenuator	53184	Apr. 09, 2024
■ - J12J102248-00-5	JUNFLON	RF Test Cable (26.5 GHz_1)	JUL-06-14-106	N/A

### 12.5 Test Procedure

- a) Set analyzer center frequency to DTS channel center frequency.
- b) Set the span to  $\geq 1.5 \times$  DTS bandwidth.
- c) Set the RBW = 100 kHz
- d) Set the VBW  $\geq 3 \times$  RBW
- e) Detector = peak.
- f) Sweep time = auto couple.
- g) Trace mode = max hold.
- h) Allow trace to fully stabilize.
- i) Use the peak marker function to determine the maximum PSD level.



### 12.6 Test Result

- Test Date : Sep. 07, 2023
- Reference standard : Part 15 Subpart C, Sec. 15.247(d)
- Test Procedure(s) : ANSI C63.10 (2013), KDB558074 D01 DTS Meas Guidance v05r02
- Operating condition : RF transmitting mode (Low: 2 402 MHz, Middle: 2 440 MHz, High: 2 480 MHz)
- Power Source : DC 3 V

#### Conducted Spurious Emission

Operating Frequency	Fundamental Level (dBm)	Spurious Level (dBm)	Deviation (dBc)	Limits (dBc)	Result
2 402 MHz	3.73	-38.33	-42.06	-20.00	Complies
2 440 MHz	3.70	-39.05	-42.75		Complies
2 480 MHz	4.00	-38.48	-42.48		Complies

#### Conducted Out of Band(Band Edge) Emission

Operating Frequency	Fundamental Level (dBm)	Bandedge Level (dBm)	Deviation (dBc)	Limits (dBc)	Result
2 402 MHz	3.73	-40.16	-43.89	-20.00	Complies
2 480 MHz	4.00	-39.56	-43.56		Complies

#### Conducted spurious Emission Plot on Configuration : Lowest channel (2 402 MHz)

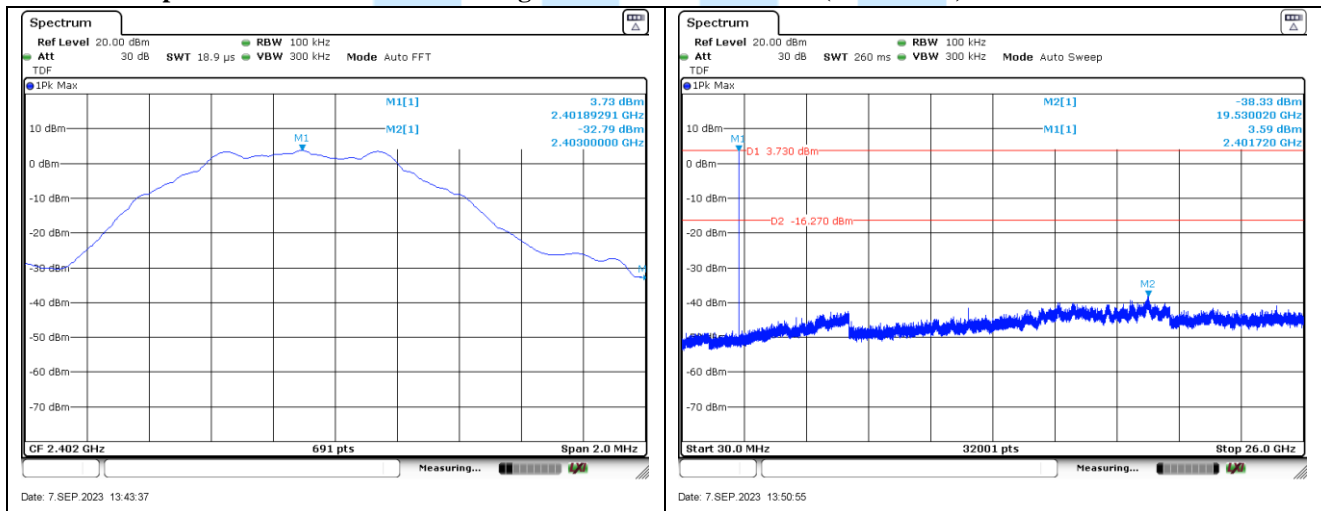



**Conducted spurious Emission Plot on Configuration : Middle channel (2 440 MHz)**

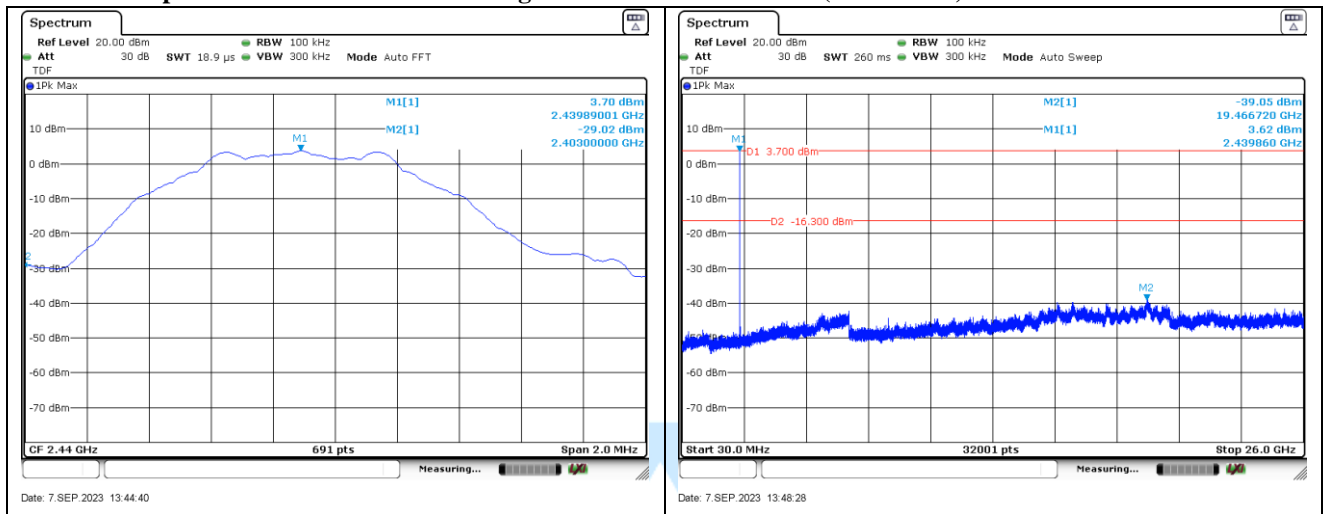

**Conducted spurious Emission Plot on Configuration : Highest channel (2 480 MHz)**

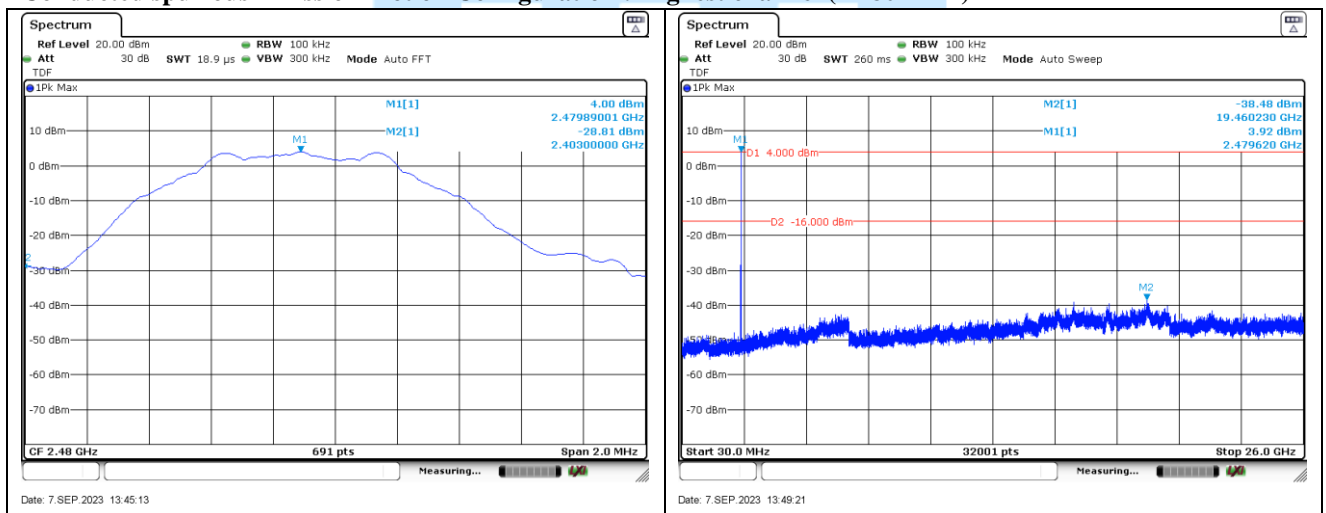



### Low Band Edge Plot on Configuration : Lowest channel (2 402 MHz)

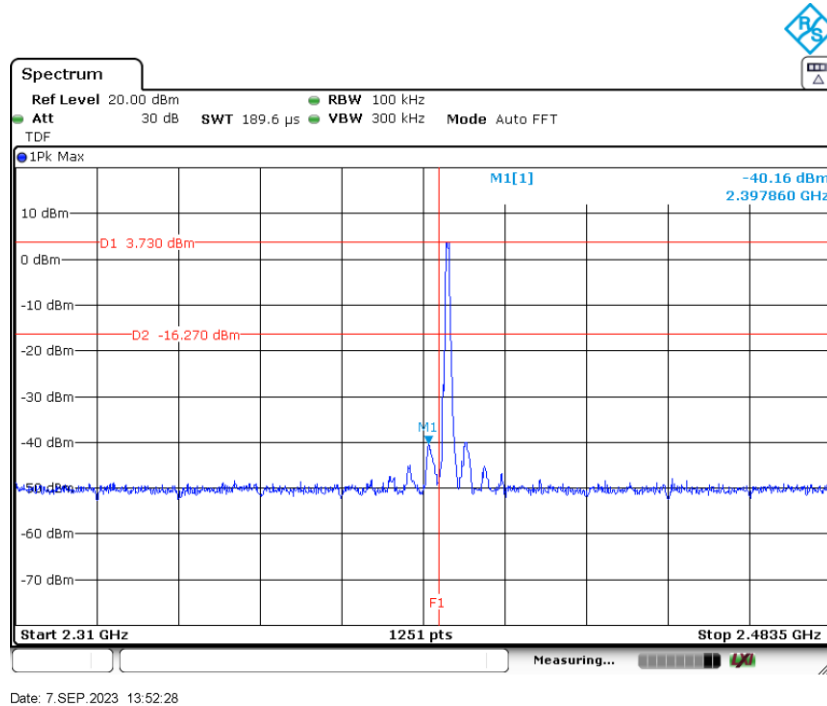

### High Band Edge Plot on Configuration : Highest channel (2 480 MHz)

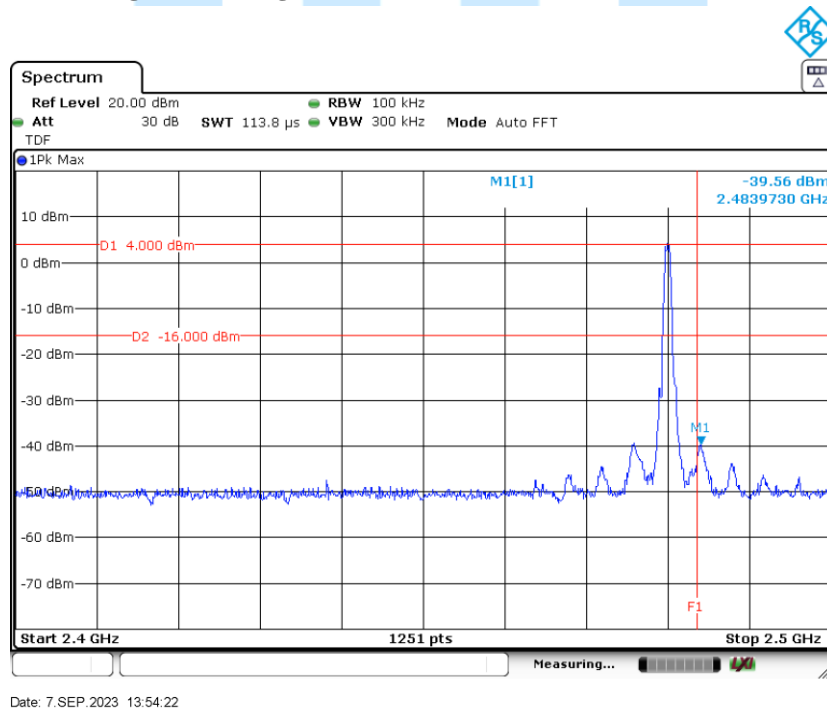



### 13. AC Power line Conducted emission

#### -Test Description

The Line conducted emission test facility is inside a 4 m × 8 m × 2.5 m shielded enclosure. (Test firm Registration Number: 269701)

The EUT was placed on a non-conducting 1.0 m by 1.5 m table, which is 0.8 m in height and 0.4 m away from the vertical wall of the shielded enclosure.

The EUT is powered from the Rohde & Schwarz LISN (ENV216) and the support equipment is powered from the Rohde & Schwarz LISN (ENV216). Powers to the LISN are filtered by high-current high insertion loss power line filter.

Sufficient time for EUT, support equipment, and test equipment was allowed in order for them to warm up to their normal operating condition.

The RF output of the LISN was connected to the EMI test receiver (Rohde & Schwarz, ESCI).

Exploratory measurements were conducted to identify the highest emission by operating the EUT in a range of typical modes of operation, cable positions, system configuration and arrangement.

Based on exploratory measurements, the final measurements were conducted at the worst test conditions.

Exploratory measurements were scanned using Peak mode of EMI Test receiver from 150 kHz to 30 MHz with 20 ms sweep time. The final measurements were measured with Quasi-Peak and Average mode.

The bandwidth of EMI Test Receiver was set to 9 kHz. Interface cables were connected to the available interface ports of the test unit. Excess cable lengths were bundled at center with 30 cm ~ 40 cm.

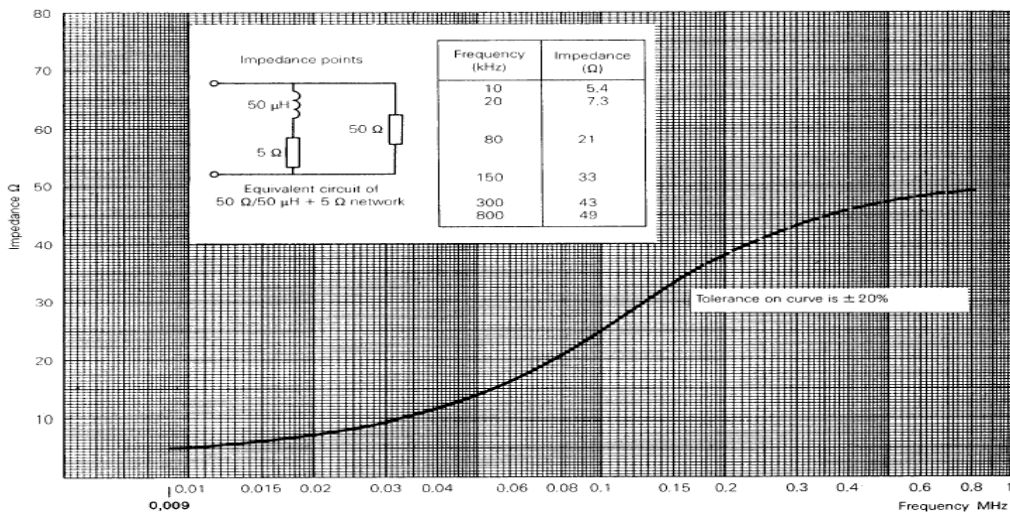

Fig 2. Impedance of LISN



### 13.1 Operating Environment

Temperature : - °C  
Relative Humidity : - % R.H.

### 13.2 Test Set-up

The conducted emission measurements were performed in the shielded room.

The EUT was placed on wooden table, 0.8 m heights above the floor, 0.4 m from the reference ground plane (GRP) wall and 0.8 m from AMN & ISN.

AMN is bonded on horizontal reference ground plane.

The ground plane, which was electrically bonded to the shield room, ground system and all power lines entering the shield room, were filtered.

### 13.3 Measurement Uncertainty

The measurement uncertainty was calculated in accordance with ISO "Guide to the expression of uncertainty in measurement."

The measurement uncertainty was given with a confidence of 95 %.

Test Items	Uncertainty	Remark
Conducted emission (9 kHz ~ 150 kHz)	3.69 dB	Confidence level of approximately 95 % ( $k = 2$ )
Conducted emission (150 kHz ~ 30 MHz)	3.32 dB	Confidence level of approximately 95 % ( $k = 2$ )



**13.4 Limit**

RFI Conducted	FCC Limit(dB $\mu$ V/m) Class B	
	Quasi-Peak	Average
150 kHz ~ 0.5 MHz	66 ~ 56*	56 ~ 46*
0.5 MHz ~ 5 MHz	56	46
5 MHz ~ 30 MHz	60	50

\*Limits decreases linearly with the logarithm of frequency.

**13.5 Test Equipment used**

Model Name	Manufacturer	Description	Serial Number	Due to Calibration
<input type="checkbox"/> - ESCI	Rohde & Schwarz	EMI test receiver	100237	Apr. 04, 2024
<input type="checkbox"/> - ENV216	Rohde & Schwarz	LISN	100172	Apr. 04, 2024
<input type="checkbox"/> - ENV216	Rohde & Schwarz	LISN	100173	Apr. 04, 2024
<input type="checkbox"/> EMC 32	Rohde & Schwarz	Testing Software	VER8.53	N/A

**13.6 Test data for Conducted Emission**

- Test Date :
  - Reference Standard :
  - Test Procedure(s) :
  - Operating Condition :
  - Frequency rage :
  - Comment : Not applicable
- ※ The EUT is supplied power from battery. Therefore this test was not applicable.





## 14. Radiated Spurious & Restricted Band Edge Emission

Exploratory Radiated measurements were conducted at the 3m semi anechoic chamber in order to identify the highest emission by operating the EUT in a range of typical modes of operation, cable positions, system configuration and arrangement.

Based on exploratory measurements, the final measurements were conducted at the worst test conditions.

Final measurements of below 1GHz were made at 3m or 10 m Chamber that complies with CISPR 16/ANSI C63.10. Above 1GHz final measurements were conducted at the 3m Chamber only.

For measurements above 1GHz, the bottom side of 3m chamber was installed with absorbers in order to meet SVSWR Limit.

Exploratory measurements were scanned using Peak mode of EMI Test receiver and final measurements were measured with Quasi-Peak mode (Below 1GHz) and Peak & Average mode (Above 1GHz).

The measurements were performed by rotating the EUT 360° and adjusting the receive antenna height from 1.0 m to 4.0 m. All frequencies were investigated in both horizontal and vertical antenna polarity.

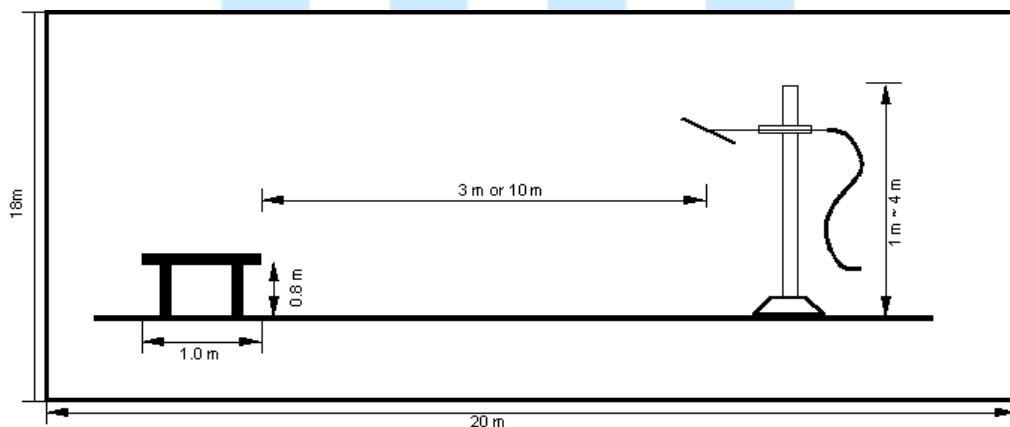

Fig 3. Dimensions of test site (Below 1GHz)

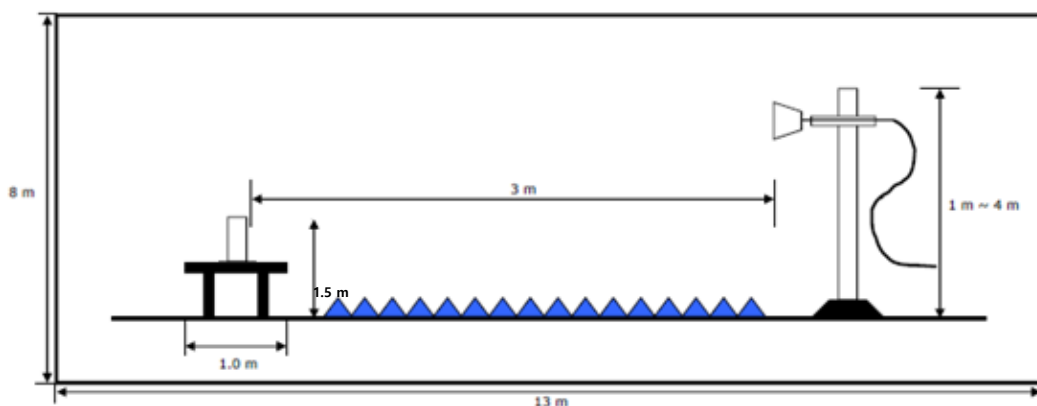

Fig 4. Dimensions of test site (Above 1GHz)



### 14.1 Operating environment

Temperature : 26.4 °C  
 Relative humidity : 54.4 % R.H.

### 14.2 Test set-up

A preliminary and final measurement was at 3 m anechoic chamber.

The EUT was placed on a non-conducting table.

For emissions testing at or below 1 GHz, the table height is 80 cm above the reference ground plane.

For emission measurements above 1 GHz, the table height is 1.5 m above the reference ground plane.

The turntable with EUT was rotated 360°, and the antenna was varied in height between 1.0 m and 4.0 m in order to determine the maximum emission levels.

This procedure was performed for both horizontal and vertical polarization of the receiving antenna.

### 14.3 Measurement uncertainty

The measurement uncertainty was calculated in accordance with ISO “Guide to the expression of uncertainty in measurement”.

The measurement uncertainty was given with a confidence of 95 %.

Test items(Anechoic Chamber)	Uncertainty	Remark
Radiated emission (30 MHz ~ 300 MHz, 3 m, Vertical)	4.78 dB	Confidence level of approximately 95 % ( $k = 2$ )
Radiated emission (30 MHz ~ 300 MHz, 3 m, Horizontal)	4.77 dB	Confidence level of approximately 95 % ( $k = 2$ )
Radiated emission (300 MHz ~ 1 000 MHz, 3 m, Vertical)	6.20 dB	Confidence level of approximately 95 % ( $k = 2$ )
Radiated emission (300 MHz ~ 1 000 MHz, 3 m, Horizontal)	5.12 dB	Confidence level of approximately 95 % ( $k = 2$ )
Radiated emission (1 000 MHz ~ 6 000 MHz, 3 m, V/H)	4.56 dB	Confidence level of approximately 95 % ( $k = 2$ )
Radiated emission (6 000 MHz ~ 18 000 MHz, 3 m, V/H)	4.88 dB	Confidence level of approximately 95 % ( $k = 2$ )
Radiated emission (18 000 MHz ~ 26 000 MHz, 3 m, V/H)	5.03 dB	Confidence level of approximately 95 % ( $k = 2$ )

Where relevant, the following measurement uncertainty levels have been estimated for tests performed on the EUT as specified in CISPR 16-4-2.

The listed uncertainties are the worst case uncertainty for the entire range of measurement. please note that the uncertainty values are provided for informational purposes only are not used in determining the PASS/FAIL results



**14.4 Limit**

20 dB in any 100 kHz bandwidth outside the operating frequency band. In case the emission fall within the restricted band specified on 15.205(a) limit in the table below has to be followed.

Frequencies (MHz)	Field Strength (microvolt/meter)	Measurement Distance (meters)
0.009 ~ 0.490	2 400/F (kHz)	300
0.490 ~ 1.705	2 400/F (kHz)	30
1.705 ~ 30.0	30	30
30 ~ 88	100	3
88 ~ 216	150	3
216 ~ 960	200	3
Above 960	500	3

**14.5 Test Equipment used**

Model Name	Manufacturer	Description	Serial Number	Due to Calibration
■ - ESU40	Rohde & Schwarz	EMI Test Receiver	100266	Apr. 04, 2023
■ - HFH2-Z2	Rohde & Schwarz	Loop Antenna	100041	Apr. 14, 2024
■ - VULB9160	Schwarzbeck	Broadband Test Antenna	3193	Apr. 18, 2024
■ - HF907	Rohde & Schwarz	Horn Antenna	100538	Jan. 25, 2024
■ - BBHA9170	Schwarzbeck	Horn Antenna	766	Apr. 17, 2024
■ - MCU066	maturo GmbH	Position Controller	1390306	N/A
■ - TT2.5SI	maturo GmbH	Turntable	1390307	N/A
■ - CO3000	Innco system GmbH	Position Controller	CO3000/1804/4 2760218/P	N/A
■ - MA4640-XP-ET	Innco system GmbH	Antenna Mast	5580916	N/A
■ - 310N	Sonoma Instrument	Amplifier	187164	Apr. 05. 2024
■ - TK-PA18H	TESTEK	Low Noise Amplifier	220107-L	Apr. 06, 2024
■ - TK-PA1840H	TESTEK	Amplifier	170007-L	Apr. 09, 2024
■ - WHKX3.0/18G-10SS	WAINWRIGHT INSTRUMENTS	High pass filter	SN31	Apr. 07, 2023
■- EMC 32	Rohde & Schwarz	Testing Software	VER10.50.10	N/A



**14.6 Test data for Radiated Spurious Emission**

- Test Date : Sep. 01 ~ 05, 2023
- Reference Standard : Part 15 Subpart C, Sec. 15.247(d)
- Measuring Distance : 3 m
- Resolution Bandwidth : 200 Hz, 9 kHz(Below 30 MHz) / 120 kHz(30 MHz ~ 1GHz) / 1 MHz(Above 1GHz)
- Detector mode : Quasi Peak detector mode / Peak detector mode / Average detector mode
- Power Source : DC 3.0 V
- Note : Through three orthogonal axes were investigated and the worst case is report

**Radiated Spurious Emission (9 kHz to 30 MHz): 2 402 MHz**

Frequency (MHz)	MaxPeak (dBμV/m)	Limit (dBμV/m)	Margin (dB)	Meas.Time (ms)	Bandwidth (kHz)	Height (cm)	Pol	Azimuth (deg)	Corr. (dB)
0.57	45.75	52.38	6.63	1000	9	100	H	237	-12.9

**Radiated Spurious Emission (9 kHz to 30 MHz): 2 440 MHz**

Frequency (MHz)	QuasiPeak (dBμV/m)	Limit (dBμV/m)	Margin (dB)	Meas.Time (ms)	Bandwidth (kHz)	Height (cm)	Pol	Azimuth (deg)	Corr. (dB)
0.57	45.66	52.42	6.76	1000	9	100	H	211	-12.9

**Radiated Spurious Emission (9 kHz to 30 MHz): 2 480 MHz**

Frequency (MHz)	MaxPeak (dBμV/m)	Limit (dBμV/m)	Margin (dB)	Meas.Time (ms)	Bandwidth (kHz)	Height (cm)	Pol	Azimuth (deg)	Corr. (dB)
0.57	46.64	52.38	5.74	1000	9	100	H	79	-12.9

**Radiated Spurious Emission (30 MHz to 1 000 MHz): 2 402 MHz**

Frequency (MHz)	QuasiPeak (dBμV/m)	Limit (dBμV/m)	Margin (dB)	Meas.Time (ms)	Bandwidth (kHz)	Height (cm)	Pol	Azimuth (deg)	Corr. (dB)
33.00	27.93	40.00	12.07	1000	120	113	V	220	-18.9

**Radiated Spurious Emission (30 MHz to 1 000 MHz): 2 440 MHz**

Frequency (MHz)	QuasiPeak (dBμV/m)	Limit (dBμV/m)	Margin (dB)	Meas.Time (ms)	Bandwidth (kHz)	Height (cm)	Pol	Azimuth (deg)	Corr. (dB)
32.95	27.47	40.00	12.53	1000	120	107	V	231	-18.9

**Radiated Spurious Emission (30 MHz to 1 000 MHz): 2 480 MHz**

Frequency (MHz)	QuasiPeak (dBμV/m)	Limit (dBμV/m)	Margin (dB)	Meas.Time (ms)	Bandwidth (kHz)	Height (cm)	Pol	Azimuth (deg)	Corr. (dB)
33.05	47.88	40.00	12.12	1000	120	110	V	1	-18.9



**Radiated Spurious Emission (1 GHz to 26 GHz): 2 402 MHz**

Frequency [MHz]	Pol.	Frequency Component	Reading [dBuV]	Transducer Factor [dB]	Test Result [dBuV/m]	Limits [dBuV/m]	Margin [dB]	Detector Type
4803.40	H	Harmonics	49.00	-8.60	40.40	54.00	13.60	AV
7206.30	V	Harmonics	66.10	-2.40	63.70	74.00	10.30	PK
9608.70	V	Harmonics	68.12	-1.50	66.62	74.00	7.38	PK
12010.80	H	Harmonics	56.85	6.90	63.75	74.00	10.25	PK

**Radiated Spurious Emission (1 GHz to 26 GHz): 2 440 MHz**

Frequency [MHz]	Pol.	Frequency Component	Reading [dBuV]	Transducer Factor [dB]	Test Result [dBuV/m]	Limits [dBuV/m]	Margin [dB]	Detector Type
4879.30	V	Harmonics	48.97	-8.10	40.87	54.00	13.13	AV
7320.30	V	Harmonics	69.47	-2.60	66.87	74.00	7.13	PK
9760.70	V	Harmonics	67.78	-0.10	67.68	74.00	6.32	PK
12198.30	V	Harmonics	59.66	5.90	65.56	74.00	8.44	PK

**Radiated Spurious Emission (1 GHz to 26 GHz): 2 480 MHz**

Frequency [MHz]	Pol.	Frequency Component	Reading [dBuV]	Transducer Factor [dB]	Test Result [dBuV/m]	Limits [dBuV/m]	Margin [dB]	Detector Type
4959.30	H	Harmonics	49.68	-8.30	41.38	54.00	12.62	AV
7440.40	V	Harmonics	70.92	-2.30	68.62	74.00	5.38	PK
9918.40	V	Harmonics	66.68	1.40	68.08	74.00	5.92	PK
12400.70	V	Harmonics	55.38	4.50	59.88	74.00	14.12	PK

Note:

If the maximized peak measured value complies with the average limit, then it is unnecessary to perform an average measurement.

Record the result only if the margin is 10 dB or less.

Test Result = Reading + Transducer Factor

Where, Transducer Factor = Cable loss + Preamplifier gain + Antenna factor + High Pass Filter

Pol.: H(Horizontal), V(Vertical)



**14.7 Test data for Radiated Restricted Band Edge Emission**

- Test Date : Sep. 04, 2023
- Reference Standard : Part 15 Subpart C, Sec. 15.247(d)
- Measuring Distance : 3 m
- Resolution Bandwidth : 1 MHz
- Detector mode : Peak detector mode / Average detector mode
- Power Source : DC 3.0 V
- Note : Through three orthogonal axes were investigated and the worst case is report

**Lowest channel (2402 MHz)**

Frequency (MHz)	Pol.	Reading [dBuV]	Transducer Factor [dB]	Test Result [dBuV/m]	Limits [dBuV/m]	Margin [dB]	Detector Type
2389.78	H	77.82	-18.20	59.62	74.00	14.38	PK

**Highest channel (2480 MHz)**

Frequency (MHz)	Pol.	Reading [dBuV]	Transducer Factor [dB]	Test Result [dBuV/m]	Limits [dBuV/m]	Margin [dB]	Detector Type
2438.90	H	86.98	-17.50	69.48	74.00	4.52	PK

Note:

If the maximized peak measured value complies with the average limit, then it is unnecessary to perform an average measurement.

Record the result only if the margin is 10 dB or less.

Test Result = Reading + Transducer Factor

Where, Transducer Factor = Cable loss + Pre-amplifier gain + Antenna factor

Pol.: H(Horizontal), V(Vertical)



## 15. Sample Calculations

$$\begin{aligned} \text{dB}\mu\text{V} &= 20 \text{ Log}_{10}(\mu\text{V}/\text{m}) \\ \text{dB}\mu\text{V} &= \text{dBm} + 107 \\ \mu\text{V} &= 10^{(\text{dB}\mu\text{V}/20)} \end{aligned}$$

### 15.1 Example 1 :

#### ■ 20.3 MHz

**Class B Limit** = 250  $\mu\text{V}$  = 48  $\text{dB}\mu\text{V}$

**Reading** = 39.2  $\text{dB}\mu\text{V}$

$10^{(39.2\text{dB}\mu\text{V}/20)}$  = 91.2  $\mu\text{V}$

**Margin** = 48  $\text{dB}\mu\text{V}$  - 39.2  $\text{dB}\mu\text{V}$

= 8.8  $\text{dB}$

### 15.2 Example 2 :

#### ■ 66.7 MHz

**Class B Limit** = 100  $\mu\text{V}/\text{m}$  = 40.0  $\text{dB}\mu\text{V}/\text{m}$

**Reading** = 31.0  $\text{dB}\mu\text{V}$

**Antenna Factor + Cable Loss** = 5.8  $\text{dB}$

**Total** = 36.8  $\text{dB}\mu\text{V}/\text{m}$

**Margin** = 40.0  $\text{dB}\mu\text{V}/\text{m}$  - 36.8  $\text{dB}\mu\text{V}/\text{m}$

= 3.2  $\text{dB}$



## 16. Recommendation & Conclusion

The data collected shows that the **Ohsung Electronics Co., Ltd. Remote Controller (Model Name: UR2-ST01)** was complies with §15.247 of the FCC Rules.

- The end -

