

EVALUATION REPORT *for Certification*

Applicant: Ohsung Electronics Co., Ltd.
#181 Gongdan-dong, Gumi-si, Gyeongsangbuk-Do
South Korea
Attn: Mr. Hak Ki, Kim/ General Manager

Date of Issue: Oct. 13, 2023
Order Number: GETEC-C1-23-608
Test Report Number: GETEC-E3-23-063
Test Site: GUMI UNIVERSITY EMC CENTER
CAB Designation Number: KR0033

RESPONSIBLE PARTY	: Ohsung Electronics Co., Ltd.
ADDRESS	: #181 Gongdan-dong, Gumi-si, Gyeongsangbuk-do, South Korea
CONTACT PERSON	: Mr. Hak-Ki, Kim / General Manager

Rule Part(s)	: FCC Part 15 Subpart C-Intentional Radiator § 15.247
Test Method	: ANSI C63.10 (2013)
Equipment Class	: Digital Transmission System(DTS)
EUT Type	: Wi-Fi Dongle
Type of Authority	: Certification
Model Name	: C307-HW-WF

This equipment has been shown to be in compliance with the applicable technical standards as indicated in the measurement report and was tested in accordance with the measurement procedures specified in ANSI C63.10 (2013)

I attest to the accuracy of data. All measurements reported herein were performed by me or were made under my supervision and are correct to the vest of my knowledge and belief. I assume full responsibility for the completeness of these measurements and vouch for the qualifications of all persons taking them.

Tested by,



Jong-Wook Park, Senior Engineer
GUMI UNIVERSITY EMC CENTER

Reviewed by,



Hyun Kim, Technical Manager
GUMI UNIVERSITY EMC CENTER



Version

Test Report No.	Date	Description
GETEC-E3-23-063	Oct. 13, 2023	- First Approval Report





CONTENTS

1. GENERAL INFORMATION	5
2. INTRODUCTION	6
3. PRODUCT INFORMATION	7
3.1 DESCRIPTION OF EUT.....	7
3.2 DEFINITION OF MODELS.....	7
3.3 SUPPORT EQUIPMENT / CABLES USED	8
3.4 MODIFICATION ITEM(S).....	9
4. ANTENNA REQUIREMENT - §15.203	10
4.1 DESCRIPTION OF ANTENNA.....	10
5. DESCRIPTION OF TESTS.....	10
5.1 TEST CONDITION.....	10
6. REFERENCES STANDARDS	10
8. SUMMARY OF TEST RESULTS	11
9. 6 DB BANDWIDTH MEASUREMENT	12
9.1 OPERATING ENVIRONMENT.....	12
9.2 TEST SET-UP (LAYOUT)	12
9.3 LIMIT	12
9.4 TEST EQUIPMENT USED.....	12
9.5 TEST PROCEDURE	12
9.6 TEST RESULT	13
10. CONDUCTED MAXIMUM PEAK OUTPUT POWER MEASUREMENT.....	17
10.1 OPERATING ENVIRONMENT	17
10.2 TEST SET-UP (LAYOUT)	17
10.3 LIMIT	17
10.4 TEST EQUIPMENT USED.....	17
10.5 TEST PROCEDURE	17
10.6 TEST RESULT	18
11. POWER SPECTRAL DENSITY MEASUREMENT	19
11.1 OPERATING ENVIRONMENT	19
11.2 TEST SET-UP (LAYOUT)	19
11.3 LIMIT	19
11.4 TEST EQUIPMENT USED.....	19
11.5 TEST PROCEDURE.....	19
11.6 TEST RESULT	20
12. CONDUCTED SPURIOUS EMISSION & OUT OF BAND EMISSION	24
12.1 OPERATING ENVIRONMENT	24
12.2 TEST SET-UP (LAY-OUT).....	24
12.3 LIMIT	24
12.4 TEST EQUIPMENT USED	24
12.5 TEST PROCEDURE	24
12.6 TEST RESULT	25



13. AC POWER LINE CONDUCTED EMISSION	35
13.1 OPERATING ENVIRONMENT	36
13.2 TEST SET-UP	36
13.3 MEASUREMENT UNCERTAINTY.....	36
13.4 LIMIT	37
13.5 TEST EQUIPMENT USED.....	37
13.6 TEST DATA FOR CONDUCTED EMISSION	37
13.7 TEST RESULT	38
14. RADIATED SPURIOUS & RESTRICTED BAND EDGE EMISSION.....	39
14.1 OPERATING ENVIRONMENT	40
14.2 TEST SET-UP.....	40
14.3 MEASUREMENT UNCERTAINTY	40
14.4 LIMIT	41
14.5 TEST EQUIPMENT USED.....	41
14.6 TEST DATA FOR RADIATED SPURIOUS EMISSION.....	42
15. SAMPLE CALCULATIONS.....	44
15.1 EXAMPLE 1 :	44
15.2 EXAMPLE 2 :	44
16. RECOMMENDATION & CONCLUSION.....	45
APPENDIX A – ATTESTATION STATEMENT	
APPENDIX B – LABELLING	
APPENDIX C – BLOCK DIAGRAM	
APPENDIX D – SCHEMATIC DIAGRAM	
APPENDIX E – TEST SETUP PHOTOGRAPH	
APPENDIX F – EXTERNAL PHOTOGRAPH	
APPENDIX G – INTERNAL PHOTOGRAPH	
APPENDIX H – USER’S MANUAL	
APPENDIX I – OPERATIONAL DESCRIPTION	
APPENDIX J – ANTENNA SPECIFICATION	
APPENDIX K – PART LIST	
APPENDIX L – RF EXPOSURE EVALUATION	



Scope: Measurement and determination of electromagnetic emissions (EME) of radio frequency devices including intentional and / or unintentional radiators for compliance with technical rules and regulations of the Federal Communications Commission.

1. General Information

Applicant: Ohsung Electronics Co., Ltd.
Applicant Address: #181 Gongdan-dong, Gumi-si, Gyeongsangbuk-do, South Korea
Manufacturer: Ohsung Electronics Co., Ltd.
Manufacturer Address: #181 Gongdan-dong, Gumi-si, Gyeongsangbuk-do, South Korea
Contact Person: Mr. Hak ki, Kim/ General Manager
Telephone Number: +82-54-468-7281 Fax Number: +82-54-461-8368

- **FCC ID.** OZ5C307-HW-WF
- **Equipment Class** Digital Transmission System (DTS)
- **EUT Type** Wi-Fi Dongle
- **Model Name** C307-HW-WF
- **Rule Part(s)** FCC Part 15 Subpart C-Intentional Radiator § 15.247
- **Test Method** ANSI C63.10 (2013)
- **Type of Authority** Certification
- **Test Procedure(s)** ANSI C63.10 (2013), KDB558074 D01 DTS Meas Guidance v05r02
- **Dates of Test** Oct. 10, 2023 ~ Oct. 13, 2023
- **Place of Test** **GUMI UNIVERSITY EMC CENTER**
37 Yaeun-ro, Gumi-si, Gyeongsangbuk-do, 730-711, Republic of Korea
(FCC Test firm Registration No.: 269701)
(ISED Test Site Registration No.: 7620A)
- **Test Report Number** GETEC-E3-23-063
- **Dates of Issue** Oct. 13, 2023



2. Introduction

The measurement procedure described in American National Standard for Methods of Measurement of Radio-Nose Emissions From Low-Voltage Electrical and Electronic Equipment in the Range of 9 kHz to 40 GHz (ANSI C63.4-2014) was used in determining radiated and conducted emissions emanating from **Ohsung Electronics Co., Ltd. Wi-Fi Dongle. (Model name: C307-HW-WF)**

These measurement tests were conducted at **GUMI UNIVERSITY EMC CENTER.**

The site address is 37 Yaeun-ro, Gumi-si, Gyeongsangbuk-do, 730-711, South Korea

This test site is one of the highest point of Gumi 1 college at about 200 kilometers away from Seoul city and 40 kilometers away from Daejeon city. It is located in the valley surrounded by mountains in all directions where ambient radio signal conditions are quiet and a favorable area to measure the radio frequency interference on open field test site for the computing and ISM devices manufactures. The detailed description of the measurement facility was found to be in compliance with the requirements of §2.948 according to ANSI C63.10 (2013)

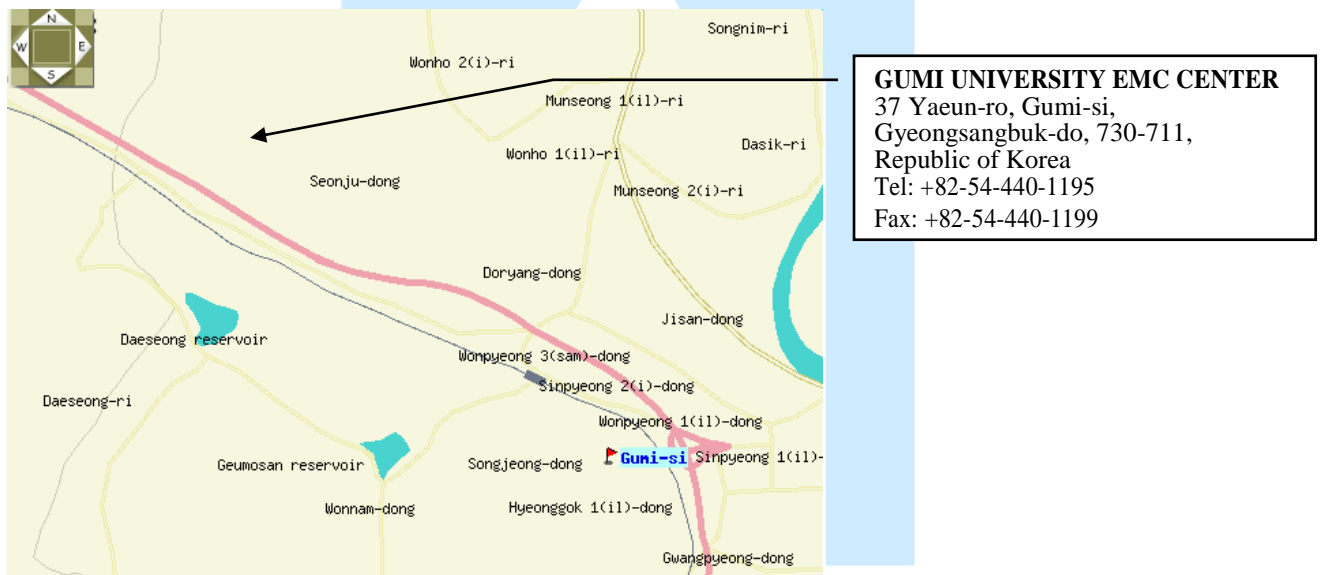

Fig 1. The map above shows the Gumi University in vicinity area.



3. Product Information

3.1 Description of EUT

The Equipment under Test (EUT) is the **Ohsung Electronics Co., Ltd. Wi-Fi Dongle. (Model name: C307-HW-WF)**
FCC ID.: OZ5C307-HW-WF

- . Equipment	: Wi-Fi Dongle	
- . Model name	: C307-HW-WF	
- . Serial number	: Proto type	
- . Electrical Rating	: DC 5 V	
- . Frequency Range	TX 20 MHz BW:	2412 MHz - 2462 MHz
	RX 20 MHz BW:	2412 MHz - 2462 MHz
- . Type of Modulation	: BPSK, QPSK, QAM, CCK, OFDM	
- . Type of chain	: One	
- . Antenna specification	: Manufacturer: Ohsung Electronics Co., Ltd. Antenna type : PCB Pattern antenna Peak Gain : 2.94 dBi	

3.2 Definition of models

-None.



3.3 Support Equipment / Cables used

3.3.1 Used Support Equipment

Description	Manufacturer	Model Name	S/N & FCC ID.
Router	EFM Networks	N104Q	S/N: 6CA01853 FCC ID.: -
AC/DC adapter #1 (Router)	ZIONCOM (VIETNAM) Co., LTD	DCP015A050600K	S/N: E1064 23022205765 FCC ID.: -
Test jig PCB #1	Ohsung Electronics Co., Ltd.	N/A	S/N: - FCC ID.: -
Test jig PCB #2	Ohsung Electronics Co., Ltd.	N/A	S/N: - FCC ID.: -
AC/DC adapter #2 (Test jig PCB #1)	LOADUS	EQ-4212Fctc	S/N: EQ23180021838 FCC ID.: -
USB LAN card	RIVER NETWORK	NX-UG29DH1	S/N: - FCC ID.: -
Notebook computer	Samsung Electronics Co., Ltd.	NT500R3W	S/N: 0Q2V91JJ100096T FCC ID.: -

3.3.2 System configuration

Description	Manufacturer	Model Name	S/N & FCC ID.
None.	-	-	S/N: - FCC ID.: -



3.3.3 Used Cable(s)

Cable Name	Condition		Description
	In(I/O port)	Out(I/O port)	
LAN	USB LAN card	Router	1.00 m Shielded
LAN	Test jig PCB #1	Router	1.00 m Unshielded
DC power	Router	AC/DC adapter #1	1.00 m Unshielded with 2 ferrite core
DC power	Test jig PCB #1	AC/DC adapter #2	1.00 m Unshielded with 2 ferrite core
AC power	AC/DC adapter #2	AC power source	1.50 m Unshielded with 3 ferrite core
USB	Notebook computer	Test jig PCB #2	1.00 m Unshielded with a ferrite core
USB	Test jig PCB #1	EUT	2.00 m Unshielded with 2 ferrite core

3.4 Modification Item(s)

- None



4. Antenna Requirement - §15.203

An intentional radiator antenna shall be designed to ensure that no antenna other than that furnished by the applicant can be used with the device. The use of permanently attached antenna or of an antenna that uses a unique coupling to the intentional radiator shall be considered sufficient to comply with this requirement.

4.1 Description of Antenna

The **Ohsung Electronics Co., Ltd. Wi-Fi Dongle**. comply with the requirement of §15.203 with a built-in PCB pattern antenna permanently attached to the transmitter.

5. Description of tests

5.1 Test Condition

The EUT was installed, arranged and operated in a manner that is most representative of equipment as typically used. The measurements were carried out while varying operating modes and cable positions within typically arrangement to determine maximum emission level.

The representative and worst test mode(s) were noted in the test report.

- Test Voltage / Frequency: 5 V / DC
- Operating condition during the test(s) :
 - . Continuous RF transmitting mode with maximum RF output power.
 - . Operating channel frequency and moderation technology

	Mode	Available channel	Frequency	Modulation Technology
DTS	802.11b	1 ~ 11	2412 ~ 2462 MHz	DSSS
	802.11g	1 ~ 11	2412 ~ 2462 MHz	OFDM
	802.11n (HT20)	1 ~ 11	2412 ~ 2462 MHz	OFDM

- . EUT set condition (Test Software)

Test Software	Dut labtool
Test Software version	2.0.0.92

6. References Standards

- FCC Part 15 (2009) Subpart C-Intentional Radiator §15.247
- ANSI C 63.10 (2013): American National Standard for Testing Unlicensed Wireless Devices
- KDB 558074 D01 DTS meas Guidance v05r02: Guidance for Performing Compliance Measurements on Digital Transmission Systems (DTS) Operating Under §15.247



8. SUMMARY OF TEST RESULTS

FCC Part Section(s)	Test Description	Test Result
§15.247(a)(2)	6 dB Bandwidth	Pass
§15.247(b)(3)	Conducted Maximum Peak Output Power	Pass
§15.247(e)	Power Spectral Density	Pass
§15.247(d)	Conducted Out of Band Emission Emissions	Pass
§15.207(a)	AC Power line Conducted Emissions	Pass
§15.205, 15.209	Radiated Spurious Emissions	Pass
§15.247(d), 15.205, 15.209	Radiated Restricted Band Edge	Pass



9. 6 dB Bandwidth Measurement

9.1 Operating environment

Temperature : 30.8 °C
 Relative Humidity : 27.4 % R.H.

9.2 Test Set-up (Layout)

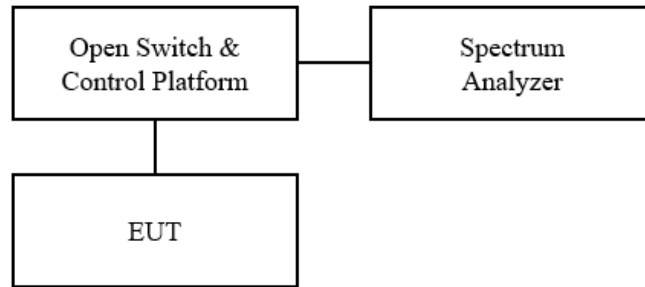

9.3 Limit

For digital modulation systems, the minimum 6 dB bandwidth shall be at least 500 kHz

9.4 Test Equipment used

Model Name	Manufacturer	Description	Serial Number	Due to Calibration
■ - FSV	Rohde & Schwarz	Spectrum Analyzer	101552	Apr. 06, 2024
■ - OSP120	Rohde & Schwarz	Open Switch and control platform	101329	Apr. 09. 2024
■ - J12J103539-00-2	JUNFLON	RF Test Cable (OSP_DUT1)	AUG-03-21-066	N/A
■ - J12J103539-00-3	JUNFLON	RF Test Cable (OSP_RX)	AUG-03-21-074	N/A
■ - WMS 32	Rohde & Schwarz	Testing Software	VER10.40.10	N/A

9.5 Test Procedure

- Set RBW = 100 kHz.
- Set the video bandwidth (VBW) $\geq 3 \times$ RBW.
- Detector = Peak.
- Trace mode = max hold.
- Sweep = auto couple.
- Allow the trace to stabilize.
- Measure the maximum width of the emission that is constrained by the frequencies associated with the two outermost amplitude points (upper and lower frequencies) that are attenuated by 6 dB relative to the maximum level measured in the fundamental emission.



9.6 Test result

- Test Date : Oct. 13, 2023
- Reference Standard : Part 15 Subpart C, Sec. 15.247(a)(2)
- Test Procedure(s) : ANSI C63.10 (2013), KDB558074 D01 DTS Meas Guidance v05r02
- Operating Condition : RF transmitting mode (1 ch: 2 412 MHz, 6 ch: 2 437 MHz, 11 ch: 2 462 MHz)
- Power Source : DC 5 V

IEEE 802.11b

Frequency (MHz)	6 dB Bandwidth (MHz)	Band Edge Left (MHz)	Band Edge Right (MHz)	Min. Limit (MHz)	Result
2 412	10.15	2406.92	2417.08	0.50	Complies
2 437	10.15	2431.92	2442.08	0.50	Complies
2 462	10.15	2456.92	2467.08	0.50	Complies

IEEE 802.11g

Frequency (MHz)	6 dB Bandwidth (MHz)	Band Edge Left (MHz)	Band Edge Right (MHz)	Min. Limit (MHz)	Result
2 412	16.45	2403.77	2420.23	0.50	Complies
2 437	16.45	2428.77	2445.23	0.50	Complies
2 462	16.45	2453.77	2470.23	0.50	Complies

IEEE 802.11n (HT20)

Frequency (MHz)	6 dB Bandwidth (MHz)	Band Edge Left (MHz)	Band Edge Right (MHz)	Min. Limit (MHz)	Result
2 412	17.65	2403.17	2420.83	0.50	Complies
2 437	17.65	2428.17	2445.83	0.50	Complies
2 462	17.65	2453.17	2470.83	0.50	Complies



6 dB Bandwidth Plot on Configuration : IEEE 802.11b 1ch

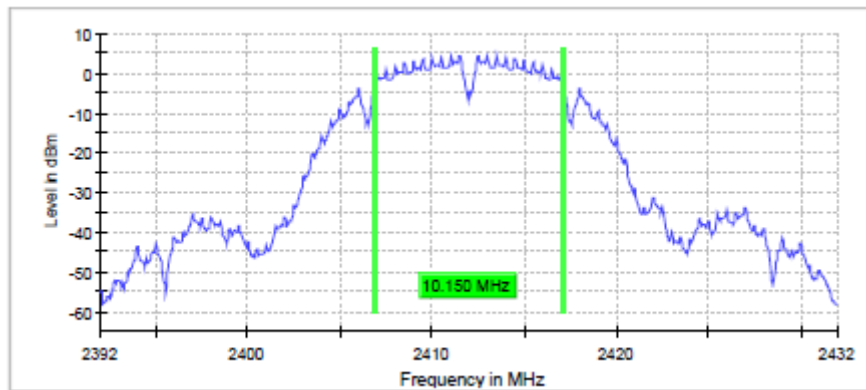

6 dB Bandwidth Plot on Configuration : IEEE 802.11b 6ch

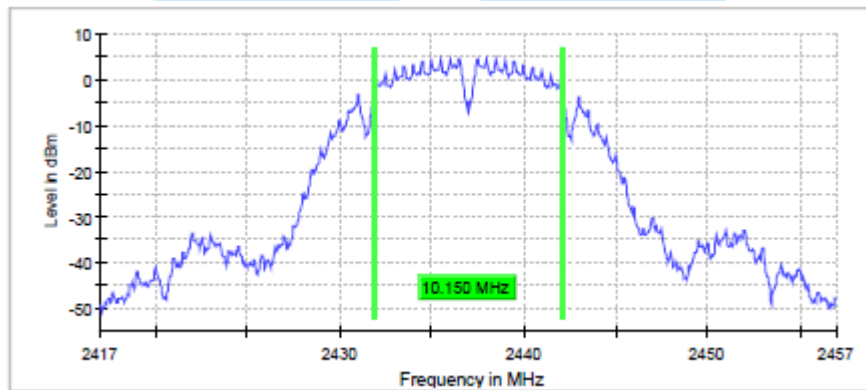

6 dB Bandwidth Plot on Configuration : IEEE 802.11b 11ch

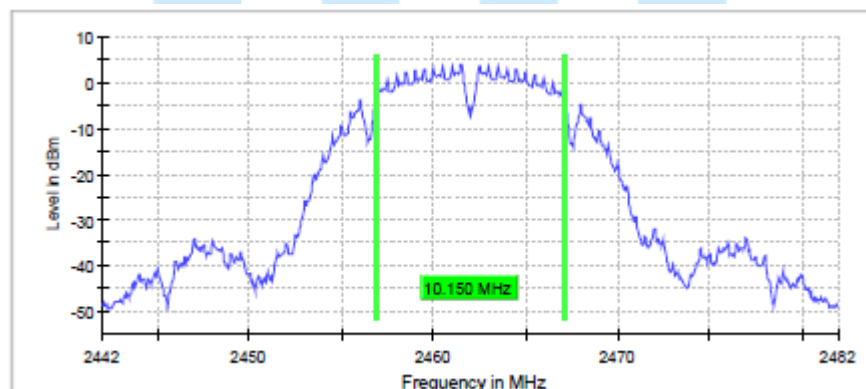



6 dB Bandwidth Plot on Configuration : IEEE 802.11g 1ch

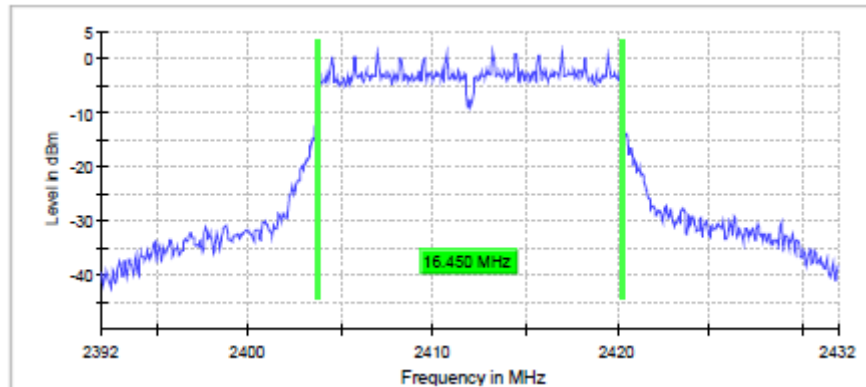

6 dB Bandwidth Plot on Configuration : IEEE 802.11g 6ch

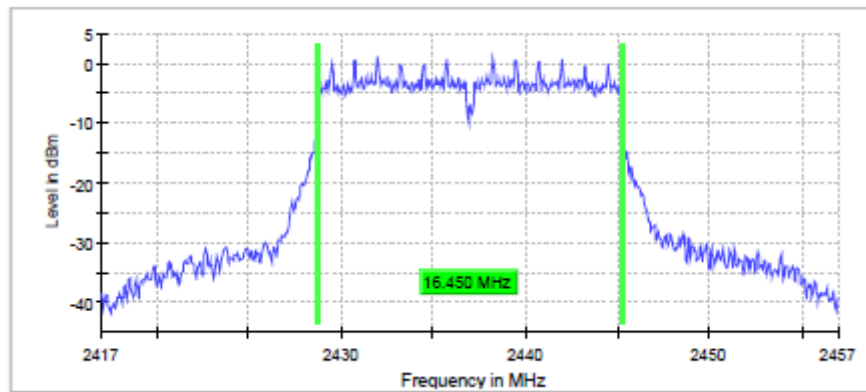

6 dB Bandwidth Plot on Configuration : IEEE 802.11g 11ch

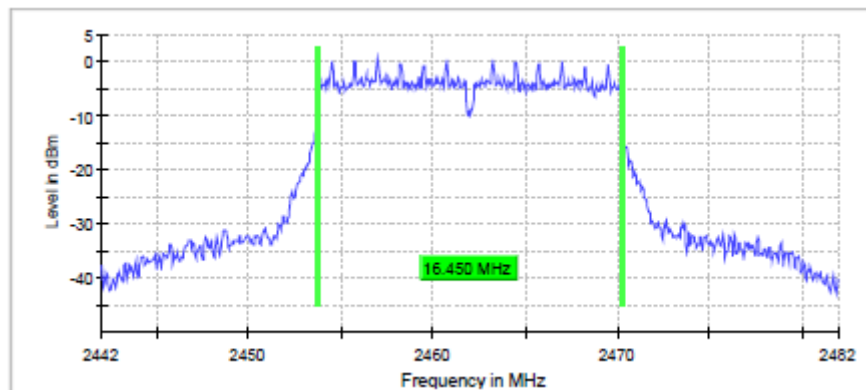



6 dB Bandwidth Plot on Configuration : IEEE 802.11n (HT20) 1ch

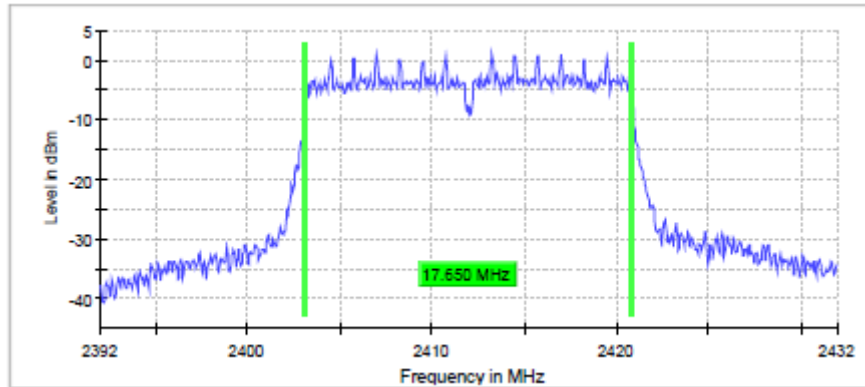

6 dB Bandwidth Plot on Configuration : IEEE 802.11n (HT20) 6ch

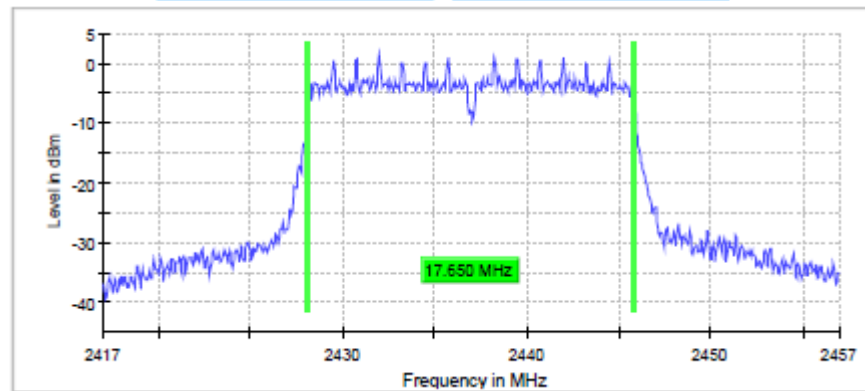

6 dB Bandwidth Plot on Configuration : IEEE 802.11n (HT20) 11ch

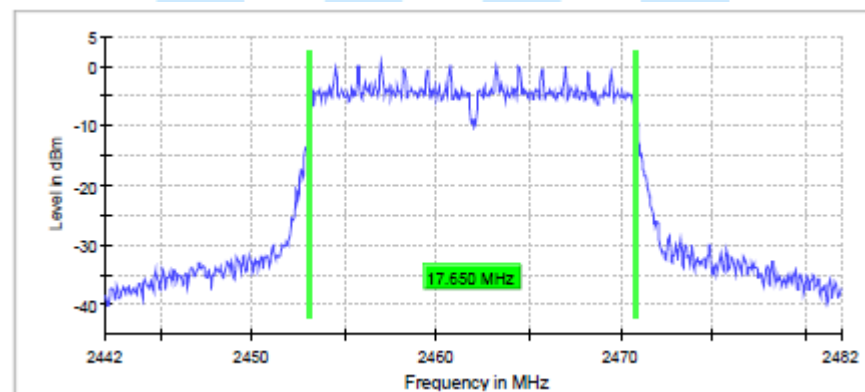



10. Conducted Maximum Peak Output Power Measurement

10.1 Operating environment

Temperature : 30.8 °C
Relative Humidity : 27.4 % R.H.

10.2 Test Set-up (Layout)

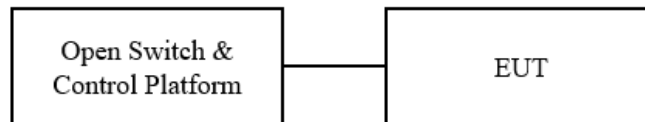

10.3 Limit

For systems using digital modulation in the (2 400~2 483.5) MHz, the limit for peak output power is 30 dBm. The limit has to be reduced by the amount in dB that the gain of the antenna exceeds 6 dBi. In case of point-to-point operation, the limit has to be reduced by 1 dB for every 3 dB that the directional gain of the antenna exceeds 6 dBi.

10.4 Test Equipment used

	Model Name	Manufacturer	Description	Serial Number	Due to Calibration
■ -	OSP120	Rohde & Schwarz	Open Switch and control platform	101329	Apr. 09. 2024
■ -	J12J103539-00-2	JUNFLON	RF Test Cable (OSP_DUT1)	AUG-03-21-066	N/A
■ -	WMS 32	Rohde & Schwarz	Testing Software	VER10.40.10	N/A

10.5 Test Procedure

A peak power sensor was used on the output port of the EUT. A power meter was used to read the response of the peak power sensor. Record the power level.



10.6 Test Result

- Test Date : Oct. 13, 2023
- Reference Standard : Part 15 Subpart C, Sec. 15.247(b)(3)
- Test Procedure(s) : ANSI C63.10 (2013), KDB558074 D01 DTS Meas Guidance v05r02
- Operating Condition : RF transmitting mode (1 ch: 2 412 MHz, 6 ch: 2 437 MHz, 11 ch: 2 462 MHz)
- Power Source : DC 5 V

IEEE 802.11b

Frequency (MHz)	Peak Conducted Power (dBm)	Average Conducted Power ¹⁾ (dBm)	Max. Limit (dBm)	Result
2 412	18.0	15.5	30.00	Complies
2 437	17.7	15.6	30.00	Complies
2 462	16.9	14.8	30.00	Complies

Note: 1) The Average output power is reference data for RF Exposure.

IEEE 802.11g

Frequency (MHz)	Peak Conducted Power (dBm)	Average Conducted Power ¹⁾ (dBm)	Max. Limit (dBm)	Result
2 412	22.6	13.2	30.00	Complies
2 437	22.5	13.2	30.00	Complies
2 462	21.9	12.5	30.00	Complies

Note: 1) The Average output power is reference data for RF Exposure.

IEEE 802.11n (HT20)

Frequency (MHz)	Peak Conducted Power (dBm)	Average Conducted Power ¹⁾ (dBm)	Max. Limit (dBm)	Result
2 412	22.3	13.2	30.00	Complies
2 437	22.0	13.2	30.00	Complies
2 462	21.4	12.6	30.00	Complies

Note: 1) The Average output power is reference data for RF Exposure.



11. Power Spectral Density Measurement

11.1 Operating Environment

Temperature : 30.8 °C
 Relative Humidity : 27.4 % R.H.

11.2 Test Set-up (Layout)

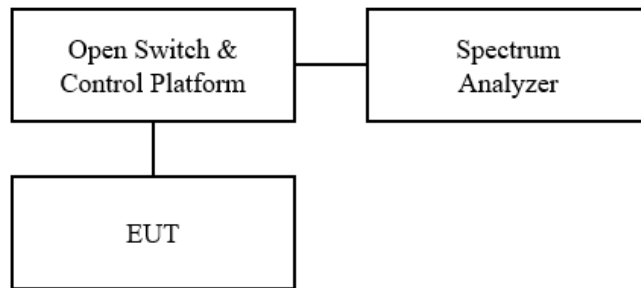

11.3 Limit

For digitally modulated systems, the power spectral density conducted from the intentional radiator to the antenna shall not be greater than 8 dBm in any 3 kHz band during any time interval of continuous transmission

11.4 Test Equipment used

Model Name	Manufacturer	Description	Serial Number	Due to Calibration
■ - FSV	Rohde & Schwarz	Spectrum Analyzer	101552	Apr. 06, 2024
■ - OSP120	Rohde & Schwarz	Open Switch and control platform	101329	Apr. 09, 2024
■ - J12J103539-00-2	JUNFLON	RF Test Cable (OSP_DUT1)	AUG-03-21-066	N/A
■ - J12J103539-00-3	JUNFLON	RF Test Cable (OSP_RX)	AUG-03-21-074	N/A
■ - WMS 32	Rohde & Schwarz	Testing Software	VER10.40.10	N/A

11.5 Test Procedure

- Set analyzer center frequency to DTS channel center frequency.
- Set span to at least 1.5 X OBW.
- Set the RBW to $3 \text{ kHz} \leq \text{RBW} \leq 100 \text{ kHz}$
- Set the VBW $\geq 3 \text{ X RBW}$
- Detector = power averaging (RMS) or sample detector (when RMS not available)
- Ensure that the number of measurement points in the sweep $\geq 2 \text{ X span/RBW}$
- Sweep time = auto couple.
- Employ trace averaging (RMS) mode over a minimum of 100 trace.
- use the peak marker function to determine the maximum amplitude level.
- If measured value exceeds limit, reduce RBW (no less than 3 kHz) and repeat (note that this may require zooming in on the emission of interest and reducing the span in order to meet the minimum measurement point requirement as the RBW is reduce).



11.6 Test Result

- Test Date : Oct. 13, 2023
- Reference Standard : Part 15 Subpart C, Sec. 15.247(e)
- Test Procedure(s) : ANSI C63.10 (2013), KDB558074 D01 DTS Meas Guidance v05r02
- Operating Condition : RF transmitting mode (1 ch: 2 412 MHz, 6 ch: 2 437 MHz, 11 ch: 2 462 MHz)
- Power Source : DC 5 V

IEEE 802.11b

Frequency	PSD (dBm/3kHz)	Max. Limit (dBm/3kHz)	Result
2 412 MHz	4.59	8.00	Complies
2 437 MHz	4.53	8.00	Complies
2 462 MHz	3.59	8.00	Complies

IEEE 802.11g

Frequency	PSD (dBm/3kHz)	Max. Limit (dBm/3kHz)	Result
2 412 MHz	1.15	8.00	Complies
2 437 MHz	1.22	8.00	Complies
2 462 MHz	0.69	8.00	Complies

IEEE 802.11n (HT20)

Frequency	PSD (dBm/3kHz)	Max. Limit (dBm/3kHz)	Result
2 412 MHz	1.24	8.00	Complies
2 437 MHz	1.26	8.00	Complies
2 462 MHz	0.67	8.00	Complies



Power Density Plot on configuration : IEEE 802.11b 1ch

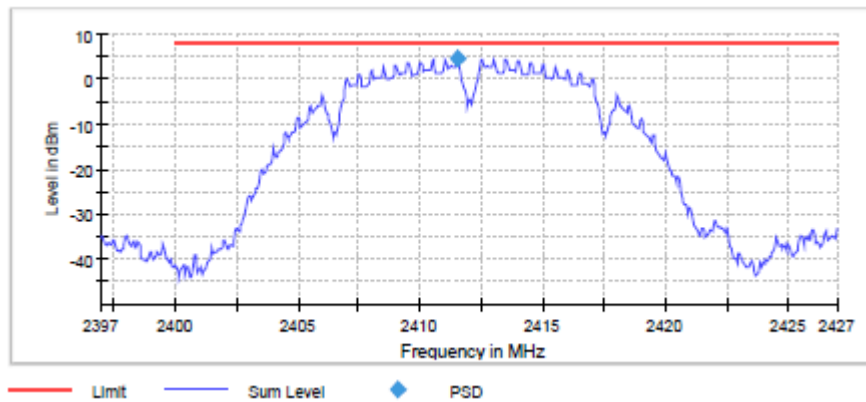

Power Density Plot on configuration : IEEE 802.11b 6ch

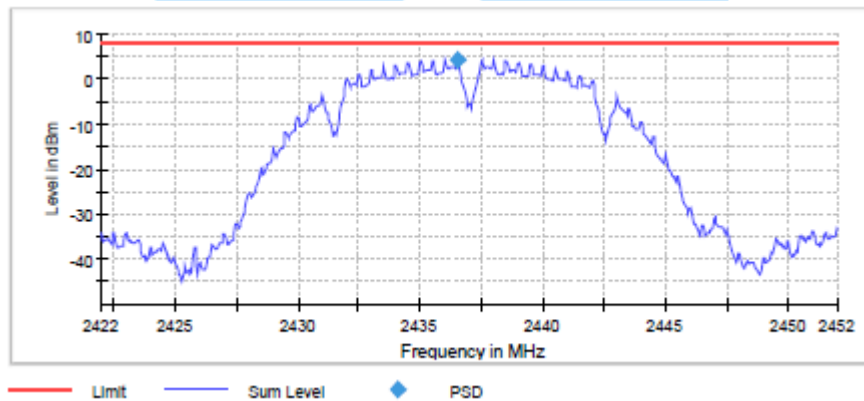

Power Density Plot on configuration : IEEE 802.11b 11ch

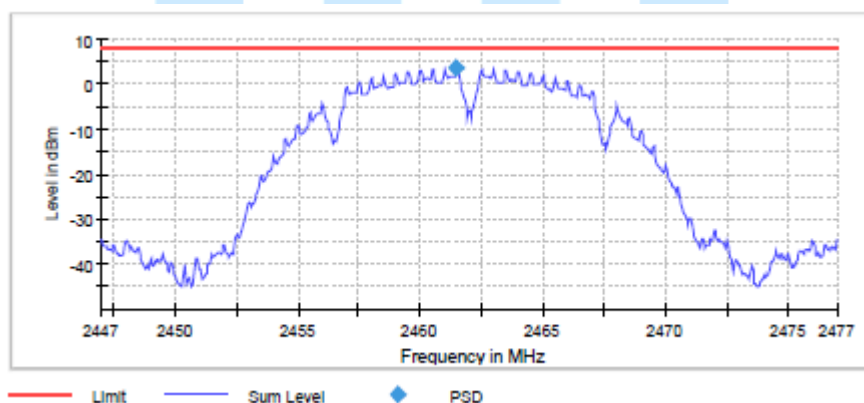



Power Density Plot on configuration : IEEE 802.11g 1ch

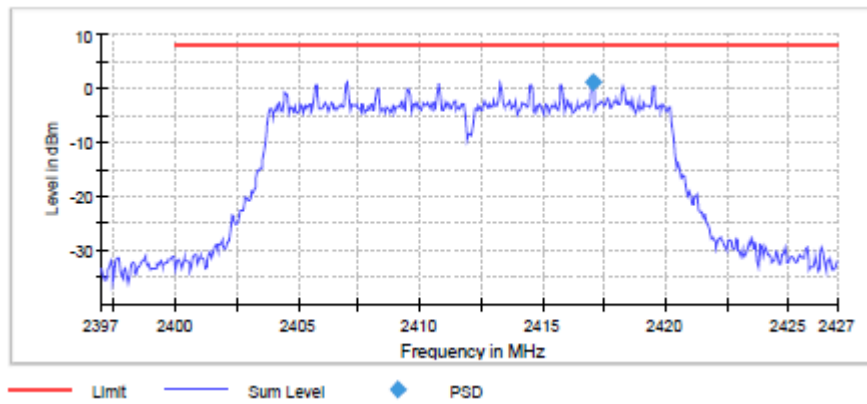

Power Density Plot on configuration : IEEE 802.11g 6ch

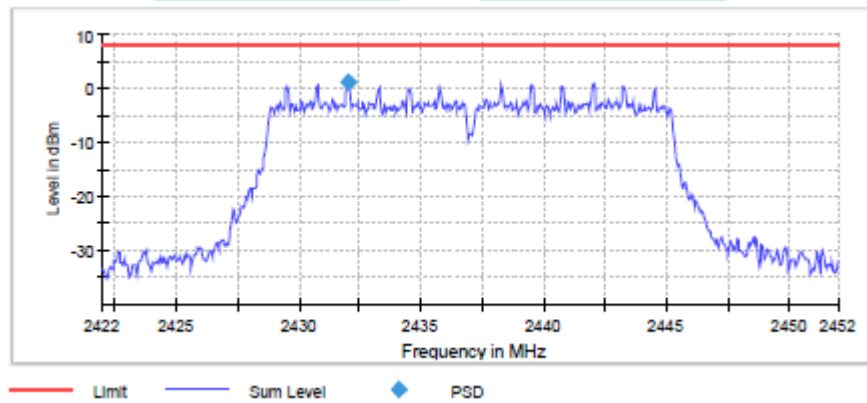

Power Density Plot on configuration : IEEE 802.11g 11ch

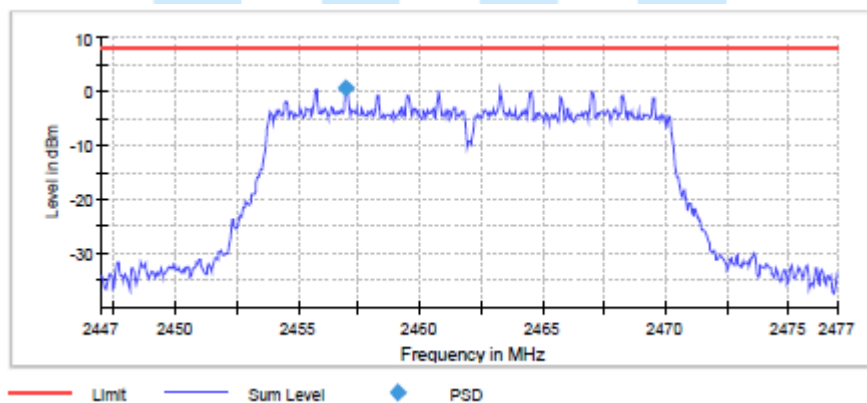



Power Density Plot on configuration : IEEE 802.11n (HT20) 1ch

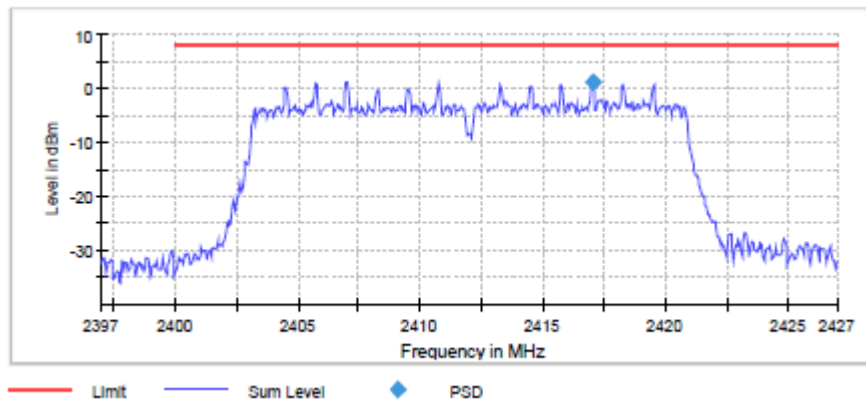

Power Density Plot on configuration : IEEE 802.11n (HT20) 6ch

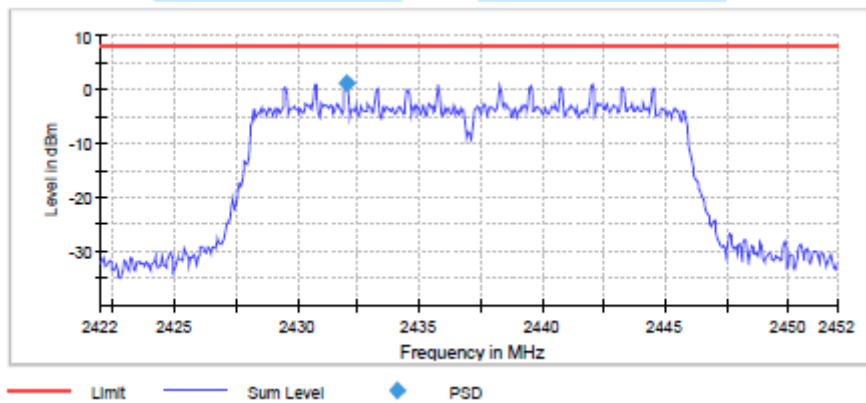

Power Density Plot on configuration : IEEE 802.11n (HT20) 11ch

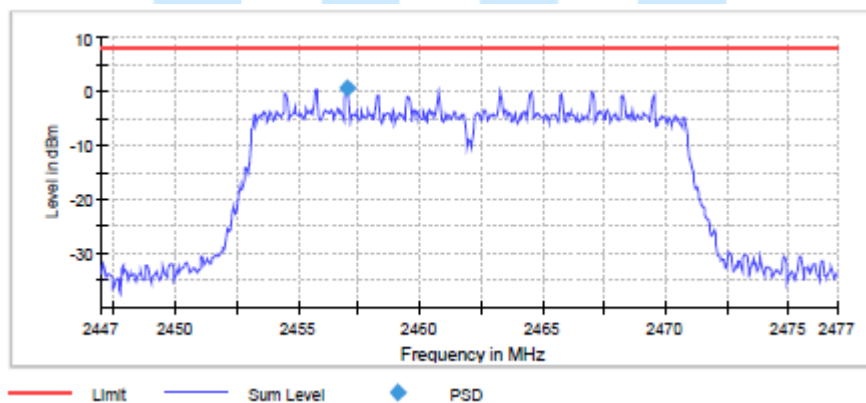



12. Conducted Spurious Emission & Out of Band Emission

12.1 Operating environment

Temperature : 27.5 °C
 Relative Humidity : 34.7 % R.H.

12.2 Test set-up (Lay-out)



12.3 Limit

Below -20 dB of the highest emission level of operating band (in 100 kHz resolution band width)

12.4 Test equipment used

Model Name	Manufacturer	Description	Serial Number	Due to Calibration
■ - FSV	Rohde & Schwarz	Spectrum Analyzer	101552	Apr. 06, 2024
■ - 56-10	Weinschel	10 dB Attenuator	53184	Apr. 09, 2024
■ - J12J102248-00-5	JUNFLON	RF Test Cable (26.5 GHz_1)	JUL-06-14-106	N/A

12.5 Test Procedure

- Set analyzer center frequency to DTS channel center frequency.
- Set the span to $\geq 1.5 \times$ DTS bandwidth.
- Set the RBW = 100 kHz
- Set the VBW $\geq 3 \times$ RBW
- Detector = peak.
- Sweep time = auto couple.
- Trace mode = max hold.
- Allow trace to fully stabilize.
- Use the peak marker function to determine the maximum PSD level.



12.6 Test Result

- Test Date : Oct. 10, 2023
- Reference standard : Part 15 Subpart C, Sec. 15.247(d)
- Test Procedure(s) : ANSI C63.10 (2013), KDB558074 D01 DTS Meas Guidance v05r02
- Operating condition : RF transmitting mode (1 ch: 2 412 MHz, 6 ch: 2 437 MHz, 11 ch: 2 462 MHz)
- Power Source : DC 5 V

Conducted Spurious Emission

IEEE 802.11b

Operating Frequency	Fundamental Level (dBm)	Spurious Level (dBm)	Deviation (dBc)	Limits (dBc)	Result
2 412 MHz	4.91	-38.28	-43.19	-20.00	Complies
2 437 MHz	4.33	-39.28	-43.61		Complies
2 462 MHz	3.97	-38.55	-42.52		Complies

IEEE 802.11g

Operating Frequency	Fundamental Level (dBm)	Spurious Level (dBm)	Deviation (dBc)	Limits (dBc)	Result
2 412 MHz	1.51	-38.32	-39.83	-20.00	Complies
2 437 MHz	0.85	-39.76	-40.61		Complies
2 462 MHz	0.67	-39.11	-39.78		Complies

IEEE 802.11n (HT20)

Operating Frequency	Fundamental Level (dBm)	Spurious Level (dBm)	Deviation (dBc)	Limits (dBc)	Result
2 412 MHz	1.32	-38.80	-40.12	-20.00	Complies
2 437 MHz	0.87	-39.39	-40.26		Complies
2 462 MHz	0.92	-38.46	-39.38		Complies



Conducted Out of Band(Band Edge) Emission
IEEE 802.11b

Operating Frequency	Fundamental Level (dBm)	Bandedge Level (dBm)	Deviation (dBc)	Limits (dBc)	Result
2 412 MHz	4.91	-32.92	-37.83	-20.00	Complies
2 462 MHz	3.97	-47.87	-51.84		Complies

IEEE 802.11g

Operating Frequency	Fundamental Level (dBm)	Bandedge Level (dBm)	Deviation (dBc)	Limits (dBc)	Result
2 412 MHz	1.51	-29.66	-31.17	-20.00	Complies
2 462 MHz	0.67	-44.34	-45.01		Complies

IEEE 802.11n (HT20)

Operating Frequency	Fundamental Level (dBm)	Bandedge Level (dBm)	Deviation (dBc)	Limits (dBc)	Result
2 412 MHz	1.32	-28.79	-30.11	-20.00	Complies
2 462 MHz	0.92	-38.92	-39.84		Complies



Conducted spurious Emission Plot on Configuration : IEEE 802.11b 1ch

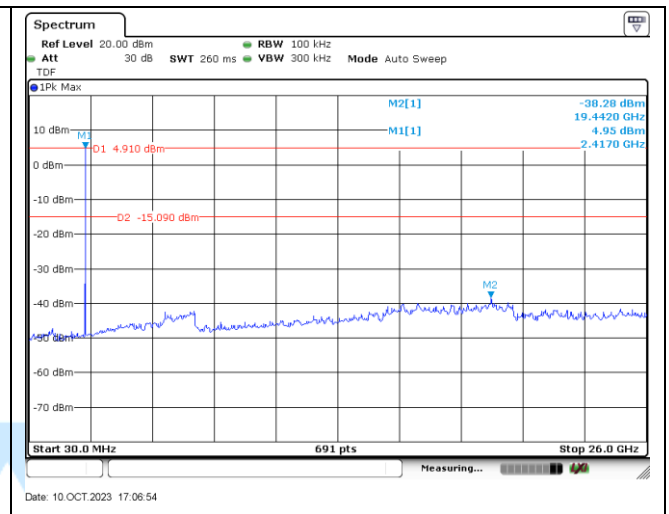
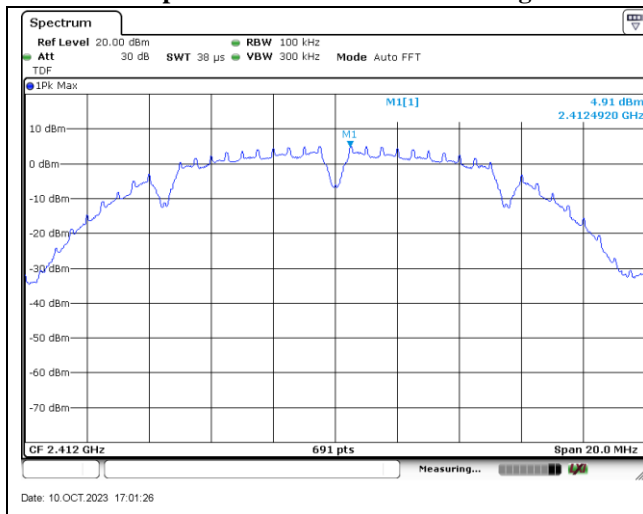

Conducted spurious Emission Plot on Configuration : IEEE 802.11b 6ch

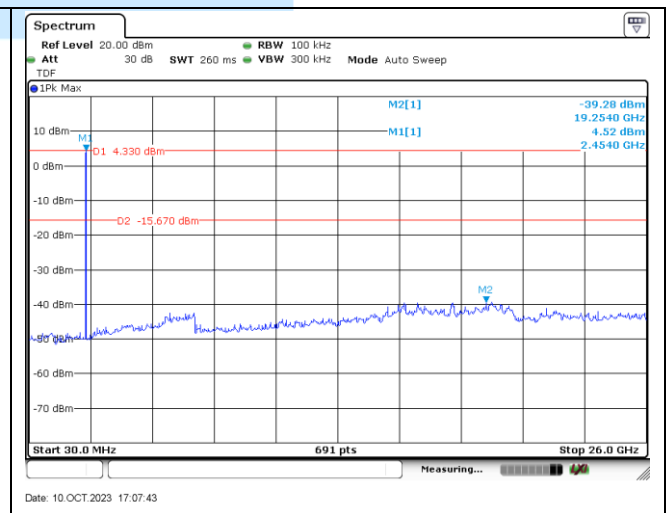
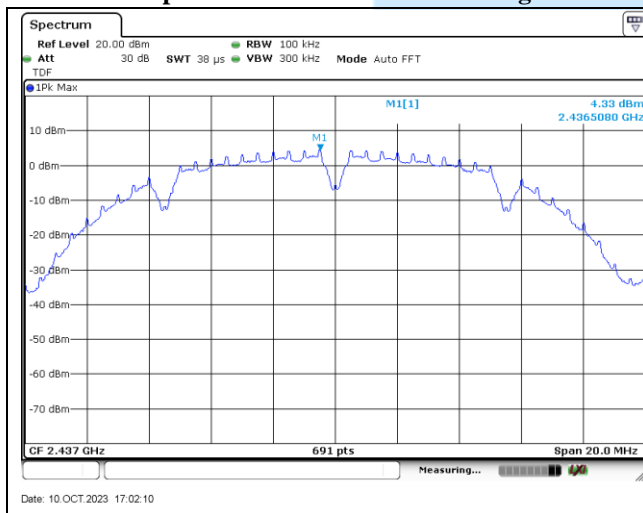



Conducted spurious Emission Plot on Configuration : IEEE 802.11b 11ch

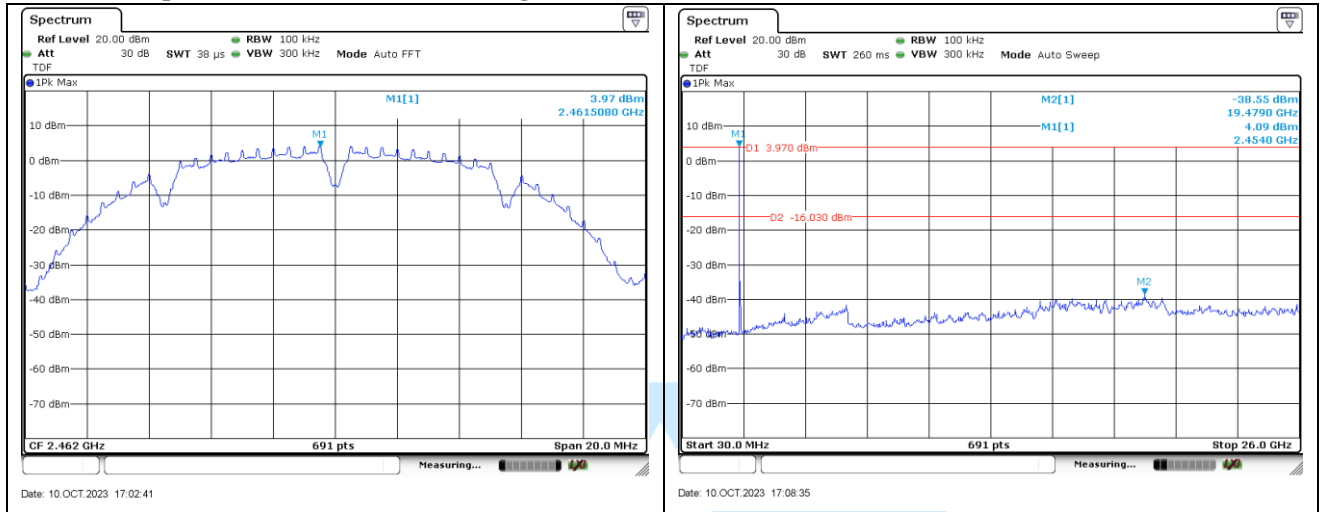

Conducted spurious Emission Plot on Configuration : IEEE 802.11g 1ch

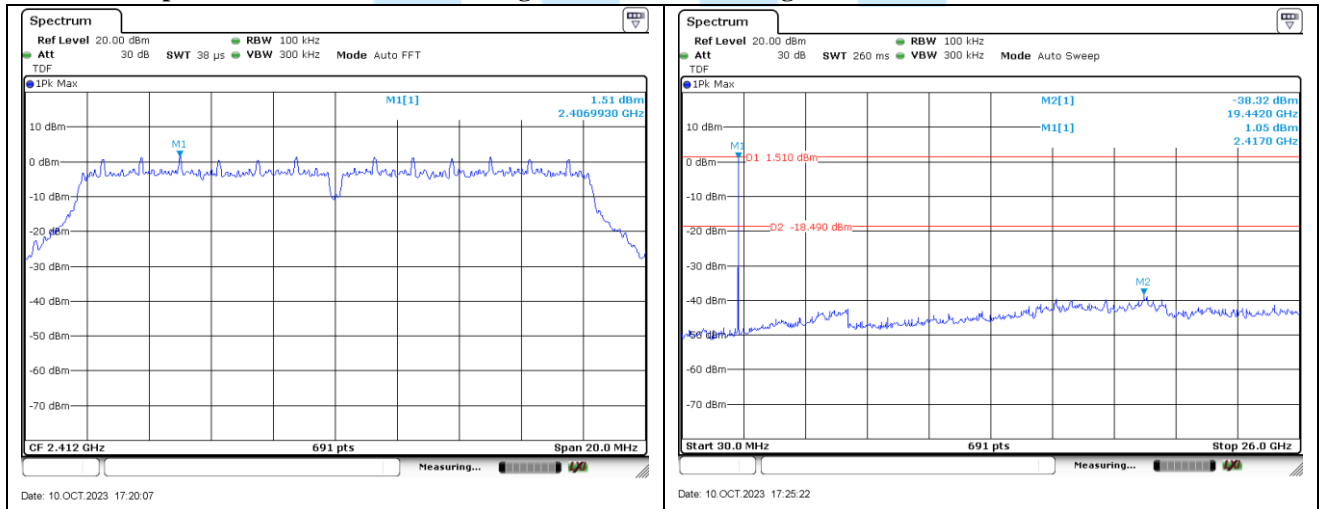



Conducted spurious Emission Plot on Configuration : IEEE 802.11g 6ch

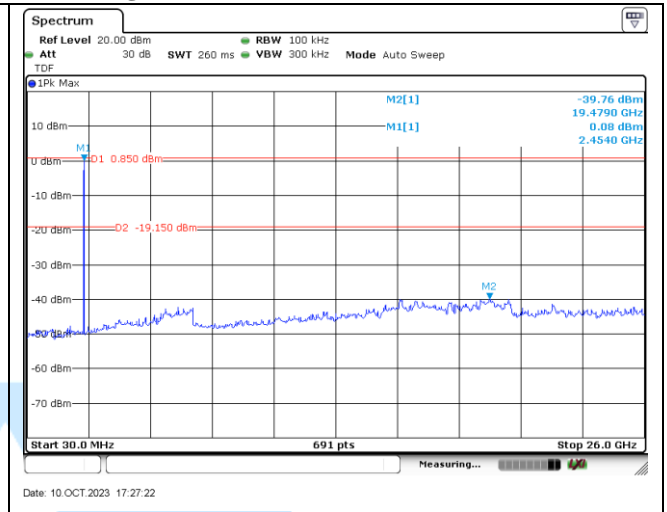
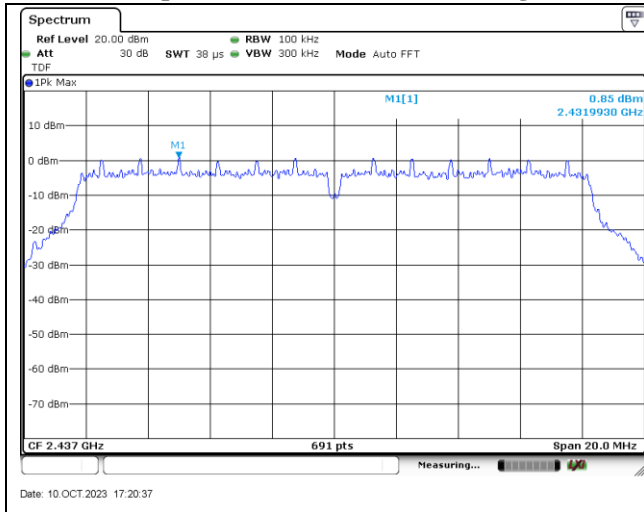

Conducted spurious Emission Plot on Configuration : IEEE 802.11g 11ch

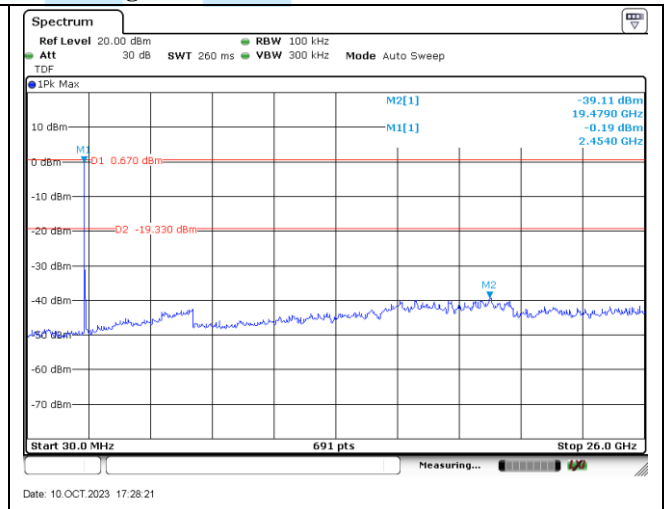
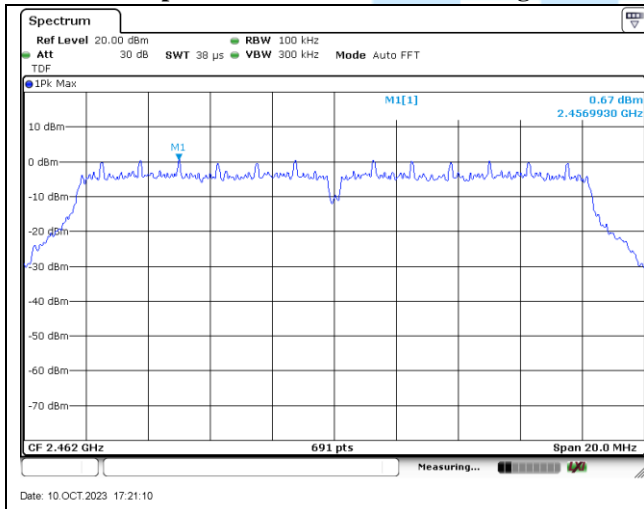



Conducted spurious Emission Plot on Configuration : IEEE 802.11n (HT20) 1ch

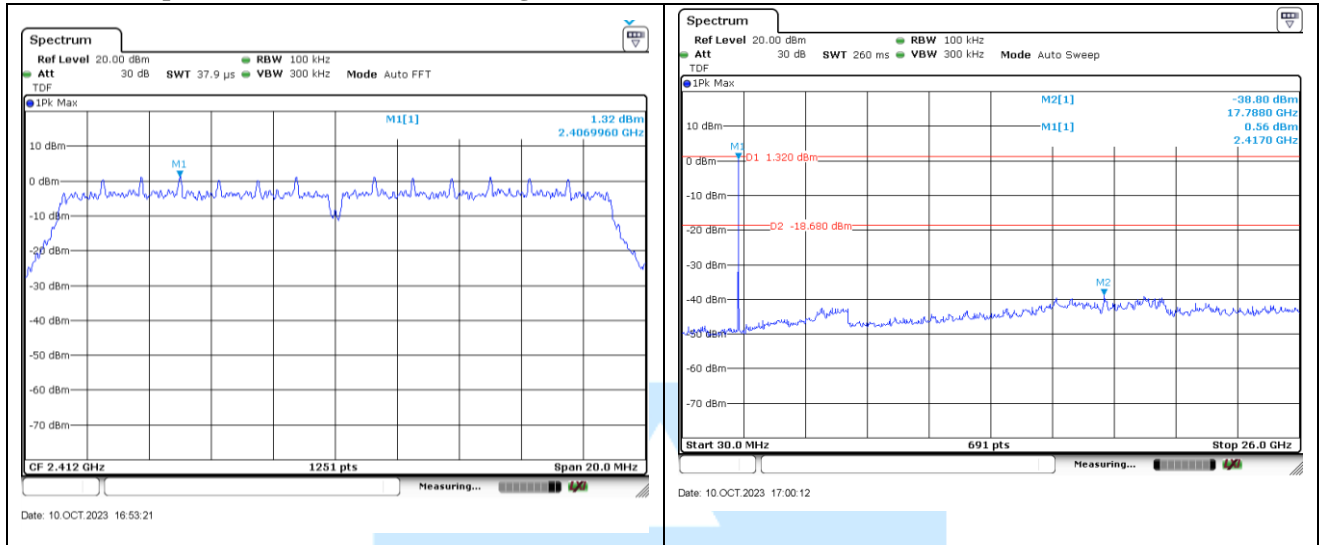

Conducted spurious Emission Plot on Configuration : IEEE 802.11n (HT20) 6ch

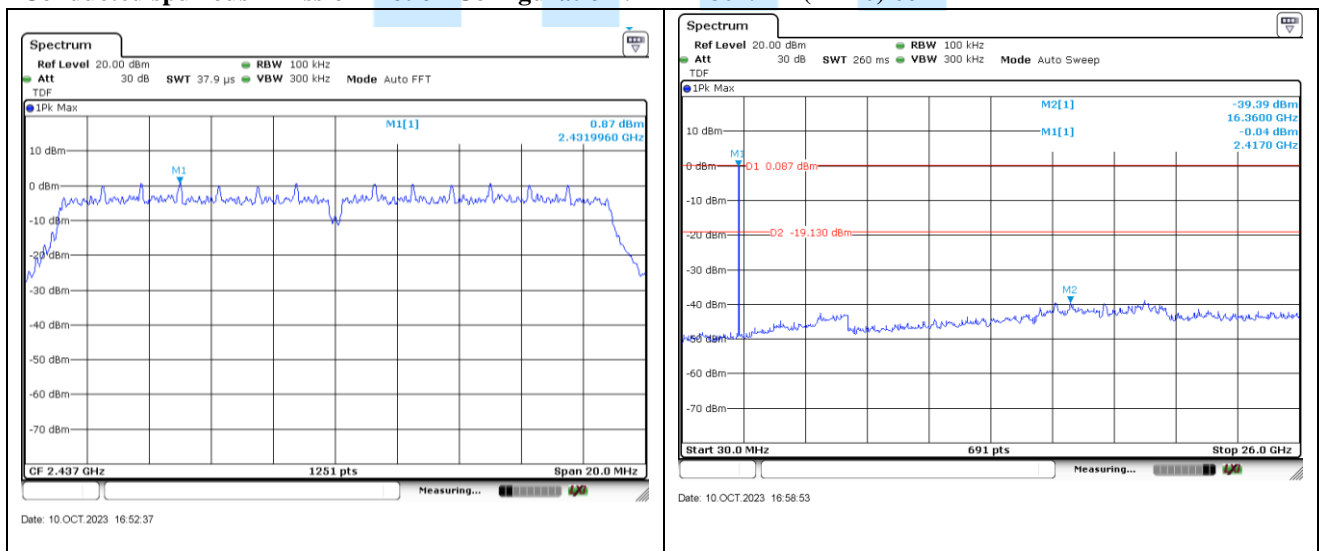



Conducted spurious Emission Plot on Configuration : IEEE 802.11n (HT20) 11ch

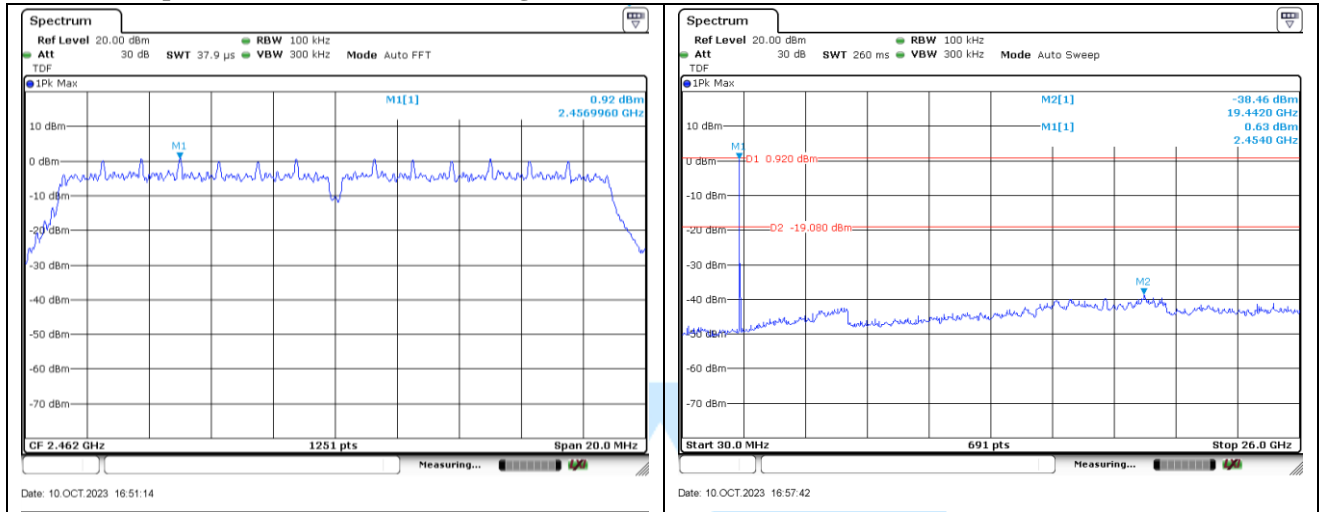



Low Band Edge Plot on Configuration : IEEE 802.11b 1ch

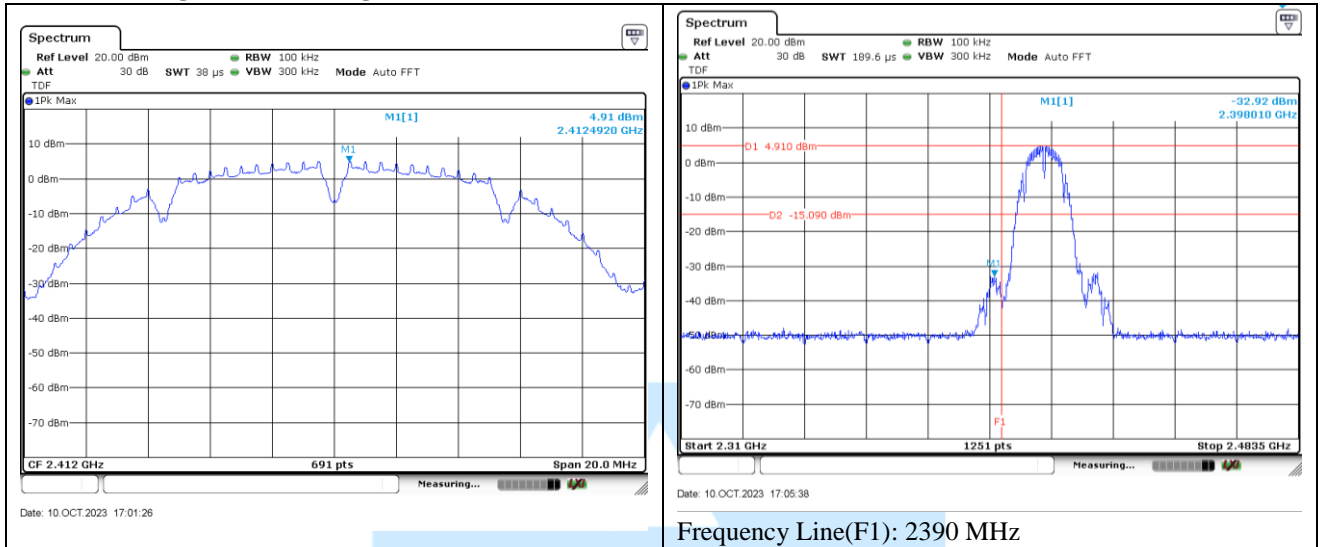

High Band Edge Plot on Configuration : IEEE 802.11b 11ch

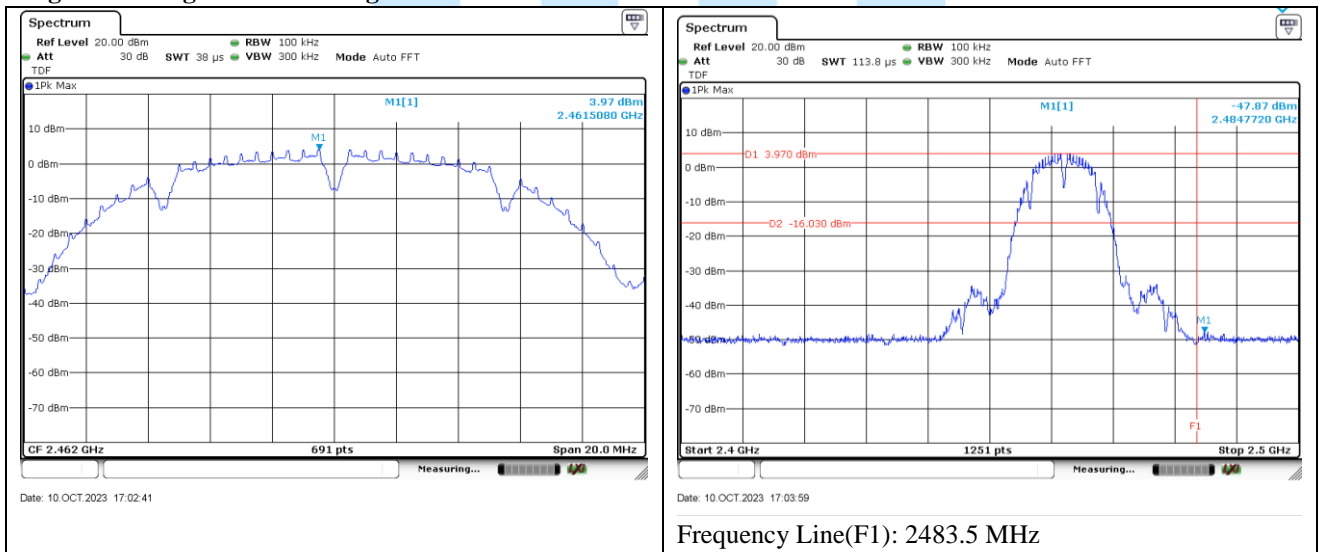



Low Band Edge Plot on Configuration : IEEE 802.11g 1ch

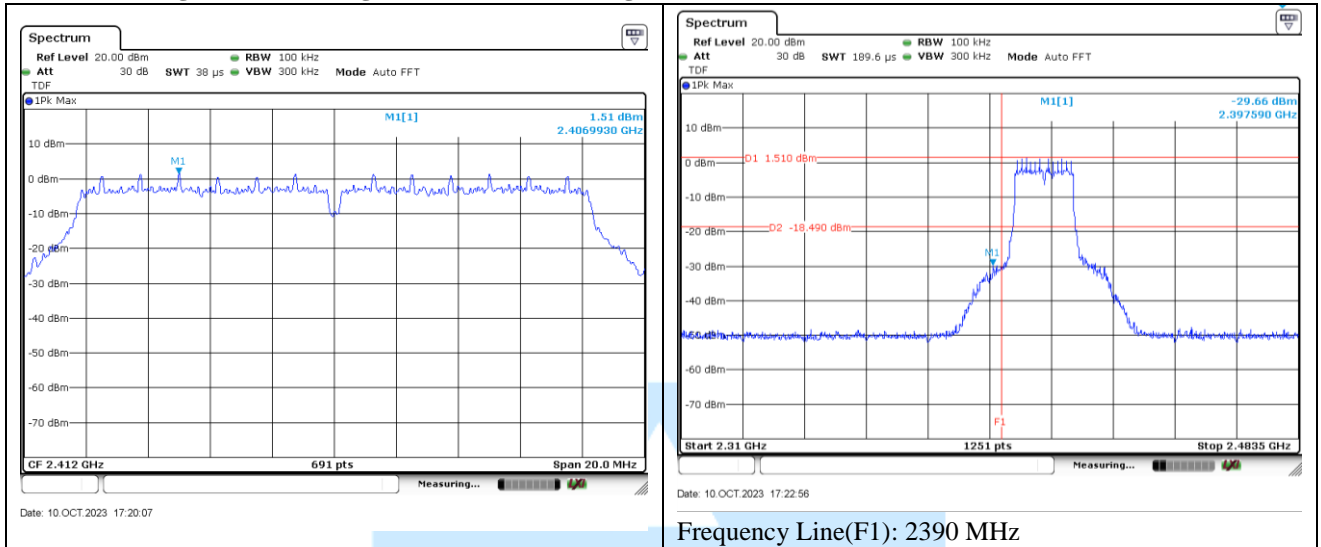

High Band Edge Plot on Configuration : IEEE 802.11g 11ch

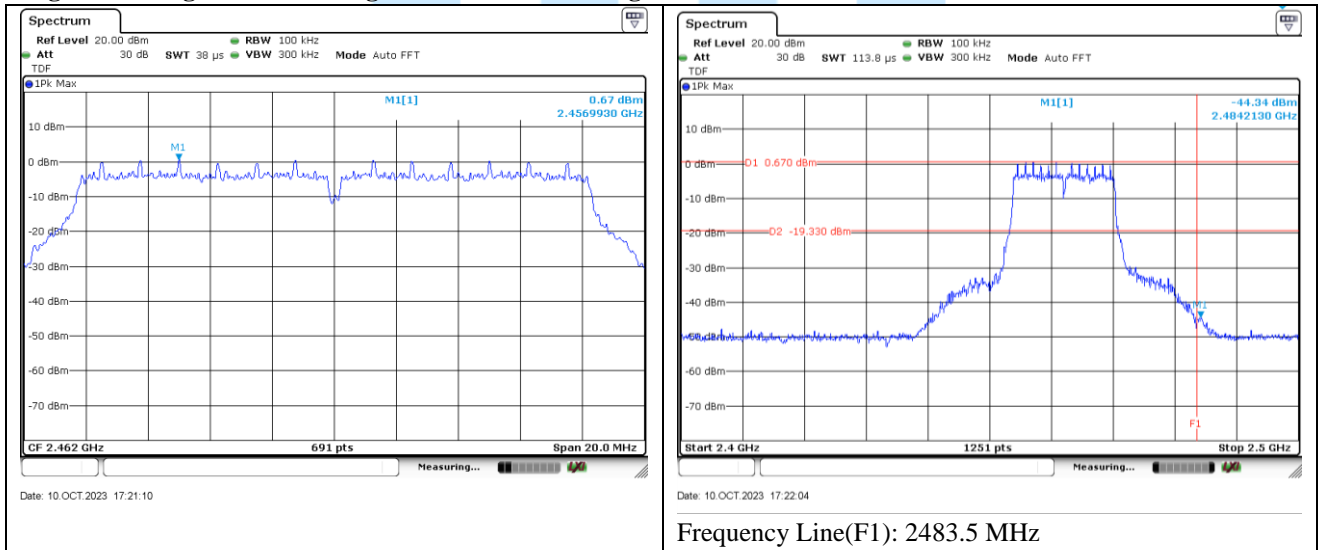



Low Band Edge Plot on Configuration : IEEE 802.11n (HT20) 1ch

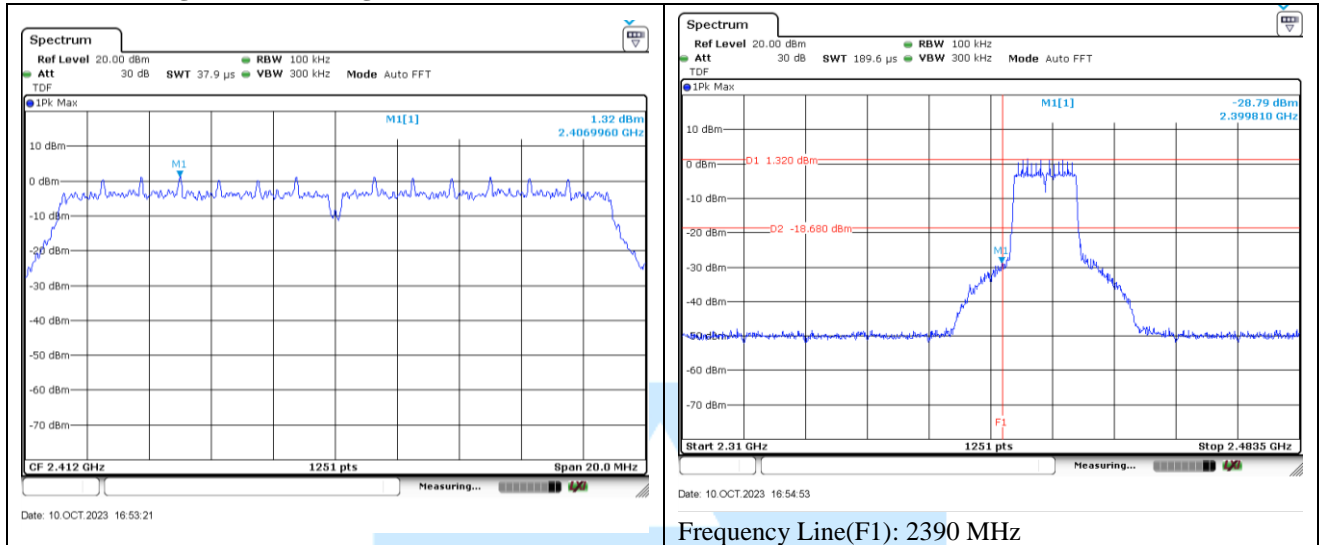

High Band Edge Plot on Configuration : IEEE 802.11n (HT20) 11ch

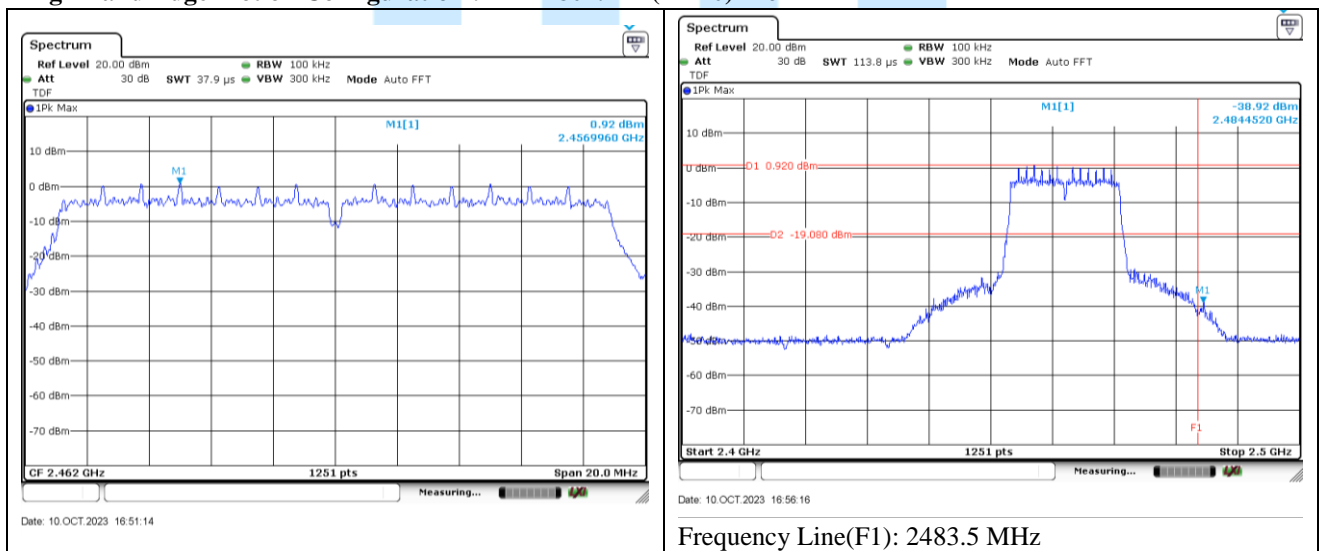



13. AC Power line Conducted emission

-Test Description

The Line conducted emission test facility is inside a 4 m × 8 m × 2.5 m shielded enclosure. (Test firm Registration Number: 269701)

The EUT was placed on a non-conducting 1.0 m by 1.5 m table, which is 0.8 m in height and 0.4 m away from the vertical wall of the shielded enclosure.

The EUT is powered from the Rohde & Schwarz LISN (ENV216) and the support equipment is powered from the Rohde & Schwarz LISN (ENV216). Powers to the LISN are filtered by high-current high insertion loss power line filter.

Sufficient time for EUT, support equipment, and test equipment was allowed in order for them to warm up to their normal operating condition.

The RF output of the LISN was connected to the EMI test receiver (Rohde & Schwarz, ESCI).

Exploratory measurements were conducted to identify the highest emission by operating the EUT in a range of typical modes of operation, cable positions, system configuration and arrangement.

Based on exploratory measurements, the final measurements were conducted at the worst test conditions.

Exploratory measurements were scanned using Peak mode of EMI Test receiver from 150 kHz to 30 MHz with 20 ms sweep time. The final measurements were measured with Quasi-Peak and Average mode.

The bandwidth of EMI Test Receiver was set to 9 kHz. Interface cables were connected to the available interface ports of the test unit. Excess cable lengths were bundled at center with 30 cm ~ 40 cm.

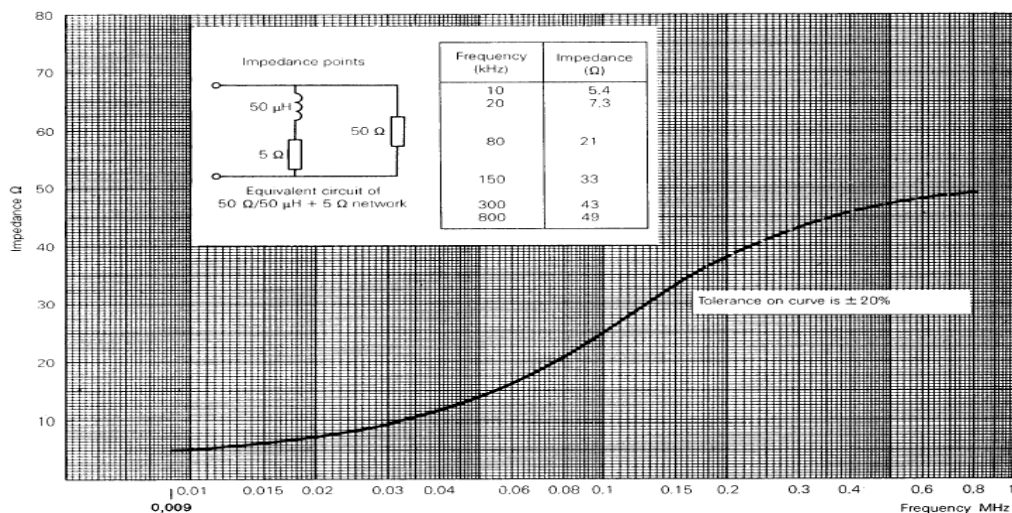

Fig 2. Impedance of LISN



13.1 Operating Environment

Temperature : 26.4 °C
Relative Humidity : 33.8 % R.H.

13.2 Test Set-up

The conducted emission measurements were performed in the shielded room.

The EUT was placed on wooden table, 0.8 m heights above the floor, 0.4 m from the reference ground plane (GRP) wall and 0.8 m from AMN & ISN.

AMN is bonded on horizontal reference ground plane.

The ground plane, which was electrically bonded to the shield room, ground system and all power lines entering the shield room, were filtered.

13.3 Measurement Uncertainty

The measurement uncertainty was calculated in accordance with ISO "Guide to the expression of uncertainty in measurement."

The measurement uncertainty was given with a confidence of 95 %.

Test Items	Uncertainty	Remark
Conducted emission (9 kHz ~ 150 kHz)	3.69 dB	Confidence level of approximately 95 % ($k = 2$)
Conducted emission (150 kHz ~ 30 MHz)	3.32 dB	Confidence level of approximately 95 % ($k = 2$)



13.4 Limit

RFI Conducted	FCC Limit(dB μ V/m) Class B	
Freq. Range	Quasi-Peak	Average
150 kHz ~ 0.5 MHz	66 ~ 56*	56 ~ 46*
0.5 MHz ~ 5 MHz	56	46
5 MHz ~ 30 MHz	60	50

*Limits decreases linearly with the logarithm of frequency.

13.5 Test Equipment used

Model Name	Manufacturer	Description	Serial Number	Due to Calibration
■- ESCI	Rohde & Schwarz	EMI test receiver	100237	Apr. 04, 2024
■- ENV216	Rohde & Schwarz	LISN	100172	Apr. 04, 2024
■- ENV216	Rohde & Schwarz	LISN	100173	Apr. 04, 2024
■ EMC 32	Rohde & Schwarz	Testing Software	VER8.53	N/A

13.6 Test data for Conducted Emission

- Test Date : Oct. 13, 2023
- Reference Standard : Part 15 Subpart C, Sec. 15.207
- Test Procedure(s) : ANSI C63.10 (2013)
- Operating Condition : RF communication mode
- Power Source : AC 120 V / 60 Hz
- Frequency rage : 0.15 MHz to 30 MHz
- Line : AC Power Line (Live and Neutral)
- Comment : -



13.7 Test Result

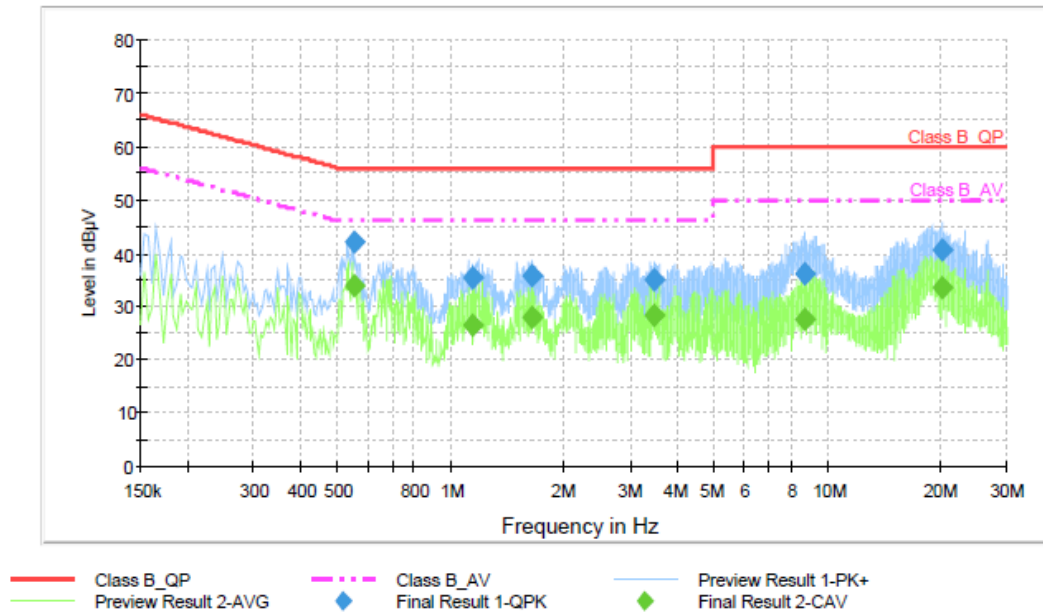

Final Result 1

Frequency (MHz)	QuasiPeak (dBµV)	Meas. Time (ms)	Bandwidth (kHz)	Filter	Line	Corr. (dB)	Margin (dB)	Limit (dBµV)	Comment
0.554012	42.0	1000.0	9.000	Off	L1	9.6	14.0	56.0	
1.144162	35.3	1000.0	9.000	Off	N	9.6	20.7	56.0	
1.638462	35.7	1000.0	9.000	Off	N	9.6	20.3	56.0	
3.451312	35.0	1000.0	9.000	Off	N	9.7	21.0	56.0	
8.748450	36.0	1000.0	9.000	Off	L1	9.7	24.0	60.0	
20.258206	40.7	1000.0	9.000	Off	L1	9.8	19.3	60.0	

Final Result 2

Frequency (MHz)	CAverage (dBµV)	Meas. Time (ms)	Bandwidth (kHz)	Filter	Line	Corr. (dB)	Margin (dB)	Limit (dBµV)	Comment
0.554012	33.7	1000.0	9.000	Off	L1	9.6	12.3	46.0	
1.144162	26.6	1000.0	9.000	Off	N	9.6	19.4	46.0	
1.638462	28.1	1000.0	9.000	Off	N	9.6	17.9	46.0	
3.451312	28.1	1000.0	9.000	Off	N	9.7	17.9	46.0	
8.748450	27.5	1000.0	9.000	Off	L1	9.7	22.5	50.0	
20.258206	33.5	1000.0	9.000	Off	L1	9.8	16.5	50.0	



14. Radiated Spurious & Restricted Band Edge Emission

Exploratory Radiated measurements were conducted at the 3m semi anechoic chamber in order to identify the highest emission by operating the EUT in a range of typical modes of operation, cable positions, system configuration and arrangement.

Based on exploratory measurements, the final measurements were conducted at the worst test conditions.

Final measurements of below 1GHz were made at 3m or 10 m Chamber that complies with CISPR 16/ANSI C63.10. Above 1GHz final measurements were conducted at the 3m Chamber only.

For measurements above 1GHz, the bottom side of 3m chamber was installed with absorbers in order to meet SVSWR Limit.

Exploratory measurements were scanned using Peak mode of EMI Test receiver and final measurements were measured with Quasi-Peak mode (Below 1GHz) and Peak & Average mode (Above 1GHz).

The measurements were performed by rotating the EUT 360° and adjusting the receive antenna height from 1.0 m to 4.0 m. All frequencies were investigated in both horizontal and vertical antenna polarity.

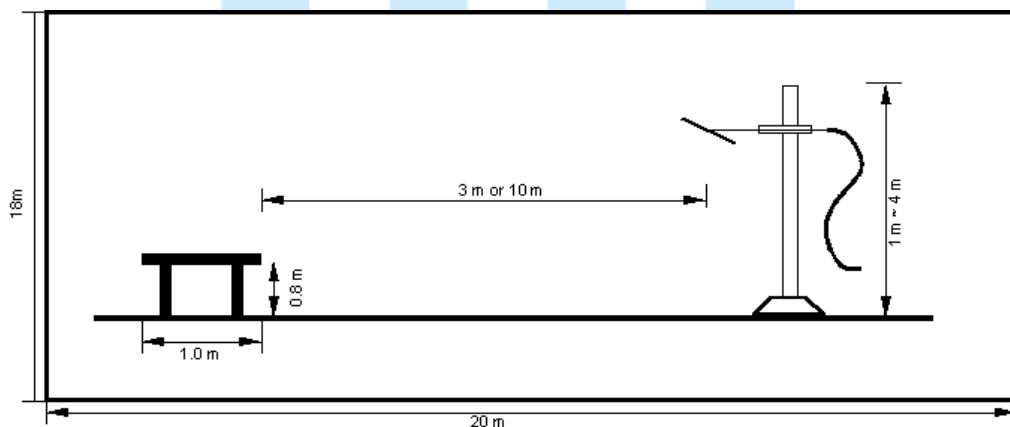

Fig 3. Dimensions of test site (Below 1GHz)

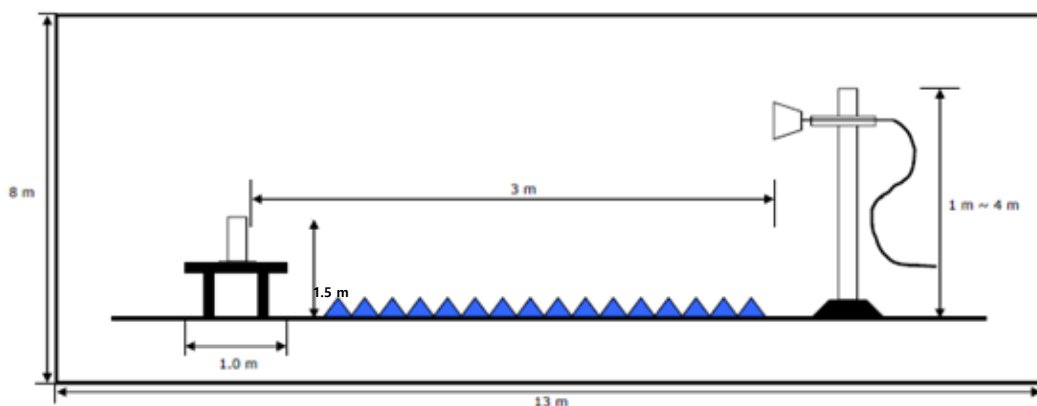

Fig 4. Dimensions of test site (Above 1GHz)



14.1 Operating environment

Temperature : 21.9 °C
Relative humidity : 48.1 % R.H.

14.2 Test set-up

A preliminary and final measurement was at 3 m anechoic chamber.

The EUT was placed on a non-conducting table.

For emissions testing at or below 1 GHz, the table height is 80 cm above the reference ground plane.

For emission measurements above 1 GHz, the table height is 1.5 m above the reference ground plane.

The turntable with EUT was rotated 360°, and the antenna was varied in height between 1.0 m and 4.0 m in order to determine the maximum emission levels.

This procedure was performed for both horizontal and vertical polarization of the receiving antenna.

14.3 Measurement uncertainty

The measurement uncertainty was calculated in accordance with ISO “Guide to the expression of uncertainty in measurement”.

The measurement uncertainty was given with a confidence of 95 %.

Test items(Anechoic Chamber)	Uncertainty	Remark
Radiated emission (30 MHz ~ 300 MHz, 3 m, Vertical)	4.78 dB	Confidence level of approximately 95 % ($k = 2$)
Radiated emission (30 MHz ~ 300 MHz, 3 m, Horizontal)	4.77 dB	Confidence level of approximately 95 % ($k = 2$)
Radiated emission (300 MHz ~ 1 000 MHz, 3 m, Vertical)	6.20 dB	Confidence level of approximately 95 % ($k = 2$)
Radiated emission (300 MHz ~ 1 000 MHz, 3 m, Horizontal)	5.12 dB	Confidence level of approximately 95 % ($k = 2$)
Radiated emission (1 000 MHz ~ 6 000 MHz, 3 m, V/H)	4.56 dB	Confidence level of approximately 95 % ($k = 2$)
Radiated emission (6 000 MHz ~ 18 000 MHz, 3 m, V/H)	4.88 dB	Confidence level of approximately 95 % ($k = 2$)
Radiated emission (18 000 MHz ~ 26 000 MHz, 3 m, V/H)	5.03 dB	Confidence level of approximately 95 % ($k = 2$)

Where relevant, the following measurement uncertainty levels have been estimated for tests performed on the EUT as specified in CISPR 16-4-2.

The listed uncertainties are the worst case uncertainty for the entire range of measurement. please note that the uncertainty values are provided for informational purposes only are not used in determining the PASS/FAIL results



14.4 Limit

20 dB in any 100 kHz bandwidth outside the operating frequency band. In case the emission fall within the restricted band specified on 15.205(a) limit in the table below has to be followed.

Frequencies (MHz)	Field Strength (microvolt/meter)	Measurement Distance (meters)
0.009 ~ 0.490	2 400/F (kHz)	300
0.490 ~ 1.705	2 400/F (kHz)	30
1.705 ~ 30.0	30	30
30 ~ 88	100	3
88 ~ 216	150	3
216 ~ 960	200	3
Above 960	500	3

14.5 Test Equipment used

Model Name	Manufacturer	Description	Serial Number	Due to Calibration
■ - ESU40	Rohde & Schwarz	EMI Test Receiver	100266	Apr. 04, 2024
■ - HFH2-Z2	Rohde & Schwarz	Loop Antenna	100041	Apr. 14, 2024
■ - VULB9160	Schwarzbeck	Broadband Test Antenna	3193	Apr. 18, 2024
■ - 3117	ETS LINDGREN	Horn Antenna	246053	Feb. 28, 2024
■ - BBHA9170	Schwarzbeck	Horn Antenna	766	Apr. 17, 2024
■ - MCU066	maturo GmbH	Position Controller	1390306	N/A
■ - TT2.5SI	maturo GmbH	Turntable	1390307	N/A
■ - CO3000	Innco system GmbH	Position Controller	CO3000/1804/4 2760218/P	N/A
■ - MA4640-XP-ET	Innco system GmbH	Antenna Mast	5580916	N/A
■ - 310N	Sonoma Instrument	Amplifier	187164	Apr. 05. 2024
■ - TK-PA18H	TESTEK	Low Noise Amplifier	220107-L	Apr. 06, 2024
■ - TK-PA1840H	TESTEK	Amplifier	170007-L	Apr. 09, 2024
■ - WHKX3.0/18G-10SS	WAINWRIGHT INSTRUMENTS	High pass filter	SN31	Apr. 07, 2023
■- EMC 32	Rohde & Schwarz	Testing Software	VER10.50.10	N/A



14.6 Test data for Radiated Spurious Emission

- Test Date : Oct. 11, 2023 ~ Oct. 12, 2023
- Reference Standard : Part 15 Subpart C, Sec. 15.247(d)
- Measuring Distance : 3 m
- Resolution Bandwidth : 200 Hz, 9 kHz(Below 30 MHz) / 120 kHz(30 MHz ~ 1GHz) / 1 MHz(Above 1GHz)
- Detector mode : Quasi Peak detector mode / Peak detector mode / Average detector mode
- Power Source : DC 5 V
- Note : Through three orthogonal axes were investigated and the worst case is report

Radiated Spurious Emission (9 kHz to 30 MHz): 2 412 MHz

IEEE Standard	Frequency (MHz)	MaxPeak (dBμV/m)	Limit (dBμV/m)	Margin (dB)	Meas. Time (ms)	Band width (kHz)	Height (cm)	Pol	Azimuth (deg)	Corr. (dB)
802.11b	1.39	42.06	44.68	2.63	1000	9	100	H	138	-12.8
802.11g	1.38	42.51	44.74	2.23	1000	9	100	H	122	-12.8
802.11n	0.99	44.07	47.62	3.55	1000	9	100	V	92	-12.9

Radiated Spurious Emission (9 kHz to 30 MHz): 2 437 MHz

IEEE Standard	Frequency (MHz)	MaxPeak (dBμV/m)	Limit (dBμV/m)	Margin (dB)	Meas. Time (ms)	Band width (kHz)	Height (cm)	Pol	Azimuth (deg)	Corr. (dB)
802.11b	1.39	42.68	44.65	1.97	1000	9	100	H	0	-12.8
802.11g	1.37	42.95	44.81	1.86	1000	9	100	H	261	-12.8
802.11n	1.37	42.17	44.81	2.64	1000	9	100	H	89	-12.8

Radiated Spurious Emission (9 kHz to 30 MHz): 2 462 MHz

IEEE Standard	Frequency (MHz)	MaxPeak (dBμV/m)	Limit (dBμV/m)	Margin (dB)	Meas. Time (ms)	Band width (kHz)	Height (cm)	Pol	Azimuth (deg)	Corr. (dB)
802.11b	1.39	41.80	44.67	2.87	1000	9	100	H	65	-12.8
802.11g	1.38	42.07	44.70	2.64	1000	9	100	H	358	-12.8
802.11n	1.35	40.44	44.90	4.46	1000	9	100	V	174	-12.8

Radiated Spurious Emission (30 MHz to 1 000 MHz): 2 412 MHz

IEEE Standard	Frequency (MHz)	MaxPeak (dBμV/m)	Limit (dBμV/m)	Margin (dB)	Meas. Time (ms)	Band width (kHz)	Height (cm)	Pol	Azimuth (deg)	Corr. (dB)
802.11b	239.44	41.50	46.02	4.52	1000	120	100	V	35	-17.8
802.11g	239.98	41.14	46.02	4.88	1000	120	106	V	36	-17.7
802.11n	240.01	40.84	46.02	5.18	1000	120	106	V	31	-17.8



Radiated Spurious Emission (30 MHz to 1 000 MHz): 2 437 MHz

IEEE Standard	Frequency (MHz)	MaxPeak (dBμV/m)	Limit (dBμV/m)	Margin (dB)	Meas. Time (ms)	Band width (kHz)	Height (cm)	Pol	Azimuth (deg)	Corr. (dB)
802.11b	240.02	40.41	46.02	5.61	1000	120	100	V	38	-17.7
802.11g	239.45	41.29	46.02	4.73	1000	120	100	V	44	-17.8
802.11n	240.00	41.47	46.02	4.55	1000	120	100	V	36	-17.7

Radiated Spurious Emission (30 MHz to 1 000 MHz): 2 462 MHz

IEEE Standard	Frequency (MHz)	MaxPeak (dBμV/m)	Limit (dBμV/m)	Margin (dB)	Meas. Time (ms)	Band width (kHz)	Height (cm)	Pol	Azimuth (deg)	Corr. (dB)
802.11b	239.43	41.08	46.02	4.94	1000	120	106	V	34	-17.8
802.11g	239.98	40.93	46.02	5.09	1000	120	107	V	34	-17.7
802.11n	239.45	40.90	46.02	5.12	1000	120	107	V	43	-17.8

Radiated Spurious Emission (1 GHz to 26 GHz): 2 412 MHz

IEEE Standard	Frequency (MHz)	Pol.	Frequency Component	Reading (dBUV)	Transducer Factor (dB)	Test Result (dBUV/m)	Limits (dBUV/m)	Margin (dB]	Detector Type
N/A									

Radiated Spurious Emission (1 GHz to 26 GHz): 2 437 MHz

IEEE Standard	Frequency (MHz)	Pol.	Frequency Component	Reading (dBUV)	Transducer Factor (dB)	Test Result (dBUV/m)	Limits (dBUV/m)	Margin (dB]	Detector Type
N/A									

Radiated Spurious Emission (1 GHz to 26 GHz): 2 462 MHz

IEEE Standard	Frequency (MHz)	Pol.	Frequency Component	Reading (dBUV)	Transducer Factor (dB)	Test Result (dBUV/m)	Limits (dBUV/m)	Margin (dB]	Detector Type
N/A									

Note:

If the maximized peak measured value complies with the average limit, then it is unnecessary to perform an average measurement.

Record the result only if the margin is 10 dB or less.

Test Result = Reading + Transducer Factor

Where, Transducer Factor = Cable loss + Preamplifier gain + Antenna factor + High Pass Filter

Pol.: H(Horizontal), V(Vertical)



15. Sample Calculations

$$\text{dB}\mu\text{V} = 20 \text{ Log}_{10}(\mu\text{V}/\text{m})$$

$$\text{dB}\mu\text{V} = \text{dBm} + 107$$

$$\mu\text{V} = 10^{(\text{dB}\mu\text{V}/20)}$$

15.1 Example 1 :

■ 20.3 MHz

Class B Limit = 250 μV = 48 dB μV

Reading = 39.2 dB μV

$10^{(39.2\text{dB}\mu\text{V}/20)}$ = 91.2 μV

Margin = 48 dB μV - 39.2 dB μV

= 8.8 dB

15.2 Example 2 :

■ 66.7 MHz

Class B Limit = 100 $\mu\text{V}/\text{m}$ = 40.0 dB $\mu\text{V}/\text{m}$

Reading = 31.0 dB μV

Antenna Factor + Cable Loss = 5.8 dB

Total = 36.8 dB $\mu\text{V}/\text{m}$

Margin = 40.0 dB $\mu\text{V}/\text{m}$ - 36.8 dB $\mu\text{V}/\text{m}$

= 3.2 dB



16. Recommendation & Conclusion

The data collected shows that the **Ohsung Electronics Co., Ltd. Wi-Fi Dongle (Model Name: C307-HW-WF)** was complies with §15.247 of the FCC Rules.

- The end -

