

## ***FCC EVALUATION REPORT FOR CERTIFICATION***

**Manufacturer: Ohsung Electronics Co., Ltd.**  
**#181 Gongdan-dong, Gumi-si, Gyeongsangbuk-Do**  
**South Korea**  
**Attn: Mr. Hak Ki, Kim / General Manager**

**Date of Issue: December 04, 2017**  
**Order Number: GETEC-C1-17-532**  
**Test Report Number: GETEC-E3-17-052**  
**Test Site: GUMI UNIVERSITY EMC CENTER**  
**(Test firm Registration Number: 269701)**

<b>FCC ID. :</b>	<b>OZ5B526A</b>
<b>Applicant :</b>	<b>Ohsung Electronics Co., Ltd.</b>

<b>Rule Part(s)</b>	<b>: FCC Part 15 Subpart C-Intentional Radiator § 15.247</b>
<b>Test Method</b>	<b>: ANSI C63.10 (2013)</b>
<b>Equipment Class</b>	<b>: Digital Transmission System(DTS)</b>
<b>EUT Type</b>	<b>: Remote Controller</b>
<b>Type of Authority</b>	<b>: Certification</b>
<b>Model Name</b>	<b>: B526A</b>

**This equipment has been shown to be in compliance with the applicable technical standards as indicated in the measurement report and was tested in accordance with the measurement procedures specified in ANSI C63.10 (2013)**

**I attest to the accuracy of data. All measurements reported herein were performed by me or were made under my supervision and are correct to the vest of my knowledge and belief. I assume full responsibility for the completeness of these measurements and vouch for the qualifications of all persons taking them.**

**Tested by,**

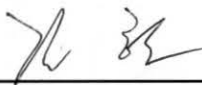

**Hyun Kim, Senior Engineer**  
**GUMI UNIVERSITY EMC CENTER**

**Reviewed by,**



**Jae-Hoon Jeong, Technical Manager**  
**GUMI UNIVERSITY EMC CENTER**



## CONTENTS

<b>1. GENERAL INFORMATION .....</b>	<b>4</b>
<b>2. INTRODUCTION .....</b>	<b>5</b>
<b>3. PRODUCT INFORMATION .....</b>	<b>6</b>
<b>3.1 DESCRIPTION OF EUT.....</b>	<b>6</b>
<b>3.2 DEFINITION OF MODELS.....</b>	<b>6</b>
<b>3.3 SUPPORT EQUIPMENT / CABLES USED .....</b>	<b>7</b>
<b>3.4 MODIFICATION ITEM(S).....</b>	<b>7</b>
<b>4. ANTENNA REQUIREMENT - §15.203 .....</b>	<b>8</b>
<b>4.1 DESCRIPTION OF ANTENNA.....</b>	<b>8</b>
<b>5. DESCRIPTION OF TESTS.....</b>	<b>8</b>
<b>5.1 TEST CONDITION.....</b>	<b>8</b>
<b>6. REFERENCES STANDARDS .....</b>	<b>8</b>
<b>7. DUTY CYCLE CORRECTION.....</b>	<b>9</b>
<b>7.1 A CYCLE PULSE TRAIN .....</b>	<b>9</b>
<b>7.2 CALCULATION OF DUTY CYCLE .....</b>	<b>9</b>
<b>8. SUMMARY OF TEST RESULTS .....</b>	<b>10</b>
<b>9. 6 DB BANDWIDTH MEASUREMENT .....</b>	<b>11</b>
<b>9.1 OPERATING ENVIRONMENT .....</b>	<b>11</b>
<b>9.2 TEST SET-UP (LAYOUT) .....</b>	<b>11</b>
<b>9.3 LIMIT .....</b>	<b>11</b>
<b>9.4 TEST EQUIPMENT USED.....</b>	<b>11</b>
<b>9.5 TEST TEST PROCEDURE .....</b>	<b>11</b>
<b>9.6 TEST RESULT .....</b>	<b>12</b>
<b>10. CONDUCTED MAXIMUM PEAK OUTPUT POWER MEASUREMENT.....</b>	<b>14</b>
<b>10.1 OPERATING ENVIRONMENT .....</b>	<b>14</b>
<b>10.2 TEST SET-UP (LAYOUT) .....</b>	<b>14</b>
<b>10.3 LIMIT .....</b>	<b>14</b>
<b>10.4 TEST EQUIPMENT USED.....</b>	<b>14</b>
<b>10.5 TEST PROCEDURE .....</b>	<b>14</b>
<b>10.6 TEST RESULT .....</b>	<b>14</b>
<b>11. POWER SPECTRAL DENSITY MEASUREMENT .....</b>	<b>15</b>
<b>11.1 OPERATING ENVIRONMENT .....</b>	<b>15</b>
<b>11.2 TEST SET-UP (LAYOUT) .....</b>	<b>15</b>
<b>11.3 LIMIT .....</b>	<b>15</b>
<b>11.4 TEST EQUIPMENT USED.....</b>	<b>15</b>
<b>11.5 TEST PROCEDURE.....</b>	<b>15</b>
<b>11.6 TEST RESULT .....</b>	<b>16</b>
<b>12. CONDUCTED SPURIOUS EMISSION &amp; OUT OF BAND EMISSION .....</b>	<b>18</b>
<b>12.1 OPERATING ENVIRONMENT .....</b>	<b>18</b>
<b>12.2 TEST SET-UP (LAY-OUT).....</b>	<b>18</b>
<b>12.3 LIMIT .....</b>	<b>18</b>
<b>12.4 TEST EQUIPMENT USED .....</b>	<b>18</b>
<b>12.5 TEST PROCEDURE .....</b>	<b>18</b>





12.6 TEST RESULT .....	19
13. AC POWER LINE CONDUCTED EMISSION .....	22
13.1 OPERATING ENVIRONMENT .....	23
13.2 TEST SET-UP .....	23
13.3 MEASUREMENT UNCERTAINTY.....	23
13.4 LIMIT .....	24
13.5 TEST EQUIPMENT USED.....	24
13.6 TEST DATA FOR CONDUCTED EMISSION .....	24
14. RADIATED SPURIOUS & RESTRICTED BAND EDGE EMISSION.....	25
14.1 OPERATING ENVIRONMENT .....	26
14.2 TEST SET-UP.....	26
14.3 MEASUREMENT UNCERTAINTY .....	26
14.4 LIMIT .....	27
14.5 TEST EQUIPMENT USED.....	27
14.6 TEST DATA FOR RADIATED SPURIOUS EMISSION.....	28
14.7 TEST DATA FOR RADIATED RESTRICTED BAND EDGE EMISSION .....	30
15. SAMPLE CALCULATIONS.....	31
15.1 EXAMPLE 1 : .....	31
15.2 EXAMPLE 2 : .....	31
16. RECOMMENDATION & CONCLUSION.....	32
APPENDIX A – ATTESTATION STATEMENT	
APPENDIX B – LABELLING	
APPENDIX C – BLOCK DIAGRAM	
APPENDIX D – SCHEMATIC DIAGRAM	
APPENDIX E – TEST SETUP PHOTOGRAPH	
APPENDIX F – EXTERNAL PHOTOGRAPH	
APPENDIX G – INTERNAL PHOTOGRAPH	
APPENDIX H – USER’S MANUAL	
APPENDIX I – OPERATIONAL DESCRIPTION	
APPENDIX J – ANTENNA SPECIFICATION	
APPENDIX K – PART LIST	
APPENDIX L – RF EXPOSURE EVALUATION	





**Scope:** Measurement and determination of electromagnetic emissions (EME) of radio frequency devices including intentional and / or unintentional radiators for compliance with technical rules and regulations of the Federal Communications Commission.

## 1. General Information

**Applicant:** Ohsung Electronics Co., Ltd.

**Applicant Address:** #181 Gongdan-dong, Gumi-si, Gyeongsangbuk-Do, South Korea

**Manufacturer:** Ohsung Electronics Co., Ltd.

**Manufacturer Address:** #181 Gongdan-dong, Gumi-si, Gyeongsangbuk-Do, South Korea

**Contact Person:** Hak Ki, Kim / General Manager

**Telephone Number:** +82-54-468-7281      **Fax Number:** +82-54-461-8368

- **FCC ID.** OZ5B526A
- **Equipment Class** Digital Transmission System (DTS)
- **EUT Type** Remote Controller
- **Model Name** B526A
- **Rule Part(s)** FCC Part 15 Subpart C-Intentional Radiator § 15.247
- **Test Method** ANSI C63.10 (2013)
- **Type of Authority** Certification
- **Test Procedure(s)** ANSI C63.10 (2013), KDB558074 D01 DTS Meas Guidance v04(April 5,2017)
- **Dates of Test** November 16 ~ 21, 2017
- **Place of Test** GUMI UNIVERSITY EMC CENTER (FCC Test firm Registration No.: 269701)  
37 Yaeun-ro, Gumi-si, Gyeongsangbuk-do, 730-711, Republic of Korea
- **Test Report Number** GETEC-E3-17-052
- **Dates of Issue** December 04, 2017

**EUT Type: Remote Controller**

**FCC ID.: OZ5B526A**





## 2. Introduction

The measurement procedure described in American National Standard for Methods of Measurement of Radio-Nose Emissions From Low-Voltage Electrical and Electronic Equipment in the Range of 9 kHz to 40 GHz (ANSI C63.4-2009) was used in determining radiated and conducted emissions emanating from **Ohsung Electronics Co., Ltd. Remote Controller (Model name: B526A)**

These measurement tests were conducted at **GUMI UNIVERSITY EMC CENTER**.

The site address is 37 Yaeun-ro, Gumi-si, Gyeongsangbuk-do, 730-711, Gyeongnam 641-713, Korea

This test site is one of the highest point of GUMI UNIVERSITY at about 200 kilometers away from Seoul city and 40 kilometers away from Daegu city. It is located in the valley surrounded by mountains in all directions where ambient radio signal conditions are quiet and a favorable area to measure the radio frequency interference on open field test site for the computing and ISM devices manufactures. The detailed description of the measurement facility was found to be in compliance with the requirements of §2.948 according to ANSI C63.10 (2013)

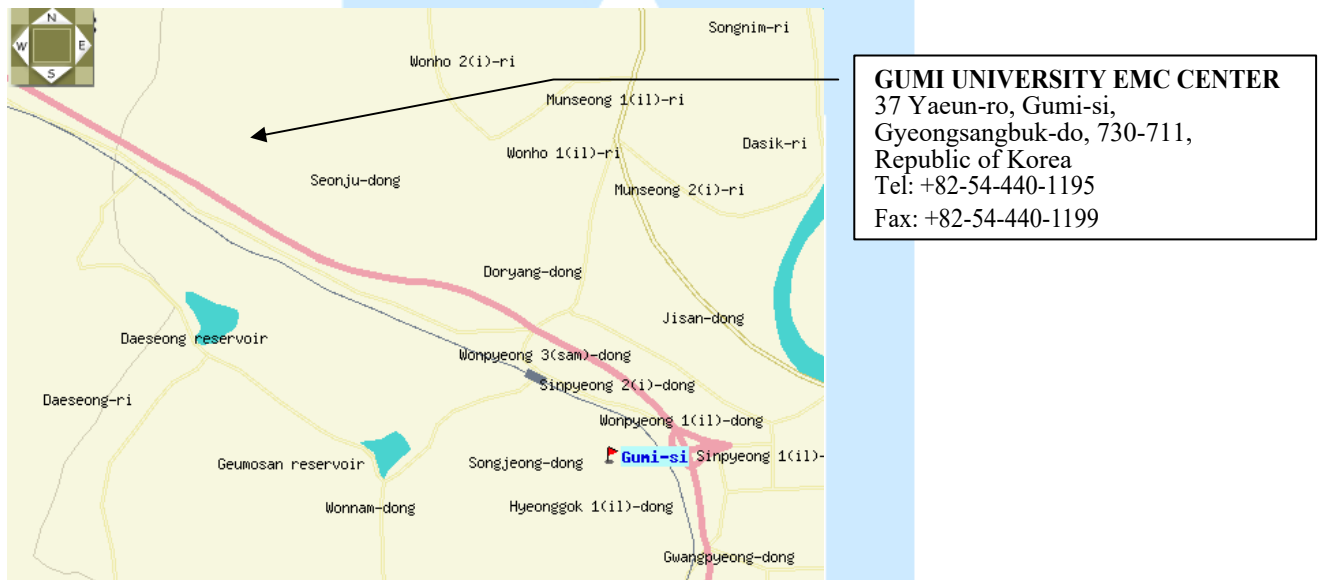

Fig 1. The map above shows the Gumi University in vicinity area.





### 3. Product Information

#### 3.1 Description of EUT

The Equipment under Test (EUT) is the **Ohsung Electronics Co., Ltd. Remote Controller (Model Name: B526A)**  
**FCC ID.: OZ5B526A**

- Equipment	: Remote Controller
- Model name	: B526A
- Serial number	: Proto type
- Electrical Rating	: DC 3 V
- Manufacturer	: Ohsung electronics Co., Ltd.
- Channel Separations	: 2 MHz
- Type of Modulation	: GFSK
- Channel frequency	: 2 402 MHz ~ 2 480 MHz
- Number of channel	: 40
- Type of chain	: One
- Antenna specification	: Manufacturer: Ohsung Electronics Co., Ltd. Antenna type : PCB printed antenna Gain : 1.23 dBi
- Hardware version	: V1.0
- Software version	: V0007

#### 3.2 Definition of models

-None.





### 3.3 Support Equipment / Cables used

#### 3.3.1 Used Support Equipment

Description	Manufacturer	Model Name	S/N & FCC ID.
Notebook Computer <sup>1)</sup>	SAMSUNG	NT500R3W	S/N: 0Q2V91JJ100096T FCC ID.: N/A

Note)

1) The Support Equipment use only setting to the test mode.

#### 3.3.2 System configuration

Description	Manufacturer	Model Name	S/N & FCC ID.
-	-	-	-

#### 3.3.3 Used Cable(s)

Cable Name	Condition	Description
-	-	-

### 3.4 Modification Item(s)

-. None





#### 4. Antenna Requirement - §15.203

An intentional radiator antenna shall be designed to ensure that no antenna other than that furnished by the applicant can be used with the device. The use of permanently attached antenna or of an antenna that uses a unique coupling to the intentional radiator shall be considered sufficient to comply with this requirement.

##### 4.1 Description of Antenna

The **Ohsung Electronics Co., Ltd. Remote Controller**. comply with the requirement of §15.203 with a PCB printed antenna permanently attached to the transmitter.

#### 5. Description of tests

##### 5.1 Test Condition

The EUT was installed, arranged and operated in a manner that is most representative of equipment as typically used. The measurements were carried out while varying operating modes and cable positions within typically arrangement to determine maximum emission level.

The representative and worst test mode(s) were noted in the test report.

- Test Voltage / Frequency: 3 V / DC
- Operating condition during the test(s) :
  - . Continuous RF transmitting mode with nominal maximum RF output power.
  - . Operating channel frequency and modulation technology

Mode	Available channel	Frequency	Modulation Technology
Bluetooth Low Energy	0 ~ 39	2402 ~ 2480 MHz	GFSK

- . EUT set condition (Test Software)

Test Software	Realtek Bluetooth MP Tool
Test Software version	V2.0.1

#### 6. References Standards

- FCC Part 15 (2009) Subpart C-Intentional Radiator §15.247
- ANSI C 63.10 (2013): American National Standard for Testing Unlicensed Wireless Devices
- KDB 558074 D01 DTS meas Guidance v04 (April 5, 2017): Guidance for Performing Compliance Measurements on Digital Transmission Systems (DTS) Operating Under §15.247







## 7. Duty Cycle Correction

### 7.1 A cycle pulse Train

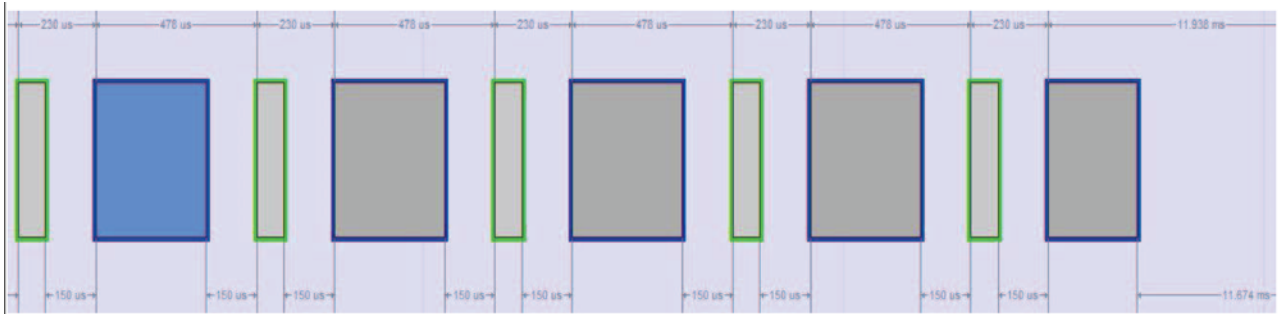

### 7.2 Calculation of duty cycle

- Total width of pulse on time: 1.976 ms
- A cycle time (On & OFF time): 15.00 ms
- Duty Cycle (%):  $1.976 \text{ ms} / 15.00 \text{ ms} = 0.131733 \times 100 = 13.1733 \%$
- Duty Cycle Collection Factor (dB):  $20 \log(1.976/15.00) = -17.61 \text{ dB}$

Total width of ON-Time	Total width of Cycle time	Duty Cycle (%)	Duty Cycle Collection Factor (dB)
1.976 ms	15.00 ms	13.1733 %	-17.61 dB





## 8. SUMMARY OF TEST RESULTS

FCC Part Section(s)	Test Description	Test Result
§15.247(a)(2)	6 dB Bandwidth	Pass
§15.247(b)(3)	Conducted Maximum Peak Output Power	Pass
§15.247(e)	Power Spectral Density	Pass
§15.247(d)	Conducted Out of Band Emission Emissions	Pass
§15.207(a)	AC Power line Conducted Emissions	N/A <sup>1)</sup>
§15.205, 15.209	Radiated Spurious Emissions	Pass
§15.247(d), 15.205, 15.209	Radiated Restricted Band Edge	Pass

Note)

1) The EUT is supplied power from battery. Therefore the test was not applicable.



## 9. 6 dB Bandwidth Measurement

### 9.1 Operating environment

Temperature : 20.6 °C  
 Relative Humidity : 28.3 % R.H.

### 9.2 Test Set-up (Layout)

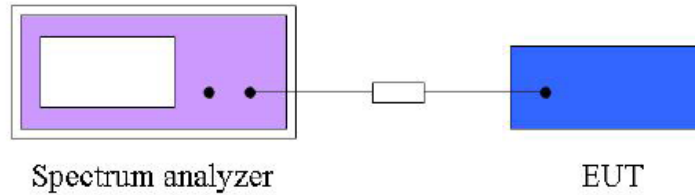

### 9.3 Limit

For digital modulation systems, the minimum 6 dB bandwidth shall be at least 500 kHz

### 9.4 Test Equipment used

Model Name	Manufacturer	Description	Serial Number	Due to Calibration
■ - FSV	Rohde & Schwarz	Spectrum Analyzer	101552	Apr. 18, 2018
■ - 10 dB Attenuator	Rohde & Schwarz	Attenuator 10 dB	SEP-10-14-044	Apr. 17. 2018
■ - WMS 32	Rohde & Schwarz	Testing Software	VER10.20.01	N/A

### 9.5 Test Test Procedure

- a) Set RBW = 100 kHz.
- b) Set the video bandwidth (VBW)  $\geq 3 \times$  RBW.
- c) Detector = Peak.
- d) Trace mode = max hold.
- e) Sweep = auto couple.
- f) Allow the trace to stabilize.
- g) Measure the maximum width of the emission that is constrained by the frequencies associated with the two outermost amplitude points (upper and lower frequencies) that are attenuated by 6 dB relative to the maximum level measured in the fundamental emission.





**9.6 Test result**

- Test Date : November 21, 2017
- Reference Standard : Part 15 Subpart C, Sec. 15.247(a)(2)
- Test Procedure(s) : ANSI C63.10 (2013), KDB558074 D01 DTS Meas Guidance v04(April 5, 2017)
- Operating Condition : RF transmitting mode (0 ch: 2 402 MHz, 19 ch: 2 440 MHz, 39 ch: 2 480 MHz)
- Power Source : DC 3.0 V

Frequency (MHz)	6 dB Bandwidth (MHz)	Band Edge Left (MHz)	Band Edge Right (MHz)	Min. Limit (MHz)	Result
2 402	0.784	2 401.666	2 402.450	0.50	Complies
2 440	0.784	2 439.666	2 440.450	0.50	Complies
2 480	0.784	2 479.666	2 480.450	0.50	Complies

**6 dB Bandwidth Plot on Configuration : 0ch**

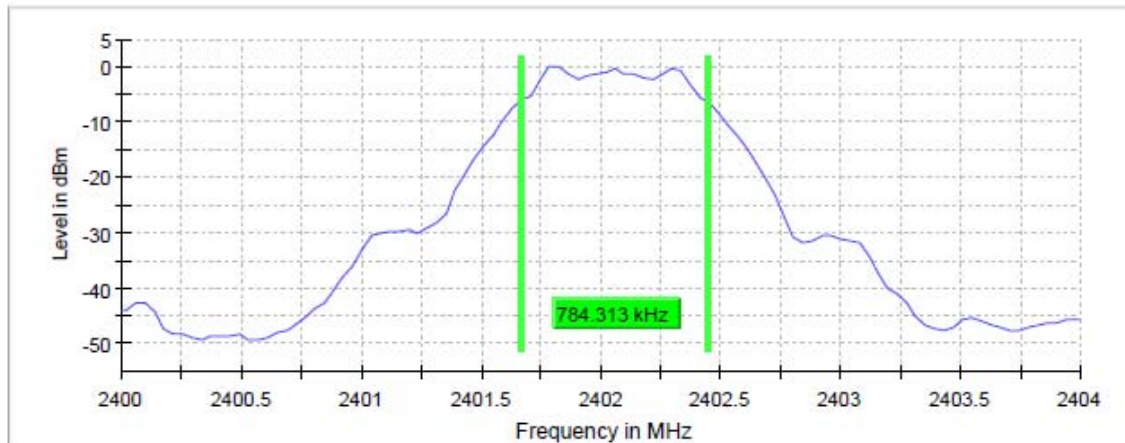



**6 dB Bandwidth Plot on Configuration : 19ch**

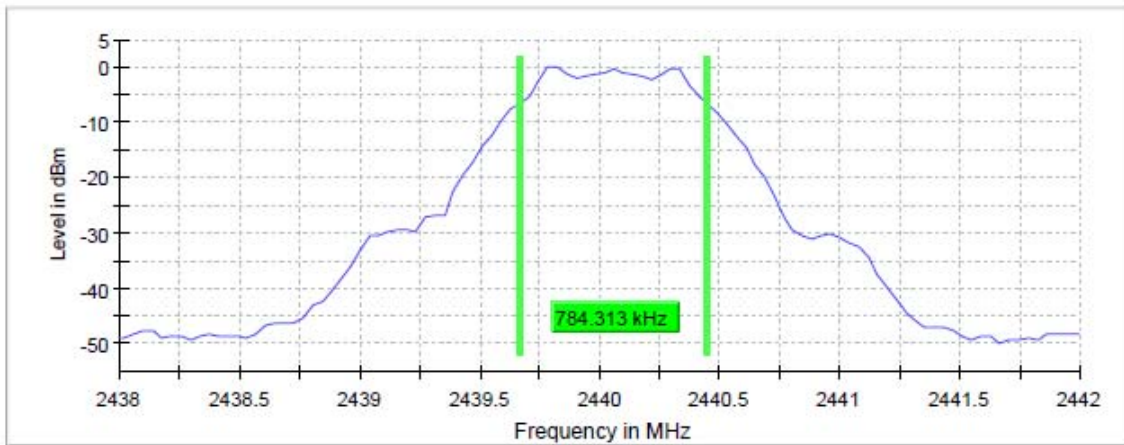

**6 dB Bandwidth Plot on Configuration : 39ch**

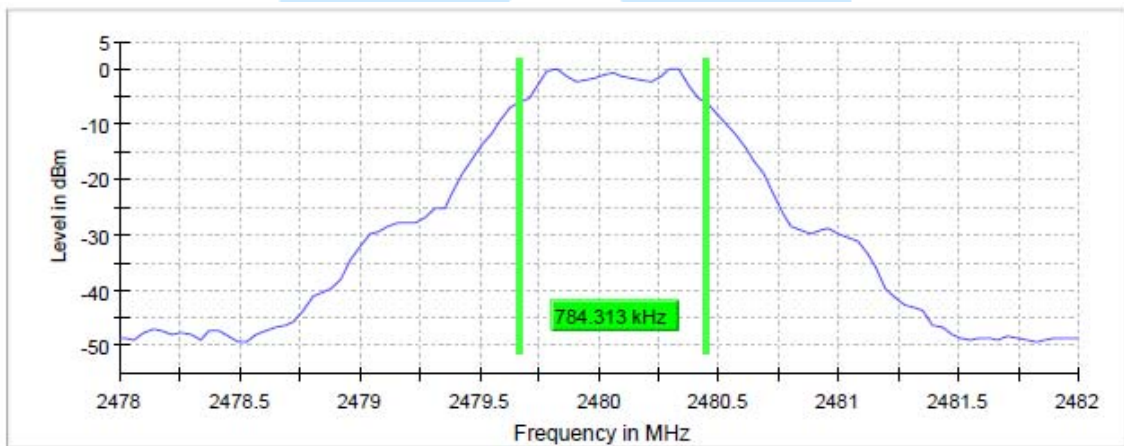



## 10. Conducted Maximum Peak Output Power Measurement

### 10.1 Operating environment

Temperature : 20.6 °C  
 Relative Humidity : 28.3 % R.H.

### 10.2 Test Set-up (Layout)

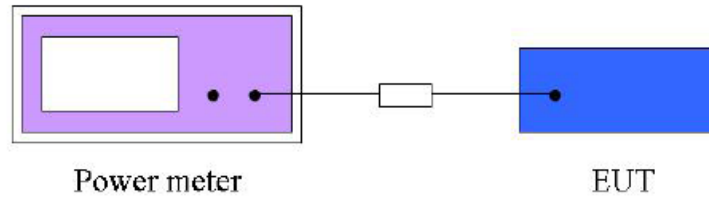

### 10.3 Limit

For systems using digital modulation in the (2 400~2 483.5) MHz, the limit for peak output power is 30 dBm. The limit has to be reduced by the amount in dB that the gain of the antenna exceeds 6 dBi. In case of point-to-point operation, the limit has to be reduced by 1 dB for every 3 dB that the directional gain of the antenna exceeds 6 dBi.

### 10.4 Test Equipment used

Model Name	Manufacturer	Description	Serial Number	Due to Calibration
■ - NRV-Z32	Rohde & Schwarz	Peak Power sensor	100049	Apr. 22, 2018
■ - NRVS	Rohde & Schwarz	Single Channel Power Meter	101008	Apr 19, 2018
■ - NRP-Z51	Rohde & Schwarz	Power sensor	1138.0005.02	Apr. 20, 2018

### 10.5 Test Procedure

A peak power sensor was used on the output port of the EUT. A power meter was used to read the response of the peak power sensor. Record the power level.

### 10.6 Test Result

- Test Date : November 21, 2017
- Reference Standard : Part 15 Subpart C, Sec. 15.247(a)(2)
- Test Procedure(s) : ANSI C63.10 (2013), KDB558074 D01 DTS Meas Guidance v04(April 5, 2017)
- Operating Condition : RF transmitting mode (0 ch: 2 402 MHz, 19 ch: 2 440 MHz, 39 ch: 2 480 MHz)
- Power Source : DC 3.0 V

Frequency (MHz)	Average Conducted Power <sup>1)</sup> (dBm)	Peak Conducted Power (dBm)	Max. Limit (dBm)	Result
2 402	-0.45	-0.35	30.00	Complies
2 440	-0.42	-0.32	30.00	Complies
2 480	-0.45	-0.34	30.00	Complies

Note: 1) The Average output power is reference data for RF Exposure.





## 11. Power Spectral Density Measurement

### 11.1 Operating Environment

Temperature : 20.6 °C  
 Relative Humidity : 28.3 % R.H.

### 11.2 Test Set-up (Layout)

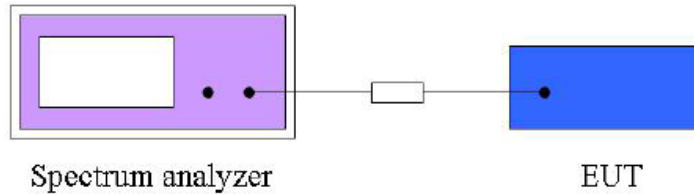

### 11.3 Limit

For digitally modulated systems, the power spectral density conducted from the intentional radiator to the antenna shall not be greater than 8 dBm in any 3 kHz band during any time interval of continuous transmission

### 11.4 Test Equipment used

Model Name	Manufacturer	Description	Serial Number	Due to Calibration
■ - FSV	Rohde & Schwarz	Spectrum Analyzer	101552	Apr. 18, 2018
■ - 10 dB Attenuator	Rohde & Schwarz	Attenuator 10 dB	SEP-10-14-044	Apr. 17. 2018
■ - WMS 32	Rohde & Schwarz	Testing Software	VER10.20.01	N/A

### 11.5 Test Procedure

- Set analyzer center frequency to DTS channel center frequency.
- Set the span to 1.5 times the DTS bandwidth.
- Set the RBW to 3 kHz
- Set the VBW to 10 kHz
- Detector = peak.
- Sweep time = auto couple.
- Trace mode = max hold.
- Allow trace to fully stabilize.
- Use the peak marker function to determine the maximum amplitude level within the RBW.





### 11.6 Test Result

- Test Date : November 21, 2017
- Reference Standard : Part 15 Subpart C, Sec. 15.247(a)(2)
- Test Procedure(s) : ANSI C63.10 (2013), KDB558074 D01 DTS Meas Guidance v04(April 5, 2017)
- Operating Condition : RF transmitting mode (0 ch: 2 402 MHz, 19 ch: 2 440 MHz, 39 ch: 2 480 MHz)
- Power Source : DC 3.0 V

Frequency	PSD (dBm/3kHz)	Max. Limit (dBm/3kHz)	Result
2 402 MHz	-13.66	8.00	Complies
2 440 MHz	-13.85	8.00	Complies
2 480 MHz	-14.69	8.00	Complies

Power Density Plot on configuration : 0ch

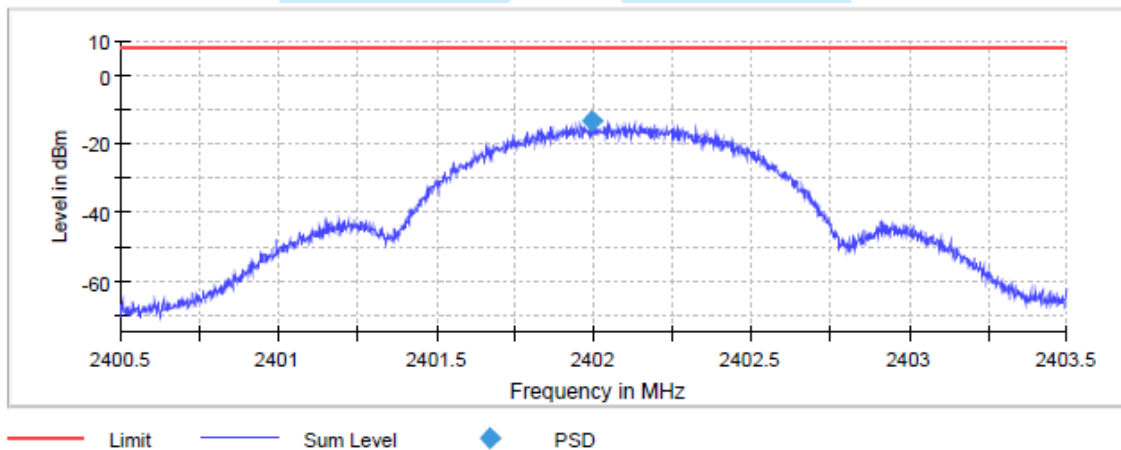

Power Density Plot on configuration : 19ch

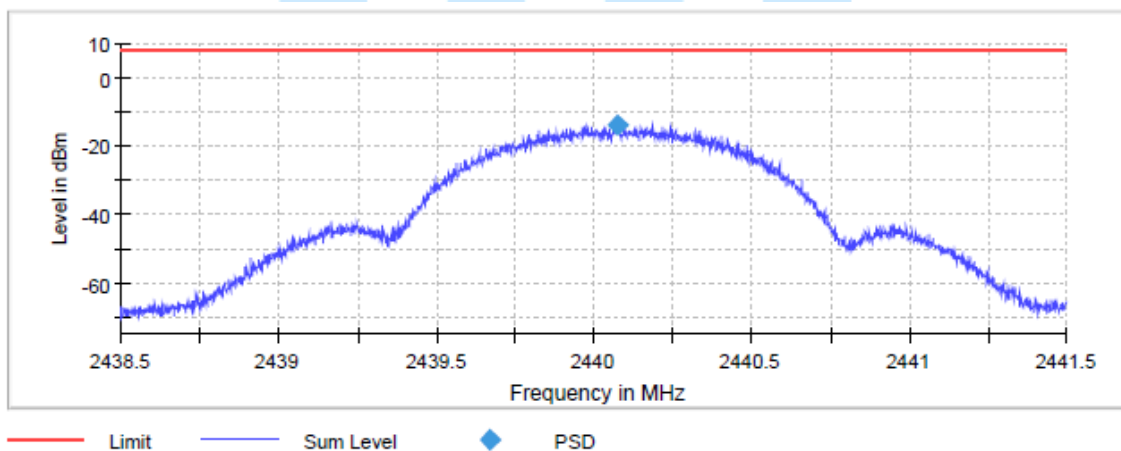





**Power Density Plot on configuration : 39ch**

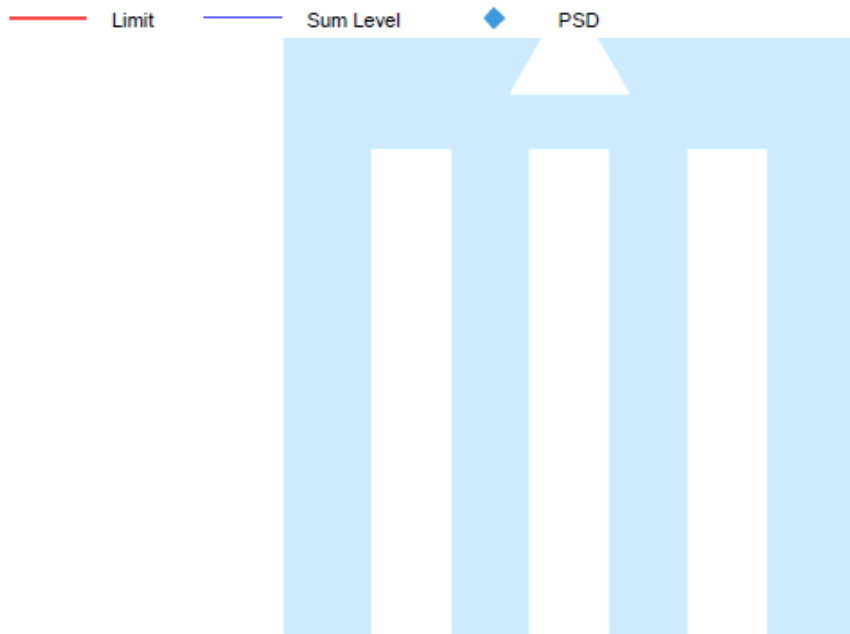
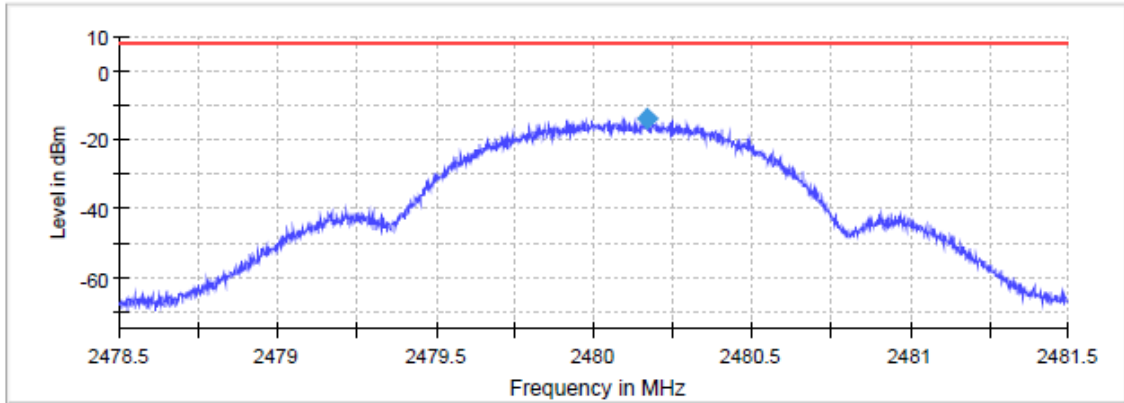



## 12. Conducted Spurious Emission & Out of Band Emission

### 12.1 Operating environment

Temperature : 20.6 °C  
 Relative Humidity : 28.3 % R.H.

### 12.2 Test set-up (Lay-out)

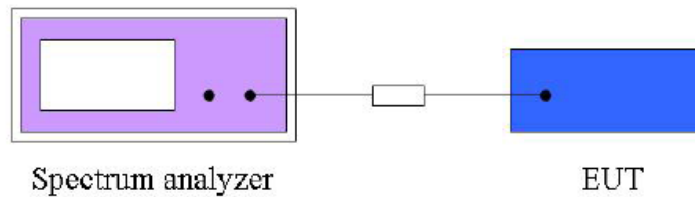

### 12.3 Limit

Below -20 dB of the highest emission level of operating band (in 100 kHz resolution band width)

### 12.4 Test equipment used

Model Name	Manufacturer	Description	Serial Number	Due to Calibration
■ - FSV	Rohde & Schwarz	Spectrum Analyzer	101552	Apr. 18, 2017
■ - 56-10	Weinschel	10 dB Attenuator	53184	Apr. 20. 2017
■ - 10 dB Attenuator	Rohde & Schwarz	Attenuator 10 dB	SEP-10-14-044	Apr. 17. 2018
■ - WMS 32	Rohde & Schwarz	Testing Software	VER10.20.01	N/A

### 12.5 Test Procedure

- a) Set analyzer center frequency to DTS channel center frequency.
- b) Set the span to 1.5 times the DTS bandwidth.
- c) Set the RBW to 3 kHz
- d) Set the VBW to 10 kHz
- e) Detector = peak.
- f) Sweep time = auto couple.
- g) Trace mode = max hold.
- h) Allow trace to fully stabilize.
- i) Use the peak marker function to determine the maximum amplitude level within the RBW.





### 12.6 Test Result

- Test Date : November 21, 2017
- Reference standard : Part 15 Subpart C, Sec. 15.247(a)(2)
- Test Procedure(s) : ANSI C63.10 (2013), KDB558074 D01 DTS Meas Guidance v04(April 5, 2017)
- Operating condition : RF transmitting mode (0 ch: 2 402 MHz, 19 ch: 2 440 MHz, 39 ch: 2 480 MHz)
- Power Source : DC 3.0 V

### Conducted Spurious Emission

Operating Frequency	100 kHz PSD (dBm)	Spurious Level (dBm)	Deviation (dBc)	Limits (dBc)	Result
2 402 MHz	0.6	-41.10	-41.70	-20.00	Complies
2 440 MHz	0.2	-41.94	-42.14		Complies
2 480 MHz	-0.8	-41.52	-40.72		Complies

### Conducted Out of Band(Band Edge) Emission

Operating Frequency	100 kHz PSD (dBm)	Bandedge Level (dBm)	Deviation (dBc)	Limits (dBc)	Result
2 402 MHz	0.6	-50.0	-50.6	-20.00	Complies
2 480 MHz	-0.8	-53.4	-52.6		Complies

### Conducted spurious Emission Plot on Configuration : 0ch

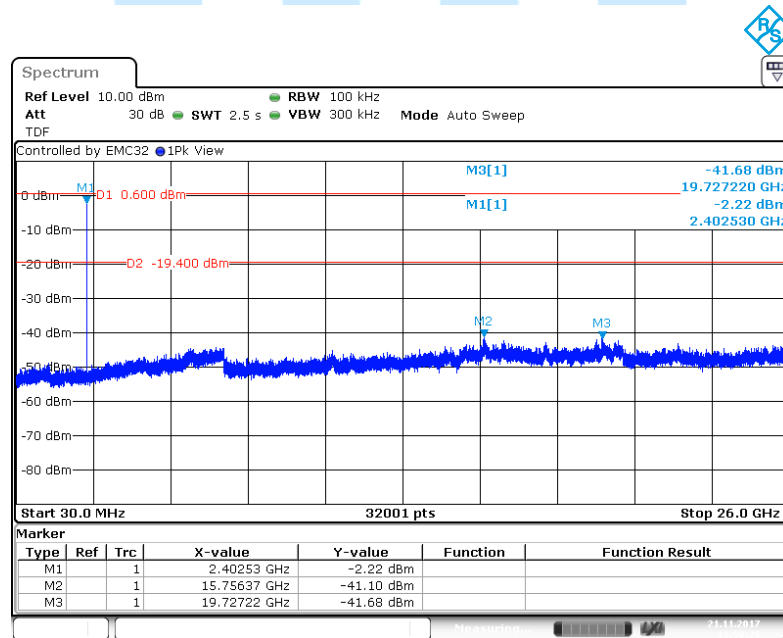



**Conducted spurious Emission Plot on Configuration : 19ch**

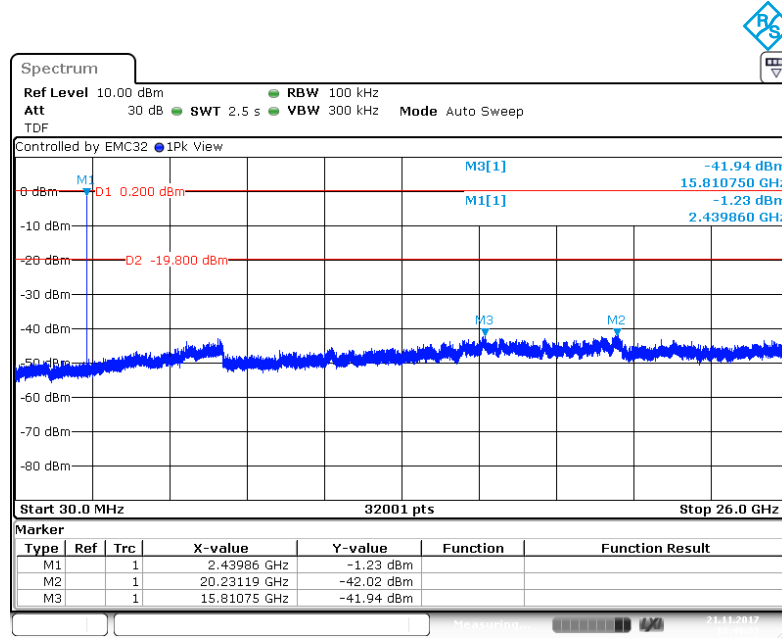

**Conducted spurious Emission Plot on Configuration : 39ch**

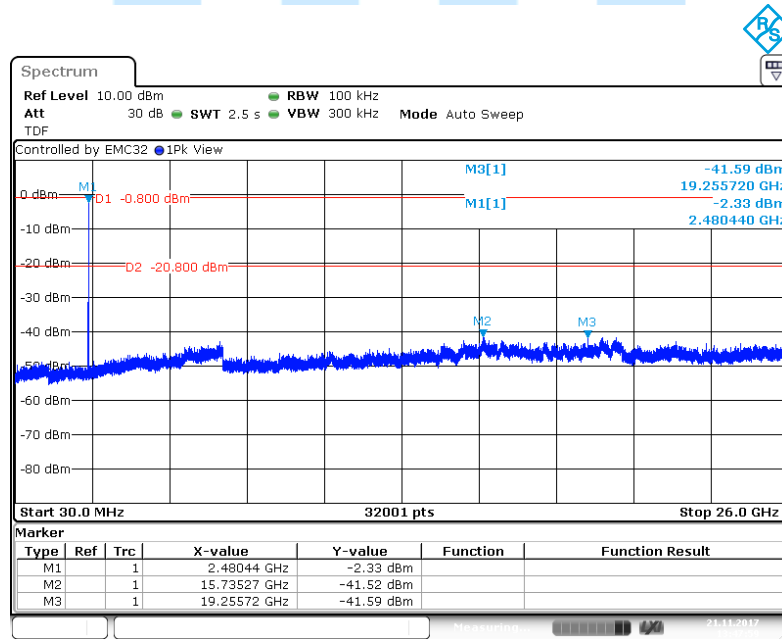



**Low Band Edge Plot on Configuration : 0ch**

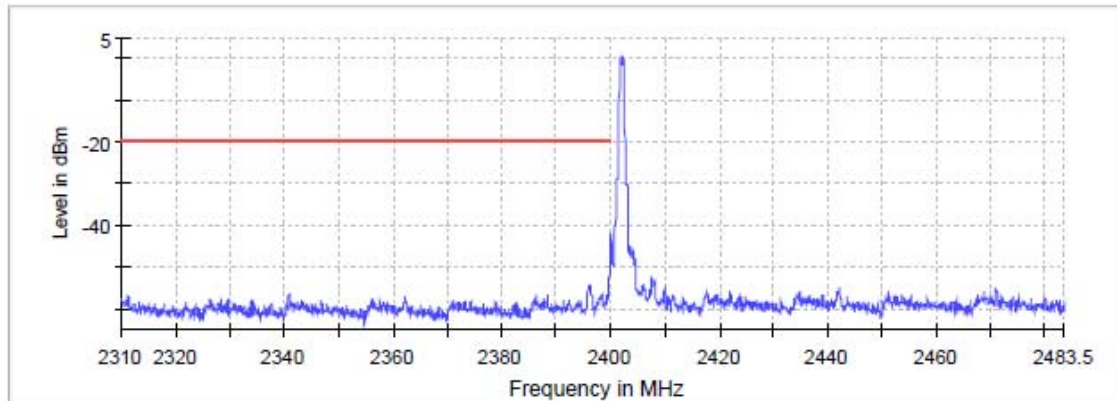

— Limit    — Sum Level    × Fail

**High Band Edge Plot on Configuration : 39ch**

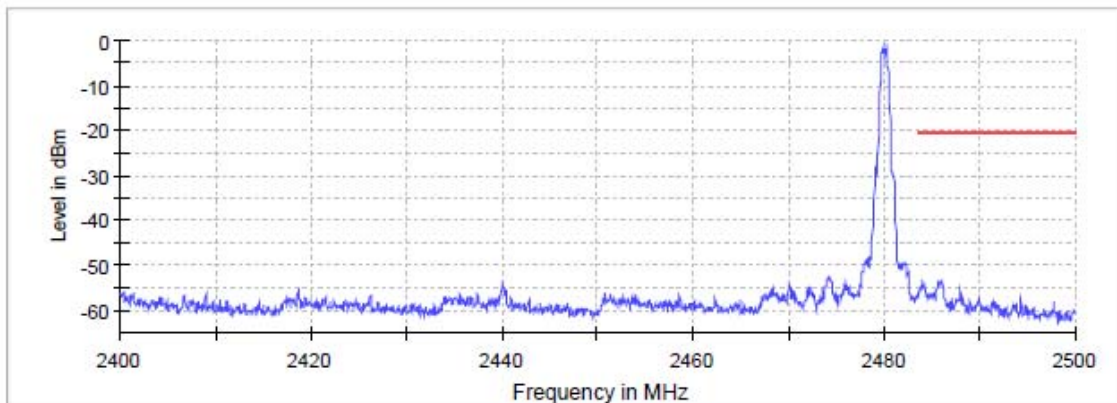

— Limit    — Sum Level    × Fail





### 13. AC Power line Conducted emission

#### -Test Description

The Line conducted emission test facility is inside a 4 m × 8 m × 2.5 m shielded enclosure. (Test firm Registration Number: 269701)

The EUT was placed on a non-conducting 1.0 m by 1.5 m table, which is 0.8 m in height and 0.4 m away from the vertical wall of the shielded enclosure.

The EUT is powered from the Rohde & Schwarz LISN (ENV216) and the support equipment is powered from the Rohde & Schwarz LISN (ENV216). Powers to the LISN are filtered by high-current high insertion loss power line filter.

Sufficient time for EUT, support equipment, and test equipment was allowed in order for them to warm up to their normal operating condition.

The RF output of the LISN was connected to the EMI test receiver (Rohde & Schwarz, ESCI).

Exploratory measurements were conducted to identify the highest emission by operating the EUT in a range of typical modes of operation, cable positions, system configuration and arrangement.

Based on exploratory measurements, the final measurements were conducted at the worst test conditions.

Exploratory measurements were scanned using Peak mode of EMI Test receiver from 150 kHz to 30 MHz with 20 ms sweep time. The final measurements were measured with Quasi-Peak and Average mode.

The bandwidth of EMI Test Receiver was set to 9 kHz. Interface cables were connected to the available interface ports of the test unit. Excess cable lengths were bundled at center with 30 cm ~ 40 cm.

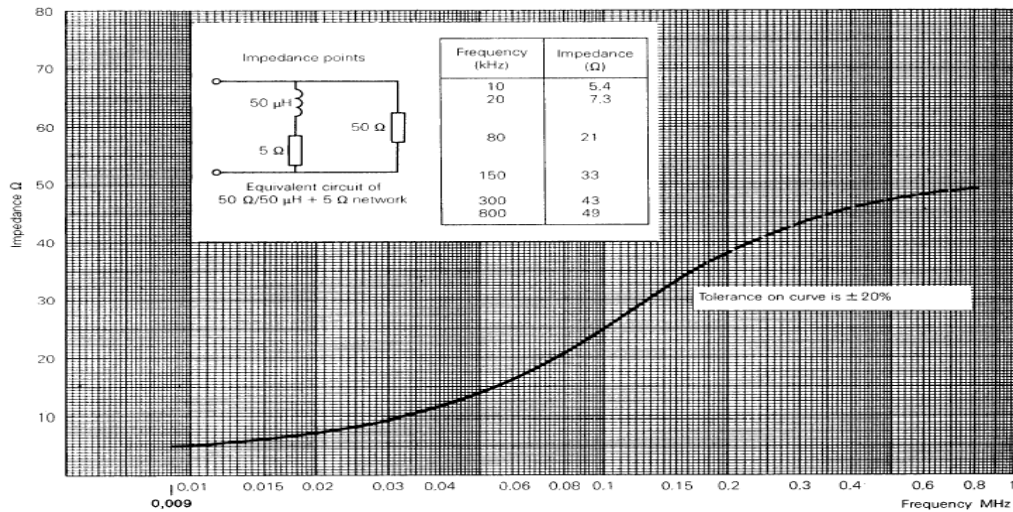

Fig 2. Impedance of LISN





### 13.1 Operating Environment

Temperature : - °C  
Relative Humidity : - % R.H.

### 13.2 Test Set-up

The conducted emission measurements were performed in the shielded room.

The EUT was placed on wooden table, 0.8 m heights above the floor, 0.4 m from the reference ground plane (GRP) wall and 0.8 m from AMN & ISN.

AMN is bonded on horizontal reference ground plane.

The ground plane, which was electrically bonded to the shield room, ground system and all power lines entering the shield room, were filtered.

### 13.3 Measurement Uncertainty

The measurement uncertainty was calculated in accordance with ISO "Guide to the expression of uncertainty in measurement."

The measurement uncertainty was given with a confidence of 95 %.

Test Items	Uncertainty	Remark
Conducted emission (9 kHz ~ 150 kHz)	3.85 dB	Confidence level of approximately 95 % ( $k = 2$ )
Conducted emission (150 kHz ~ 30 MHz)	3.32 dB	Confidence level of approximately 95 % ( $k = 2$ )





**13.4 Limit**

RFI Conducted	FCC Limit(dBμV/m) Class B	
Freq. Range	Quasi-Peak	Average
150 kHz ~ 0.5 MHz	66 ~ 56*	56 ~ 46*
0.5 MHz ~ 5 MHz	56	46
5 MHz ~ 30 MHz	60	50

\*Limits decreases linearly with the logarithm of frequency.

**13.5 Test Equipment used**

Model Name	Manufacturer	Description	Serial Number	Due to Calibration
<input type="checkbox"/> - ESCI	Rohde & Schwarz	EMI test receiver	100237	Apr 18. 2018
<input type="checkbox"/> - ENV216	Rohde & Schwarz	LISN	100172	Apr 19. 2018
<input type="checkbox"/> - ENV216	Rohde & Schwarz	LISN	100173	Apr 19. 2018
<input type="checkbox"/> - ISN T8	TESEQ. GmbH	ISN	24568	Apr 21. 2018
<input type="checkbox"/> - EMC 32	Rohde & Schwarz	Testing Software	VER8.53	N/A

**13.6 Test data for Conducted Emission**

- Test Date :
  - Reference Standard :
  - Test Procedure(s) :
  - Operating Condition :
  - Power Source :
  - Frequency rage :
  - Line :
  - Comment : Not Applicable
- ※ The EUT is supplied power from battery. Therefore this test was not applicable.







## 14. Radiated Spurious & Restricted Band Edge Emission

Exploratory Radiated measurements were conducted at the 3m semi anechoic chamber in order to identify the highest emission by operating the EUT in a range of typical modes of operation, cable positions, system configuration and arrangement.

Based on exploratory measurements, the final measurements were conducted at the worst test conditions.

Final measurements of below 1GHz were made at 3m or 10 m Chamber that complies with CISPR 16/ANSI C63.10. Above 1GHz final measurements were conducted at the 3m Chamber only.

For measurements above 1GHz, the bottom side of 3m chamber was installed with absorbers in order to meet SVSWR Limit.

Exploratory measurements were scanned using Peak mode of EMI Test receiver and final measurements were measured with Quasi-Peak mode (Below 1GHz) and Peak & Average mode (Above 1GHz).

The measurements were performed by rotating the EUT 360° and adjusting the receive antenna height from 1.0 m to 4.0 m. All frequencies were investigated in both horizontal and vertical antenna polarity.

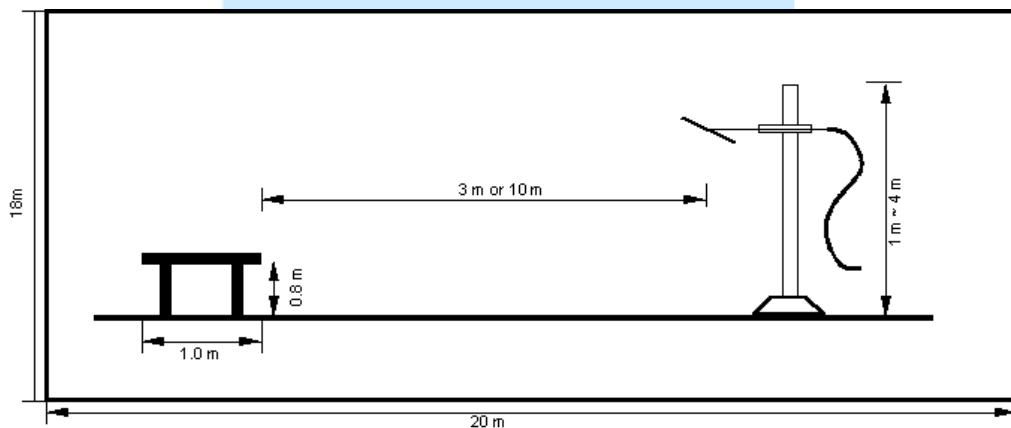

Fig 3. Dimensions of test site (Below 1GHz)

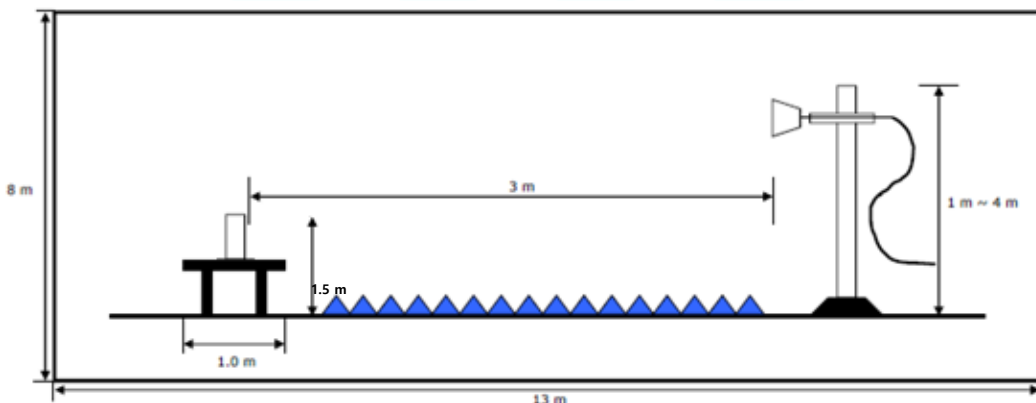

Fig 4. Dimensions of test site (Above 1GHz)





### 14.1 Operating environment

Temperature : 23.7 °C  
 Relative humidity : 32.5 % R.H.  
 Atmosphere : 101.7 kPa

### 14.2 Test set-up

A preliminary and final measurement was at 3 m anechoic chamber.

The EUT was placed on a non-conducting table.

For emissions testing at or below 1 GHz, the table height is 80 cm above the reference ground plane.

For emission measurements above 1 GHz, the table height is 1.5 m above the reference ground plane.

The turntable with EUT was rotated 360°, and the antenna was varied in height between 1.0 m and 4.0 m in order to determine the maximum emission levels.

This procedure was performed for both horizontal and vertical polarization of the receiving antenna.

### 14.3 Measurement uncertainty

The measurement uncertainty was calculated in accordance with ISO “Guide to the expression of uncertainty in measurement”.

The measurement uncertainty was given with a confidence of 95 %.

Test items(Anechoic Chamber)	Uncertainty	Remark
Radiated emission (30 MHz ~ 300 MHz, 3 m, Vertical)	5.01 dB	Confidence level of approximately 95 % ( $k = 2$ )
Radiated emission (30 MHz ~ 300 MHz, 3 m, Horizontal)	5.01 dB	Confidence level of approximately 95 % ( $k = 2$ )
Radiated emission (300 MHz ~ 1 000 MHz, 3 m, Vertical)	5.10 dB	Confidence level of approximately 95 % ( $k = 2$ )
Radiated emission (300 MHz ~ 1 000 MHz, 3 m, Horizontal)	5.10 dB	Confidence level of approximately 95 % ( $k = 2$ )
Radiated emission (1 000 MHz ~ 6 000 MHz, 3 m, V/H)	4.53 dB	Confidence level of approximately 95 % ( $k = 2$ )
Radiated emission (6 000 MHz ~ 18 000 MHz, 3 m, V/H)	4.55 dB	Confidence level of approximately 95 % ( $k = 2$ )
Radiated emission (18 000 MHz ~ 26 000 MHz, 3 m, V/H)	5.40 dB	Confidence level of approximately 95 % ( $k = 2$ )

Where relevant, the following measurement uncertainty levels have been estimated for tests performed on the EUT as specified in CISPR 16-4-2.

The listed uncertainties are the worst case uncertainty for the entire range of measurement. please note that the uncertainty values are provided for informational purposes only are not used in determining the PASS/FAIL results





**14.4 Limit**

20 dB in any 100 kHz bandwidth outside the operating frequency band. In case the emission fall within the restricted band specified on 15.205(a) limit in the table below has to be followed.

Frequencies (MHz)	Field Strength (microvolt/meter)	Measurement Distance (meters)
0.009 ~ 0.490	2 400/F (kHz)	300
0.490 ~ 1.705	2 400/F (kHz)	30
1.705 ~ 30.0	30	30
30 ~ 88	100	3
88 ~ 216	150	3
216 ~ 960	200	3
Above 960	500	3

**14.5 Test Equipment used**

Model Name	Manufacturer	Description	Serial Number	Due to Calibration
■ - ESU40	Rohde & Schwarz	EMI Test Receiver	100266	Apr. 18, 2018
■ - HFH2-Z2	Rohde & Schwarz	Loop Antenna	100041	Dec. 21, 2017
■ - VULB9160	Schwarzbeck	Broadband Test Antenna	3099	Sep. 29. 2019
■ - BBHA9120D	Schwarzbeck	Horn Antenna	207	Sep. 29. 2018
■ - 3160-09	Schwarzbeck	Horn Antenna	218457	Jan. 31. 2018
■ - MCU066	maturo GmbH	Position Controller	1390306	N/A
■ - TT2.5SI	maturo GmbH	Turntable	1390307	N/A
■ - AM 4.0	maturo GmbH	Antenna Mast	1390308	N/A
■ - AFS 44 00101800-25-10P-44	MITEQ	Preamplifier	1258943	Apr. 22, 2018
■ - SCU-F1826-G47-BZ42-CSS	BONN Elektronik	Preamplifier	10003	May. 12. 2018
■ - WHKX3.0/18G-10SS	WAINWRIGHT INSTRUMENTS	High pass filter	SN31	Apr. 18, 2018
■- EMC 32	Rohde & Schwarz	Testing Software	VER9.15	N/A





### 14.6 Test data for Radiated Spurious Emission

- Test Date : November 16 ~ 17 , 2017
- Reference Standard : Part 15 Subpart C, Sec. 15.247(d)
- Measuring Distance : 3 m
- Resolution Bandwidth : 200 Hz, 9 kHz(Below 30 MHz) / 120 kHz(30 MHz ~ 1GHz) / 1 MHz(Above 1GHz)
- Detector mode : Quasi Peak detector mode / Peak detector mode / Average detector mode
- Power Source : DC 3 V
- Note : Through three orthogonal axes were investigated and the worst case is report

#### Radiated Spurious Emission (9 kHz to 30 MHz)

※ The emission level was not found.

#### Radiated Spurious Emission (30 MHz to 1 000 MHz)

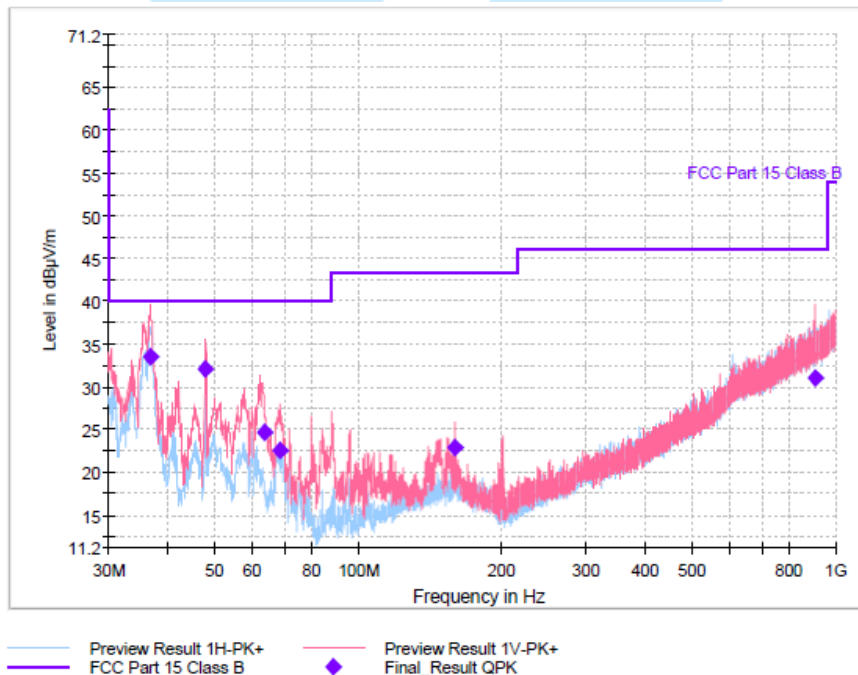

#### Final Result

Frequency (MHz)	QuasiPeak (dBµV/m)	Limit (dBµV/m)	Margin (dB)	Meas. Time (ms)	Bandwidth (kHz)	Height (cm)	Pol	Azimuth (deg)	Corr. (dB)
36.8925	33.53	40.00	6.47	1000.0	120.000	125.0	V	120.0	13.1
48.0069	32.11	40.00	7.89	1000.0	120.000	106.0	V	-55.0	13.8
63.5466	24.67	40.00	15.33	1000.0	120.000	205.0	V	347.0	12.4
68.8284	22.47	40.00	17.53	1000.0	120.000	107.0	V	242.0	11.5
160.0034	22.86	43.50	20.64	1000.0	120.000	100.0	V	214.0	16.0
907.6856	30.99	46.00	15.01	1000.0	120.000	388.0	V	163.0	31.3





**Radiated Spurious Emission (1 GHz to 25 GHz): 0ch**

Frequency (MHz)	Measurement Level						Limit (dBµV/m)		Margin (dB)		Positioning System			
	Reading Value (dBµV/m)		AF (dB/m)	AMP / CL (dB)	Duty Cycle collection (dB)	Test Result (dBµV/m)					Pol. (H/V)	Height (cm)	Angle (°)	
	Peak	Average				Peak	Average	Peak	Average					
1333.44	60.45	35.10	24.94	-37.75	-	47.64	22.29	74.00	54.00	26.36	31.71	V	163	332
1994.86	54.22	35.93	25.64	-37.33	-	42.53	24.24	74.00	54.00	31.47	29.76	V	155	127
4803.50	60.83	-	30.70	-34.83	-17.61	56.70	39.09	74.00	54.00	17.30	14.91	H	125	246
7207.00	60.47	-	35.75	-34.10	-17.61	62.12	44.51	74.00	54.00	11.88	9.49	H	204	54
14356.40	46.15	33.29	42.78	-34.10	-	54.83	41.97	74.00	54.00	19.17	12.03	H	125	268
17981.70	6.00	32.52	49.27	-34.10	-	60.81	47.69	74.00	54.00	13.19	6.31	H	215	175

**Radiated Spurious Emission (1 GHz to 25 GHz): 19ch**

Frequency (MHz)	Measurement Level						Limit (dBµV/m)		Margin (dB)		Positioning System			
	Reading Value (dBµV/m)		AF (dB/m)	AMP / CL (dB)	Duty Cycle collection (dB)	Test Result (dBµV/m)					Pol. (H/V)	Height (cm)	Angle (°)	
	Peak	Average				Peak	Average	Peak	Average					
1329.09	57.18	34.96	24.93	-37.75	-	44.36	22.14	74.00	54.00	29.64	31.86	V	165	330
1995.12	59.71	35.83	25.64	-37.33	-	48.02	24.14	74.00	54.00	25.98	29.86	V	164	3
2525.48	47.40	35.03	27.30	-36.88	-	37.82	25.45	74.00	54.00	36.18	28.55	V	175	185
4880.70	62.21	-	30.81	-34.83	-17.61	58.19	40.58	74.00	54.00	15.81	13.42	H	120	42
7319.40	58.53	-	35.96	-34.10	-17.61	60.39	42.78	74.00	54.00	13.61	11.22	H	109	73
17971.70	45.81	32.47	49.14	-34.10	-	60.85	47.51	74.00	54.00	13.15	6.49	V	200	218

**Radiated Spurious Emission (1 GHz to 25 GHz): 39ch**

Frequency (MHz)	Measurement Level						Limit (dBµV/m)		Margin (dB)		Positioning System			
	Reading Value (dBµV/m)		AF (dB/m)	AMP / CL (dB)	Duty Cycle collection (dB)	Test Result (dBµV/m)					Pol. (H/V)	Height (cm)	Angle (°)	
	Peak	Average				Peak	Average	Peak	Average					
1328.06	55.94	34.91	24.93	-37.75	-	43.12	22.09	74.00	54.00	30.88	31.91	V	163	16
1999.22	55.43	39.40	25.64	-37.33	-	43.74	27.71	74.00	54.00	30.26	26.29	V	132	104
2520.43	53.43	45.47	27.30	-36.88	-	43.85	35.89	74.00	54.00	30.15	18.11	H	175	321
4960.70	63.61	-	30.93	-34.51	-17.61	60.03	42.42	74.00	54.00	13.97	11.58	H	138	48
7441.00	57.17	-	36.19	-34.10	-17.61	59.26	41.65	74.00	54.00	14.74	12.35	H	106	81
17999.80	45.64	32.79	49.51	-34.10	-	61.05	48.20	74.00	54.00	12.95	5.80	V	150	56

Note:

If the maximized peak measured value complies with the average limit, then it is unnecessary to perform an average measurement.

Test result = Reading: + AF+AMP / CL

Where, AF : Antenna Collection Factor,

AMP / CL = Cable loss + Preamplifier gain + High Pass filter.

※ High Pass filter use to range of 3 GHz to 18 GHz

Average calculation = Peak – Duty Cycle Collection Factor (dB)

Duty Cycle Collection Factor :  $20\log(1.976/15.000) = -17.61$  dB

Pol.: H(Horizontal), V(Vertical)





**14.7 Test data for Radiated Restricted Band Edge Emission**

- Test Date : November 16, 2017
- Reference Standard : Part 15 Subpart C, Sec. 15.247(d)
- Measuring Distance : 3 m
- Resolution Bandwidth : 1 MHz
- Detector mode : Peak detector mode / Average detector mode
- Power Source : DC 3 V
- Note : Through three orthogonal axes were investigated and the worst case is report

**0ch, 39ch**

Frequency (MHz)	Measurement Level							Limit (dBµV/m)		Margin (dB)		Positioning System		
	Reading Value (dBµV/m)		AF (dB/m)	AMP / CL (dB)	Duty Cycle collection (dB)	Test Result (dBµV/m)						Pol. (H/V)	Height (cm)	Angle (°)
	Peak	Average				Peak	Average	Peak	Average					
2386.81	48.33	35.73	26.90	-36.98	-	38.25	25.65	74.00	54.00	35.75	28.35	V	150	148

Frequency (MHz)	Measurement Level							Limit (dBµV/m)		Margin (dB)		Positioning System		
	Reading Value (dBµV/m)		AF (dB/m)	AMP / CL (dB)	Duty Cycle collection (dB)	Test Result (dBµV/m)						Pol. (H/V)	Height (cm)	Angle (°)
	Peak	Average				Peak	Average	Peak	Average					
2483.53	59.15	46.54	27.21	-36.95	-	49.41	36.80	74.00	54.00	24.59	17.20	H	144	323

Note:

Test result = Reading: + Transducer Factor.

Where, ACF : Antenna Collection Factor,

CL = Cable loss + Pre-amplifier gain + High Pass filter

※ High Pass filter use to range of 3 GHz to 18 GHz

Pol.: H(Horizontal), V(Vertical)





## 15. Sample Calculations

$$\begin{aligned} \text{dB}\mu\text{V} &= 20 \text{ Log}_{10}(\mu\text{V}/\text{m}) \\ \text{dB}\mu\text{V} &= \text{dBm} + 107 \\ \mu\text{V} &= 10^{(\text{dB}\mu\text{V}/20)} \end{aligned}$$

### 15.1 Example 1 :

■ 20.3 MHz

**Class B Limit** = 250  $\mu\text{V}$  = 48 dB $\mu\text{V}$

**Reading** = 39.2 dB $\mu\text{V}$

$10^{(39.2\text{dB}\mu\text{V}/20)}$  = 91.2  $\mu\text{V}$

**Margin** = 48 dB $\mu\text{V}$  - 39.2 dB $\mu\text{V}$   
 = 8.8 dB

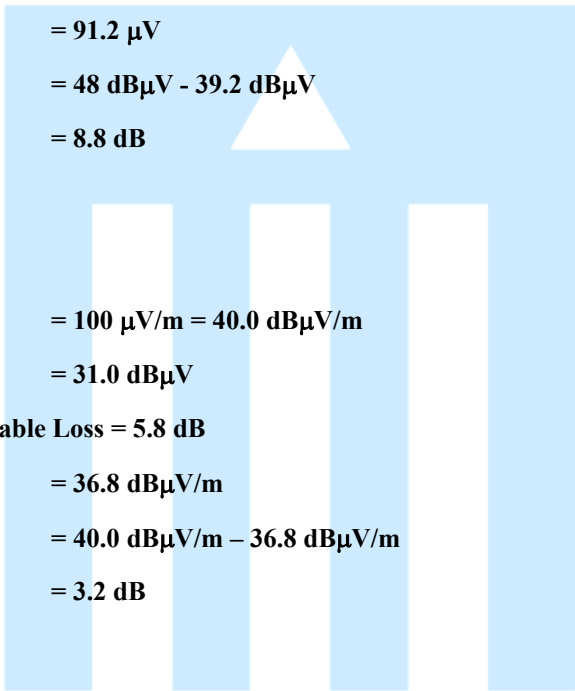

### 15.2 Example 2 :

■ 66.7 MHz

**Class B Limit** = 100  $\mu\text{V}/\text{m}$  = 40.0 dB $\mu\text{V}/\text{m}$

**Reading** = 31.0 dB $\mu\text{V}$

**Antenna Factor + Cable Loss** = 5.8 dB

**Total** = 36.8 dB $\mu\text{V}/\text{m}$

**Margin** = 40.0 dB $\mu\text{V}/\text{m}$  - 36.8 dB $\mu\text{V}/\text{m}$   
 = 3.2 dB





## 16. Recommendation & Conclusion

The data collected shows that the **Ohsung Electronics Co., Ltd. Remote Controller (Model Name: B526A)** was complies with §15.247 of the FCC Rules.

- The end -

