



中认信通
CHINA CERTIFICATION ICT CO., LTD (DONGGUAN)



TEST REPORT

Applicant: Shenzhen Four Seas Global Link Network Technology Co., Ltd

Address: Room 607-610, Block B, TAOJINDI Electronic Business Incubation Base, Tenglong Road, Longhua District, Shenzhen, China

FCC ID: OYR-CF-951AX

Product Name: Wireless USB Adapter

Model Number: CF-951AX, CF-952AX,CF-953AX,CF-943AX,
CF-955AX V2,CF-957AX V2,CF-959AX V2,
CF-921AC,CF-922AC,CF-950AX,CF-954AX

Standard(s): 47 CFR Part 15, Subpart E(15.407)
ANSI C63.10-2013
KDB 789033 D02 General U-NII Test Procedures New
Rules v02r01

The above equipment has been tested and found compliant with the requirement of the relative standards by China Certification ICT Co., Ltd (Dongguan)

Report Number: CR22070005-00C

Date Of Issue: 2022-09-05

Reviewed By: Sun Zhong

Sun Zhong

Title: Manager

Test Laboratory: China Certification ICT Co., Ltd (Dongguan)

No. 113, Pingkang Road, Dalang Town, Dongguan,
Guangdong, China
Tel: +86-769-82016888

Test Facility

The Test site used by China Certification ICT Co., Ltd (Dongguan) to collect test data is located on the No. 113, Pingkang Road, Dalang Town, Dongguan, Guangdong, China.

The lab has been recognized as the FCC accredited lab under the KDB 974614 D01 and is listed in the FCC Public Access Link (PAL) database, FCC Registration No. : 442868, the FCC Designation No. : CN1314.

The lab has been recognized by Innovation, Science and Economic Development Canada to test to Canadian radio equipment requirements, the CAB identifier: CN0123.

Declarations

China Certification ICT Co., Ltd (Dongguan) is not responsible for the authenticity of any test data provided by the applicant. Data included from the applicant that may affect test results are marked with a triangle symbol “▲”. Customer model name, addresses, names, trademarks etc. are not considered data.

Unless otherwise stated the results shown in this test report refer only to the sample(s) tested.

This report cannot be reproduced except in full, without prior written approval of the Company.

This report is valid only with a valid digital signature. The digital signature may be available only under the Adobe software above version 7.0.

This report may contain data that are not covered by the accreditation scope and shall be marked with an asterisk “★”.

CONTENTS

TEST FACILITY	2
DECLARATIONS.....	2
1. GENERAL INFORMATION	5
1.1 PRODUCT DESCRIPTION FOR EQUIPMENT UNDER TEST (EUT)	5
1.2 DESCRIPTION OF TEST CONFIGURATION.....	7
1.2.1 EUT Operation Condition:.....	7
1.2.2 Support Equipment List and Details	8
1.2.3 Support Cable List and Details	8
1.2.4 Block Diagram of Test Setup.....	8
1.3 MEASUREMENT UNCERTAINTY	10
2. SUMMARY OF TEST RESULTS	11
3. REQUIREMENTS AND TEST PROCEDURES	12
3.1 AC LINE CONDUCTED EMISSIONS.....	12
3.1.1 Applicable Standard.....	12
3.1.2 EUT Setup.....	13
3.1.3 EMI Test Receiver Setup	13
3.1.4 Test Procedure	14
3.1.5 Corrected Amplitude & Margin Calculation.....	14
3.2 RADIATION SPURIOUS EMISSIONS	15
3.2.1 Applicable Standard.....	15
3.2.2 EUT Setup.....	16
3.2.3 EMI Test Receiver & Spectrum Analyzer Setup	16
3.2.4 Test Procedure	17
3.2.5 Corrected Amplitude & Margin Calculation.....	17
3.3 EMISSION BANDWIDTH:	18
3.3.1 Applicable Standard.....	18
3.3.2 EUT Setup.....	18
3.3.3 Test Procedure	18
3.4 MAXIMUM CONDUCTED OUTPUT POWER:.....	20
3.4.1 Applicable Standard.....	20
3.4.2 EUT Setup.....	20
3.4.3 Test Procedure	20
3.5 MAXIMUM POWER SPECTRAL DENSITY:	21
3.5.1 Applicable Standard.....	21
3.5.2 EUT Setup.....	21
3.5.3 Test Procedure	22
3.7 DUTY CYCLE:.....	23
3.7.1 EUT Setup.....	23
3.7.2 Test Procedure	23
3.8 ANTENNA REQUIREMENT.....	24
3.8.1 Applicable Standard.....	24

3.8.2 Judgment.....	24
4. Test DATA AND RESULTS	25
4.1 AC LINE CONDUCTED EMISSIONS.....	25
4.2 RADIATION SPURIOUS EMISSIONS.....	28
4.3 EMISSION BANDWIDTH:	42
4.4 MAXIMUM CONDUCTED OUTPUT POWER:	56
4.5 MAXIMUM POWER SPECTRAL DENSITY:	58
4.6 DUTY CYCLE:.....	72

1. GENERAL INFORMATION

1.1 Product Description for Equipment under Test (EUT)

1.1.1 General:

EUT Name:	Wireless USB Adapter
EUT Model:	CF-951AX
Multiple Model:	CF-952AX,CF-953AX,CF-943AX,CF-955AX V2,CF-957AX V2,CF-959AX V2,CF-921AC,CF-922AC,CF-950AX,CF-954AX
Operation Frequency:	5180-5240 MHz (802.11a/n ht20) 5190-5230 MHz(802.11n ht40) 5210MHz(802.11ac vht80) 5745-5825 MHz (802.11a/n ht20) 5755-5795 MHz(802.11n ht40) 5775MHz(802.11ac vht80)
Maximum Average Output Power (Conducted):	16.85 dBm (5150-5250 MHz) 13.53 dBm (5725-5850 MHz)
Modulation Type:	OFDM-BPSK, QPSK, 16QAM, 64QAM,256QAM
Rated Input Voltage:	DC 5V from USB Host
Serial Number:	CR22070005-RF-S1
EUT Received Date:	2022.7.11
EUT Received Status:	Good

Note: The Multiple models are electrically identical with the test model. Please refer to the declaration letter for more detail, which was provided by manufacturer.

1.1.2 Operation Frequency Detail:

For 802.11a/n ht20:

5150-5250MHz Band		5725-5850MHz Band	
Channel	Frequency (MHz)	Channel	Frequency (MHz)
36	5180	149	5745
40	5200	153	5765
44	5220	157	5785
48	5240	161	5805
/	/	165	5825
Per section 15.31(m), the below frequencies were performed the test as below:			
36	5180	149	5745
40	5200	157	5785
48	5240	165	5825

For 802.11n ht40:

5150-5250MHz Band		5725-5850MHz Band	
Channel	Frequency (MHz)	Channel	Frequency (MHz)
38	5190	151	5755
46	5230	159	5795
Per section 15.31(m), the below frequencies were performed the test as below:			
38	5190	151	5755
46	5230	159	5795

For 802.11ac vht80:

5150-5250MHz Band		5725-5850MHz Band	
Channel	Frequency (MHz)	Channel	Frequency (MHz)
42	5210	155	5775
Per section 15.31(m), the below frequencies were performed the test as below:			
42	5210	155	5775

1.1.3 Antenna Information Detail▲:

Antenna Chain	Manufacturer	Antenna Type	input impedance (Ohm)	Frequency Range	Antenna Gain
Chain 0	Shenzhen Four Seas Global Link Network Technology Co., Ltd	PCB	50	2400-2500MHz	2.0 dBi
				5150-5850MHz	1.8 dBi
Chain 1		PCB	50	2400-2500MHz	-0.1 dBi
				5150-5850MHz	2.0 dBi

The Method of §15.203 Compliance:

- Antenna must be permanently attached to the unit.
 Antenna must use a unique type of connector to attach to the EUT.
 Unit must be professionally installed, and installer shall be responsible for verifying that the correct antenna is employed with the unit.

1.1.4 Accessory Information:

Accessory Description	Manufacturer	Model	Parameters
/	/	/	/

1.2 Description of Test Configuration

1.2.1 EUT Operation Condition:

EUT Operation Mode:	The system was configured for testing in Engineering Mode, which was provided by the manufacturer.
Equipment Modifications:	No
EUT Exercise Software:	M17961 QA 0.0.2.39

The software was provided by manufacturer. The maximum power was configured as below, that was provided by the manufacturer ▲ :

5150-5250 MHz Band:

Test Modes	Test Channels	Test Frequency (MHz)	Data rate	Power Level Setting	
				Chain 0	Chain 1
802.11a	Lowest	5180	6Mbps	11	10
	Middle	5200	6Mbps	11	10
	Highest	5240	6Mbps	11	10
802.11n ht20	Lowest	5180	MCS8	11	10
	Middle	5200	MCS8	11	10
	Highest	5240	MCS8	11	10
802.11n ht40	Lowest	5190	MCS8	11	10
	Highest	5230	MCS8	11	10
802.11ac vht80	Middle	5210	MCS8	11	10

5725-5850 MHz Band:

Test Modes	Test Channels	Test Frequency (MHz)	Data rate	Power Level Setting	
				Chain 0	Chain 1
802.11a	Lowest	5745	6Mbps	9	10
	Middle	5785	6Mbps	9	10
	Highest	5825	6Mbps	9	10
802.11n ht20	Lowest	5745	MCS8	9	10
	Middle	5785	MCS8	9	10
	Highest	5825	MCS8	9	10
802.11n ht40	Lowest	5755	MCS8	9	10
	Highest	5795	MCS8	9	10
802.11ac vht80	Middle	5775	MCS8	9	10

Note:

The above are the worst-case data rates, which are determined for each mode based upon investigations by measuring the average power and PSD across all data rates, bandwidths, and modulations.

The system support 802.11a/n ht20/n ht40/ac vht20/ac vht40/ac vht80, the vht20/vht40 were reduced since the identical parameters with 802.11n ht20 and ht40.

The device supports SISO in all modes, and MIMO 2T2R in 802.11n and 802.11ac modes, per pretest, 2T2R mode was the worst mode and reported for 802.11n and 802.11ac modes.

Spurious Emissions :

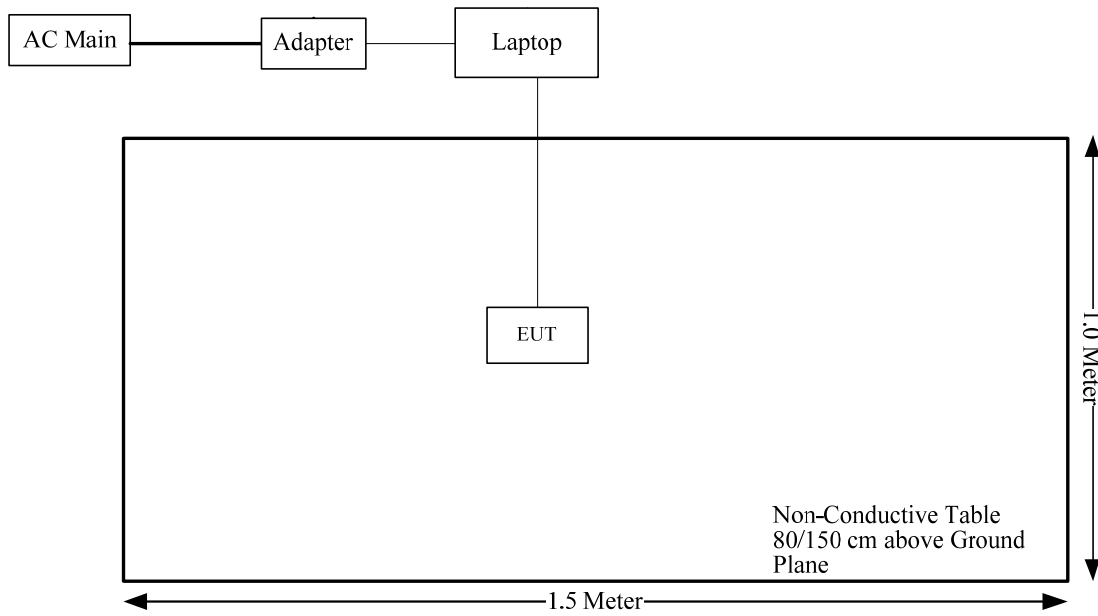

1.3 Measurement Uncertainty

Otherwise required by the applicant or Product Regulations, Decision Rule in this report did not consider the uncertainty. The extended uncertainty given in this report is obtained by combining the standard uncertainty times the coverage factor K with the 95% confidence interval.

Parameter	Measurement Uncertainty
Occupied Channel Bandwidth	±5 %
RF output power, conducted	±0.61dB
Power Spectral Density, conducted	±0.61 dB
Unwanted Emissions, radiated	30M~200MHz: 4.15 dB,200M~1GHz: 5.61 dB,1G~6GHz: 5.14 dB, 6G~18GHz: 5.93 dB,18G~26.5G:5.47 dB,26.5G~40G:5.63 dB
Unwanted Emissions, conducted	±1.26 dB
Temperature	±1 °C
Humidity	±5%
DC and low frequency voltages	±0.4%
Duty Cycle	1%
AC Power Lines Conducted Emission	2.8 dB (150 kHz to 30 MHz)

2. SUMMARY OF TEST RESULTS

Standard(s) Section	Test Items	Result
FCC§15.207(a)	AC line conducted emissions	Compliant
FCC§15.205& §15.209 &§15.407(b)	Undesirable Emission& Restricted Bands	Compliant
FCC§15.407(a) (e)	Emission Bandwidth	Compliant
FCC§15.407(a)	Conducted Transmitter Output Power	Compliant
FCC§15.407 (a)	Power Spectral Density	Compliant
FCC§15.203	Antenna Requirement	Compliant

3. REQUIREMENTS AND TEST PROCEDURES

3.1 AC Line Conducted Emissions

3.1.1 Applicable Standard

FCC§15.207(a).

(a) Except as shown in paragraphs (b) and (c) of this section, for an intentional radiator that is designed to be connected to the public utility (AC) power line, the radio frequency voltage that is conducted back onto the AC power line on any frequency or frequencies, within the band 150 kHz to 30 MHz, shall not exceed the limits in the following table, as measured using a 50 μ H/50 ohms line impedance stabilization network (LISN). Compliance with the provisions of this paragraph shall be based on the measurement of the radio frequency voltage between each power line and ground at the power terminal. The lower limit applies at the boundary between the frequency ranges.

Frequency of emission (MHz)	Conducted limit (dB μ V)	
	Quasi-peak	Average
0.15-0.5	66 to 56*	56 to 46*
0.5-5	56	46
5-30	60	50

*Decreases with the logarithm of the frequency.

(b) The limit shown in paragraph (a) of this section shall not apply to carrier current systems operating as intentional radiators on frequencies below 30 MHz. In lieu thereof, these carrier current systems shall be subject to the following standards:

(1) For carrier current system containing their fundamental emission within the frequency band 535-1705 kHz and intended to be received using a standard AM broadcast receiver: no limit on conducted emissions.

(2) For all other carrier current systems: 1000 μ V within the frequency band 535-1705 kHz, as measured using a 50 μ H/50 ohms LISN.

(3) Carrier current systems operating below 30 MHz are also subject to the radiated emission limits in §15.205, §15.209, §15.221, §15.223, or §15.227, as appropriate.

(c) Measurements to demonstrate compliance with the conducted limits are not required for devices which only employ battery power for operation and which do not operate from the AC power lines or contain provisions for operation while connected to the AC power lines. Devices that include, or make provisions for, the use of battery chargers which permit operating while charging, AC adapters or battery eliminators or that connect to the AC power lines indirectly, obtaining their power through another device which is connected to the AC power lines, shall be tested to demonstrate compliance with the conducted limits.

3.1.2 EUT Setup

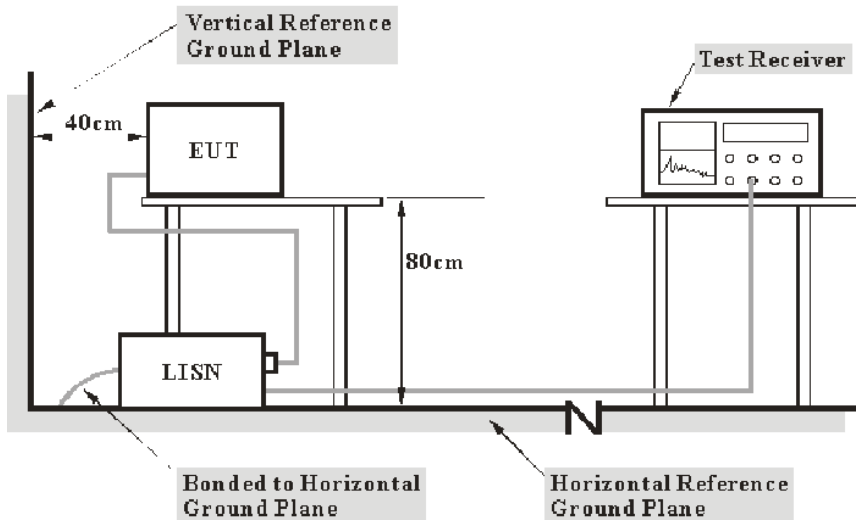

- Note: 1. Support units were connected to second LISN.
 2. Both of LISNs (AMN) 80 cm from EUT and at the least 80 cm from other units and other metal planes support units.

The setup of EUT is according with per ANSI C63.10-2013 measurement procedure. The specification used was with the FCC Part 15.207 limits.

The spacing between the peripherals was 10 cm.

The adapter or EUT was connected to the main LISN with a 120 V/60 Hz AC power source.

3.1.3 EMI Test Receiver Setup

The EMI test receiver was set to investigate the spectrum from 150 kHz to 30 MHz.

During the conducted emission test, the EMI test receiver was set with the following configurations:

Frequency Range	IF B/W
150 kHz – 30 MHz	9 kHz

3.1.4 Test Procedure

The frequency and amplitude of the six highest ac power-line conducted emissions relative to the limit, measured over all the current-carrying conductors of the EUT power cords, and the operating frequency or frequency to which the EUT is tuned (if appropriate), should be reported, unless such emissions are more than 20 dB below the limit. AC power-line conducted emissions measurements are to be separately carried out only on each of the phase (“hot”) line(s) and (if used) on the neutral line(s), but not on the ground [protective earth] line(s). If less than six emission frequencies are within 20 dB of the limit, then the noise level of the measuring instrument at representative frequencies should be reported. The specific conductor of the power-line cord for each of the reported emissions should be identified. Measure the six highest emissions with respect to the limit on each current-carrying conductor of each power cord associated with the EUT (but not the power cords of associated or peripheral equipment that are part of the test configuration). Then, report the six highest emissions with respect to the limit from among all the measurements identifying the frequency and specific current-carrying conductor identified with the emission. The six highest emissions should be reported for each of the current-carrying conductors, or the six highest emissions may be reported over all the current-carrying conductors.

3.1.5 Corrected Amplitude & Margin Calculation

The basic equation is as follows:

Result = Reading + Factor

Factor = attenuation caused by cable loss + voltage division factor of AMN

The “**Margin**” column of the following data tables indicates the degree of compliance within the applicable limit. The equation for margin calculation is as follows:

Margin = Limit – Result

3.2 Radiation Spurious Emissions

3.2.1 Applicable Standard

FCC §15.407 (b);

Undesirable emission limits. Except as shown in paragraph (b)(7) of this section, the maximum emissions outside of the frequency bands of operation shall be attenuated in accordance with the following limits:

(1) For transmitters operating in the 5.15-5.25 GHz band: All emissions outside of the 5.15-5.35 GHz band shall not exceed an e.i.r.p. of - 27 dBm/MHz.

(2) For transmitters operating in the 5.25-5.35 GHz band: All emissions outside of the 5.15-5.35 GHz band shall not exceed an e.i.r.p. of - 27 dBm/MHz.

(3) For transmitters operating in the 5.47-5.725 GHz band: All emissions outside of the 5.47-5.725 GHz band shall not exceed an e.i.r.p. of - 27 dBm/MHz.

(4) For transmitters operating solely in the 5.725-5.850 GHz band:

(i) All emissions shall be limited to a level of - 27 dBm/MHz at 75 MHz or more above or below the band edge increasing linearly to 10 dBm/MHz at 25 MHz above or below the band edge, and from 25 MHz above or below the band edge increasing linearly to a level of 15.6 dBm/MHz at 5 MHz above or below the band edge, and from 5 MHz above or below the band edge increasing linearly to a level of 27 dBm/MHz at the band edge.

(ii) Devices certified before March 2, 2017 with antenna gain greater than 10 dBi may demonstrate compliance with the emission limits in § 15.247(d), but manufacturing, marketing and importing of devices certified under this alternative must cease by March 2, 2018. Devices certified before March 2, 2018 with antenna gain of 10 dBi or less may demonstrate compliance with the emission limits in § 15.247(d), but manufacturing, marketing and importing of devices certified under this alternative must cease before March 2, 2020.

(8) The emission measurements shall be performed using a minimum resolution bandwidth of 1 MHz. A lower resolution bandwidth may be employed near the band edge, when necessary, provided the measured energy is integrated to show the total power over 1 MHz.

(9) Unwanted emissions below 1 GHz must comply with the general field strength limits set forth in § 15.209. Further, any U-NII devices using an AC power line are required to comply also with the conducted limits set forth in § 15.207.

(10) The provisions of § 15.205 apply to intentional radiators operating under this section.

(11) When measuring the emission limits, the nominal carrier frequency shall be adjusted as close to the upper and lower frequency band edges as the design of the equipment permits.

(c) The device shall automatically discontinue transmission in case of either absence of information to transmit or operational failure. These provisions are not intended to preclude the transmission of control or signalling information or the use of repetitive codes used by certain digital technologies to complete frame or burst intervals. Applicants shall include in their application for equipment authorization a description of how this requirement is met.

3.2.2 EUT Setup

Below 1GHz:

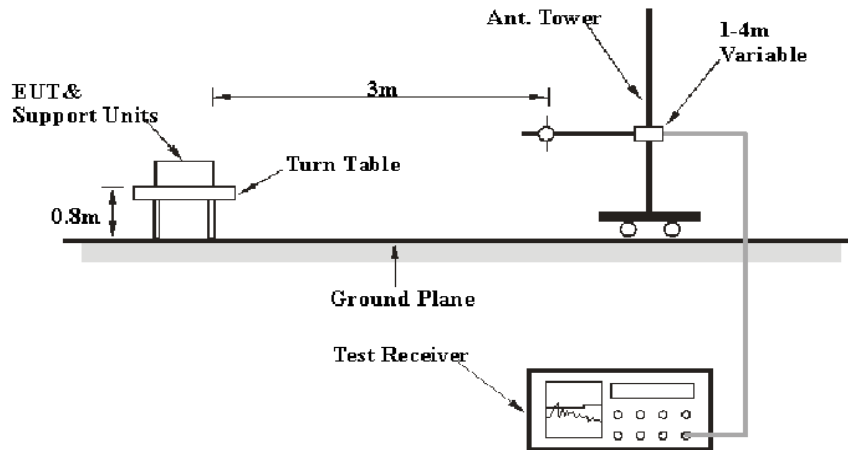

1-40 GHz:

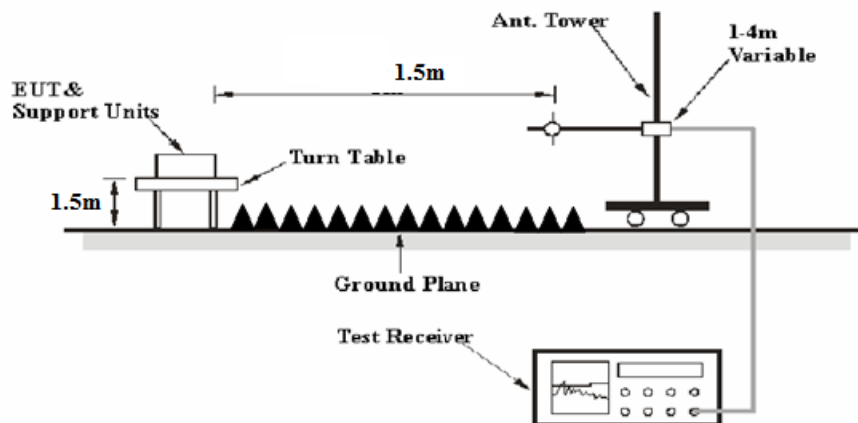

The radiated emission tests were performed in the 3 meters chamber test site, using the setup accordance with the ANSI C63.10-2013. The specification used was FCC 15.209, FCC 15.407 limits.

The external I/O cables were draped along the test table and formed a bundle 30 to 40 cm long in the middle.

The spacing between the peripherals was 10 cm.

3.2.3 EMI Test Receiver & Spectrum Analyzer Setup

The system was investigated from 30 MHz to 40 GHz.

During the radiated emission test, the EMI test receiver & Spectrum Analyzer Setup were set with the following configurations:

30MHz-1000MHz:

Measurement	RBW	Video B/W	IF B/W
QP	120 kHz	300 kHz	120kHz

1GHz- 40GHz:

Measurement	Duty cycle	RBW	Video B/W
PK	Any	1MHz	3 MHz
AV	>98%	1MHz	10 Hz
	<98%	1MHz	1/T

Note: T is minimum transmission duration

If the maximized peak measured value complies with under the QP/Average limit more than 6dB, then it is unnecessary to perform an QP/Average measurement.

3.2.4 Test Procedure

During the radiated emission test, the adapter was connected to the first AC floor outlet.

Data was recorded in Quasi-peak detection mode for frequency range of 30 MHz-1GHz, peak and Average detection modes for frequencies above 1GHz.

According to KDB 789033 D02 General UNII Test Procedures New Rules v02r01, emission shall be computed as: $E [dB\mu V/m] = EIRP[dBm] + 95.2$, for $d = 3$ meters.

According to C63.10, the above 1G test result shall be extrapolated to the specified distance using an extrapolation Factor of 20dB/decade from 3m to 1.5m or 1m
Distance extrapolation Factor = $20 \log (\text{specific distance [3m]}/\text{test distance [1.5m]})$ dB= 6.02 dB

All emissions under the average limit and under the noise floor have not recorded in the report.

3.2.5 Corrected Amplitude & Margin Calculation

The basic equation is as follows:

Factor = Antenna Factor + Cable Loss- Amplifier Gain

For 30MHz-1GHz:

Result = Reading + Factor

For 1GHz-40GHz

Result = Reading + Factor-Distance extrapolation Factor

The “**Margin**” column of the following data tables indicates the degree of compliance within the applicable limit. The equation for margin calculation is as follows:

Margin = Limit – Result

3.3 Emission Bandwidth:

3.3.1 Applicable Standard

FCC §15.407 (a),(h)

(h)(2) Radar Detection Function of Dynamic Frequency Selection (DFS). U-NII devices operating with any part of its 26 dB emission bandwidth in the 5.25-5.35 GHz and 5.47-5.725 GHz bands shall employ a DFS radar detection mechanism to detect the presence of radar systems and to avoid co-channel operation with radar systems.

FCC §15.407 (e)

Within the 5.725-5.850 GHz and 5.850-5.895 GHz bands, the minimum 6 dB bandwidth of U-NII devices shall be at least 500 kHz.

3.3.2 EUT Setup

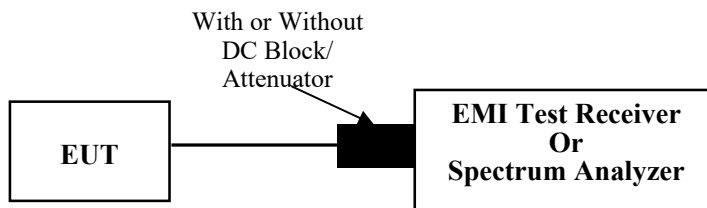

3.3.3 Test Procedure

26dB Emission Bandwidth:

According to ANSI C63.10-2013 Section 12.4.1

- a) Set RBW = approximately 1% of the emission bandwidth.
- b) Set the VBW > RBW.
- c) Detector = peak.
- d) Trace mode = max hold
- e) Measure the maximum width of the emission that is 26 dB down from the peak of the emission. Compare this with the RBW setting of the instrument. Readjust RBW and repeat measurement as needed until the RBW/EBW ratio is approximately 1%.

6 dB emission bandwidth:

According to KDB 789033 D02 General UNII Test Procedures New Rules v02r01

- a) Set RBW = 100 kHz.
- b) Set the video bandwidth (VBW) ≥ 3 RBW.
- c) Detector = Peak.
- d) Trace mode = max hold.
- e) Sweep = auto couple.
- f) Allow the trace to stabilize.
- g) Measure the maximum width of the emission that is constrained by the frequencies associated with the two outermost amplitude points (upper and lower frequencies) that are attenuated by 6 dB relative to the maximum level measured in the fundamental emission.

Note: The automatic bandwidth measurement capability of a spectrum analyzer or EMI receiver may be employed if it implements the functionality described in this section. For devices that use channel aggregation refer to III.A and III.C for determining emission bandwidth.

99% Occupied Bandwidth:

According to ANSI C63.10-2013 Section 12.4.2&6.9.3

The occupied bandwidth is the frequency bandwidth such that, below its lower and above its upper frequency limits, the mean powers are each equal to 0.5% of the total mean power of the given emission. The following procedure shall be used for measuring 99% power bandwidth:

- a) The instrument center frequency is set to the nominal EUT channel center frequency. The frequency span for the spectrum analyzer shall be between 1.5 times and 5.0 times the OBW.
- b) The nominal IF filter bandwidth (3 dB RBW) shall be in the range of 1% to 5% of the OBW, and VBW shall be approximately three times the RBW, unless otherwise specified by the applicable requirement.
- c) Set the reference level of the instrument as required, keeping the signal from exceeding the maximum input mixer level for linear operation. In general, the peak of the spectral envelope shall be more than $[10 \log (OBW/RBW)]$ below the reference level. Specific guidance is given in 4.1.5.2.
- d) Step a) through step c) might require iteration to adjust within the specified range.
- e) Video averaging is not permitted. Where practical, a sample detection and single sweep mode shall be used. Otherwise, peak detection and max hold mode (until the trace stabilizes) shall be used.
- f) Use the 99% power bandwidth function of the instrument (if available) and report the measured bandwidth.
- g) If the instrument does not have a 99% power bandwidth function, then the trace data points are recovered and directly summed in linear power terms. The recovered amplitude data points, beginning at the lowest frequency, are placed in a running sum until 0.5% of the total is reached; that frequency is recorded as the lower frequency. The process is repeated until 99.5% of the total is reached; that frequency is recorded as the upper frequency. The 99% power bandwidth is the difference between these two frequencies.
- h) The occupied bandwidth shall be reported by providing plot(s) of the measuring instrument display; the plot axes and the scale units per division shall be clearly labeled. Tabular data may be reported in addition to the plot(s).

3.4 Maximum conducted output power:

3.4.1 Applicable Standard

FCC §15.407(a) (1)(iv)

For client devices in the 5.15-5.25 GHz band, the maximum conducted output power over the frequency band of operation shall not exceed 250 mW provided the maximum antenna gain does not exceed 6 dBi. In addition, the maximum power spectral density shall not exceed 11 dBm in any 1 megahertz band. If transmitting antennas of directional gain greater than 6 dBi are used, both the maximum conducted output power and the maximum power spectral density shall be reduced by the amount in dB that the directional gain of the antenna exceeds 6 dBi.

FCC §15.407(a) (2)

For the 5.25-5.35 GHz and 5.47-5.725 GHz bands, the maximum conducted output power over the frequency bands of operation shall not exceed the lesser of 250 mW or $11 \text{ dBm} + 10 \log B$, where B is the 26 dB emission bandwidth in megahertz. In addition, the maximum power spectral density shall not exceed 11 dBm in any 1 megahertz band. If transmitting antennas of directional gain greater than 6 dBi are used, both the maximum conducted output power and the maximum power spectral density shall be reduced by the amount in dB that the directional gain of the antenna exceeds 6 dBi.

FCC §15.407(a) (3)(i)

For the band 5.725-5.850 GHz, the maximum conducted output power over the frequency band of operation shall not exceed 1 W. In addition, the maximum power spectral density shall not exceed 30 dBm in any 500-kHz band. If transmitting antennas of directional gain greater than 6 dBi are used, both the maximum conducted output power and the maximum power spectral density shall be reduced by the amount in dB that the directional gain of the antenna exceeds 6 dBi. However, fixed point-to-point U-NII devices operating in this band may employ transmitting antennas with directional gain greater than 6 dBi without any corresponding reduction in transmitter conducted power. Fixed, point-to-point operations exclude the use of point-to-multipoint systems, omnidirectional applications, and multiple collocated transmitters transmitting the same information. The operator of the U-NII device, or if the equipment is professionally installed, the installer, is responsible for ensuring that systems employing high gain directional antennas are used exclusively for fixed, point-to-point operations.

3.4.2 EUT Setup

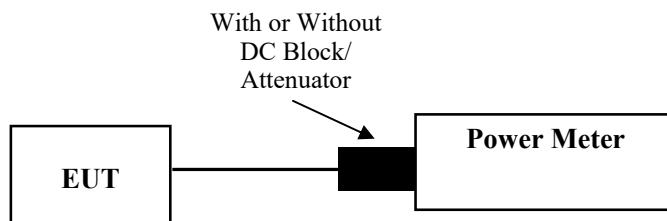

3.4.3 Test Procedure

According to ANSI C63.10-2013 Section 11.9.1.3

Method PM-G is measurement using a gated RF average power meter. Measurements may be performed using a wideband gated RF power meter provided that the gate parameters are adjusted such that the power is measured only when the EUT is transmitting at its maximum power control level. Because the measurement is made only during the ON time of the transmitter, no duty cycle correction factor is required.

3.5 Maximum power spectral density:

3.5.1 Applicable Standard

FCC §15.407(a) (1)(iv)

For client devices in the 5.15-5.25 GHz band, the maximum conducted output power over the frequency band of operation shall not exceed 250 mW provided the maximum antenna gain does not exceed 6 dBi. In addition, the maximum power spectral density shall not exceed 11 dBm in any 1 megahertz band. If transmitting antennas of directional gain greater than 6 dBi are used, both the maximum conducted output power and the maximum power spectral density shall be reduced by the amount in dB that the directional gain of the antenna exceeds 6 dBi.

FCC §15.407(a) (2)

For the 5.25-5.35 GHz and 5.47-5.725 GHz bands, the maximum conducted output power over the frequency bands of operation shall not exceed the lesser of 250 mW or $11 \text{ dBm} + 10 \log B$, where B is the 26 dB emission bandwidth in megahertz. In addition, the maximum power spectral density shall not exceed 11 dBm in any 1 megahertz band. If transmitting antennas of directional gain greater than 6 dBi are used, both the maximum conducted output power and the maximum power spectral density shall be reduced by the amount in dB that the directional gain of the antenna exceeds 6 dBi.

FCC §15.407(a) (3)(i)

For the band 5.725-5.850 GHz, the maximum conducted output power over the frequency band of operation shall not exceed 1 W. In addition, the maximum power spectral density shall not exceed 30 dBm in any 500-kHz band. If transmitting antennas of directional gain greater than 6 dBi are used, both the maximum conducted output power and the maximum power spectral density shall be reduced by the amount in dB that the directional gain of the antenna exceeds 6 dBi. However, fixed point-to-point U-NII devices operating in this band may employ transmitting antennas with directional gain greater than 6 dBi without any corresponding reduction in transmitter conducted power. Fixed, point-to-point operations exclude the use of point-to-multipoint systems, omnidirectional applications, and multiple collocated transmitters transmitting the same information. The operator of the U-NII device, or if the equipment is professionally installed, the installer, is responsible for ensuring that systems employing high gain directional antennas are used exclusively for fixed, point-to-point operations.

3.5.2 EUT Setup

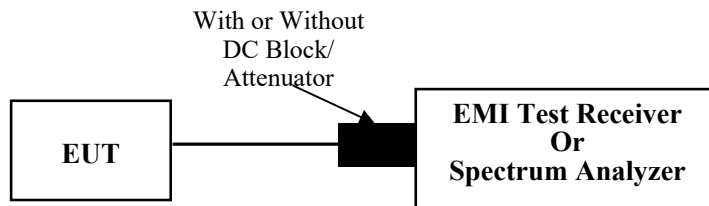

3.5.3 Test Procedure

According to KDB 789033 D02 General UNII Test Procedures New Rules v02r01

Method SA-3 (power averaging (rms) detection with max hold):

(i) Set span to encompass the entire EBW (or, alternatively, the entire 99% occupied bandwidth) of the signal.

(ii) Set sweep trigger to “free run.”

(iii) Set RBW = 1 MHz.

(iv) Set VBW \geq 3 MHz

(v) Number of points in sweep $\geq 2 \times \text{span} / \text{RBW}$. (This ensures that bin-to-bin spacing is $\leq \text{RBW}/2$, so that narrowband signals are not lost between frequency bins.)

(vi) Sweep time \leq (number of points in sweep) $\times T$, where T is defined in II.B.1.a).

Note: If this results in a sweep time less than the auto sweep time of the analyzer, Method SA-3 Alternative shall not be used. (The purpose of this step is to ensure that averaging time in each bin is less than or equal to the minimum time of a transmission.)

(vii) Detector = power averaging (rms).

(viii) Trace mode = max hold.

(ix) Allow max hold to run for at least 60 seconds, or longer as needed to allow the trace to stabilize.

For devices operating in the band 5.725–5.85 GHz, the rules specify a measurement bandwidth of 500 kHz. Many spectrum analyzers do not have 500 kHz RBW, thus a narrower RBW may need to be used.

3.7 Duty Cycle:

3.7.1 EUT Setup

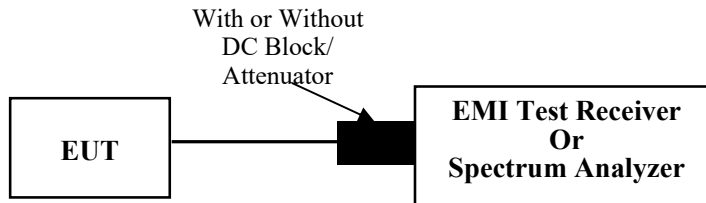

3.7.2 Test Procedure

According to ANSI C63.10-2013 Section 12.2

The zero-span mode on a spectrum analyzer or EMI receiver if the response time and spacing between bins on the sweep are sufficient to permit accurate measurements of the ON and OFF times of the transmitted signal:

- 1) Set the center frequency of the instrument to the center frequency of the transmission.
- 2) Set $RBW \geq OBW$ if possible; otherwise, set RBW to the largest available value.
- 3) Set $VBW \geq RBW$. Set detector = peak or average.
- 4) The zero-span measurement method shall not be used unless both RBW and VBW are $> 50/T$ and the number of sweep points across duration T exceeds 100. (For example, if VBW and/or RBW are limited to 3 MHz, then the zero-span method of measuring the duty cycle shall not be used if $T \leq 16.7 \mu s$.)

3.8 Antenna Requirement

3.8.1 Applicable Standard

FCC §15.203

An intentional radiator shall be designed to ensure that no antenna other than that furnished by the responsible party shall be used with the device. The use of a permanently attached antenna or of an antenna that uses a unique coupling to the intentional radiator shall be considered sufficient to comply with the provisions of this section. The manufacturer may design the unit so that a broken antenna can be replaced by the user, but the use of a standard antenna jack or electrical connector is prohibited. This requirement does not apply to carrier current devices or to devices operated under the provisions of §§15.211, 15.213, 15.217, 15.219, 15.221, or §15.236. Further, this requirement does not apply to intentional radiators that must be professionally installed, such as perimeter protection systems and some field disturbance sensors, or to other intentional radiators which, in accordance with §15.31(d), must be measured at the installation site. However, the installer shall be responsible for ensuring that the proper antenna is employed so that the limits in this part are not exceeded.

3.8.2 Judgment

Result: Compliant. Please refer to the Antenna Information detail in Section 1.

4. Test DATA AND RESULTS

4.1 AC Line Conducted Emissions

Serial Number:	CR22070005-RF-S1	Test Date:	2022-07-18
Test Site:	CE	Test Mode:	Transmitting (802.11a chain 0 5785MHz was the worst)
Tester:	Vic Du	Test Result:	Pass

Environmental Conditions:

Temperature: (°C)	28.4	Relative Humidity: (%)	64	ATM Pressure: (kPa)	100
----------------------	------	------------------------------	----	------------------------	-----

Test Equipment List and Details:

Manufacturer	Description	Model	Serial Number	Calibration Date	Calibration Due Date
R&S	LISN	ENV216	101134	2022-04-01	2023-03-31
R&S	EMI Test Receiver	ESR3	102726	2021-07-22	2022-07-21
MICRO-COAX	Coaxial Cable	UTIFLEX	C-0200-01	2021-08-08	2022-08-07
Audix	Test Software	E3	190306 (V9)	N/A	N/A

* Statement of Traceability: China Certification ICT Co., Ltd (Dongguan) attests that all calibrations have been performed, traceable to National Primary Standards and International System of Units (SI).

Line:

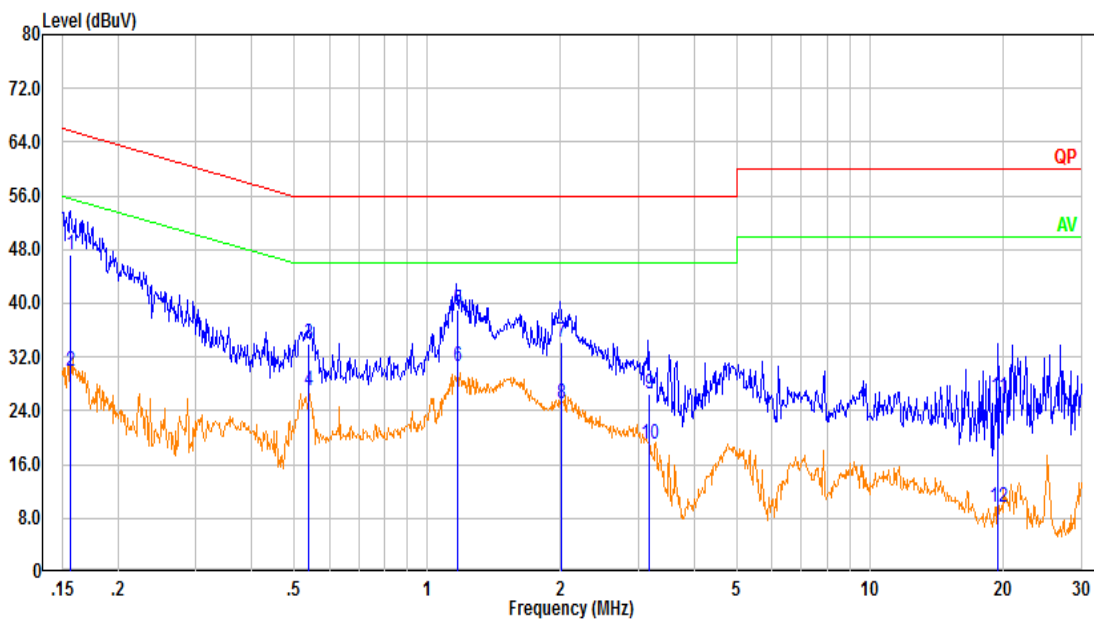

No.	Frequency (MHz)	Reading (dBμV)	Factor (dB)	Result (dBμV)	Limit (dBμV)	Margin (dB)	Detector
1	0.156	37.57	9.61	47.18	65.67	18.49	QP
2	0.156	20.35	9.61	29.96	55.67	25.71	Average
3	0.539	24.25	9.61	33.86	56.00	22.14	QP
4	0.539	17.46	9.61	27.07	46.00	18.93	Average
5	1.168	29.46	9.62	39.08	56.00	16.92	QP
6	1.168	21.05	9.62	30.67	46.00	15.33	Average
7	2.004	24.48	9.63	34.11	56.00	21.89	QP
8	2.004	15.52	9.63	25.15	46.00	20.85	Average
9	3.165	16.74	9.65	26.39	56.00	29.61	QP
10	3.165	9.37	9.65	19.02	46.00	26.98	Average
11	19.497	16.27	9.78	26.05	60.00	33.95	QP
12	19.497	-0.15	9.78	9.64	50.00	40.36	Average

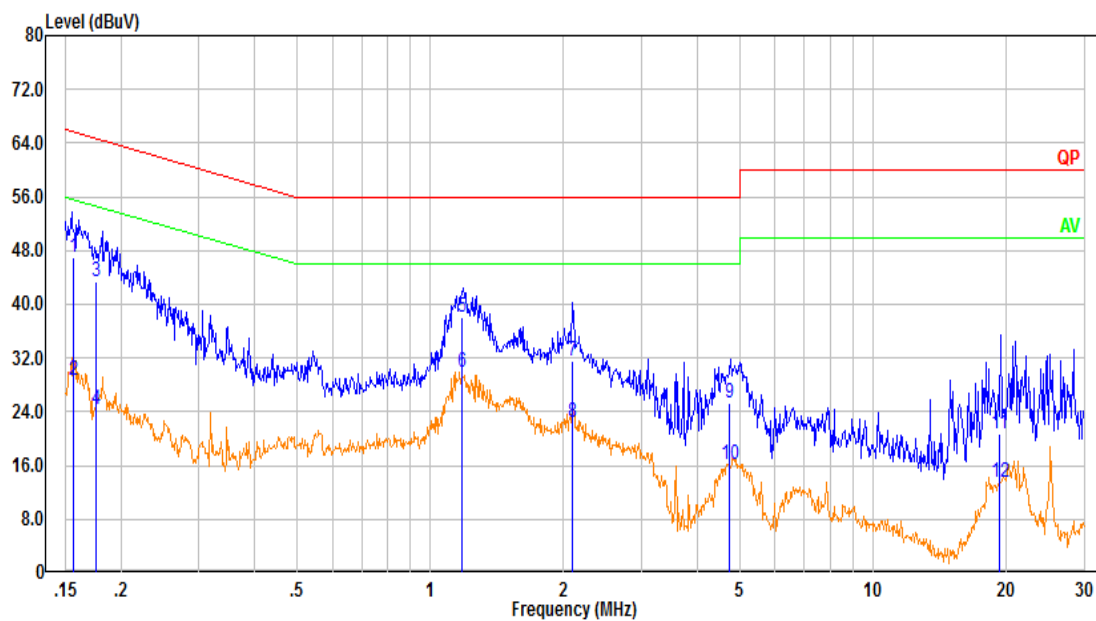
Neutral:

No.	Frequency (MHz)	Reading (dB μ V)	Factor (dB)	Result (dB μ V)	Limit (dB μ V)	Margin (dB)	Detector
1	0.156	37.49	9.61	47.10	65.69	18.59	QP
2	0.156	18.99	9.61	28.60	55.69	27.09	Average
3	0.176	33.66	9.61	43.27	64.67	21.40	QP
4	0.176	14.69	9.61	24.30	54.67	30.37	Average
5	1.178	28.57	9.62	38.19	56.00	17.81	QP
6	1.178	20.29	9.62	29.91	46.00	16.09	Average
7	2.090	22.01	9.63	31.64	56.00	24.36	QP
8	2.090	12.77	9.63	22.40	46.00	23.60	Average
9	4.733	15.68	9.66	25.34	56.00	30.66	QP
10	4.733	6.37	9.66	16.03	46.00	29.97	Average
11	19.255	11.11	9.69	20.80	60.00	39.20	QP
12	19.255	3.77	9.69	13.46	50.00	36.54	Average

4.2 Radiation Spurious Emissions

Serial Number:	CR22070005-RF-S1	Test Date:	2022-07-26~2022-07-27
Test Site:	966-1,966-2	Test Mode:	Transmitting
Tester:	Carl Liang, Nick Tang	Test Result:	Pass

Environmental Conditions:

Temperature: (°C)	24.4~29.4	Relative Humidity: (%)	45~63	ATM Pressure: (kPa)	100.2~100.7
----------------------	-----------	------------------------------	-------	------------------------	-------------

Test Equipment List and Details:

Manufacturer	Description	Model	Serial Number	Calibration Date	Calibration Due Date
Sunol Sciences	Antenna	JB6	A082520-5	2020-10-19	2023-10-18
R&S	EMI Test Receiver	ESR3	102724	2022-07-15	2023-07-14
TIMES MICROWAVE	Coaxial Cable	LMR-600-UltraFlex	C-0470-02	2022-07-17	2023-07-16
TIMES MICROWAVE	Coaxial Cable	LMR-600-UltraFlex	C-0780-01	2022-07-17	2023-07-16
Sonoma	Amplifier	310N	186165	2022-07-17	2023-07-16
Audix	Test Software	E3	201021 (V9)	N/A	N/A
ETS-Lindgren	Horn Antenna	3115	9912-5985	2020-10-13	2023-10-12
R&S	Spectrum Analyzer	FSV40	101591	2022-07-15	2023-07-14
MICRO-COAX	Coaxial Cable	UFA210A-1-1200-70U300	217423-008	2021-08-08	2022-08-07
MICRO-COAX	Coaxial Cable	UFA210A-1-2362-300300	235780-001	2021-08-08	2022-08-07
Mini	Pre-amplifier	ZVA-183-S+	5969001149	2021-11-10	2022-11-09
PASTERNAK	Horn Antenna	PE9852/2F-20	112002	2021-02-05	2024-02-04
AH	Preamplifier	PAM-1840VH	190	2021-11-19	2022-11-18
MICRO-COAX	Coaxial Cable	UFB142A-1-2362-200200	235772-001	2021-08-08	2022-08-07
E-Microwave	Band Rejection Filter	5150-5850MHz	OE01902423	2021-08-08	2022-08-07
Mini Circuits	High Pass Filter	VHF-6010+	31119	2021-08-08	2022-08-07
PASTERNAK	Horn Antenna	PE9850/2F-20	072001	2021-02-05	2024-02-04

* Statement of Traceability: China Certification ICT Co., Ltd (Dongguan) attests that all calibrations have been performed, traceable to National Primary Standards and International System of Units (SI).

Test Data:

Please refer to the below table and plots.

Note: The device can be mounted in multiple orientations, test was performed with X,Y, Z Axis according to C63.10 figure 8, the worst orientation was photographed and it's data was recorded.

1) 30MHz-1GHz(802.11a Chain 0 5785MHz was the worst)

Horizontal:

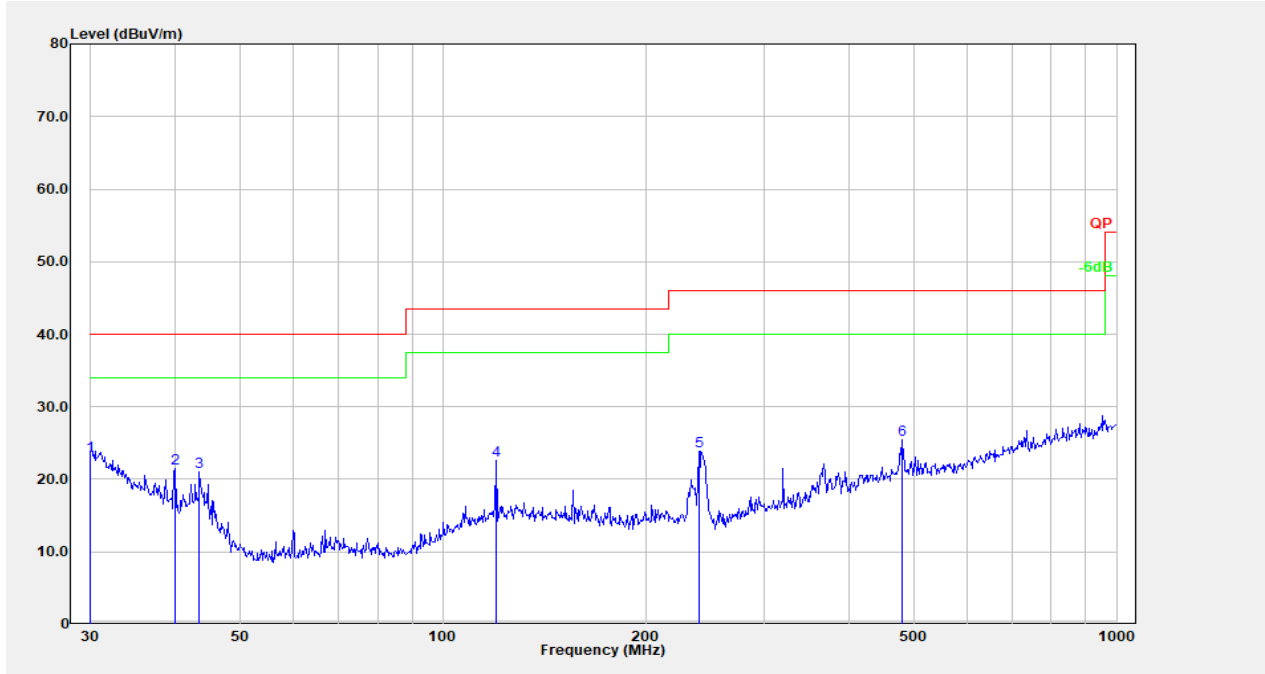

No.	Frequency (MHz)	Reading (dB μ V)	Factor (dB/m)	Result (dB μ V/m)	Limit (dB μ V/m)	Margin (dB)	Detector
1	30.000	27.10	-3.79	23.31	40.00	16.69	Peak
2	39.994	32.95	-11.52	21.44	40.00	18.56	Peak
3	43.506	34.56	-13.61	20.95	40.00	19.05	Peak
4	119.856	34.35	-11.75	22.60	43.50	20.90	Peak
5	239.987	36.98	-13.17	23.81	46.00	22.19	Peak
6	480.528	31.99	-6.49	25.51	46.00	20.49	Peak

Vertical:

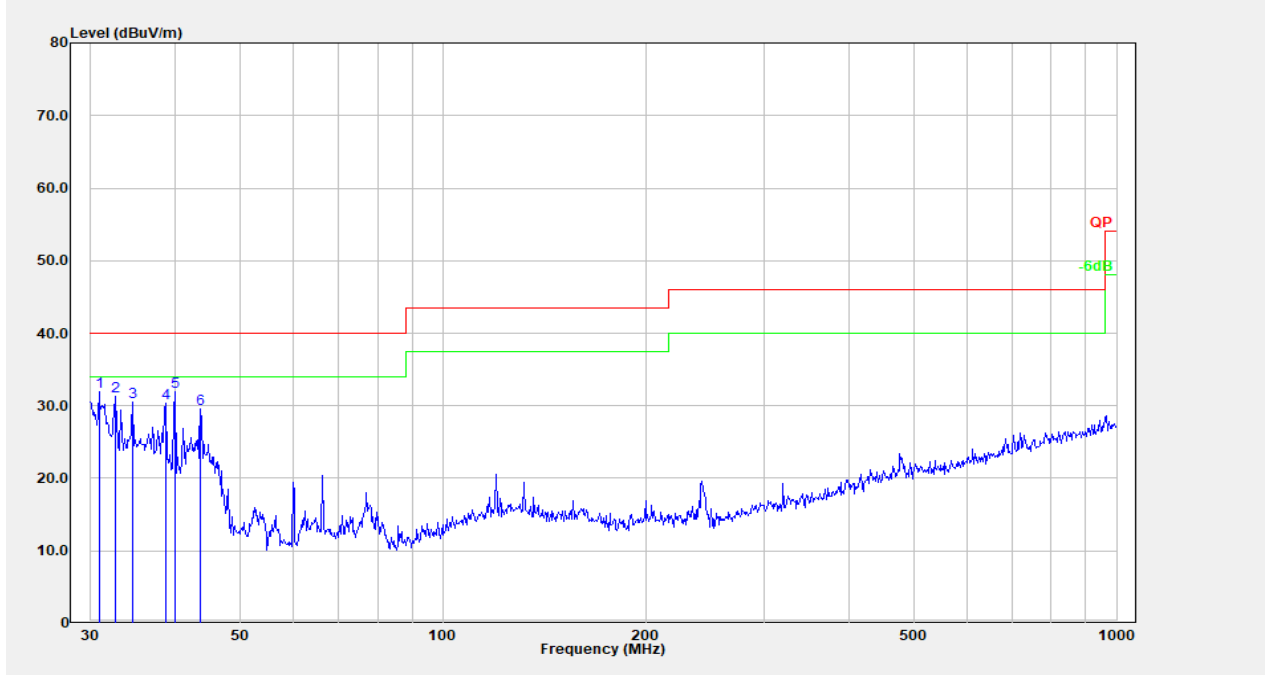

No.	Frequency (MHz)	Reading (dB μ V)	Factor (dB/m)	Result (dB μ V/m)	Limit (dB μ V/m)	Margin (dB)	Detector
1	30.853	36.36	-4.45	31.91	40.00	8.09	Peak
2	32.634	37.08	-5.83	31.26	40.00	8.74	Peak
3	34.639	37.84	-7.38	30.46	40.00	9.54	Peak
4	38.752	40.85	-10.52	30.33	40.00	9.67	Peak
5	39.994	43.40	-11.52	31.88	40.00	8.12	Peak
6	43.659	43.24	-13.70	29.54	40.00	10.46	Peak

2) 1GHz-40GHz:**5150-5250MHz****802.11a, Chain 0:**

Frequency (MHz)	Receiver		Polar (H/V)	Factor (dB/m)	Result (dB μ V/m)	Limit (dB μ V/m)	Margin (dB)
	Reading (dB μ V)	Detector					
Low Channel: 5180MHz							
5180.00	66.96	PK	H	38.68	99.62	N/A	N/A
5180.00	56.02	AV	H	38.68	88.68	N/A	N/A
5180.00	70.38	PK	V	38.68	103.04	N/A	N/A
5180.00	60.54	AV	V	38.68	93.20	N/A	N/A
5150.00	30.43	PK	V	38.64	63.05	74.00	10.95
5150.00	17.23	AV	V	38.64	49.85	54.00	4.15
10360.00	33.10	PK	V	19.18	46.26	68.20	21.94
15540.00	34.37	PK	V	22.44	50.79	74.00	23.21
15540.00	22.14	AV	V	22.44	38.56	54.00	15.44
Middle Channel: 5200 MHz							
5200.00	67.79	PK	H	38.70	100.47	N/A	N/A
5200.00	55.40	AV	H	38.70	88.08	N/A	N/A
5200.00	71.45	PK	V	38.70	104.13	N/A	N/A
5200.00	59.55	AV	V	38.70	92.23	N/A	N/A
10400.00	33.32	PK	V	19.16	46.46	68.20	21.74
15600.00	38.19	PK	V	22.41	54.58	74.00	19.42
15600.00	25.67	AV	V	22.41	42.06	54.00	11.94
High Channel: 5240 MHz							
5240.00	69.40	PK	H	38.85	102.23	N/A	N/A
5240.00	57.58	AV	H	38.85	90.41	N/A	N/A
5240.00	72.71	PK	V	38.85	105.54	N/A	N/A
5240.00	62.28	AV	V	38.85	95.11	N/A	N/A
5350.00	29.37	PK	V	39.03	62.38	74.00	11.62
5350.00	16.67	AV	V	39.03	49.68	54.00	4.32
10480.00	34.05	PK	V	18.86	46.89	68.20	21.31
15720.00	37.41	PK	V	22.28	53.67	74.00	20.33
15720.00	24.31	AV	V	22.28	40.57	54.00	13.43

802.11a, Chain 1:

Frequency (MHz)	Receiver		Polar (H/V)	Factor (dB/m)	Result (dB μ V/m)	Limit (dB μ V/m)	Margin (dB)
	Reading (dB μ V)	Detector					
Low Channel: 5180MHz							
5180.00	67.30	PK	H	38.68	99.96	N/A	N/A
5180.00	56.41	AV	H	38.68	89.07	N/A	N/A
5180.00	74.18	PK	V	38.68	106.84	N/A	N/A
5180.00	63.85	AV	V	38.68	96.51	N/A	N/A
5150.00	31.04	PK	V	38.64	63.66	74.00	10.34
5150.00	18.01	AV	V	38.64	50.63	54.00	3.37
10360.00	33.78	PK	V	19.18	46.94	68.20	21.26
15540.00	34.22	PK	V	22.44	50.64	74.00	23.36
15540.00	22.03	AV	V	22.44	38.45	54.00	15.55
Middle Channel: 5200 MHz							
5200.00	67.25	PK	H	38.70	99.93	N/A	N/A
5200.00	56.46	AV	H	38.70	89.14	N/A	N/A
5200.00	74.12	PK	V	38.70	106.80	N/A	N/A
5200.00	63.89	AV	V	38.70	96.57	N/A	N/A
10400.00	33.81	PK	V	19.16	46.95	68.20	21.25
15600.00	38.07	PK	V	22.41	54.46	74.00	19.54
15600.00	25.19	AV	V	22.41	41.58	54.00	12.42
High Channel: 5240 MHz							
5240.00	66.18	PK	H	38.85	99.01	N/A	N/A
5240.00	56.34	AV	H	38.85	89.17	N/A	N/A
5240.00	73.58	PK	V	38.85	106.41	N/A	N/A
5240.00	63.71	AV	V	38.85	96.54	N/A	N/A
5350.00	30.00	PK	V	39.03	63.01	74.00	10.99
5350.00	16.82	AV	V	39.03	49.83	54.00	4.17
10480.00	33.92	PK	V	18.86	46.76	68.20	21.44
15720.00	40.01	PK	V	22.28	56.27	74.00	17.73
15720.00	25.37	AV	V	22.28	41.63	54.00	12.37

802.11n ht20(2Tx mode was the worst):

Frequency (MHz)	Receiver		Polar (H/V)	Factor (dB/m)	Result (dB μ V/m)	Limit (dB μ V/m)	Margin (dB)
	Reading (dB μ V)	Detector					
Low Channel: 5180MHz							
5180.00	69.19	PK	H	38.68	101.85	N/A	N/A
5180.00	56.71	AV	H	38.68	89.37	N/A	N/A
5180.00	76.41	PK	V	38.68	109.07	N/A	N/A
5180.00	64.84	AV	V	38.68	97.50	N/A	N/A
5150.00	32.44	PK	V	38.64	65.06	74.00	8.94
5150.00	19.02	AV	V	38.64	51.64	54.00	2.36
10360.00	34.35	PK	V	19.18	47.51	68.20	20.69
15540.00	35.50	PK	V	22.44	51.92	74.00	22.08
15540.00	22.61	AV	V	22.44	39.03	54.00	14.97
Middle Channel: 5200 MHz							
5200.00	69.38	PK	H	38.70	102.06	N/A	N/A
5200.00	56.83	AV	H	38.70	89.51	N/A	N/A
5200.00	76.66	PK	V	38.70	109.34	N/A	N/A
5200.00	65.29	AV	V	38.70	97.97	N/A	N/A
10400.00	34.28	PK	V	19.16	47.42	68.20	20.78
15600.00	36.52	PK	V	22.41	52.91	74.00	21.09
15600.00	23.98	AV	V	22.41	40.37	54.00	13.63
High Channel: 5240 MHz							
5240.00	69.79	PK	H	38.85	102.62	N/A	N/A
5240.00	56.80	AV	H	38.85	89.63	N/A	N/A
5240.00	77.00	PK	V	38.85	109.83	N/A	N/A
5240.00	65.23	AV	V	38.85	98.06	N/A	N/A
5350.00	30.55	PK	V	39.03	63.56	74.00	10.44
5350.00	17.15	AV	V	39.03	50.16	54.00	3.84
10480.00	38.20	PK	V	18.86	51.04	68.20	17.16
15720.00	38.39	PK	V	22.28	54.65	74.00	19.35
15720.00	25.96	AV	V	22.28	42.22	54.00	11.78

802.11n ht40(2Tx mode was the worst):

Frequency (MHz)	Receiver		Polar (H/V)	Factor (dB/m)	Result (dB μ V/m)	Limit (dB μ V/m)	Margin (dB)
	Reading (dB μ V)	Detector					
Low Channel: 5190 MHz							
5190.00	67.59	PK	H	38.69	100.26	N/A	N/A
5190.00	56.10	AV	H	38.69	88.77	N/A	N/A
5190.00	74.43	PK	V	38.69	107.10	N/A	N/A
5190.00	62.34	AV	V	38.69	95.01	N/A	N/A
5150.00	32.20	PK	V	38.64	64.82	74.00	9.18
5150.00	18.49	AV	V	38.64	51.11	54.00	2.89
10380.00	33.73	PK	V	19.17	46.88	68.20	21.32
15570.00	34.84	PK	V	22.43	51.25	74.00	22.75
15570.00	22.67	AV	V	22.43	39.08	54.00	14.92
High Channel: 5230 MHz							
5230.00	67.91	PK	H	38.81	100.70	N/A	N/A
5230.00	56.73	AV	H	38.81	89.52	N/A	N/A
5230.00	74.64	PK	V	38.81	107.43	N/A	N/A
5230.00	62.94	AV	V	38.81	95.73	N/A	N/A
5350.00	31.07	PK	V	39.03	64.08	74.00	9.92
5350.00	16.87	AV	V	39.03	49.88	54.00	4.12
10460.00	33.84	PK	V	18.94	46.76	68.20	21.44
15690.00	37.78	PK	V	22.29	54.05	74.00	19.95
15690.00	24.68	AV	V	22.29	40.95	54.00	13.05

802.11ac vht80(2Tx mode was the worst):

Frequency (MHz)	Receiver		Polar (H/V)	Factor (dB/m)	Result (dB μ V/m)	Limit (dB μ V/m)	Margin (dB)
	Reading (dB μ V)	Detector					
5210.00	58.54	PK	H	38.74	91.26	N/A	N/A
5210.00	47.96	AV	H	38.74	80.68	N/A	N/A
5210.00	65.90	PK	V	38.74	98.62	N/A	N/A
5210.00	56.93	AV	V	38.74	89.65	N/A	N/A
5150.00	29.74	PK	V	38.64	62.36	74.00	11.64
5150.00	16.88	AV	V	38.64	49.50	54.00	4.50
5350.00	29.55	PK	V	39.03	62.56	74.00	11.44
5350.00	16.55	AV	V	39.03	49.56	54.00	4.44
10420.00	33.78	PK	V	19.09	46.85	68.20	21.35
15630.00	37.28	PK	V	22.37	53.63	74.00	20.37
15630.00	24.94	AV	V	22.37	41.29	54.00	12.71

Note:

Result = Reading + Factor- Distance extrapolation Factor

Distance extrapolation Factor = $20 \log(\text{specific distance [3m]}/\text{test distance [1.5m]})$ dB = 6.02 dB

5725-5850MHz:**802.11a, Chain 0:**

Frequency (MHz)	Receiver		Polar (H/V)	Factor (dB/m)	Result (dB μ V/m)	Limit (dB μ V/m)	Margin (dB)
	Reading (dB μ V)	Detector					
Low Channel: 5745MHz							
5745.00	67.12	PK	H	39.46	100.56	N/A	N/A
5745.00	56.82	AV	H	39.46	90.26	N/A	N/A
5745.00	70.96	PK	V	39.46	104.40	N/A	N/A
5745.00	60.77	AV	V	39.46	94.21	N/A	N/A
5725.00	38.59	PK	V	39.48	72.05	122.20	50.15
5720.00	31.68	PK	V	39.49	65.15	110.80	45.65
5700.00	31.17	PK	V	39.51	64.66	105.20	40.54
5650.00	30.68	PK	V	39.49	64.15	68.20	4.05
11490.00	47.87	PK	V	20.67	62.52	74.00	11.48
11490.00	33.65	AV	V	20.67	48.30	54.00	5.70
17235.00	33.49	PK	V	26.76	54.23	68.20	13.97
Middle Channel: 5785 MHz							
5785.00	66.27	PK	H	39.44	99.69	N/A	N/A
5785.00	55.11	AV	H	39.44	88.53	N/A	N/A
5785.00	69.42	PK	V	39.44	102.84	N/A	N/A
5785.00	59.10	AV	V	39.44	92.52	N/A	N/A
11570.00	47.28	PK	V	20.83	62.09	74.00	11.91
11570.00	32.76	AV	V	20.83	47.57	54.00	6.43
17355.00	33.42	PK	V	27.74	55.14	68.20	13.06
High Channel: 5825 MHz							
5825.00	67.89	PK	H	39.46	101.33	N/A	N/A
5825.00	57.08	AV	H	39.46	90.52	N/A	N/A
5825.00	71.22	PK	V	39.46	104.66	N/A	N/A
5825.00	60.20	AV	V	39.46	93.64	N/A	N/A
5850.00	32.52	PK	V	39.49	65.99	122.20	56.21
5855.00	32.83	PK	V	39.51	66.32	110.80	44.48
5875.00	31.77	PK	V	39.60	65.35	105.20	39.85
5925.00	33.17	PK	V	39.68	66.83	68.20	1.37
11650.00	47.64	PK	V	21.07	62.69	74.00	11.31
11650.00	33.75	AV	V	21.07	48.80	54.00	5.20
17475.00	33.86	PK	V	28.61	56.45	68.20	11.75

802.11a,Chain 1:

Frequency (MHz)	Receiver		Polar (H/V)	Factor (dB/m)	Result (dB μ V/m)	Limit (dB μ V/m)	Margin (dB)
	Reading (dB μ V)	Detector					
Low Channel: 5745MHz							
5745.00	65.76	PK	H	39.46	99.20	N/A	N/A
5745.00	60.63	AV	H	39.46	94.07	N/A	N/A
5745.00	71.82	PK	V	39.46	105.26	N/A	N/A
5745.00	66.80	AV	V	39.46	100.24	N/A	N/A
5725.00	39.45	PK	V	39.48	72.91	122.20	49.29
5720.00	32.01	PK	V	39.49	65.48	110.80	45.32
5700.00	31.48	PK	V	39.51	64.97	105.20	40.23
5650.00	30.23	PK	V	39.49	63.70	68.20	4.50
11490.00	47.13	PK	V	20.67	61.78	74.00	12.22
11490.00	33.06	AV	V	20.67	47.71	54.00	6.29
17235.00	33.35	PK	V	26.76	54.09	68.20	14.11
Middle Channel: 5785 MHz							
5785.00	65.49	PK	H	39.44	98.91	N/A	N/A
5785.00	60.55	AV	H	39.44	93.97	N/A	N/A
5785.00	71.43	PK	V	39.44	104.85	N/A	N/A
5785.00	66.63	AV	V	39.44	100.05	N/A	N/A
11570.00	45.40	PK	V	20.83	60.21	74.00	13.79
11570.00	32.04	AV	V	20.83	46.85	54.00	7.15
17355.00	33.20	PK	V	27.74	54.92	68.20	13.28
High Channel: 5825 MHz							
5825.00	65.13	PK	H	39.46	98.57	N/A	N/A
5825.00	60.18	AV	H	39.46	93.62	N/A	N/A
5825.00	71.16	PK	V	39.46	104.60	N/A	N/A
5825.00	66.29	AV	V	39.46	99.73	N/A	N/A
5850.00	32.16	PK	V	39.49	65.63	122.20	56.57
5855.00	32.43	PK	V	39.51	65.92	110.80	44.88
5875.00	32.49	PK	V	39.60	66.07	105.20	39.13
5925.00	31.68	PK	V	39.68	65.34	68.20	2.86
11650.00	48.19	PK	V	21.07	63.24	74.00	10.76
11650.00	34.06	AV	V	21.07	49.11	54.00	4.89
17475.00	33.70	PK	V	28.61	56.29	68.20	11.91

802.11n ht20(2Tx mode was the worst):

Frequency (MHz)	Receiver		Polar (H/V)	Factor (dB/m)	Result (dBμV/m)	Limit (dBμV/m)	Margin (dB)
	Reading (dBμV)	Detector					
Low Channel: 5745MHz							
5745.00	70.33	PK	H	39.46	103.77	N/A	N/A
5745.00	58.82	AV	H	39.46	92.26	N/A	N/A
5745.00	74.01	PK	V	39.46	107.45	N/A	N/A
5745.00	62.30	AV	V	39.46	95.74	N/A	N/A
5725.00	41.00	PK	V	39.48	74.46	122.20	47.74
5720.00	32.59	PK	V	39.49	66.06	110.80	44.74
5700.00	31.43	PK	V	39.51	64.92	105.20	40.28
5650.00	30.77	PK	V	39.49	64.24	68.20	3.96
11490.00	49.64	PK	V	20.67	64.29	74.00	9.71
11490.00	35.20	AV	V	20.67	49.85	54.00	4.15
17235.00	33.27	PK	V	26.76	54.01	68.20	14.19
Middle Channel: 5785 MHz							
5785.00	71.14	PK	H	39.44	104.56	N/A	N/A
5785.00	59.03	AV	H	39.44	92.45	N/A	N/A
5785.00	75.21	PK	V	39.44	108.63	N/A	N/A
5785.00	63.61	AV	V	39.44	97.03	N/A	N/A
11570.00	47.56	PK	V	20.83	62.37	74.00	11.63
11570.00	34.09	AV	V	20.83	48.90	54.00	5.10
17355.00	33.17	PK	V	27.74	54.89	68.20	13.31
High Channel: 5825 MHz							
5825.00	70.88	PK	H	39.46	104.32	N/A	N/A
5825.00	58.97	AV	H	39.46	92.41	N/A	N/A
5825.00	74.85	PK	V	39.46	108.29	N/A	N/A
5825.00	62.66	AV	V	39.46	96.10	N/A	N/A
5850.00	32.37	PK	V	39.49	65.84	122.20	56.36
5855.00	32.25	PK	V	39.51	65.74	110.80	45.06
5875.00	32.47	PK	V	39.60	66.05	105.20	39.15
5925.00	32.54	PK	V	39.68	66.20	68.20	2.00
11650.00	49.46	PK	V	21.07	64.51	74.00	9.49
11650.00	35.62	AV	V	21.07	50.67	54.00	3.33
17475.00	33.72	PK	V	28.61	56.31	68.20	11.89

802.11n ht40(2Tx mode was the worst):

Frequency (MHz)	Receiver		Polar (H/V)	Factor (dB/m)	Result (dB μ V/m)	Limit (dB μ V/m)	Margin (dB)
	Reading (dB μ V)	Detector					
Low Channel: 5755 MHz							
5755.00	67.32	PK	H	39.45	100.75	N/A	N/A
5755.00	57.52	AV	H	39.45	90.95	N/A	N/A
5755.00	72.34	PK	V	39.45	105.77	N/A	N/A
5755.00	60.83	AV	V	39.45	94.26	N/A	N/A
5725.00	32.12	PK	V	39.48	65.58	122.20	56.62
5720.00	32.33	PK	V	39.49	65.80	110.80	45.00
5700.00	31.76	PK	V	39.51	65.25	105.20	39.95
5650.00	30.53	PK	V	39.49	64.00	68.20	4.20
11510.00	47.09	PK	V	20.67	61.74	74.00	12.26
11510.00	33.86	AV	V	20.67	48.51	54.00	5.49
17265.00	33.12	PK	V	26.94	54.04	68.20	14.16
High Channel: 5795 MHz							
5795.00	67.15	PK	H	39.43	100.56	N/A	N/A
5795.00	57.26	AV	H	39.43	90.67	N/A	N/A
5795.00	72.23	PK	V	39.43	105.64	N/A	N/A
5795.00	60.50	AV	V	39.43	93.91	N/A	N/A
5850.00	32.04	PK	V	39.49	65.51	122.20	56.69
5855.00	31.95	PK	V	39.51	65.44	110.80	45.36
5875.00	31.87	PK	V	39.60	65.45	105.20	39.75
5925.00	31.74	PK	V	39.68	65.40	68.20	2.80
11590.00	45.31	PK	V	20.88	60.17	74.00	13.83
11590.00	33.45	AV	V	20.88	48.31	54.00	5.69
17385.00	33.10	PK	V	28.07	55.15	68.20	13.05

802.11ac vht80(2Tx mode was the worst):

Frequency (MHz)	Receiver		Polar (H/V)	Factor (dB/m)	Result (dB μ V/m)	Limit (dB μ V/m)	Margin (dB)
	Reading (dB μ V)	Detector					
5775.00	58.12	PK	H	39.44	91.54	N/A	N/A
5775.00	48.91	AV	H	39.44	82.33	N/A	N/A
5775.00	61.06	PK	V	39.44	94.48	N/A	N/A
5775.00	52.50	AV	V	39.44	85.92	N/A	N/A
5725.00	31.27	PK	V	39.48	64.73	122.20	57.47
5720.00	31.38	PK	V	39.49	64.85	110.80	45.95
5700.00	30.12	PK	V	39.51	63.61	105.20	41.59
5650.00	31.43	PK	V	39.49	64.90	68.20	3.30
5850.00	31.66	PK	V	39.49	65.13	122.20	57.07
5855.00	31.47	PK	V	39.51	64.96	110.80	45.84
5875.00	31.39	PK	V	39.60	64.97	105.20	40.23
5925.00	32.23	PK	V	39.68	65.89	68.20	2.31
11550.00	34.22	PK	V	20.78	48.98	74.00	25.02
11550.00	22.05	AV	V	20.78	36.81	54.00	17.19
17325.00	33.59	PK	V	27.41	54.98	68.20	13.22

Note:

Result = Reading + Factor- Distance extrapolation Factor

Distance extrapolation Factor = $20 \log(\text{specific distance [3m]}/\text{test distance [1.5m]})$ dB = 6.02 dB

Worst Test plots(802.11n ht20 2TX 5825 MHz was the worst)

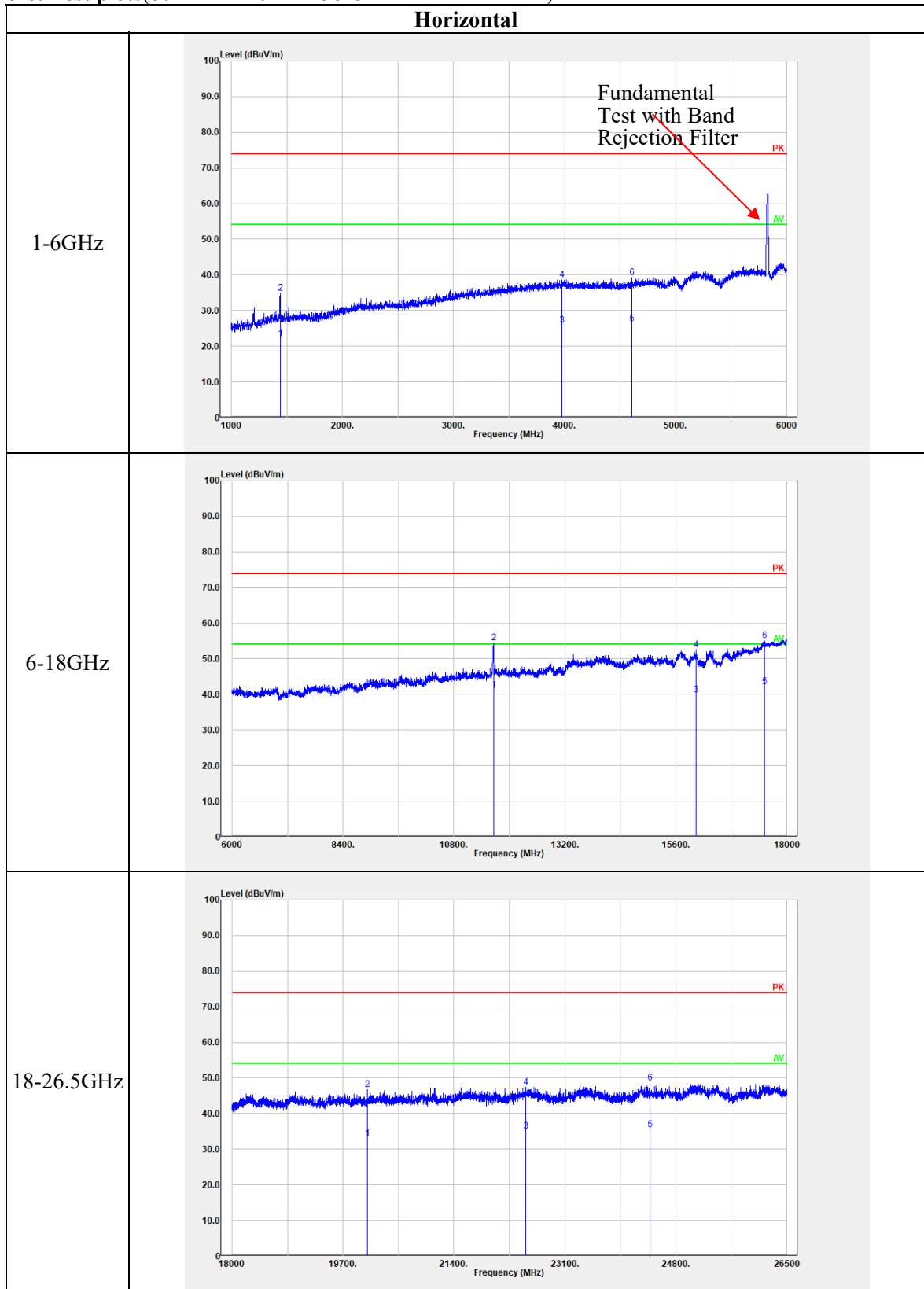

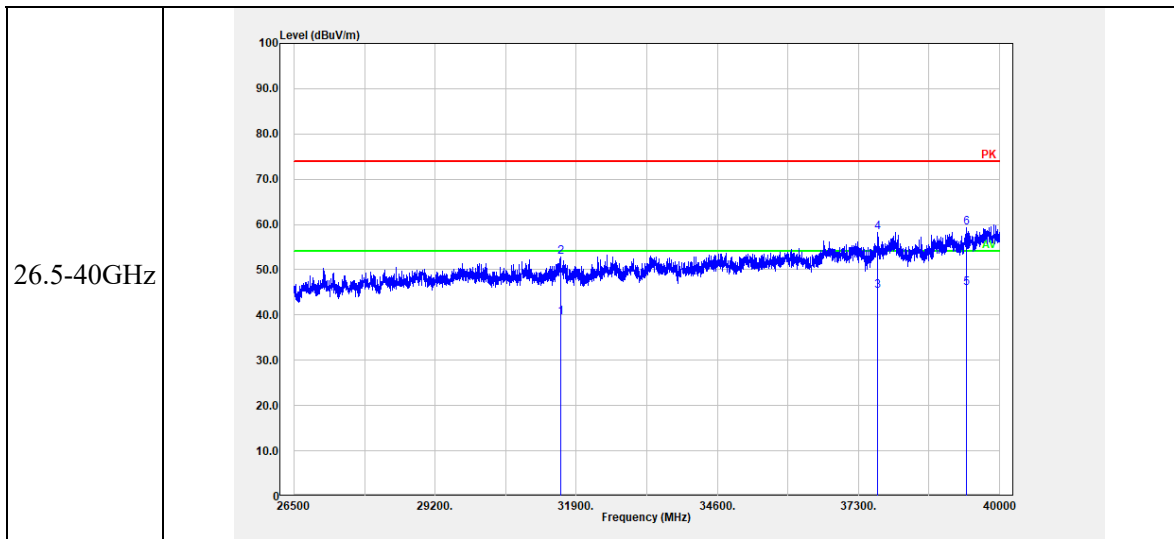

Vertical

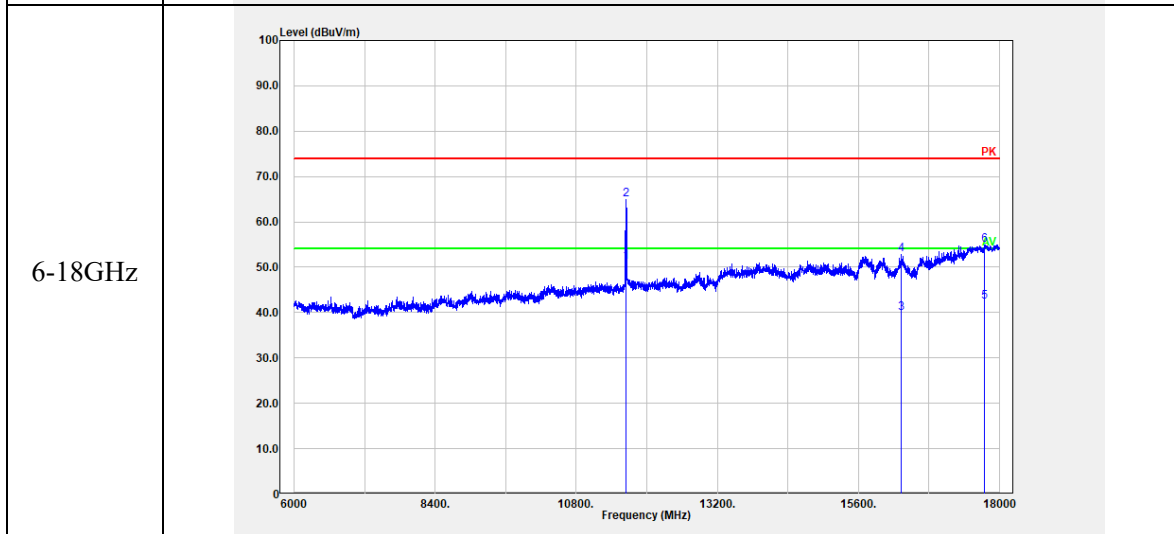
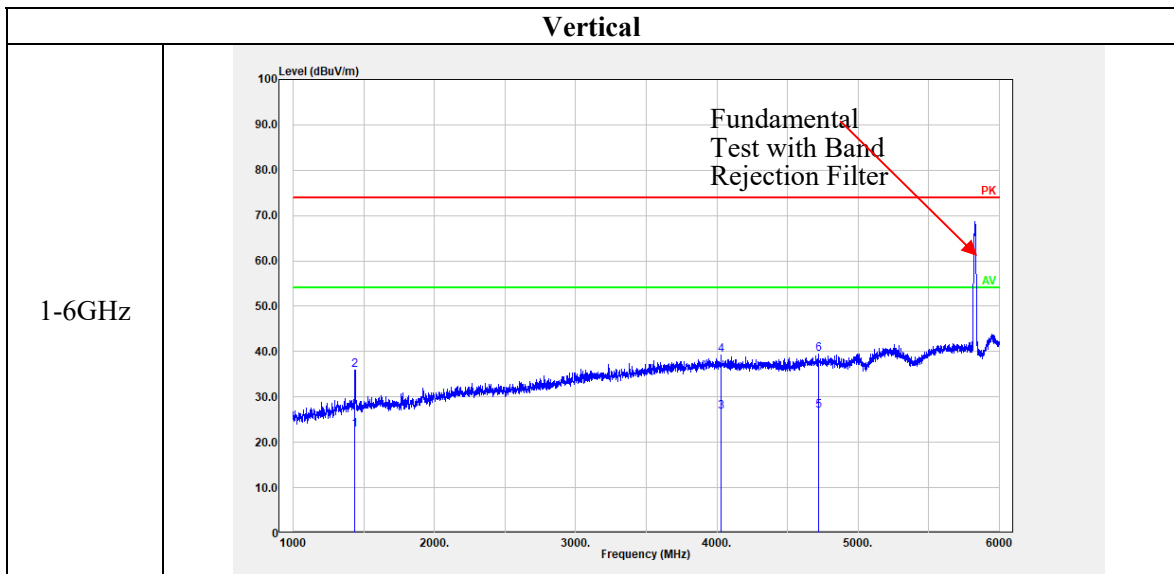

18-26.5GHz

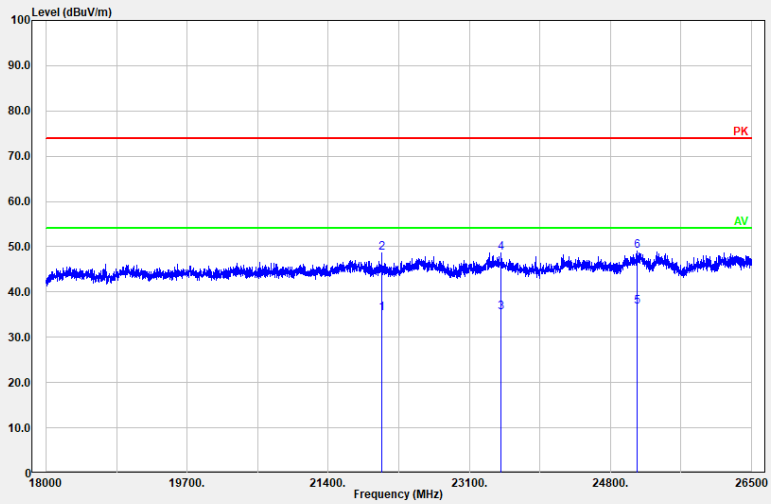

26.5-40GHz

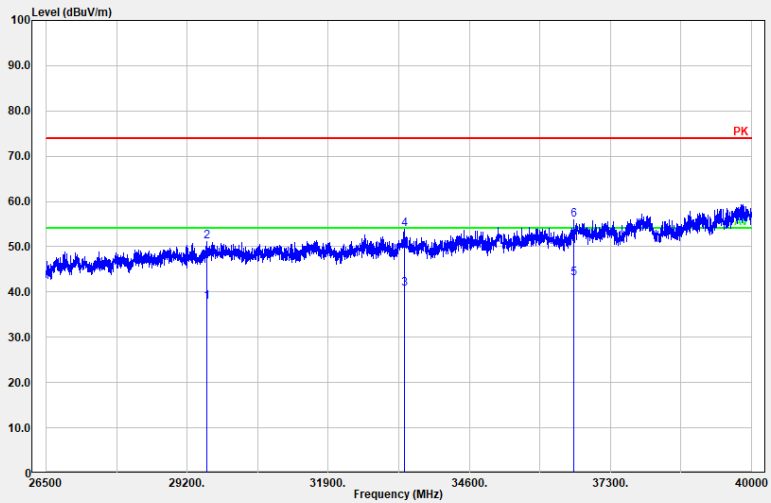

4.3 Emission Bandwidth:

Serial Number:	CR22070005-RF-S1	Test Date:	2022-8-11
Test Site:	RF	Test Mode:	Transmitting
Tester:	Julie Tan	Test Result:	Pass

Environmental Conditions:

Temperature: (°C)	27.6	Relative Humidity: (%)	63	ATM Pressure: (kPa)	100.2
----------------------	------	------------------------------	----	------------------------	-------

Test Equipment List and Details:

Manufacturer	Description	Model	Serial Number	Calibration Date	Calibration Due Date
R&S	Spectrum Analyzer	FSV40	101943	2021-10-10	2022-10-09
zhuoxiang	Coaxial Cable	SMA-178	211001	Each time	N/A
Mini-Circuits	DC Block	BLK-18-S+	1554403	Each time	N/A

* Statement of Traceability: China Certification ICT Co., Ltd (Dongguan) attests that all calibrations have been performed, traceable to National Primary Standards and International System of Units (SI).

Test Data:

5150-5250 MHz:

Test Modes	Test Frequency (MHz)	26 dB Bandwidth (MHz)	99% Occupied Bandwidth (MHz)
802.11a	5180	28.08	17.725
	5200	29.68	17.804
	5240	20.24	16.766
802.11n ht20	5180	29.44	18.683
	5200	28.56	18.762
	5240	20.64	17.804
802.11n ht40	5190	40.16	36.248
	5230	40	36.248
802.11ac vht80	5210	80.96	76.327
Note: Test only was performed at Chain 0. The 99% Occupied Bandwidths are not fall into the range of 5250-5350MHz			

5725-5850 MHz:

Test Modes	Test Frequency (MHz)	6 dB Bandwidth (MHz)	99% Occupied Bandwidth (MHz)
802.11a	5745	15.274	17.804
	5785	15.368	18.044
	5825	15.332	17.964
802.11n ht20	5745	17.271	18.762
	5785	17.45	18.762
	5825	17.552	18.762
802.11n ht40	5755	34.97	36.407
	5795	35.25	36.248
802.11ac vht80	5775	76.83	76.327
Note: 6dB Emission Bandwidth Limit: ≥ 0.5 MHz Test only was performed at Chain 0. The 99% Occupied Bandwidths are not fall into the range of 5470-5725MHz			

5150-5250MHz:

26dB Emission Bandwidth

802.11a
Lowest Channel

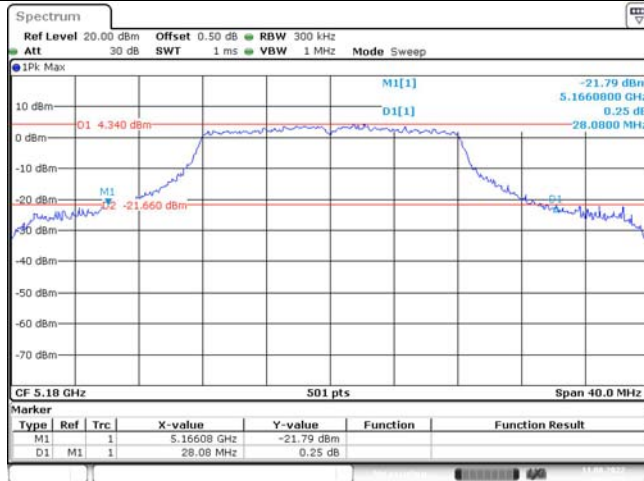

802.11a
Middle Channel

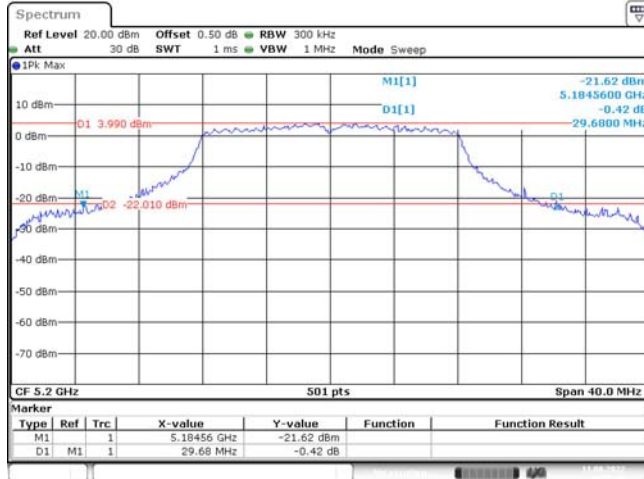

802.11a
Highest Channel

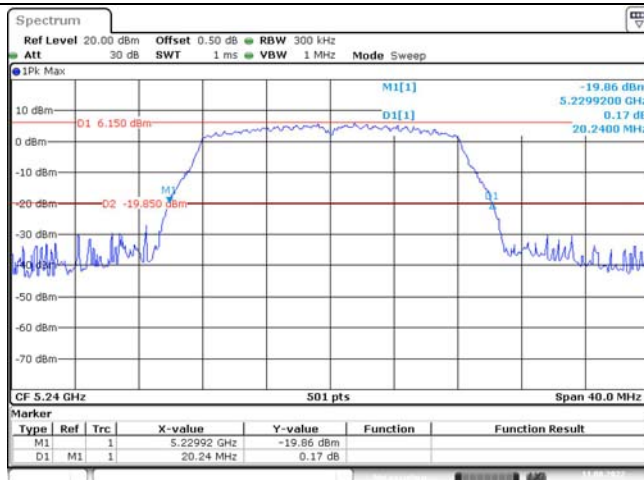

26dB Emission Bandwidth

802.11n ht20
Lowest Channel

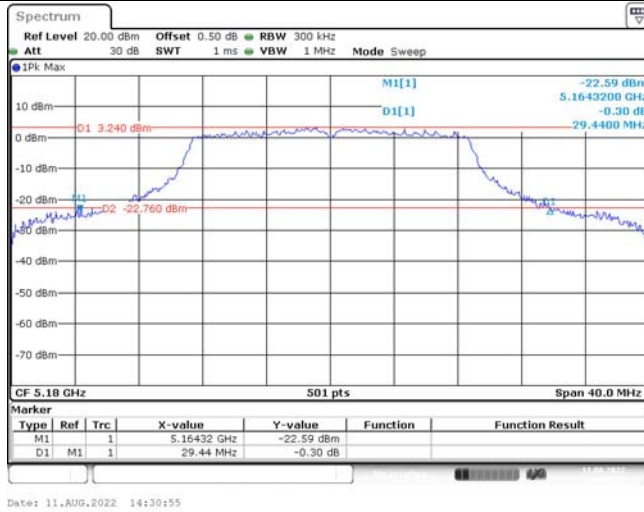

802.11n ht20
Middle Channel

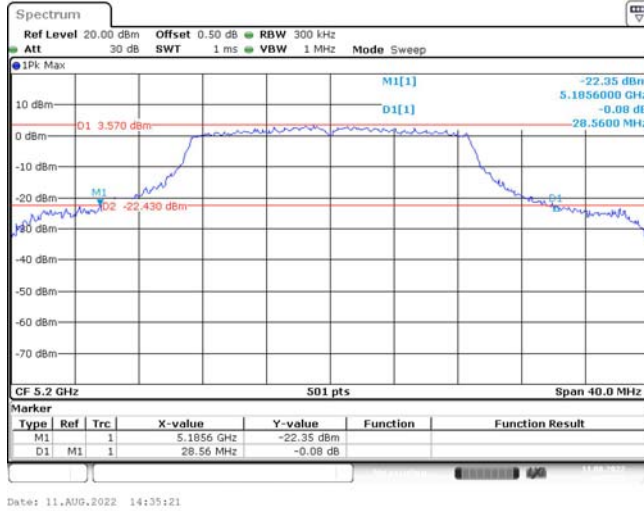

802.11n ht20
Highest Channel

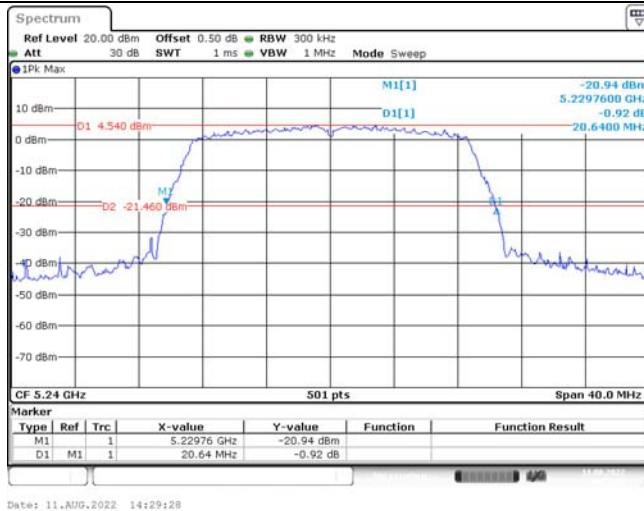

26dB Emission Bandwidth

802.11n ht40
Lowest Channel

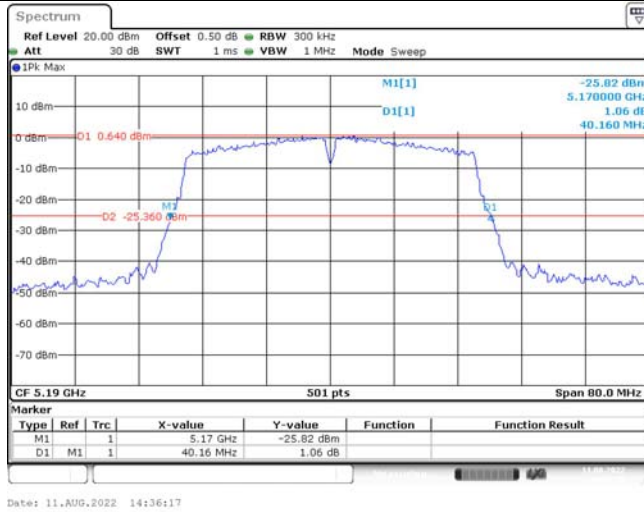

802.11n ht40
Highest Channel

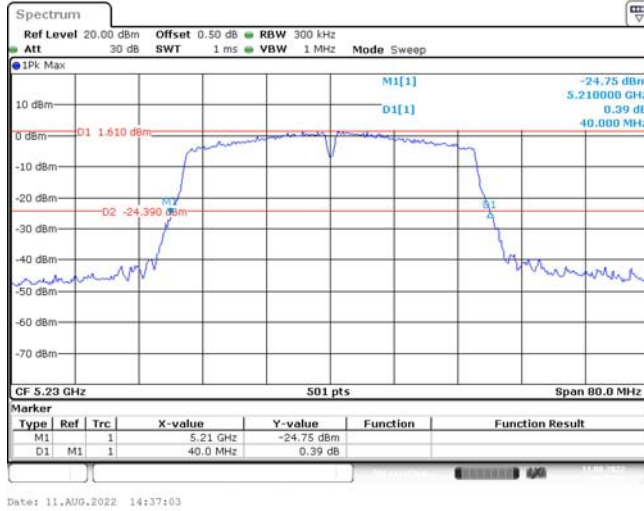

802.11ac vht80
Middle Channel

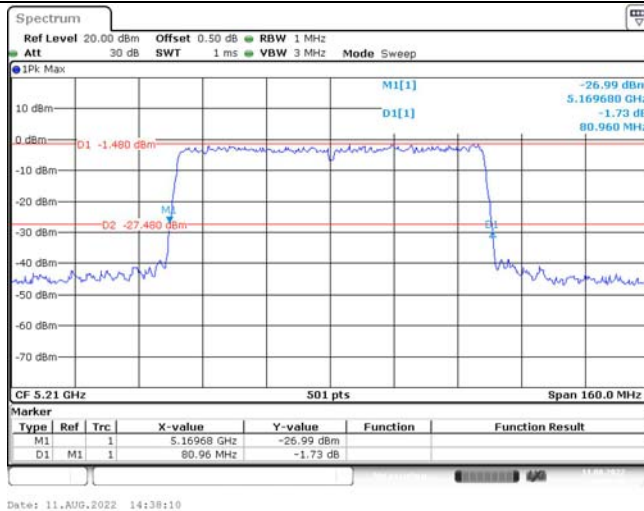

99% Emission Bandwidth

802.11a
Lowest Channel

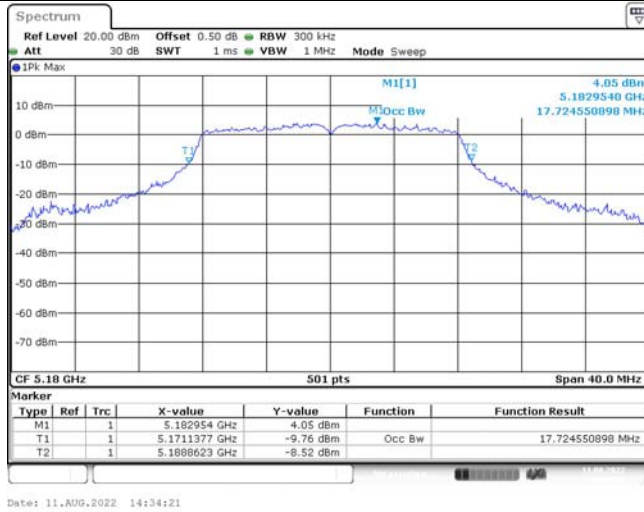

802.11a
Middle Channel



802.11a
Highest Channel

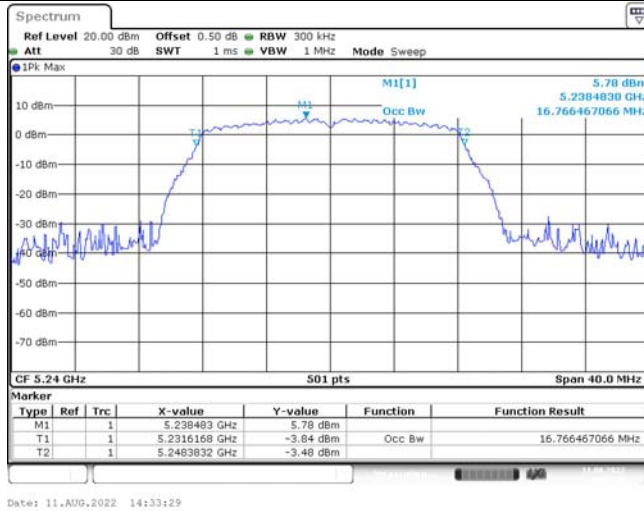

99% Emission Bandwidth

802.11n ht20
Lowest Channel

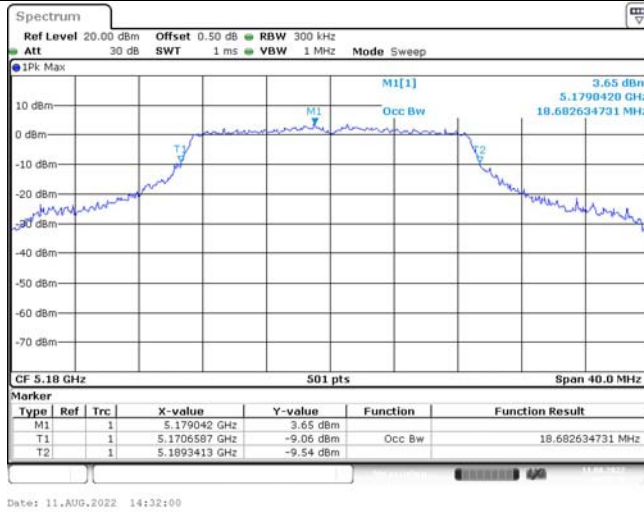

802.11n ht20
Middle Channel



802.11n ht20
Highest Channel



99% Emission Bandwidth

802.11n ht40
Lowest Channel

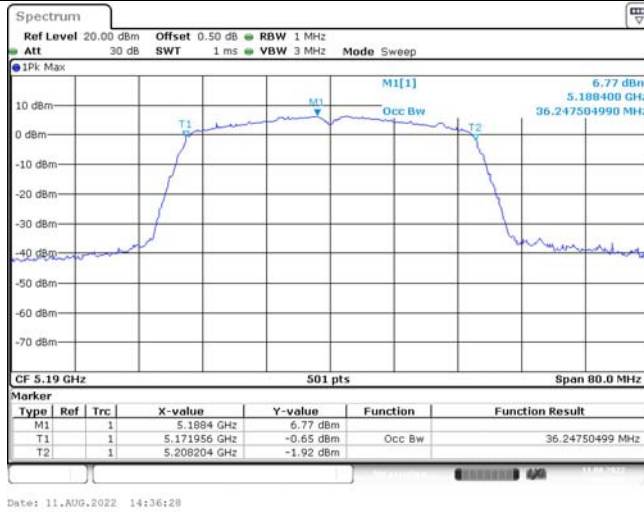

Date: 11.AUG.2022 14:36:28

802.11n ht40
Highest Channel



Date: 11.AUG.2022 14:37:17

802.11ac vht80
Middle Channel

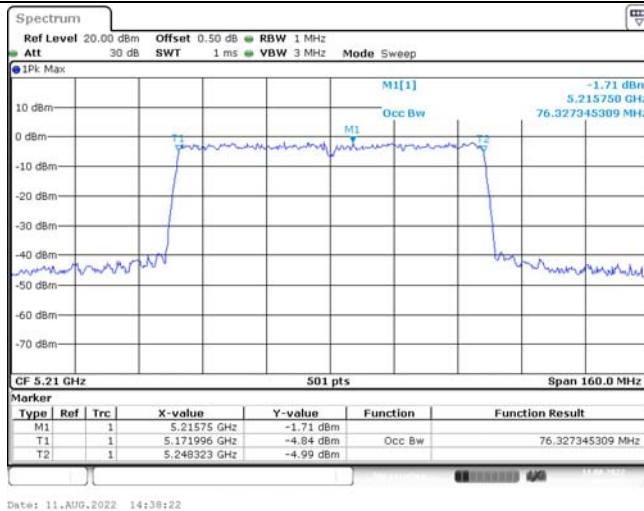

Date: 11.AUG.2022 14:38:22

5725-5850MHz:

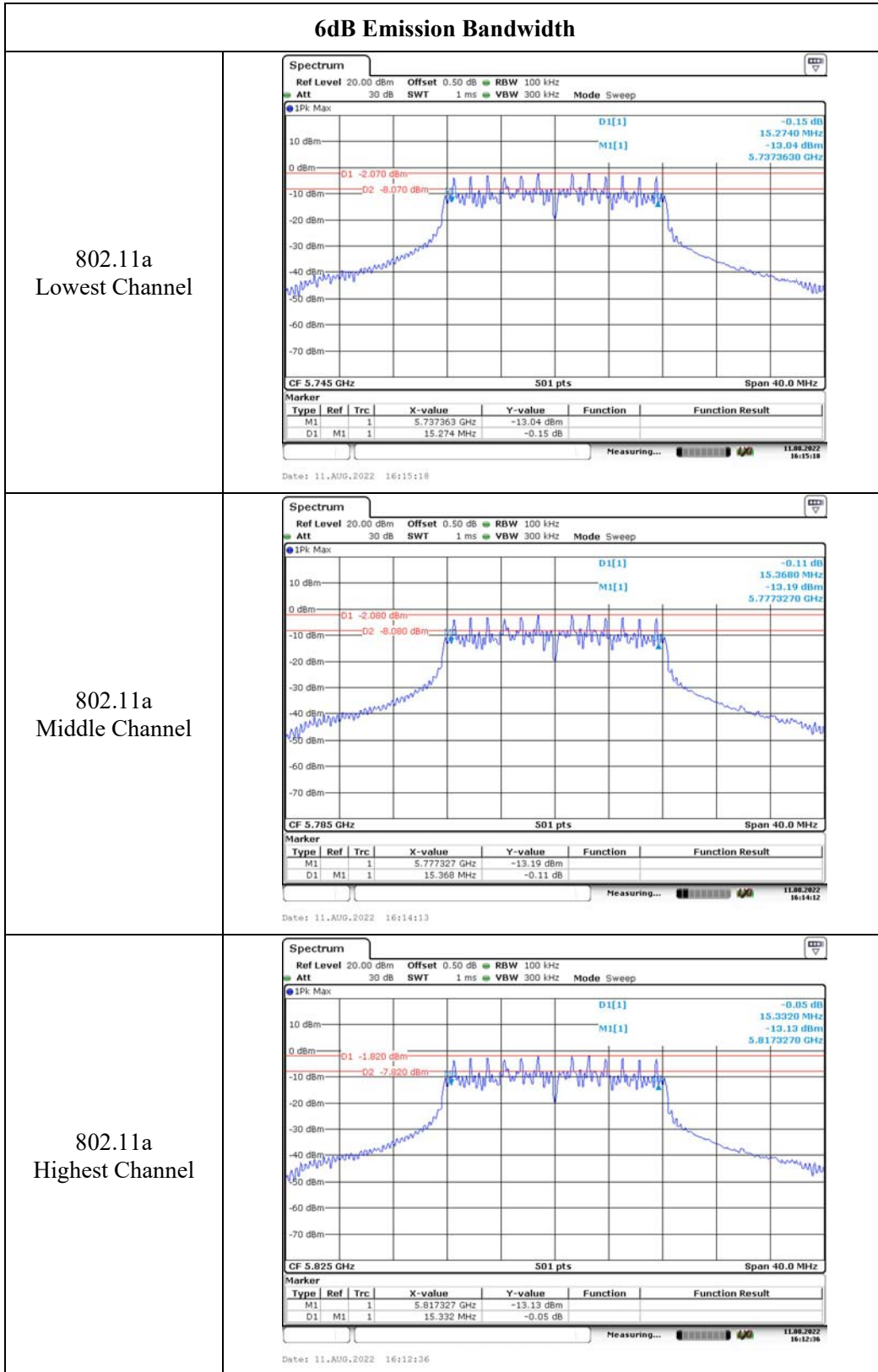

6dB Emission Bandwidth

802.11n ht20
Lowest Channel

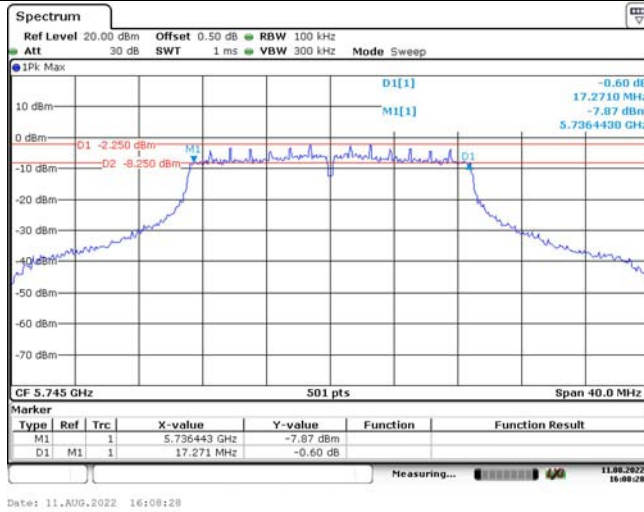

802.11n ht20
Middle Channel

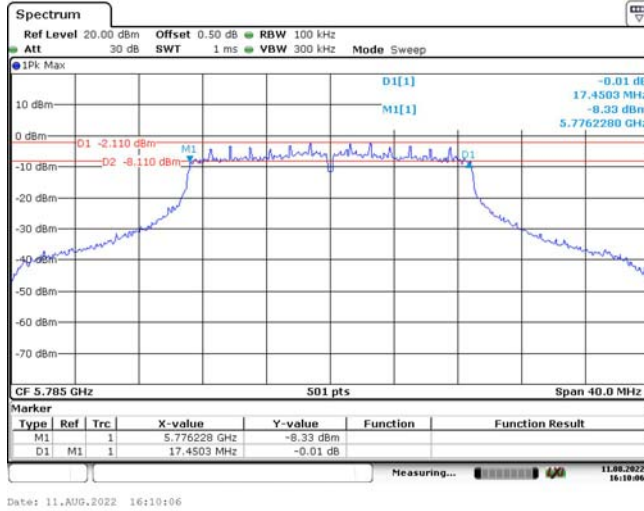

802.11n ht20
Highest Channel

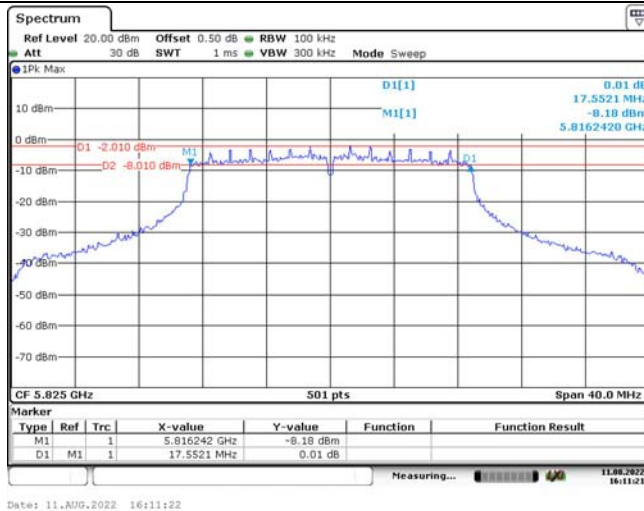

6dB Emission Bandwidth

802.11n ht40
Lowest Channel

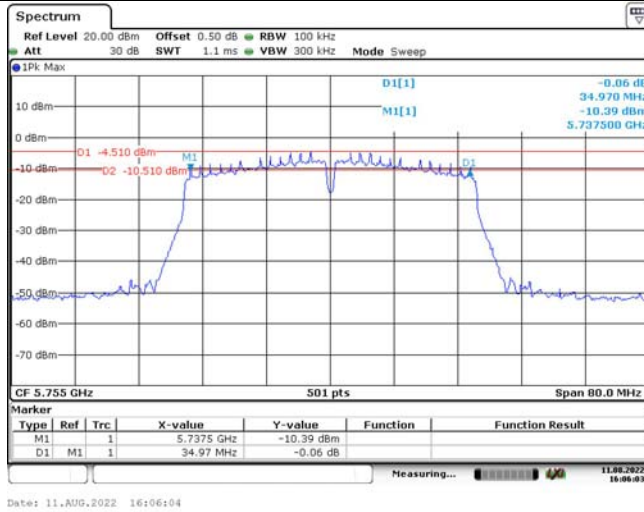

802.11n ht40
Highest Channel

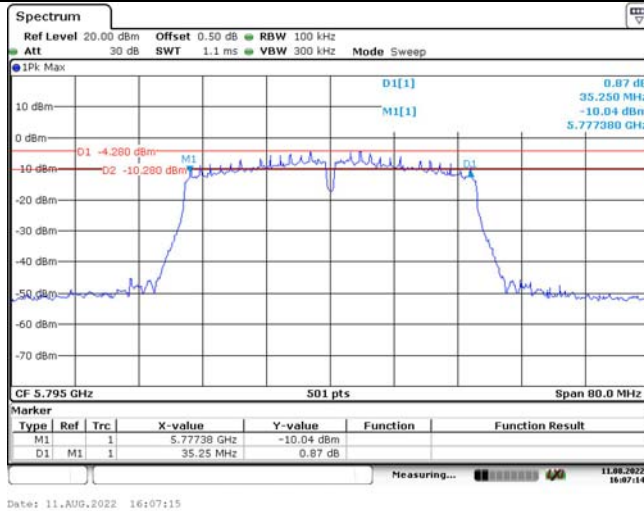

802.11ac vht80
Middle Channel

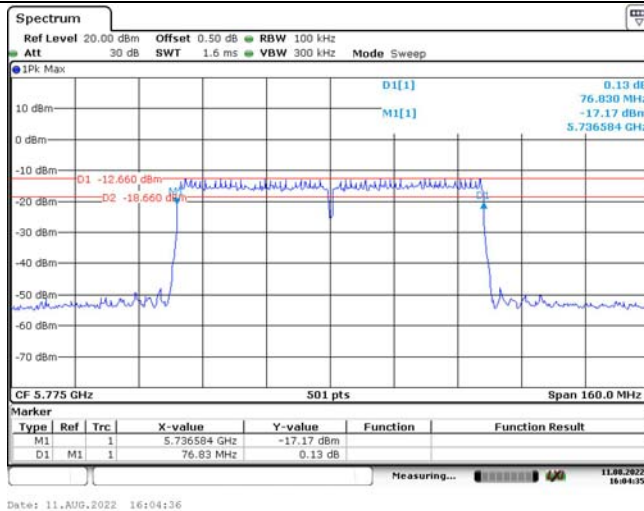

99% Emission Bandwidth

802.11a
Lowest Channel



Date: 11.AUG.2022 15:13:01

802.11a
Middle Channel



Date: 11.AUG.2022 15:11:52

802.11a
Highest Channel



Date: 11.AUG.2022 15:10:36

99% Emission Bandwidth

802.11n ht20
Lowest Channel



802.11n ht20
Middle Channel



802.11n ht20
Highest Channel



99% Emission Bandwidth

802.11n ht40
Lowest Channel



802.11n ht40
Highest Channel



802.11ac vht80
Middle Channel

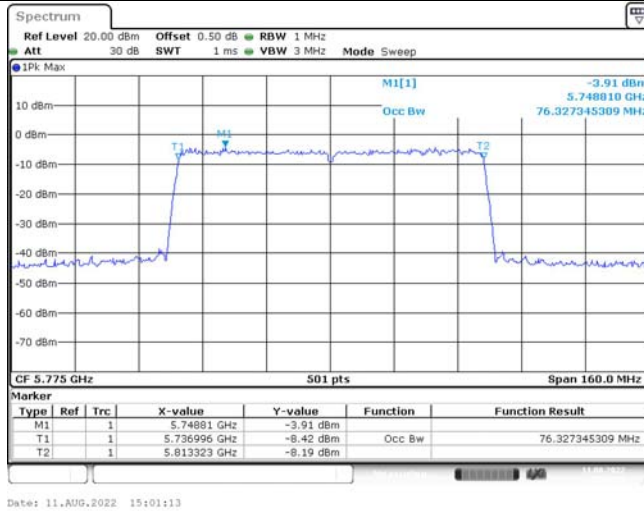

4.4 Maximum Conducted Output Power:

Serial Number:	CR22070005-RF-S1	Test Date:	2022-8-11
Test Site:	RF	Test Mode:	Transmitting
Tester:	Julie Tan	Test Result:	Pass

Environmental Conditions:

Temperature: (°C)	27.6	Relative Humidity: (%)	63	ATM Pressure: (kPa)	100.2
----------------------	------	------------------------------	----	------------------------	-------

Test Equipment List and Details:

Manufacturer	Description	Model	Serial Number	Calibration Date	Calibration Due Date
Agilent	USB Wideband Power Sensor	U2021XA	MY54080015	2022-07-15	2023-07-14
eastsheep	Coaxial Attenuator	2W-SMA-JK-18G	21060301	Each time	N/A
zhuoxiang	Coaxial Cable	SMA-178	211001	Each time	N/A

* Statement of Traceability: China Certification ICT Co., Ltd (Dongguan) attests that all calibrations have been performed, traceable to National Primary Standards and International System of Units (SI).

Test Data:

5150-5250 MHz:

Test Modes	Test Frequency (MHz)	Max. Conducted Average Output Power (dBm)			
		Chain 0	Chain 1	Total	Limit
802.11a	5180	13.62	12.72	/	24.00
	5200	13.55	12.74	/	24.00
	5240	15.16	13.31	/	24.00
802.11n ht20	5180	13.21	12.29	15.78	24.00
	5200	13.2	12.4	15.83	24.00
	5240	14.6	12.91	16.85	24.00
802.11n ht40	5190	12.72	11.88	15.33	24.00
	5230	13.8	12.1	16.04	24.00
802.11ac vht80	5210	7.19	6.64	9.93	24.00

Note:

The EUT is a client device.

The duty cycle factor has been calculated into the test data.

The device employed Cyclic Delay Diversity (CDD) for 802.11 MIMO transmitting, per KDB 662911 D01 Multiple Transmitter Output v02r01, for power measurements on IEEE 802.11 devices:

Array Gain = 0 dB (i.e., no array gain) for $N_{ANT} \leq 4$

Antenna Gain:	2.00	dBi	Directional gain:	2.00	dBi
---------------	------	-----	-------------------	------	-----

5725-5850 MHz:

Test Modes	Test Frequency (MHz)	Max. Conducted Average Output Power (dBm)			
		Chain 0	Chain 1	Total	Limit
802.11a	5745	10.33	11.44	/	30.00
	5785	10.31	11.29	/	30.00
	5825	10.22	11.01	/	30.00
802.11n ht20	5745	9.95	11.02	13.53	30.00
	5785	9.95	10.79	13.40	30.00
	5825	9.82	10.61	13.24	30.00
802.11n ht40	5755	9.56	10.51	13.07	30.00
	5795	9.51	10.42	13.00	30.00
802.11ac vht80	5775	2.26	4.94	6.81	30.00
<p>Note: The device employed Cyclic Delay Diversity (CDD) for 802.11 MIMO transmitting, per KDB 662911 D01 Multiple Transmitter Output v02r01, for power measurements on IEEE 802.11 devices: Array Gain = 0 dB (i.e., no array gain) for $N_{ANT} \leq 4$</p>					
Antenna Gain:	2	dBi	Directional gain:	2.00	dBi

4.5 Maximum power spectral density:

Serial Number:	CR22070005-RF-S1	Test Date:	2022-8-11
Test Site:	RF	Test Mode:	Transmitting
Tester:	Julie Tan	Test Result:	Pass

Environmental Conditions:

Temperature: (°C)	27.6	Relative Humidity: (%)	63	ATM Pressure: (kPa)	100.2
----------------------	------	------------------------------	----	------------------------	-------

Test Equipment List and Details:

Manufacturer	Description	Model	Serial Number	Calibration Date	Calibration Due Date
R&S	Spectrum Analyzer	FSV40	101943	2021-10-10	2022-10-09
zhuoxiang	Coaxial Cable	SMA-178	211001	Each time	N/A
Mini-Circuits	DC Block	BLK-18-S+	1554403	Each time	N/A

* Statement of Traceability: China Certification ICT Co., Ltd (Dongguan) attests that all calibrations have been performed, traceable to National Primary Standards and International System of Units (SI).

Test Data:

5150-5250 MHz:

Test Modes	Test Frequency (MHz)	Maximum Power Spectral Density (dBm/MHz)			
		Chain 0	Chain 1	Total	Limit
802.11a	5180	6.25	4.58	/	11.00
	5200	6.01	4.76	/	11.00
	5240	7.41	6.27	/	11.00
802.11n ht20	5180	4.97	5.79	8.41	11.00
	5200	5.43	5.78	8.62	11.00
	5240	6.57	7.44	10.04	11.00
802.11n ht40	5190	2.68	3.41	6.07	11.00
	5230	3.81	3.78	6.81	11.00
802.11ac vht80	5210	-5.72	-4.76	-2.20	11.00

Note:

The EUT is a client device.

Method SA-3 in KDB 789033 D02 General UNII Test Procedures New Rules v02r01 was used for PSD test.

The device employed Cyclic Delay Diversity (CDD) for 802.11 MIMO transmitting, per KDB 662911 D01 Multiple Transmitter Output v02r01, for power spectral density (PSD) measurements on the devices:

Array Gain = $10 \log(N_{ANT}/N_{SS})$ dB

Antenna Gain:	2.00	dBi	Directional gain:	5.00	dBi
---------------	------	-----	-------------------	------	-----

5725-5850 MHz:

Test Modes	Test Frequency (MHz)	Reading (dBm/300kHz)		Maximum Power Spectral Density (dBm/500kHz)			
		Chain 0	Chain 1	Chain 0	Chain 1	Total	Limit
802.11a	5745	-0.29	1.26	1.93	3.48	/	30.00
	5785	-0.39	1.33	1.83	3.55	/	30.00
	5825	0.69	1.59	2.91	3.81	/	30.00
802.11n ht20	5745	-0.85	1.27	1.37	3.49	5.57	30.00
	5785	-0.26	1.35	1.96	3.57	5.85	30.00
	5825	-0.29	1.27	1.93	3.49	5.79	30.00
802.11n ht40	5755	-3.44	-1.12	-1.22	1.1	3.10	30.00
	5795	-3.22	-1.06	-1	1.16	3.22	30.00
802.11ac vht80	5775	-11.24	-9.94	-9.02	-7.72	-5.31	30.00

Note:
Method SA-3 in KDB 789033 D02 General UNII Test Procedures New Rules v02r01 was used for PSD test.
The device employed Cyclic Delay Diversity (CDD) for 802.11 MIMO transmitting, per KDB 662911 D01 Multiple Transmitter Output v02r01, for power spectral density (PSD) measurements on the devices:
Array Gain = $10 \log(N_{ANT}/N_{SS})$ dB

Antenna Gain:	2.00	dBi	Directional gain:	5.00	dBi
---------------	------	-----	-------------------	------	-----

5150-5250MHz:
Chain0:

Maximum power spectral density

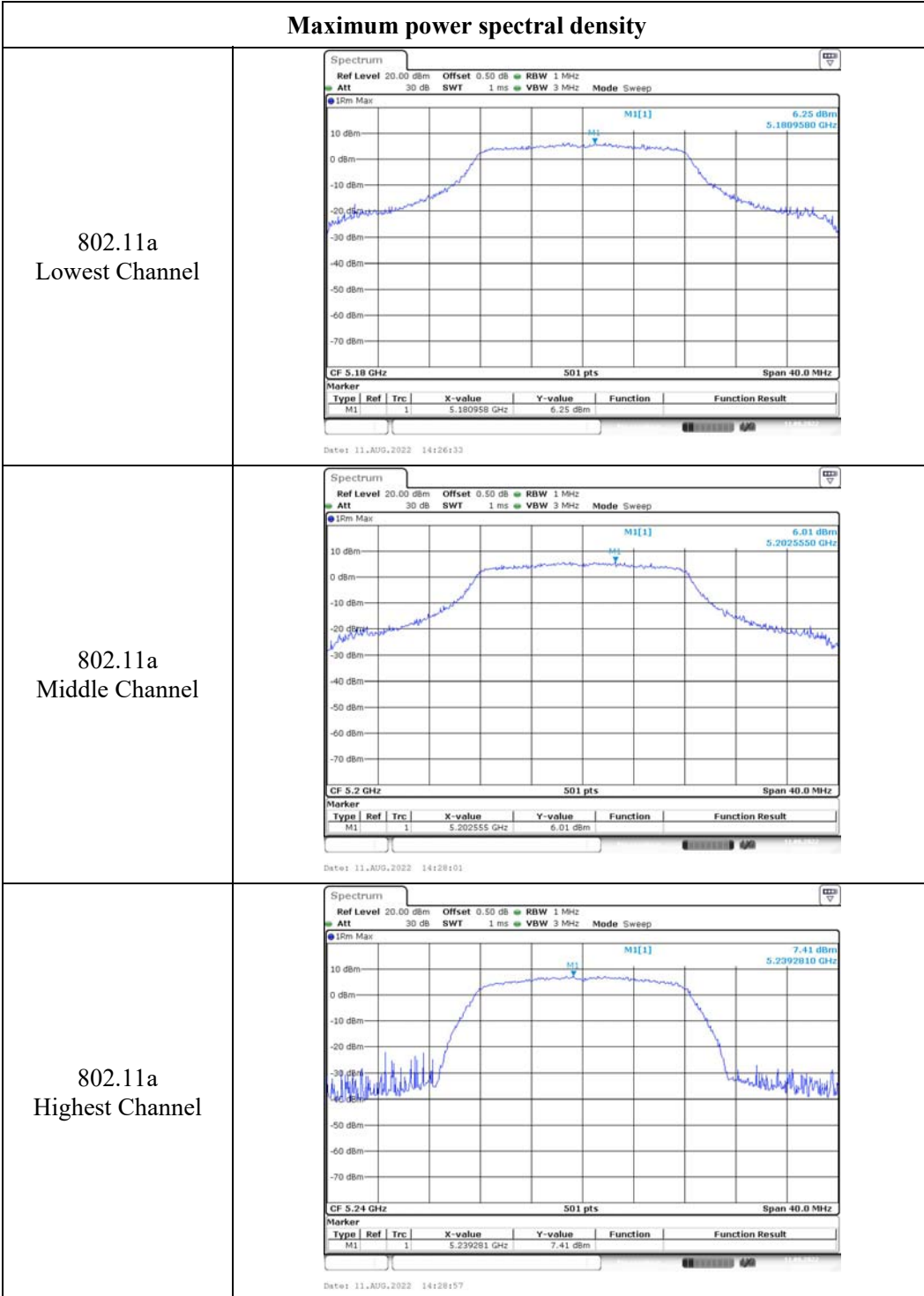

Maximum power spectral density

802.11n ht20
Lowest Channel

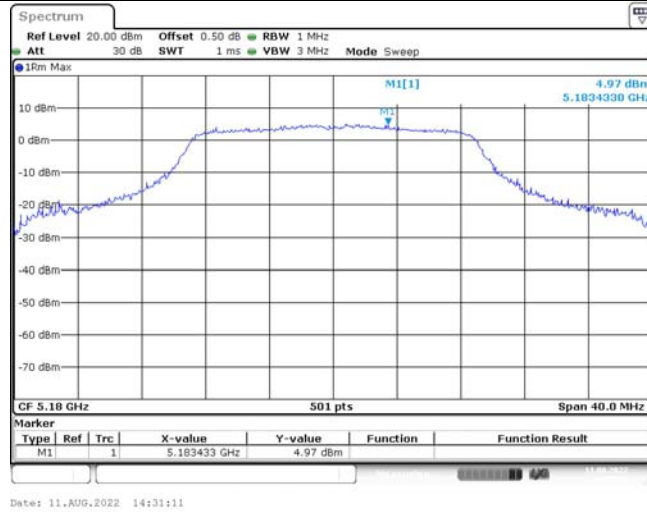

Date: 11.AUG.2022 14:31:11

802.11n ht20
Middle Channel

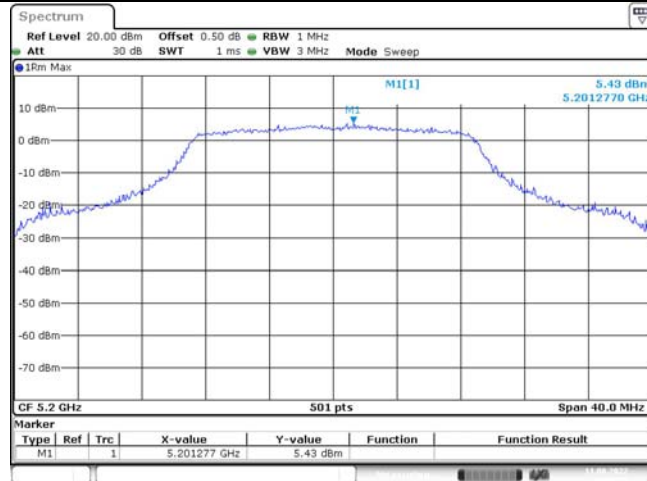

Date: 11.AUG.2022 14:30:19

802.11n ht20
Highest Channel

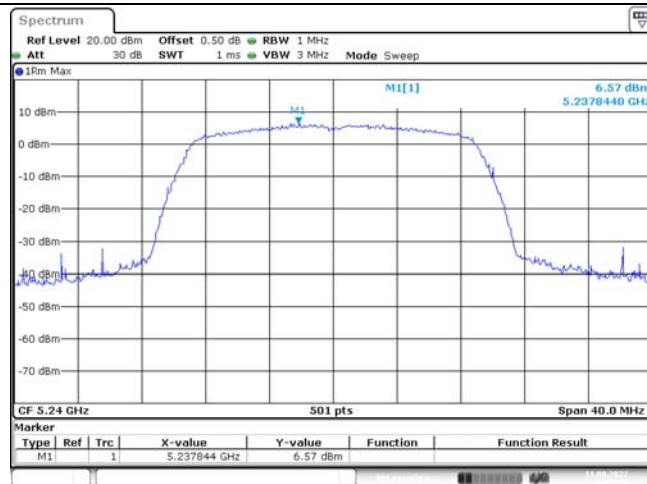

Date: 11.AUG.2022 14:29:38

Maximum power spectral density

802.11n ht40
Lowest Channel

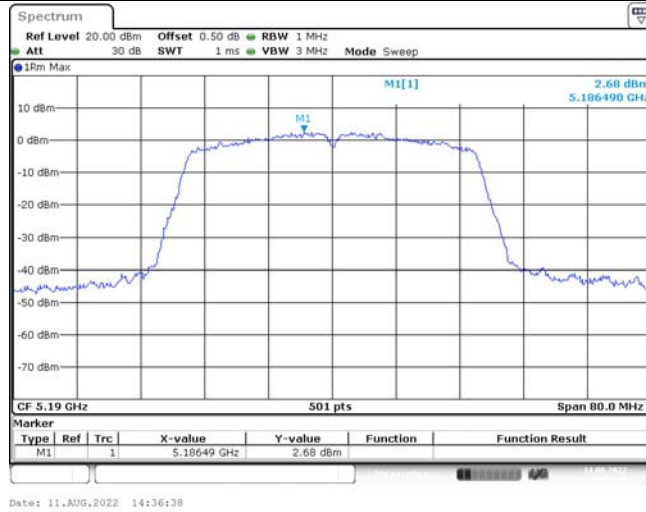

802.11n ht40
Highest Channel



802.11ac vht80
Middle Channel

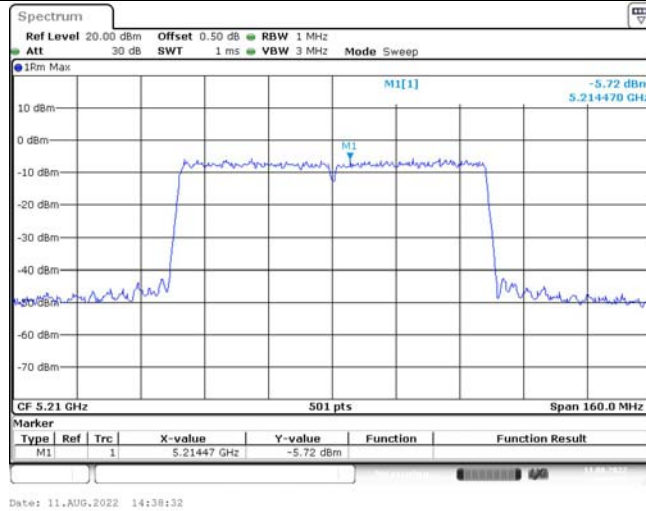

Chain1:

Maximum power spectral density

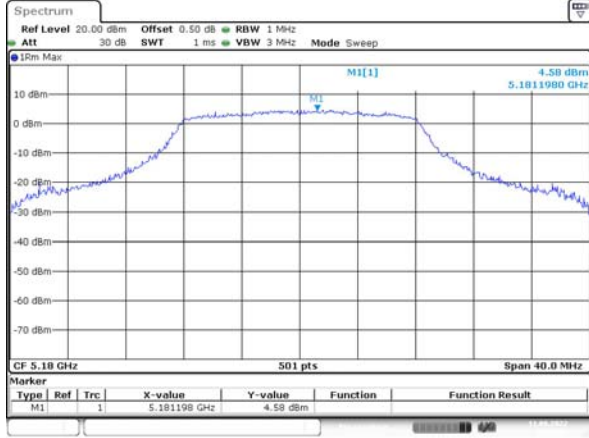
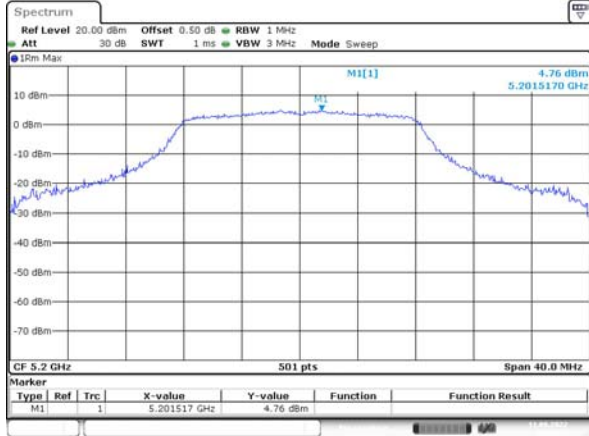
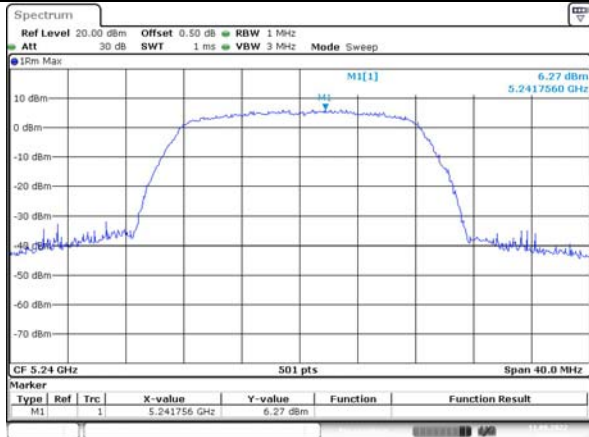
<p>802.11a Lowest Channel</p>	 <p>CF 5.18 GHz 501 pts Span 40.0 MHz</p> <table border="1"> <thead> <tr> <th>Marker</th> <th>Type</th> <th>Ref</th> <th>Trc</th> <th>X-value</th> <th>Y-value</th> <th>Function</th> <th>Function Result</th> </tr> </thead> <tbody> <tr> <td>M1</td> <td></td> <td></td> <td></td> <td>5.181198 GHz</td> <td>4.58 dBm</td> <td></td> <td></td> </tr> </tbody> </table> <p>Date: 11.AUG.2022 14:44:00</p>	Marker	Type	Ref	Trc	X-value	Y-value	Function	Function Result	M1				5.181198 GHz	4.58 dBm		
Marker	Type	Ref	Trc	X-value	Y-value	Function	Function Result										
M1				5.181198 GHz	4.58 dBm												
<p>802.11a Middle Channel</p>	 <p>CF 5.2 GHz 501 pts Span 40.0 MHz</p> <table border="1"> <thead> <tr> <th>Marker</th> <th>Type</th> <th>Ref</th> <th>Trc</th> <th>X-value</th> <th>Y-value</th> <th>Function</th> <th>Function Result</th> </tr> </thead> <tbody> <tr> <td>M1</td> <td></td> <td></td> <td></td> <td>5.201517 GHz</td> <td>4.76 dBm</td> <td></td> <td></td> </tr> </tbody> </table> <p>Date: 11.AUG.2022 14:43:37</p>	Marker	Type	Ref	Trc	X-value	Y-value	Function	Function Result	M1				5.201517 GHz	4.76 dBm		
Marker	Type	Ref	Trc	X-value	Y-value	Function	Function Result										
M1				5.201517 GHz	4.76 dBm												
<p>802.11a Highest Channel</p>	 <p>CF 5.24 GHz 501 pts Span 40.0 MHz</p> <table border="1"> <thead> <tr> <th>Marker</th> <th>Type</th> <th>Ref</th> <th>Trc</th> <th>X-value</th> <th>Y-value</th> <th>Function</th> <th>Function Result</th> </tr> </thead> <tbody> <tr> <td>M1</td> <td></td> <td></td> <td></td> <td>5.241756 GHz</td> <td>6.27 dBm</td> <td></td> <td></td> </tr> </tbody> </table> <p>Date: 11.AUG.2022 14:43:13</p>	Marker	Type	Ref	Trc	X-value	Y-value	Function	Function Result	M1				5.241756 GHz	6.27 dBm		
Marker	Type	Ref	Trc	X-value	Y-value	Function	Function Result										
M1				5.241756 GHz	6.27 dBm												

Maximum power spectral density

802.11n ht20
Lowest Channel

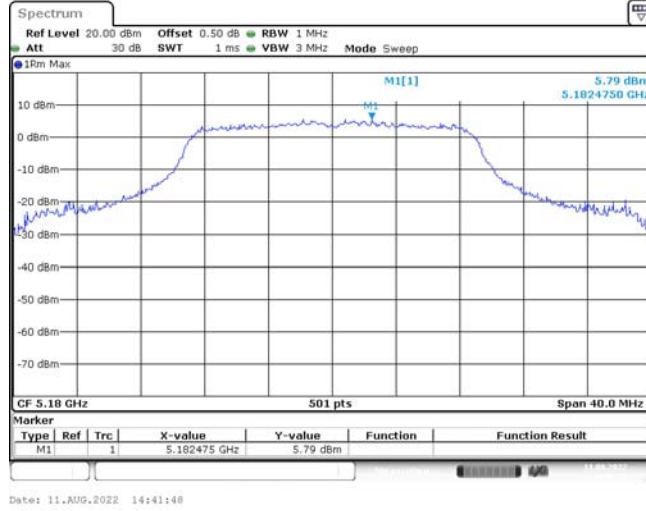

802.11n ht20
Middle Channel



802.11n ht20
Highest Channel



Maximum power spectral density

802.11n ht40
Lowest Channel

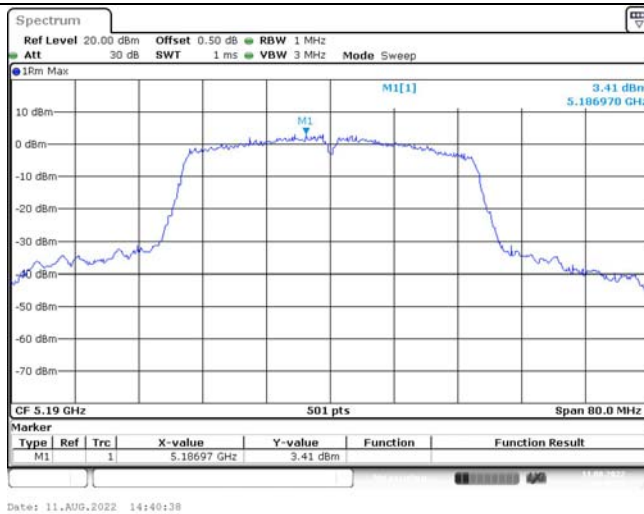

802.11n ht40
Highest Channel

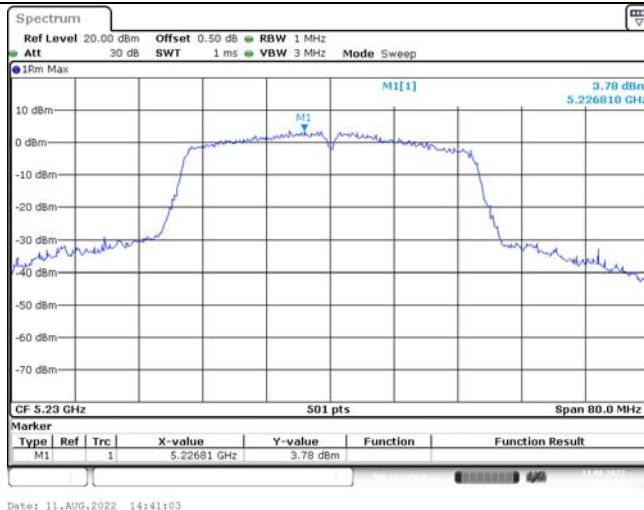

802.11ac vht80
Middle Channel



5725-5850MHz
Chain 0:

Maximum power spectral density

802.11a
Lowest Channel

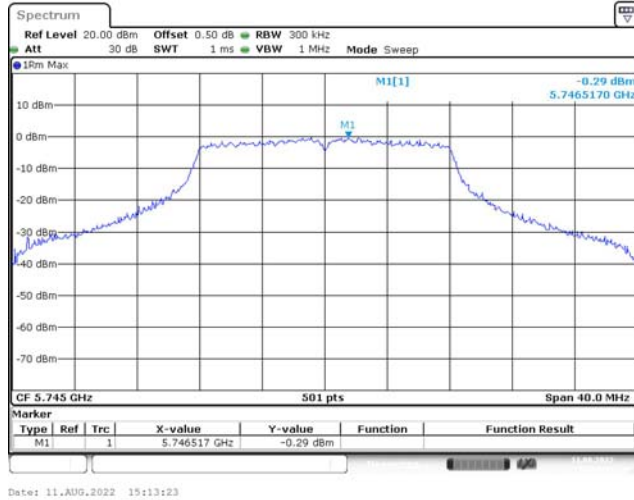

Date: 11.AUG.2022 15:13:23

802.11a
Middle Channel

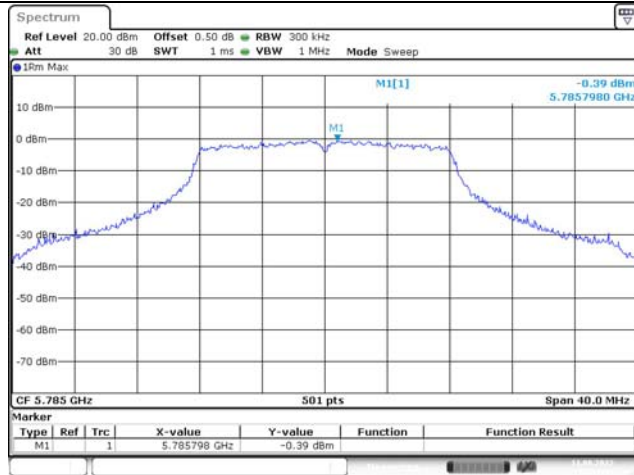

Date: 11.AUG.2022 15:12:14

802.11a
Highest Channel

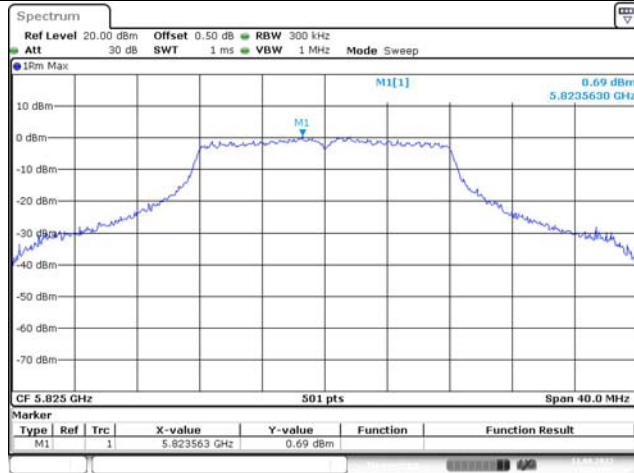

Date: 11.AUG.2022 15:11:04

Maximum power spectral density

802.11n ht20
Lowest Channel

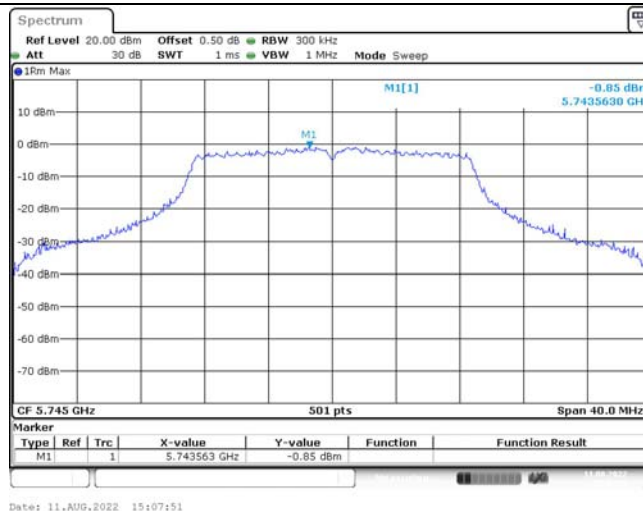

802.11n ht20
Middle Channel

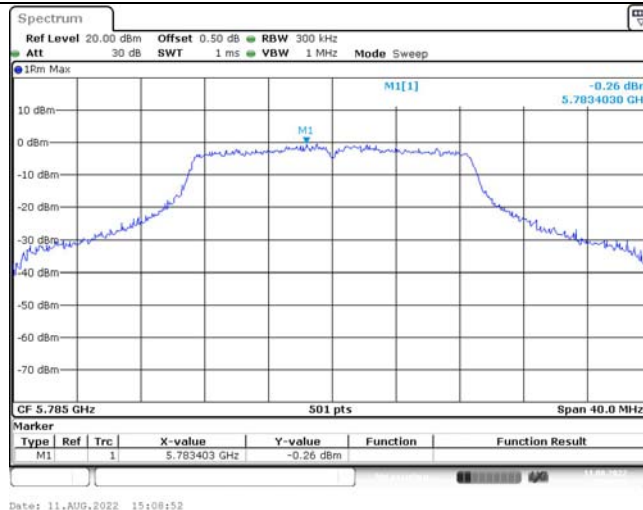

802.11n ht20
Highest Channel

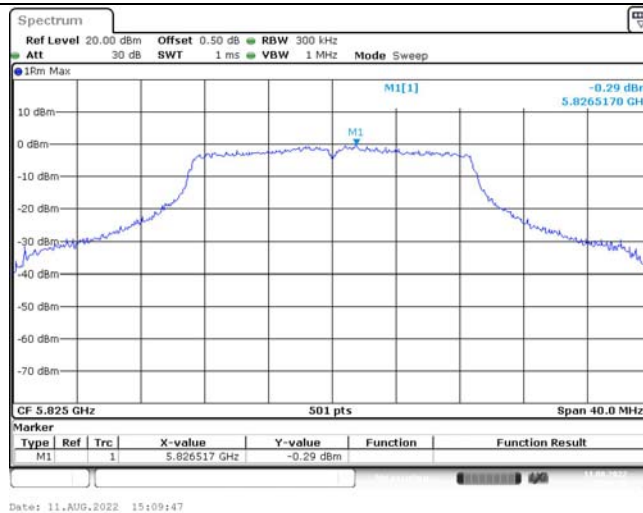

Maximum power spectral density

802.11n ht40
Lowest Channel

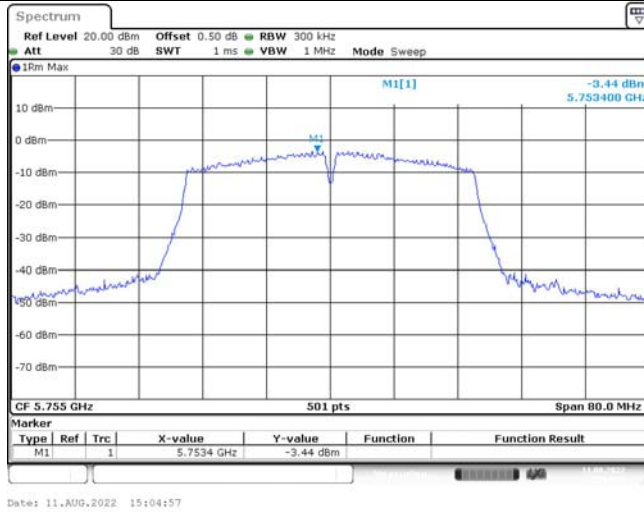

802.11n ht40
Highest Channel

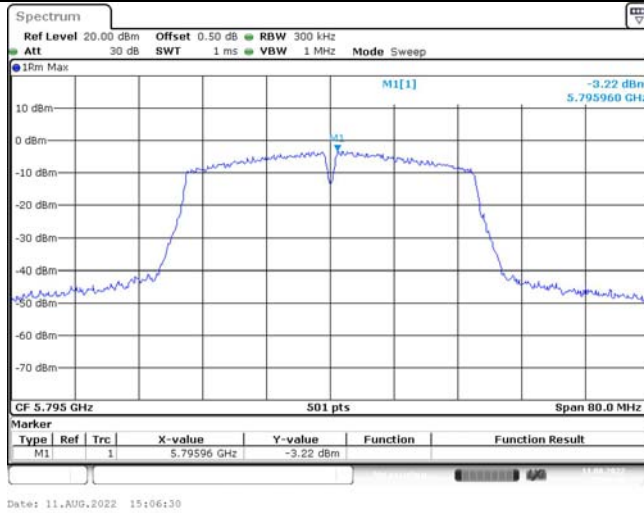

802.11ac vht80
Middle Channel

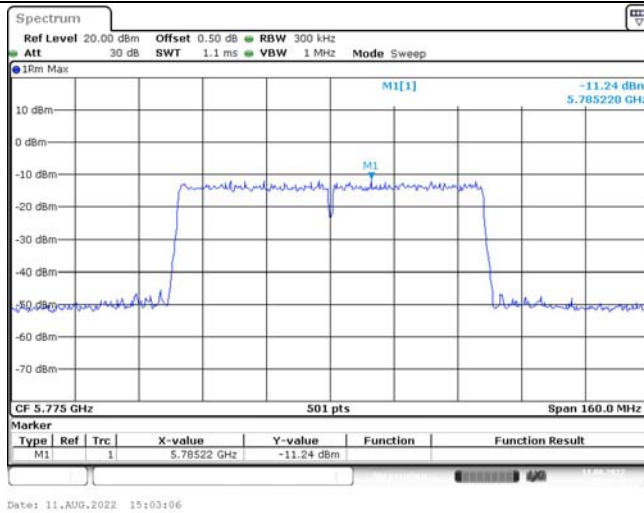

Chain1:

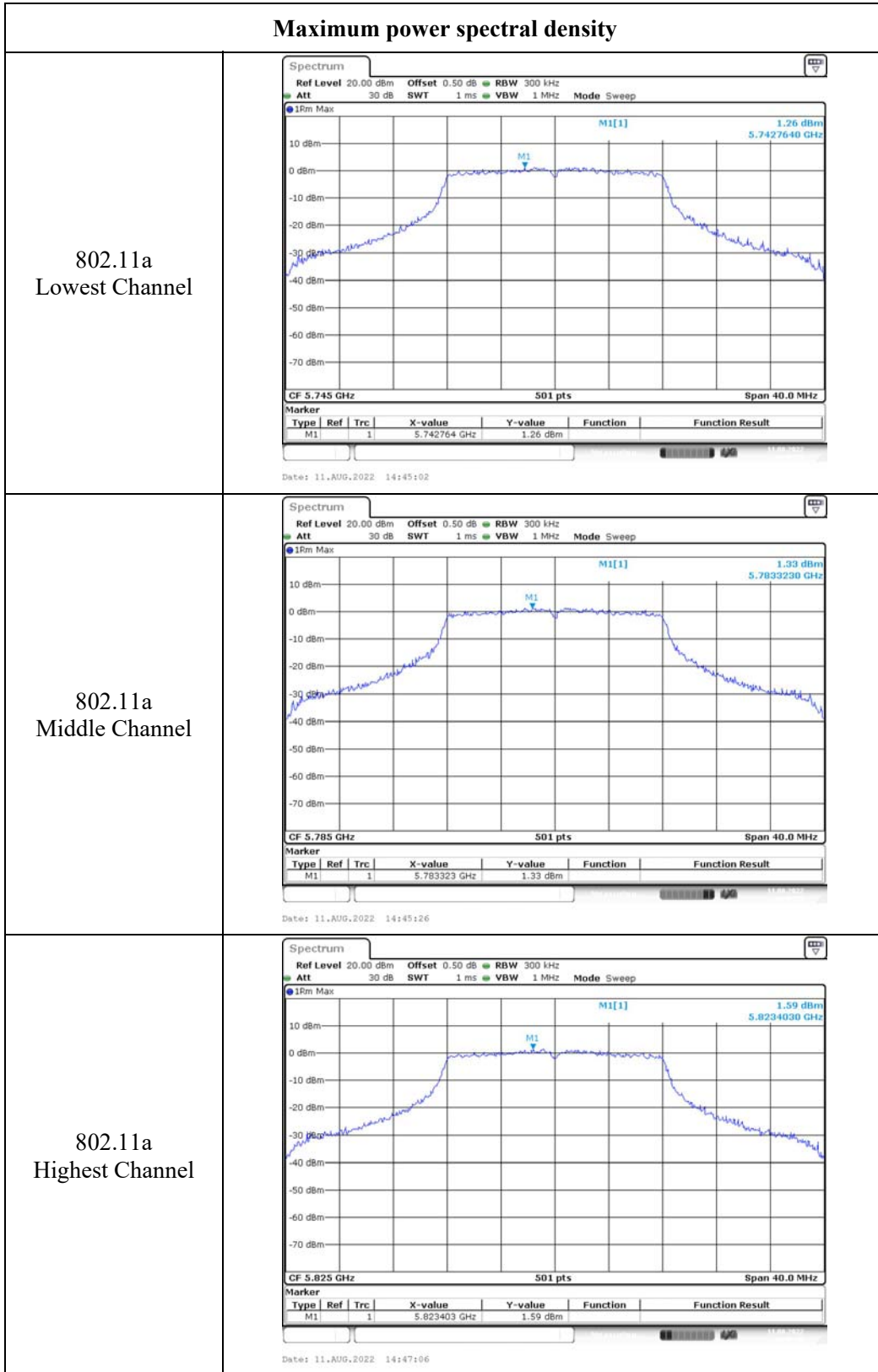

Maximum power spectral density

802.11n ht20
Lowest Channel

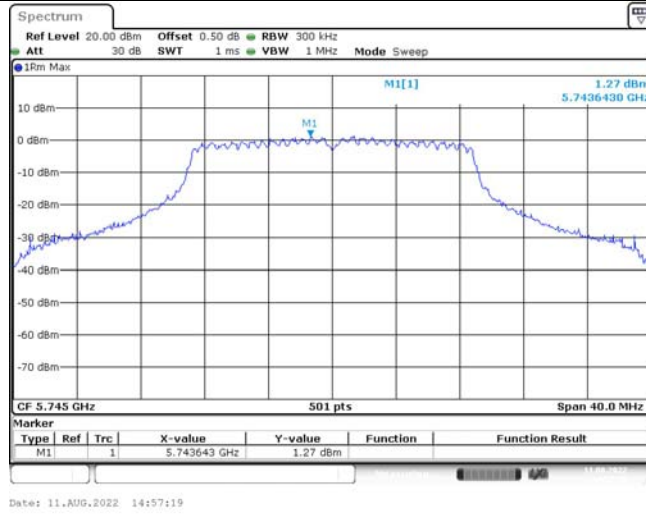

802.11n ht20
Middle Channel

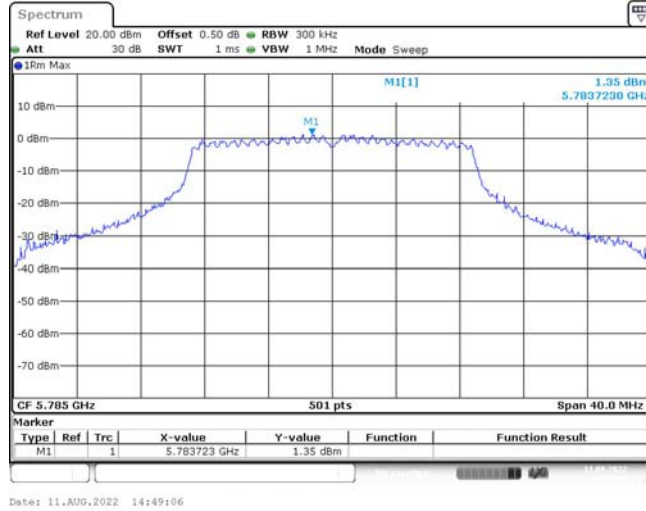

802.11n ht20
Highest Channel



Maximum power spectral density

802.11n ht40
Lowest Channel

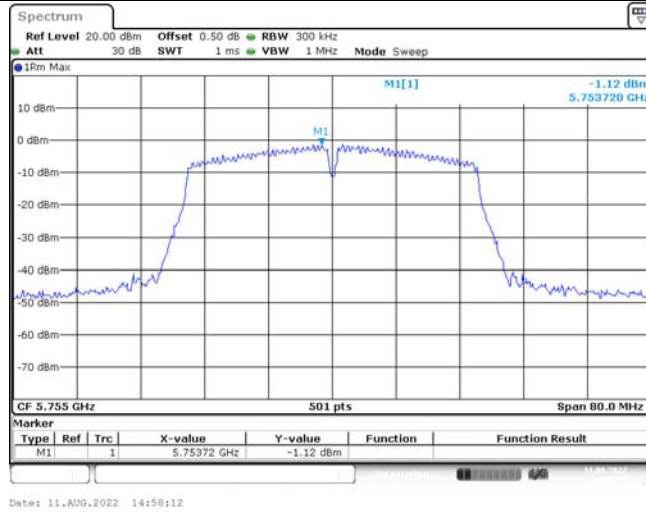

802.11n ht40
Highest Channel

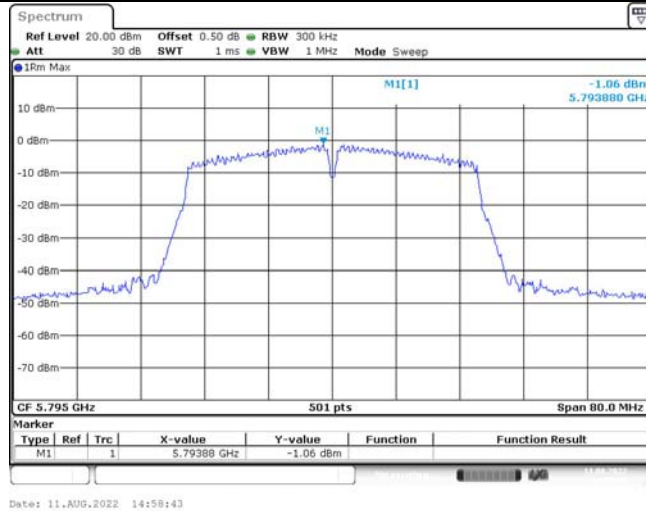

802.11ac vht80
Middle Channel

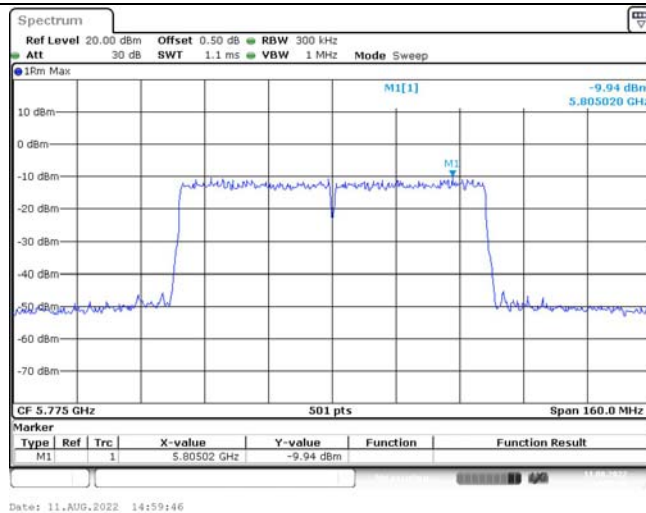

4.6 Duty Cycle:

Serial Number:	CR22070005-RF-S1	Test Date:	2022-8-11
Test Site:	RF	Test Mode:	Transmitting
Tester:	Julie Tan	Test Result:	Pass

Environmental Conditions:

Temperature: (°C)	27.6	Relative Humidity: (%)	63	ATM Pressure: (kPa)	100.2
----------------------	------	---------------------------	----	------------------------	-------

Test Equipment List and Details:

Manufacturer	Description	Model	Serial Number	Calibration Date	Calibration Due Date
R&S	Spectrum Analyzer	FSV40	101943	2021-10-10	2022-10-09
zhuoxiang	Coaxial Cable	SMA-178	211001	Each time	N/A
Mini-Circuits	DC Block	BLK-18-S+	1554403	Each time	N/A

* Statement of Traceability: China Certification ICT Co., Ltd (Dongguan) attests that all calibrations have been performed, traceable to National Primary Standards and International System of Units (SI).

Test Data:

Test Modes	Ton (ms)	Ton+off (ms)	Duty Cycle (%)
802.11a	0.022	0.048	45.83
802.11n ht20	2.651	2.953	89.77
802.11n ht40	1.302	1.624	80.17
802.11ac vht80	0.103	0.445	23.15

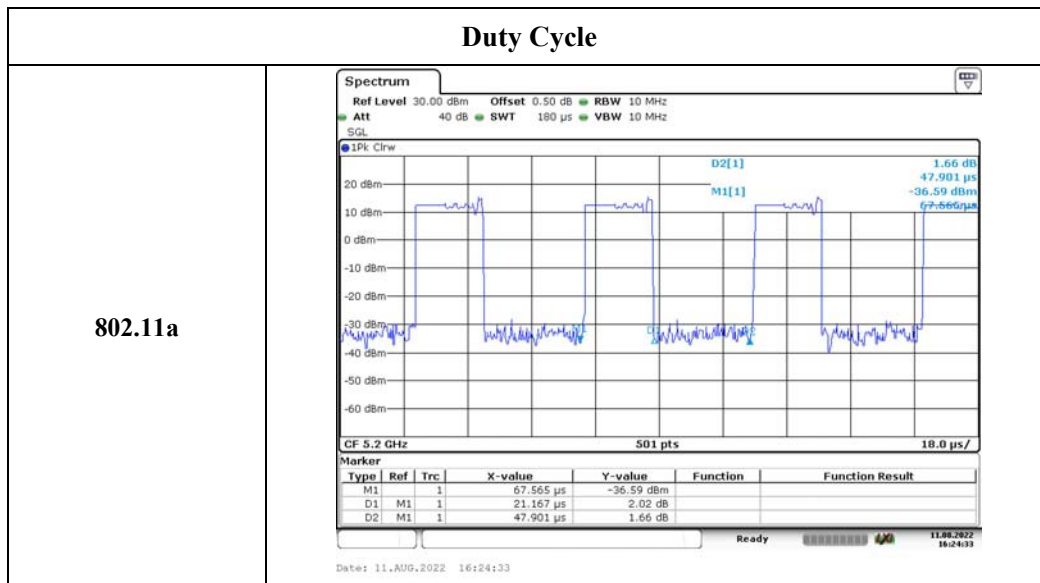

Duty Cycle

802.11n ht20

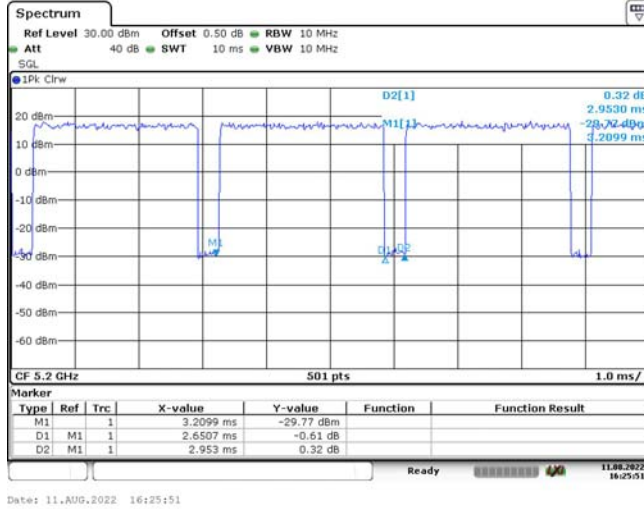

Date: 11.AUG.2022 16:25:51

802.11n ht40

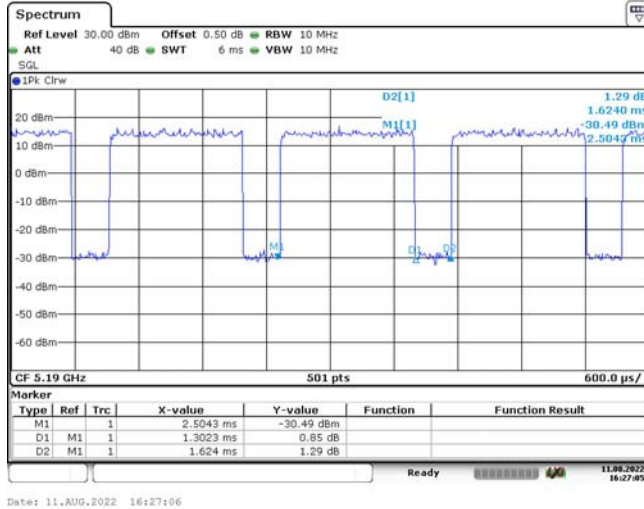

Date: 11.AUG.2022 16:27:06

802.11ac vht80

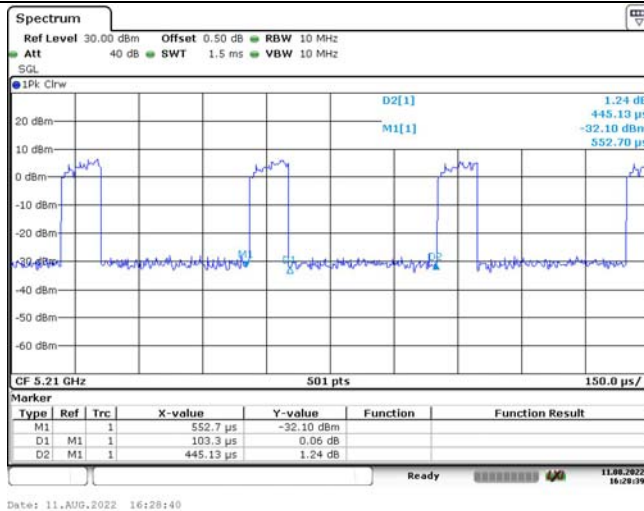

Date: 11.AUG.2022 16:28:40

==== END OF REPORT ====