

X-UFO™

HIGHEST TECH R/C FLYING TOY

Instruction Manual

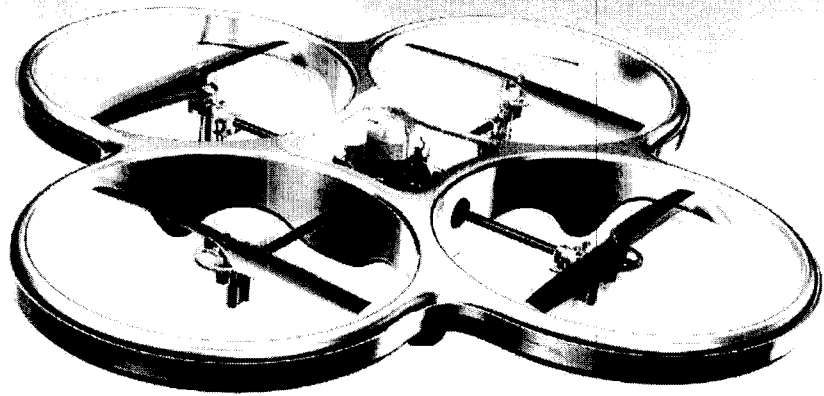

CAUTION ELECTRIC TOY:

Not recommended for children under 14 years of age. As with all electric products, precautions should be observed during handling and use to prevent electric shock.

GB

Silverlit®
ELECTRONICS

Introduction

A simple and easy to fly X-UFO machine equipped with advanced technology is now available. The R/C X-UFO: Flying up sky has a simple and compact size to achieve form follow function design. Making your sky journey in a full excitement. The gyro sensors and four high speed electric motors make it differentiate with other flying products in the market. Lightweight carbon fiber frame with extremely durable poly foam ring body prevents serious destruction through aerial fly. And flying distance can be up to 100 meters nearly out of your sight.

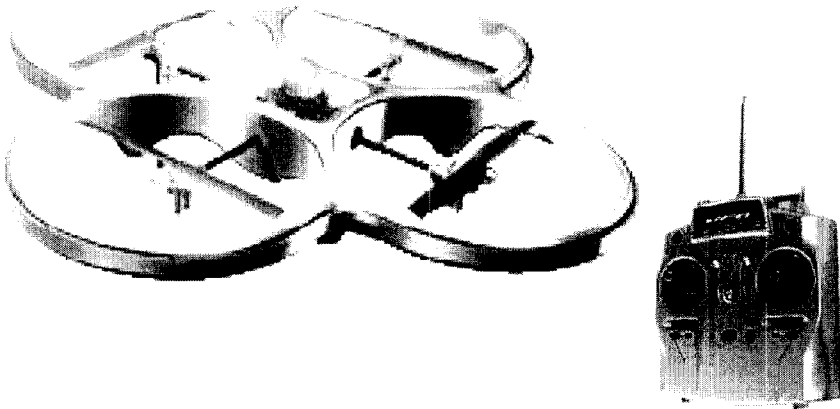

Key Features

- Gyro Stabilized
- Indoor & Outdoor
- Easy To Fly
- Unique Electronic Control System
- Ultra Lightweight Carbon Fiber Frame
- Flying Distance Up To 100 Meters

Contents

1. Pack List	2
2. Precautions, Warning & Statement	2
3. Parts Identification	
3.1 X-UFO	4
3.2 Transmitter	4
3.3 Power Charger	5
3.4 Automobile Adaptor	5
3.5 AC/DC Adaptor	5
4. Batter Installation and Charging	
4.1 X-UFO	6
4.2 Transmitter	6
4.3 Power Charger	6
5. Transmitter Operation	7
6. Procedure for Flight	9
7. Environment for Flight	10
8. Flight Technique and Tips	10
9. Repair and Maintenance	10
10. Trouble Shooting	11
11. Specification	11

1. Pack List

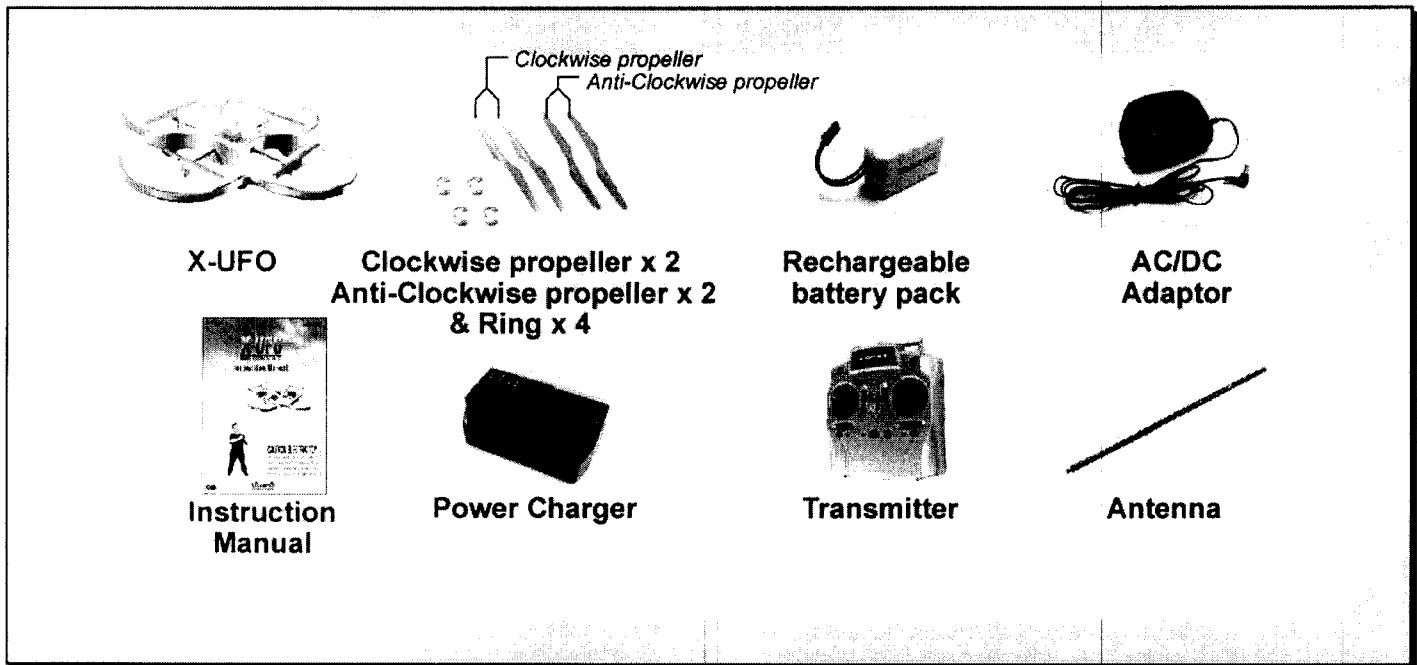

2. Precautions, Warning & Statement

2.1 Precautions

- 2.1.1 Read through the whole Instruction Manual before starting to play your X-UFO.
- 2.1.2 Make sure you and other people keep 1-2 meters away from the X-UFO while you start for flight.
- 2.1.3 Always keep an eye on the flying X-UFO to prevent it flying, landing or crashing on or near your head, your body and any other people.
- 2.1.4 Do not pick up or touch flying, landing or crashing X-UFO before you turn off the Transmitter and waited for all propellers stopped rotating.
- 2.1.5 Always turn off the X-UFO and the Transmitter after you stop to flight. Remove all batteries inside all devices.
- 2.1.6 Remove the Ni-MH battery from the X-UFO when not in use to prevent any unexpected accident. Keep it in a safe and cool condition, without direct sunlight to avoid overheats or short with a wire.

2.2 Warning Statement

Safety Precautions:

- Parents, this toy is recommended for children. To ensure that your child's play is both safe and fun, please review the operating instructions with your children.
 - Adult assemble is required!
 - Adult supervision is required!
 - DO NOT touch the turning propeller!
 - Keep hands, hair and loose clothing away from the running propeller.
 - Remove battery from transmitter and X-UFO when not in use.
 - DO NOT operate your X-UFO on street. Avoid hitting people, pets or home furnishings.
- Warning: Changes or modifications to this unit not expressly approved by the party responsible for compliance could void the user's authority to operate the equipment.**

FCC Statements

This device complies with part 15 of the FCC rules. Operation is subject to the following two conditions:

- 1) This device may not cause harmful interference, and
- 2) This device must accept any interference received, including interference that may cause undesired operation.

NOTE: This equipment has been tested and found to comply with the limits for a Class B digital device, pursuant to Part 15 of the FCC Rules. These limits are designed to provide reasonable protection against harmful interference in a residential installation. This equipment generates, uses and can radiate radio frequency energy and, if not installed and used in accordance with the instructions, may cause harmful interference to radio communications.

However, there is no guarantee that interference will not occur in a particular installation. If this equipment does cause harmful interference to radio or television reception, which can be determined by turning the equipment off and on, the user is encouraged to try to correct the interference by one or more of the following measures:

- Reorient or relocate the receiving antenna.
- Increase the separation between the equipment and receiver.
- Connect the equipment into an outlet on a circuit different from that to which the receiver is connected.
- Consult the dealer or an experienced radio/TV technician for help.

Care and Maintenance:

- Always remove batteries from the toy when it is not being used for a long period of time.
- Wipe the toy gently with a clean damp cloth.
- Keep the toy away from direct heat.
- Do not submerge the toy into water that can damage the electronic assemblies.

Note:

- Parental guidance is recommended when installing or replacing batteries.
- New batteries are recommended to use in this toy to obtain best and maximum performance. (For transmitter)
- You are advised to recharge the battery pack as soon as the function becomes impaired.
- Users should keep and retain this information for future reference.
- Users should keep strict accordance with the instruction manual while operating the product.
- Under the environment with electrostatic discharge, the sample may malfunction and require user to reset the sample.

Battery Cautions:

- Do not recharge the battery if it's hot. Allow it to cool before recharging.
- Do not charge the battery that shows leakage or corrosion.
- Do not disassemble the battery.
- Do not dispose of the batteries in fire.

Cautions:

- Non-rechargeable batteries are not to be recharged.
- Rechargeable batteries are to be removed from the toy before being charged.
- Rechargeable battery are only to be charged by an adult.
- Different types of batteries or new and used batteries are not to be mixed.
- Only batteries of the same or equivalent type as recommended are to be used.
- Batteries are to be inserted with correct polarity.
- Exhausted batteries are to be removed from the toy.
- The supply terminals are not to be short-circuited.

Special Note to Adults:

- Regularly examine for damage to the plug, enclosure and other parts. In the event of any damage, the toy must not be used with the power charger until the damage has been repaired.
- This toy is not intended for children under 3 years old. The charger is not a toy.
- This toy must only be used with the recommended charger and AC/DC adaptor.
- Do not try to charge other batteries with Power Charger.

Note: *New and Alkaline batteries are recommended to obtain best and maximum performance.*

Battery requirement for Transmitter:

- ☉☉ Power Supply : ===
- ☉☉ Rating : DC6V 0.9W
- ☉☉ Batteries : 4 x 1.5V "AA"/LR6/AM3
- ☉☉ Requires 4 x 1.5V "AA" size batteries (not included)



Battery requirement for X-UFO:

- ☉☉ Power Supply : ===
- ☉☉ Rating : DC12V 50W
- ☉☉ Batteries : 12V NiMH battery pack
- ☉☉ Requires 1 x 12V NiMH battery pack & Charger (included)

⚠ WARNING:
CHOKING HAZARD – Small parts.
Not for Children under 3 years.

"This product is in compliance with the essential requirements and other relevant provisions of Directive 1999/5/EC."



3. Parts Identification

3.1 X-UFO

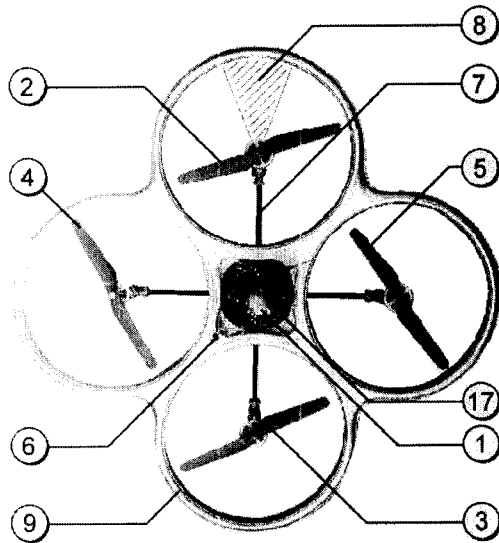

TOP VIEW

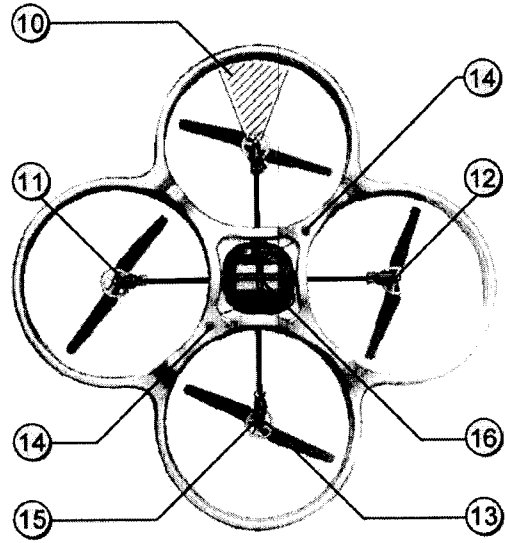

BOTTOM VIEW

1. Gyro and Main Control Board
2. Clockwise Propeller
3. Clockwise Propeller
4. Anti-clockwise Propeller
5. Anti-clockwise Propeller
6. ON/OFF switch
7. Carbon Fiber Frame
8. Red LED Light(Front part)

9. Poly-foam Ring
10. Red LED LIGHT(Front part)
11. Blue LED Light
12. Blue LED Light
13. Blue LED Light
14. Ultrasonic Receiver (optional for advance version)
15. IR Emitting Diode (optional for advance version)
16. Battery Case

3.2 Transmitter

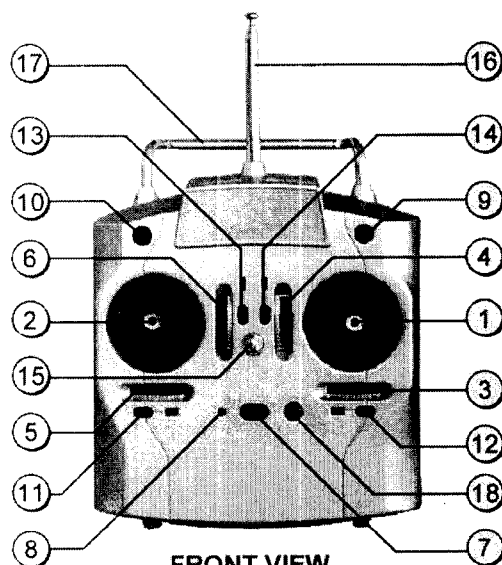

FRONT VIEW

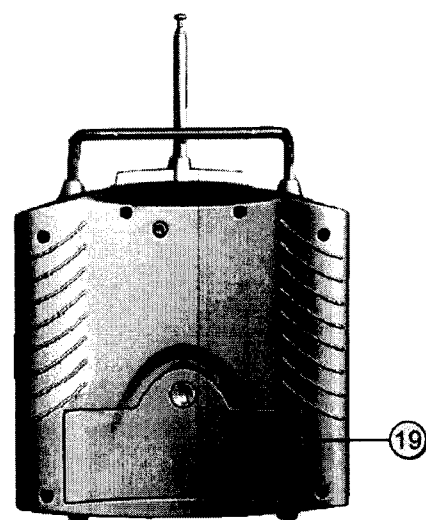

BACK VIEW

1. Right Control Stick
Vertical-Pitch forward or Backward (Mode2)
Vertical-Throttle up or down (Mode 1)
Horizontal-Roll left or right
2. Left Control Stick
Vertical-Throttle up or down (Mode 2)
Vertical-Pitch forward or Backward (Mode 1)
Horizontal-Yaw left or right
3. Roll Trimmer
4. Pitch Trimmer (Mode2) Throttle Trimmer (Mode 1)
5. Yaw Trimmer
6. Throttle Trimmer (Mode2) Pitch Trimmer (Mode 1)
7. Main on/off switch
8. Power LED

9. Trainer Button (Optional for Advance Version)
10. Auto Button (Optional for Advance Version)
11. Aux1 (Optional for Advance Version)
12. Aux4 (Optional for Advance Version)
13. Aux2 (Optional for Advance Version)
14. Aux3 (Optional for Advance Version)
15. Neck Strap Connecting Hook
16. Retractable Antenna
17. Carrying Handle
18. AUX5 (Optional for Advance Version)
19. Battery Compartment

3.3 Power Charger

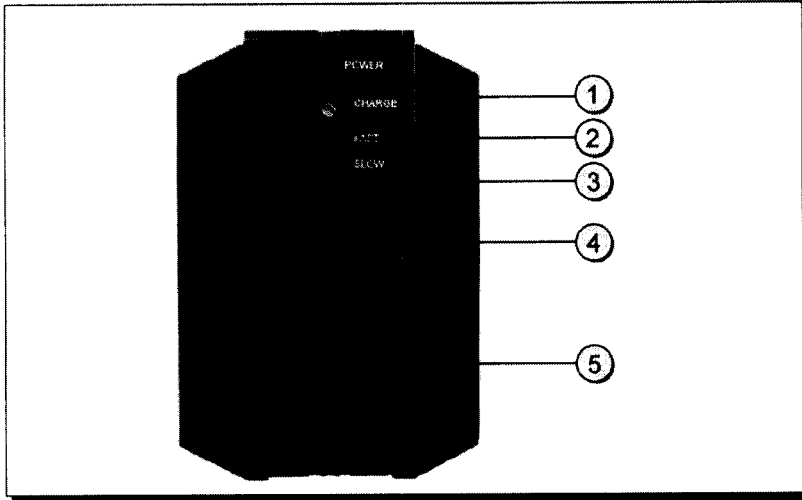

1. Power LED
2. Battery Charging Indicator
3. Selector (Fast / Slow Charge)
4. Plug connect to Rechargeable Battery
5. Recess area for Rechargeable Battery

** SLOW Charge: Charging time about 100 minutes. (Recommended using SLOW charge to obtain better life time for battery.)*

** FAST Charge : Charging time about 20-25 minutes.*

3.4 Automobile Adaptor (Optional)

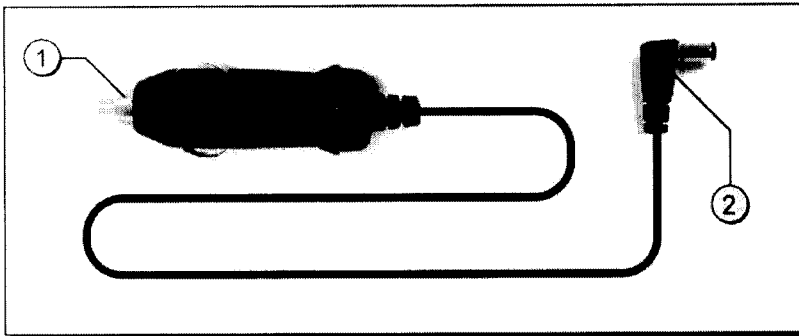

1. Plug Head connect to the Car Socket
2. Plug Head connect to the Power Charger

** 12V Automobile Adaptor use in normal vehicle.*

3.5 AC/DC Adaptor

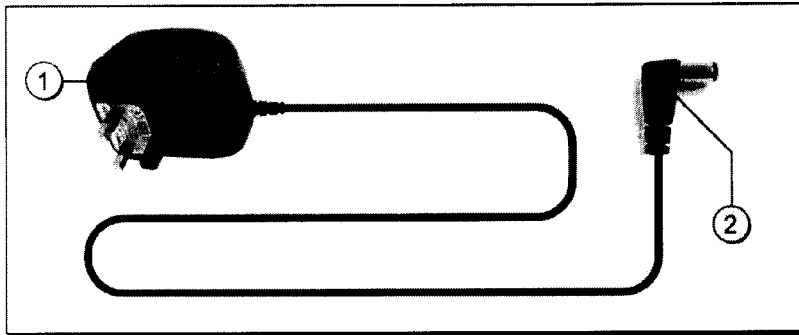

1. Plug connect to the AC Source
2. Plug connect to the Power Charger

4. Battery Installation & Charging

4.1 Battery Installation : X-UFO

Make sure the power switch is on "OFF" position.

1. Remove the battery case as shown.(pic.1)
2. Connect the battery and set the battery in its compartment. (pic.2)
3. Replace the battery case .(pic.3)

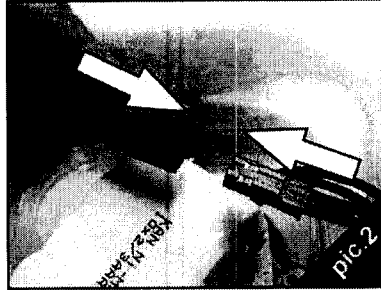
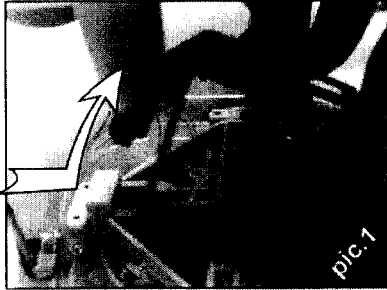

NOTE 1: If you need to hold or pick up X-UFO, make sure the power switch is at OFF position.
NOTE 2: Be aware of unexpected propellers rotating which may hit against face or hand after switching on the X-UFO with battery installed.

4.2 Battery Installation : Transmitter

Make sure the power switch is on "OFF" position

1. Open the battery door with a coin turning in counter clockwise. (pic.4)
2. Insert 4 new "AA" size batteries with "+" & "-" signs as shown inside battery compartment. (pic.5)
3. Close the battery door with a coin turning in clockwise. (pic.6)

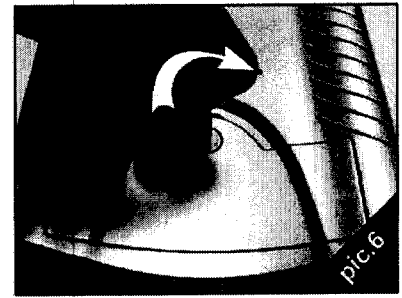
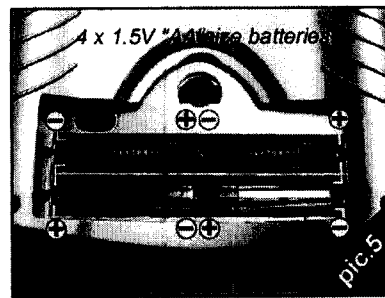
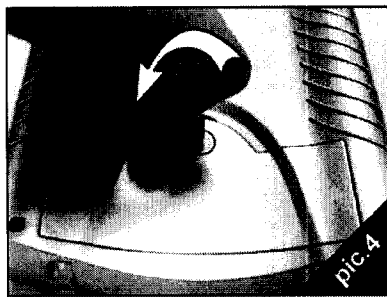

NOTE 1: After batteries are installed, make sure the Transmitter is in OFF position if flight is not yet started.

NOTE 2: Once the Transmitter is in ON position, RF signal emits automatically before you trigger any buttons. There may have frequency interference with other RF products near by.

4.3 Battery Charging

1. Connect the plug of the Automobile Adaptor or AC/DC Adaptor to Power Charger. The red LED indicator will light up. (pic.7)
2. Select the charging time you desire. There are 2 options "FAST" or "SLOW".(pic.8) (pic.9) After charging, the X-UFO can be operated up to about 4~5 minutes depending on flying conditions.
3. After charging is completed, the green LED indicator will turn off automatically.

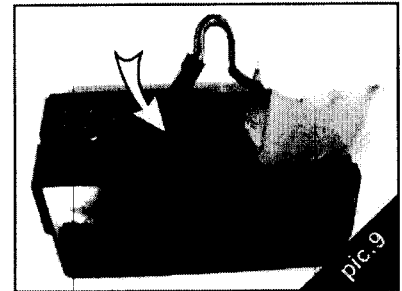
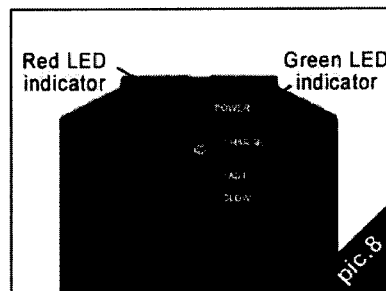
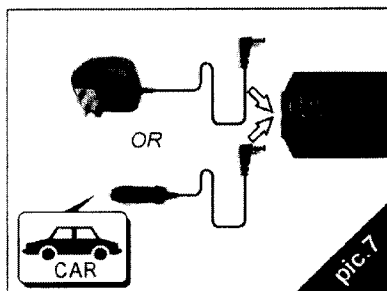

Regularly examine for damage to the plug, enclosure and other parts. In the event of any damage, the toy must not be used with the power charger until the damage has been repaired.

NOTE : Regularly examine for damage to the plug, enclosure and other parts in the event of any damage, the toy must not be used with the Power Charger until the damage has been repaired.

5. Transmitter Operation

5.1 Basic Idea:

Your X-UFO transmitter is compatible with most of the transmitter used for model control, such as 27M FM 4 channel transmitter sold separately in the market.

MODE-I			MODE-II		
Left Control Stick	Right Control Stick	Action	Left Control Stick	Right Control Stick	Action
	↑	↑ Throttle up		↑	↑ Throttle up
	↓	↓ Throttle down		↓	↓ Throttle down
←		↻ Yaw left	←		↻ Yaw left
→		↻ Yaw right	→		↻ Yaw right
↑	Suspending the X-UFO	• ↑ Pitch forward		↑	• ↑ Pitch forward
↓	Suspending the X-UFO	• ↓ Pitch backward		↓	• ↓ Pitch backward
Suspending the X-UFO	←	• ← Roll left	Suspending the X-UFO	←	• ← Roll left
Suspending the X-UFO	→	• → Roll right	Suspending the X-UFO	→	• → Roll right

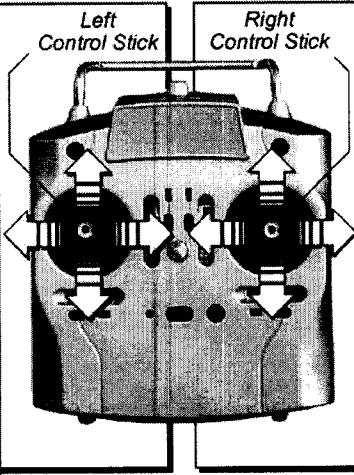

5.2 MODE-I (for Asian area)

Throttle up & down

• RED LABEL INDICATING FRONT HEAD

Yaw left & right

• RED LABEL INDICATING FRONT HEAD

Pitch forward

• RED LABEL INDICATING FRONT HEAD

Pitch backward

• RED LABEL INDICATING FRONT HEAD

Roll left

• RED LABEL INDICATING FRONT HEAD

Roll right

• RED LABEL INDICATING FRONT HEAD

5.3 MODE-II (for American & European area)

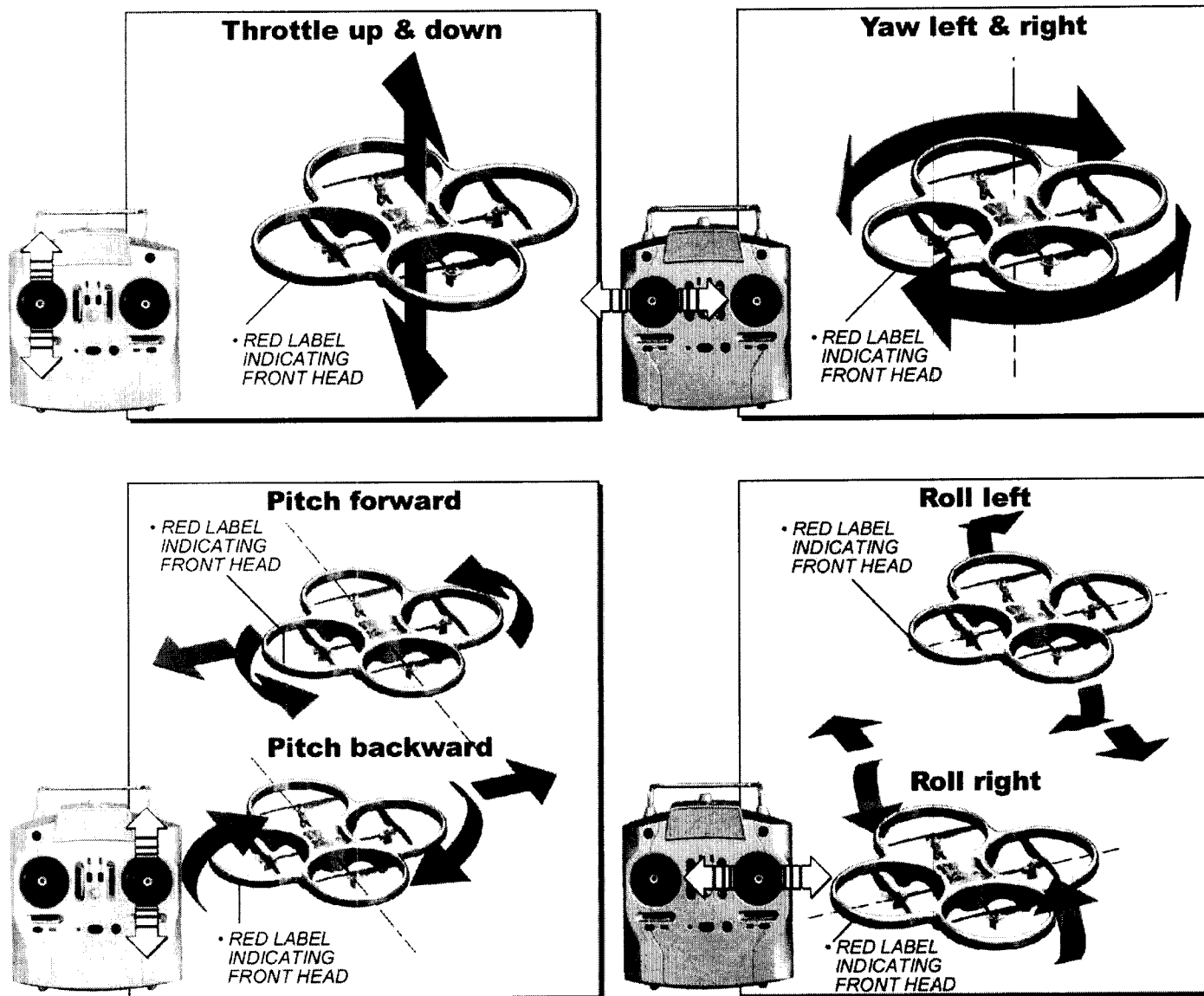

5.4 Trimmer adjustment

NOTE:

The trimmer is a fine tune to the operating levers on your transmitter; it can't supersede the function of the levers. Trimmer adjustment is a preparation for your flight, we expect your X-UFO can go up in a stable way after adjustment so that you may have an easy flight, but may not a perfect flight.

Please follow the steps below to adjust the trimmer:

1. Keep all the trimmers in center position.
2. Slowly push the Throttle up to raise your X-UFO about 0.5 to 1meter high.
3. When your X-UFO goes up slowly, you can move down the THROTTLE trimmer to have it suspending in a certain height; when it goes down slowly, you can move up the THROTTLE trimmer.
4. When your X-UFO spirals left, you can move YAW trimmer to right. When it spirals right, move YAW trimmer to left.
5. When your X-UFO goes left, you can move ROLL trimmer to right. When it goes right, move ROLL trimmer to left.
6. When your X-UFO goes forward, you can move PITCH trimmer to backward. When it goes backward, move PITCH trimmer to forward.

6. Procedure For Flight

- 1 Remove the battery from the X-UFO. Charge the battery through the Power Charger.

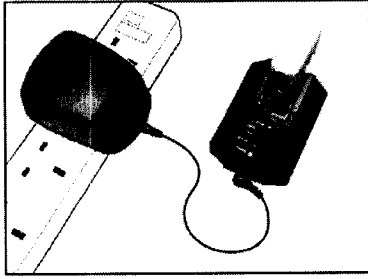

- 2 Connect the fully charged battery pack to the X-UFO.

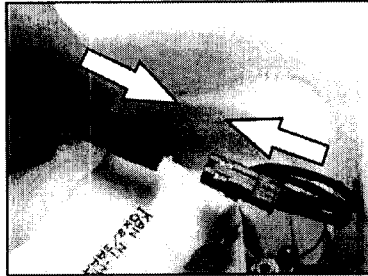

- 3 Pull the Throttle Stick down to the minimum before turn on the Transmitter.

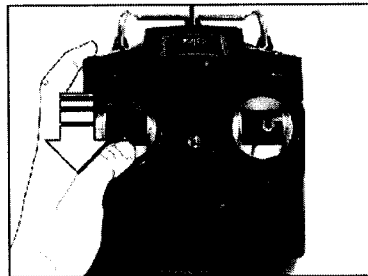

- 4 Turn on the Transmitter.

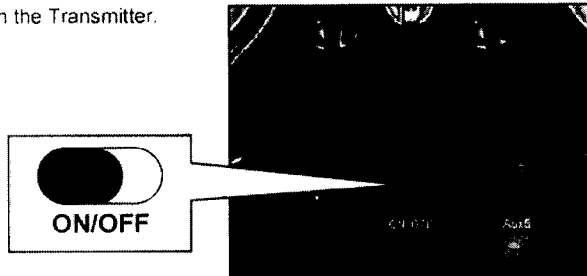

- 5 Place the X-UFO on a flat floor. Turn the red label side which represents the front head of the X-UFO in front of you. Switch on the X-UFO.

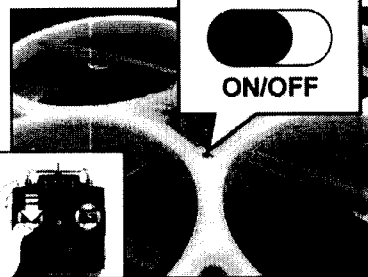

IMPORTANT:
Make sure the Throttle Stick in the Transmitter is down to the minimum position before switch on the X-UFO.

- 6 Check on the light pattern for "Ready to fly". Wait around 5 seconds in order to obtain a constant light blinking directions.

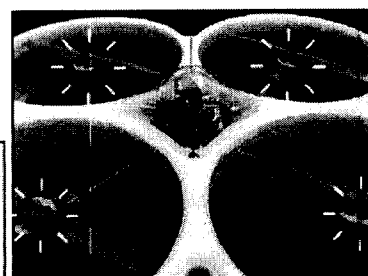

NOTE 1:
"Ready to fly" light pattern.

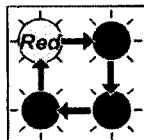

7. Pull the Throttle Stick of the Transmitter slowly upwards until 4 propellers are activated & started to fly. Flight time for a fully charged battery will be around 4 to 5 minutes.

CAUTION:
Avoid from flying the X-UFO above or near people. We are not responsible for any accident arising from a flight made in disregard of these cautions.

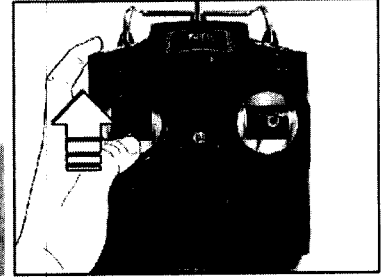

8. For the beginners, keep your X-UFO fly up to 1 to 1.5 meter height. Keep practice to make sure you the X-UFO is under your control. Always follow the red label front head of the X-UFO in order to figure out the control direction.

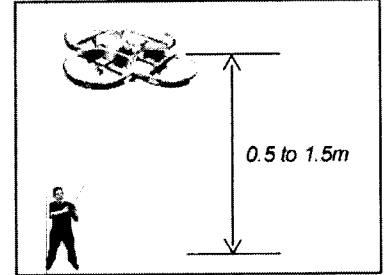

9. When you can keep your X-UFO stable in the air, tune the Yaw trimmer first to prevent unstable spiral turn. Tune all other trimmers as well (Roll, Pitch, Yaw and Throttle) in order to obtain stable hovering performance.

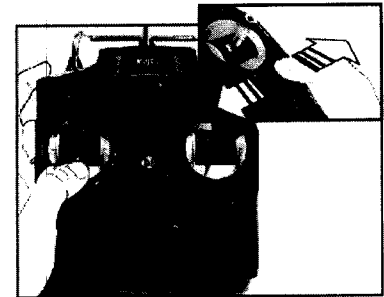

10. If X-UFO crashes, first pull down the Throttle Stick of the Transmitter to the minimum until all 4 propellers on the X-UFO stop moving. Make sure the Throttle Stick down to the minimum BEFORE picking up your X-UFO.

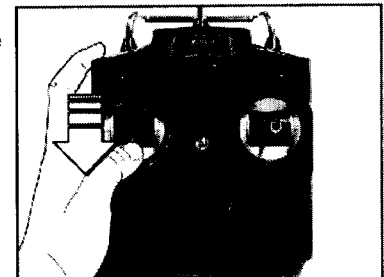

11. To start again, check the "Ready to fly" light pattern is ready. (pic.a)

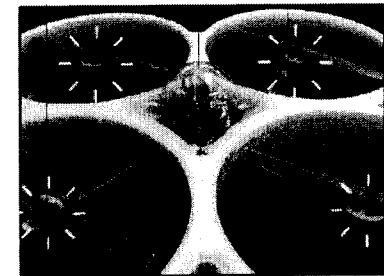
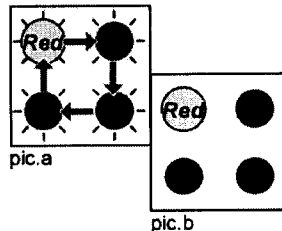

If you find the light pattern is in "Waiting for Reset" mode, (pic.b) please pull the Throttle Stick of the Transmitter upward for 1 sec and then downward again in order to reset the X-UFO. Once you can obtain the "Ready to fly" light pattern, you can start to fly your X-UFO again.

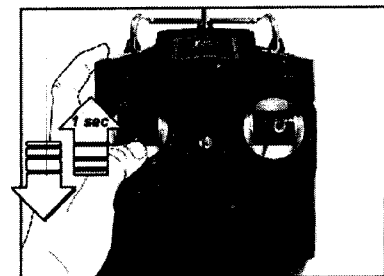

7. Environment For Flight

7.1 Indoor Environment

1. X-UFO will have relatively better performance while playing indoor. For beginners, we recommend you first practice to fly your X-UFO indoor.
2. Avoid your X-UFO fly near any electric fan, air-conditioner and easy broken utensils while playing indoor.
3. Keep the X-UFO away from people and pets at home.

7.2 Outdoor Environment

1. It is highly recommended to fly in a sunny day and slight breeze (Esp. no more than Beaufort scale 3-gentle breeze)
2. Keep away from trees, power station, electric wire or any potential dangerous area.
3. Avoid your X-UFO fly near people or vehicles passing by.

8. Flight Technique & Tips

1. The Gyro located inside the X-UFO is a mechanical design device. A rapid sideway movement will cause the Gyro difficult to control. It is important to operate the control stick of your Transmitter smoothly and gently. Do not pull the control stick quickly at any directions at any time when you start to flight or landing your X-UFO.
2. After Landing, we recommend you to turn off the X-UFO. It helps to make your Gyro become stable and prepare for the next fly.
3. When you start to fly your X-UFO, make sure the height is between 50cm to 150cm from the floor to obtain a more stable condition to practice your flight.
4. If the tilt angle of X-UFO is more than 20 degree, the gyro will start to oscillate and it may no longer to maintain the stability of X-UFO. Crashing of X-UFO is result.

Table 1.0

No	LED	DESCRIPTION
1	front - right - back- left (running in constant speed)	Gyro powering up / UFO initializing, please wait
2	front/back - left/right	No RF transmitter found. Waiting for valid RF signal
3	front - right - back(long) - left	UFO is ready to fly or already flying
4	front - right - back(blinking twice) - left	UFO's battery gets empty. You have about 20-30 seconds to come down
5	all four lights are lit up and don't blink	Gyro is oscillating. Waiting until gyro is stable again. Push thrust up to full (hold it there for 1 sec) and back to zero, to power gyro up again
6	front and back lit up and don't blink	UFO waits until Gyro stops oscillating and will then power up again
7	all four lights blink 3 times	Gyro calibration mode successfully completed. New calibration data stored in EEPROM
8	all four lights blink 5 times	Factory settings restored
9	power LED not stable or even blinking	Battery power very low. Recharge or change UFO battery

5. "Table 1.0" shows the LED pattern of UFO.

6. User Calibration:

If the Gyro has minor damage, you can calibrate it as per following steps:

- Adjust the throttle to minimum and OFF the transmitter.
- Put your X-UFO on a horizontal surface.
- Switch on your X-UFO.
- Press Aux 1 button and Aux 2 button while power ON transmitter.
- While all 4 LED blinks 3 times, the calibration has been completed.

7. Restore factory setting:

If the stability is worse than before after calibration, you can either re-calibrate it as above or follow steps below to restore factory setting:

- Adjust the throttle to minimum and OFF the transmitter.
- Put your X-UFO on a horizontal surface.
- Switch on your X-UFO.
- Press Aux 3 button and Aux 4 button while power ON transmitter.
- While all 4 LED blinks 5 times, factory setting has been restored.

9. Repair & Maintenance

- Replacement parts can be purchased at the retailer shop only.

9.1 Repairing broken poly foam ring body

Use market available adhesives or epoxy system bonding agent for repair purpose (pic.1 & pic.2)

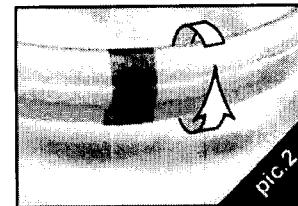
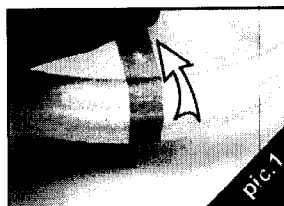

9.2 Replacement of propellers

1. Use a piler or screwdriver to lift up the ring. (pic.3)
2. Take out the broken or spoiled propeller as photo shown. (pic.4)
3. Check the direction of propeller before replacing a new one. (pic.5)

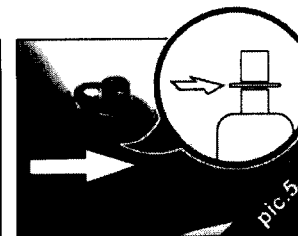
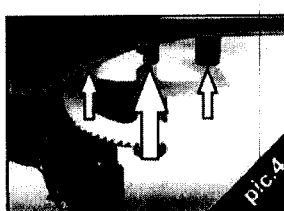
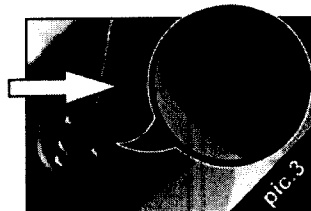

9.3 Replacement of poly foam ring body

Please check the instruction sheet attached in the poly foam ring body replacement package which sold separately in the retailer shop.

10. Trouble Shooting

Symptom	Cause	Correction
Propeller can't move.	<ul style="list-style-type: none"> • ON/OFF Switch is OFF. • Weak Battery. 	<ul style="list-style-type: none"> • Set switch to ON. • Re-charge the battery pack.
X-UFO turns around and descends after taking off.	<ul style="list-style-type: none"> • Weak Battery. • Trimmer is not in neutral position. 	<ul style="list-style-type: none"> • Re-charge the battery pack. • Tune the Trimmer on your transmitter.
Can't take off or drop down at flight.	<ul style="list-style-type: none"> • The wind is unsuitable for flying. • Weak power. • Mechanical gyro oscillating. 	<ul style="list-style-type: none"> • Move to another place or play in indoor. • Re-charge the battery pack. • Practice for more skills, such as tune the Trimmer for precise power control or stroke (not hold) the left control lever on transmitter. • Waiting until gyro is stable again. Push thrust up to full (hold it there for 1 sec) and back to zero, to power gyro up again.
Drop down at the climbing state or before take off.	<ul style="list-style-type: none"> • Weak power. • Unbalance of the body. 	<ul style="list-style-type: none"> • Re-charge the battery pack. • Try to re-place the battery pack in another orientation.
X-UFO does not react, or react poorly to operation by transmitter.	<ul style="list-style-type: none"> • High-frequency interference occurred near to high-voltage lines, transformers and some types of building. 	<ul style="list-style-type: none"> • Avoid these if possible, or choose another place to operate the X-UFO.
Loss of control.	<ul style="list-style-type: none"> • Another radio control X-UFO using the same frequency and channel is operated near your X-UFO. • Out of the control range of distance. 	<ul style="list-style-type: none"> • Move to another place where without radio frequency interference from another device. • Ensure the antenna is fully extended. The X-UFO fly up to 100 meters in open space.

11. Specification

Transmitter	
Channel	8
Crystal frequency	27.045MHz (Default) 27.195MHz (Default)
Modulation	FM(PPM)
Control range	Up to 100m
Battery low detection	Yes. Power LED blinks - half sec
Power saving mode	Yes. Power LED blinks- short on, long off

UFO	
Mechanical Gyro module	Yes
Gyro control	Roll and Pitch control
Receiver crystal frequency	26.590MHz (Default) 26.740MHz (Default)
Battery pack	12V, 350mAh NiMH

Smart Charger	
AC/DC adaptor output	18V, 1A
Automobile adaptor output	12V, 1.5A

Accessories	
Li-polymer battery pack	Optional
Li-polymer battery charger	Optional
Main motor	One pair
Crystal	Transmitter and receiver pair
Mechanical Gyro module	For 2D spatial control
Electro-mechanical gyro module	For 3D spatial control
Propellers	Clockwise and anti-clockwise type
Base station	Optional – X-UFO system upgrade is required