FCC Test Report

Report No.: AGC00931150402FE03

FCC ID : OYCBT048

APPLICATION PURPOSE : Original Equipment

PRODUCT DESIGNATION : Bluetooth speaker

BRAND NAME : N/A

MODEL NAME : BT048, BTXXX(X for A-Z and 0-9), SPB14 , MI-SPBXX (X for A-Z and 0-9), UB-SPBXX (X for A-Z and 0-9), AX410,BOOST, TT-CK05

CLIENT : Dongguan Taide Industrial Co., Ltd.

DATE OF ISSUE : May 18,2015

**STANDARD(S)
TEST PROCEDURE(S)** : FCC Part 15 Rules

REPORT VERSION : V1.0

Attestation of Global Compliance (Shenzhen) Co., Ltd



CAUTION:

This report shall not be reproduced except in full without the written permission of the test laboratory and shall not be quoted out of context.



Report Revise Record

Report Version	Revise Time	Issued Date	Valid Version	Notes
V1.0	/	May 18,2015	Valid	Original Report

TABLE OF CONTENTS

1. VERIFICATION OF CONFORMITY	4
2. GENERAL INFORMATION	5
2.1. PRODUCT DESCRIPTION	5
2.2. TABLE OF CARRIER FREQUENCYS	5
3. MEASUREMENT UNCERTAINTY.....	6
4. DESCRIPTION OF TEST MODES.....	6
5. SYSTEM TEST CONFIGURATION	7
5.1. CONFIGURATION OF EUT SYSTEM.....	7
5.2. EQUIPMENT USED IN EUT SYSTEM.....	7
5.3. SUMMARY OF TEST RESULTS.....	7
6. TEST FACILITY	8
7 ALL TEST EQUIPMENT LIST	8
8. RADIATED EMISSION	9
8.1TEST LIMIT.....	9
8.2. MEASUREMENT PROCEDURE.....	10
8.3. TEST SETUP.....	12
8.4. TEST RESULT(Worst modulation:GFSK).....	14
9. BAND EDGE EMISSION	27
9.1. MEASUREMENT PROCEDURE.....	27
9.2 TEST SETUP.....	27
9.3 RADIATED TEST RESULT(Worst modulation:GFSK)	28
10. 20DB BANDWIDTH.....	32
10.1. MEASUREMENT PROCEDURE.....	32
10.2. TEST SET-UP (BLOCK DIAGRAM OF CONFIGURATION)	32
10.3. LIMITS AND MEASUREMENT RESULTS.....	32
11. FCC LINE CONDUCTED EMISSION TEST	39
11.1. LIMITS OF LINE CONDUCTED EMISSION TEST	39
11.2. BLOCK DIAGRAM OF LINE CONDUCTED EMISSION TEST	39
11.3. PRELIMINARY PROCEDURE OF LINE CONDUCTED EMISSION TEST	40
11.4. FINAL PROCEDURE OF LINE CONDUCTED EMISSION TEST	40
11.5. TEST RESULT OF LINE CONDUCTED EMISSION TEST	41
APPENDIX A: PHOTOGRAPHS OF TEST SETUP	43
APPENDIX B: PHOTOGRAPHS OF EUT	45

1. VERIFICATION OF CONFORMITY

Applicant	Dongguan Taide Industrial Co., Ltd.
Address	Taide Technology Park, Jinfenghuang Industrial Distrial, Fenggang Town,Dongguan City,China
Manufacturer	Dongguan Taide Industrial Co., Ltd.
Address	Taide Technology Park, Jinfenghuang Industrial Distrial, Fenggang Town,Dongguan City,China
Product Designation	Bluetooth speaker
Brand Name	N/A
Test Model	BT048
Series Model	BTXXX(X for A-Z and 0-9), SPB14 , MI-SPBXX (X for A-Z and 0-9), UB-SPBXX (X for A-Z and 0-9), AX410,BOOST, TT-CK05
Different Description	All the same except for the model name
Date of test	May 14,2015 to May 15,2015
Deviation	None
Condition of Test Sample	Normal
Report Template	AGCRT-US-BR/RF

We hereby certify that:

The above equipment was tested by Compliance Certification Service(Shenzhen) Inc. The test data, data evaluation, test procedures, and equipment configurations shown in this report were made in accordance with the procedures given in ANSI C63.4 (2009) and the energy emitted by the sample EUT tested as described in this report is in compliance with radiated emission limits of FCC Rules Part 15.249.

Prepared By

Time Huang

Time Huang May 18,2015

Checked By

Forrest Lei

Forrest Lei May 18,2015

Authorized By

Solger Zhang

Solger Zhang May 18,2015

2. GENERAL INFORMATION

2.1. PRODUCT DESCRIPTION

A major technical description of EUT is described as following

Operation Frequency	2.402 GHz to 2.480GHz
RF Output Power	3.77dBm(Max)
Bluetooth Version	V2.1+EDR
Modulation	GFSK, $\pi/4$ -DQPSK, 8DPSK
Number of channels	79
Hardware Version	V1.0
Software Version	V1.0
Antenna Designation	PCB Antenna (Met 15.203 Antenna requirement)
Antenna Gain	0dBi
Power Supply	DC3.7V by battery

Note: The USB port only used for charging and can't be used to transfer data with PC.

2.2. TABLE OF CARRIER FREQUENCIES

Frequency Band	Channel Number	Frequency
2400~2483.5MHZ	0	2402MHZ
	1	2403MHZ
	:	:
	38	2440 MHZ
	39	2441 MHZ
	40	2442 MHZ
	:	:
	77	2479 MHZ
	78	2480 MHZ

3. MEASUREMENT UNCERTAINTY

The reported uncertainty of measurement $y \pm U$, where expanded uncertainty U is based on a standard uncertainty multiplied by a coverage factor of $k=2$, providing a level of confidence of approximately 95 %.

No.	Item	Uncertainty
1	Conducted Emission Test	± 3.18 dB
2	All emissions, radiated	± 3.91 dB
3	Temperature	± 0.5 °C
4	Humidity	± 2 %

4. DESCRIPTION OF TEST MODES

NO.	TEST MODE DESCRIPTION
1	Low channel GFSK
2	Middle channel GFSK
3	High channel GFSK
4	Low channel $\pi/4$ -DQPSK
5	Middle channel $\pi/4$ -DQPSK
6	High channel $\pi/4$ -DQPSK
7	Low channel 8DPSK
8	Middle channel 8DPSK
9	High channel 8DPSK
10	Normal operation (BT)

Note:

- All the test modes can be supply by battery, only the result of the worst case was recorded in the report, if no other cases.
- For Radiated Emission, 3axis were chosen for testing for each applicable mode.

5. SYSTEM TEST CONFIGURATION

5.1. CONFIGURATION OF EUT SYSTEM

Configure 1: (Normal hopping)

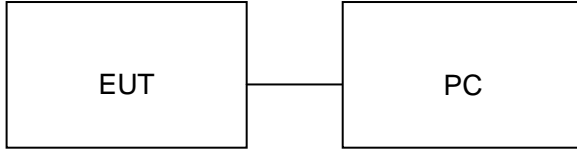

Configure 2: (Control continuous TX)

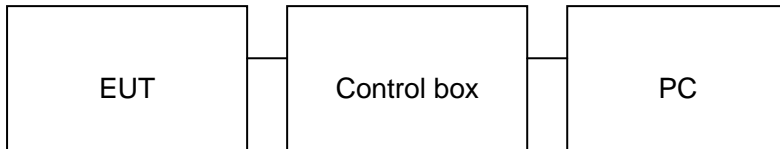

5.2. EQUIPMENT USED IN EUT SYSTEM

Item	Equipment	Model No.	ID or Specification	Remark
1	Bluetooth speaker	N/A	BT048	EUT
2	Control box	N/A	N/A	A.E
3	PC	Dell	INSPIRON	A.E

5.3. SUMMARY OF TEST RESULTS

FCC RULES	DESCRIPTION OF TEST	RESULT
§15.249	Radiated Emission	Compliant
§15.249	Band Edges	Compliant
§15.207	Conduction Emission	Compliant
N/A	BANDWIDTH	Compliant

6. TEST FACILITY

Site	Compliance Certification Service(Shenzhen) Inc.
Location	No.10-1 Mingkeda Logistics Park, No.18 Huanguan South RD. Guan lan Town,Baoan Distr
FCC Registration No.	441872
Description	The test site is constructed and calibrated to meet the FCC requirements in documents ANSI C63.4:2009.

7 ALL TEST EQUIPMENT LIST

Radiated Emission Test Site 966(2)					
Name of Equipment	Manufacturer	Model Number	Serial Number	Last Calibration	Due Calibration
PSA Series Spectrum Analyzer	Agilent	E4446A	US44300399	03/01/2015	03/01/2016
EMI TEST RECEIVER	ROHDE&SCHWARZ	ESCI	100783	03/09/2015	03/08/2016
Amplifier	MITEQ	AM-1604-3000	1123808	03/18/2015	03/17/2016
High Noise Amplifier	Agilent	8449B	3008A01838	03/18/2015	03/17/2016
Board-Band Horn Antenna	Schwarzbeck	BBHA 9170	9170-497	07/10/2014	07/09/2015
Bilog Antenna	SCHAFFNER	CBL6143	5082	03/01/2015	03/01/2016
Horn Antenna	SCHWARZBECK	BBHA9120	D286	03/01/2015	03/01/2016
Loop Antenna	COM-POWER	AL-130	121044	09/27/2014	09/26/2015
Turn Table	N/A	N/A	N/A	N.C.R	N.C.R
Controller	Sunol Sciences	SC104V	022310-1	N.C.R	N.C.R
Controller	CT	N/A	N/A	N.C.R	N.C.R
Temp. / Humidity Meter	Anymetre	JR913	N/A	02/28/2015	02/27/2016
Antenna Tower	SUNOL	TLT2	N/A	N.C.R	N.C.R
Test S/W	FARAD	LZ-RF / CCS-SZ-3A2			

Conducted Emission Test Site					
Name of Equipment	Manufacturer	Model Number	Serial Number	Last Calibration	Due Calibration
EMI TEST RECEIVER	ROHDE&SCHWARZ	ESCI	100783	03/09/2015	03/08/2016
LISN(EUT)	ROHDE&SCHWARZ	ENV216	101543-WX	03/09/2015	03/08/2016
LISN	EMCO	3825/2	8901-1459	03/09/2015	03/08/2016
Temp. / Humidity Meter	VICTOR	HTC-1	N/A	03/04/2015	03/03/2016
Test S/W	FARAD	EZ-EMC/ CCS-3A1-CE			

8. RADIATED EMISSION

8.1 TEST LIMIT

Standard FCC15.249

Fundamental Frequency	Field Strength of Fundamental (millivolts/meter)	Field Strength of Harmonics (microvolts/meter)
900-928MHz	50	500
2400-2483.5MHz	50	500
5725-5875MHz	50	500
24.0-24.25GHz	250	2500

Standard FCC 15.209

Frequency (MHz)	Distance Meters	Field Strengths Limit	
		μ V/m	dB(μ V)/m
0.009 ~ 0.490	300	2400/F(kHz)	---
0.490 ~ 1.705	30	24000/F(kHz)	---
1.705 ~ 30	30	30	---
30 ~ 88	3	100	40.0
88 ~ 216	3	150	43.5
216 ~ 960	3	200	46.0
960 ~ 1000	3	500	54.0
Above 1000	3	Other:74.0 dB(μ V)/m (Peak) 54.0 dB(μ V)/m (Average)	

Remark: (1) Emission level $\text{dB}\mu\text{V} = 20 \log \text{Emission level } \mu\text{V/m}$
(2) The smaller limit shall apply at the cross point between two frequency bands.
(3) Distance is the distance in meters between the measuring instrument, antenna and the closest point of any part of the device or system.

8.2. MEASUREMENT PROCEDURE

1. Configure the EUT according to ANSI C63.4. The EUT was placed on the top of the turntable 0.8 meter above ground. The phase center of the receiving antenna mounted on the top of a height-variable antenna tower was placed 3 meters far away from the turntable.
2. Power on the EUT and all the supporting units. The turntable was rotated by 360 degrees to determine the position of the highest radiation.
3. The height of the broadband receiving antenna was varied between one meter and four meters above ground to find the maximum emissions field strength of both horizontal and vertical polarization.
4. For each suspected emissions, the antenna tower was scan (from 1 M to 4 M) and then the turntable was rotated (from 0 degree to 360 degrees) to find the maximum reading.
5. Set the test-receiver system to Peak or CISPR quasi-peak Detect Function with specified bandwidth under Maximum Hold Mode.
6. For emissions above 1GHz, use 1MHz VBW and RBW for peak reading. Then 1MHz RBW and 10Hz VBW for average reading in spectrum analyzer.
7. When the radiated emissions limits are expressed in terms of the average value of the emissions, and pulsed operation is employed, the measurement field strength shall be determined by averaging over one complete pulse train, including blanking intervals, as long as the pulse train does not exceed 0.1 seconds. As an alternative (provided the transmitter operates for longer than 0.1 seconds) or in cases where the pulse train exceeds 0.1 seconds, the measured field strength shall be determined from the average absolute voltage during a 0.1 second interval during which the field strength is at its maximum values.
8. If the emissions level of the EUT in peak mode was 3 dB lower than the average limit specified, then testing will be stopped and peak values of EUT will be reported, otherwise, the emissions which do not have 3 dB margin will be repeated one by one using the quasi-peak method for below 1GHz.
9. For testing above 1GHz, the emissions level of the EUT in peak mode was lower than average limit (that means the emissions level in peak mode also complies with the limit in average mode), then testing will be stopped and peak values of EUT will be reported, otherwise, the emissions will be measured in average mode again and reported.
10. In case the emission is lower than 30MHz, loop antenna has to be used for measurement and the recorded data should be QP measured by receiver. High - Low scan is not required in this case.

The following table is the setting of spectrum analyzer and receiver.

Spectrum Parameter	Setting
Start ~Stop Frequency	9KHz~150KHz/RB 200Hz for QP
Start ~Stop Frequency	150KHz~30MHz/RB 9KHz for QP
Start ~Stop Frequency	30MHz~1000MHz/RB 120KHz for QP
Start ~Stop Frequency	1GHz~26.5GHz 1MHz/1MHz for Peak, 1MHz/10Hz for Average

Receiver Parameter	Setting
Start ~Stop Frequency	9KHz~150KHz/RB 200Hz for QP
Start ~Stop Frequency	150KHz~30MHz/RB 9KHz for QP
Start ~Stop Frequency	30MHz~1000MHz/RB 120KHz for QP

8.3. TEST SETUP

Radiated Emission Test-Setup Frequency Below 30MHz

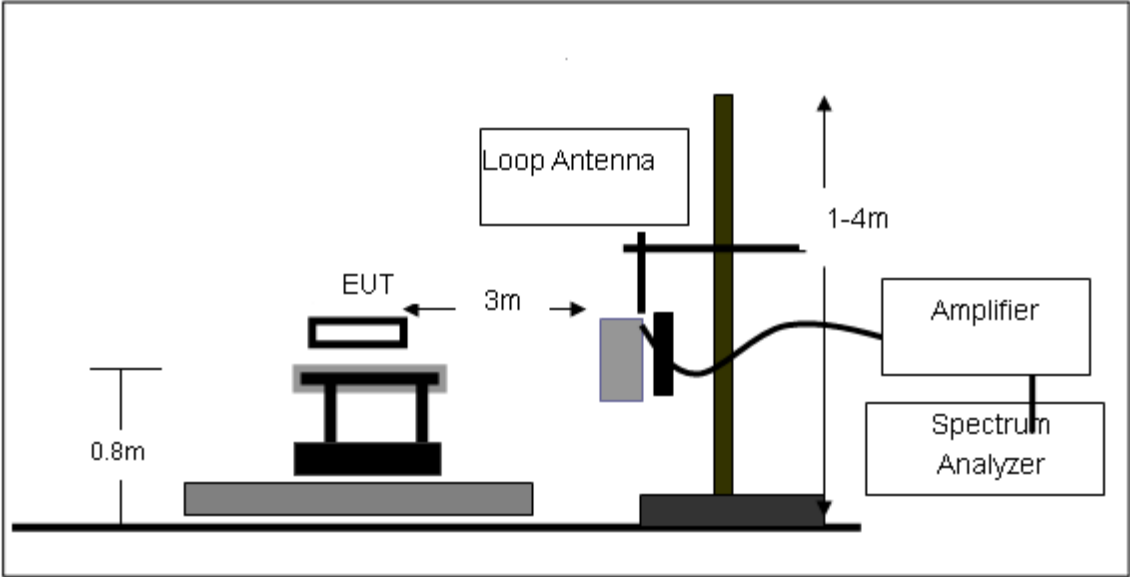

RADIATED EMISSION TEST SETUP 30MHz-1000MHz

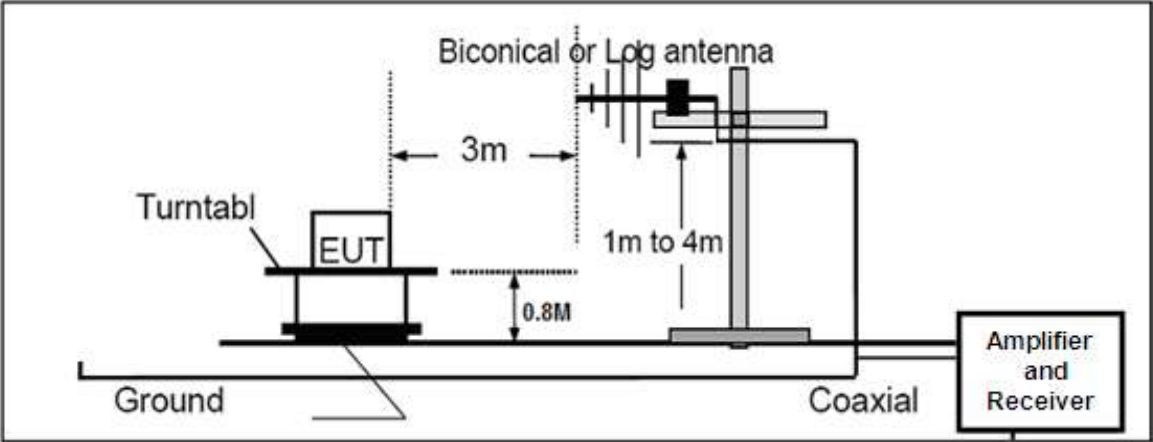

RADIATED EMISSION TEST SETUP ABOVE 1000MHz

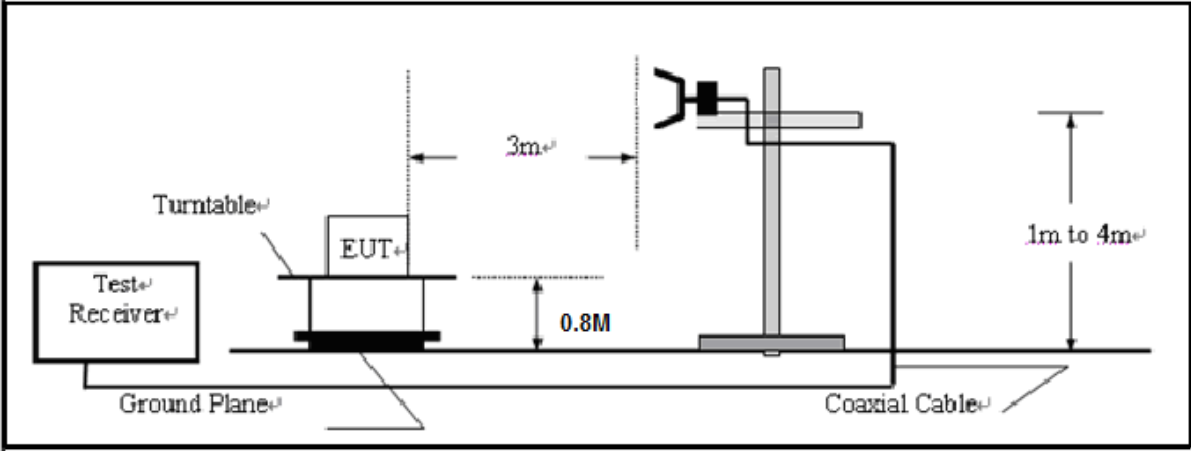

8.4. TEST RESULT(Worst modulation:GFSK)

RADIATED EMISSION BELOW 30MHZ

No emission found between lowest internal used/generated frequencies to 30MHz.

RADIATED EMISSION BELOW 1GHZ

RADIATED EMISSION TEST- (30MHZ-1GHZ)-LOW CHANNEL-HORIZONTAL

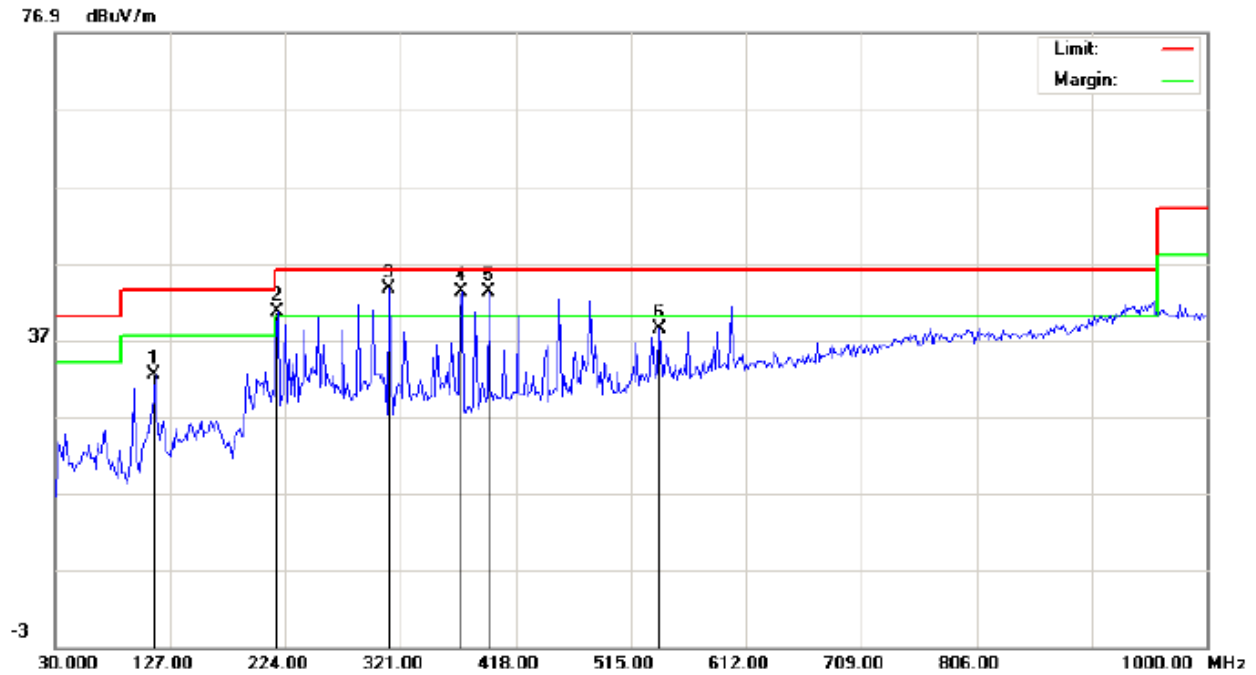

Site: site #1	Polarization: <i>Horizontal</i>	Temperature: 26
Limit: FCC Class B 3M Radiation	Power:	Humidity: 60 %
EUT: Bluetooth Speaker	Distance: 3m	
M/N: BT048		
Mode: Low Channel TX		
Note:		

No.	Mk	Freq.	Reading	Factor	Measurement	Limit	Over	Detector	Antenna Height	Table Degree	Comment
		MHz	dBuV	dB/m	dBuV/m	dBuV/m	dB		cm	degree	
1		114.0666	21.04	11.45	32.49	43.50	-11.01	peak			
2	!	217.5332	27.97	12.67	40.64	46.00	-5.36	peak			
3	*	311.3000	27.48	16.16	43.64	46.00	-2.36	peak			
4	!	372.7332	24.28	18.89	43.17	46.00	-2.83	peak			
5	!	395.3666	24.14	19.04	43.18	46.00	-2.82	peak			
6		539.2500	16.14	22.19	38.33	46.00	-7.67	peak			

RESULT: PASS

RADIATED EMISSION TEST- (30MHZ-1GHZ)-MIDDLE CHANNEL-HORIZONTAL

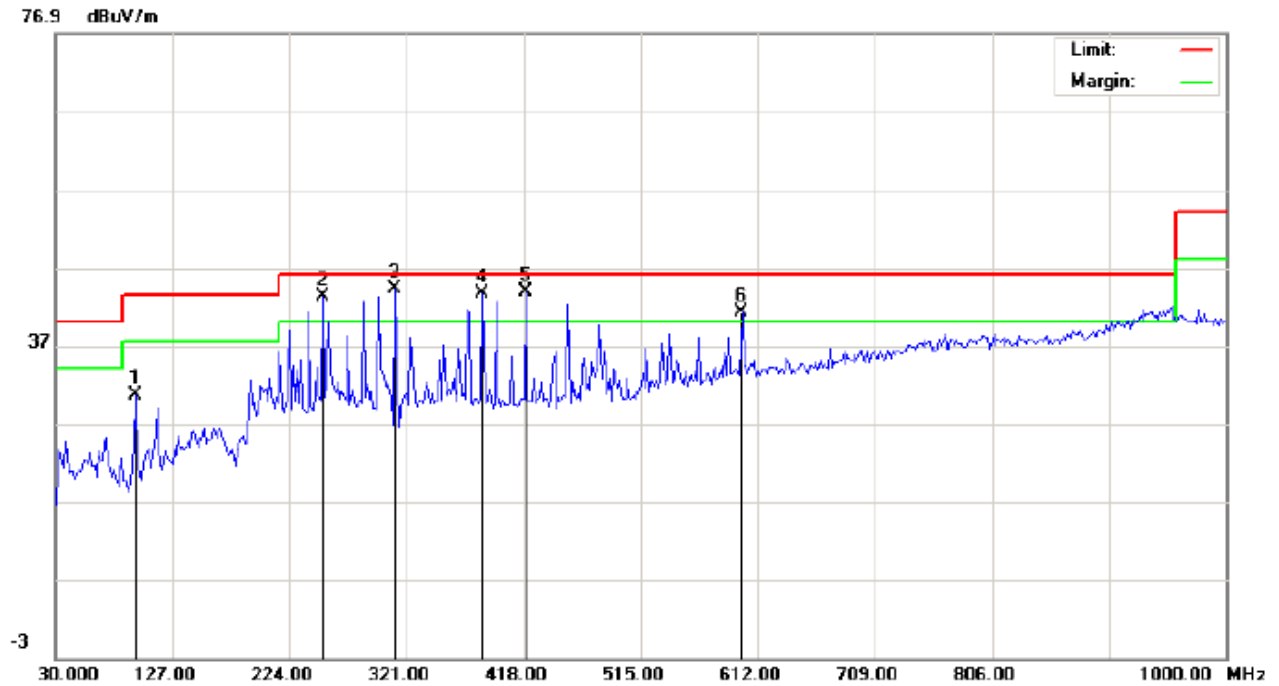

Site: site #1
Limit: FCC Class B 3M Radiation
EUT: Bluetooth Speaker
M/N: BT048
Mode: Middle Channel TX
Note:

Polarization: *Horizontal*
Power:
Distance: 3m

Temperature: 26
Humidity: 60 %

No.	Mk	Freq.	Reading	Factor	Measurement	Limit	Over	Detector	Antenna Height	Table Degree	Comment
		MHz	dBuV	dB/m	dBuV/m	dBuV/m	dB		cm	degree	
1		96.2831	20.55	10.07	30.62	43.50	-12.88	peak			
2	!	251.4833	29.28	13.94	43.22	46.00	-2.78	peak			
3	*	311.3000	27.98	16.16	44.14	46.00	-1.86	peak			
4	!	384.0500	24.59	18.96	43.55	46.00	-2.45	peak			
5	!	419.6166	24.05	19.67	43.72	46.00	-2.28	peak			
6	!	599.0666	17.54	23.71	41.25	46.00	-4.75	peak			

RESULT: PASS

RADIATED EMISSION TEST- (30MHZ-1GHZ)- MIDDLE CHANNEL -VERTICAL

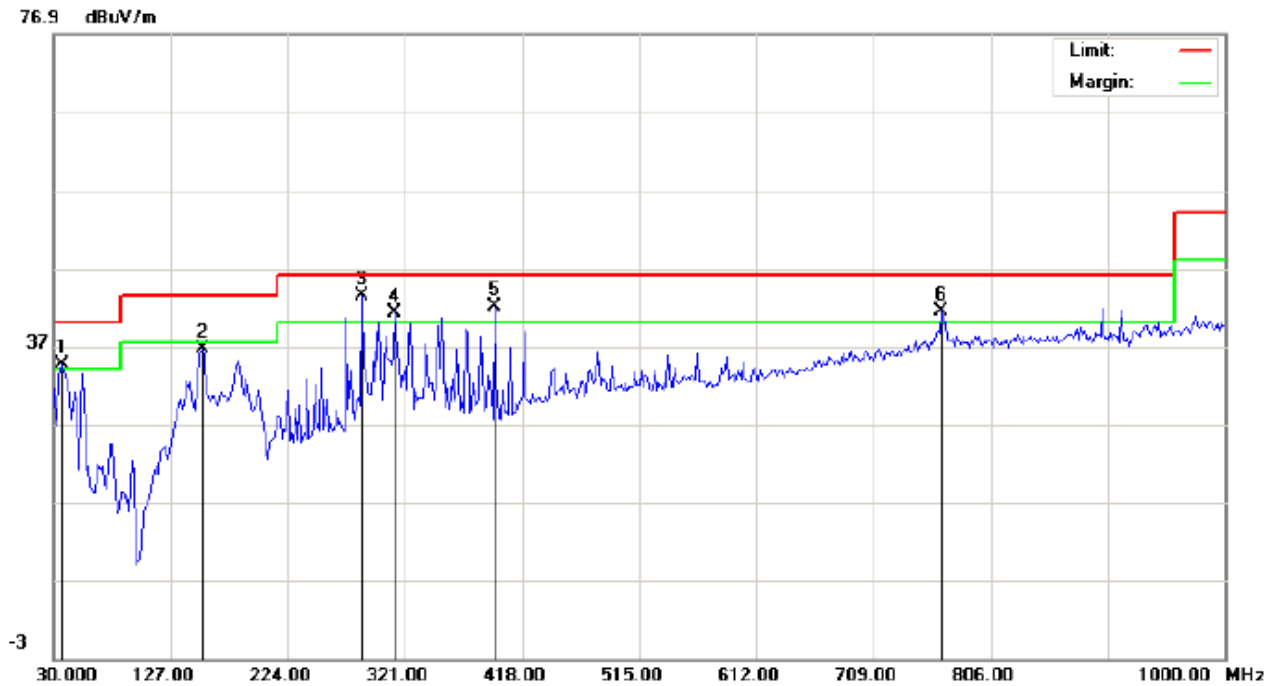

Site: site #1
Limit: FCC Class B 3M Radiation
EUT: Bluetooth Speaker
M/N: BT048
Mode: Middle Channel TX
Note:

Polarization: *Vertical*
Power:
Distance: 3m

Temperature: 26
Humidity: 60 %

No.	Mk	Freq.	Reading	Factor	Measurement	Limit	Over	Detector	Antenna Height	Table Degree	Comment
		MHz	dBuV	dB/m	dBuV/m	dBuV/m	dB		cm	degree	
1	!	36.4667	30.38	4.27	34.65	40.00	-5.35	peak			
2		152.8667	21.32	15.28	36.60	43.50	-6.90	peak			
3	*	285.4332	28.41	14.97	43.38	46.00	-2.62	peak			
4	!	312.9166	25.03	16.27	41.30	46.00	-4.70	peak			
5	!	395.3666	22.90	19.04	41.94	46.00	-4.06	peak			
6	!	765.5833	14.51	26.84	41.35	46.00	-4.65	peak			

RESULT: PASS

Note: 1. Factor=Antenna Factor + Cable loss, Margin=Measurement-Limit.

2. The "Factor" value can be calculated automatically by software of measurement system.

RADIATED EMISSION TEST- (30MHZ-1GHZ)-HIGH CHANNEL-HORIZONTAL

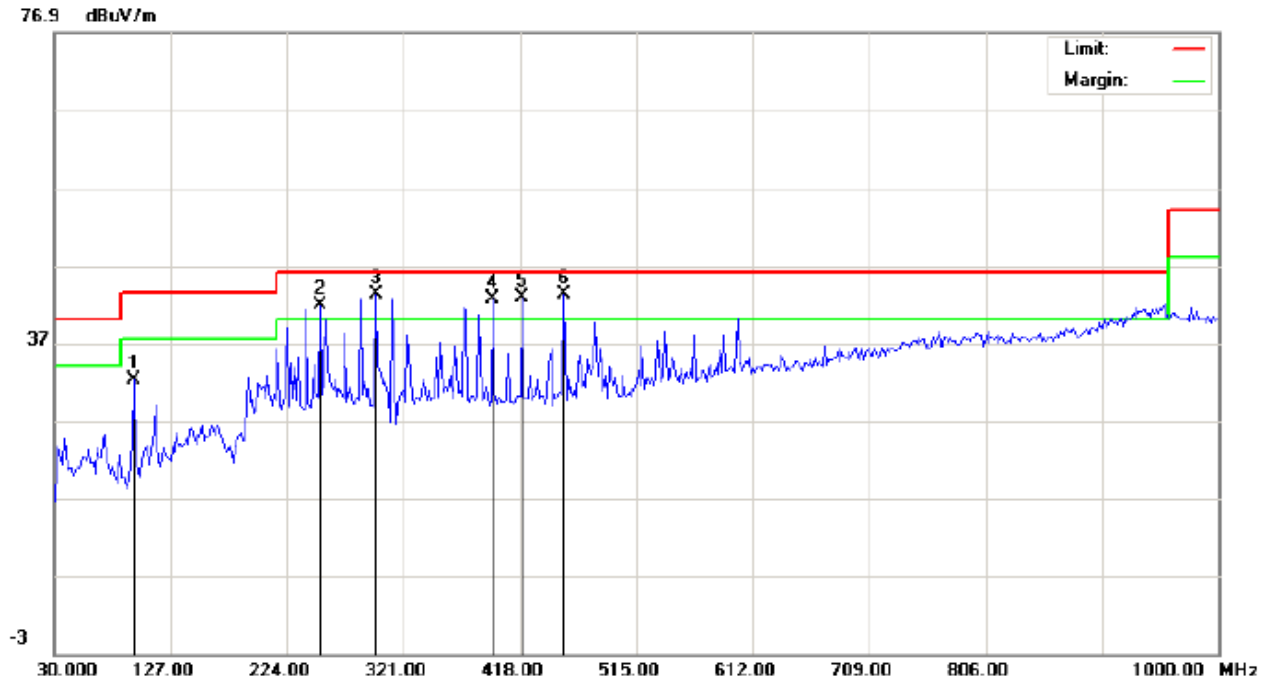

Site: site #1
Limit: FCC Class B 3M Radiation
EUT: Bluetooth Speaker
M/N: BT048
Mode: High Channel TX
Note:

Polarization: *Horizontal*
Power:
Distance: 3m

Temperature: 26
Humidity: 60 %

No.	Mk	Freq.	Reading	Factor	Measurement	Limit	Over	Detector	Antenna Height	Table Degree	Comment
		MHz	dBuV	dB/m	dBuV/m	dBuV/m	dB		cm	degree	
1		96.2831	22.05	10.07	32.12	43.50	-11.38	peak			
2	!	251.4833	27.78	13.94	41.72	46.00	-4.28	peak			
3	*	298.3666	27.88	15.36	43.24	46.00	-2.76	peak			
4	!	395.3666	23.64	19.04	42.68	46.00	-3.32	peak			
5	!	419.6166	23.05	19.67	42.72	46.00	-3.28	peak			
6	!	455.1832	22.56	20.65	43.21	46.00	-2.79	peak			

RESULT: PASS

RADIATED EMISSION TEST- (30MHZ-1GHZ)-HIGH CHANNEL -VERTICAL

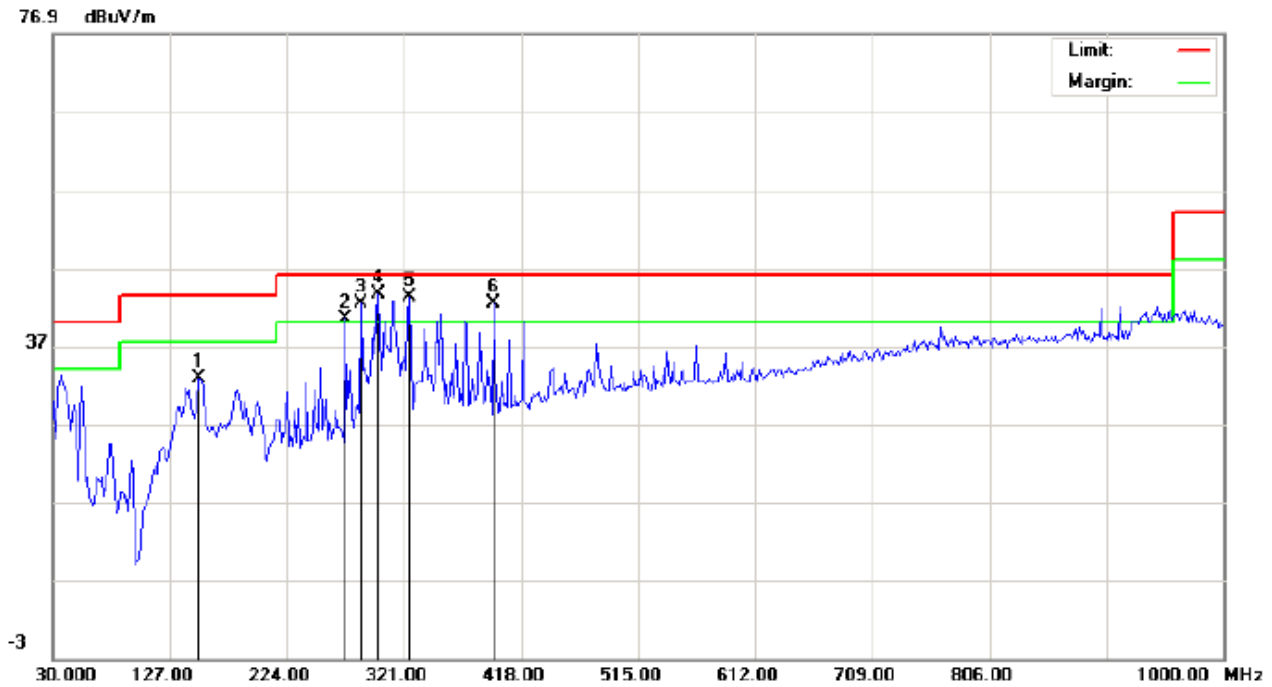

Site: site #1
Limit: FCC Class B 3M Radiation
EUT: Bluetooth Speaker
M/N: BT048
Mode: High Channel TX
Note:

Polarization: *Vertical*
Power:
Distance: 3m

Temperature: 26
Humidity: 60 %

No.	Mk	Freq.	Reading	Factor	Measurement	Limit	Over	Detector	Antenna Height	Table Degree	Comment
		MHz	dBuV	dB/m	dBuV/m	dBuV/m	dB		cm	degree	
1		151.2500	17.52	15.27	32.79	43.50	-10.71	peak			
2	!	272.5000	25.92	14.58	40.50	46.00	-5.50	peak			
3	!	285.4332	27.41	14.97	42.38	46.00	-3.62	peak			
4	*	299.9832	28.16	15.41	43.57	46.00	-2.43	peak			
5	!	325.8500	26.14	17.13	43.27	46.00	-2.73	peak			
6	!	395.3666	23.40	19.04	42.44	46.00	-3.56	peak			

RESULT: PASS

Note: 1. Factor=Antenna Factor + Cable loss, Margin=Measurement-Limit.

2. The "Factor" value can be calculated automatically by software of measurement system.

RADIATED EMISSION ABOVE 1GHZ

RADIATED EMISSION TEST- (ABOVE 1GHZ)-LOW CHANNEL-HORIZONTAL

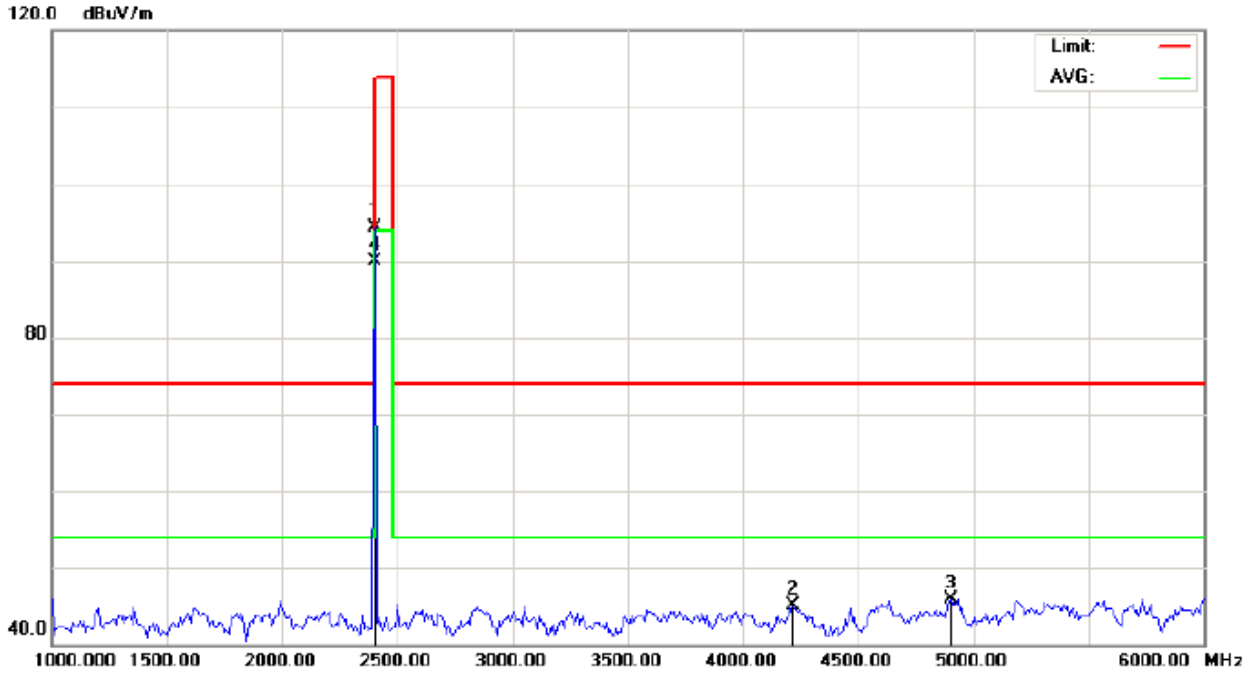

Site: site #1
Limit: FCC Class B 3M Radiation above 1GHZ(PK)-
EUT: Bluetooth Speaker
M/N: BT048
Mode: Low Channel TX
Note:

Polarization: *Horizontal*
Power:
Distance: 3m

Temperature: 26
Humidity: 60 %

No.	Mk	Freq.	Reading	Factor	Measurement	Limit	Over	Detector	Antenna Height	Table Degree	Comment
		MHz	dBuV	dB/m	dBuV/m	dBuV/m	dB		cm	degree	
1		2402.000	103.96	-9.68	94.28	114.00	-19.72	peak			
2		4216.667	49.08	-4.07	45.01	74.00	-28.99	peak			
3		4900.000	47.96	-2.06	45.90	74.00	-28.10	peak			
4	*	2402.000	99.51	-9.68	89.83	94.00	-4.17	AVG	150	146	

RESULT: PASS

RADIATED EMISSION TEST- (ABOVE 1GHZ)-LOW CHANNEL- VERTICAL

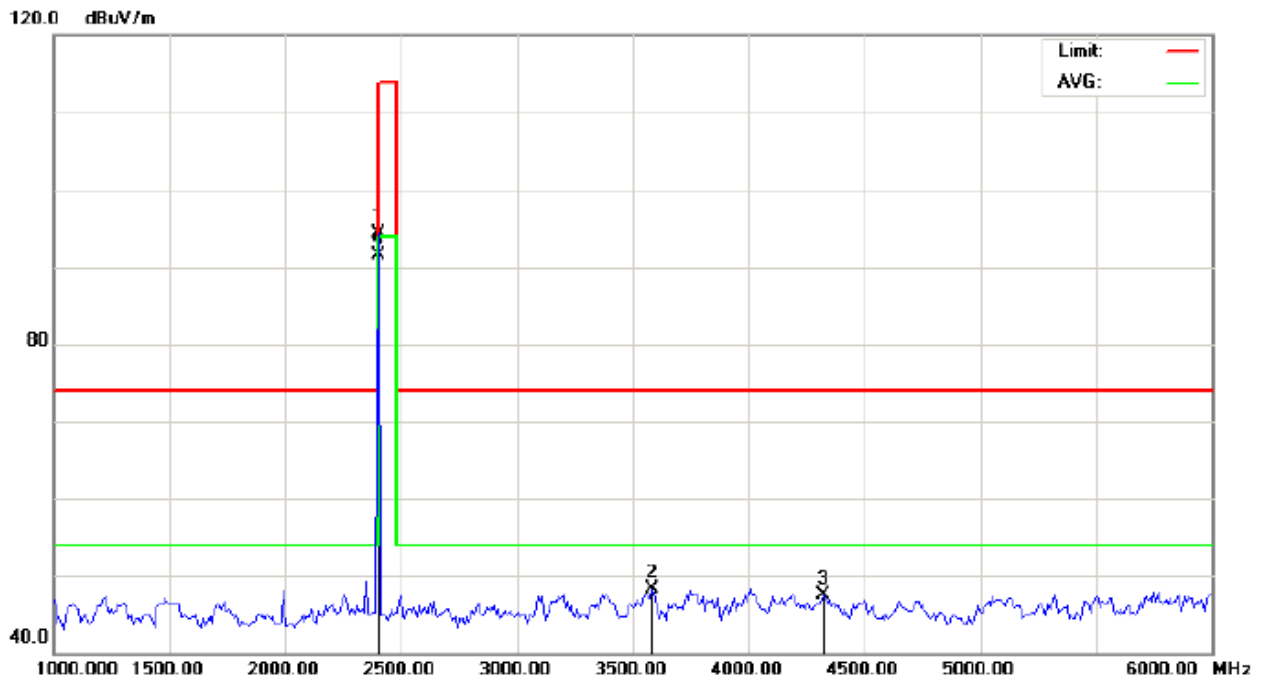

Site: site #1
Limit: FCC Class B 3M Radiation above 1GHZ(PK)-
EUT: Bluetooth Speaker
M/N: BT048
Mode: Low Channel TX
Note:

Polarization: *Vertical*
Power:
Distance: 3m

Temperature: 26
Humidity: 60 %

No.	Mk	Freq.	Reading	Factor	Measurement	Limit	Over	Detector	Antenna Height	Table Degree	Comment
		MHz	dBuV	dB/m	dBuV/m	dBuV/m	dB		cm	degree	
1		2402.000	104.06	-9.68	94.38	114.00	-19.62	peak			
2		3583.333	55.61	-7.38	48.23	74.00	-25.77	peak			
3		4325.000	51.23	-3.70	47.53	74.00	-26.47	peak			
4	*	2402.000	101.20	-9.68	91.52	94.00	-2.48	AVG	150	360	

RESULT: PASS

RADIATED EMISSION TEST- (ABOVE 1GHZ)-MIDDLE CHANNEL-HORIZONTAL

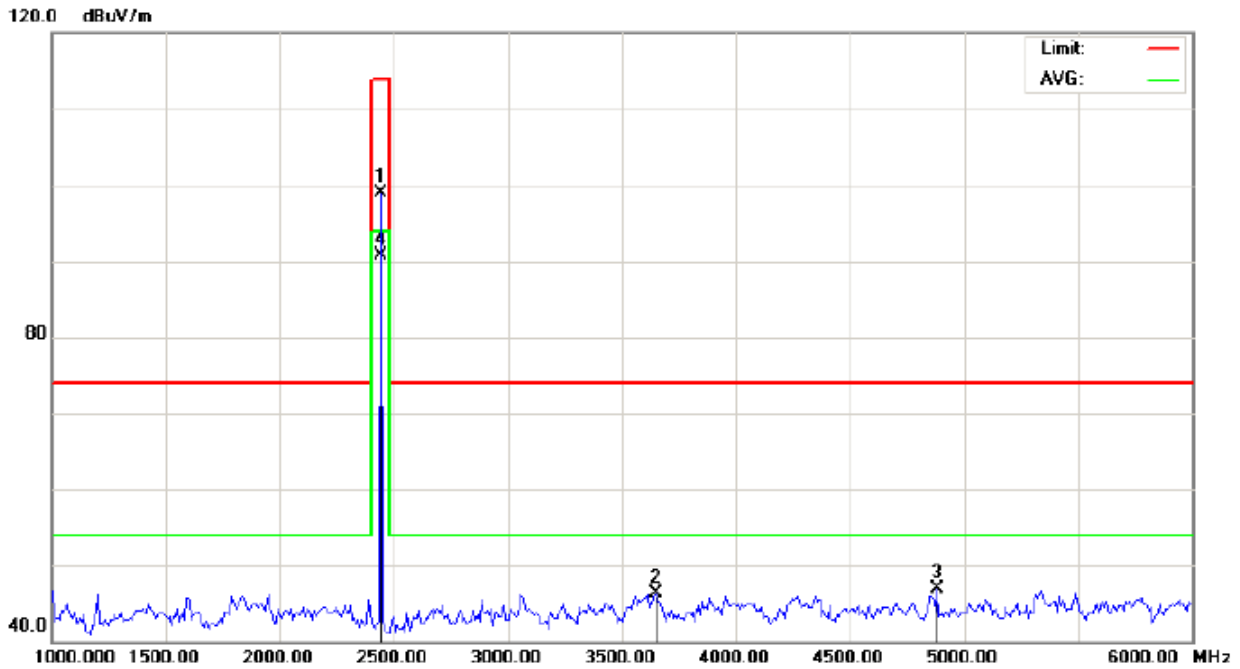

Site: site #1
 Limit: FCC Class B 3M Radiation above 1GHZ(PK)-
 EUT: Bluetooth Speaker
 M/N: BT048
 Mode: Middle Channel TX
 Note:

Polarization: *Horizontal*
 Power:
 Distance: 3m

Temperature: 26
 Humidity: 60 %

No.	Mk	Freq.	Reading	Factor	Measurement	Limit	Over	Detector	Antenna Height	Table Degree	Comment
		MHz	dBuV	dB/m	dBuV/m	dBuV/m	dB		cm	degree	
1		2441.000	108.50	-9.63	98.87	114.00	-15.13	peak			
2		3650.000	53.29	-6.97	46.32	74.00	-27.68	peak			
3		4883.333	48.94	-2.11	46.83	74.00	-27.17	peak			
4	*	2441.000	100.35	-9.63	90.72	94.00	-3.28	AVG	150	127	

RESULT: PASS

RADIATED EMISSION TEST- (ABOVE 1GHZ)-MIDDLE CHANNEL- VERTICAL

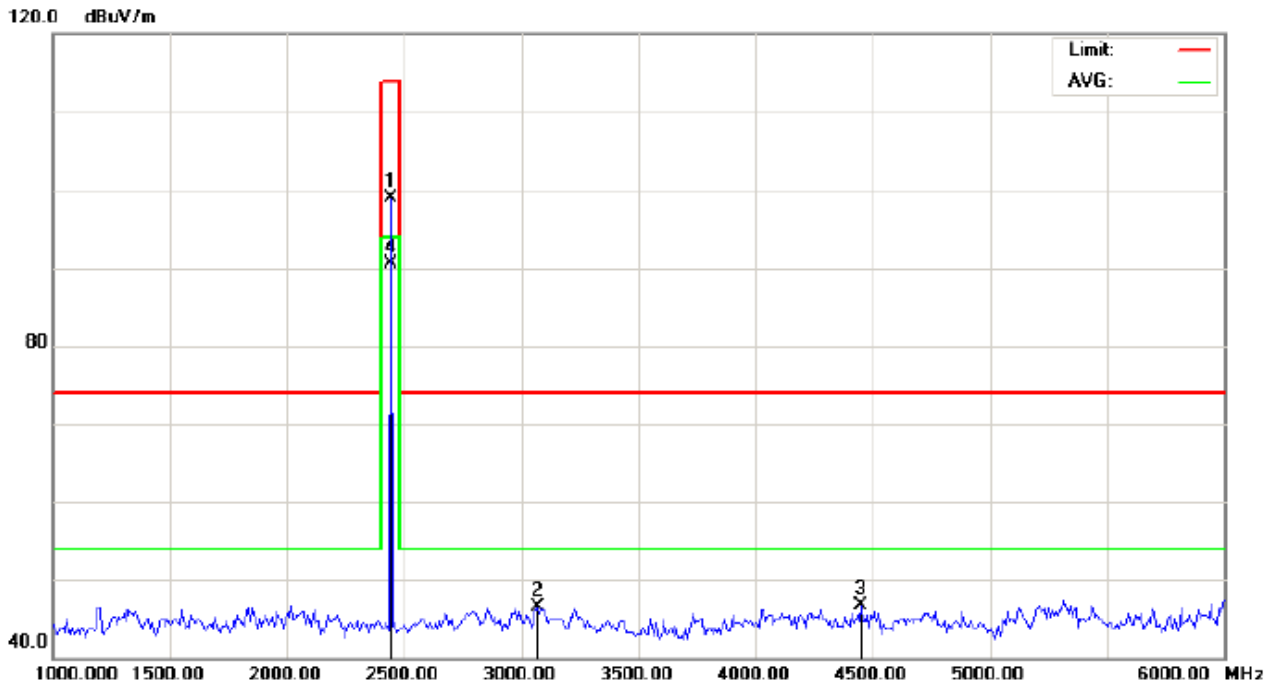

Site: site #1 Polarization: *Vertical* Temperature: 26
Limit: FCC Class B 3M Radiation above 1GHZ(PK)- Power: Humidity: 60 %
EUT: Bluetooth Speaker Distance: 3m
M/N: BT048
Mode: Middle Channel TX
Note:

No.	Mk	Freq.	Reading	Factor	Measurement	Limit	Over	Detector	Antenna Height	Table Degree	Comment
		MHz	dBuV	dB/m	dBuV/m	dBuV/m	dB		cm	degree	
1		2441.000	108.60	-9.63	98.97	114.00	-15.03	peak			
2		3066.667	54.83	-8.30	46.53	74.00	-27.47	peak			
3		4450.000	49.89	-3.28	46.61	74.00	-27.39	peak			
4	*	2441.000	100.18	-9.63	90.55	94.00	-3.45	AVG	150	228	

RESULT: PASS

RADIATED EMISSION TEST- (ABOVE 1GHZ)-HIGH CHANNEL-HORIZONTAL

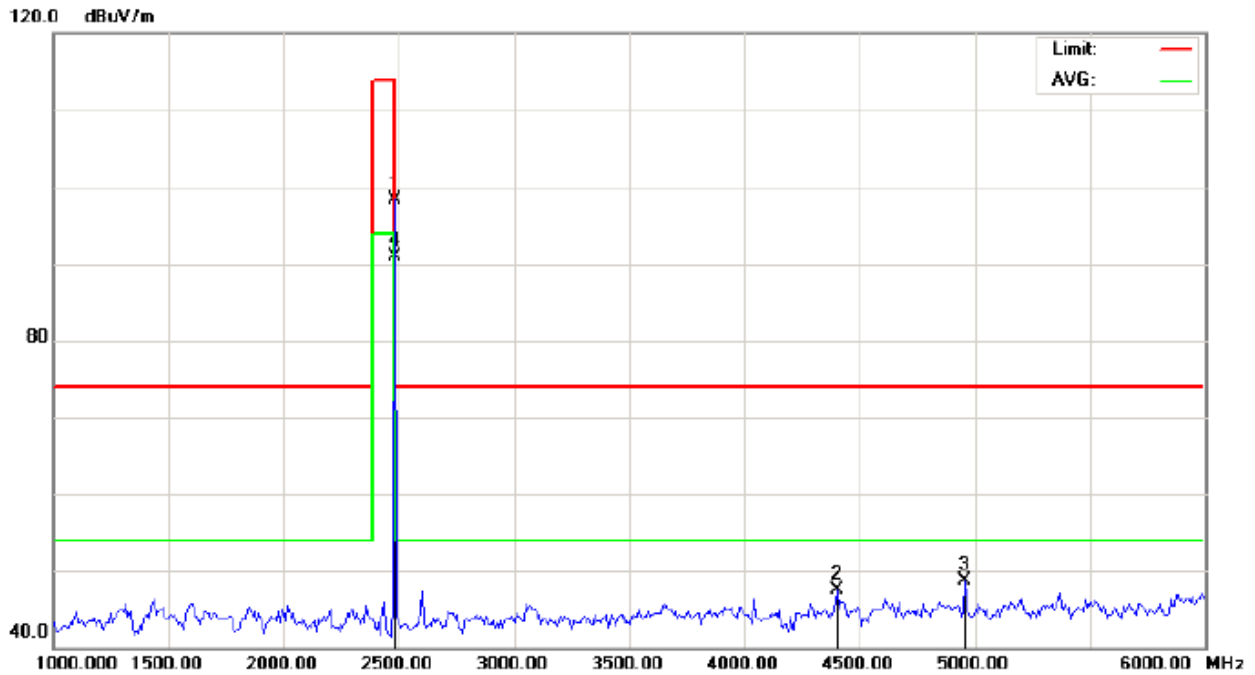

Site: site #1
Limit: FCC Class B 3M Radiation above 1GHZ(PK)-
EUT: Bluetooth Speaker
M/N: BT048
Mode: High Channel TX
Note:

Polarization: *Horizontal*
Power:
Distance: 3m

Temperature: 26
Humidity: 60 %

No.	Mk	Freq.	Reading	Factor	Measurement	Limit	Over	Detector	Antenna	Table	Comment
		MHz	dBuV	dB/m	dBuV/m	dBuV/m	dB		Height	Degree	
									cm	degree	
1		2480.000	107.97	-9.59	98.38	114.00	-15.62	peak			
2		4400.000	50.97	-3.45	47.52	74.00	-26.48	peak			
3		4958.333	50.54	-1.91	48.63	74.00	-25.37	peak			
4	*	2480.000	100.53	-9.59	90.94	94.00	-3.06	AVG	150	208	

RESULT: PASS

RADIATED EMISSION TEST- (ABOVE 1GHZ)-HIGH CHANNEL- VERTICAL

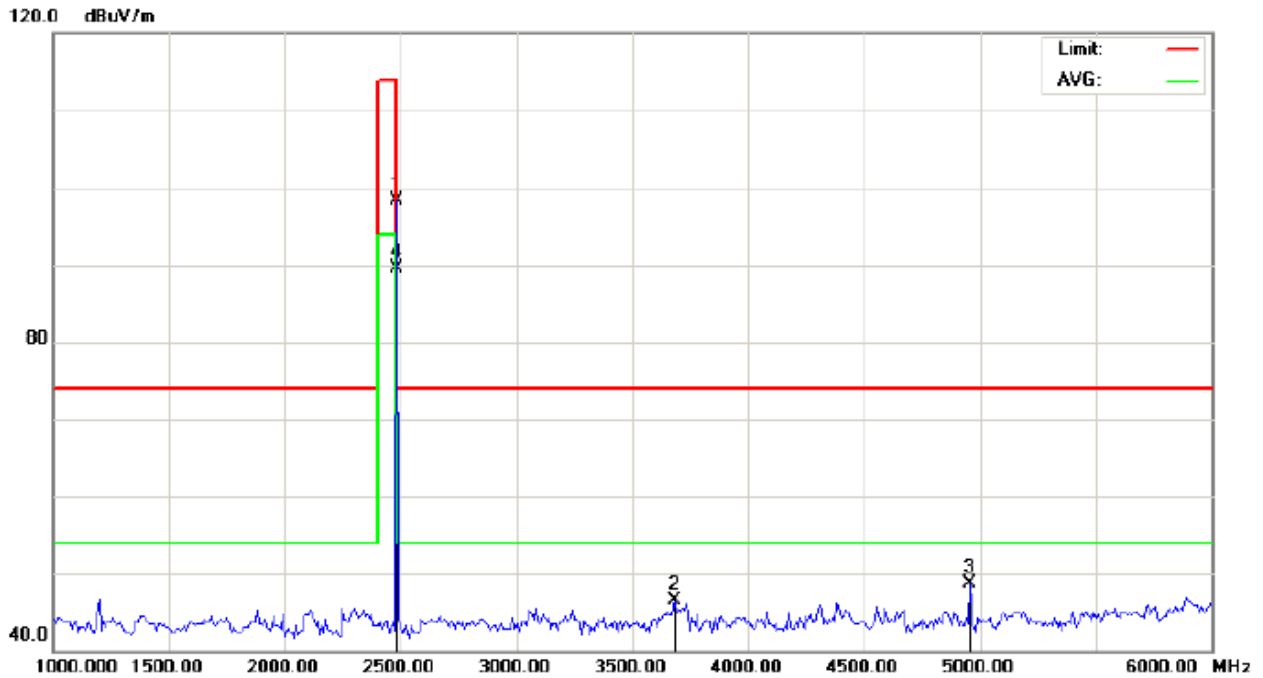

Site: site #1 Polarization: *Vertical* Temperature: 26
Limit: FCC Class B 3M Radiation above 1GHZ(PK)- Power: Humidity: 60 %
EUT: Bluetooth Speaker Distance: 3m
M/N: BT048
Mode: High Channel TX
Note:

No.	Mk	Freq.	Reading	Factor	Measurement	Limit	Over	Detector	Antenna Height	Table Degree	Comment
		MHz	dBuV	dB/m	dBuV/m	dBuV/m	dB		cm	degree	
1		2480.000	107.88	-9.59	98.29	114.00	-15.71	peak			
2		3683.333	53.20	-6.76	46.44	74.00	-27.56	peak			
3		4958.333	50.71	-1.91	48.80	74.00	-25.20	peak			
4	*	2480.000	99.11	-9.59	89.52	94.00	-4.48	AVG	150	314	

RESULT: PASS

Note: 6~25GHz at least have 20dB margin. No recording in the test report.

Factor=Antenna Factor + Cable loss - Amplifier gain, Margin=Measurement-Limit.

The "Factor" value can be calculated automatically by software of measurement system.

Field strength of the fundamental signal

Peak value

Frequency	Reading Level	Factor	Measurement	Limit	Over	Antenna
(MHz)	(dBuv)	(dB/m)	(dBuv/m)	(dBuv/m)	(dB)	Polarization
2402	103.96	-9.68	94.28	114	-19.72	Horizontal
2402	104.06	-9.68	94.38	114	-19.62	Vertical
2441	108.50	-9.63	98.87	114	-15.13	Horizontal
2441	108.60	-9.63	98.97	114	-15.03	Vertical
2480	107.97	-9.59	98.38	114	-15.62	Horizontal
2480	107.88	-9.59	98.29	114	-15.71	Vertical

Average value

Frequency	Reading Level	Factor	Measurement	Limit	Over	Antenna
(MHz)	(dBuv)	(dB/m)	(dBuv/m)	(dBuv/m)	(dB)	Polarization
2402	99.51	-9.68	89.83	94	-4.17	Horizontal
2402	101.20	-9.68	91.52	94	-2.48	Vertical
2441	100.35	-9.63	90.72	94	-3.28	Horizontal
2441	100.18	-9.63	90.55	94	-3.45	Vertical
2480	100.53	-9.59	90.94	94	-3.06	Horizontal
2480	99.11	-9.59	89.52	94	-4.48	Vertical

9. BAND EDGE EMISSION

9.1. MEASUREMENT PROCEDURE

1The EUT operates at hopping-off test mode. The lowest or highest channels are tested to verify the largest transmission and spurious emissions power at the continuous transmission mode.

2Max hold the trace of the setp 1,and the EUT operates at hopping-on test mode to verify the largest spurious emissions power.

3Set the spectrum analyzer in the following setting in order to capture the lower and upper band-edges of the emission: (a) PEAK: RBW=VBW=1MHz / Sweep=AUTO

(b) AVERAGE: RBW=1MHz ; VBW=1/on time(1KHz) / Sweep=AUTO

9.2 TEST SETUP

RADIATED EMISSION TEST SETUP

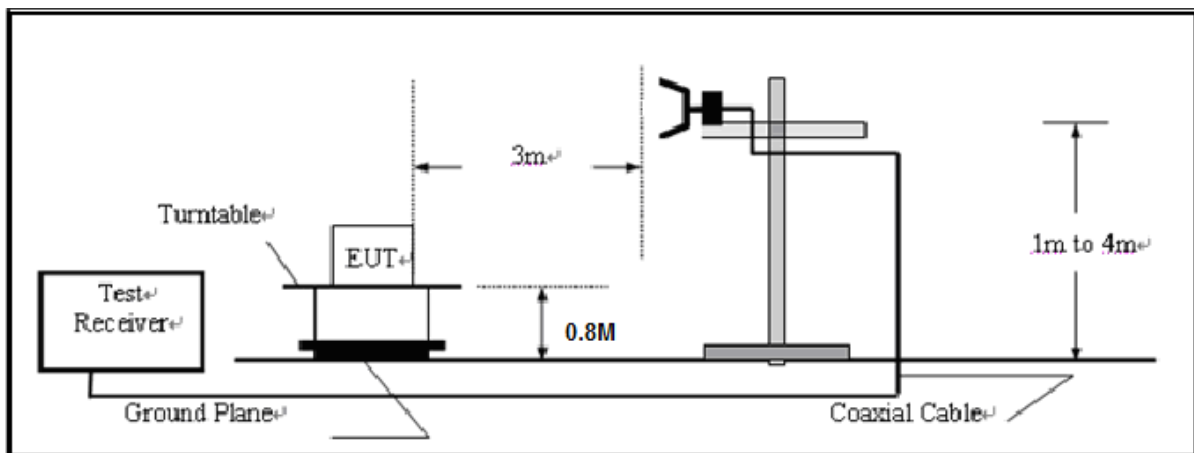

CONDUCTED TEST SETUP

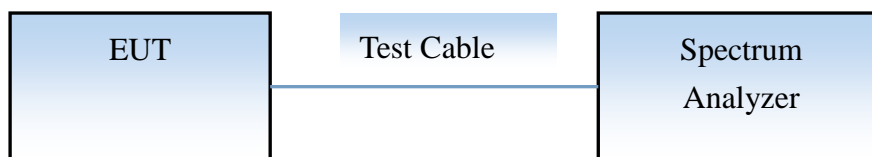

TEST PLOT OF BAND EDGE FOR LOW CHANNEL -Vertical

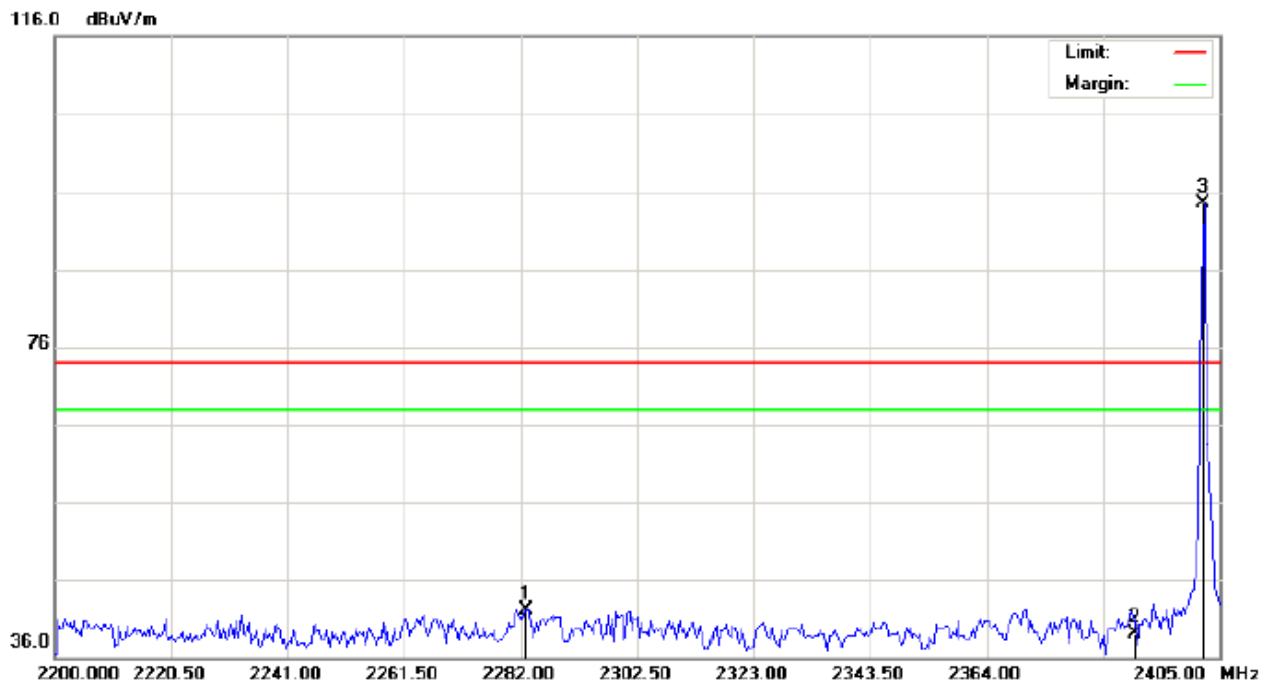

Site: site #1

Polarization: *Vertical*

Temperature: 26

Limit: FCC Class B 3M Radiation above 1GHZ(PK)

Power:

Humidity: 60 %

EUT: Bluetooth Speaker

Distance:

M/N: BT048

Mode: Low Channel TX

Note:

No.	Mk	Freq.	Reading	Factor	Measurement	Limit	Over	Detector	Antenna	Table	Comment
		MHz	dBuV	dB/m	dBuV/m	dBuV/m	dB		Height	Degree	
									cm	degree	
1		2283.025	31.94	10.19	42.13	74.00	-31.87	peak			
2		2390.000	28.85	10.31	39.16	74.00	-34.84	peak			
3	*	2402.000	84.26	10.32	94.58	74.00	20.58	peak			

10. 20DB BANDWIDTH

10.1. MEASUREMENT PROCEDURE

1. Connect EUT RF output port to the Spectrum Analyzer through an RF attenuator
2. Set the EUT Work on the top, the middle and the bottom operation frequency individually.
3. Set Span = approximately 2 to 3 times the 20 dB bandwidth, centered on a hopping channel
RBW \geq 1% of the 20 dB bandwidth, VBW \geq RBW; Sweep = auto; Detector function = peak
4. Set SPA Trace 1 Max hold, then View.

10.2. TEST SET-UP (BLOCK DIAGRAM OF CONFIGURATION)

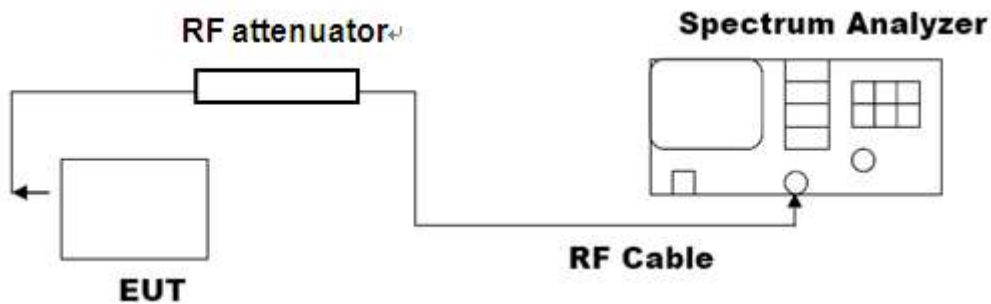

10.3. LIMITS AND MEASUREMENT RESULTS

BLUETOOTH 1MBPS LIMITS AND MEASUREMENT RESULT			
Applicable Limits	Measurement Result		
	Test Data (MHz)		Criteria
N/A	Low Channel	0.945	PASS
	Middle Channel	0.904	PASS
	High Channel	0.947	PASS

TEST PLOT OF BANDWIDTH FOR LOW CHANNEL

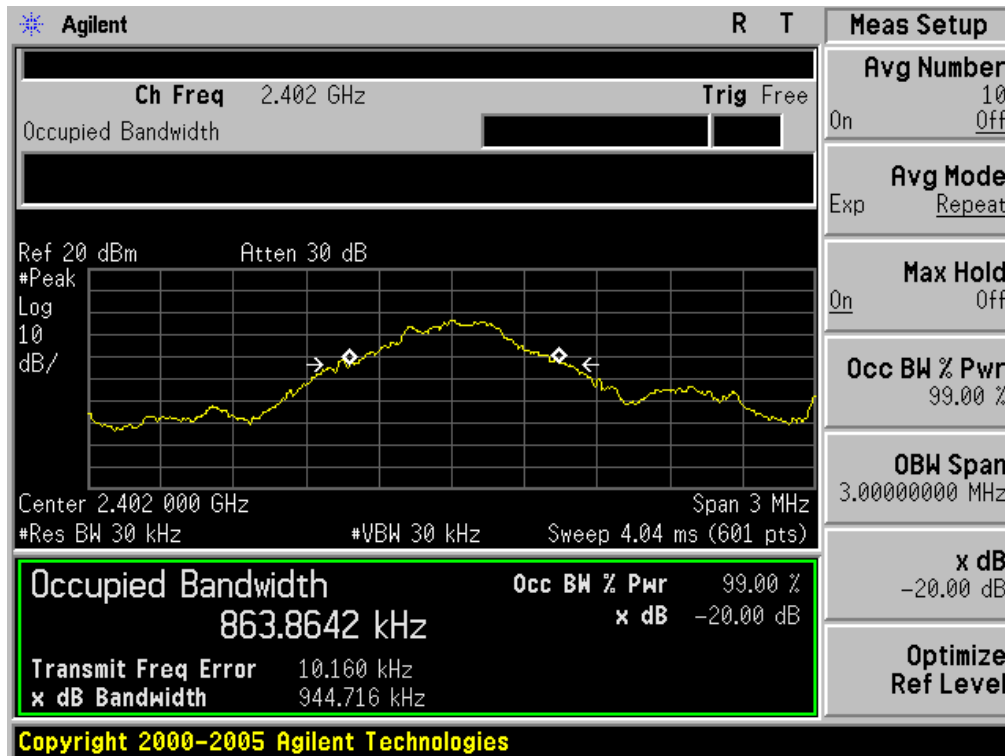

TEST PLOT OF BANDWIDTH FOR MIDDLE CHANNEL

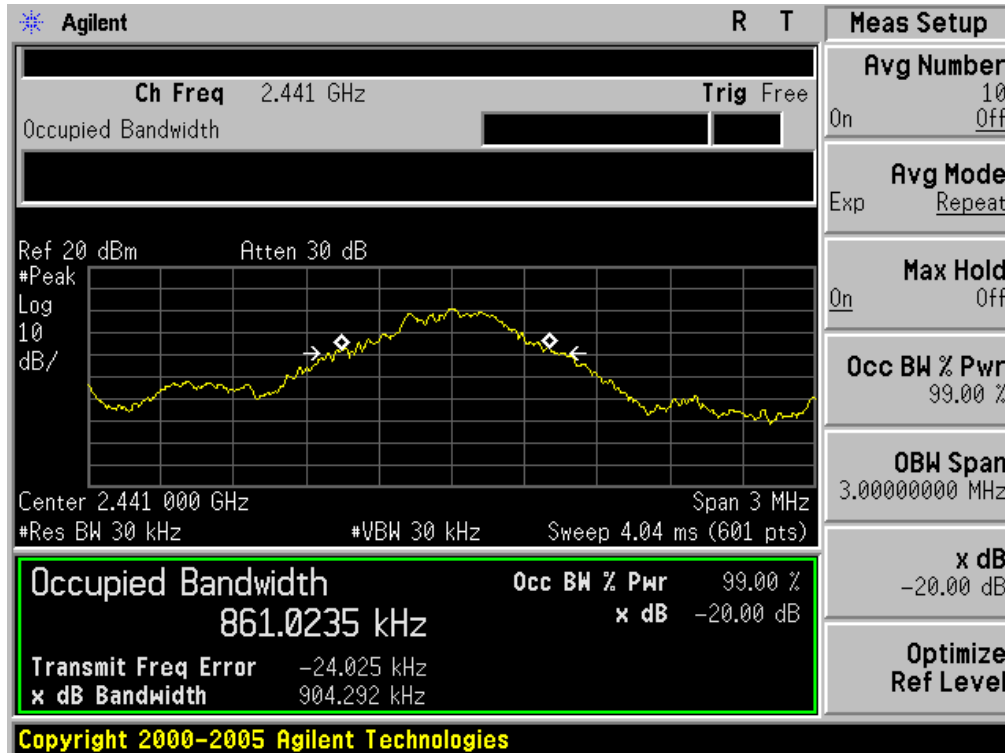

TEST PLOT OF BANDWIDTH FOR HIGH CHANNEL

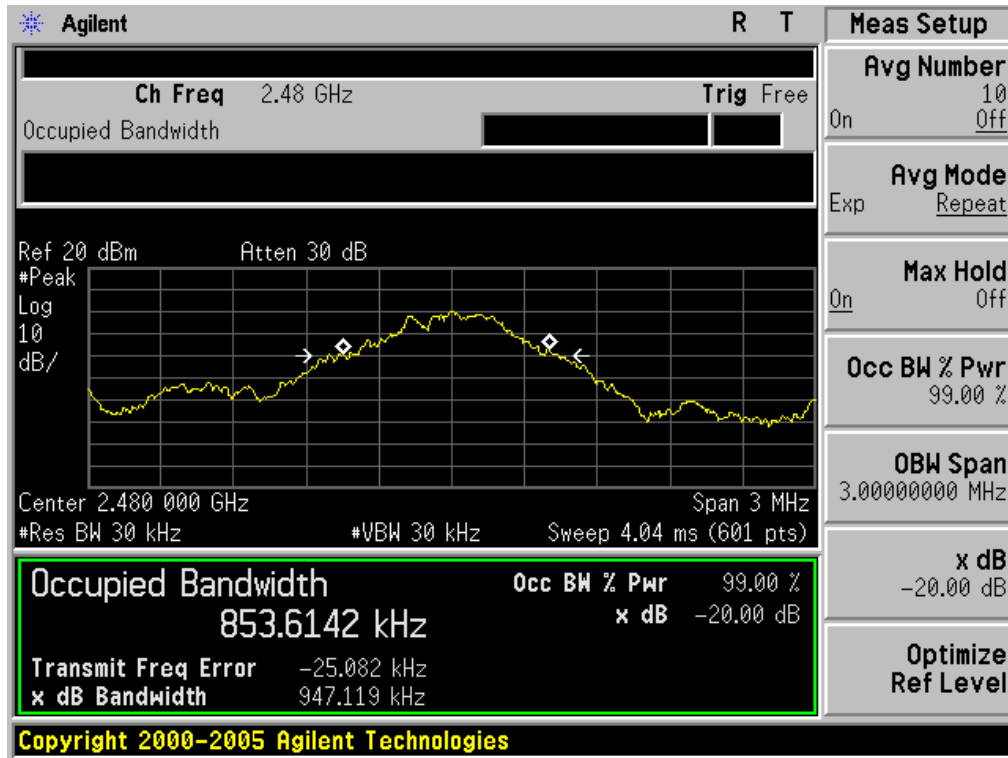

BLUETOOTH 2Mbps LIMITS AND MEASUREMENT RESULT			
Applicable Limits	Measurement Result		
	Test Data (MHz)		Criteria
N/A	Low Channel	1.296	PASS
	Middle Channel	1.278	PASS
	High Channel	1.284	PASS

TEST PLOT OF BANDWIDTH FOR LOW CHANNEL

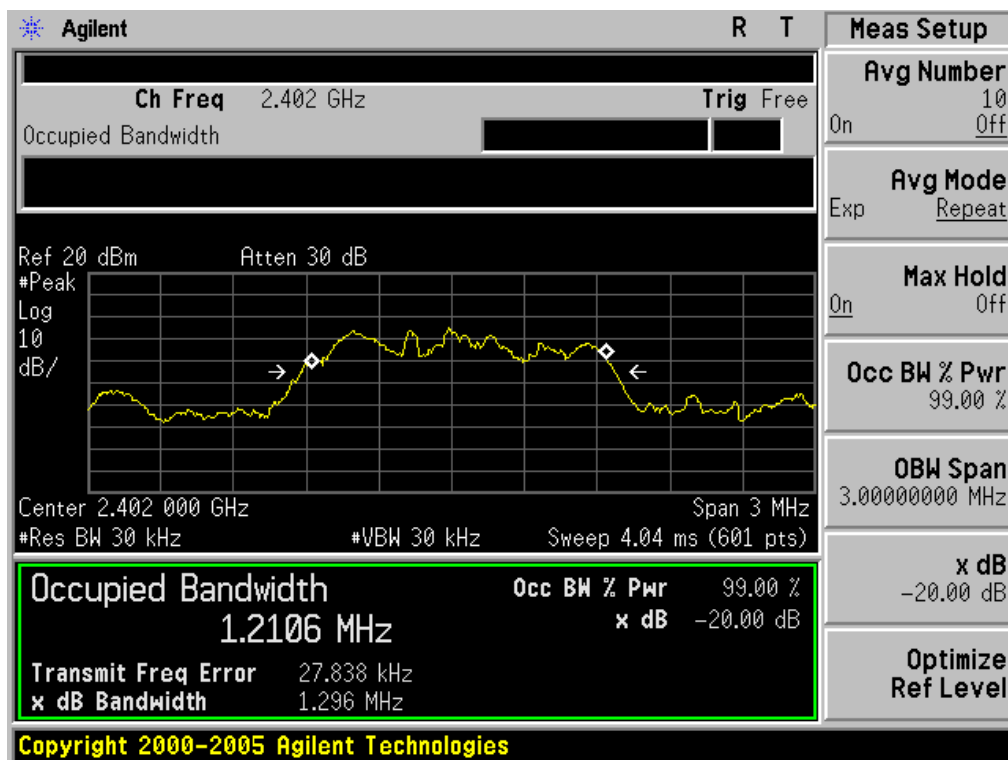

TEST PLOT OF BANDWIDTH FOR MIDDLE CHANNEL

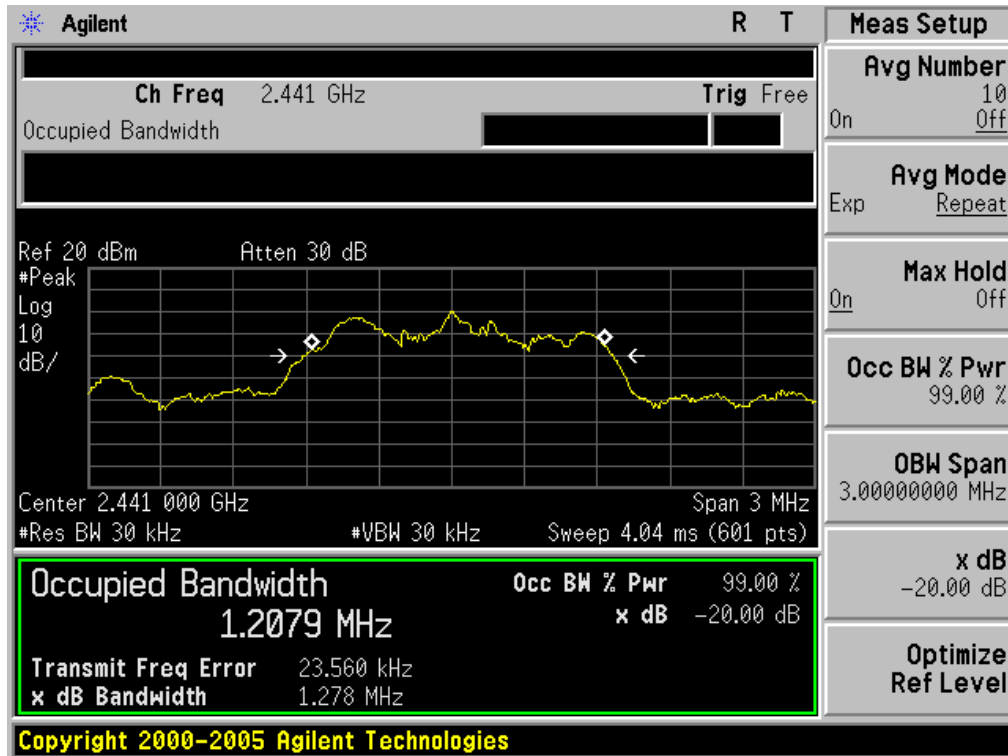

TEST PLOT OF BANDWIDTH FOR HIGH CHANNEL

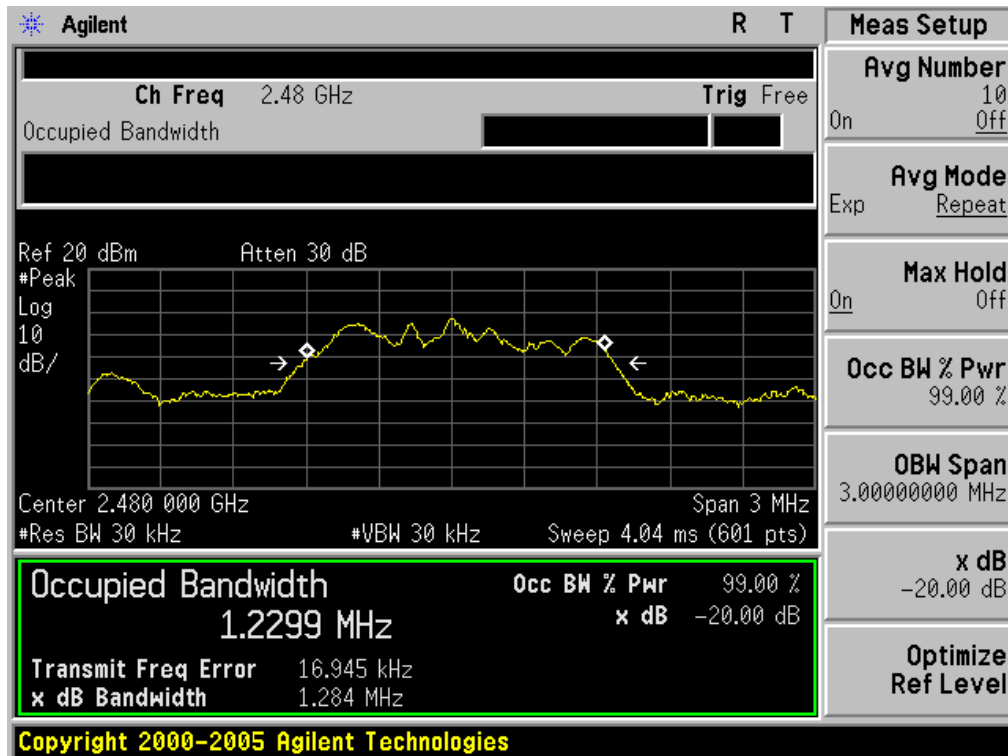

BLUETOOTH 3MBPS LIMITS AND MEASUREMENT RESULT			
Applicable Limits	Measurement Result		
	Test Data (MHz)		Criteria
N/A	Low Channel	1.266	PASS
	Middle Channel	1.245	PASS
	High Channel	1.294	PASS

TEST PLOT OF BANDWIDTH FOR LOW CHANNEL

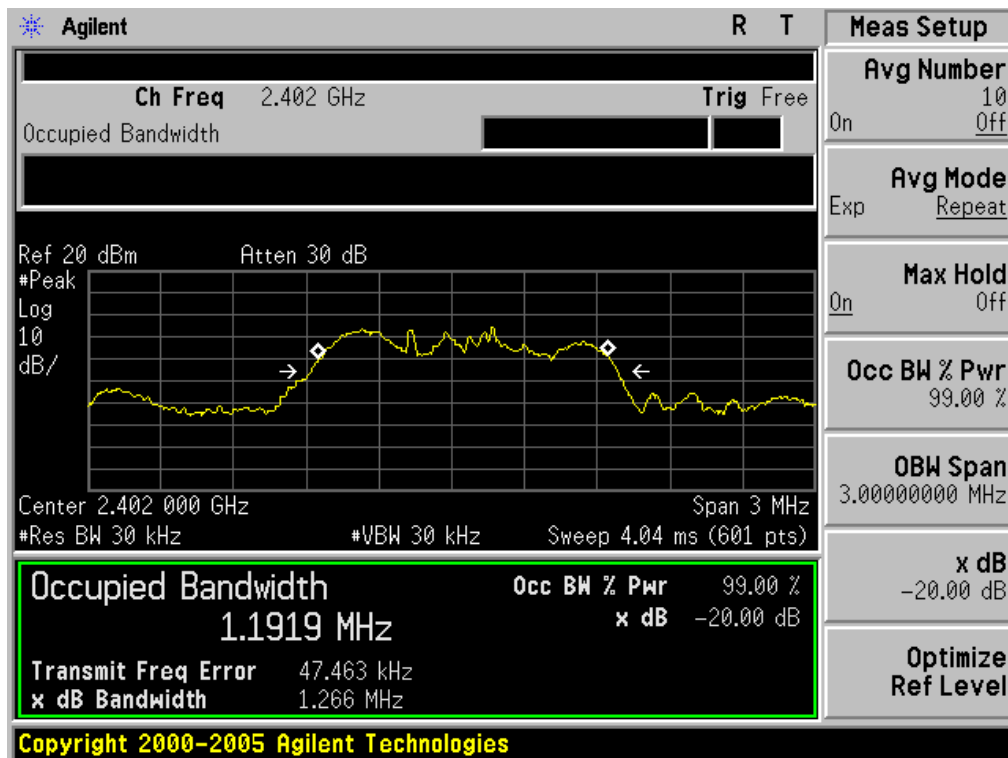

TEST PLOT OF BANDWIDTH FOR MIDDLE CHANNEL

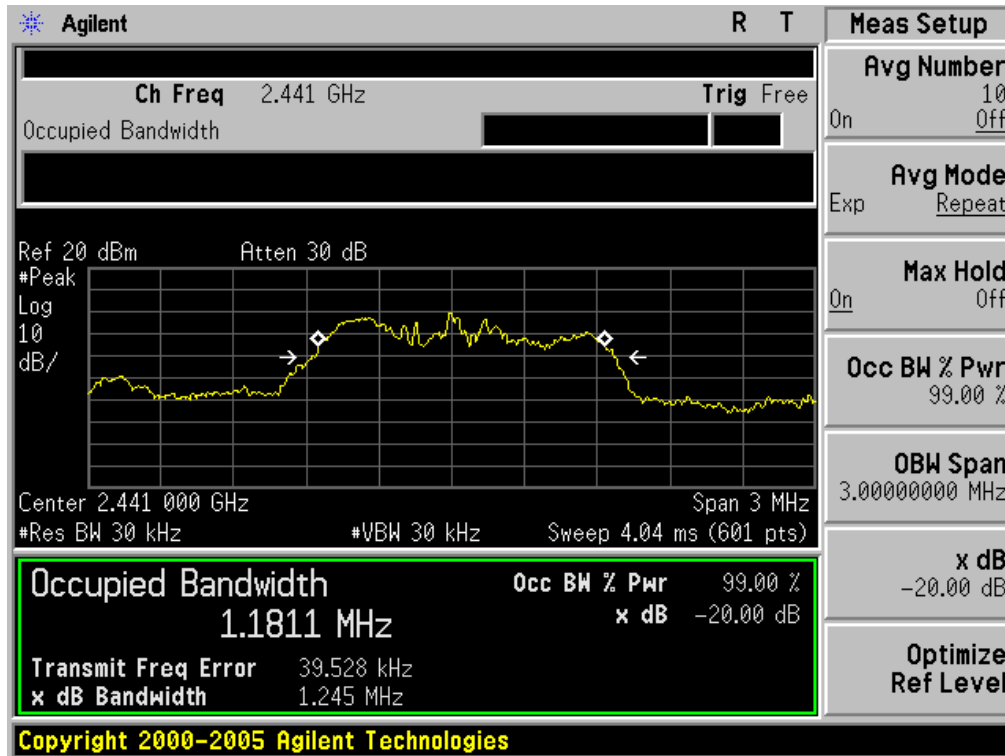

TEST PLOT OF BANDWIDTH FOR HIGH CHANNEL

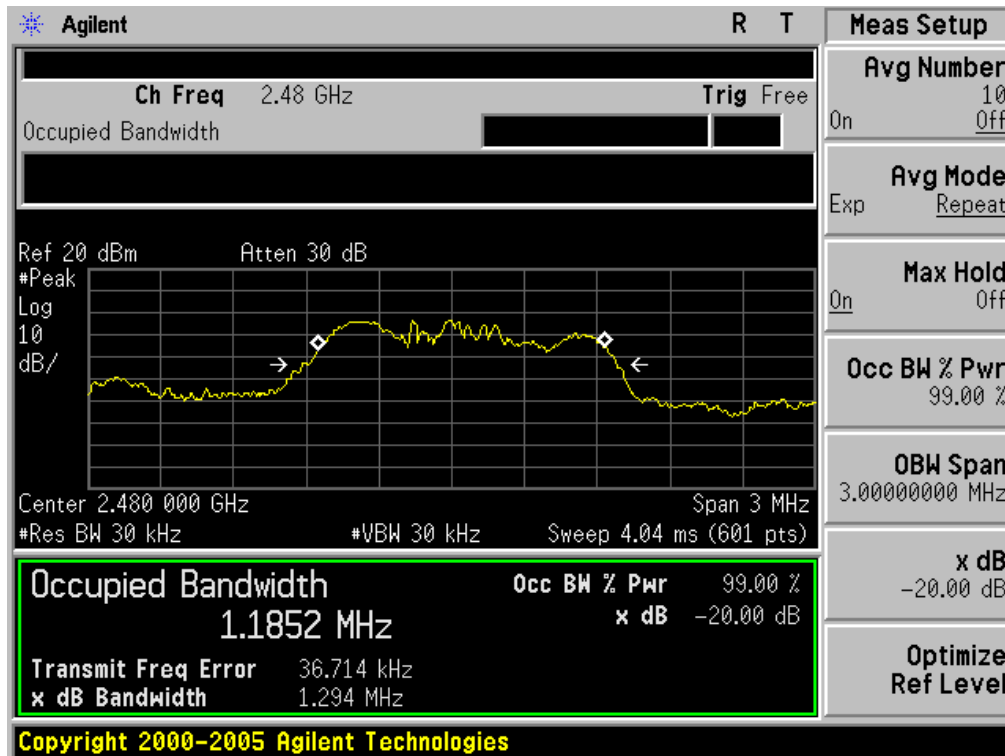

11. FCC LINE CONDUCTED EMISSION TEST

11.1. LIMITS OF LINE CONDUCTED EMISSION TEST

Frequency	Maximum RF Line Voltage	
	Q.P.(dBuV)	Average(dBuV)
150kHz~500kHz	66-56	56-46
500kHz~5MHz	56	46
5MHz~30MHz	60	50

Note:

1. The lower limit shall apply at the transition frequency.
2. The limit decreases linearly with the logarithm of the frequency in the range 0.15 MHz to 0.50 MHz.

11.2. BLOCK DIAGRAM OF LINE CONDUCTED EMISSION TEST

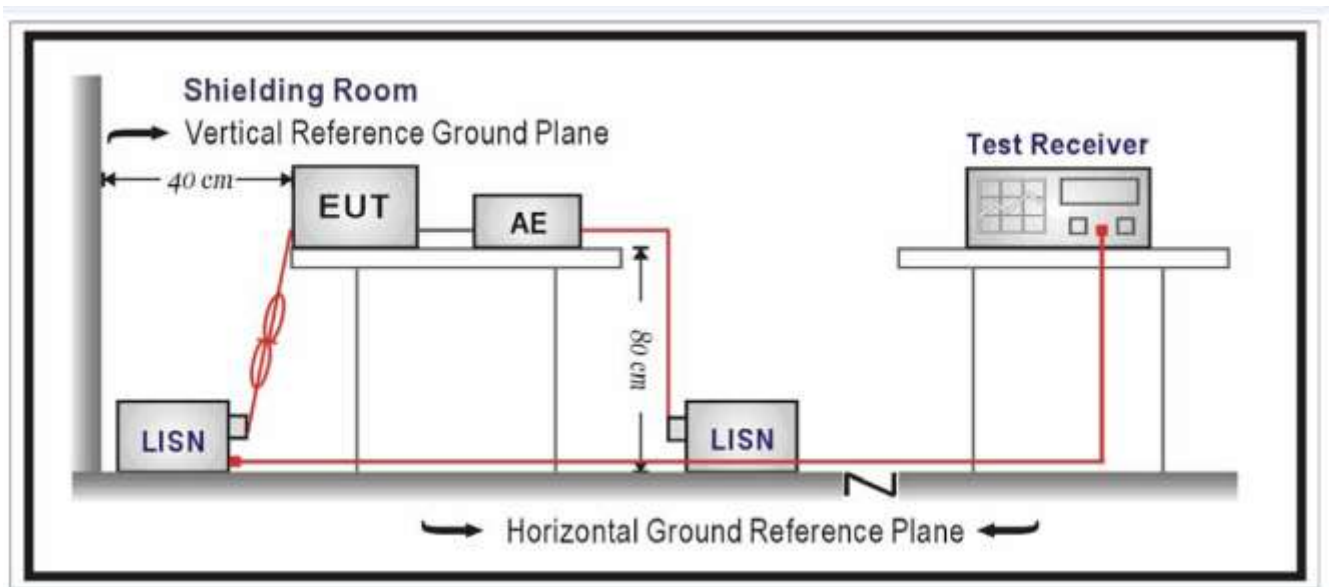

11.3. PRELIMINARY PROCEDURE OF LINE CONDUCTED EMISSION TEST

1. The equipment was set up as per the test configuration to simulate typical actual usage per the user's manual. When the EUT is a tabletop system, a wooden table with a height of 0.8 meters is used and is placed on the ground plane as per ANSI C63.4 (see Test Facility for the dimensions of the ground plane used). When the EUT is a floor-standing equipment, it is placed on the ground plane which has a 3-12 mm non-conductive covering to insulate the EUT from the ground plane.
2. Support equipment, if needed, was placed as per ANSI C63.4.
3. All I/O cables were positioned to simulate typical actual usage as per ANSI C63.4.
4. All support equipments received AC120V/60Hz power from a LISN, if any.
5. The EUT received DC charging voltage by PC which received 120V/60Hz power by a LISN.
6. The test program was started. Emissions were measured on each current carrying line of the EUT using a spectrum Analyzer / Receiver connected to the LISN powering the EUT. The LISN has two monitoring points: Line 1 (Hot Side) and Line 2 (Neutral Side). Two scans were taken: one with Line 1 connected to Analyzer / Receiver and Line 2 connected to a 50 ohm load; the second scan had Line 1 connected to a 50 ohm load and Line 2 connected to the Analyzer / Receiver.
7. Analyzer / Receiver scanned from 150 kHz to 30MHz for emissions in each of the test modes.
8. During the above scans, the emissions were maximized by cable manipulation.
9. The test mode(s) were scanned during the preliminary test.

Then, the EUT configuration and cable configuration of the above highest emission level were recorded for reference of final testing.

11.4. FINAL PROCEDURE OF LINE CONDUCTED EMISSION TEST

- EUT and support equipment was set up on the test bench as per step 2 of the preliminary test.
2. A scan was taken on both power lines, Line 1 and Line 2, recording at least the six highest emissions. Emission frequency and amplitude were recorded into a computer in which correction factors were used to calculate the emission level and compare reading to the applicable limit. If EUT emission level was less -2dB to the A.V. limit in Peak mode, then the emission signal was re-checked using Q.P and Average detector.
3. The test data of the worst case condition(s) was reported on the Summary Data page.

11.5. TEST RESULT OF LINE CONDUCTED EMISSION TEST

Line Conducted Emission Test Line 1-L

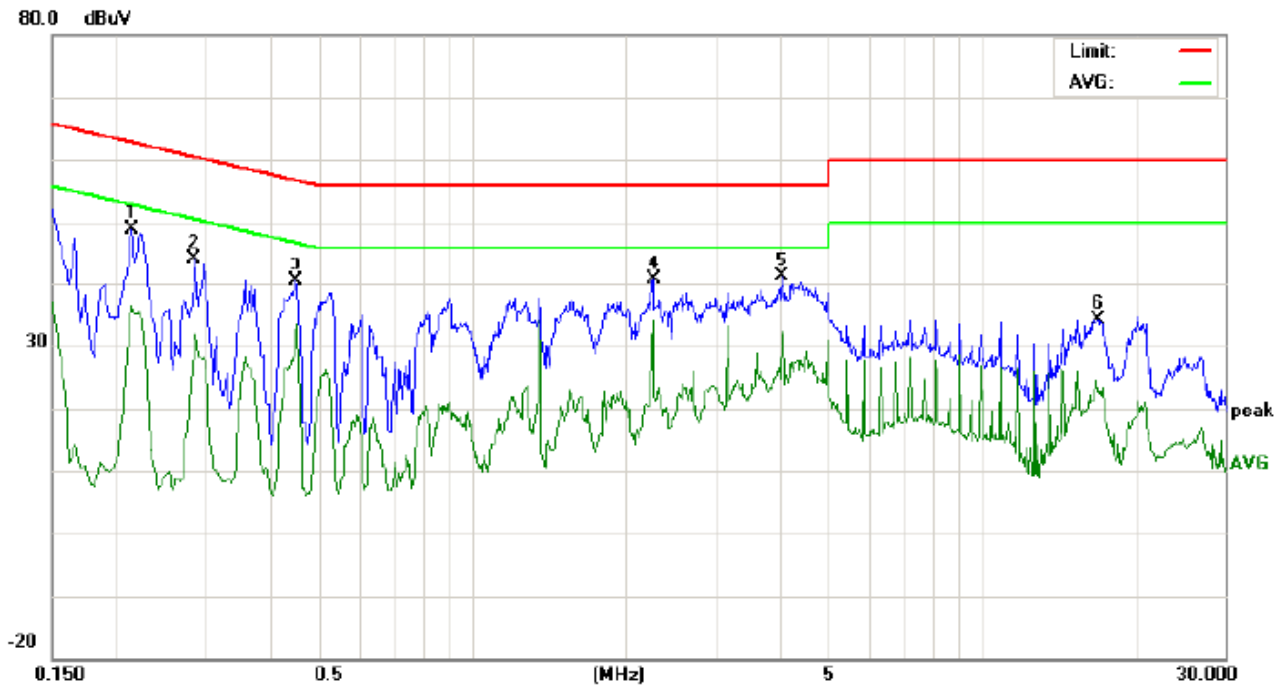

Site: Conduction Phase: **L1** Temperature: 26
 Limit: FCC Class B Conduction(QP) Power: Humidity: 60 %
 EUT: Bluetooth Speaker
 M/N: BT048
 Mode: Normal operation with charging
 Note:

No.	Freq. (MHz)	Reading_Level (dBuV)			Correct Factor (dB)	Measurement (dBuV)			Limit (dBuV)		Margin (dB)		P/F	Comment
		Peak	QP	AVG		Peak	QP	AVG	QP	AVG	QP	AVG		
1	0.2140	38.70		26.09	10.23	48.93		36.32	63.04	53.04	-14.11	-16.72	P	
2	0.2860	33.85		21.70	10.28	44.13		31.98	60.64	50.64	-16.51	-18.66	P	
3	0.4500	29.90		22.15	10.37	40.27		32.52	56.87	46.87	-16.60	-14.35	P	
4	2.2620	30.32		23.85	10.33	40.65		34.18	56.00	46.00	-15.35	-11.82	P	
5	4.0700	30.62		21.23	10.40	41.02		31.63	56.00	46.00	-14.98	-14.37	P	
6	16.9020	24.11		12.39	10.13	34.24		22.52	60.00	50.00	-25.76	-27.48	P	

Line Conducted Emission Test Line 2-N

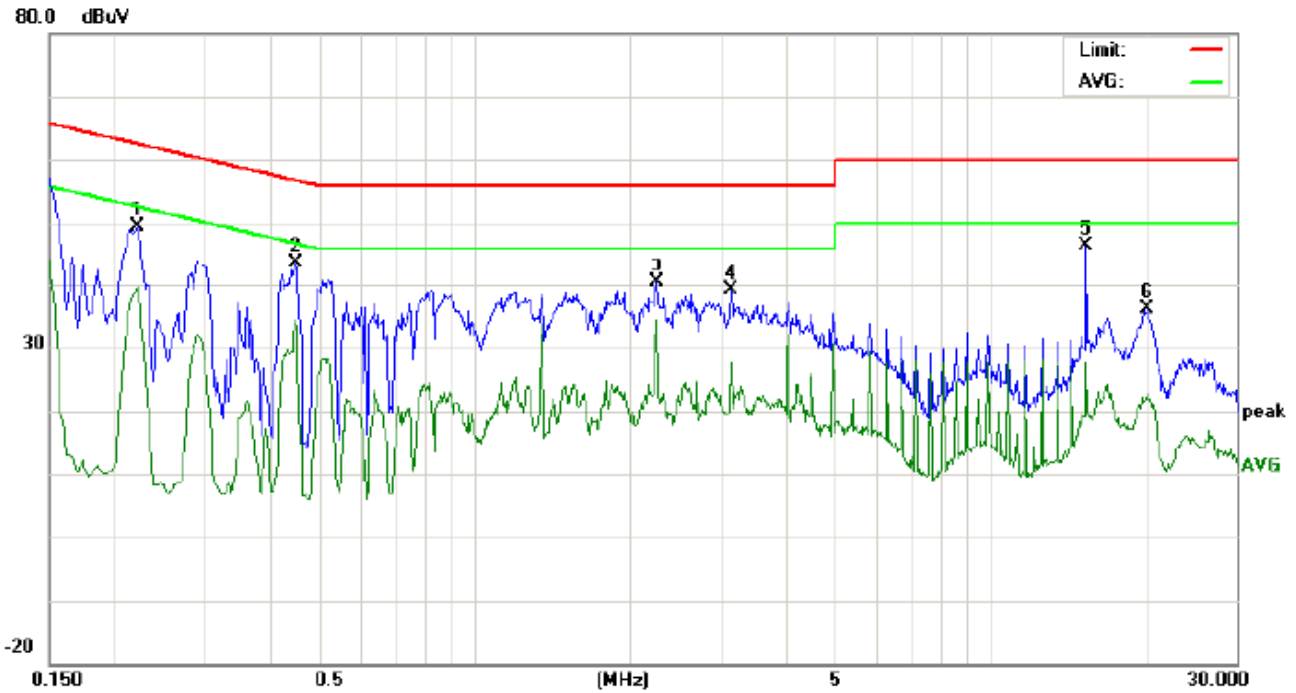

Site: Conduction Phase: *N* Temperature: 26
Limit: FCC Class B Conduction(QP) Power: Humidity: 60 %
EUT: Bluetooth Speaker
M/N: BT048
Mode: Normal operation with charging
Note:

No.	Freq. (MHz)	Reading_Level (dBuV)			Correct Factor (dB)	Measurement (dBuV)			Limit (dBuV)		Margin (dB)		P/F	Comment
		Peak	QP	AVG		Peak	QP	AVG	QP	AVG	QP	AVG		
1	0.2220	39.12		29.30	10.24	49.36		39.54	62.74	52.74	-13.38	-13.20	P	
2	0.4500	33.33		23.94	10.37	43.70		34.31	56.87	46.87	-13.17	-12.56	P	
3	2.2500	29.95		23.99	10.32	40.27		34.31	56.00	46.00	-15.73	-11.69	P	
4	3.1460	28.58		17.06	10.54	39.12		27.60	56.00	46.00	-16.88	-18.40	P	
5	15.3180	36.20		17.50	10.12	46.32		27.62	60.00	50.00	-13.68	-22.38	P	
6	20.0740	25.91		12.56	10.11	36.02		22.67	60.00	50.00	-23.98	-27.33	P	

APPENDIX A: PHOTOGRAPHS OF TEST SETUP
FCC LINE CONDUCTED EMISSION TEST SETUP



FCC RADIATED EMISSION TEST SETUP



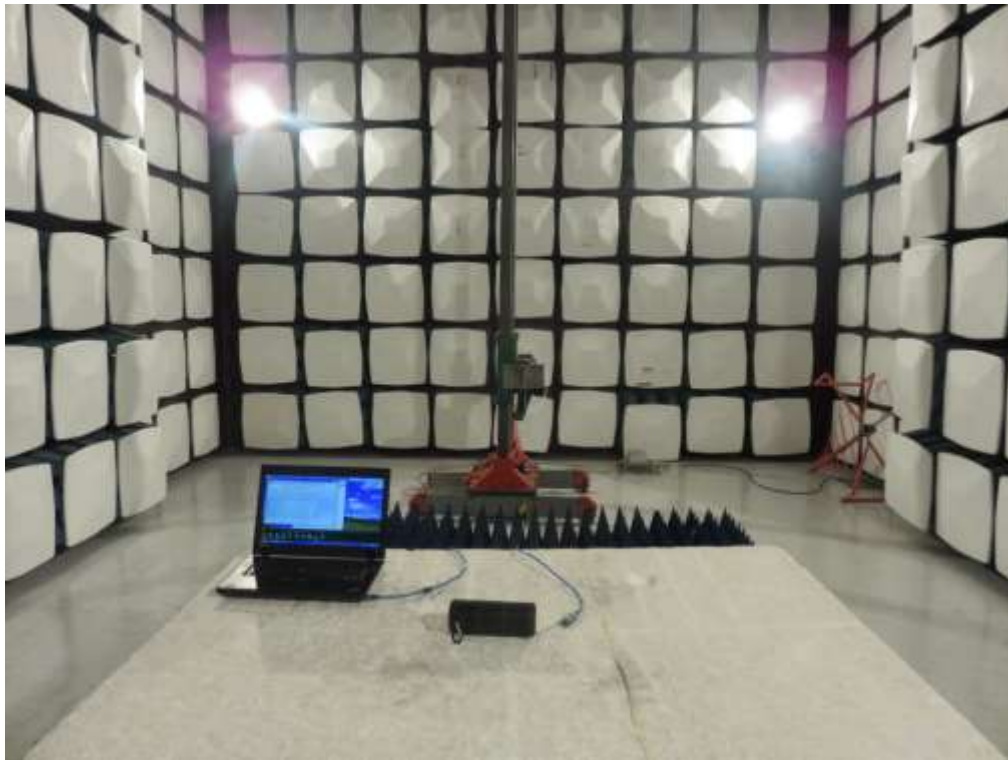

APPENDIX B: PHOTOGRAPHS OF EUT
TOTAL VIEW OF EUT



TOP VIEW OF EUT



BOTTOM VIEW OF EUT



FRONT VIEW OF EUT



BACK VIEW OF EUT

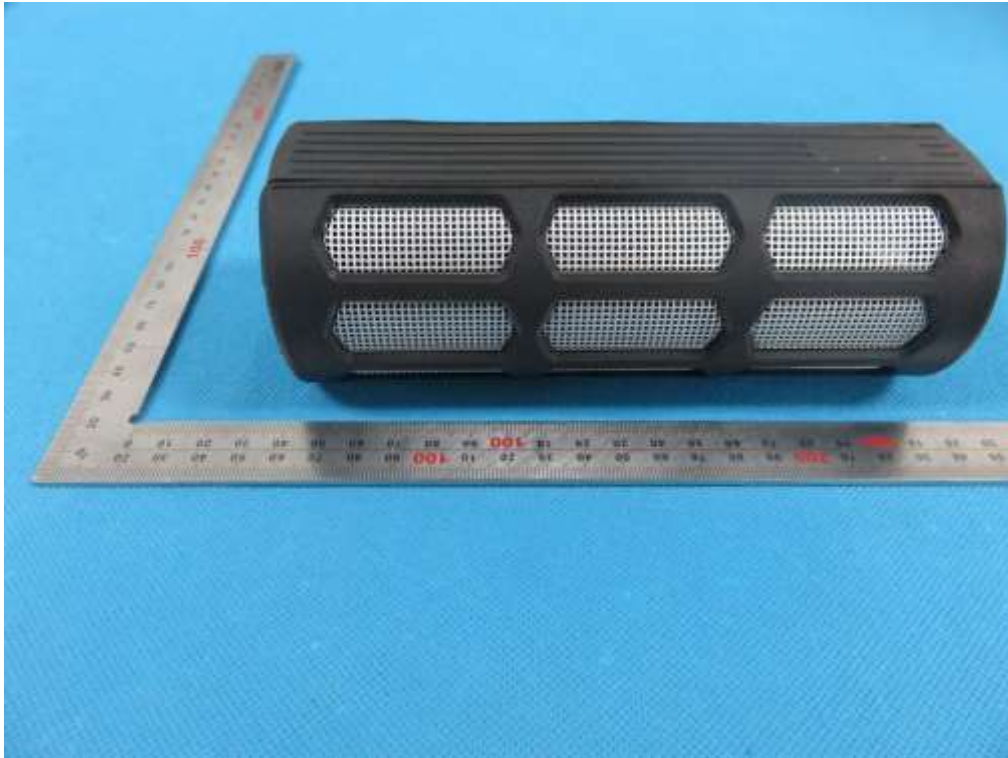

LEFT VIEW OF EUT



RIGHT VIEW OF EUT



VIEW OF EUT (PORT)



OPEN VIEW OF EUT



INTERNAL VIEW OF EUT-1

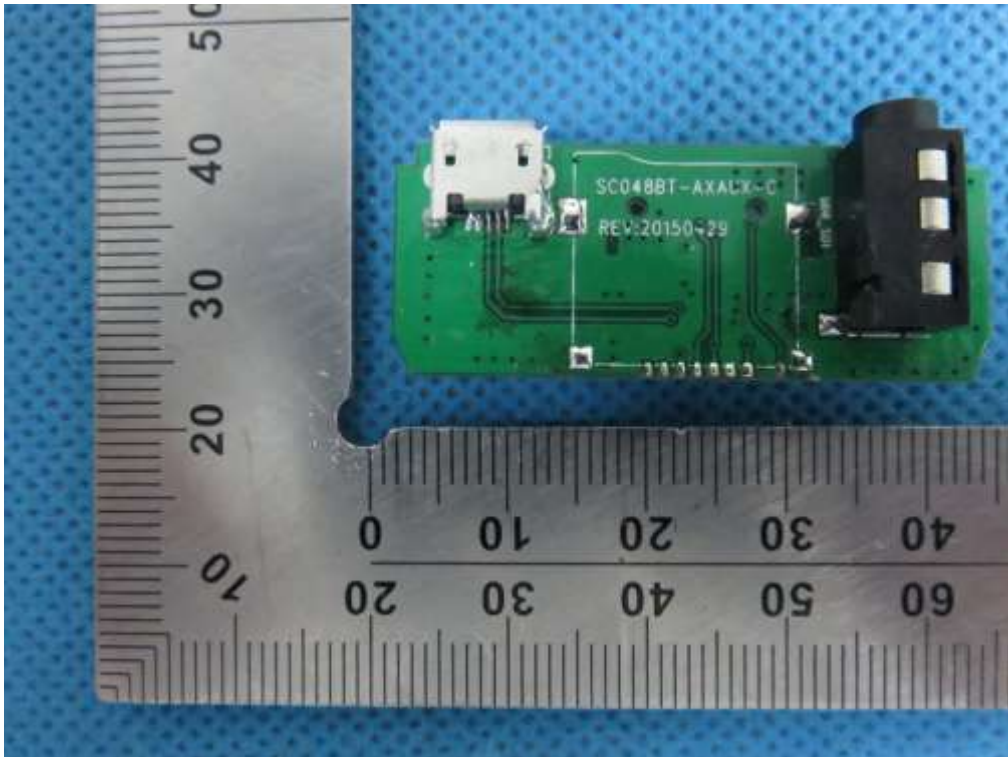

INTERNAL VIEW OF EUT-2

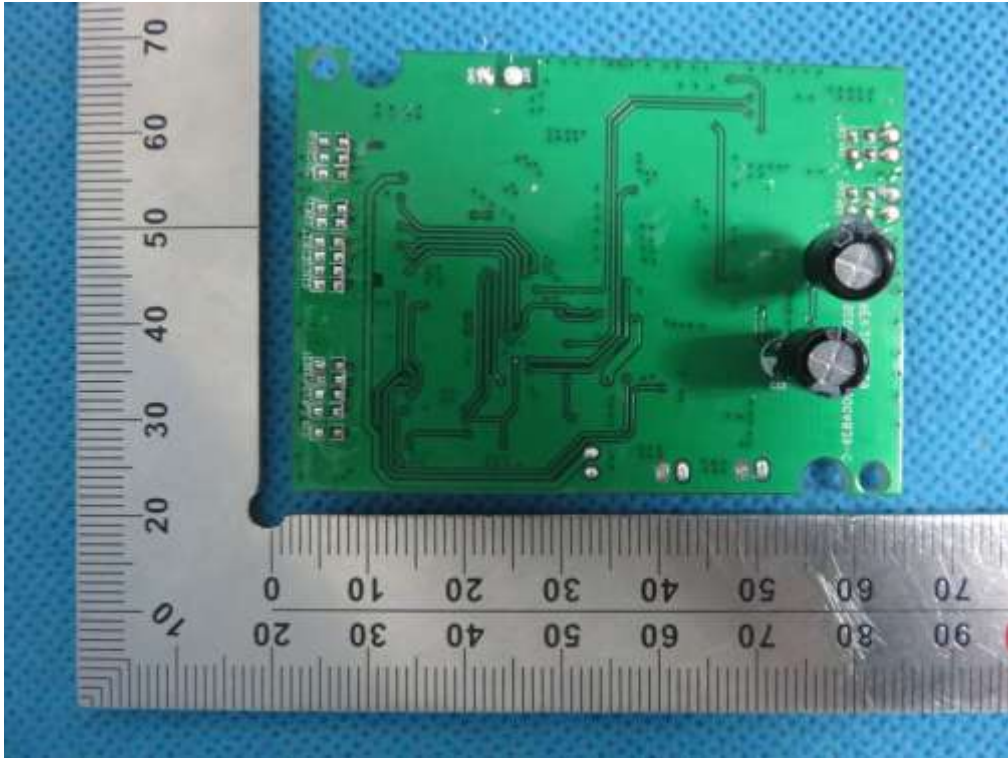

INTERNAL VIEW OF EUT-3

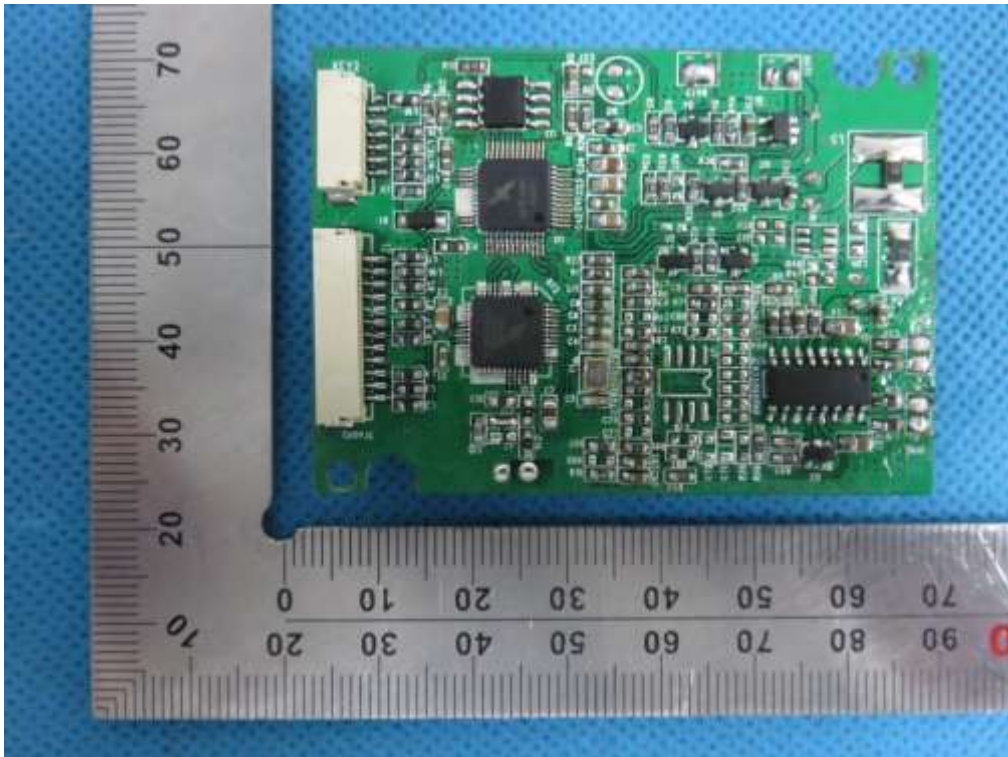

INTERNAL VIEW OF EUT-4

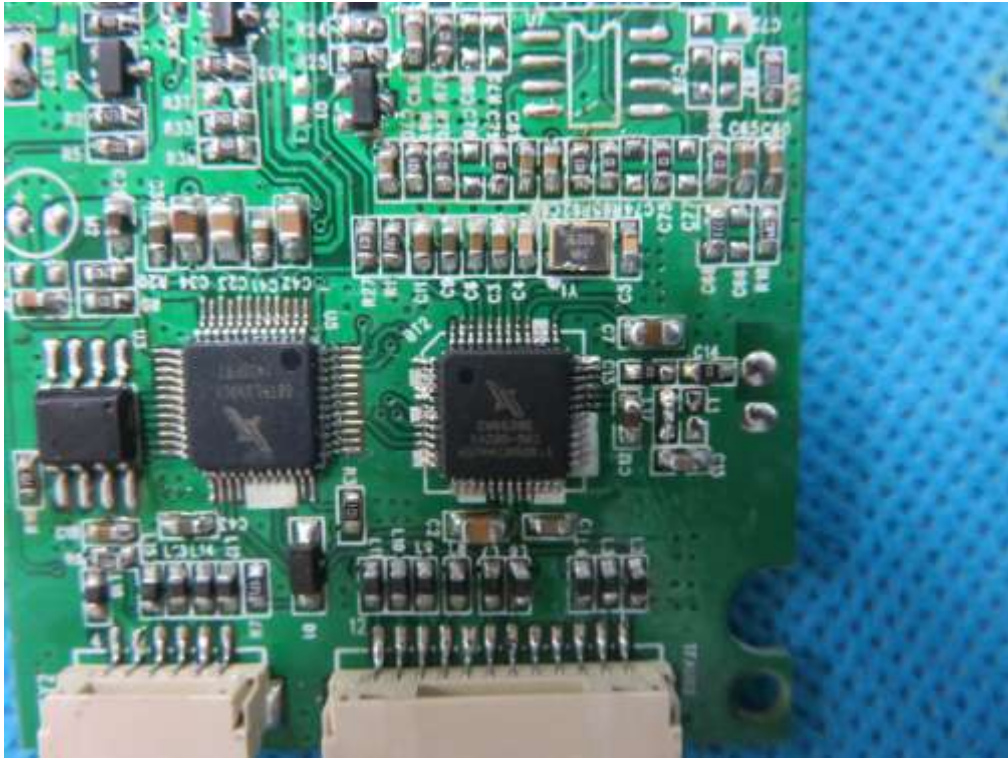

INTERNAL VIEW OF EUT-5

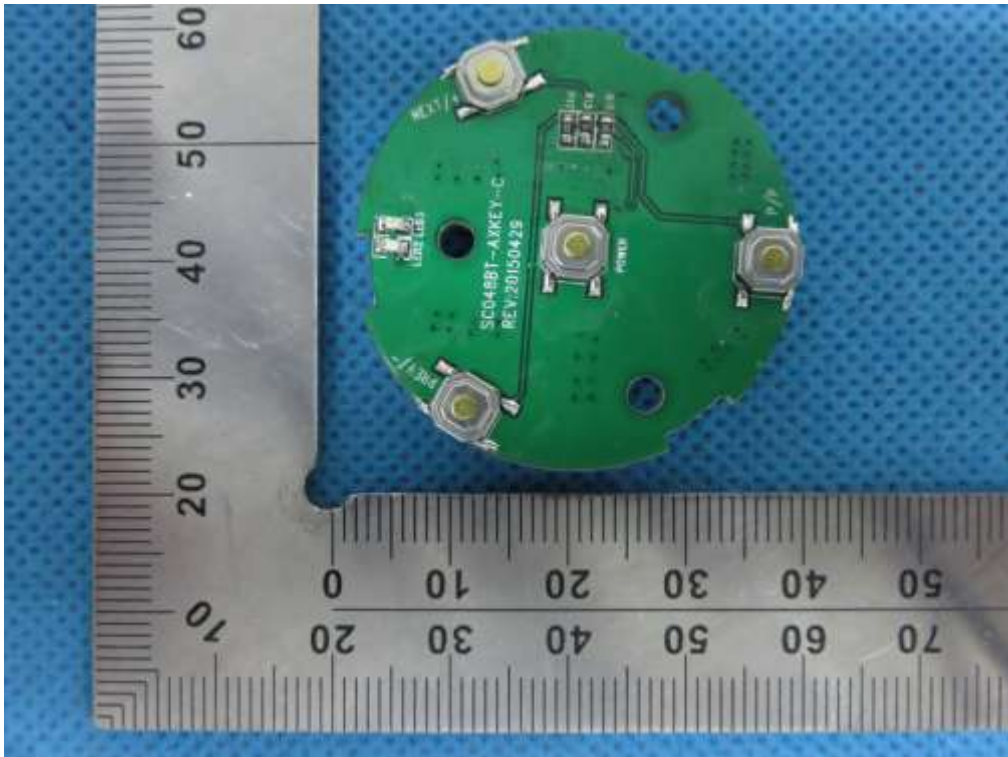

INTERNAL VIEW OF EUT-6

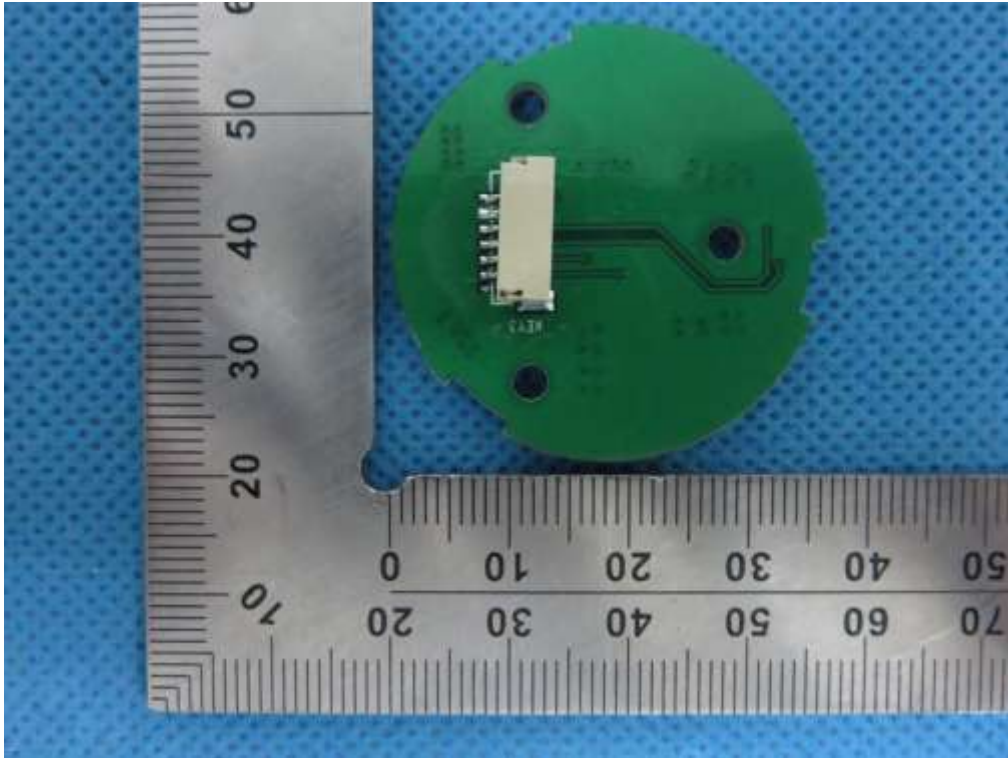

INTERNAL VIEW OF EUT-7

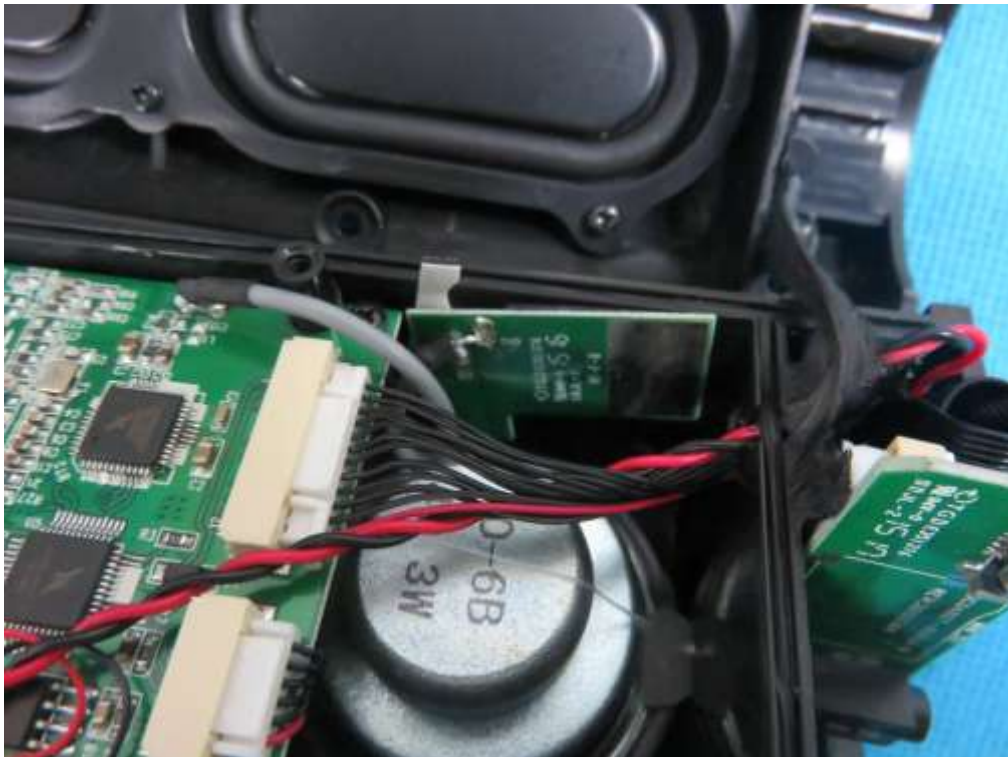

INTERNAL VIEW OF EUT-8

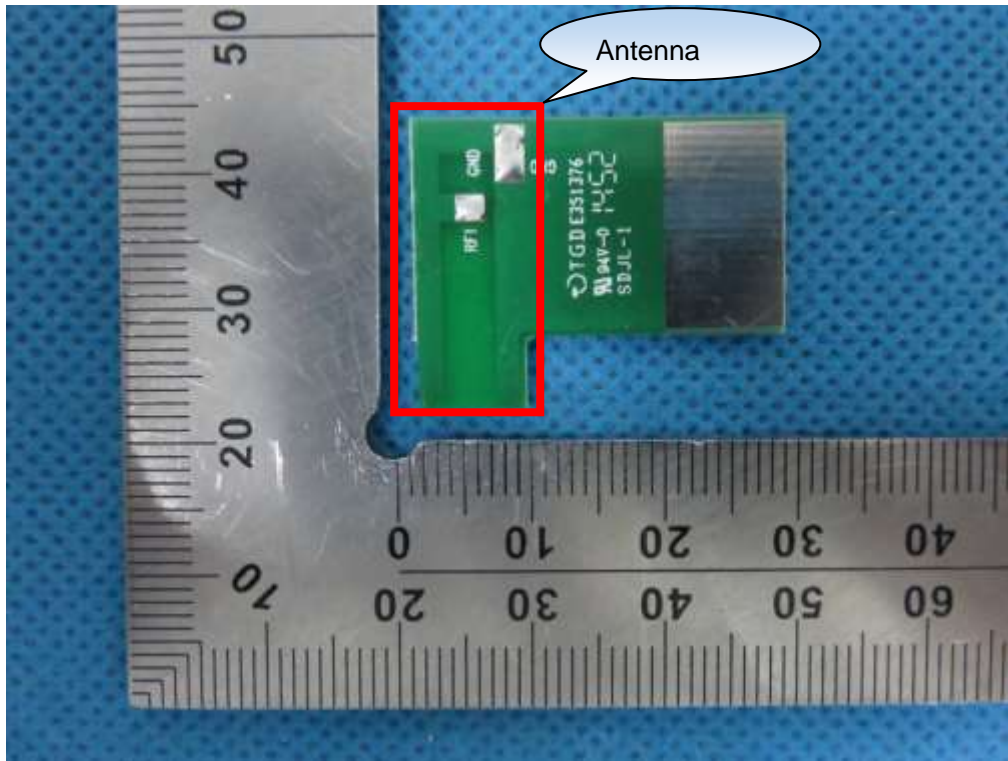

INTERNAL VIEW OF EUT-9

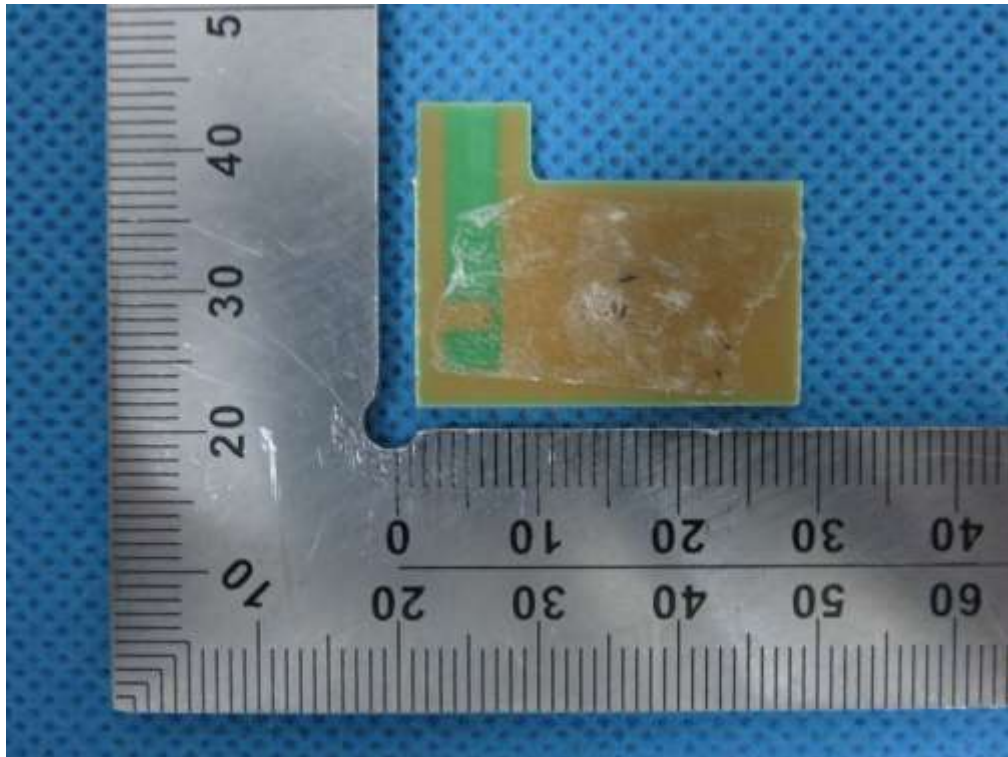

----END OF REPORT----