



*Testing Tomorrow's Technology*

**Application  
For**

**Title 47 USC, Part 2, Subpart J, Paragraph 2.902, Equipment Authorization of Verification for an Unintentional Radiator per Part 15, Subpart B, Paragraphs 15.107 and 15.109**

**And**

**Part 2, Subpart J, Paragraph 2.907 Equipment Authorization of Certification for an Intentional Radiator per Part 15, Subpart C, paragraph 15.247**

**For the**

**Inventek Systems**

**Models: ISM43362-M3G-L44-E and ISM43362-M3G-L44-U**

**FCC ID: O7P-362**

**IC: 10147A-362**

**UST Project: 13-0186**

**Issue Date: July 29, 2013**

Total Pages: 122

**3505 Francis Circle Alpharetta, GA 30004**  
**PH: 770-740-0717 Fax: 770-740-1508**  
**[www.ustech-lab.com](http://www.ustech-lab.com)**



*Testing Tomorrow's Technology*

I certify that I am authorized to sign for the Test Agency and that all of the statements in this report and in the Exhibits attached hereto are true and correct to the best of my knowledge and belief:

US TECH (Agent Responsible For Test):

By: Alan Ghasiani

Name: 

Title: Compliance Engineer – President

Date: July 25, 2013

This report shall not be reproduced except in full. This report may be copied in part only with the prior written approval of US Tech. The results contained in this report are subject to the adequacy and representative character of the sample provided.

3505 Francis Circle Alpharetta, GA 30004  
PH: 770-740-0717 Fax: 770-740-1508  
[www.ustech-lab.com](http://www.ustech-lab.com)

US Tech Test Report:  
FCC ID:  
IC ID:  
Test Report Number:  
Issue Date:  
Customer:  
Model(s):

FCC Part 15 Certification & IC RSS  
O7P-362  
10147A-362  
13-0186  
July 29, 2013  
Inventek Systems  
ISM43362-M3G-L44-E and ISM43362-M3G-L44-U

## MEASUREMENT TECHNICAL REPORT

**COMPANY NAME:** Inventek Systems  
**MODEL(S):** ISM43362-M3G-L44-E and ISM43362-M3G-L44-U  
**FCC ID:** O7P-362  
**IC ID:** 10147A-362  
**DATE:** July 25, 2013

This report concerns (check one): Original grant   
Class II change

Equipment type: DSSS WiFi module for use in other devices.

Deferred grant requested per 47 CFR 0.457(d)(1)(ii)? yes\_\_\_\_\_ No X

If yes, defer until: N/A date  
agrees to notify the Commission by N/A date  
of the intended date of announcement of the product so that the grant can be  
issued on that date.

Report prepared by:

US Tech  
3505 Francis Circle  
Alpharetta, GA 30004  
Phone Number: (770) 740-0717  
Fax Number: (770) 740-1508

US Tech Test Report:  
FCC ID:  
IC ID:  
Test Report Number:  
Issue Date:  
Customer:  
Model(s):

FCC Part 15 Certification & IC RSS  
O7P-362  
10147A-362  
13-0186  
July 29, 2013  
Inventek Systems  
ISM43362-M3G-L44-E and ISM43362-M3G-L44-U

## Table of Contents

<u>Paragraph</u>	<u>Title</u>	<u>Page</u>
1	General Information .....	10
1.1	Purpose of this Report .....	10
1.2	Characterization of Test Sample .....	10
1.3	Product Description .....	10
1.4	Configuration of Tested System .....	11
1.5	Test Facility .....	11
1.6	Related Submittal(s)/Grant(s) .....	11
2	Tests and Measurements .....	13
2.1	Test Equipment .....	13
2.2	Modifications to EUT Hardware .....	14
2.3	Number of Measurements for Intentional Radiators (15.31(m)).....	14
2.4	Frequency Range of Radiated Measurements (Part 15.33) .....	15
2.5	Measurement Detector Function and Bandwidth (CFR 15.35) .....	15
2.6	EUT Antenna Requirements (CFR 15.203) .....	16
2.7	Restricted Bands of Operation (Part 15.205).....	18
2.8	Transmitter Duty Cycle (CFR 35 (c)) .....	18
2.9	Intentional Radiator, Power Lines Conducted Emissions (CFR 15.207)....	20
2.10	Intentional Radiator, Radiated Emissions (Antenna Conducted) (CFR 15.209, 15.247(d)) (IC RSS 210, A2.9 (a)) .....	21
2.10.1	Conducted Radiated Emissions, IEEE 802.11b, Channel 1 .....	23
2.10.2	Conducted Radiated Emissions, IEEE 802.11b, Channel 7 .....	27
2.10.3	Conducted Radiated Emissions, IEEE 802.11b, Channel 11 .....	31
2.10.4	Conducted Radiated Emissions, IEEE 802.11g, Channel 1 .....	35
2.10.5	Conducted Radiated Emissions, IEEE 802.11g, Channel 7 .....	39
2.10.6	Conducted Radiated Emissions, IEEE 802.11g, Channel 11 .....	43
2.10.7	Conducted Radiated Emissions, IEEE 802.11n, Channel 1 .....	47
2.10.8	Conducted Radiated Emissions, IEEE 802.11n, Channel 7 .....	51
2.10.9	Conducted Radiated Emissions, IEEE 802.11n, Channel 11 .....	55
2.11	Intentional Radiated Emissions and Harmonics .....	59
2.12	6 dB Bandwidth per CFR 15.247(a)(2), (IC RSS 210, A8.2(a)) .....	71
2.13	Maximum Peak Conducted Output Power (CFR 15.247 (b) (3)) .....	81
2.14	Power Spectral Density (CFR 15.247(e)) (IC RSS 210 A8.5).....	92
2.15	Band Edge Measurements-(CFR 15.247 (d)) .....	102
2.16	20 dB Bandwidth Measurement per CFR 15.247, 99% Occupied Bandwidth (IC RSS 210, A8.1).....	109
2.17	Unintentional Radiator Power Lines Conducted Emissions (CFR 15.107) 119	
2.18	Unintentional Radiator, Radiated Emissions (CFR 15.109, 15.209) .....	121

US Tech Test Report:  
FCC ID:  
IC ID:  
Test Report Number:  
Issue Date:  
Customer:  
Model(s):

FCC Part 15 Certification & IC RSS  
O7P-362  
10147A-362  
13-0186  
July 29, 2013  
Inventek Systems  
ISM43362-M3G-L44-E and ISM43362-M3G-L44-U

### List of Figures

<u>Figures</u>	<u>Title</u>	<u>Page</u>
Figure 1.	Test Configuration .....	17
Figure 2.	Duty Cycle, Plot 1 .....	18
Figure 3.	Duty Cycle, Plot 2 .....	19
Figure 4.	Emissions 802.11b - Low Channel, Part 1 .....	23
Figure 5.	Emissions 802.11b - Low Channel, Part 2 .....	24
Figure 6.	Emissions 802.11b - Low Channel, Part 3 .....	25
Figure 7.	Emissions 802.11b - Low Channel, Part 4 .....	26
Figure 8.	Emissions 802.11b - Mid Channel, Part 1 .....	27
Figure 9.	Emissions 802.11b - Mid Channel, Part 2 .....	28
Figure 10.	Emissions 802.11b - Mid Channel, Part 3 .....	29
Figure 11.	Emissions 802.11b - Mid Channel, Part 4 .....	30
Figure 12.	Emissions 802.11b - High Channel, Part 1 .....	31
Figure 13.	Emissions 802.11b - High Channel, Part 2 .....	32
Figure 14.	Emissions 802.11b - High Channel, Part 3 .....	33
Figure 15.	Emissions 802.11b - High Channel, Part 4 .....	34
Figure 16.	Emissions 802.11g - Low Channel, Part 1 .....	35
Figure 17.	Emissions 802.11g - Low Channel, Part 2 .....	36
Figure 18.	Emissions 802.11g - Low Channel, Part 3 .....	37
Figure 19.	Emissions 802.11g - Low Channel, Part 4 .....	38
Figure 20.	Emissions 802.11g - Mid Channel, Part 1 .....	39
Figure 21.	Emissions 802.11g - Mid Channel, Part 2 .....	40
Figure 22.	Emissions 802.11g - Mid Channel, Part 3 .....	41
Figure 23.	Emissions 802.11g - Mid Channel, Part 4 .....	42
Figure 24.	Emissions 802.11g - High Channel, Part 1 .....	43
Figure 25.	Emissions 802.11g - High Channel, Part 2 .....	44
Figure 26.	Emissions 802.11g - High Channel, Part 3 .....	45
Figure 27.	Emissions 802.11g - High Channel, Part 4 .....	46
Figure 28.	Emissions 802.11n - Low Channel, Part 1 .....	47
Figure 29.	Emissions 802.11n - Low Channel, Part 2 .....	48
Figure 30.	Emissions 802.11n - Low Channel, Part 3 .....	49
Figure 31.	Emissions 802.11n - Low Channel, Part 4 .....	50
Figure 32.	Emissions 802.11n - Mid Channel, Part 1 .....	51
Figure 33.	Emissions 802.11n - Mid Channel, Part 2 .....	52
Figure 34.	Emissions 802.11n - Mid Channel, Part 3 .....	53
Figure 35.	Emissions 802.11n - Mid Channel, Part 4 .....	54
Figure 36.	Emissions 802.11n - High Channel, Part 1 .....	55
Figure 37.	Emissions 802.11n - High Channel, Part 2 .....	56
Figure 38.	Emissions 802.11n - High Channel, Part 3 .....	57
Figure 39.	Emissions 802.11n - High Channel, Part 4 .....	58

Figure 40. 6 dB Bandwidth - 15.247 (a) (2) – 802.11b – Low Channel ..... 72  
Figure 41. 6 dB Bandwidth - 15.247 (a) (2) – 802.11b – Mid Channel..... 73  
Figure 42. 6 dB Bandwidth - 15.247 (a) (2) – 802.11b – High Channel ..... 74  
Figure 43. 6 dB Bandwidth - 15.247 (a) (2) – 802.11g – Low Channel ..... 75  
Figure 44. 6 dB Bandwidth - 15.247 (a) (2) – 802.11g – Mid Channel..... 76  
Figure 45. 6 dB Bandwidth - 15.247 (a) (2) – 802.11g – High Channel ..... 77  
Figure 46. 6 dB Bandwidth - 15.247 (a) (2) – 802.11n – Low Channel ..... 78  
Figure 47. 6 dB Bandwidth - 15.247 (a) (2) – 802.11n – Mid Channel..... 79  
Figure 48. 6 dB Bandwidth - 15.247 (a) (2) – 802.11n – High Channel ..... 80  
Figure 49. IEEE 802.11b, Low Channel..... 83  
Figure 50. IEEE 802.11b, Mid Channel..... 84  
Figure 51. IEEE 802.11b, High Channel..... 85  
Figure 52. IEEE 802.11g, Low Channel..... 86  
Figure 53. IEEE 802.11g, Mid Channel..... 87  
Figure 54. IEEE 802.11g, High Channel..... 88  
Figure 55. IEEE 802.11n, Low Channel..... 89  
Figure 56. IEEE 802.11n, Mid Channel..... 90  
Figure 57. IEEE 802.11n, High Channel..... 91  
Figure 58. 802.11(b) Peak Power Spectral Density - Part 15.247 (e) - Low Channel  
..... 93  
Figure 59. 802.11(b) Peak Power Spectral Density - Part 15.247 (e) - Mid Channel..... 94  
Figure 60. 802.11(b) Peak Power Spectral Density - Part 15.247 (e) - High Channel  
..... 95  
Figure 61. 802.11(g) Peak Power Spectral Density - Part 15.247 (e) - Low Channel  
..... 96  
Figure 62. 802.11(g) Peak Power Spectral Density - Part 15.247 (e) - Mid Channel..... 97  
Figure 63. 802.11(g) Peak Power Spectral Density - Part 15.247 (e) - High Channel  
..... 98  
Figure 64. 802.11(n) Peak Power Spectral Density - Part 15.247 (e) - Low Channel  
..... 99  
Figure 65. 802.11(n) Peak Power Spectral Density - Part 15.247 (e) - Mid Channel  
..... 100  
Figure 66. 802.11(n) Peak Power Spectral Density - Part 15.247 (e) - High Channel  
..... 101  
Figure 67. 802.11b – Band Edge Compliance – Low Channel Delta - Peak..... 103  
Figure 68. 802.11b – Band Edge Compliance – High Channel Delta - Peak..... 104  
Figure 69. 802.11g – Band Edge Compliance – Low Channel Delta - Peak..... 105  
Figure 70. 802.11g – Band Edge Compliance – High Channel Delta - Peak..... 106  
Figure 71. 802.11n – Band Edge Compliance – Low Channel Delta - Peak..... 107  
Figure 72. 802.11n – Band Edge Compliance – High Channel Delta - Peak..... 108  
Figure 73. 802.11b - Low Channel 99% Bandwidth ..... 110  
Figure 74. 802.11b - Mid Channel 99% Bandwidth..... 111

US Tech Test Report:  
FCC ID:  
IC ID:  
Test Report Number:  
Issue Date:  
Customer:  
Model(s):

FCC Part 15 Certification & IC RSS  
O7P-362  
10147A-362  
13-0186  
July 29, 2013  
Inventek Systems  
ISM43362-M3G-L44-E and ISM43362-M3G-L44-U

---

Figure 75. 802.11b - High Channel 99% Bandwidth ..... 112  
Figure 76. 802.11g - Low Channel 99% Bandwidth ..... 113  
Figure 77. 802.11g - Mid Channel 99% Bandwidth..... 114  
Figure 78. 802.11g - High Channel 99% Bandwidth ..... 115  
Figure 79. 802.11n - Low Channel 99% Bandwidth ..... 116  
Figure 80. 802.11n - Mid Channel 99% Bandwidth..... 117  
Figure 81. 802.11n - High Channel 99% Bandwidth ..... 118

US Tech Test Report:  
FCC ID:  
IC ID:  
Test Report Number:  
Issue Date:  
Customer:  
Model(s):

FCC Part 15 Certification & IC RSS  
O7P-362  
10147A-362  
13-0186  
July 29, 2013  
Inventek Systems  
ISM43362-M3G-L44-E and ISM43362-M3G-L44-U

## List of Tables

<u>Table</u>	<u>Title</u>	<u>Page</u>
Table 1.	EUT and Peripherals.....	12
Table 2.	Test Instruments .....	13
Table 3.	Number of Test Frequencies for Intentional Radiators.....	14
Table 4.	Allowed Antenna(s) .....	16
Table 5.	Conducted Emissions for intentional Radiator .....	20
Table 6.	802.11b Peak Fundamental & Harmonic Emissions Antenna 1 .....	59
Table 7.	802.11b Average Fundamental & Harmonic Emissions Antenna 1 .....	60
Table 8.	802.11g Peak Fundamental & Harmonic Emissions Antenna 1 .....	61
Table 9.	802.11g Average Fundamental & Harmonic Emissions Antenna 1 .....	62
Table 10.	802.11n Peak Fundamental & Harmonic Emissions Antenna 1 .....	63
Table 11.	802.11n Average Fundamental & Harmonic Emissions Antenna 1 .....	64
Table 12.	802.11b Peak Fundamental & Harmonic Emissions Antenna 2.....	65
Table 13.	802.11b Average Fundamental & Harmonic Emissions Antenna 2.....	66
Table 14.	802.11g Peak Fundamental & Harmonic Emissions Antenna 2.....	67
Table 15.	802.11g Average Fundamental & Harmonic Emissions Antenna 2.....	68
Table 16.	802.11n Peak Fundamental & Harmonic Emissions Antenna 2.....	69
Table 17.	802.11n Average Fundamental & Harmonic Emissions Antenna 2.....	70
Table 18.	6 dB Bandwidth.....	71
Table 19.	Peak Antenna Conducted Output Power per Part 15.247 (b) (3) .....	82
Table 20.	Power Spectral Density for 802.11b Low, Mid and High Channels .....	92
Table 21.	802.11b 20 dB Bandwidth and 99% Occupied Bandwidth .....	109
Table 22.	Power Line Conducted Emissions Data, Class B Part 15.107 .....	120
Table 23.	Unintentional Radiator, Radiated Emissions. ....	122



US Tech Test Report:  
FCC ID:  
IC ID:  
Test Report Number:  
Issue Date:  
Customer:  
Model(s):

FCC Part 15 Certification & IC RSS  
O7P-362  
10147A-362  
13-0186  
July 29, 2013  
Inventek Systems  
ISM43362-M3G-L44-E and ISM43362-M3G-L44-U

---

## **List of Attachments**

### **Attachments**

Agency Agreement  
Application Forms  
Letter of Confidentiality  
Equipment Label  
Block Diagram(s)  
Schematic(s)  
Test Configuration Photographs  
Internal Photographs  
External and Antenna Photographs  
Theory of Operation  
RF Exposure  
User's Manual

US Tech Test Report:  
FCC ID:  
IC ID:  
Test Report Number:  
Issue Date:  
Customer:  
Model(s):

FCC Part 15 Certification & IC RSS  
O7P-362  
10147A-362  
13-0186  
July 29, 2013  
Inventek Systems  
ISM43362-M3G-L44-E and ISM43362-M3G-L44-U

---

## **1 General Information**

### **1.1 Purpose of this Report**

This report is prepared as a means of conveying test results for the 2.4 GHz WiFi (802.11b, 802.11g, and 802.11n) information concerning the suitability of this exact product for public distribution according to the FCC Rules and Regulations Part 15, Section 247.

### **1.2 Characterization of Test Sample**

The sample used for testing was received by US Tech on June 10, 2013 in good operating condition.

### **1.3 Product Description**

The Equipment Under Test (EUT) is the Inventek Systems eS-WiFi module. The module employs DSSS modulation techniques. The module comes with two antenna options see below for details. Both models use the same radio module: BCM43362 from Broadcom. The module (BCM43362) is part of Inventek Systems eS-WiFi module family targeting embedded WiFi 802.11 b/g/n applications. eS-WiFi modules offer plug and play WiFi solution that enables the embedded designers to integrate WiFi into their devices. The eS-WiFi module hardware system consists of a host processor, integrated antenna and Broadcom WiFi device (BCM43362). The module provides SPI, USB and UART interfaces. The module requires no operation system and has a completely integrated TCP/IP stack that only requires a simple AT command set to establish connectivity.

The eS-WiFi module is offered in two configurations:

1. 15mmx30mm module with integrated trace antenna (Designated as Model ISM43362-MG3-L44-E)
2. 15mmx30mm module with external antenna, Dipole (Bow Tie) attached with a u.fl connector (Designated as Model ISM43362-MG3-L44-U)

The EUT was placed into a test mode and both variations were tested. The output characteristics of these two models are presented herein.

US Tech Test Report:  
FCC ID:  
IC ID:  
Test Report Number:  
Issue Date:  
Customer:  
Model(s):

FCC Part 15 Certification & IC RSS  
O7P-362  
10147A-362  
13-0186  
July 29, 2013  
Inventek Systems  
ISM43362-M3G-L44-E and ISM43362-M3G-L44-U

---

## 1.4 Configuration of Tested System

The Test Samples were tested per *ANSI C63.4:2003, Methods of Measurement of Low-Voltage Electrical and Electronic Equipment in the Range of 9 kHz to 40 GHz (2003)* for FCC subpart B Digital equipment Verification requirements and per FCC KDB Publication number 558074 for Digital Transmission Systems Operating Under section 15.247.

Digital RF conducted and radiated Verification emissions data (FCC 15.107 and 109) below 1 GHz were taken with the measuring receiver's (or spectrum analyzer's) resolution bandwidth adjusted to 9 kHz and 120 kHz, respectively. All measurements performed above 1.0 GHz were made with a RBW of 1 MHz. All measurements are peak unless stated otherwise. The video filter associated with the spectrum analyzer was off throughout the evaluation process.

A list of EUT and Peripherals is found in Table 1 below. A block diagram of the tested system is shown in Figure 1. Test configuration photographs for spurious and fundamental emissions are provided in separate Appendices.

## 1.5 Test Facility

Testing was performed at US Tech's measurement facility at 3505 Francis Circle, Alpharetta, GA 30004. This site has been fully described and registered with the FCC. Its designation number is 186022. Additionally this site has also been fully described and submitted to Industry Canada (IC), and has been approved under file number 2982A-1.

## 1.6 Related Submittal(s)/Grant(s)

The EUT will be used to wirelessly send/receive data. The transceiver presented in this report will be used with other like transceivers:

The EUT is subject to the following FCC Equipment Authorizations:

- a) Certification of the transmitter for Wifi.
- b) Verification as a Class B digital device.

The manufacturer desires to seek a modular approval on this device.

US Tech Test Report:  
 FCC ID:  
 IC ID:  
 Test Report Number:  
 Issue Date:  
 Customer:  
 Model(s):

FCC Part 15 Certification & IC RSS  
 O7P-362  
 10147A-362  
 13-0186  
 July 29, 2013  
 Inventek Systems  
 ISM43362-M3G-L44-E and ISM43362-M3G-L44-U

**Table 1. EUT and Peripherals**

PERIPHERAL MANUFACTURER	MODEL NUMBER	SERIAL NUMBER	FCC ID and IC:	CABLES P/D
Inventek Systems (EUT)	ISM43362-M3G-L44-E, ISM43362-M3G-L44-U	Engineering Sample	Pending FCC ID:O7P-362 IC: 10147A-362	USB to Micro USB 1 meter U - P
Asus Netbook	Various	--	Various	2 meter U - P
Power Supply Asus	Various	--	None	2 meter U - P 120 VAC/ 60 Hz
Laptop Computer IBM	Various	--	Various	2 meter U - P
Power Supply IBM	Various	--	None	2 meter U - P 120 VAC/ 60 Hz

US Tech Test Report:  
 FCC ID:  
 IC ID:  
 Test Report Number:  
 Issue Date:  
 Customer:  
 Model(s):

FCC Part 15 Certification & IC RSS  
 O7P-362  
 10147A-362  
 13-0186  
 July 29, 2013  
 Inventek Systems  
 ISM43362-M3G-L44-E and ISM43362-M3G-L44-U

## 2 Tests and Measurements

### 2.1 Test Equipment

Table 2 below lists test equipment used to evaluate this product. Model numbers, serial numbers and their calibration status are included herein.

**Table 2. Test Instruments**

TEST INSTRUMENT	MODEL NUMBER	MANUFACTURER	SERIAL NUMBER	DATE OF LAST CALIBRATION*
SPECTRUM ANALYZER	E4407B	Agilent	US41442935	10/29/2012
SPECTRUM ANALYZER	8566B	HEWLETT-PACKARD	2410A00109	11/21/2012
RF PREAMP 100 kHz to 1.3 GHz	8447D	HEWLETT-PACKARD	2944A07436	3/4/2013
LOOP ANTENNA 0.09 MHz to 30 MHz	SAS-200/562	Electro-Metrics	142	8/9/2011 2 Year
BICONICAL ANTENNA 25 MHz to 200 MHz	3110	EMCO	9306-1708	7/02/2012 2 Year
LOG PERIODIC 100 MHz to 1000 MHz	3146	EMCO	9110-3236	11/22/2013 2 Year
HORN ANTENNA 1 GHz to 18 GHz	3115	EMCO	9107-3723	8/10/2011 2 Year
HORN ANTENNA 18 GHz to 26 GHz	3116	EMCO	9505-2255	8/09/2012 2 Year
PREAMP 1 GHz to 26.5 GHz	8449B	HEWLETT-PACKARD	3008A00480	3/4/2013
LISN	8028-50-TS24-BNC	Solar Electronics	910495 & 910494	3/1/2013
CALCULATION PROGRAM	N/A	N/A	Ver. 6.0	N/A

**Note: The calibration interval of the above test instruments are 12 months unless stated otherwise and all calibrations are traceable to NIST/USA.**

US Tech Test Report:  
FCC ID:  
IC ID:  
Test Report Number:  
Issue Date:  
Customer:  
Model(s):

FCC Part 15 Certification & IC RSS  
O7P-362  
10147A-362  
13-0186  
July 29, 2013  
Inventek Systems  
ISM43362-M3G-L44-E and ISM43362-M3G-L44-U

## 2.2 Modifications to EUT Hardware

No modifications were made by US Tech in order to bring the EUT into compliance with FCC Part 15, Subpart C Intentional Radiator Limits for the transmitter portion of the EUT or the Subpart B Unintentional Radiator Limits (Receiver and Digital Device) Requirements.

## 2.3 Number of Measurements for Intentional Radiators (15.31(m))

Measurements of intentional radiators or receivers shall be performed and reported for each band in which the device can be operated with the device operating at the number of frequencies in each band specified in Table 3 as follows:

**Table 3. Number of Test Frequencies for Intentional Radiators**

Frequency Range over which the device operates	Number of Frequencies	Location in the Range of operation
1 MHz or less	1	Middle
1 to 10 MHz	2	1 near the top 1 near the bottom
Greater than 10 MHz	3	1 near top 1 near middle 1 near bottom

Because the EUT operates over 2.4 GHz to 2.4835 GHz, 3 test frequencies will be used.

US Tech Test Report:  
FCC ID:  
IC ID:  
Test Report Number:  
Issue Date:  
Customer:  
Model(s):

FCC Part 15 Certification & IC RSS  
O7P-362  
10147A-362  
13-0186  
July 29, 2013  
Inventek Systems  
ISM43362-M3G-L44-E and ISM43362-M3G-L44-U

---

## **2.4 Frequency Range of Radiated Measurements (Part 15.33)**

### **Intentional Radiator**

The spectrum shall be investigated for the intentional radiator from the lowest RF signal generated in the EUT, without going below 9 kHz to the 10<sup>th</sup> harmonic of the highest fundamental frequency generated or 40 GHz, whichever is the lowest.

### **Unintentional Radiator**

For the digital device, an unintentional radiator, the frequency range shall be 30 MHz to 1000 MHz, or to the range specified in 2.4.1 above, whichever is the higher range of investigation.

## **2.5 Measurement Detector Function and Bandwidth (CFR 15.35)**

The radiated and conducted emissions limits shown herein are based on the following:

### **Detector Function and Associated Bandwidth**

On frequencies below 1000 MHz, the limits herein are based upon measurement equipment employing a CISPR Quasi-peak detector function and related measurement bandwidths (i.e. 9 kHz from 150 kHz to 30 MHz and 120 kHz from 30 MHz to 1000 MHz). Alternatively, measurements may be made with equipment employing a peak detector function as long as the same bandwidths specified for the Quasi-peak device are used.

### **Corresponding Peak and Average Requirements**

Above 1000 MHz, radiated limits are based on measuring instrumentation employing an average detector function. When average radiated emissions are specified there is also a corresponding Peak requirement, as measured using a peak detector, of 20 dB greater than the average limit. For all measurements above 1000 MHz the Resolution Bandwidth shall be at least 1 MHz.

### **Pulsed Transmitter Averaging**

When the radiated emissions limit is expressed as an average value, and the transmitter is pulsed, the measured field strength shall be determined by applying a Duty Cycle Correction Factor based upon dividing the total ON time during the first 100 ms period by 100 ms (or by the period if less than 100 ms). The duty cycle may also be expressed logarithmically in dB. Please section 2.8 herein for details.

US Tech Test Report:  
FCC ID:  
IC ID:  
Test Report Number:  
Issue Date:  
Customer:  
Model(s):

FCC Part 15 Certification & IC RSS  
O7P-362  
10147A-362  
13-0186  
July 29, 2013  
Inventek Systems  
ISM43362-M3G-L44-E and ISM43362-M3G-L44-U

## 2.6 EUT Antenna Requirements (CFR 15.203)

An intentional radiator shall be designed to ensure that no antenna other than that furnished by the responsible party shall be used with the device. The use of a permanently attached antenna or of an antenna that uses a unique coupling to the intentional radiator shall be considered sufficient to comply with the provisions of this section. The EUT has a built in antenna; there is no obvious method of attaching a different antenna.

**Table 4. Allowed Antenna(s)**

MANUFACTURER	TYPE OF ANTENNA	MODEL	GAIN dB <sub>i</sub>	TYPE OF CONNECTOR	Report Reference
Inventek Systems	Trace antenna	Trace	0	Permanent integral	Antenna 1
Inventek Systems	Dipole (Bow Tie) antenna	W24P-U	2.15	Unique connector	Antenna 2



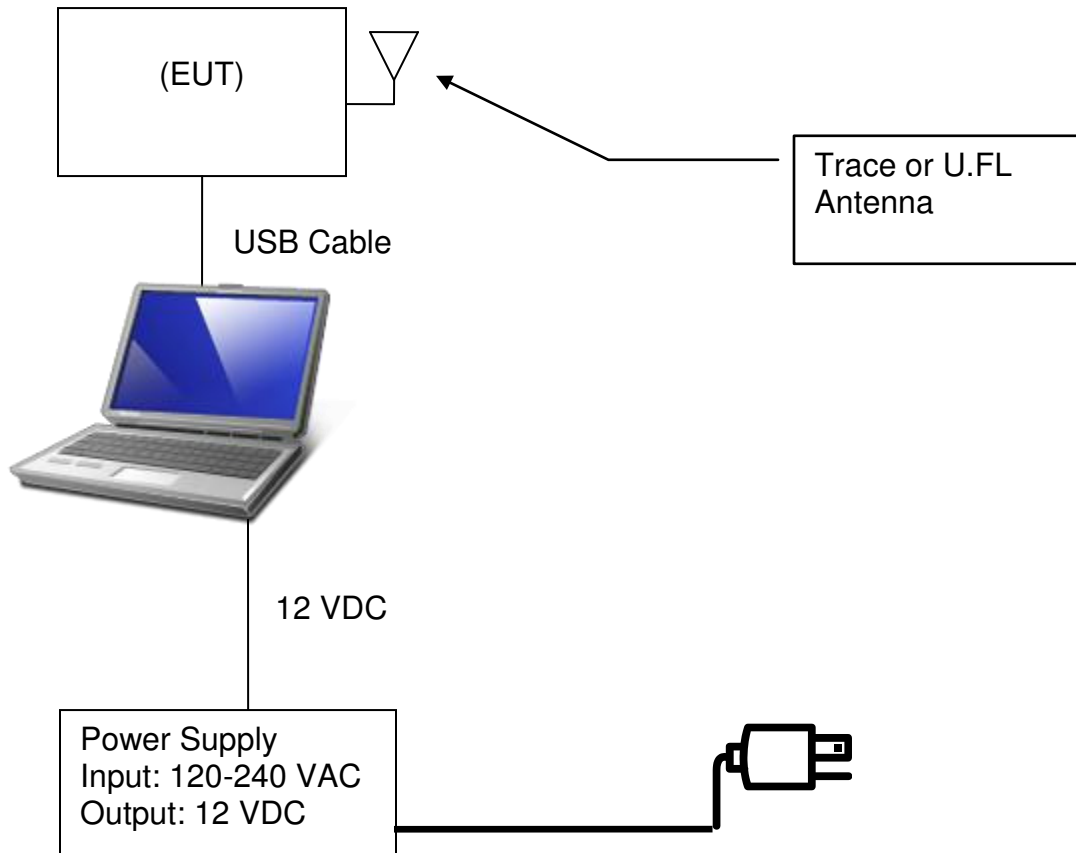

**Figure 1. Test Configuration**

## 2.7 Restricted Bands of Operation (Part 15.205)

Only spurious emissions can fall in the frequency bands of CFR 15.205. The field strength of these spurious cannot exceed the limits of 15.209. Radiated harmonics and other Spurious are examined for this requirement see paragraph 2.10.

## 2.8 Transmitter Duty Cycle (CFR 35 (c))

The duty cycle de-rating factor used in the calculation of average radiated limits (per CFR 15.209 and 15.35(c)) is described below. This factor was calculated by first determining the worst case scenario for system operation.

The worst-case scenario in any 100 ms timeslot, along with all transmission lengths, will be as follows:

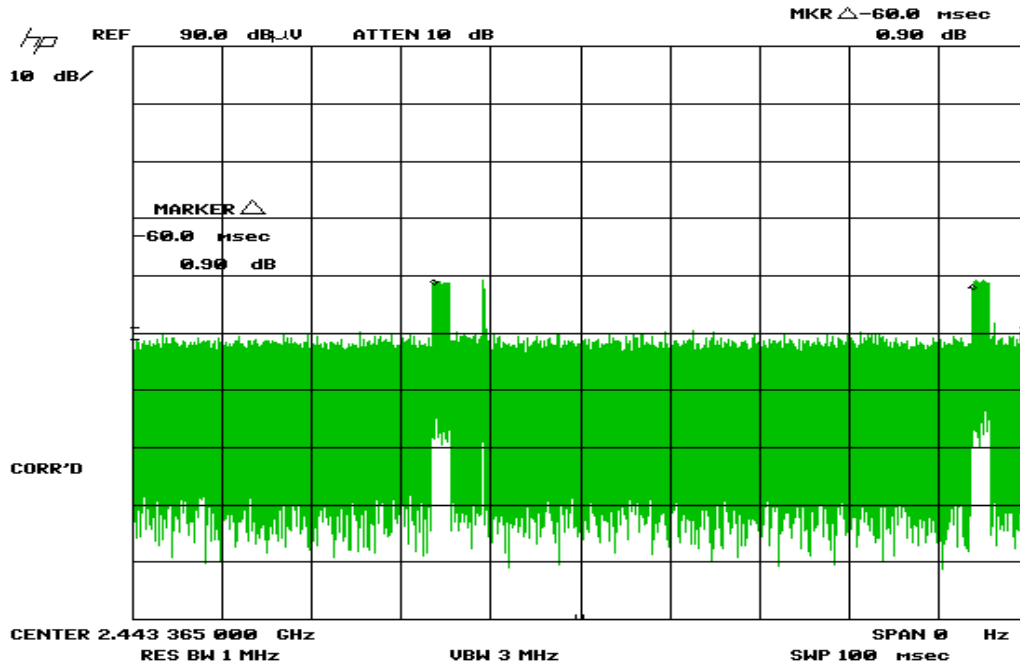
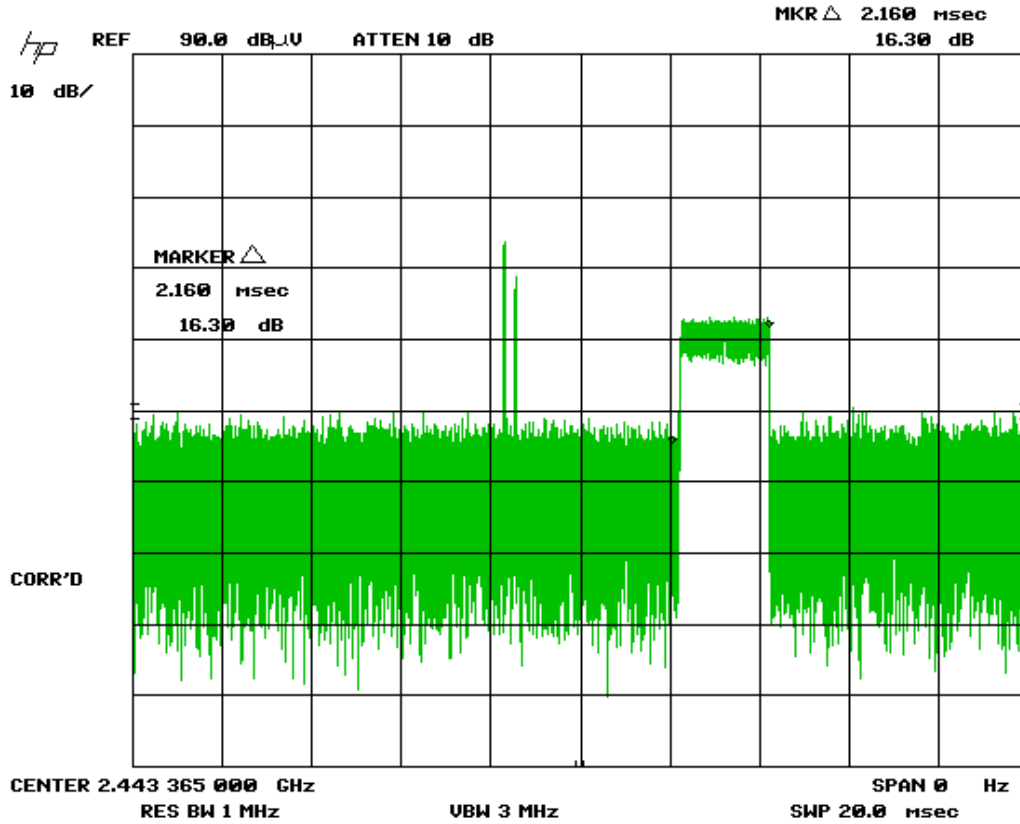

Figure 2. Duty Cycle, Plot 1



**Figure 3. Duty Cycle, Plot 2**

The duty cycle is computed as follows (in any 100 ms period):

$$\text{Duty Cycle} = 2.16 \times 2 = 4.32 \text{ msec in } 100 \text{ msec}$$

$$\text{Correction Factor} = 20\log_{10}(4.32/100\text{ms}) = \text{[-13.65 dB]}$$

US Tech Test Report:  
 FCC ID:  
 IC ID:  
 Test Report Number:  
 Issue Date:  
 Customer:  
 Model(s):

FCC Part 15 Certification & IC RSS  
 O7P-362  
 10147A-362  
 13-0186  
 July 29, 2013  
 Inventek Systems  
 ISM43362-M3G-L44-E and ISM43362-M3G-L44-U

## 2.9 Intentional Radiator, Power Lines Conducted Emissions (CFR 15.207)

The power line conducted voltage emission measurements have been carried out in accordance with CFR 15.207, per ANSI C63.4:2003, Paragraph 7, with a spectrum analyzer connected to an LISN and the EUT placed into a continuous mode of transmission.

The worst-case results for conducted emissions were determined to be produced when the EUT was operating under continuous transmission on the low channel.

**Table 5. Conducted Emissions for intentional Radiator**

Conducted Emissions Tested from 150 KHz to 30 MHz						
Tested By: SS	FCC Part 15.207 Class B		Project No.: 13-0186	Manufacturer: Inventek Systems Model: ISM43362-M3G-L44-E, ISM43362-M3G-L44-U		
Frequency (MHz)	Test Data (dBuV)	LISN+CL-PA (dB)	Corrected Results (dBuV)	Avg Limits (dBuV)	Margin (dB)	Detector
<b>120 VAC, 60 Hz, Phase Line</b>						
0.1500	50.50	1.65	52.15	56.0	3.8	QP
0.6279	38.70	0.43	39.13	46.0	6.9	QP
3.8560	41.50	0.38	41.88	46.0	4.1	PK
9.3100	42.70	0.46	43.16	50.0	6.8	PK
11.7300	44.20	0.49	44.69	50.0	5.3	PK
20.1100	39.90	0.61	40.51	50.0	9.5	PK
<b>120 VAC, 60 Hz, Neutral Line</b>						
0.1565	49.20	1.50	50.70	55.6	5.0	QP
0.6194	43.00	0.42	43.42	*56.0	12.6	QP
0.6194	42.70	0.42	43.12	46.0	2.9	AVG
2.6600	37.00	0.36	37.36	46.0	8.6	QP
9.9100	42.20	0.46	42.66	50.0	7.3	PK
12.3400	44.90	0.49	45.39	50.0	4.6	PK
20.4300	42.00	0.61	42.61	50.0	7.4	PK

SAMPLE CALCULATIONS: At 20.43 MHz = 42.0 + (0.61) = 42.61 dBuV

(\*)= denotes quasi-peak measurement used.

Test Date: June 13, 2013

Tested By

Signature: Sina Sabhaniyan

Name: Sina Sabhaniyan

US Tech Test Report:  
FCC ID:  
IC ID:  
Test Report Number:  
Issue Date:  
Customer:  
Model(s):

FCC Part 15 Certification & IC RSS  
O7P-362  
10147A-362  
13-0186  
July 29, 2013  
Inventek Systems  
ISM43362-M3G-L44-E and ISM43362-M3G-L44-U

---

## **2.10 Intentional Radiator, Radiated Emissions (Antenna Conducted) (CFR 15.209, 15.247(d)) (IC RSS 210, A2.9 (a))**

The EUT was put into a continuous-transmit mode of operation and tested per FCC KDB Publication 558074 for conducted out of band emissions emanating from the antenna port over the frequency range of 30 MHz to 25.0 GHz. A conducted scan was performed on the EUT to identify and record spurious signals that were related to the transmitter. Antenna Conducted Emissions of a significant magnitude that fell within restricted bands were then measured as radiated emissions on the OATS. The conducted emissions graphs are found in the following figures. The limit for antenna conducted power is 1 Watt (30 dBm) per 15.247 (b)(3).

For radiated measurements, the EUT was set into a continuous transmission mode. From 9 kHz to 30 MHz the RBW was set to 10 kHz, below 1 GHz, the RBW of the measuring instrument was set equal to 120 kHz. Peak measurements above 1 GHz were measured using a RBW = 1 MHz, with a VBW  $\geq$  RBW. The results of peak radiated spurious emissions falling within restricted bands are given in the test tables below.

For Average Voltage measurements above 1 GHz, the emissions were measured using RBW = 1 MHz and VBW = 10 Hz. For a pulse-modulated transmitter, the EUT's average emissions are further modified by adding to them the worst-case duty cycle, determined by adding the EUT's total pulse widths (on time) over a 100 ms period and dividing by 100 ms.

US Tech Test Report:  
FCC ID:  
IC ID:  
Test Report Number:  
Issue Date:  
Customer:  
Model(s):

FCC Part 15 Certification & IC RSS  
O7P-362  
10147A-362  
13-0186  
July 29, 2013  
Inventek Systems  
ISM43362-M3G-L44-E and ISM43362-M3G-L44-U

---

## 2.10 Intentional Radiator, Radiated Emissions (CFR 15.209, 15.247(d)) (IC RSS 210, A2.9 (a)) (Cont'd).

On the OATS, the EUT was mounted on top of a non-conductive table, 80 cm above the floor, by placing it in the X, Y, Z plane along the Z axis with its bottom cover in parallel with the ground. The front of the EUT faced the measurement antenna located 3 meters away. Each signal measured was maximized by raising and lowering the receive antenna between 1 and 4 meters in height while monitoring the ever changing spectrum analyzer display (with channel A in the Clear-Write mode and channel B in the Max-Hold mode) for the largest signal visible. That exact antenna height where the signal was maximized was recorded for reproducibility purposes. Also, the EUT was rotated about its Y-axis while monitoring the Spectrum Analyzer display for maximum. The EUT azimuth was recorded for reproducibility purposes. The EUT was measured when both maxima were simultaneously satisfied.

The test data is detailed below in for this section. Several radiated emissions above 1 GHz were measured at a distance of 1 meter. The measured value at 1 meter was then extrapolated to the resultant at 3 meters using an inverse distance extrapolation factor of -20 dB/decade. There were no test failures.

US Tech Test Report:  
FCC ID:  
IC ID:  
Test Report Number:  
Issue Date:  
Customer:  
Model(s):

FCC Part 15 Certification & IC RSS  
O7P-362  
10147A-362  
13-0186  
July 29, 2013  
Inventek Systems  
ISM43362-M3G-L44-E and ISM43362-M3G-L44-U

### 2.10.1 Conducted Radiated Emissions, IEEE 802.11b, Channel 1

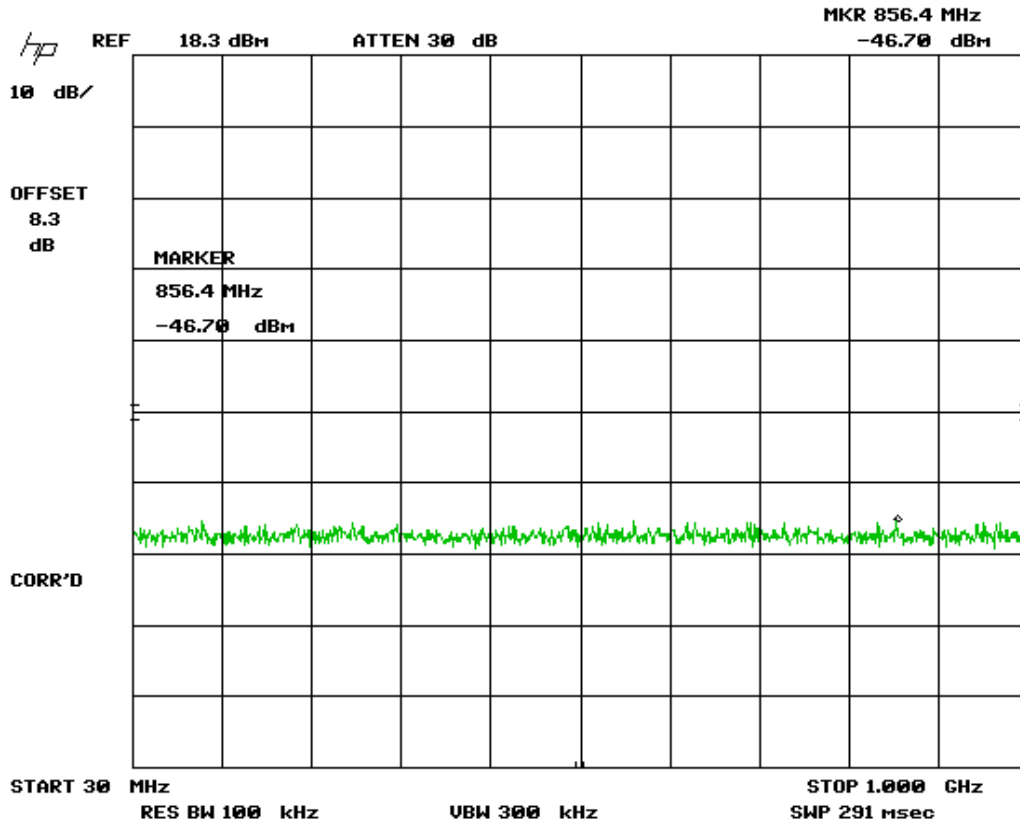

Figure 4. Emissions 802.11b - Low Channel, Part 1

US Tech Test Report:  
FCC ID:  
IC ID:  
Test Report Number:  
Issue Date:  
Customer:  
Model(s):

FCC Part 15 Certification & IC RSS  
O7P-362  
10147A-362  
13-0186  
July 29, 2013  
Inventek Systems  
ISM43362-M3G-L44-E and ISM43362-M3G-L44-U

Note: Large Signal shown is Fundamental Frequency

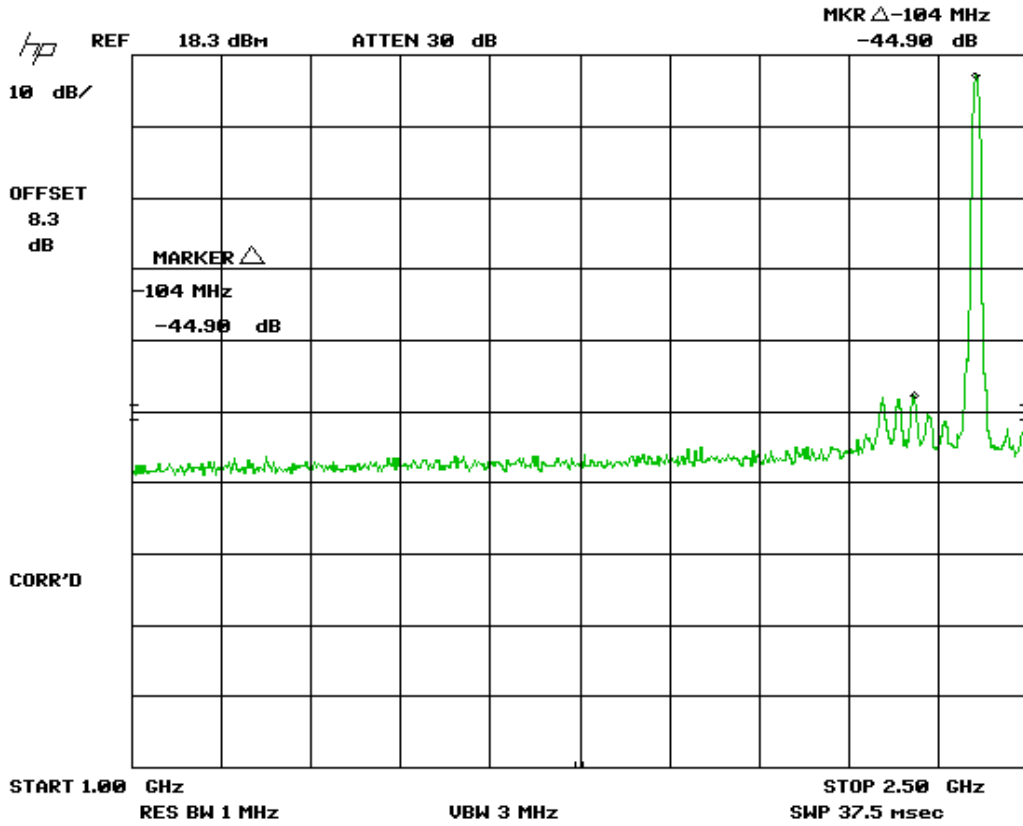

Figure 5. Emissions 802.11b - Low Channel, Part 2



US Tech Test Report:  
FCC ID:  
IC ID:  
Test Report Number:  
Issue Date:  
Customer:  
Model(s):

FCC Part 15 Certification & IC RSS  
O7P-362  
10147A-362  
13-0186  
July 29, 2013  
Inventek Systems  
ISM43362-M3G-L44-E and ISM43362-M3G-L44-U

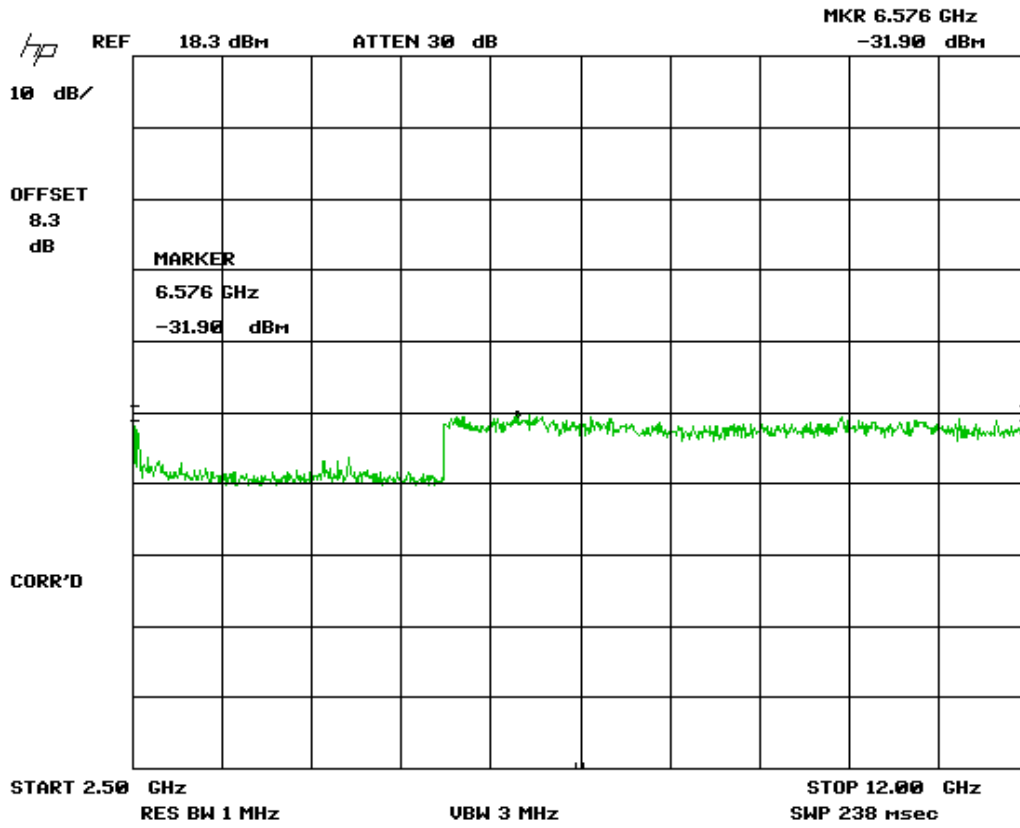

Figure 6. Emissions 802.11b - Low Channel, Part 3

US Tech Test Report:  
FCC ID:  
IC ID:  
Test Report Number:  
Issue Date:  
Customer:  
Model(s):

FCC Part 15 Certification & IC RSS  
O7P-362  
10147A-362  
13-0186  
July 29, 2013  
Inventek Systems  
ISM43362-M3G-L44-E and ISM43362-M3G-L44-U

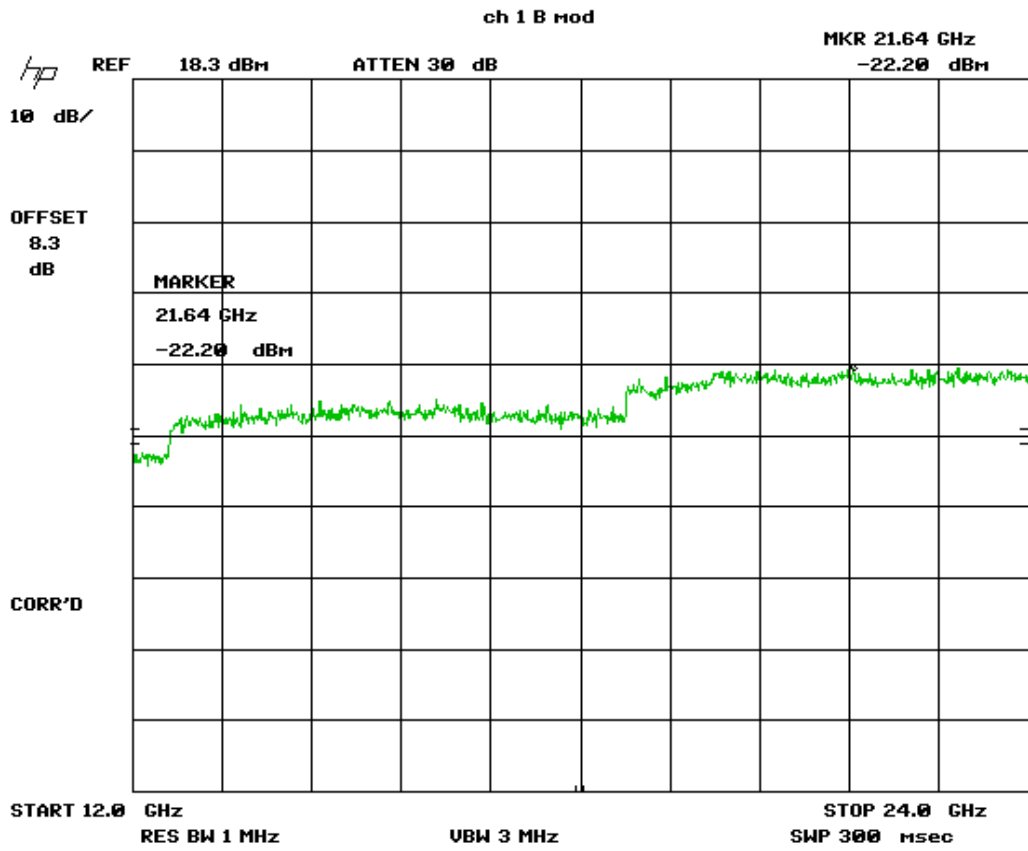

Figure 7. Emissions 802.11b - Low Channel, Part 4

US Tech Test Report:  
FCC ID:  
IC ID:  
Test Report Number:  
Issue Date:  
Customer:  
Model(s):

FCC Part 15 Certification & IC RSS  
O7P-362  
10147A-362  
13-0186  
July 29, 2013  
Inventek Systems  
ISM43362-M3G-L44-E and ISM43362-M3G-L44-U

### 2.10.2 Conducted Radiated Emissions, IEEE 802.11b, Channel 7

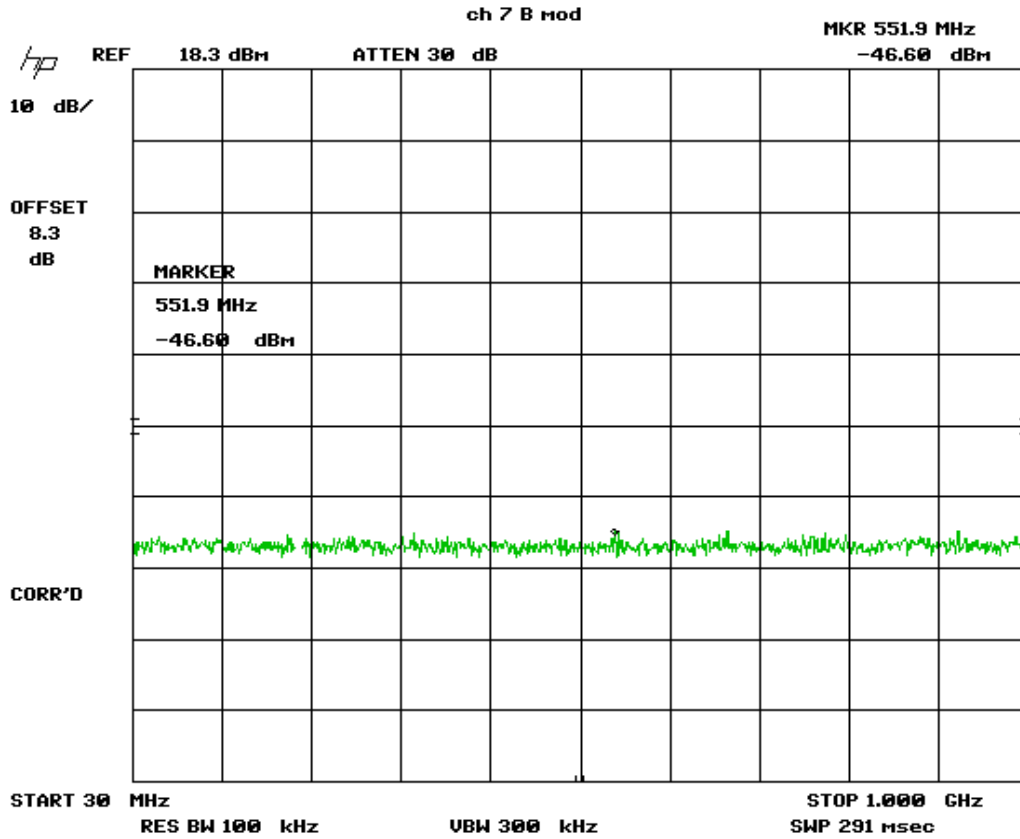

Figure 8. Emissions 802.11b - Mid Channel, Part 1

US Tech Test Report:  
FCC ID:  
IC ID:  
Test Report Number:  
Issue Date:  
Customer:  
Model(s):

FCC Part 15 Certification & IC RSS  
O7P-362  
10147A-362  
13-0186  
July 29, 2013  
Inventek Systems  
ISM43362-M3G-L44-E and ISM43362-M3G-L44-U

Note: Large Signal shown is Fundamental Frequency

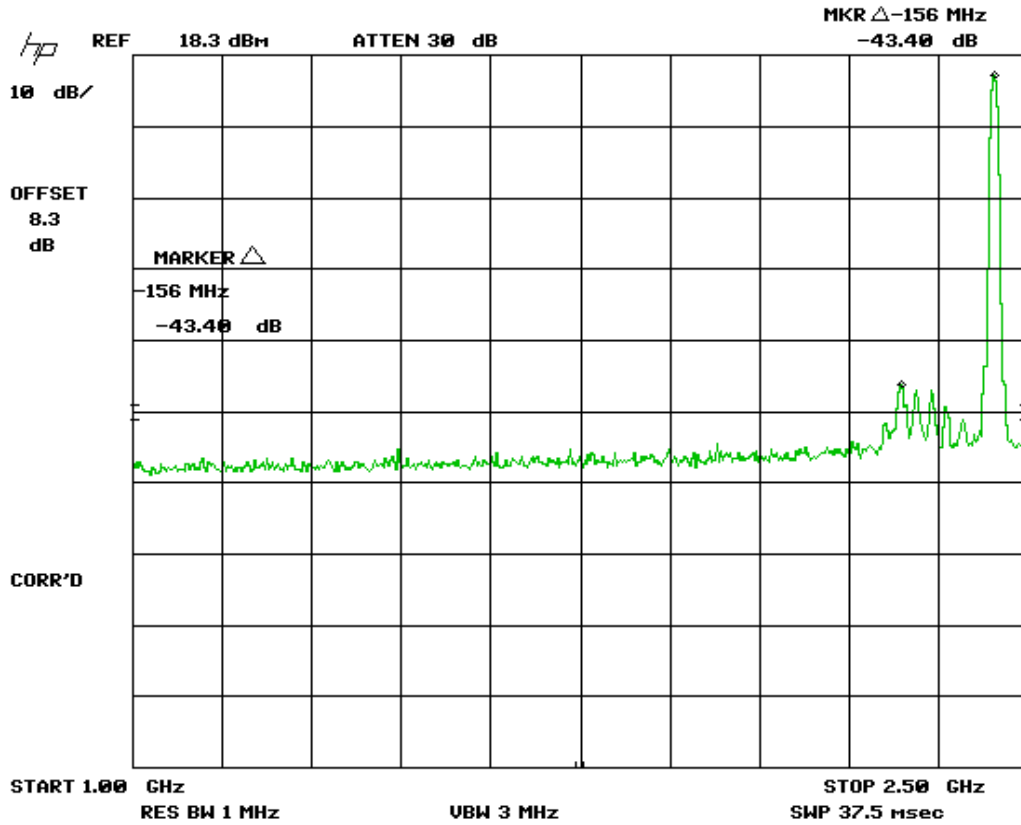

Figure 9. Emissions 802.11b - Mid Channel, Part 2

US Tech Test Report:  
FCC ID:  
IC ID:  
Test Report Number:  
Issue Date:  
Customer:  
Model(s):

FCC Part 15 Certification & IC RSS  
O7P-362  
10147A-362  
13-0186  
July 29, 2013  
Inventek Systems  
ISM43362-M3G-L44-E and ISM43362-M3G-L44-U

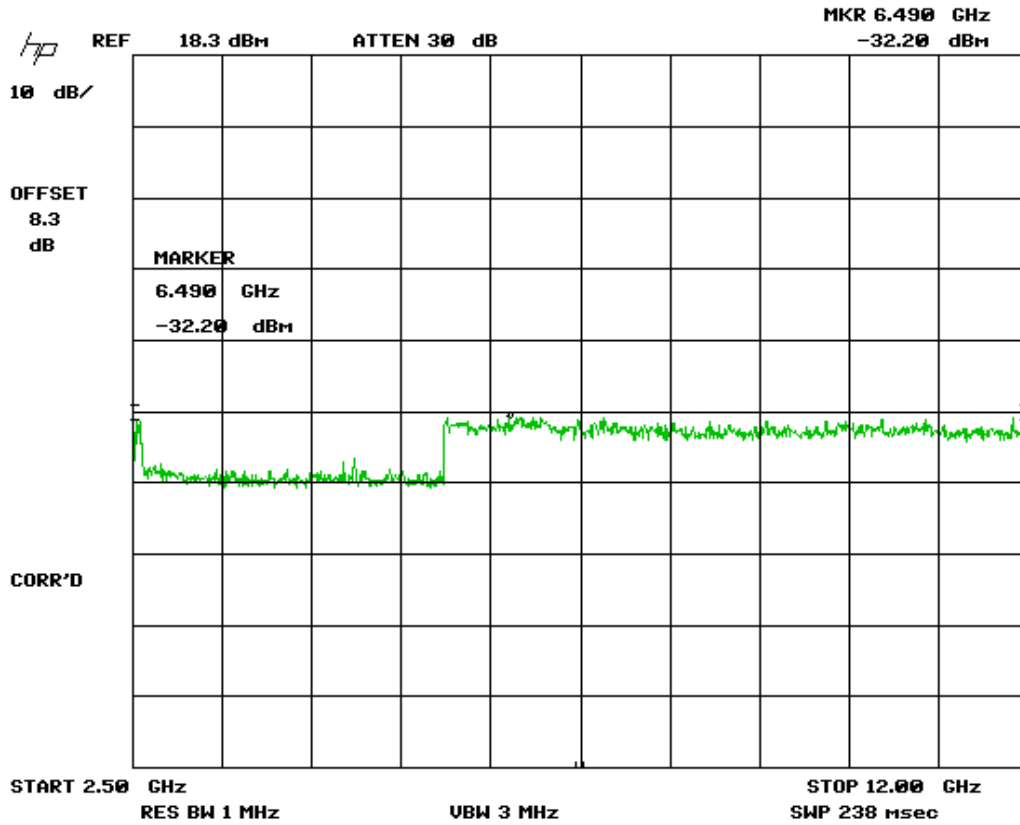

Figure 10. Emissions 802.11b - Mid Channel, Part 3

US Tech Test Report:  
FCC ID:  
IC ID:  
Test Report Number:  
Issue Date:  
Customer:  
Model(s):

FCC Part 15 Certification & IC RSS  
O7P-362  
10147A-362  
13-0186  
July 29, 2013  
Inventek Systems  
ISM43362-M3G-L44-E and ISM43362-M3G-L44-U

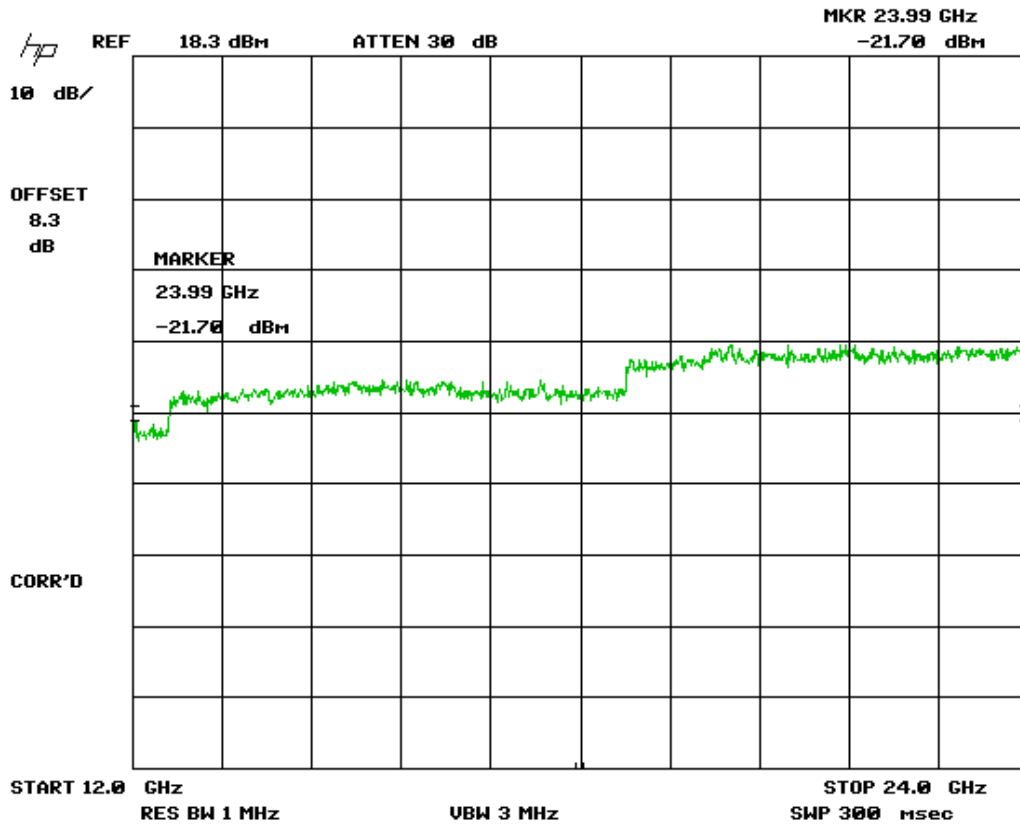

Figure 11. Emissions 802.11b - Mid Channel, Part 4

US Tech Test Report:  
FCC ID:  
IC ID:  
Test Report Number:  
Issue Date:  
Customer:  
Model(s):

FCC Part 15 Certification & IC RSS  
O7P-362  
10147A-362  
13-0186  
July 29, 2013  
Inventek Systems  
ISM43362-M3G-L44-E and ISM43362-M3G-L44-U

### 2.10.3 Conducted Radiated Emissions, IEEE 802.11b, Channel 11

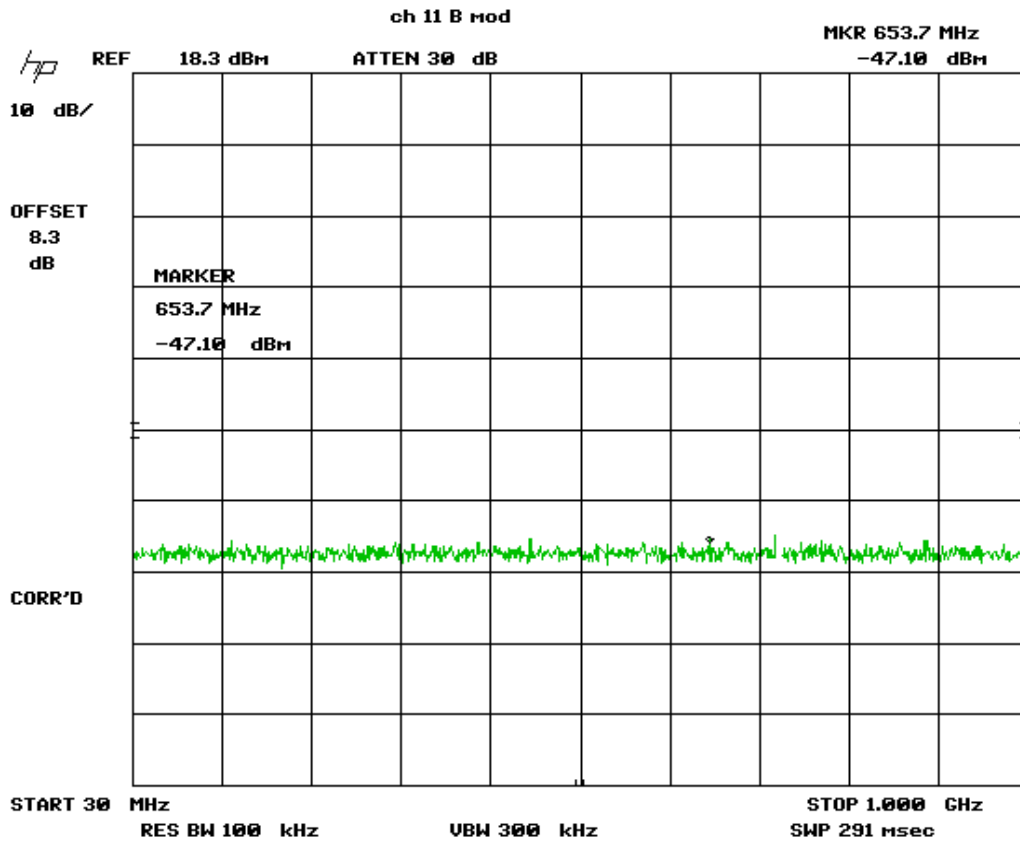

Figure 12. Emissions 802.11b - High Channel, Part 1

US Tech Test Report:  
FCC ID:  
IC ID:  
Test Report Number:  
Issue Date:  
Customer:  
Model(s):

FCC Part 15 Certification & IC RSS  
O7P-362  
10147A-362  
13-0186  
July 29, 2013  
Inventek Systems  
ISM43362-M3G-L44-E and ISM43362-M3G-L44-U

Note: Large Signal shown is Fundamental Frequency

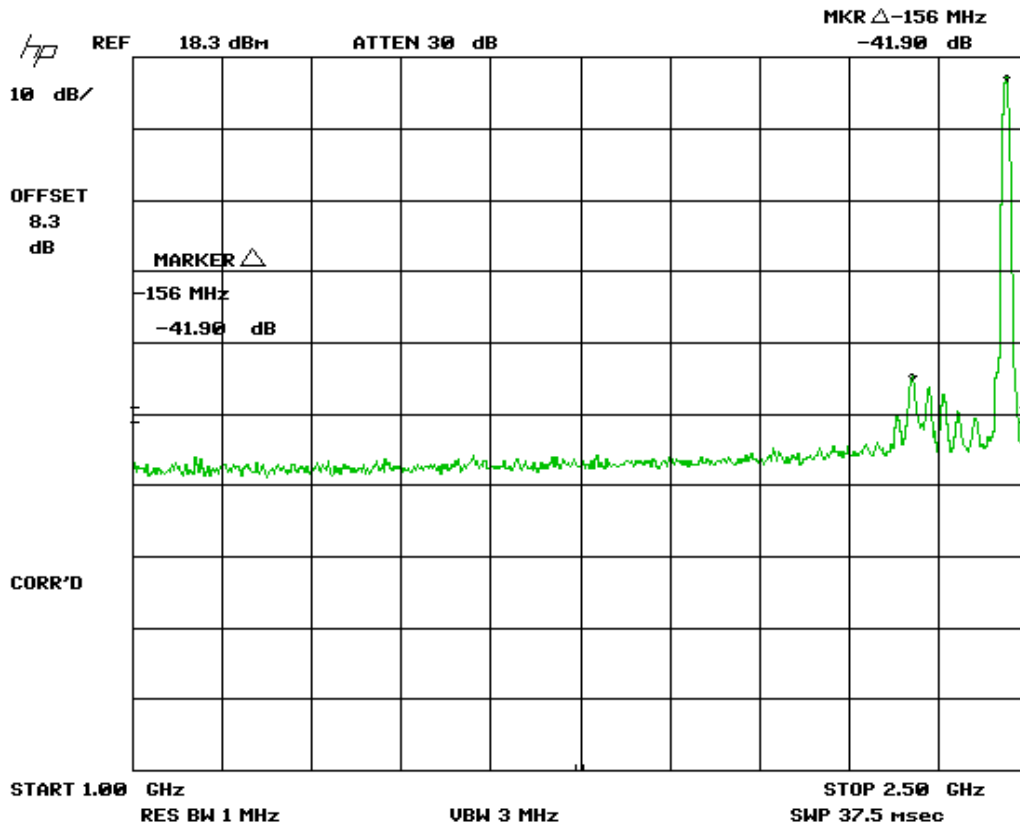

Figure 13. Emissions 802.11b - High Channel, Part 2



US Tech Test Report:  
FCC ID:  
IC ID:  
Test Report Number:  
Issue Date:  
Customer:  
Model(s):

FCC Part 15 Certification & IC RSS  
O7P-362  
10147A-362  
13-0186  
July 29, 2013  
Inventek Systems  
ISM43362-M3G-L44-E and ISM43362-M3G-L44-U

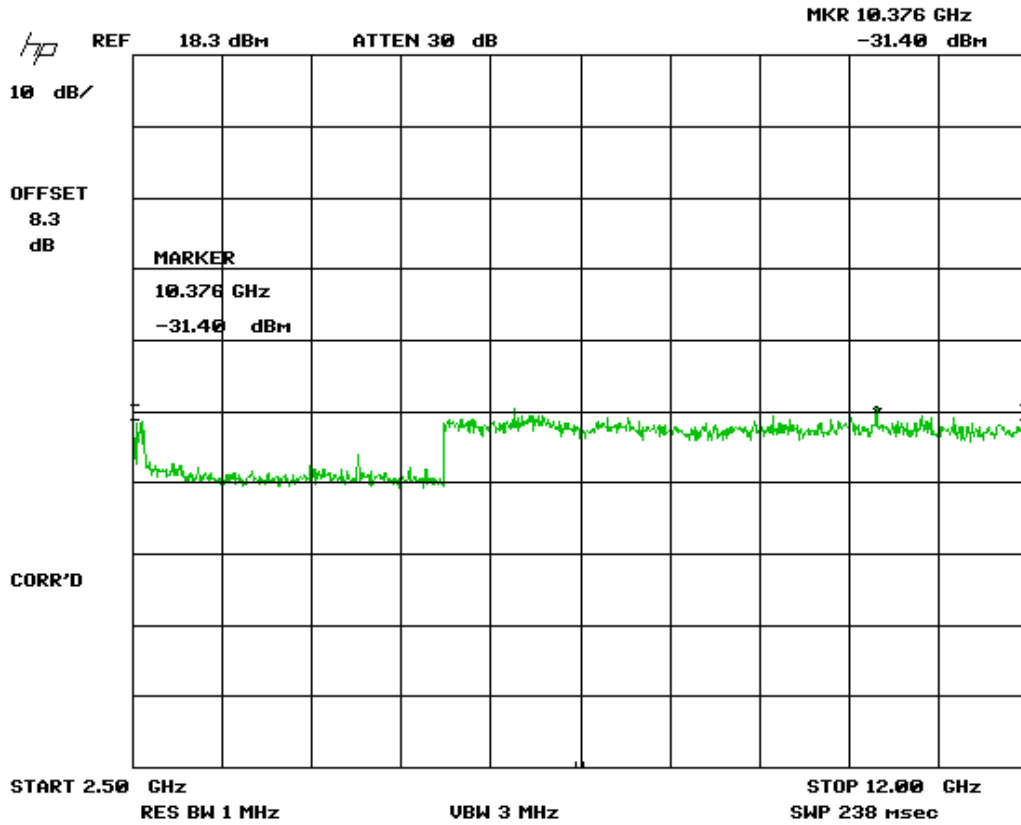

Figure 14. Emissions 802.11b - High Channel, Part 3

US Tech Test Report:  
FCC ID:  
IC ID:  
Test Report Number:  
Issue Date:  
Customer:  
Model(s):

FCC Part 15 Certification & IC RSS  
O7P-362  
10147A-362  
13-0186  
July 29, 2013  
Inventek Systems  
ISM43362-M3G-L44-E and ISM43362-M3G-L44-U

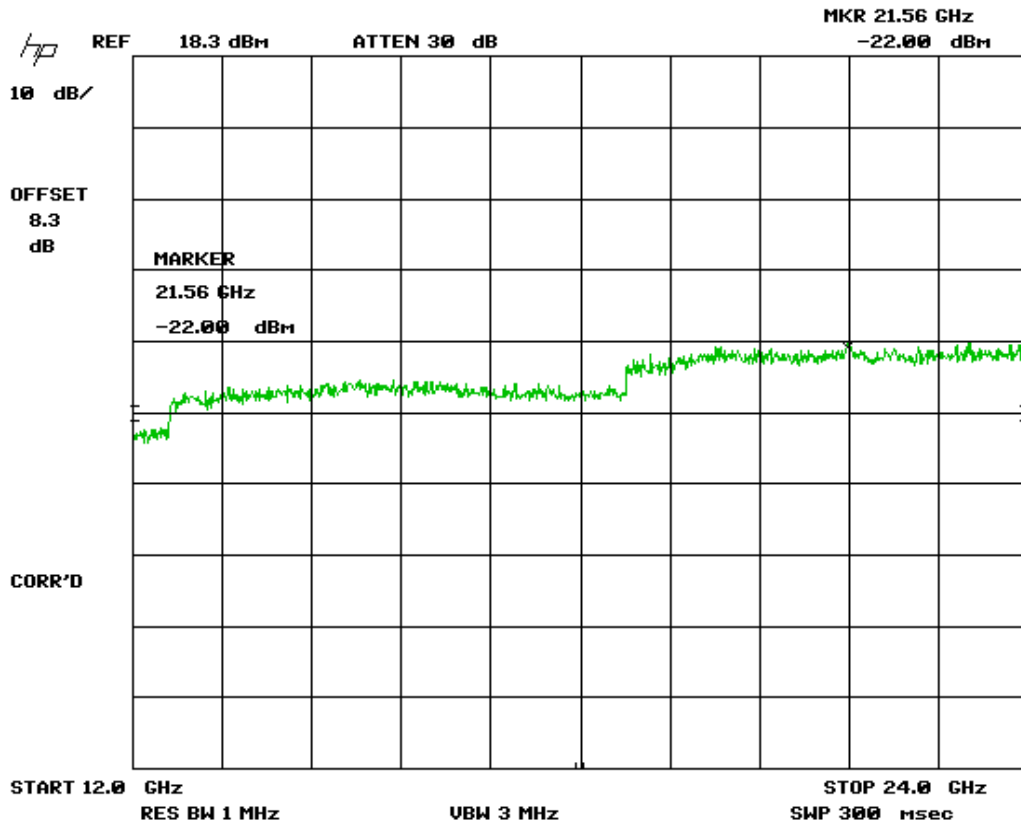

Figure 15. Emissions 802.11b - High Channel, Part 4

US Tech Test Report:  
FCC ID:  
IC ID:  
Test Report Number:  
Issue Date:  
Customer:  
Model(s):

FCC Part 15 Certification & IC RSS  
O7P-362  
10147A-362  
13-0186  
July 29, 2013  
Inventek Systems  
ISM43362-M3G-L44-E and ISM43362-M3G-L44-U

### 2.10.4 Conducted Radiated Emissions, IEEE 802.11g, Channel 1

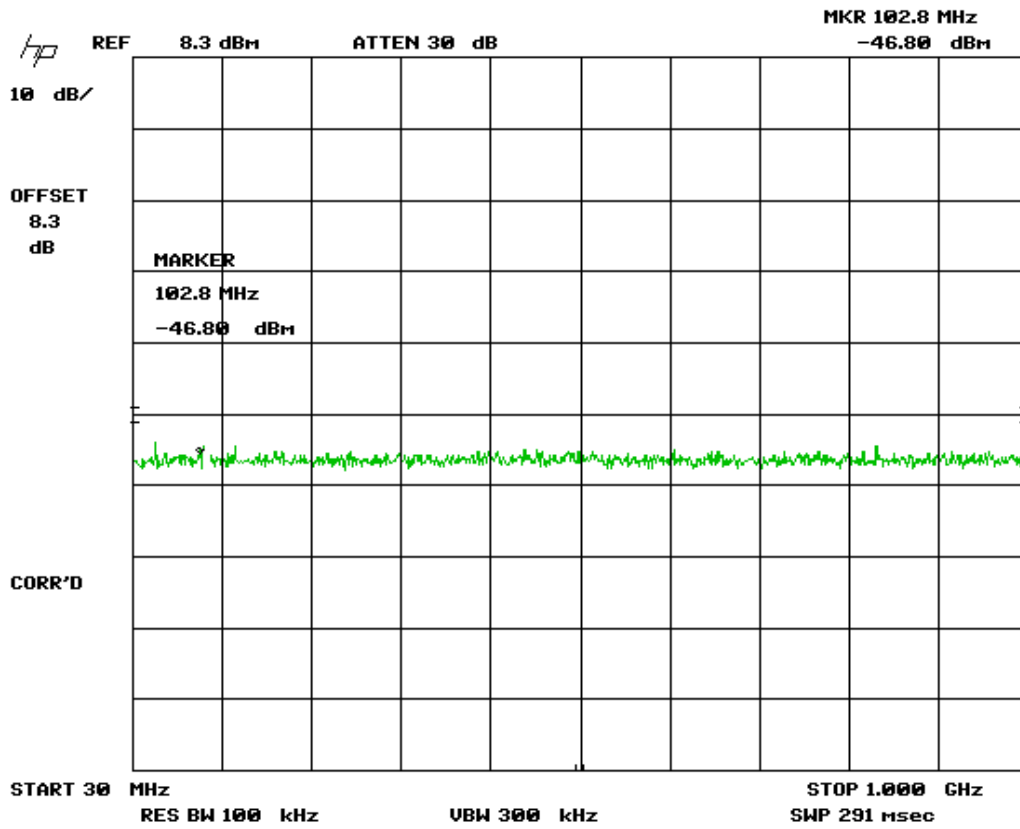

Figure 16. Emissions 802.11g - Low Channel, Part 1

US Tech Test Report:  
FCC ID:  
IC ID:  
Test Report Number:  
Issue Date:  
Customer:  
Model(s):

FCC Part 15 Certification & IC RSS  
O7P-362  
10147A-362  
13-0186  
July 29, 2013  
Inventek Systems  
ISM43362-M3G-L44-E and ISM43362-M3G-L44-U

Note: Large Signal shown is Fundamental Frequency

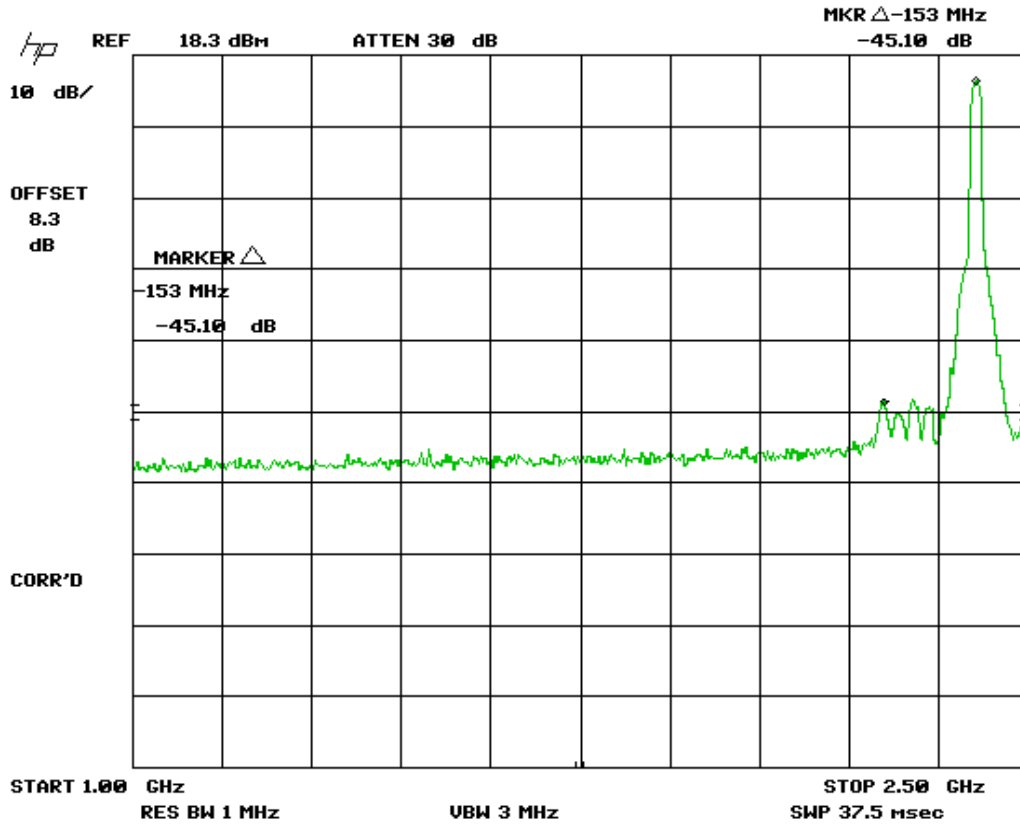

Figure 17. Emissions 802.11g - Low Channel, Part 2

US Tech Test Report:  
FCC ID:  
IC ID:  
Test Report Number:  
Issue Date:  
Customer:  
Model(s):

FCC Part 15 Certification & IC RSS  
O7P-362  
10147A-362  
13-0186  
July 29, 2013  
Inventek Systems  
ISM43362-M3G-L44-E and ISM43362-M3G-L44-U

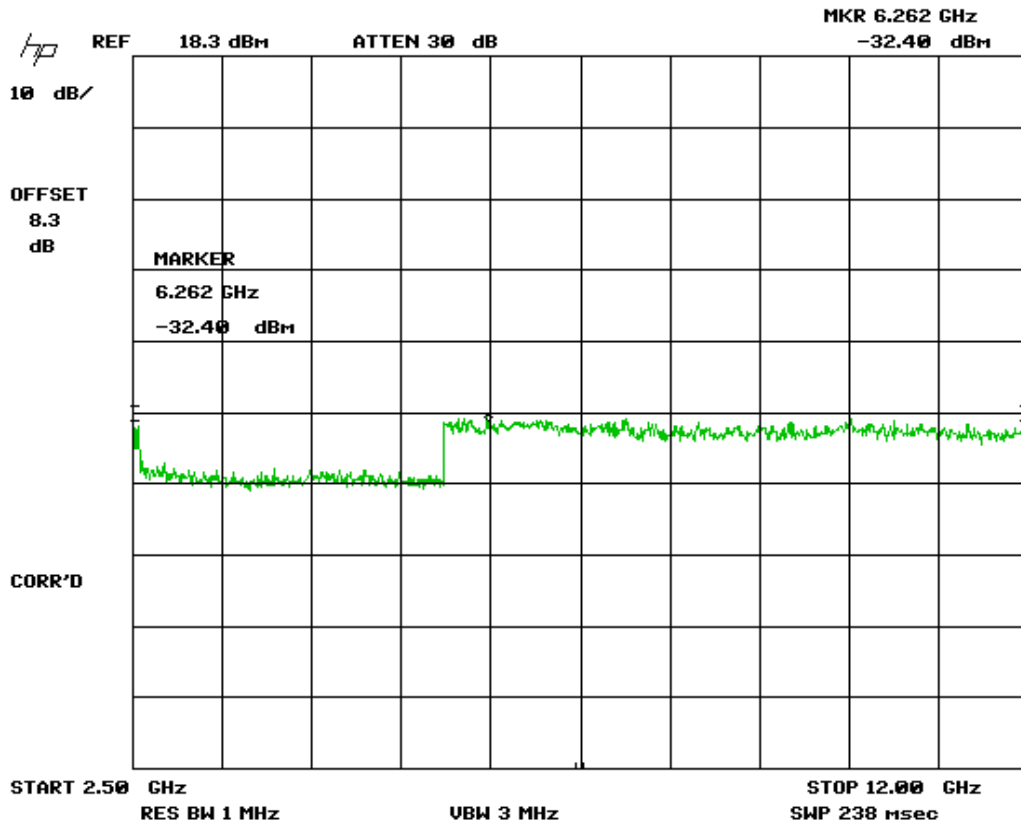

Figure 18. Emissions 802.11g - Low Channel, Part 3

US Tech Test Report:  
FCC ID:  
IC ID:  
Test Report Number:  
Issue Date:  
Customer:  
Model(s):

FCC Part 15 Certification & IC RSS  
O7P-362  
10147A-362  
13-0186  
July 29, 2013  
Inventek Systems  
ISM43362-M3G-L44-E and ISM43362-M3G-L44-U

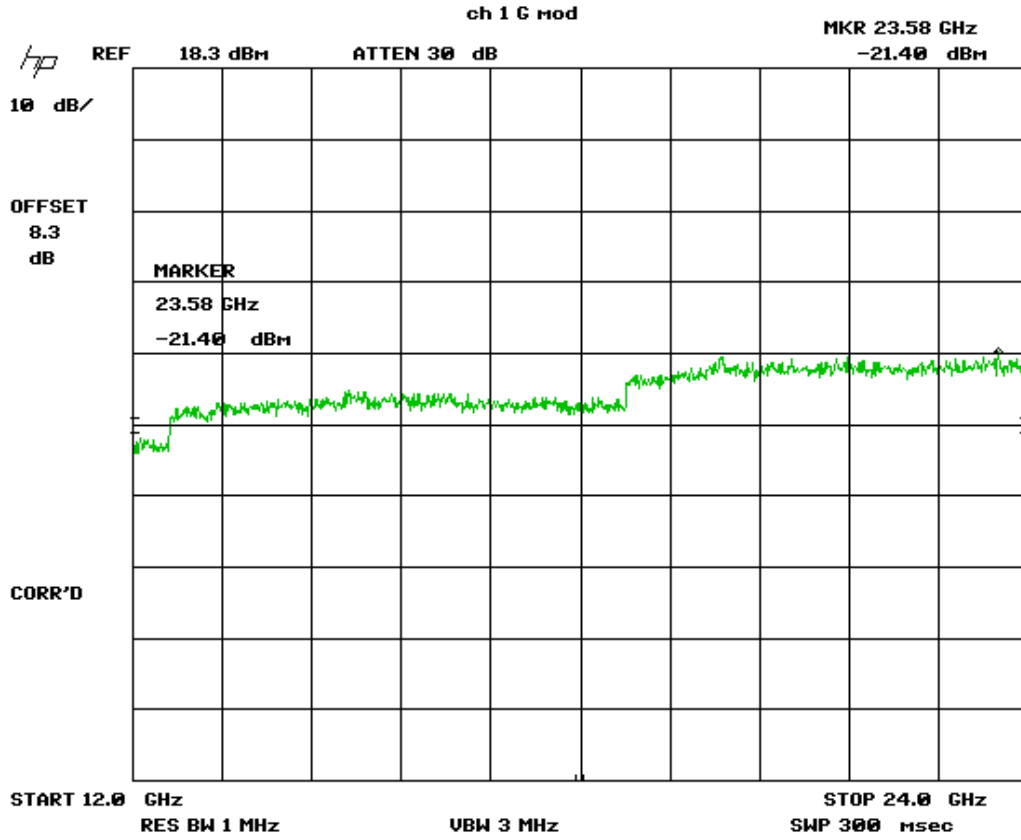

Figure 19. Emissions 802.11g - Low Channel, Part 4

US Tech Test Report:  
FCC ID:  
IC ID:  
Test Report Number:  
Issue Date:  
Customer:  
Model(s):

FCC Part 15 Certification & IC RSS  
O7P-362  
10147A-362  
13-0186  
July 29, 2013  
Inventek Systems  
ISM43362-M3G-L44-E and ISM43362-M3G-L44-U

### 2.10.5 Conducted Radiated Emissions, IEEE 802.11g, Channel 7

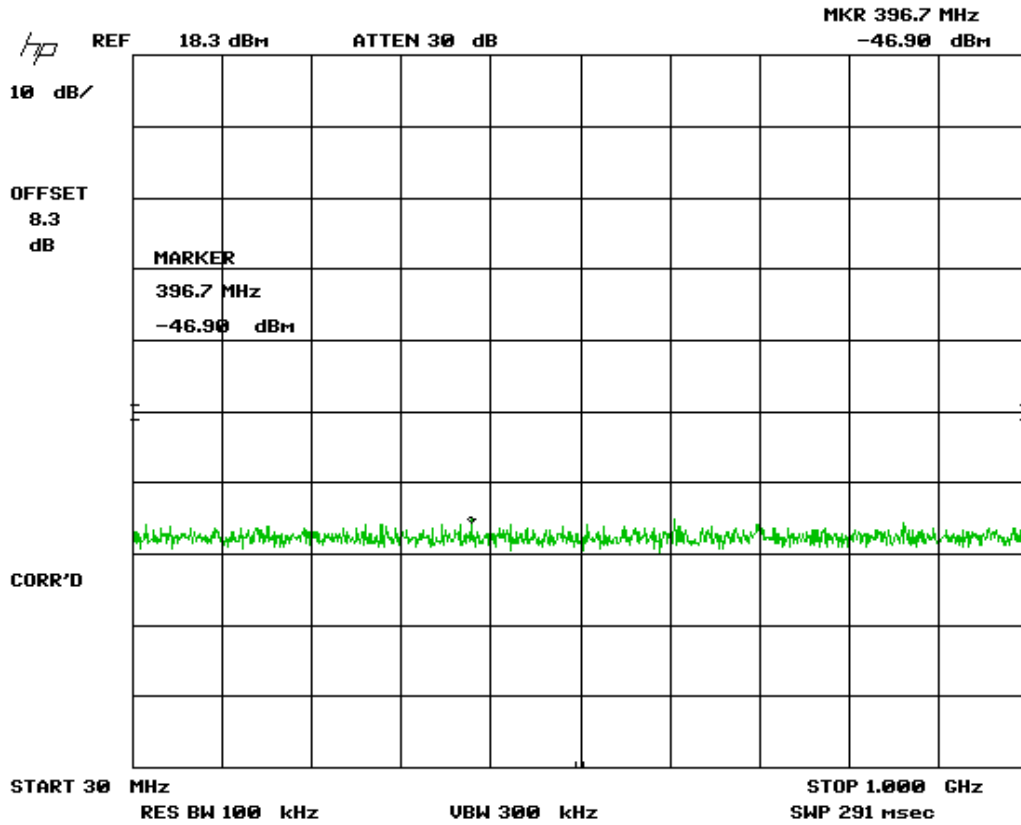

Figure 20. Emissions 802.11g - Mid Channel, Part 1

US Tech Test Report:  
FCC ID:  
IC ID:  
Test Report Number:  
Issue Date:  
Customer:  
Model(s):

FCC Part 15 Certification & IC RSS  
O7P-362  
10147A-362  
13-0186  
July 29, 2013  
Inventek Systems  
ISM43362-M3G-L44-E and ISM43362-M3G-L44-U

Note: Large Signal shown is Fundamental Frequency

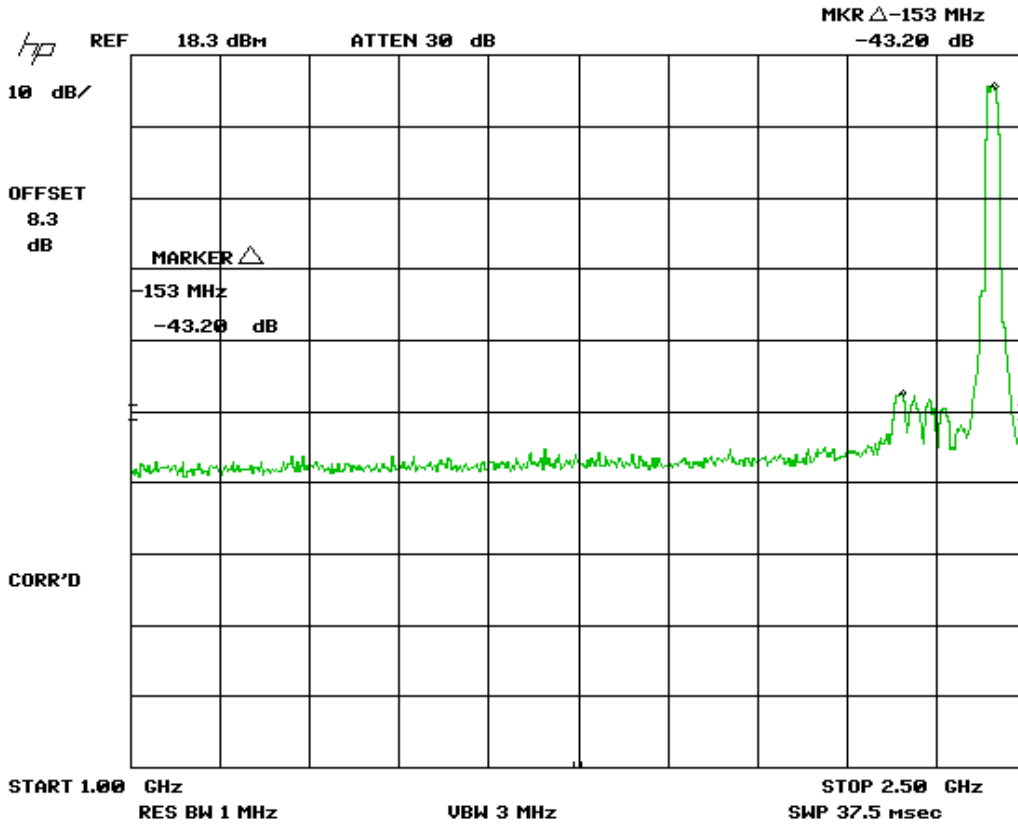

Figure 21. Emissions 802.11g - Mid Channel, Part 2



US Tech Test Report:  
FCC ID:  
IC ID:  
Test Report Number:  
Issue Date:  
Customer:  
Model(s):

FCC Part 15 Certification & IC RSS  
O7P-362  
10147A-362  
13-0186  
July 29, 2013  
Inventek Systems  
ISM43362-M3G-L44-E and ISM43362-M3G-L44-U

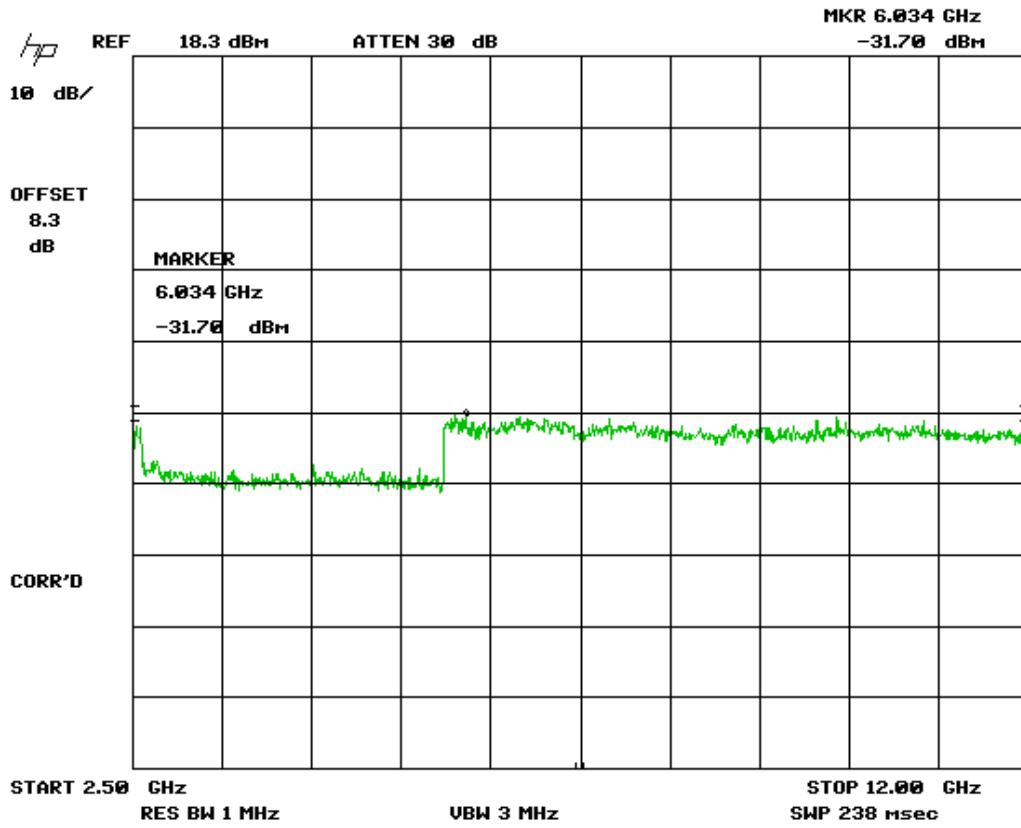

Figure 22. Emissions 802.11g - Mid Channel, Part 3

US Tech Test Report:  
FCC ID:  
IC ID:  
Test Report Number:  
Issue Date:  
Customer:  
Model(s):

FCC Part 15 Certification & IC RSS  
O7P-362  
10147A-362  
13-0186  
July 29, 2013  
Inventek Systems  
ISM43362-M3G-L44-E and ISM43362-M3G-L44-U

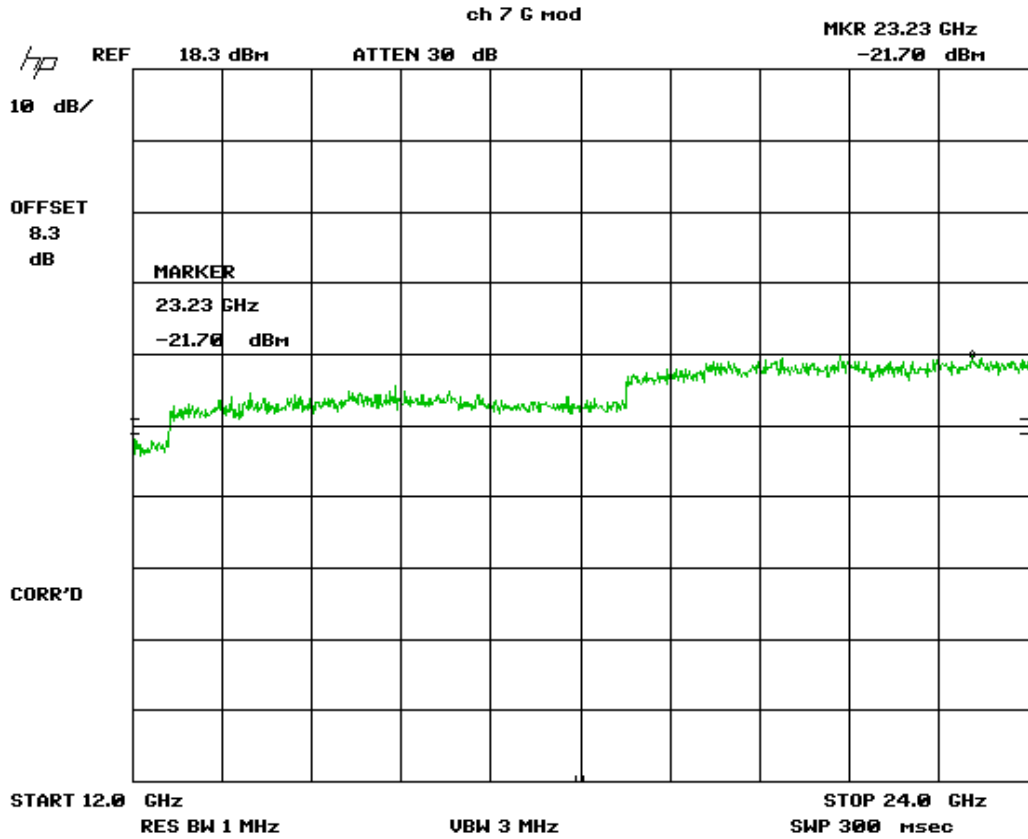

Figure 23. Emissions 802.11g - Mid Channel, Part 4

US Tech Test Report:  
FCC ID:  
IC ID:  
Test Report Number:  
Issue Date:  
Customer:  
Model(s):

FCC Part 15 Certification & IC RSS  
O7P-362  
10147A-362  
13-0186  
July 29, 2013  
Inventek Systems  
ISM43362-M3G-L44-E and ISM43362-M3G-L44-U

### 2.10.6 Conducted Radiated Emissions, IEEE 802.11g, Channel 11

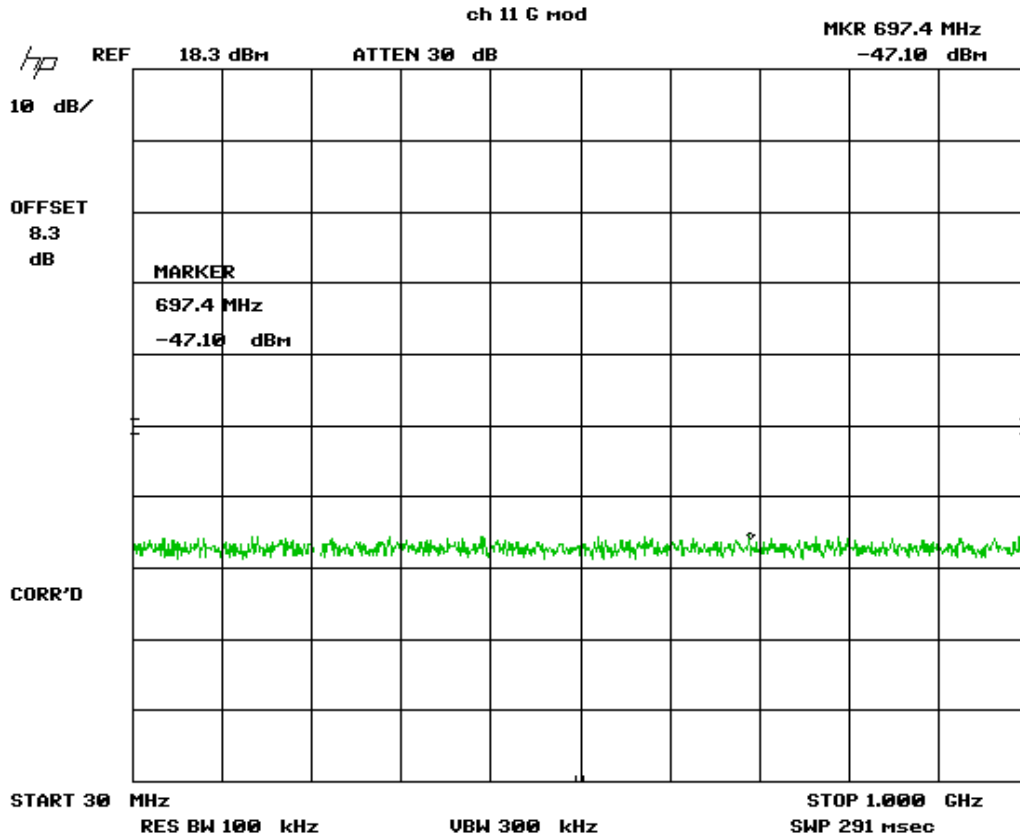

Figure 24. Emissions 802.11g - High Channel, Part 1

US Tech Test Report:  
FCC ID:  
IC ID:  
Test Report Number:  
Issue Date:  
Customer:  
Model(s):

FCC Part 15 Certification & IC RSS  
O7P-362  
10147A-362  
13-0186  
July 29, 2013  
Inventek Systems  
ISM43362-M3G-L44-E and ISM43362-M3G-L44-U

Note: Large Signal shown is Fundamental Frequency

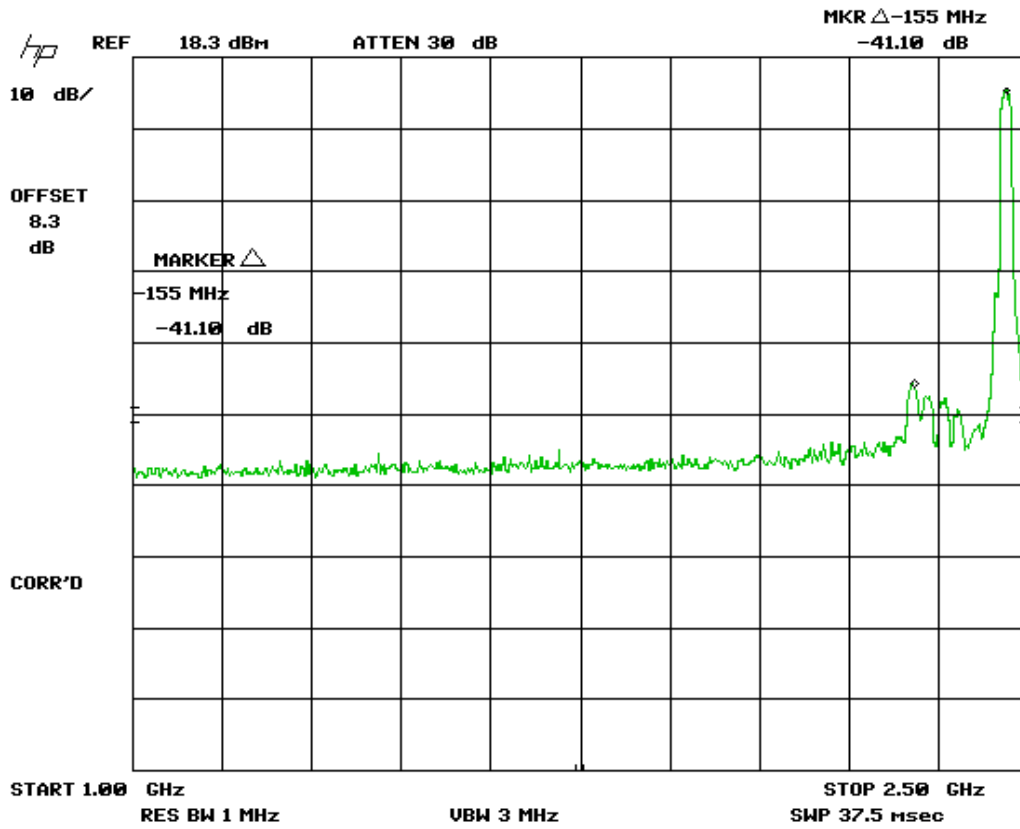

Figure 25. Emissions 802.11g - High Channel, Part 2

US Tech Test Report:  
FCC ID:  
IC ID:  
Test Report Number:  
Issue Date:  
Customer:  
Model(s):

FCC Part 15 Certification & IC RSS  
O7P-362  
10147A-362  
13-0186  
July 29, 2013  
Inventek Systems  
ISM43362-M3G-L44-E and ISM43362-M3G-L44-U

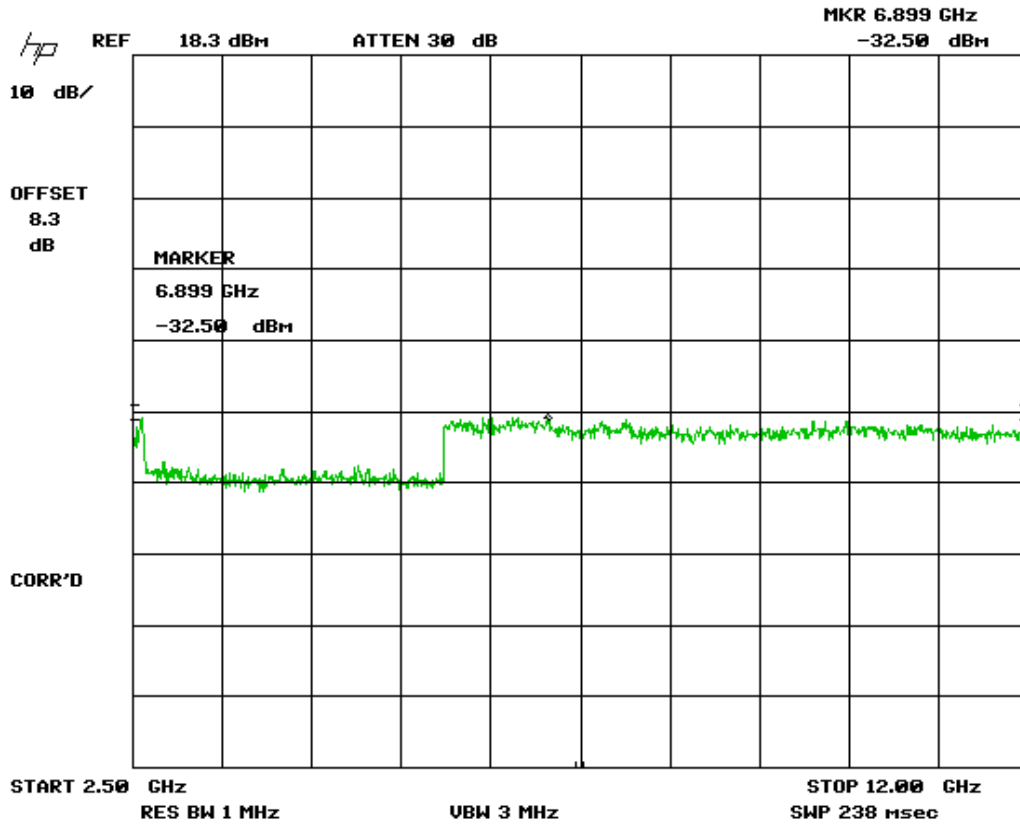

Figure 26. Emissions 802.11g - High Channel, Part 3

US Tech Test Report:  
FCC ID:  
IC ID:  
Test Report Number:  
Issue Date:  
Customer:  
Model(s):

FCC Part 15 Certification & IC RSS  
O7P-362  
10147A-362  
13-0186  
July 29, 2013  
Inventek Systems  
ISM43362-M3G-L44-E and ISM43362-M3G-L44-U

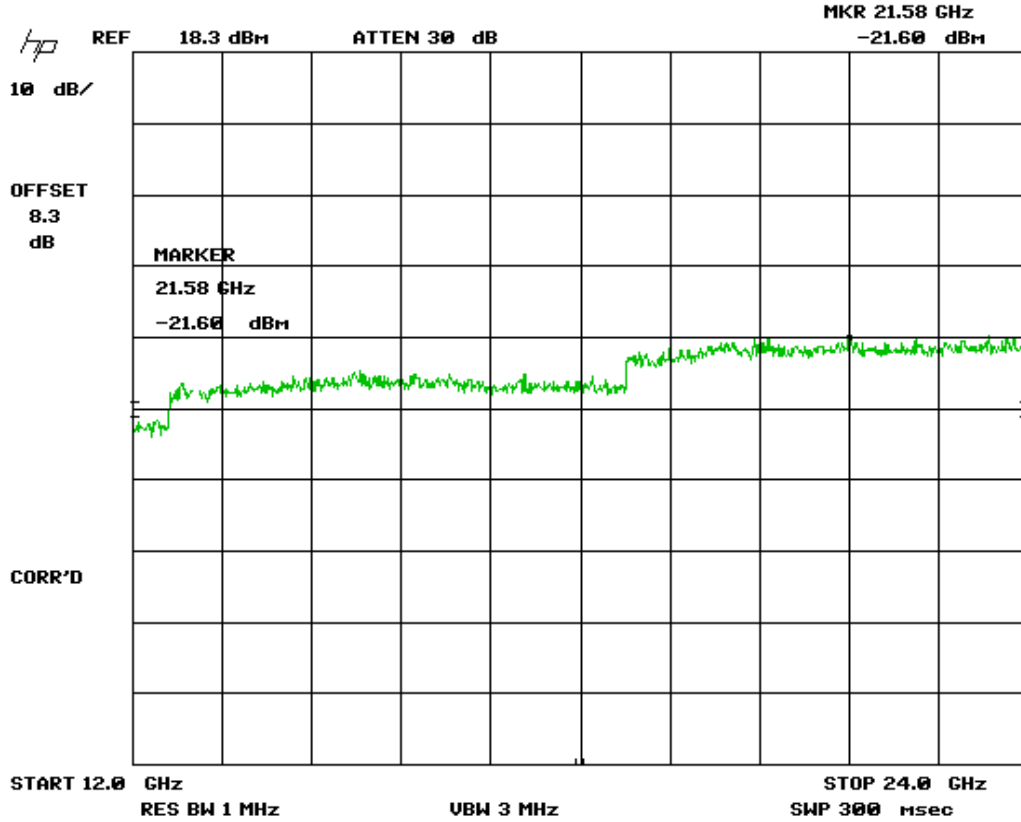

Figure 27. Emissions 802.11g - High Channel, Part 4

US Tech Test Report:  
 FCC ID:  
 IC ID:  
 Test Report Number:  
 Issue Date:  
 Customer:  
 Model(s):

FCC Part 15 Certification & IC RSS  
 O7P-362  
 10147A-362  
 13-0186  
 July 29, 2013  
 Inventek Systems  
 ISM43362-M3G-L44-E and ISM43362-M3G-L44-U

### 2.10.7 Conducted Radiated Emissions, IEEE 802.11n, Channel 1

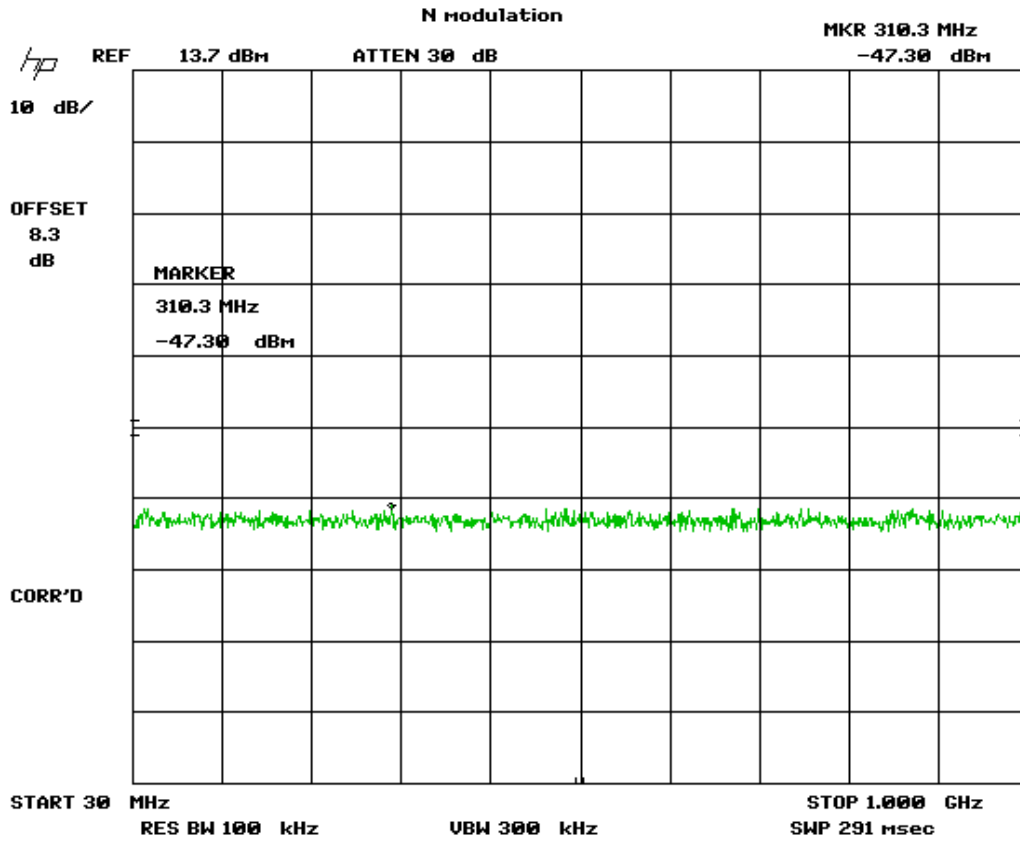

Figure 28. Emissions 802.11n - Low Channel, Part 1

US Tech Test Report:  
FCC ID:  
IC ID:  
Test Report Number:  
Issue Date:  
Customer:  
Model(s):

FCC Part 15 Certification & IC RSS  
O7P-362  
10147A-362  
13-0186  
July 29, 2013  
Inventek Systems  
ISM43362-M3G-L44-E and ISM43362-M3G-L44-U

Note: Large Signal shown is Fundamental Frequency

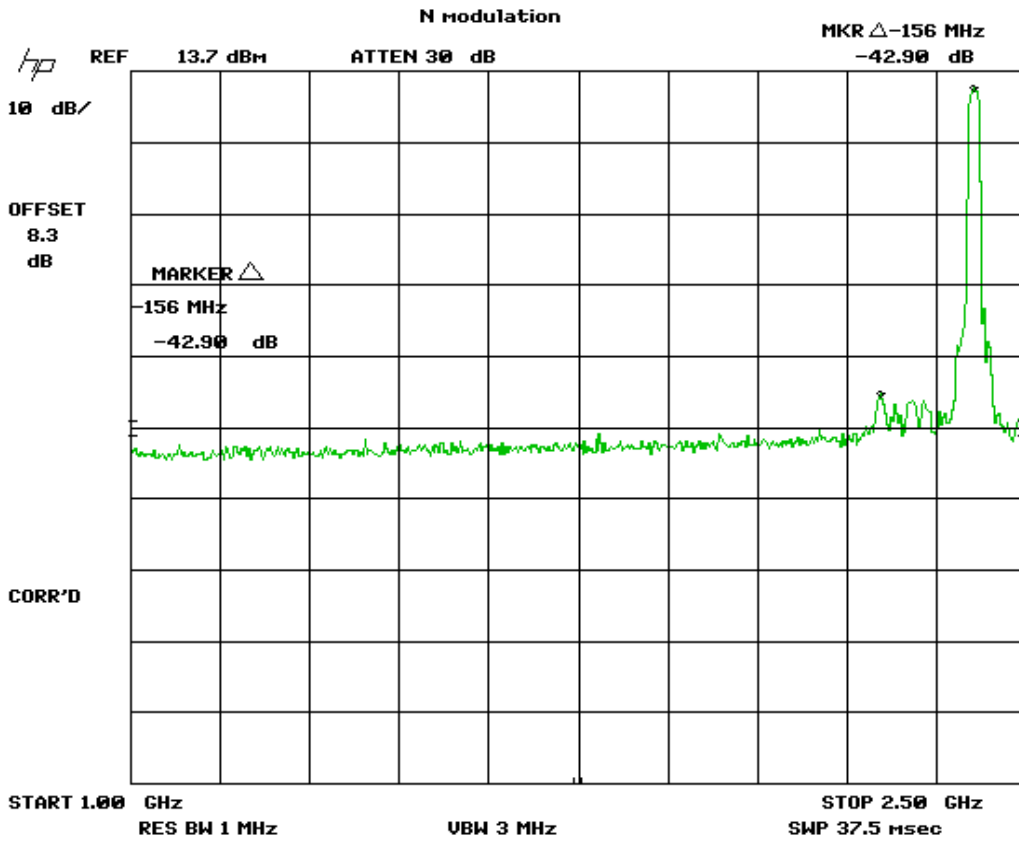

Figure 29. Emissions 802.11n - Low Channel, Part 2



US Tech Test Report:  
FCC ID:  
IC ID:  
Test Report Number:  
Issue Date:  
Customer:  
Model(s):

FCC Part 15 Certification & IC RSS  
O7P-362  
10147A-362  
13-0186  
July 29, 2013  
Inventek Systems  
ISM43362-M3G-L44-E and ISM43362-M3G-L44-U

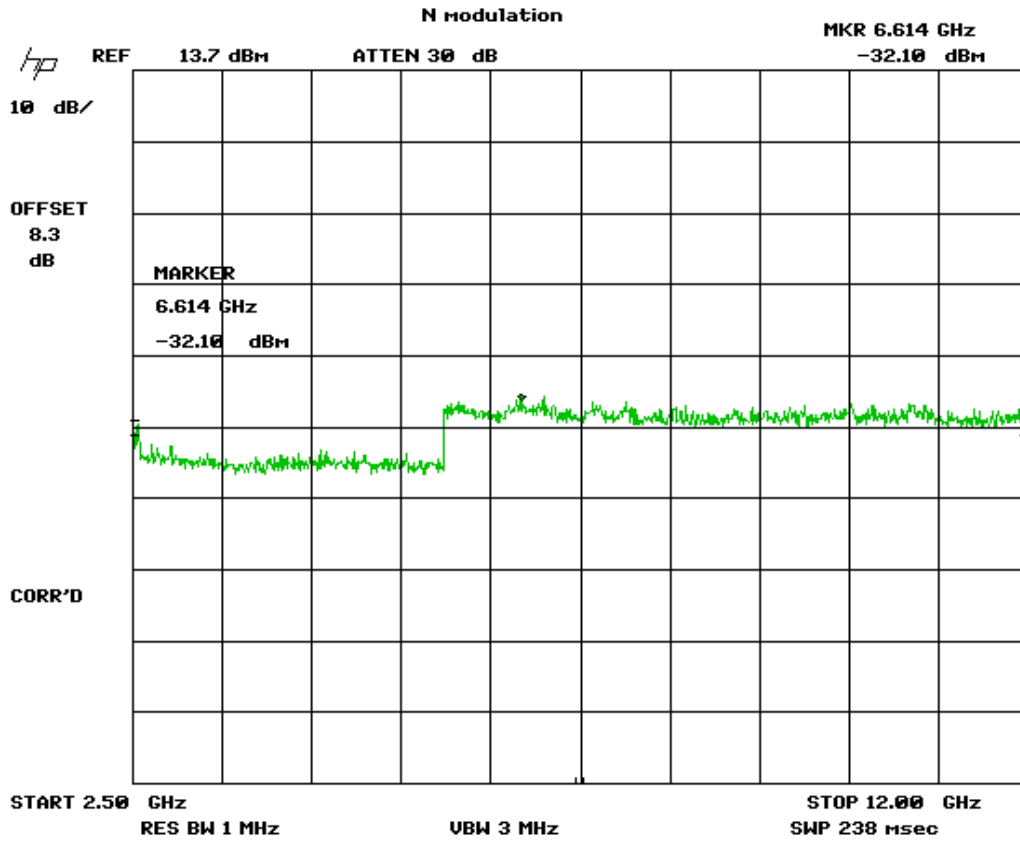

Figure 30. Emissions 802.11n - Low Channel, Part 3

US Tech Test Report:  
FCC ID:  
IC ID:  
Test Report Number:  
Issue Date:  
Customer:  
Model(s):

FCC Part 15 Certification & IC RSS  
O7P-362  
10147A-362  
13-0186  
July 29, 2013  
Inventek Systems  
ISM43362-M3G-L44-E and ISM43362-M3G-L44-U

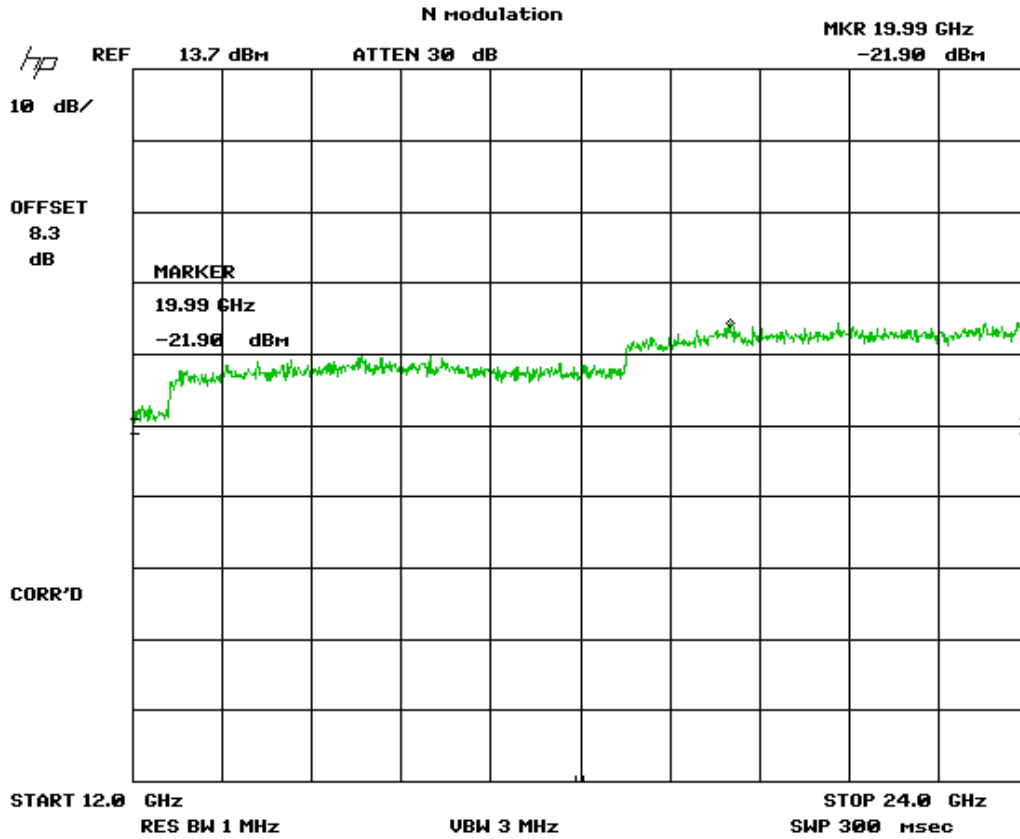

Figure 31. Emissions 802.11n - Low Channel, Part 4

US Tech Test Report:  
FCC ID:  
IC ID:  
Test Report Number:  
Issue Date:  
Customer:  
Model(s):

FCC Part 15 Certification & IC RSS  
O7P-362  
10147A-362  
13-0186  
July 29, 2013  
Inventek Systems  
ISM43362-M3G-L44-E and ISM43362-M3G-L44-U

### 2.10.8 Conducted Radiated Emissions, IEEE 802.11n, Channel 7

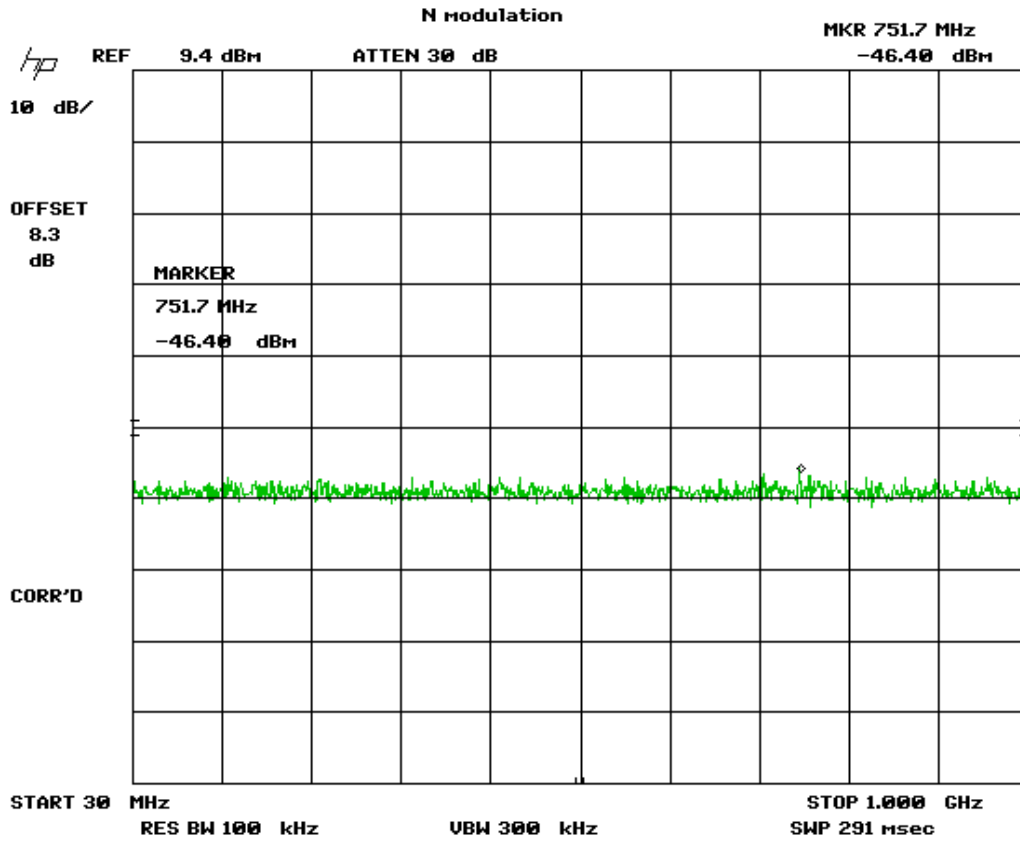

Figure 32. Emissions 802.11n - Mid Channel, Part 1

US Tech Test Report:  
FCC ID:  
IC ID:  
Test Report Number:  
Issue Date:  
Customer:  
Model(s):

FCC Part 15 Certification & IC RSS  
O7P-362  
10147A-362  
13-0186  
July 29, 2013  
Inventek Systems  
ISM43362-M3G-L44-E and ISM43362-M3G-L44-U

Note: Large Signal shown is Fundamental Frequency

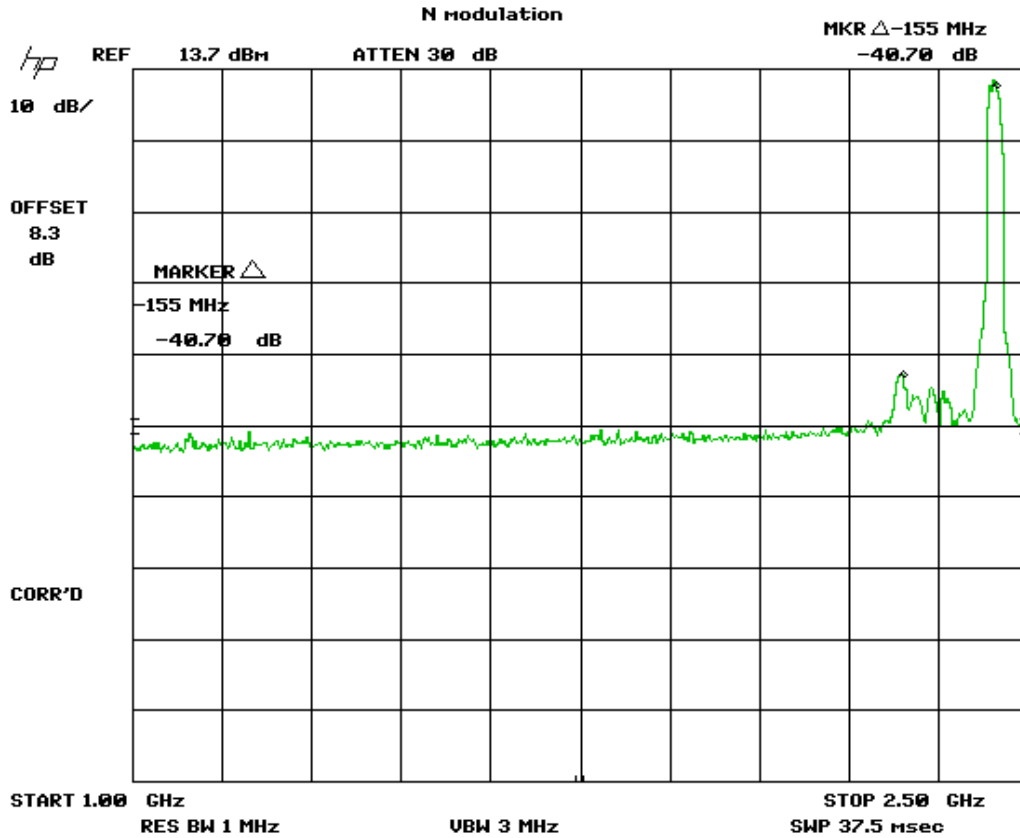

Figure 33. Emissions 802.11n - Mid Channel, Part 2

US Tech Test Report:  
FCC ID:  
IC ID:  
Test Report Number:  
Issue Date:  
Customer:  
Model(s):

FCC Part 15 Certification & IC RSS  
O7P-362  
10147A-362  
13-0186  
July 29, 2013  
Inventek Systems  
ISM43362-M3G-L44-E and ISM43362-M3G-L44-U

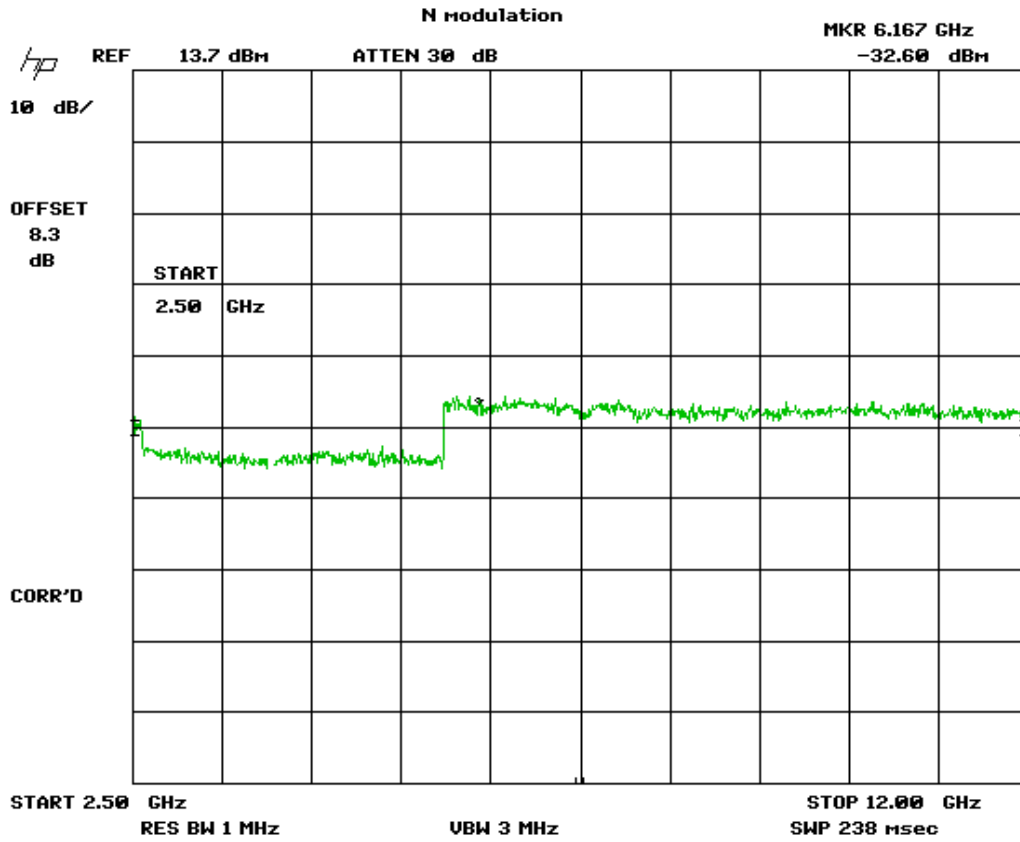

Figure 34. Emissions 802.11n - Mid Channel, Part 3

US Tech Test Report:  
 FCC ID:  
 IC ID:  
 Test Report Number:  
 Issue Date:  
 Customer:  
 Model(s):

FCC Part 15 Certification & IC RSS  
 O7P-362  
 10147A-362  
 13-0186  
 July 29, 2013  
 Inventek Systems  
 ISM43362-M3G-L44-E and ISM43362-M3G-L44-U

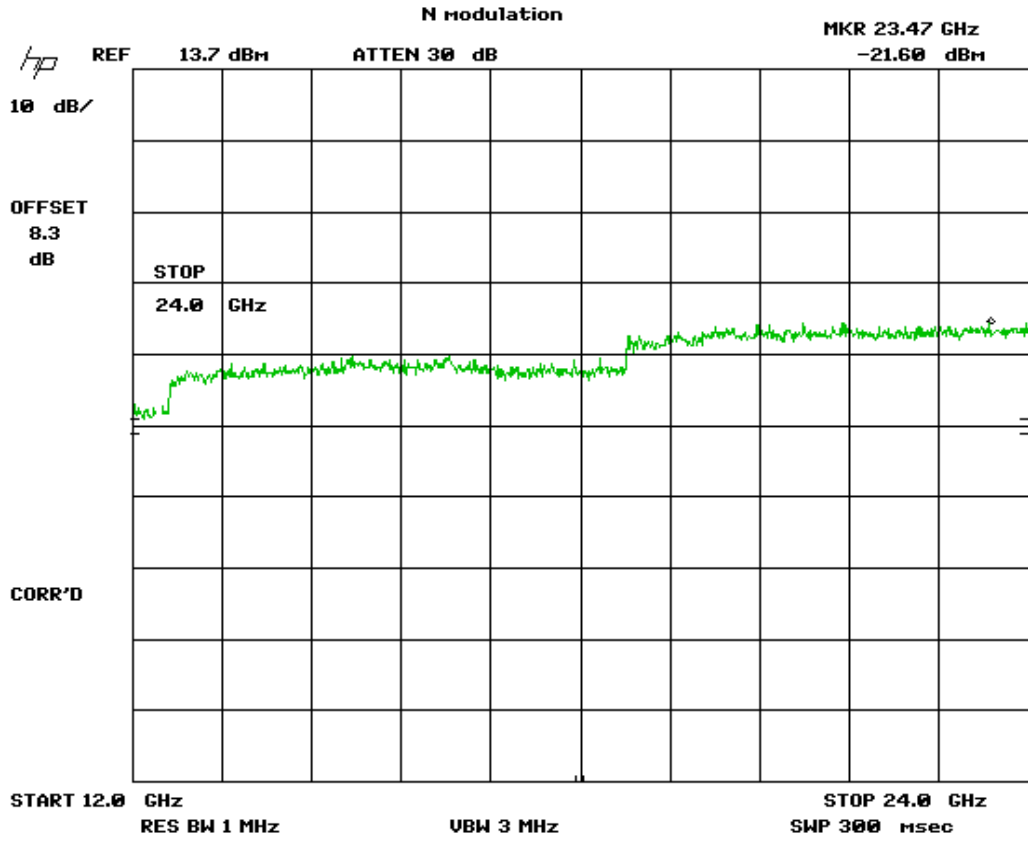

Figure 35. Emissions 802.11n - Mid Channel, Part 4

US Tech Test Report:  
 FCC ID:  
 IC ID:  
 Test Report Number:  
 Issue Date:  
 Customer:  
 Model(s):

FCC Part 15 Certification & IC RSS  
 O7P-362  
 10147A-362  
 13-0186  
 July 29, 2013  
 Inventek Systems  
 ISM43362-M3G-L44-E and ISM43362-M3G-L44-U

### 2.10.9 Conducted Radiated Emissions, IEEE 802.11n, Channel 11

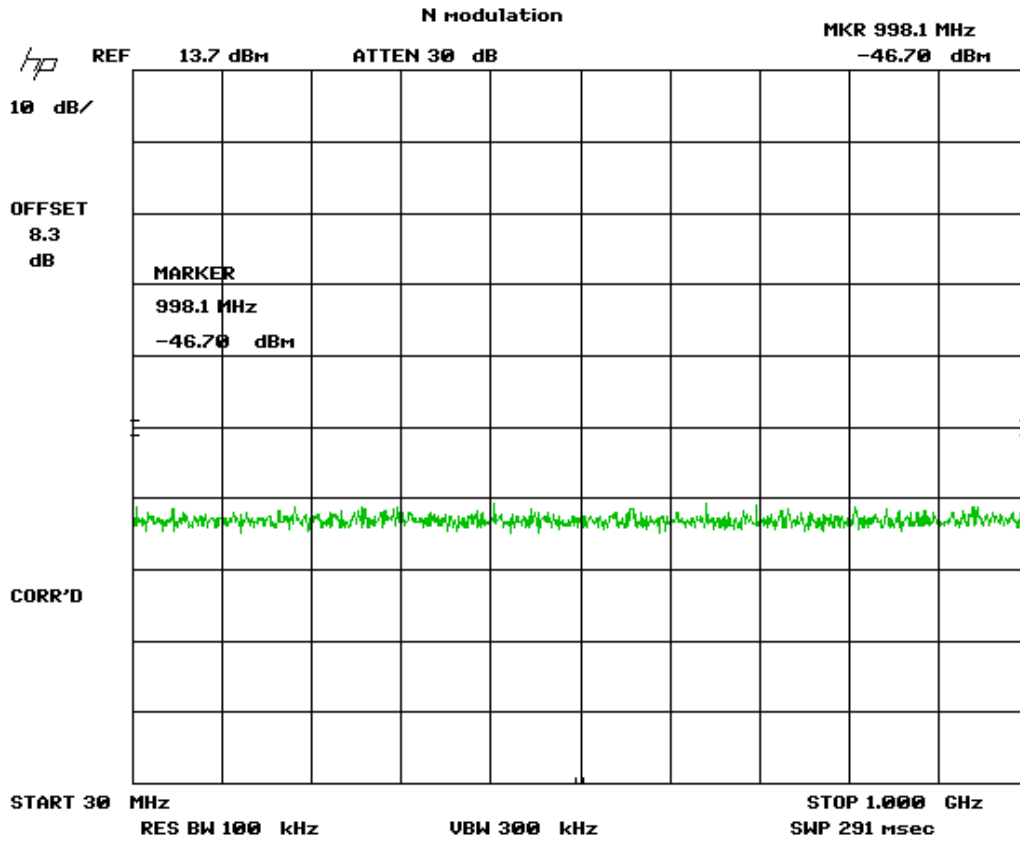

Figure 36. Emissions 802.11n - High Channel, Part 1

US Tech Test Report:  
FCC ID:  
IC ID:  
Test Report Number:  
Issue Date:  
Customer:  
Model(s):

FCC Part 15 Certification & IC RSS  
O7P-362  
10147A-362  
13-0186  
July 29, 2013  
Inventek Systems  
ISM43362-M3G-L44-E and ISM43362-M3G-L44-U

Note: Large Signal shown is Fundamental Frequency

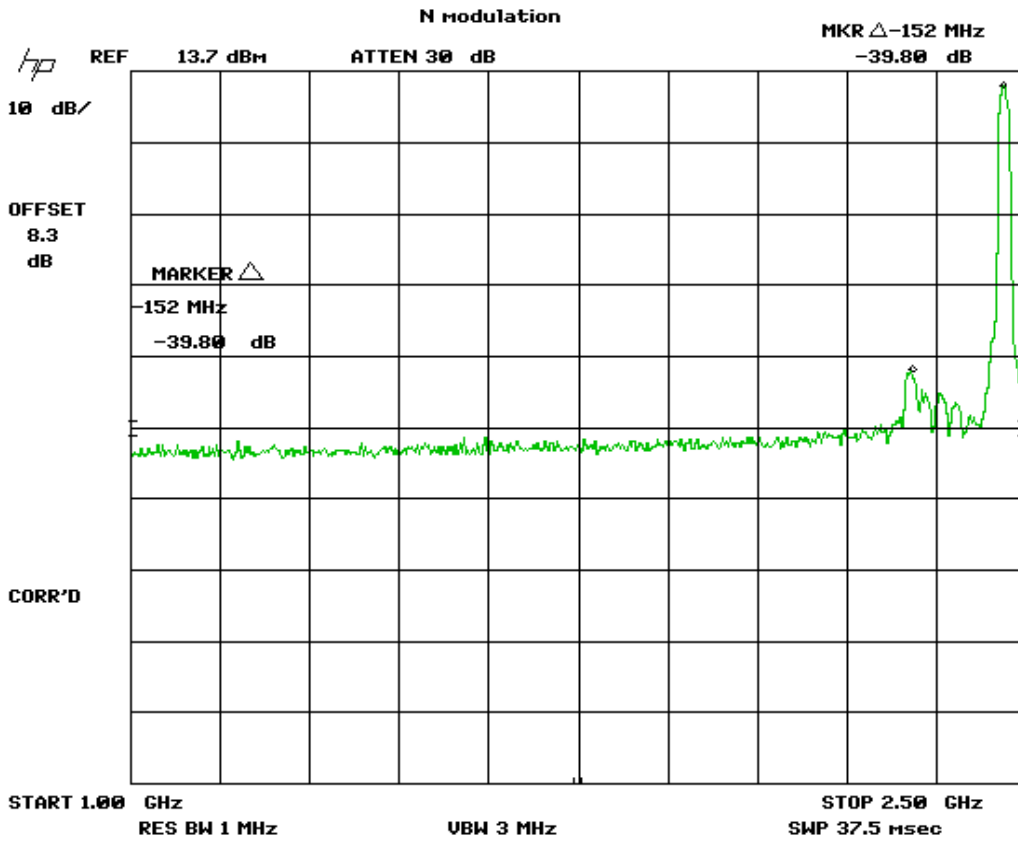

Figure 37. Emissions 802.11n - High Channel, Part 2



US Tech Test Report:  
FCC ID:  
IC ID:  
Test Report Number:  
Issue Date:  
Customer:  
Model(s):

FCC Part 15 Certification & IC RSS  
O7P-362  
10147A-362  
13-0186  
July 29, 2013  
Inventek Systems  
ISM43362-M3G-L44-E and ISM43362-M3G-L44-U

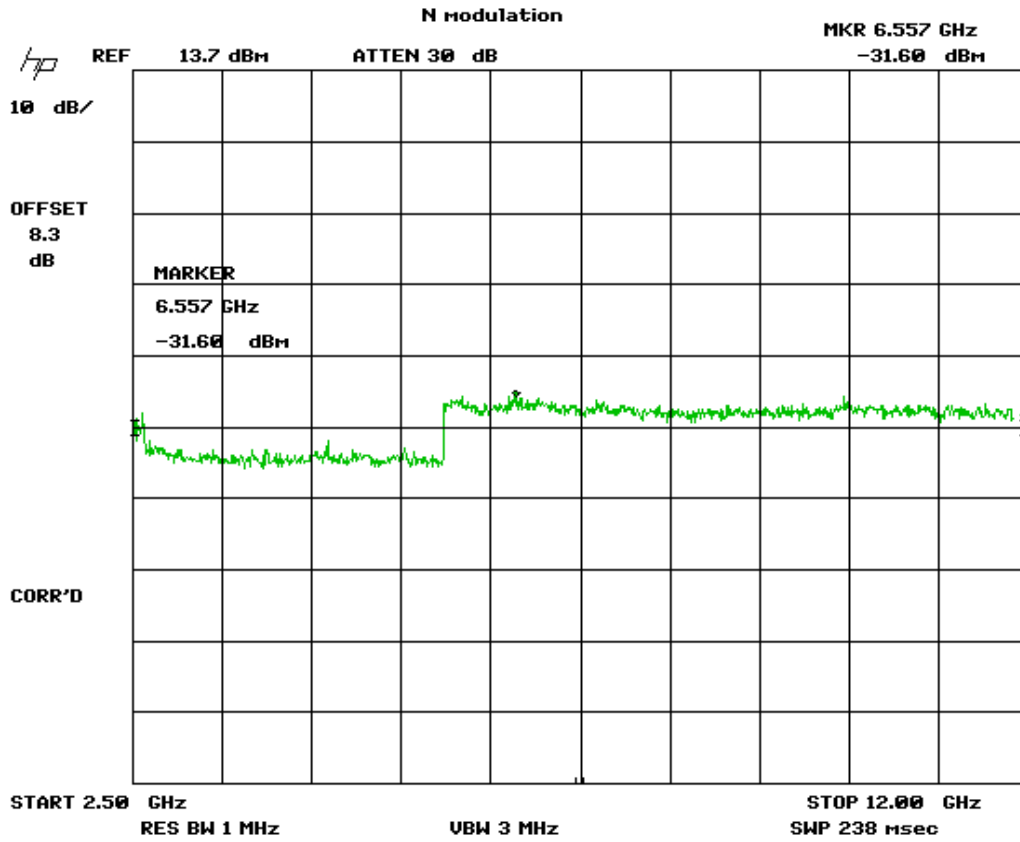

Figure 38. Emissions 802.11n - High Channel, Part 3

US Tech Test Report:  
FCC ID:  
IC ID:  
Test Report Number:  
Issue Date:  
Customer:  
Model(s):

FCC Part 15 Certification & IC RSS  
O7P-362  
10147A-362  
13-0186  
July 29, 2013  
Inventek Systems  
ISM43362-M3G-L44-E and ISM43362-M3G-L44-U

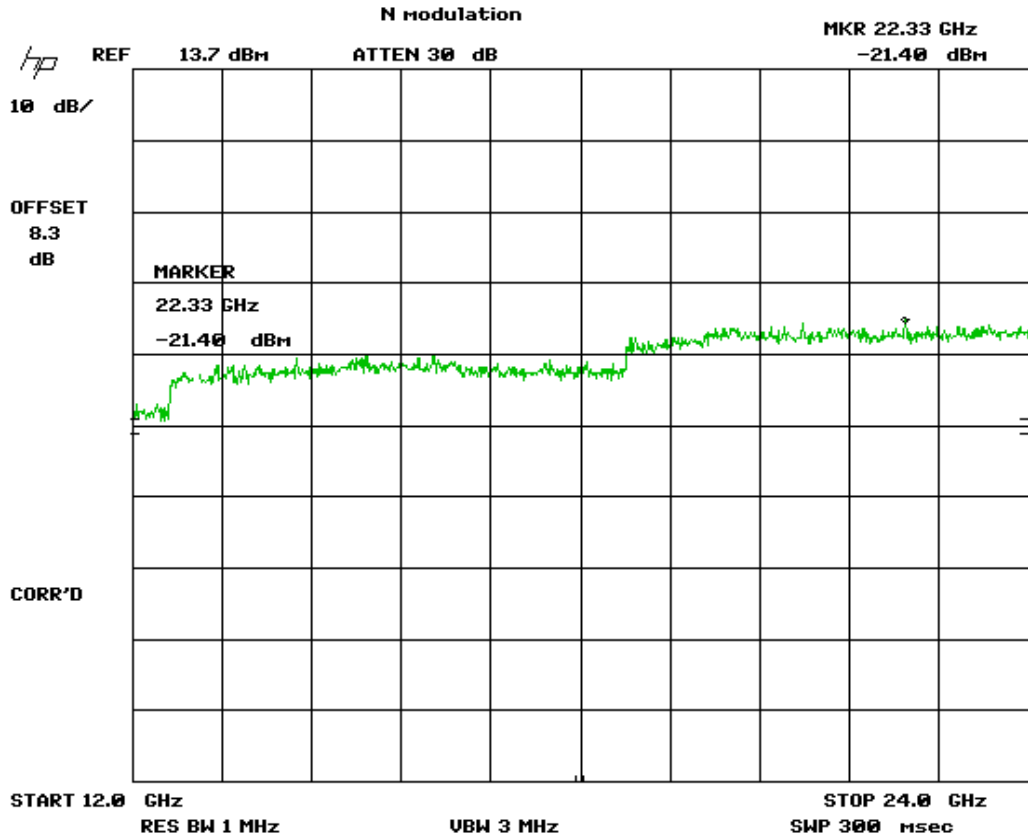

Figure 39. Emissions 802.11n - High Channel, Part 4

US Tech Test Report:  
 FCC ID:  
 IC ID:  
 Test Report Number:  
 Issue Date:  
 Customer:  
 Model(s):

FCC Part 15 Certification & IC RSS  
 O7P-362  
 10147A-362  
 13-0186  
 July 29, 2013  
 Inventek Systems  
 ISM43362-M3G-L44-E and ISM43362-M3G-L44-U

## 2.11 Intentional Radiated Emissions and Harmonics

**Table 6. 802.11b Peak Fundamental & Harmonic Emissions Antenna 1**

Radiated Harmonic and Spurious Emissions, Tested from 30 MHz – 24 GHz							
Tested By: JCW	Test: FCC Part 15, Para 15.247(d)			Client: Inventek Systems			
	Project: 13-0186			Model: ISM43362-MG3-L44-E, ISM43362-MG3-L44-U			
Frequency (MHz)	Test Data (dBuV)	AF+CL-PA (dB/m)	Corrected Results (dBuV/m)	Limits (dBuV/m)	Distance / Polarization	Pass Margin (dB)	Detector PK / AVG
<b>LOW BAND - PEAK</b>							
2411.75	81.09	31.35	112.44		3.0m./ver		PK
4822.85	68.86	2.65	71.51	74	3.0m./ver	2.49	PK
7233.25	67.62	7.07	65.19	74	1.0m./ver	8.81	PK
9643.75	50.74	6.96	48.20	74	1.0m./ver	25.80	PK
12058.63	47.07	9.98	47.55	74	1.0m./ver	26.45	PK
<b>MID BAND- PEAK</b>							
2441.90	79.71	31.35	111.06		3.0m./ver		PK
4884.09	68.08	2.57	70.65	74	3.0m./ver	3.4	PK
7326.16	64.24	7.36	62.10	74	1.0m./ver	11.9	PK
9768.15	50.14	7.13	47.77	74	1.0m./ver	26.2	PK
12209.50	47.71	10.04	48.25	74	1.0m./ver	25.8	PK
<b>HIGH BAND- PEAK</b>							
2462.75	78.93	31.60	110.53		3.0m./ver		PK
4924.00	68.03	2.77	70.80	74	3.0m./ver	3.2	PK
7386.00	62.09	7.34	59.93	74	1.0m./ver	14.1	PK
9848.25	50.22	7.12	47.84	74	1.0m./ver	26.2	PK
12296.60	44.72	10.14	45.36	74	1.0m./ver	28.6	PK

**SAMPLE CALCULATION:**

Measurements taken at 1 meter distance were extrapolated to 3 meters using a factor of (-9.54 dB).

RESULTS: At 4884.09 MHz: 68.08 dBuV + 2.57 dB/m = 70.65 dBuV/m @ 3m

Margin = (74.0 – 70.65) = 3.40 dB

Test Date: June 14, 2013

Tested By

Signature: 

Name: John C. Wynn

US Tech Test Report:  
 FCC ID:  
 IC ID:  
 Test Report Number:  
 Issue Date:  
 Customer:  
 Model(s):

FCC Part 15 Certification & IC RSS  
 O7P-362  
 10147A-362  
 13-0186  
 July 29, 2013  
 Inventek Systems  
 ISM43362-M3G-L44-E and ISM43362-M3G-L44-U

**Table 7. 802.11b Average Fundamental & Harmonic Emissions Antenna 1**

Radiated Harmonic and Spurious Emissions, Tested from 30 MHz – 24 GHz							
Tested By: JCW	Test: FCC Part 15, Para 15.247(d)			Client: Inventek Systems			
	Project: 13-0186			Model: ISM43362-M3G-L44-E, ISM43362-M3G-L44-U			
Frequency (MHz)	Test Data (dBuV)	AF+CL-PA (dB/m)	Corrected Results (dBuV/m)	Limits (dBuV/m)	Distance / Polarization	Pass Margin (dB)	Detector PK / AVG
<b>LOW BAND - Average</b>							
2411.75	73.22	31.35	104.57		3.0m./ver		<b>AVG</b>
4822.85	59.26	2.65	61.91	54	3.0m./ver	*5.7	<b>AVG</b>
7233.25	64.28	7.07	61.85	54	1.0m./ver	*5.8	<b>AVG</b>
9643.75	39.69	6.96	37.15	54	1.0m./ver	*30.5	<b>AVG</b>
12058.63	34.83	9.98	35.31	54	1.0m./ver	*32.3	<b>AVG</b>
<b>MID BAND- Average</b>							
2441.90	72.72	31.35	104.07		3.0m./ver		<b>AVG</b>
4884.09	58.54	2.57	61.11	54	3.0m./ver	*6.54	<b>AVG</b>
7326.16	52.25	7.36	50.11	54	1.0m./ver	*17.54	<b>AVG</b>
9768.15	39.60	7.13	37.23	54	1.0m./ver	*30.42	<b>AVG</b>
12209.50	43.80	10.04	44.34	54	1.0m./ver	*23.31	<b>AVG</b>
<b>HIGH BAND- Average</b>							
2462.75	71.46	31.60	103.06		3.0m./ver		<b>AVG</b>
4924.00	59.32	2.77	62.09	54	1.0m./ver	*5.6	<b>AVG</b>
7386.00	50.09	7.34	47.93	54	1.0m./ver	*19.7	<b>AVG</b>
9848.25	40.60	7.12	38.22	54	1.0m./ver	*29.4	<b>AVG</b>

(\*) denotes: A duty cycle correction factor of -13.65dB was added to the average measurements.

**SAMPLE CALCULATION:**

Measurements taken at 1 meter distance were extrapolated to 3 meters using a factor of (-9.54 dB).

RESULTS: At 4884.9 MHz: = 58.54 dBuV + 2.57 dB/m = 61.11 dBuV/m @ 3m

Margin = (54.0 – 61.1 – (-13.65)) = 6.54 dB

Test Date: June 14, 2013

Tested By

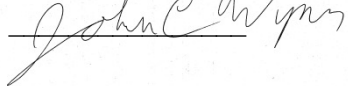
Signature: 

Name: John C. Wynn

US Tech Test Report:  
 FCC ID:  
 IC ID:  
 Test Report Number:  
 Issue Date:  
 Customer:  
 Model(s):

FCC Part 15 Certification & IC RSS  
 O7P-362  
 10147A-362  
 13-0186  
 July 29, 2013  
 Inventek Systems  
 ISM43362-M3G-L44-E and ISM43362-M3G-L44-U

**Table 8. 802.11g Peak Fundamental & Harmonic Emissions Antenna 1**

Radiated Harmonic and Spurious Emissions, Tested from 30 MHz – 24 GHz							
Tested By: JCW	Test: FCC Part 15, Para 15.247(d)			Client: Inventek Systems			
	Project: 13-0186			Model: ISM43362-M3G-L44-E, ISM43362-M3G-L44-U			
Frequency (MHz)	Test Data (dBuV)	AF+CL-PA (dB/m)	Corrected Results (dBuV/m)	Limits (dBuV/m)	Distance / Polarization	Pass Margin (dB)	Detector PK / AVG
<b>LOW BAND - PEAK</b>							
2411.75	79.48	31.35	110.83		3.0m./ver		PK
4822.85	67.75	2.65	70.40	74.0	3.0m./ver	3.6	PK
7233.25	63.22	7.07	60.79	74.0	1.0m./ver	13.2	PK
9643.75	53.81	6.96	51.27	74.0	1.0m./ver	22.7	PK
<b>MID BAND- PEAK</b>							
2441.20	78.47	31.35	109.82		3.0m./ver		PK
4886.65	66.62	2.86	69.48	74.0	3.0m./ver	4.5	PK
7324.50	61.73	-1.67	60.06	74.0	1.0m./ver	13.9	PK
9759.38	52.82	-1.33	51.49	74.0	1.0m./ver	22.5	PK
12215.75	48.06	1.63	49.69	74.0	1.0m./ver	24.3	PK
<b>HIGH BAND- PEAK</b>							
2462.00	78.07	31.60	109.67		3.0m./ver		PK
4922.50	66.46	2.77	69.23	74.0	3.0m./ver	4.8	PK
7385.38	61.12	7.41	59.03	74.0	1.0m./ver	15.0	PK
9846.25	52.18	7.11	49.79	74.0	1.0m./ver	24.2	PK
12307.75	47.25	10.35	48.10	74.0	1.0m./ver	25.9	PK

**SAMPLE CALCULATION:**

Measurements taken at 1 meter distance were extrapolated to 3 meters using a factor of (-9.54 dB).

RESULTS: At 4886.65 MHz: = 66.62 dBuV + 2.86 dB/m = 69.48 dBuV/m @ 3m

Margin = (74.0 – 69.48) = 4.5 dB

Test Date: June 14, 2013

Tested By

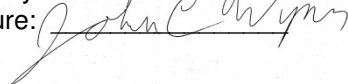
Signature: 

Name: John C. Wynn

US Tech Test Report:  
 FCC ID:  
 IC ID:  
 Test Report Number:  
 Issue Date:  
 Customer:  
 Model(s):

FCC Part 15 Certification & IC RSS  
 O7P-362  
 10147A-362  
 13-0186  
 July 29, 2013  
 Inventek Systems  
 ISM43362-M3G-L44-E and ISM43362-M3G-L44-U

**Table 9. 802.11g Average Fundamental & Harmonic Emissions Antenna 1**

Radiated Harmonic and Spurious Emissions, Tested from 30 MHz – 24 GHz							
Tested By: JCW	Test: FCC Part 15, Para 15.247(d)			Client: Inventek Systems			
	Project: 13-0186			Model: ISM43362-M3G-L44E, ISM43362-M3G-L44-U			
Frequency (MHz)	Test Data (dBuV)	AF+CL-PA (dB/m)	Corrected Results (dBuV/m)	Limits (dBuV/m)	Distance / Polarization	Pass Margin (dB)	Detector PK / AVG
<b>LOW BAND - Average</b>							
2411.75	67.26	31.35	98.61		3.0m./ver	--	<b>AVG</b>
4822.85	53.75	2.65	56.40	54.0	3.0m./ver	*11.2	<b>AVG</b>
7233.25	50.17	7.07	47.74	54.0	1.0m./ver	*19.9	<b>AVG</b>
9643.75	37.26	6.96	34.72	54.0	1.0m./ver	*32.9	<b>AVG</b>
12058.63	35.50	9.98	35.98	54.0	1.0m./ver	*31.7	<b>AVG</b>
<b>MID BAND- Average</b>							
2441.20	66.00	31.35	97.35		3.0m./ver	--	<b>AVG</b>
4886.65	52.73	2.57	55.30	54.0	3.0m./ver	*12.4	<b>AVG</b>
7324.50	48.91	7.26	46.67	54.0	1.0m./ver	*21.0	<b>AVG</b>
9759.38	35.18	7.12	32.80	54.0	1.0m./ver	*34.9	<b>AVG</b>
12215.75	33.94	10.08	34.52	54.0	1.0m./ver	*33.1	<b>AVG</b>
<b>HIGH BAND- Average</b>							
2462.00	65.92	31.60	97.52		3.0m./ver	--	<b>AVG</b>
4922.50	52.27	2.77	55.04	54.0	1.0m./ver	*12.6	<b>AVG</b>
7385.38	48.20	7.41	46.11	54.0	1.0m./ver	*21.5	<b>AVG</b>
9846.25	34.89	7.11	32.50	54.0	1.0m./ver	*35.1	<b>AVG</b>
12307.75	32.76	10.35	33.61	54.0	1.0m./ver	*34.0	<b>AVG</b>

(\*) denotes: A duty cycle correction factor of -13.65dB was added to the average measurements.

**SAMPLE CALCULATION:**

Measurements taken at 1 meter distance were extrapolated to 3 meters using a factor of (-9.54 dB).

RESULTS: At 4886.65 MHz: = 52.73 dBuV+ 2.57 dB/m = 55.3 dBuV/m @ 3m

Margin = (54.0 – 55.3 -(-13.65)) = 12.35dB

Test Date: June 14, 2013

Tested By

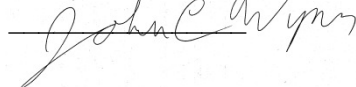
Signature: 

Name: John C. Wynn

US Tech Test Report:  
 FCC ID:  
 IC ID:  
 Test Report Number:  
 Issue Date:  
 Customer:  
 Model(s):

FCC Part 15 Certification & IC RSS  
 O7P-362  
 10147A-362  
 13-0186  
 July 29, 2013  
 Inventek Systems  
 ISM43362-M3G-L44-E and ISM43362-M3G-L44-U

**Table 10. 802.11n Peak Fundamental & Harmonic Emissions Antenna 1**

Radiated Harmonic and Spurious Emissions, Tested from 30 MHz – 24 GHz							
Tested By: JCW	Test: FCC Part 15, Para 15.247(d)			Client: Inventek Systems			
	Project: 13-0186			Model: ISM43362-M3G-L44E, ISM43362-M3G-L44-U			
Frequency (MHz)	Test Data (dBuV)	AF+CL-PA (dB/m)	Corrected Results (dBuV/m)	Limits (dBuV/m)	Distance / Polarization	Pass Margin (dB)	Detector PK / AVG
<b>LOW BAND - PEAK</b>							
2413.10	78.38	31.35	109.73		3.0m./ver		PK
4824.85	65.16	2.65	67.81	74.0	3.0m./ver	6.2	PK
7233.30	61.36	7.07	58.93	74.0	1.0m./ver	15.1	PK
9654.45	56.74	6.91	54.15	74.0	1.0m./ver	19.8	PK
<b>MID BAND- PEAK</b>							
2443.15	77.34	31.35	108.69		3.0m./ver		PK
4884.65	65.70	2.57	68.27	74.0	3.0m./ver	5.7	PK
7323.48	61.48	7.36	59.34	74.0	1.0m./ver	14.7	PK
9767.50	52.87	7.13	50.50	74.0	1.0m./ver	23.5	PK
12213.00	46.57	10.04	47.11	74.0	1.0m./ver	26.9	PK
<b>HIGH BAND- PEAK</b>							
2459.75	75.95	31.60	107.55		3.0m./ver		PK
4921.88	64.48	2.77	67.25	74.0	3.0m./ver	6.8	PK
7384.50	59.35	7.34	57.19	74.0	1.0m./ver	16.8	PK
9847.37	53.25	7.12	50.87	74.0	1.0m./ver	23.1	PK
12298.38	45.07	10.32	45.89	74.0	1.0m./ver	28.1	PK

**SAMPLE CALCULATION:**

Measurements taken at 1 meter distance were extrapolated to 3 meters using a factor of (-9.54 dB).

RESULTS: At 4884.65 MHz: = 65.70 dBuV + 2.57 dB/m = 68.27dBuV/m @ 3m

Margin = (74.0 – 68.27) = 5.7 dB

Test Date: June 14, 2013

Tested By

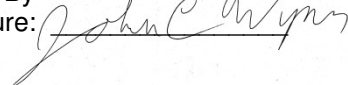
Signature: 

Name: John C. Wynn

US Tech Test Report:  
 FCC ID:  
 IC ID:  
 Test Report Number:  
 Issue Date:  
 Customer:  
 Model(s):

FCC Part 15 Certification & IC RSS  
 O7P-362  
 10147A-362  
 13-0186  
 July 29, 2013  
 Inventek Systems  
 ISM43362-M3G-L44-E and ISM43362-M3G-L44-U

**Table 11. 802.11n Average Fundamental & Harmonic Emissions Antenna 1**

Radiated Harmonic and Spurious Emissions, Tested from 30 MHz – 24 GHz							
Tested By: JCW	Test: FCC Part 15, Para 15.247(d)			Client: Inventek Systems			
	Project: 13-0186			Model: ISM43362-M3G-L44E, ISM43362-M3G-L44-U			
Frequency (MHz)	Test Data (dBuV)	AF+CL-PA (dB/m)	Corrected Results (dBuV/m)	Limits (dBuV/m)	Distance / Polarization	Pass Margin (dB)	Detector PK / AVG
<b>LOW BAND - Average</b>							
2413.10	65.39	31.35	96.74		3.0m./ver		<b>AVG</b>
4824.85	50.19	2.65	52.84	54.0	3.0m./ver	*14.8	<b>AVG</b>
7233.30	48.07	7.07	45.64	54.0	1.0m./ver	*22.0	<b>AVG</b>
9654.45	36.93	6.91	34.34	54.0	1.0m./ver	*33.3	<b>AVG</b>
<b>MID BAND- Average</b>							
2443.15	64.66	31.35	96.01		3.0m./ver		<b>AVG</b>
4884.65	51.13	2.57	53.70	54.0	3.0m./ver	*14.0	<b>AVG</b>
7323.48	47.18	7.36	45.04	54.0	1.0m./ver	*22.6	<b>AVG</b>
9767.50	35.85	7.13	33.48	54.0	1.0m./ver	*34.2	<b>AVG</b>
12213.00	32.55	10.04	33.09	54.0	1.0m./ver	*34.6	<b>AVG</b>
<b>HIGH BAND- Average</b>							
2459.75	63.75	31.60	95.35		3.0m./ver		<b>AVG</b>
4921.88	50.17	2.77	52.94	54.0	3.0m./ver	*14.7	<b>AVG</b>
7384.50	46.12	7.34	43.96	54.0	1.0m./ver	*23.7	<b>AVG</b>
9847.37	34.89	7.12	32.51	54.0	1.0m./ver	*35.1	<b>AVG</b>
12298.38	45.07	10.36	45.93	54.0	1.0m./ver	*21.7	<b>AVG</b>

(\*) denotes: A duty cycle correction factor of -13.65dB was added to the average measurements.

**SAMPLE CALCULATION:**

Measurements taken at 1 meter distance were extrapolated to 3 meter using a factor of (-9.54 dB).

RESULTS: At 4886.65 MHz: = 51.13 dBuV+ 2.57 dB/m = 53.7 dBuV/m @ 3m

Margin = (54.0 – 53.7-(-13.65)) = 14.0dB

Test Date: June 14, 2013

Tested By

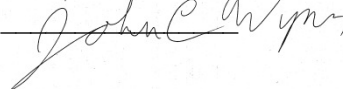
Signature: 

Name: John C. Wynn



US Tech Test Report:  
 FCC ID:  
 IC ID:  
 Test Report Number:  
 Issue Date:  
 Customer:  
 Model(s):

FCC Part 15 Certification & IC RSS  
 O7P-362  
 10147A-362  
 13-0186  
 July 29, 2013  
 Inventek Systems  
 ISM43362-M3G-L44-E and ISM43362-M3G-L44-U

**Table 12. 802.11b Peak Fundamental & Harmonic Emissions Antenna 2**

Radiated Harmonic and Spurious Emissions, Tested from 30 MHz – 24 GHz							
Tested By: JCW	Test: FCC Part 15, Para 15.247(d)			Client: Inventek Systems			
	Project: 13-0186			Model: ISM43362-M3G-L44E, ISM43362-M3G-L44-U			
Frequency (MHz)	Test Data (dBuV)	AF+CL-PA (dB/m)	Corrected Results (dBuV/m)	Limits (dBuV/m)	Distance / Polarization	Pass Margin (dB)	Detector PK / AVG
<b>LOW BAND - PEAK</b>							
2411.98	76.71	31.35	108.06		3.0m./ver	--	PK
4824.25	57.73	2.65	60.38	74.0	3.0m./ver	13.6	PK
7235.75	53.33	2.00	45.83	74.0	1.0m./ver	28.2	PK
<b>MID BAND- PEAK</b>							
2441.74	79.39	31.35	110.74		3.0m./ver	--	PK
4884.12	56.83	2.86	59.69	74.0	3.0m./ver	14.3	PK
7326.13	48.32	-7.20	41.12	74.0	1.0m./ver	32.9	PK
<b>HIGH BAND- PEAK</b>							
2461.93	80.07	31.60	111.67		3.0m./ver	16.5	PK
4924.44	58.41	2.77	61.18	74.0	3.0m./ver	13.8	PK
7386.13	49.62	-7.22	42.40	74.0	1.0m./ver	31.6	PK

**SAMPLE CALCULATION:**

Measurements taken at 1 meter distance were extrapolated to 3 meters using a factor of (-9.54 dB).

RESULTS: At 4884.12 MHz: = 56.83 dBuV + 2.86 dB/m = 59.69dBuV/m @ 3m

Margin = (74.0 – 59.69) = 14.3 dB

Test Date: June 14, 2013

Tested By

Signature:

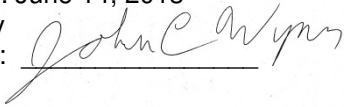

Name: John C. Wynn

US Tech Test Report:  
 FCC ID:  
 IC ID:  
 Test Report Number:  
 Issue Date:  
 Customer:  
 Model(s):

FCC Part 15 Certification & IC RSS  
 O7P-362  
 10147A-362  
 13-0186  
 July 29, 2013  
 Inventek Systems  
 ISM43362-M3G-L44-E and ISM43362-M3G-L44-U

**Table 13. 802.11b Average Fundamental & Harmonic Emissions Antenna 2**  
**Radiated Harmonic and Spurious Emissions, Tested from 30 MHz – 24 GHz**

Tested By: JCW		Test: FCC Part 15, Para 15.247(d)		Client: Inventek Systems			
		Project: 13-0186		Model: ISM43362-M3G-L44E, ISM43362-M3G-L44-U			
Frequency (MHz)	Test Data (dBuV)	AF+CL-PA (dB/m)	Corrected Results (dBuV/m)	Limits (dBuV/m)	Distance / Polarization	Pass Margin (dB)	Detector PK / AVG
<b>LOW BAND - Average</b>							
2411.98	68.77	31.35	100.12		3.0m./ver	--	<b>AVG</b>
4824.25	47.51	2.65	50.16	54.0	3.0m./ver	3.8	<b>AVG</b>
7235.75	40.26	2.00	32.76	54.0	1.0m./ver	21.2	<b>AVG</b>
<b>MID BAND- Average</b>							
2441.74	71.51	31.35	102.86		3.0m./ver	--	<b>AVG</b>
4884.12	46.02	2.57	48.59	54.0	3.0m./ver	5.4	<b>AVG</b>
7326.13	36.85	2.30	39.15	54.0	1.0m./ver	14.9	<b>AVG</b>
<b>HIGH BAND- Average</b>							
2461.93	72.32	31.60	103.92		3.0m./ver	--	<b>AVG</b>
4924.44	48.42	2.77	51.19	54.0	1.0m./ver	2.8	<b>AVG</b>
7386.13	38.83	2.28	41.11	54.0	1.0m./ver	12.9	<b>AVG</b>

(\*) denotes: A duty cycle correction factor of -13.65dB was added to the average measurements.

**SAMPLE CALCULATION:**

Measurements taken at 1 meter distance were extrapolated to 3 meters using a factor of (-9.54 dB).

RESULTS: At 4884.12MHz: = 46.02 dBuV + 2.00 dB/m = 32.76 dBuV/m @ 3m

Margin = (54.0 – 32.76) = 21.2 dB

Test Date: June 14, 2013

Tested By

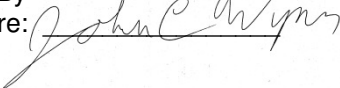
Signature: 

Name: John C. Wynn

US Tech Test Report:  
 FCC ID:  
 IC ID:  
 Test Report Number:  
 Issue Date:  
 Customer:  
 Model(s):

FCC Part 15 Certification & IC RSS  
 O7P-362  
 10147A-362  
 13-0186  
 July 29, 2013  
 Inventek Systems  
 ISM43362-M3G-L44-E and ISM43362-M3G-L44-U

**Table 14. 802.11g Peak Fundamental & Harmonic Emissions Antenna 2**

Radiated Harmonic and Spurious Emissions, Tested from 30 MHz – 24 GHz							
Tested By: JCW	Test: FCC Part 15, Para 15.247(d)			Client: Inventek Systems			
	Project: 13-0186			Model: ISM43362-M3G-L44E, ISM43362-M3G-L44-U			
Frequency (MHz)	Test Data (dBuV)	AF+CL-PA (dB/m)	Corrected Results (dBuV/m)	Limits (dBuV/m)	Distance / Polarization	Pass Margin (dB)	Detector PK / AVG
<b>LOW BAND - PEAK</b>							
2413.72	77.59	31.35	108.94		3.0m./ver	--	PK
4826.88	55.58	2.65	58.23	74	3.0m./ver	16.8	PK
7236.00	54.99	2.00	47.49	74	1.0m./ver	26.5	PK
<b>MID BAND- PEAK</b>							
2441.36	78.03	31.35	109.38		3.0m./ver	--	PK
4882.31	55.54	2.57	58.11	74.0	3.0m./ver	15.9	PK
7324.12	51.84	-7.20	44.64	74.0	1.0m./ver	29.4	PK
<b>HIGH BAND- PEAK</b>							
2461.95	79.59	31.60	111.19		3.0m./ver	--	PK
4920.10	55.54	2.77	58.31	74.0	3.0m./ver	15.7	PK
7383.75	50.52	2.28	43.30	74.0	1.0m./ver	30.7	PK

**SAMPLE CALCULATION:**

Measurements taken at 1 meter distance were extrapolated to 3 meter using a factor of (-9.54 dB).

RESULTS: At 4882.31 MHz: = 55.54 dBuV + 2.57 dB/m = 58.11dBuV/m @ 3m

Margin = (74.0 – 58.11) = 15.9 dB

Test Date: May 24, 2013

Tested By

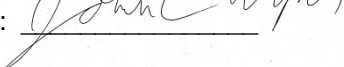
Signature: 

Name: John C. Wynn

US Tech Test Report:  
 FCC ID:  
 IC ID:  
 Test Report Number:  
 Issue Date:  
 Customer:  
 Model(s):

FCC Part 15 Certification & IC RSS  
 O7P-362  
 10147A-362  
 13-0186  
 July 29, 2013  
 Inventek Systems  
 ISM43362-M3G-L44-E and ISM43362-M3G-L44-U

**Table 15. 802.11g Average Fundamental & Harmonic Emissions Antenna 2**

Radiated Harmonic and Spurious Emissions, Tested from 30 MHz – 24 GHz							
Tested By: JCW	Test: FCC Part 15, Para 15.247(d)			Client: Inventek Systems			
	Project: 13-0186			Model: ISM43362-M3G-L44E, ISM43362-M3G-L44-U			
Frequency (MHz)	Test Data (dBuV)	AF+CL-PA (dB/m)	Corrected Results (dBuV/m)	Limits (dBuV/m)	Distance / Polarization	Pass Margin (dB)	Detector PK / AVG
<b>LOW BAND - Average</b>							
2413.72	65.64	31.35	96.99		3.0m./ver	--	<b>AVG</b>
4826.88	42.24	2.65	44.89	54.0	3.0m./ver	9.1	<b>AVG</b>
7236.00	40.35	-7.50	32.85	54.0	1.0m./ver	21.1	<b>AVG</b>
<b>MID BAND- Average</b>							
2441.36	66.47	31.35	97.82		3.0m./ver	--	<b>AVG</b>
4882.31	41.91	2.57	44.48	54.0	3.0m./ver	9.5	<b>AVG</b>
7324.12	39.01	-7.20	31.81	54.0	1.0m./ver	22.2	<b>AVG</b>
<b>HIGH BAND- Average</b>							
2461.95	66.74	31.60	98.34		3.0m./ver	--	<b>AVG</b>
4920.10	41.36	2.77	44.13	54.0	1.0m./ver	9.9	<b>AVG</b>
7383.75	37.65	2.28	30.43	54.0	1.0m./ver	23.6	<b>AVG</b>

(\*) denotes: A duty cycle correction factor of -13.65dB was added to the average measurements.

**SAMPLE CALCULATION:**

Measurements taken at 1 meter distance were extrapolated to 3 meter using a factor of (-9.54 dB).

RESULTS: At 4882.31MHz: = 41.91 dBuV + 2.57 dB/m = 44.48 dBuV/m @ 3m

Margin = (54.0 – 44.48) = 9.5 dB

Test Date: June 14, 2013

Tested By

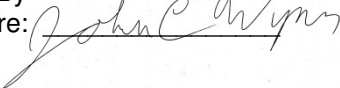
Signature: 

Name: John C. Wynn

US Tech Test Report:  
 FCC ID:  
 IC ID:  
 Test Report Number:  
 Issue Date:  
 Customer:  
 Model(s):

FCC Part 15 Certification & IC RSS  
 O7P-362  
 10147A-362  
 13-0186  
 July 29, 2013  
 Inventek Systems  
 ISM43362-M3G-L44-E and ISM43362-M3G-L44-U

**Table 16. 802.11n Peak Fundamental & Harmonic Emissions Antenna 2**

Radiated Harmonic and Spurious Emissions, Tested from 30 MHz – 24 GHz							
Tested By: JCW	Test: FCC Part 15, Para 15.247(d)			Client: Inventek Systems			
	Project: 13-0186			Model: ISM43362-M3G-L44E, ISM43362-M3G-L44-U			
Frequency (MHz)	Test Data (dBuV)	AF+CL-PA (dB/m)	Corrected Results (dBuV/m)	Limits (dBuV/m)	Distance / Polarization	Pass Margin (dB)	Detector PK / AVG
<b>LOW BAND - PEAK</b>							
2413.72	75.42	26.28	101.70		3.0m./ver	--	PK
4826.88	55.63	-2.41	53.22	74.0	3.0m./ver	21.8	PK
7236.00	51.89	-7.00	44.39	74.0	1.0m./ver	29.1	PK
<b>MID BAND- PEAK</b>							
2439.92	77.34	26.28	103.62		3.0m./ver	--	PK
4882.50	53.77	-2.50	51.27	74.0	3.0m./ver	22.7	PK
7325.50	49.65	-7.20	42.45	74.0	1.0m./ver	31.6	PK
<b>HIGH BAND- PEAK</b>							
2459.59	77.30	26.54	103.84		3.0m./ver	--	PK
4920.52	52.43	-2.29	50.14	74.0	3.0m./ver	24.9	PK
7386.38	45.67	2.28	38.45	74.0	1.0m./ver	35.6	PK

**SAMPLE CALCULATION:**

Measurements taken at 1 meter distance were extrapolated to 3 meter using a factor of (-9.54 dB).

RESULTS: At 4882.5 MHz: = 53.77 dBuV - 2.57 dB/m = 51.27dBuV/m @ 3m

Margin = (74.0 – 51.27) = 22.7 dB

Test Date: June 14, 2013

Tested By

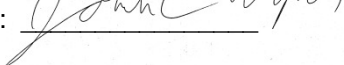
Signature: 

Name: John C. Wynn

US Tech Test Report:  
 FCC ID:  
 IC ID:  
 Test Report Number:  
 Issue Date:  
 Customer:  
 Model(s):

FCC Part 15 Certification & IC RSS  
 O7P-362  
 10147A-362  
 13-0186  
 July 29, 2013  
 Inventek Systems  
 ISM43362-M3G-L44-E and ISM43362-M3G-L44-U

**Table 17. 802.11n Average Fundamental & Harmonic Emissions Antenna 2**  
**Radiated Harmonic and Spurious Emissions, Tested from 30 MHz – 24 GHz**

Tested By: JCW		Test: FCC Part 15, Para 15.247(d)		Client: Inventek Systems				
Frequency (MHz)		Test Data (dBuV)	AF+CL-PA (dB/m)	Corrected Results (dBuV/m)	Limits (dBuV/m)	Distance / Polarization	Pass Margin (dB)	Detector PK / AVG
		Project: 13-0186		Model: ISM43362-M3G-L44E, ISM43362-M3G-L44-U				
<b>LOW BAND - Average</b>								
2413.72	63.05	26.28	89.33		3.0m./ver	--		<b>AVG</b>
4826.88	42.34	-2.41	39.93	54.0	3.0m./ver	14.1		<b>AVG</b>
7236.00	36.50	-7.50	29.00	54.0	1.0m./ver	25.0		<b>AVG</b>
<b>MID BAND- Average</b>								
2439.92	64.48	26.28	90.76		3.0m./ver	--		<b>AVG</b>
4882.50	39.19	-2.50	36.69	54.0	3.0m./ver	17.3		<b>AVG</b>
7325.50	38.45	-7.20	31.25	54.0	1.0m./ver	22.8		<b>AVG</b>
<b>HIGH BAND- Average</b>								
2459.59	65.51	26.54	92.05		3.0m./ver	--		<b>AVG</b>
4920.52	39.42	-2.29	37.13	54.0	1.0m./ver	16.9		<b>AVG</b>
7386.38	36.63	2.28	29.41	54.0	1.0m./ver	24.6		<b>AVG</b>

**SAMPLE CALCULATION:**

Measurements taken at 1 meter distance were extrapolated to 3 meter using a factor of (-9.54 dB).

RESULTS: At 4882.5MHz: = 39.19 dBuV -2.50 dB/m = 36.69 dBuV/m @ 3m

Margin = (54.0 – 36.69) = 17.3 dB

Test Date: June 14, 2013

Tested By

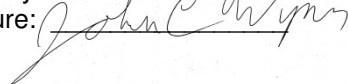
Signature: 

Name: John C. Wynn

US Tech Test Report:  
 FCC ID:  
 IC ID:  
 Test Report Number:  
 Issue Date:  
 Customer:  
 Model(s):

FCC Part 15 Certification & IC RSS  
 O7P-362  
 10147A-362  
 13-0186  
 July 29, 2013  
 Inventek Systems  
 ISM43362-M3G-L44-E and ISM43362-M3G-L44-U

**2.12 6 dB Bandwidth per CFR 15.247(a)(2), (IC RSS 210, A8.2(a))**

The EUT was connected to the spectrum analyzer through the u.fl port for direct measurements. An 8 dB attenuator was used during the measurement and was factored out during the measurement. The RBW was set to approximately 1/100 of the manufacturers claimed RBW and with the VBW  $\geq$  RBW. The results of this test are given in Table 9 and Figures 40 through 48.

**Table 18. 6 dB Bandwidth**

Frequency (MHz)	6 dB Bandwidth (MHz)	Minimum FCC Bandwidth (MHz)
802.11b		
2412	6.86	0.5
2442	7.70	0.5
2462	7.34	0.5
802.11g		
2412	15.74	0.5
2442	15.78	0.5
2462	16.00	0.5
802.11n		
2412	17.40	0.5
2442	17.06	0.5
2462	16.98	0.5

Test Date: June 16, 2013

Tested By  
 Signature: 

Name: George Yang

US Tech Test Report:  
FCC ID:  
IC ID:  
Test Report Number:  
Issue Date:  
Customer:  
Model(s):

FCC Part 15 Certification & IC RSS  
O7P-362  
10147A-362  
13-0186  
July 29, 2013  
Inventek Systems  
ISM43362-M3G-L44-E and ISM43362-M3G-L44-U

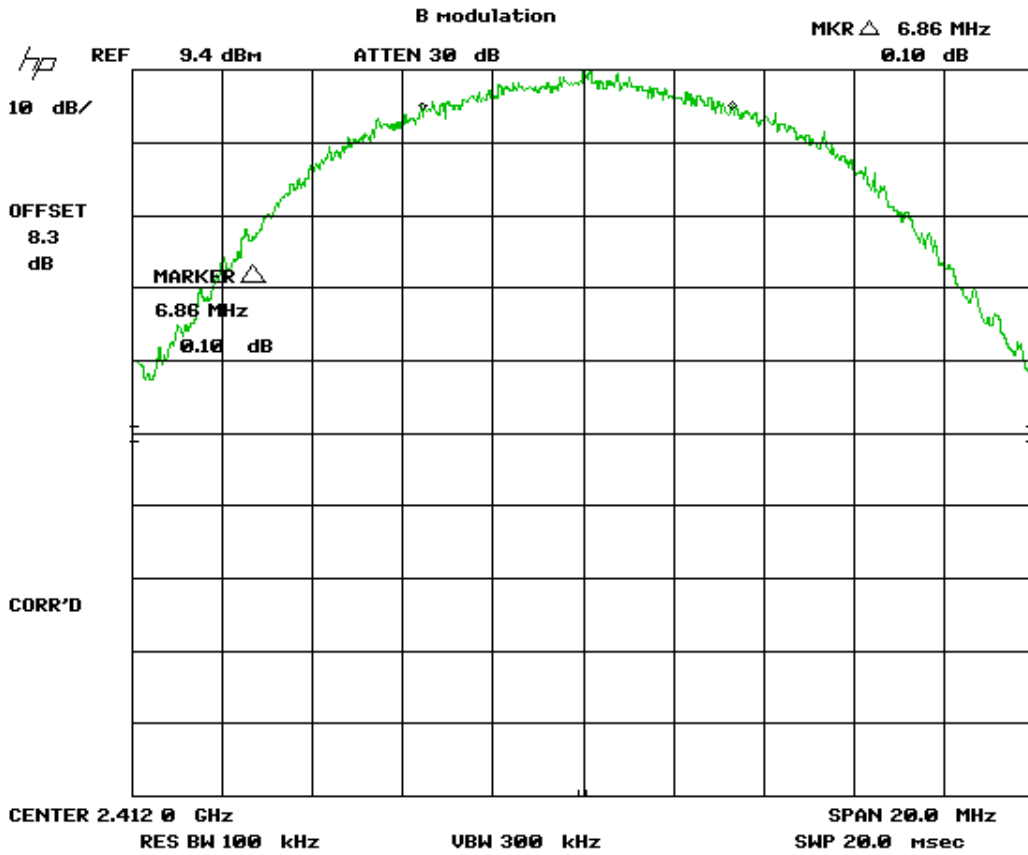

Figure 40. 6 dB Bandwidth - 15.247 (a) (2) – 802.11b – Low Channel



US Tech Test Report:  
FCC ID:  
IC ID:  
Test Report Number:  
Issue Date:  
Customer:  
Model(s):

FCC Part 15 Certification & IC RSS  
O7P-362  
10147A-362  
13-0186  
July 29, 2013  
Inventek Systems  
ISM43362-M3G-L44-E and ISM43362-M3G-L44-U

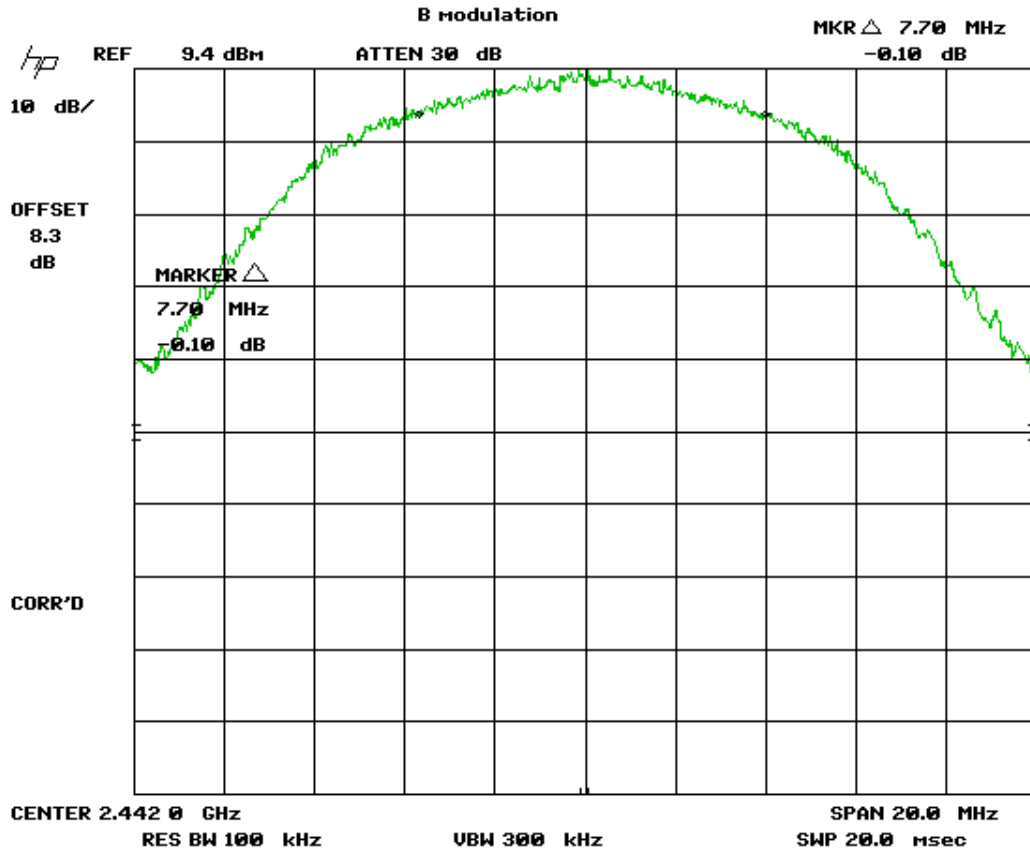

Figure 41. 6 dB Bandwidth - 15.247 (a) (2) - 802.11b - Mid Channel

US Tech Test Report:  
FCC ID:  
IC ID:  
Test Report Number:  
Issue Date:  
Customer:  
Model(s):

FCC Part 15 Certification & IC RSS  
O7P-362  
10147A-362  
13-0186  
July 29, 2013  
Inventek Systems  
ISM43362-M3G-L44-E and ISM43362-M3G-L44-U

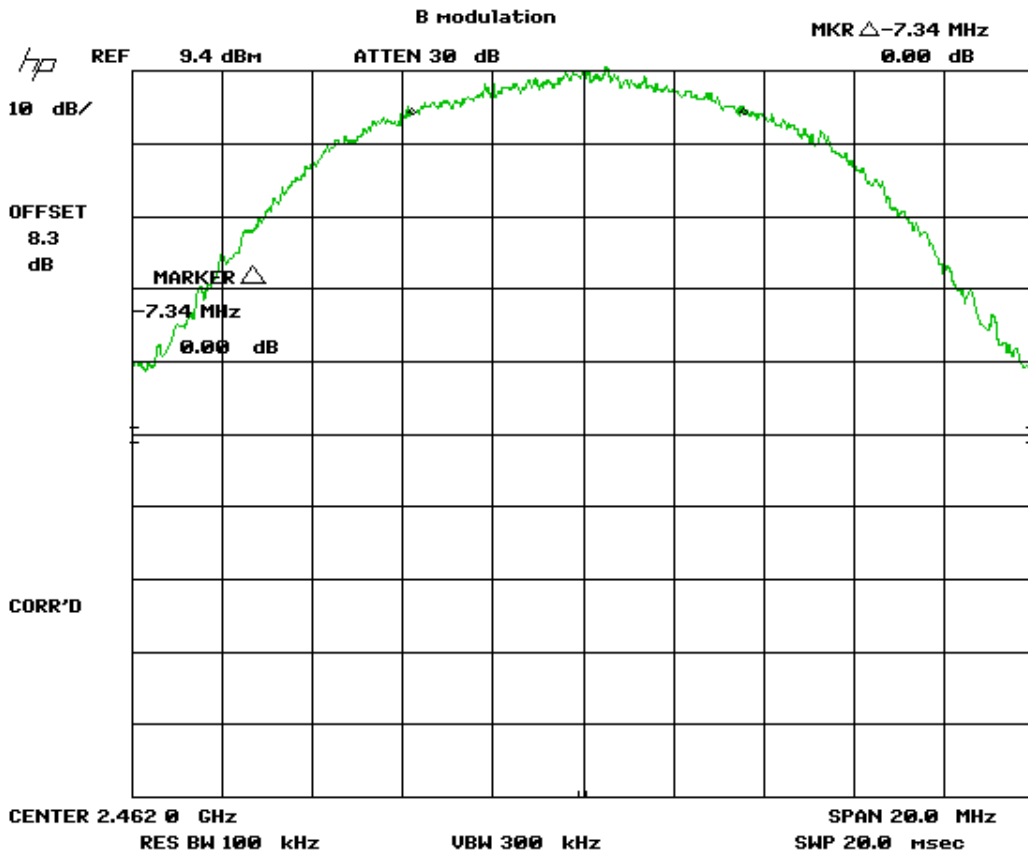

Figure 42. 6 dB Bandwidth - 15.247 (a) (2) – 802.11b – High Channel

US Tech Test Report:  
FCC ID:  
IC ID:  
Test Report Number:  
Issue Date:  
Customer:  
Model(s):

FCC Part 15 Certification & IC RSS  
O7P-362  
10147A-362  
13-0186  
July 29, 2013  
Inventek Systems  
ISM43362-M3G-L44-E and ISM43362-M3G-L44-U

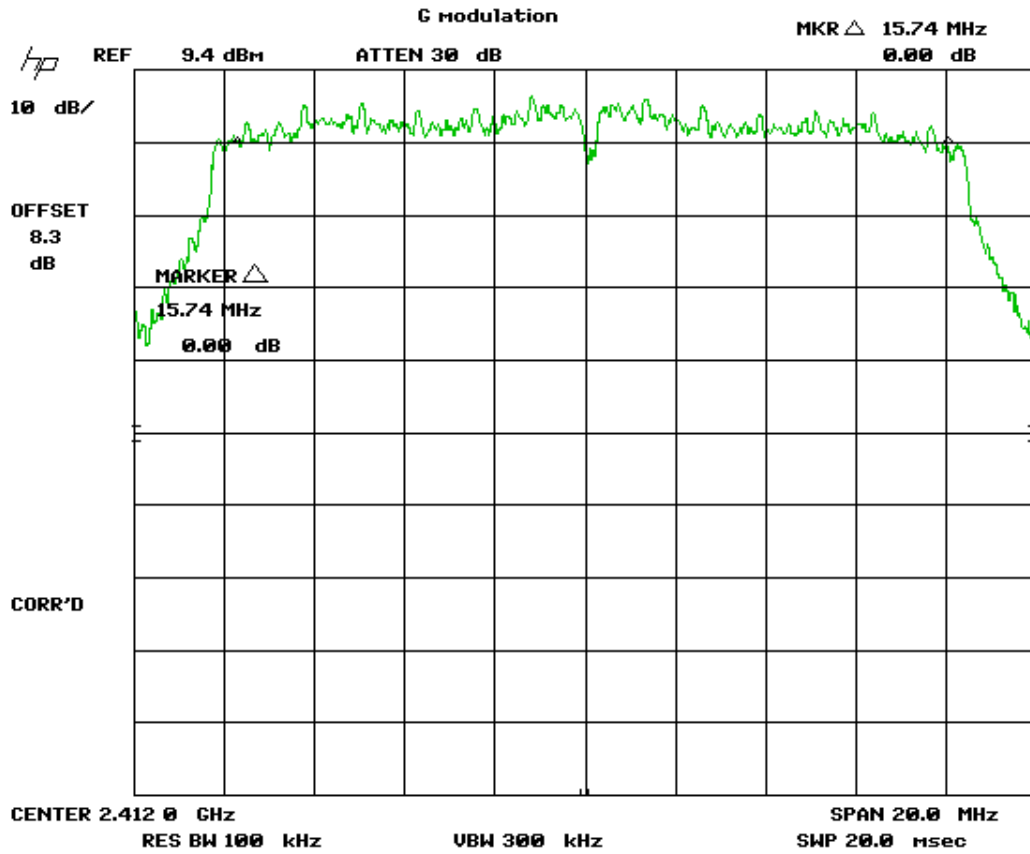

Figure 43. 6 dB Bandwidth - 15.247 (a) (2) – 802.11g – Low Channel

US Tech Test Report:  
FCC ID:  
IC ID:  
Test Report Number:  
Issue Date:  
Customer:  
Model(s):

FCC Part 15 Certification & IC RSS  
O7P-362  
10147A-362  
13-0186  
July 29, 2013  
Inventek Systems  
ISM43362-M3G-L44-E and ISM43362-M3G-L44-U

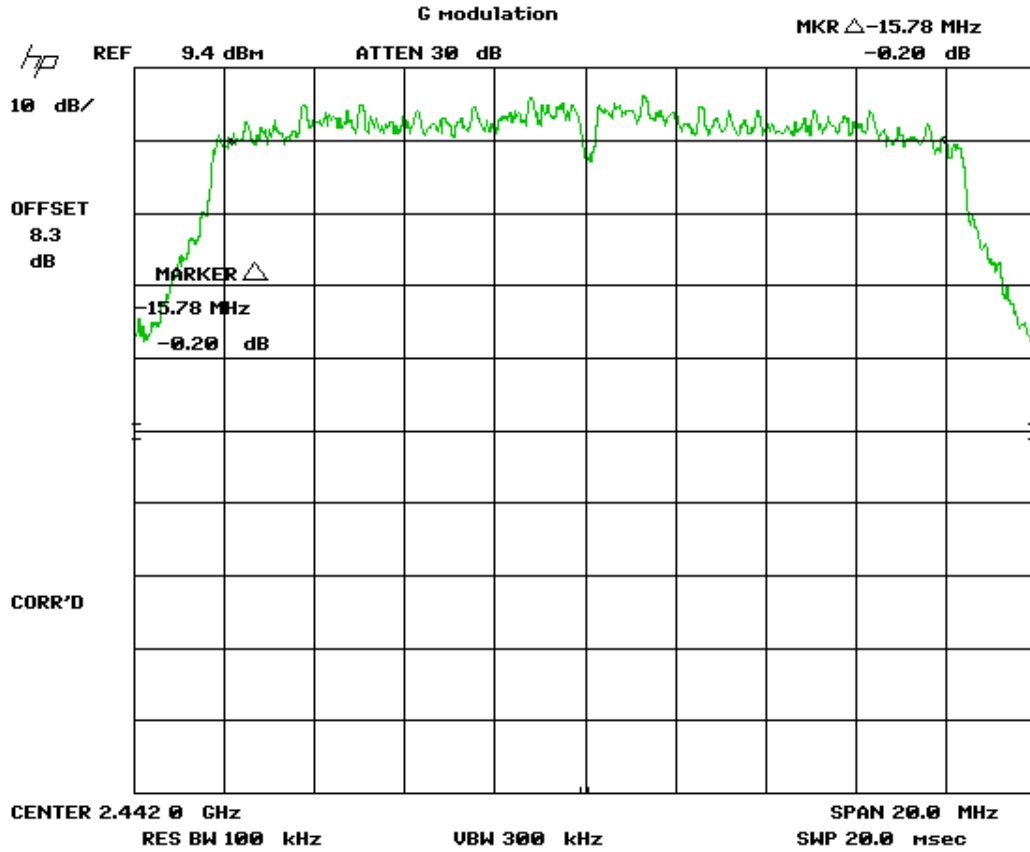

Figure 44. 6 dB Bandwidth - 15.247 (a) (2) - 802.11g - Mid Channel

US Tech Test Report:  
FCC ID:  
IC ID:  
Test Report Number:  
Issue Date:  
Customer:  
Model(s):

FCC Part 15 Certification & IC RSS  
O7P-362  
10147A-362  
13-0186  
July 29, 2013  
Inventek Systems  
ISM43362-M3G-L44-E and ISM43362-M3G-L44-U

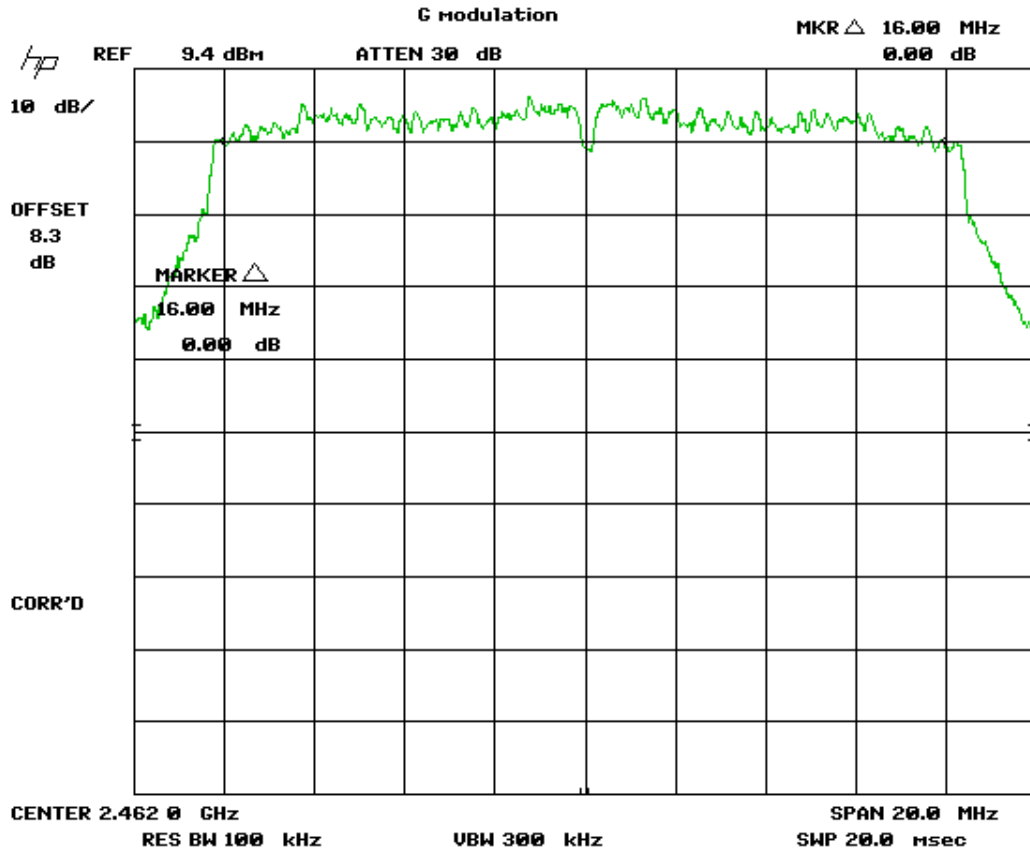

Figure 45. 6 dB Bandwidth - 15.247 (a) (2) – 802.11g – High Channel

US Tech Test Report:  
FCC ID:  
IC ID:  
Test Report Number:  
Issue Date:  
Customer:  
Model(s):

FCC Part 15 Certification & IC RSS  
O7P-362  
10147A-362  
13-0186  
July 29, 2013  
Inventek Systems  
ISM43362-M3G-L44-E and ISM43362-M3G-L44-U

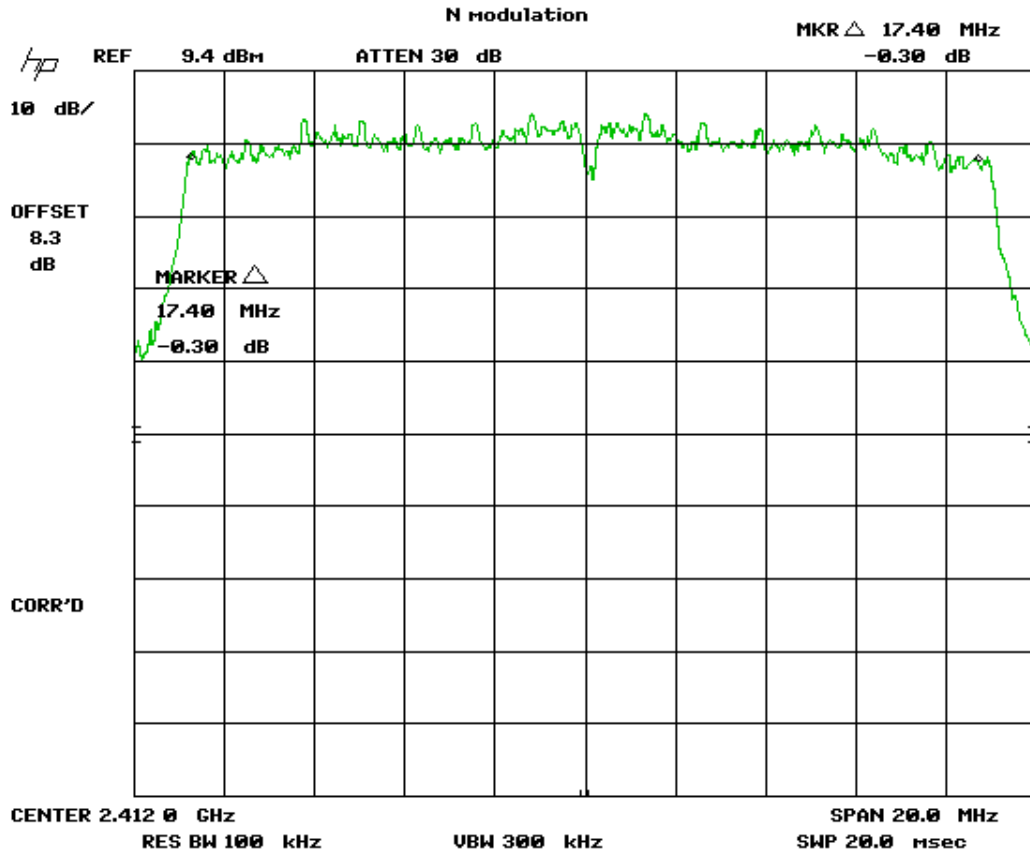

Figure 46. 6 dB Bandwidth - 15.247 (a) (2) – 802.11n – Low Channel

US Tech Test Report:  
FCC ID:  
IC ID:  
Test Report Number:  
Issue Date:  
Customer:  
Model(s):

FCC Part 15 Certification & IC RSS  
O7P-362  
10147A-362  
13-0186  
July 29, 2013  
Inventek Systems  
ISM43362-M3G-L44-E and ISM43362-M3G-L44-U

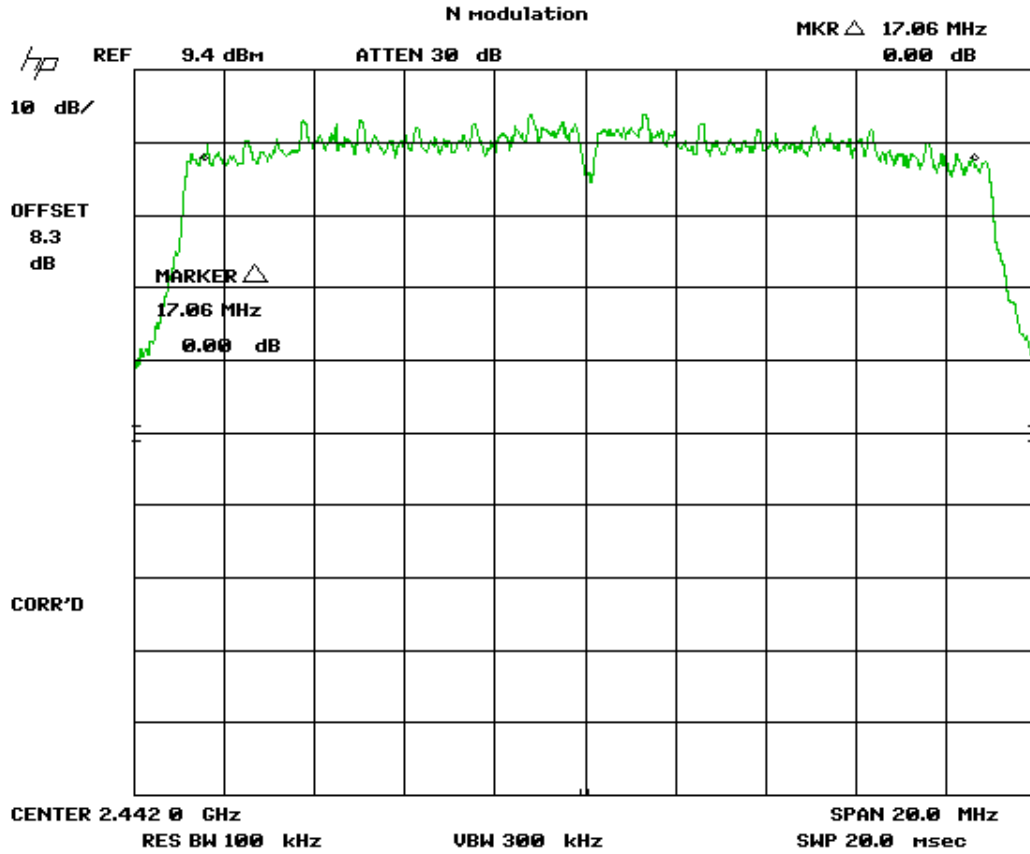

Figure 47. 6 dB Bandwidth - 15.247 (a) (2) - 802.11n - Mid Channel

US Tech Test Report:  
FCC ID:  
IC ID:  
Test Report Number:  
Issue Date:  
Customer:  
Model(s):

FCC Part 15 Certification & IC RSS  
O7P-362  
10147A-362  
13-0186  
July 29, 2013  
Inventek Systems  
ISM43362-M3G-L44-E and ISM43362-M3G-L44-U

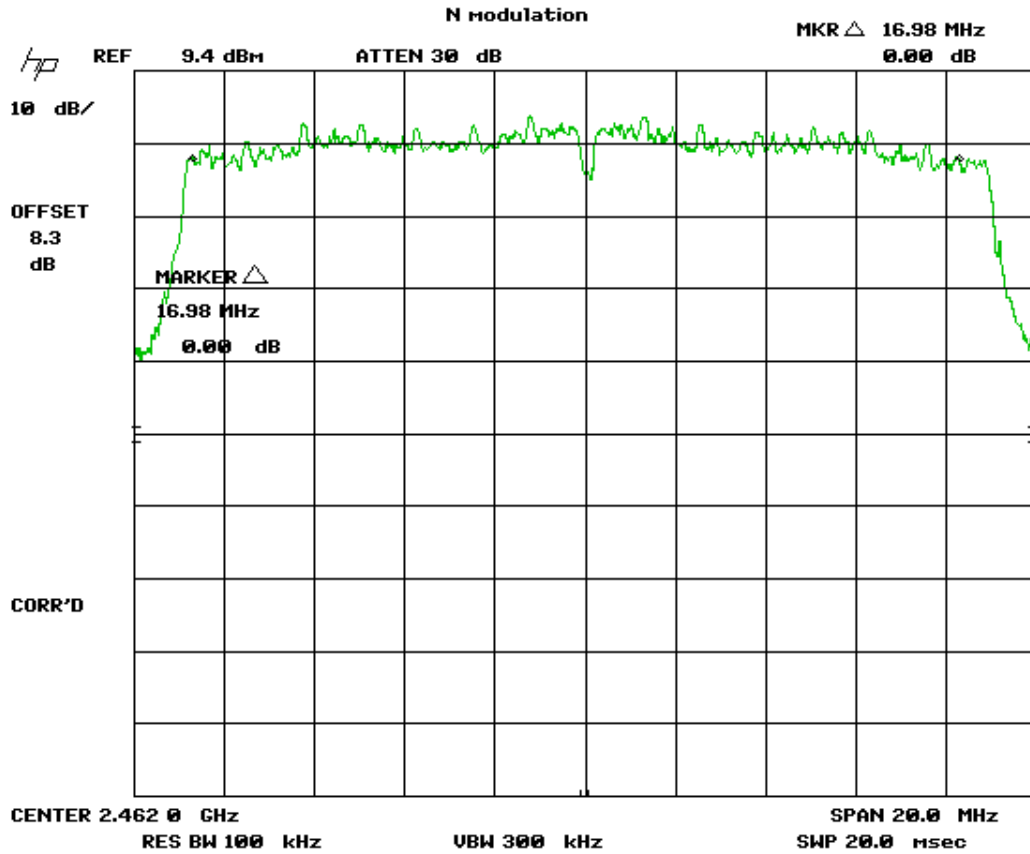

Figure 48. 6 dB Bandwidth - 15.247 (a) (2) – 802.11n – High Channel



US Tech Test Report:  
FCC ID:  
IC ID:  
Test Report Number:  
Issue Date:  
Customer:  
Model(s):

FCC Part 15 Certification & IC RSS  
O7P-362  
10147A-362  
13-0186  
July 29, 2013  
Inventek Systems  
ISM43362-M3G-L44-E and ISM43362-M3G-L44-U

---

### **2.13 Maximum Peak Conducted Output Power (CFR 15.247 (b) (3))**

For this EUT, the transmitter was programmed to operate at a maximum of 20 dBm across the bandwidth therefore the manufacturer set the units to a power setting of 20 dBm output using the manufacturer's proprietary software. This setting will be set for all radios. This setting is not user accessible and will be a permanent setting.

Peak power within the band 2400 MHz to 2483.5 MHz was measured per FCC KDB Publication 558074. The EUT antenna port was connected to a spectrum analyzer having a 50  $\Omega$  input impedance. The spectrum analyzer was set for an impedance of 50  $\Omega$  with the RBW set greater than the 20 dB bandwidth of the EUT, and the VBW  $\geq$  RBW. The loss of the short cable is 0.3 dB, and addition of an attenuator, 8.0 dB and the final corrected measurements were determined by adding 8.3 dB to the raw data measured values of Figures 49 to 57. Peak antenna conducted output power is tabulated in the table below.

US Tech Test Report:  
 FCC ID:  
 IC ID:  
 Test Report Number:  
 Issue Date:  
 Customer:  
 Model(s):

FCC Part 15 Certification & IC RSS  
 O7P-362  
 10147A-362  
 13-0186  
 July 29, 2013  
 Inventek Systems  
 ISM43362-M3G-L44-E and ISM43362-M3G-L44-U

**Table 19. Peak Antenna Conducted Output Power per Part 15.247 (b) (3)**

Frequency of Fundamental (MHz)	Test Result (dBm)	Calculated Power Output (mW)	FCC Limit (mW Maximum)
802.11b			
2412.00	19.1	81.28	1000
2442.00	19.1	81.28	1000
2462.00	19.0	79.43	1000
802.11g			
2412.00	19.7	94.41	1000
2442.00	19.9	97.72	1000
2462.00	19.7	93.33	1000
802.11n			
2412.00	17.8	60.26	1000
2442.00	17.0	50.12	1000
2462.00	17.7	58.88	1000

Test Date: June 16, 2013

Tested By

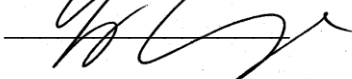
Signature: 

Name: George Yang

US Tech Test Report:  
FCC ID:  
IC ID:  
Test Report Number:  
Issue Date:  
Customer:  
Model(s):

FCC Part 15 Certification & IC RSS  
O7P-362  
10147A-362  
13-0186  
July 29, 2013  
Inventek Systems  
ISM43362-M3G-L44-E and ISM43362-M3G-L44-U

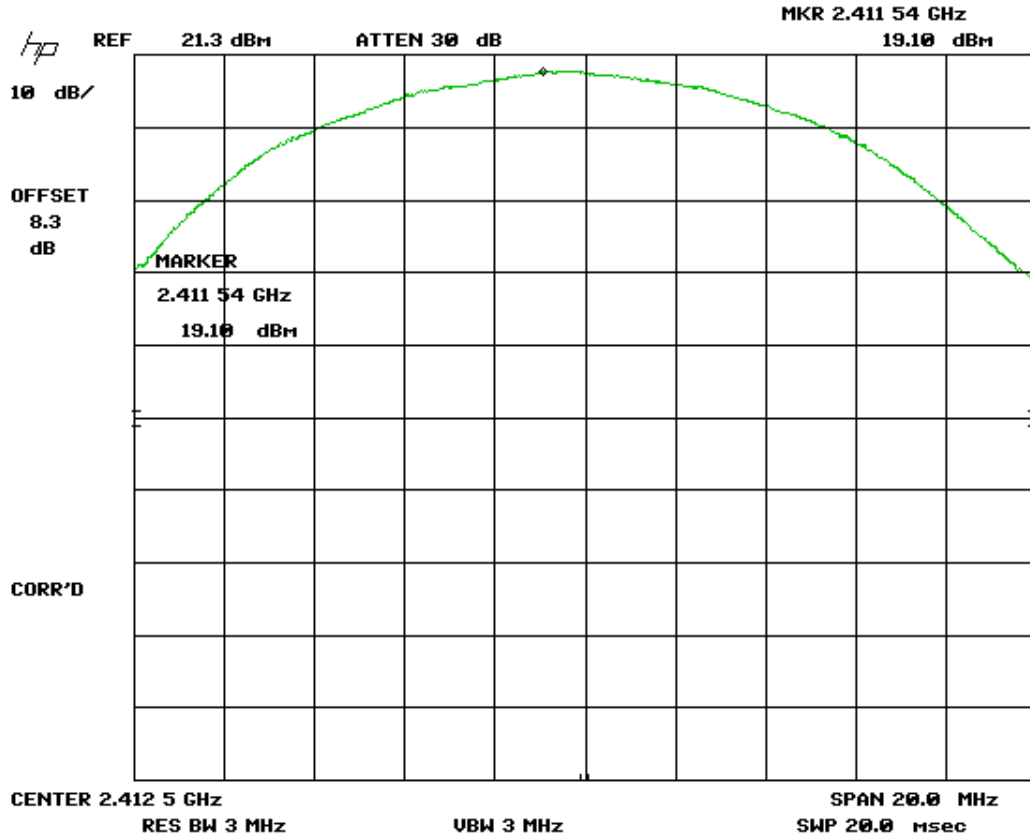

Figure 49. IEEE 802.11b, Low Channel

US Tech Test Report:  
FCC ID:  
IC ID:  
Test Report Number:  
Issue Date:  
Customer:  
Model(s):

FCC Part 15 Certification & IC RSS  
O7P-362  
10147A-362  
13-0186  
July 29, 2013  
Inventek Systems  
ISM43362-M3G-L44-E and ISM43362-M3G-L44-U

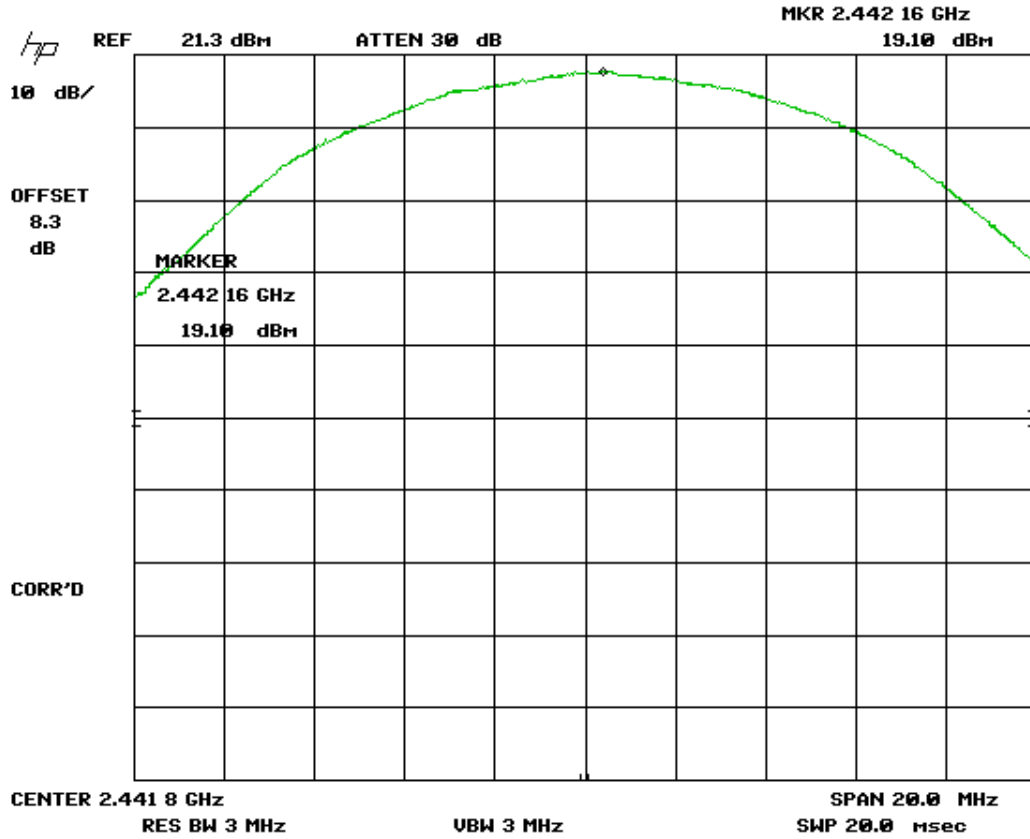

Figure 50. IEEE 802.11b, Mid Channel

US Tech Test Report:  
FCC ID:  
IC ID:  
Test Report Number:  
Issue Date:  
Customer:  
Model(s):

FCC Part 15 Certification & IC RSS  
O7P-362  
10147A-362  
13-0186  
July 29, 2013  
Inventek Systems  
ISM43362-M3G-L44-E and ISM43362-M3G-L44-U

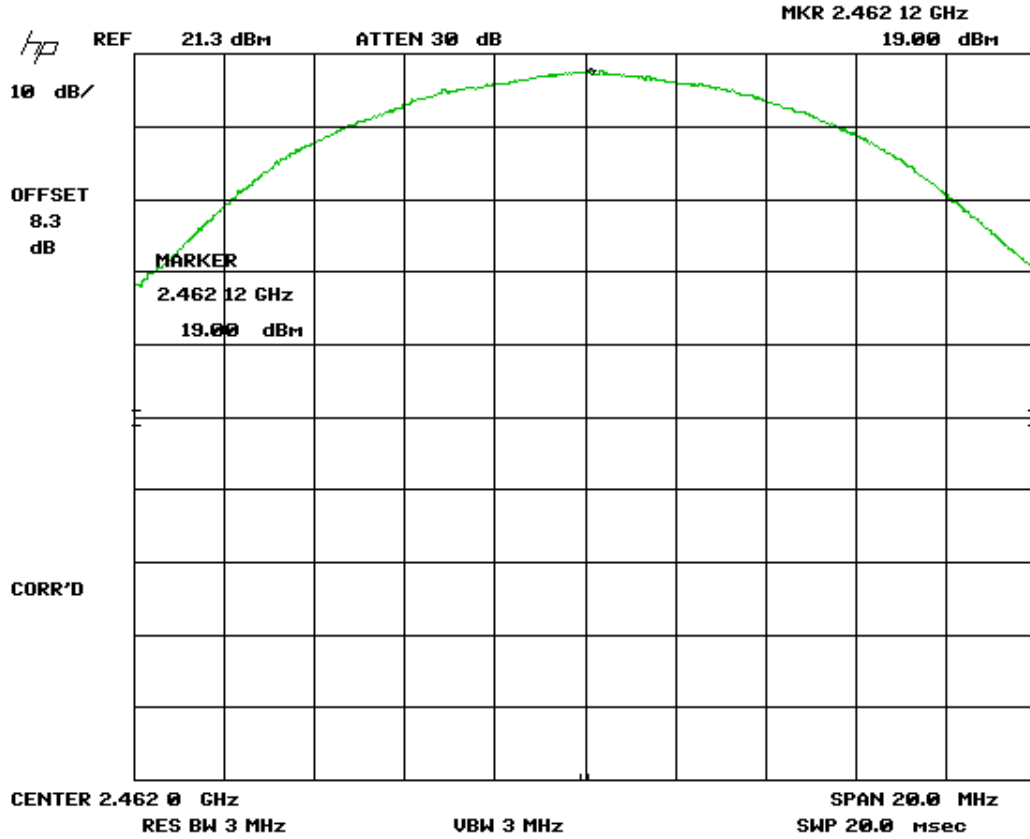

Figure 51. IEEE 802.11b, High Channel

US Tech Test Report:  
FCC ID:  
IC ID:  
Test Report Number:  
Issue Date:  
Customer:  
Model(s):

FCC Part 15 Certification & IC RSS  
O7P-362  
10147A-362  
13-0186  
July 29, 2013  
Inventek Systems  
ISM43362-M3G-L44-E and ISM43362-M3G-L44-U

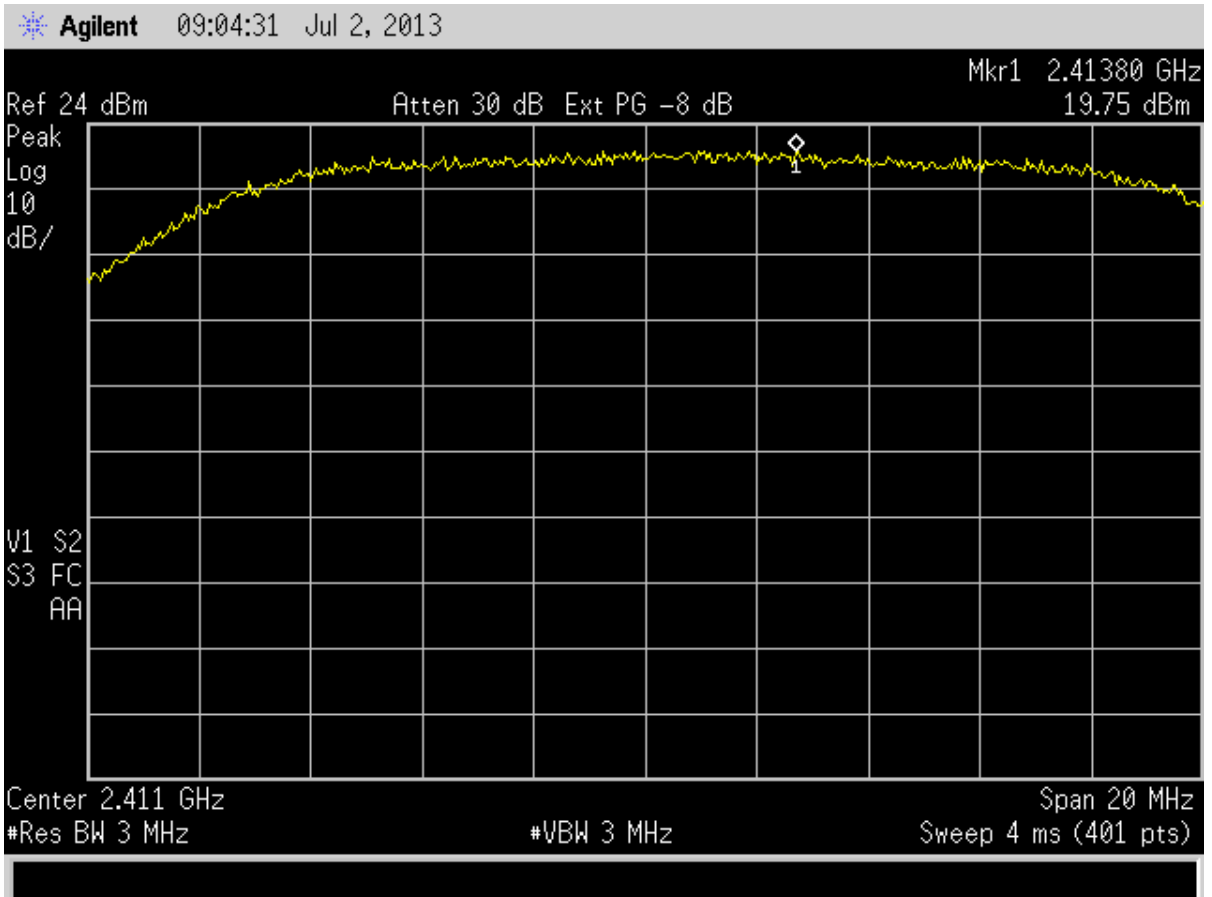

Figure 52. IEEE 802.11g, Low Channel

US Tech Test Report:  
FCC ID:  
IC ID:  
Test Report Number:  
Issue Date:  
Customer:  
Model(s):

FCC Part 15 Certification & IC RSS  
O7P-362  
10147A-362  
13-0186  
July 29, 2013  
Inventek Systems  
ISM43362-M3G-L44-E and ISM43362-M3G-L44-U

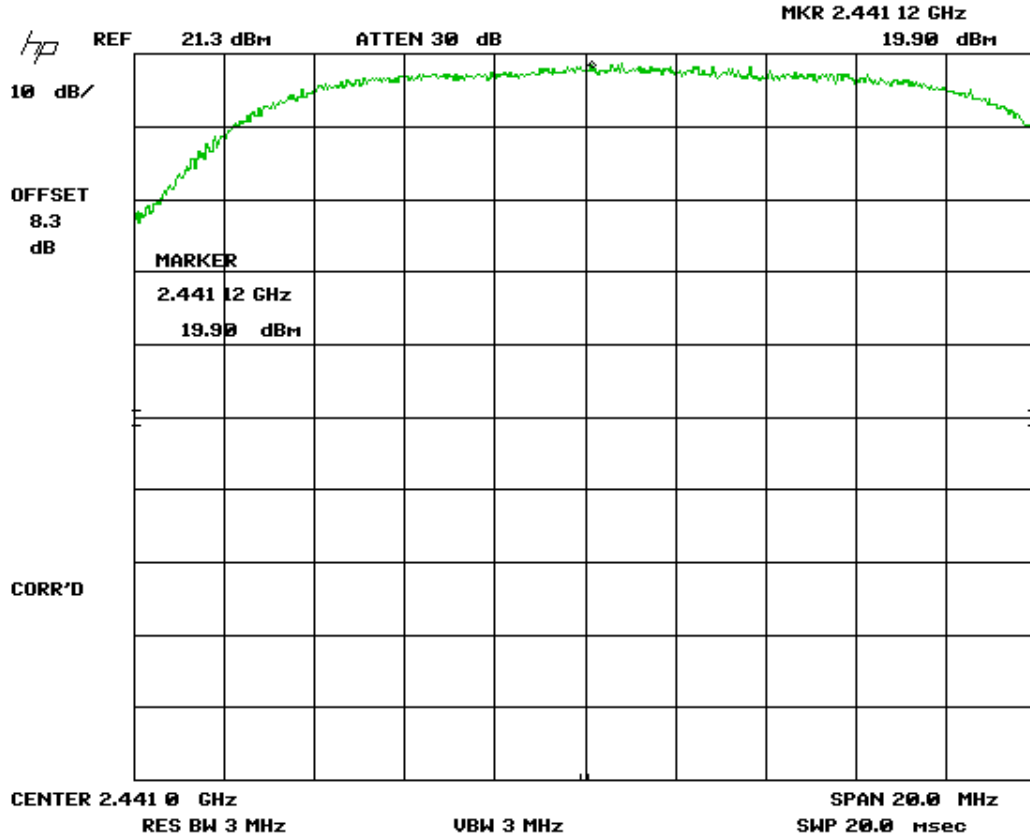

Figure 53. IEEE 802.11g, Mid Channel

US Tech Test Report:  
FCC ID:  
IC ID:  
Test Report Number:  
Issue Date:  
Customer:  
Model(s):

FCC Part 15 Certification & IC RSS  
O7P-362  
10147A-362  
13-0186  
July 29, 2013  
Inventek Systems  
ISM43362-M3G-L44-E and ISM43362-M3G-L44-U

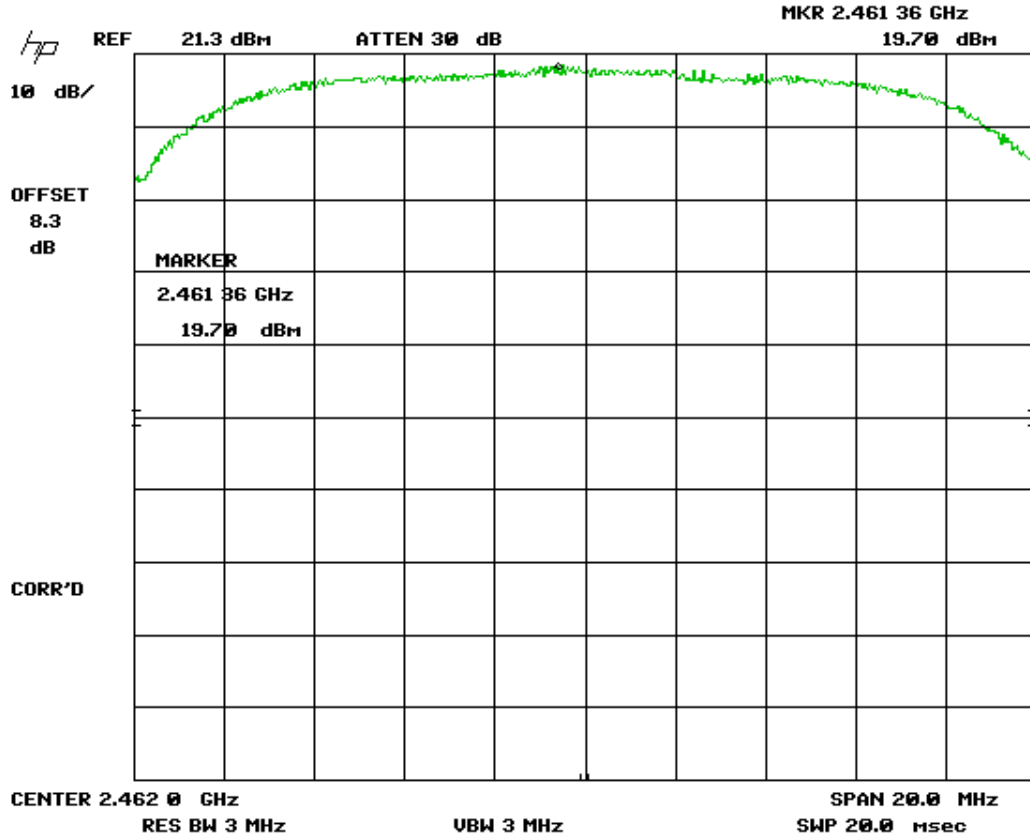

Figure 54. IEEE 802.11g, High Channel



US Tech Test Report:  
FCC ID:  
IC ID:  
Test Report Number:  
Issue Date:  
Customer:  
Model(s):

FCC Part 15 Certification & IC RSS  
O7P-362  
10147A-362  
13-0186  
July 29, 2013  
Inventek Systems  
ISM43362-M3G-L44-E and ISM43362-M3G-L44-U

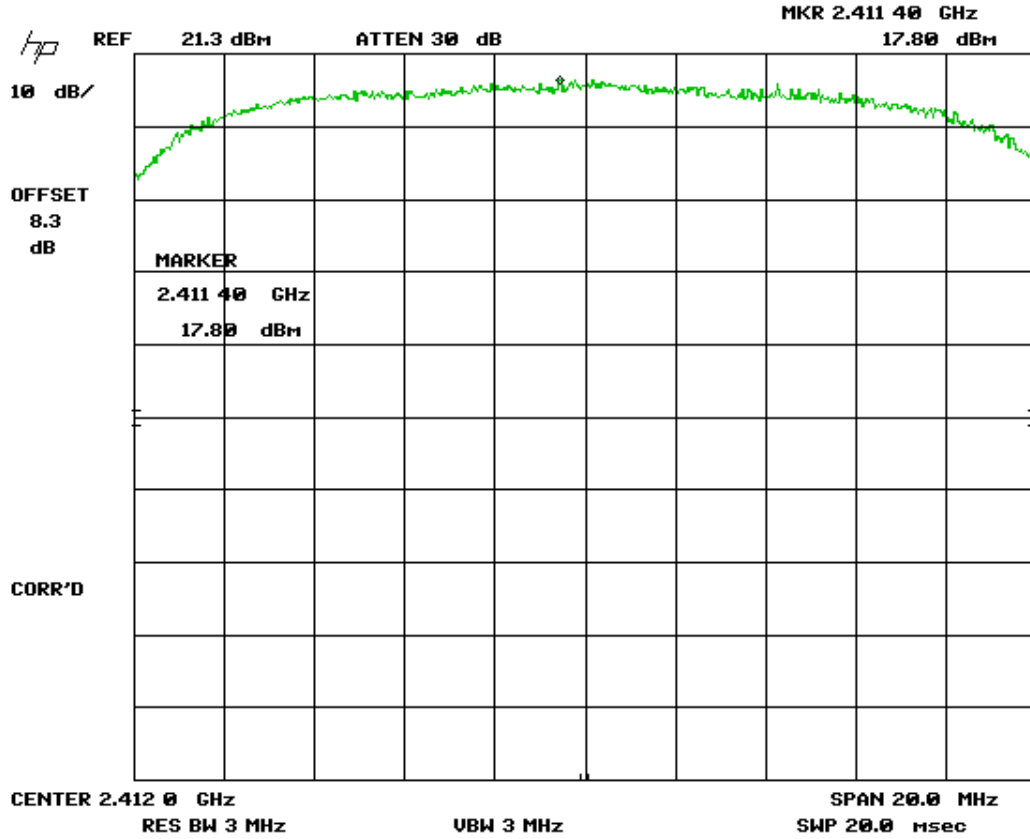

Figure 55. IEEE 802.11n, Low Channel

US Tech Test Report:  
FCC ID:  
IC ID:  
Test Report Number:  
Issue Date:  
Customer:  
Model(s):

FCC Part 15 Certification & IC RSS  
O7P-362  
10147A-362  
13-0186  
July 29, 2013  
Inventek Systems  
ISM43362-M3G-L44-E and ISM43362-M3G-L44-U

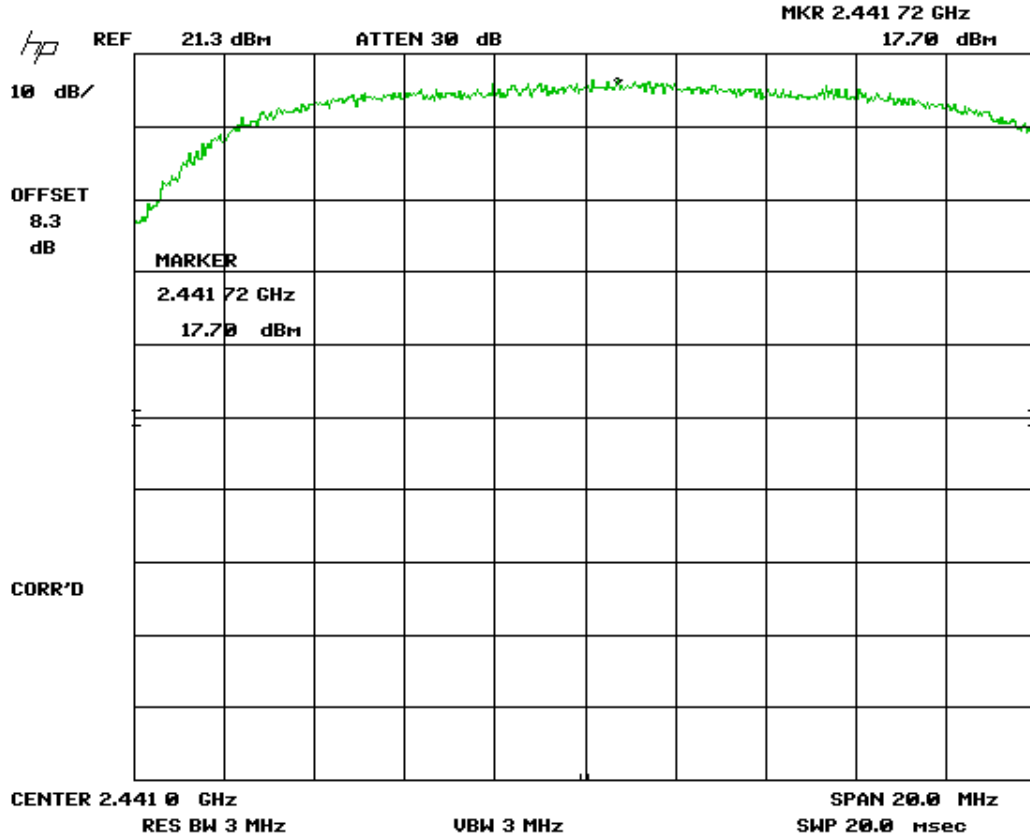

Figure 56. IEEE 802.11n, Mid Channel

US Tech Test Report:  
FCC ID:  
IC ID:  
Test Report Number:  
Issue Date:  
Customer:  
Model(s):

FCC Part 15 Certification & IC RSS  
O7P-362  
10147A-362  
13-0186  
July 29, 2013  
Inventek Systems  
ISM43362-M3G-L44-E and ISM43362-M3G-L44-U

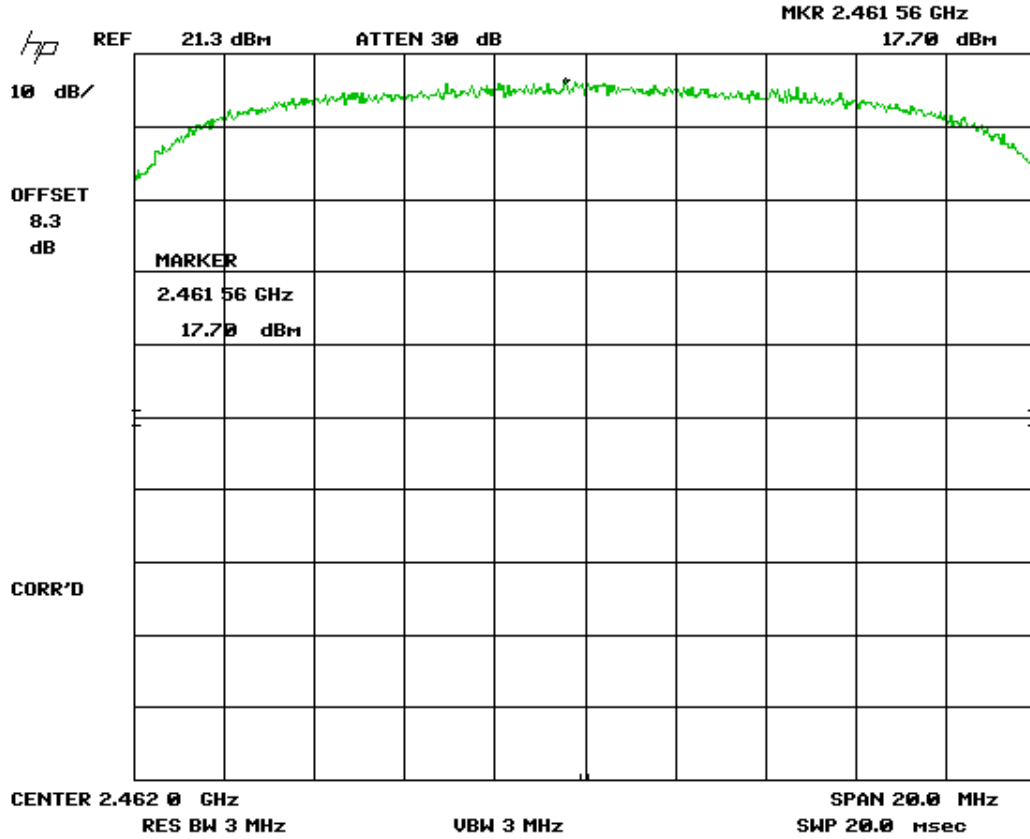

Figure 57. IEEE 802.11n, High Channel

US Tech Test Report:  
 FCC ID:  
 IC ID:  
 Test Report Number:  
 Issue Date:  
 Customer:  
 Model(s):

FCC Part 15 Certification & IC RSS  
 O7P-362  
 10147A-362  
 13-0186  
 July 29, 2013  
 Inventek Systems  
 ISM43362-M3G-L44-E and ISM43362-M3G-L44-U

**2.14 Power Spectral Density (CFR 15.247(e)) (IC RSS 210 A8.5)**

The transmitter was placed into a continuous mode of operation at all applicable frequencies. The measurements were performed per the procedures of FCC KDB Procedure 558074. The PKPSD method was used because the conducted power measurements were also collected with PK detection. The RBW and VBW were set to 100 kHz and 300 kHz respectively, the span was set to 5-30% greater than the EBW. Peak detection was used as well as max hold. The collected test data was then corrected using the bandwidth correction factor of -15.2 dB(BWCF= 10log (3 kHz/100 kHz)).

In accordance with 15.247 (e), the power spectral density shall be no greater than +8 dBm per any 3 kHz band.

Results are shown in Table 20 and Figures 58 through 66 below. Results are corrected by adding 8.3 dB to the measured value to account for the cable loss and attenuator used. All are less than +8 dBm per 3 kHz band.

**Table 20. Power Spectral Density for 802.11b Low, Mid and High Channels**

Frequency (MHz)	Test Data (dBm/100 KHz)	Correction Factor (dB)	Corrected Results (dBm/3 kHz)	FCC Limit (dBm/3 kHz)
802.11b				
Low-2412	6.735	-15.2	-8.465	8
Mid-2442	6.182	-15.2	-9.018	8
High- 2462	7.204	-15.2	-7.996	8
802.11g				
Low-2412	4.147	-15.2	-11.053	8
Mid-2442	3.771	-15.2	-11.429	8
High- 2462	3.806	-15.2	-11.394	8
802.11n				
Low-2412	4.074	-15.2	-11.126	8
Mid-2442	9.943	-15.2	-5.257	8
High- 2462	3.890	-15.2	-11.31	8

Note: reference adjusted for correction factor of 8.3 dB for attenuator.

Test Date: July 10, 2013

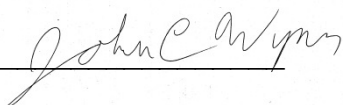
Tested By  
 Signature: 

Name: John C. Wynn

US Tech Test Report:  
FCC ID:  
IC ID:  
Test Report Number:  
Issue Date:  
Customer:  
Model(s):

FCC Part 15 Certification & IC RSS  
O7P-362  
10147A-362  
13-0186  
July 29, 2013  
Inventek Systems  
ISM43362-M3G-L44-E and ISM43362-M3G-L44-U

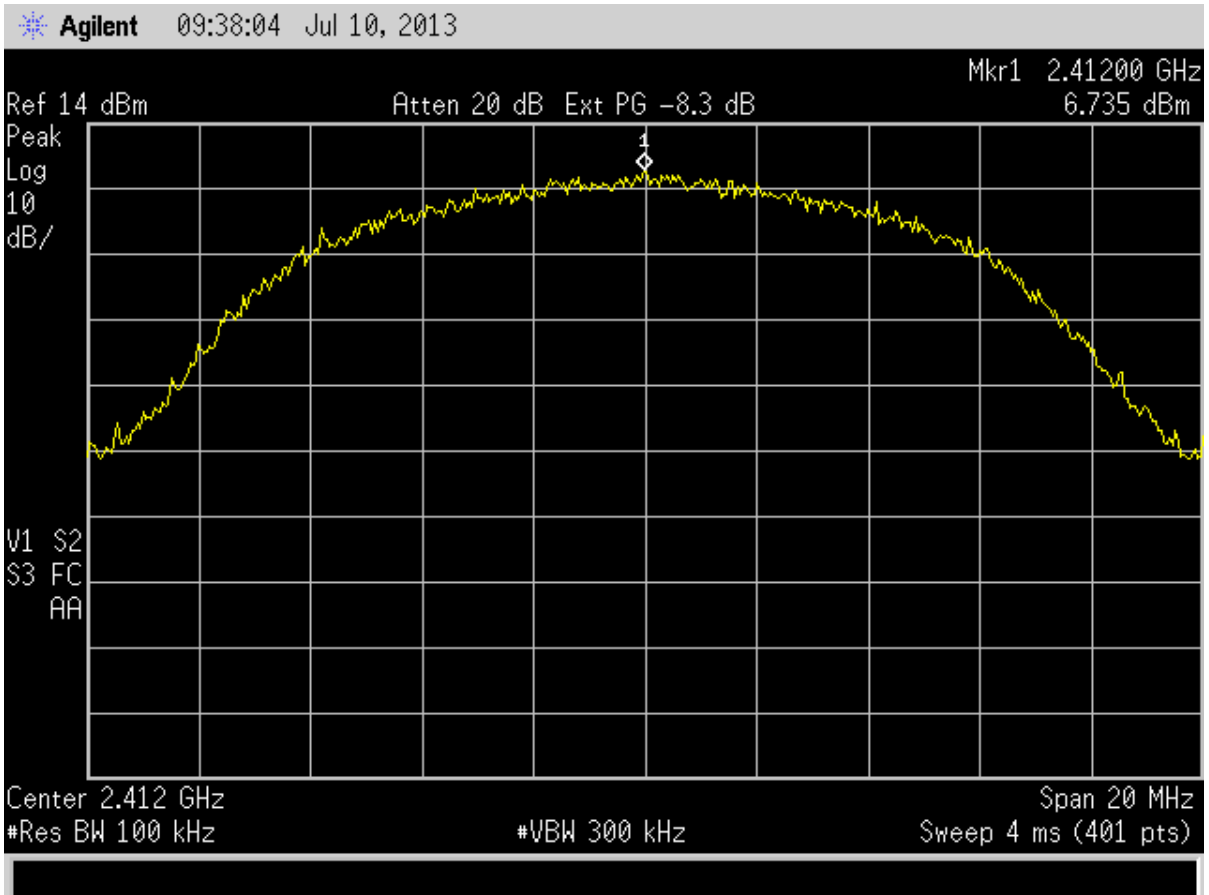

**Figure 58. 802.11(b) Peak Power Spectral Density - Part 15.247 (e) - Low Channel**

US Tech Test Report:  
FCC ID:  
IC ID:  
Test Report Number:  
Issue Date:  
Customer:  
Model(s):

FCC Part 15 Certification & IC RSS  
O7P-362  
10147A-362  
13-0186  
July 29, 2013  
Inventek Systems  
ISM43362-M3G-L44-E and ISM43362-M3G-L44-U

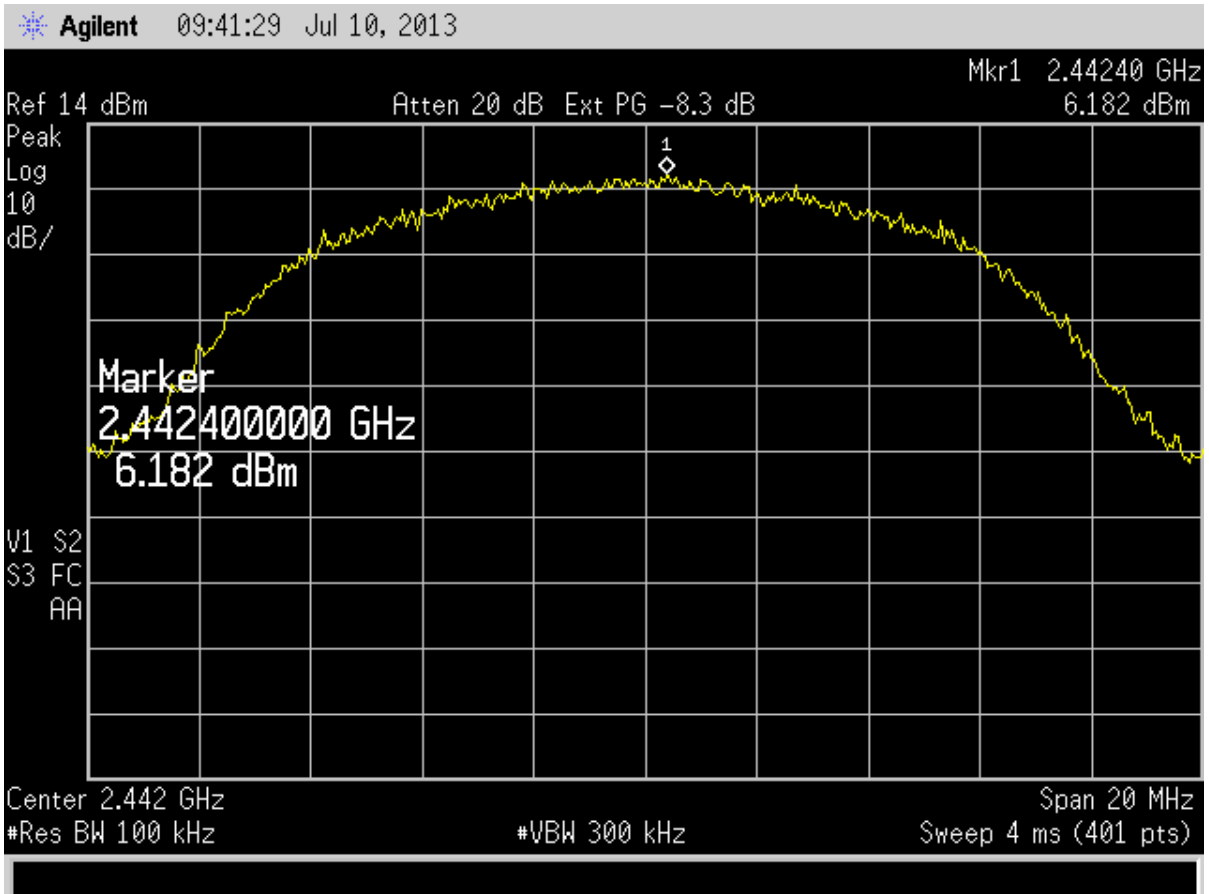
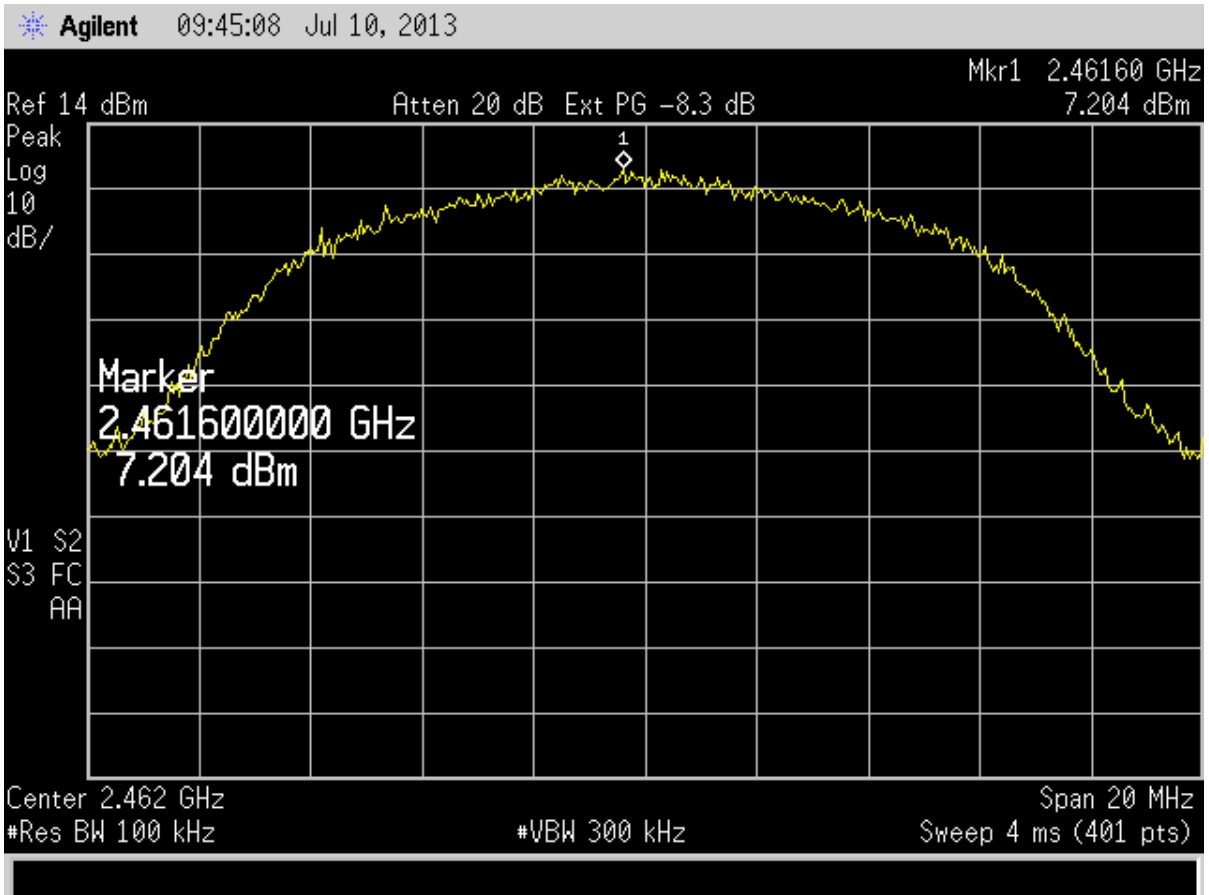

Figure 59. 802.11(b) Peak Power Spectral Density - Part 15.247 (e) - Mid Channel

US Tech Test Report:  
FCC ID:  
IC ID:  
Test Report Number:  
Issue Date:  
Customer:  
Model(s):

FCC Part 15 Certification & IC RSS  
O7P-362  
10147A-362  
13-0186  
July 29, 2013  
Inventek Systems  
ISM43362-M3G-L44-E and ISM43362-M3G-L44-U



**Figure 60. 802.11(b) Peak Power Spectral Density - Part 15.247 (e) - High Channel**

US Tech Test Report:  
FCC ID:  
IC ID:  
Test Report Number:  
Issue Date:  
Customer:  
Model(s):

FCC Part 15 Certification & IC RSS  
O7P-362  
10147A-362  
13-0186  
July 29, 2013  
Inventek Systems  
ISM43362-M3G-L44-E and ISM43362-M3G-L44-U

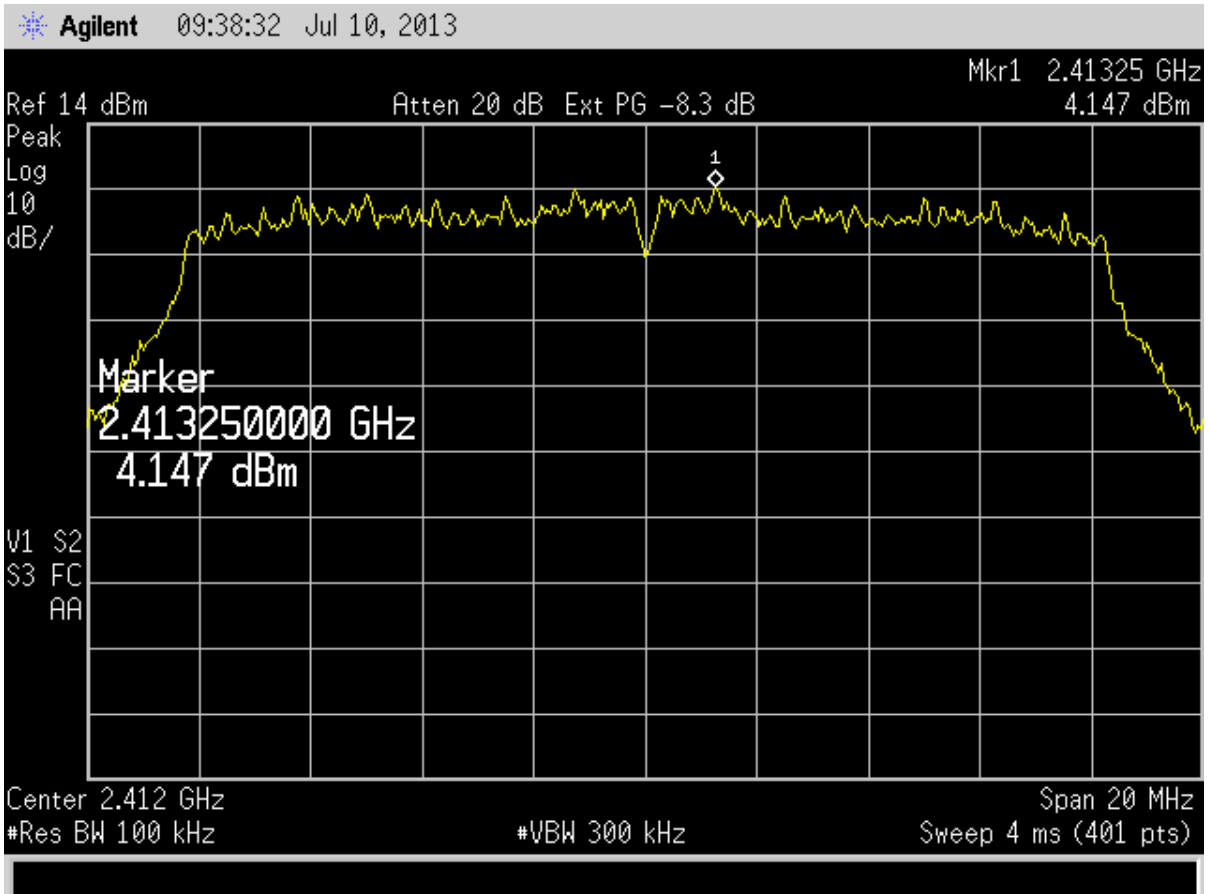
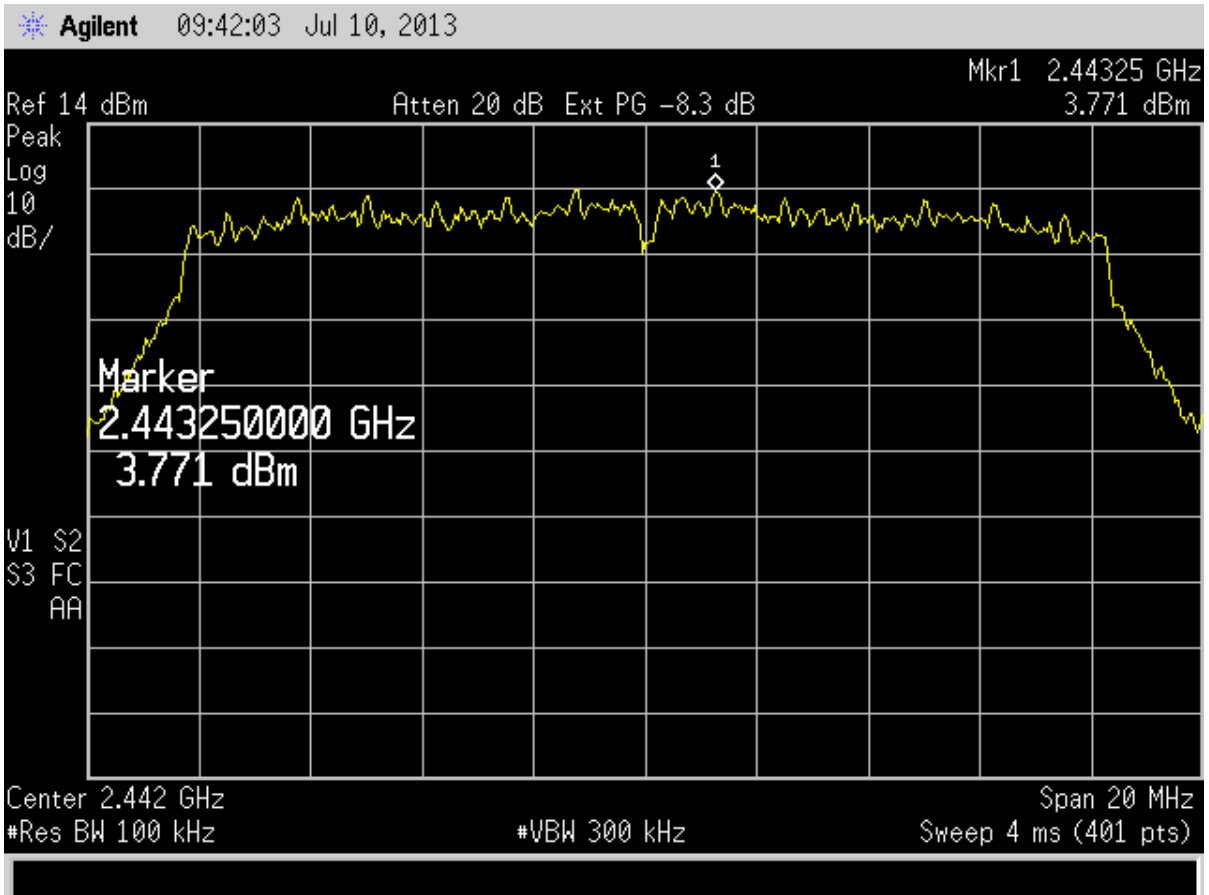

**Figure 61. 802.11(g) Peak Power Spectral Density - Part 15.247 (e) - Low Channel**



US Tech Test Report:  
FCC ID:  
IC ID:  
Test Report Number:  
Issue Date:  
Customer:  
Model(s):

FCC Part 15 Certification & IC RSS  
O7P-362  
10147A-362  
13-0186  
July 29, 2013  
Inventek Systems  
ISM43362-M3G-L44-E and ISM43362-M3G-L44-U



**Figure 62. 802.11(g) Peak Power Spectral Density - Part 15.247 (e) - Mid Channel**

US Tech Test Report:  
FCC ID:  
IC ID:  
Test Report Number:  
Issue Date:  
Customer:  
Model(s):

FCC Part 15 Certification & IC RSS  
O7P-362  
10147A-362  
13-0186  
July 29, 2013  
Inventek Systems  
ISM43362-M3G-L44-E and ISM43362-M3G-L44-U

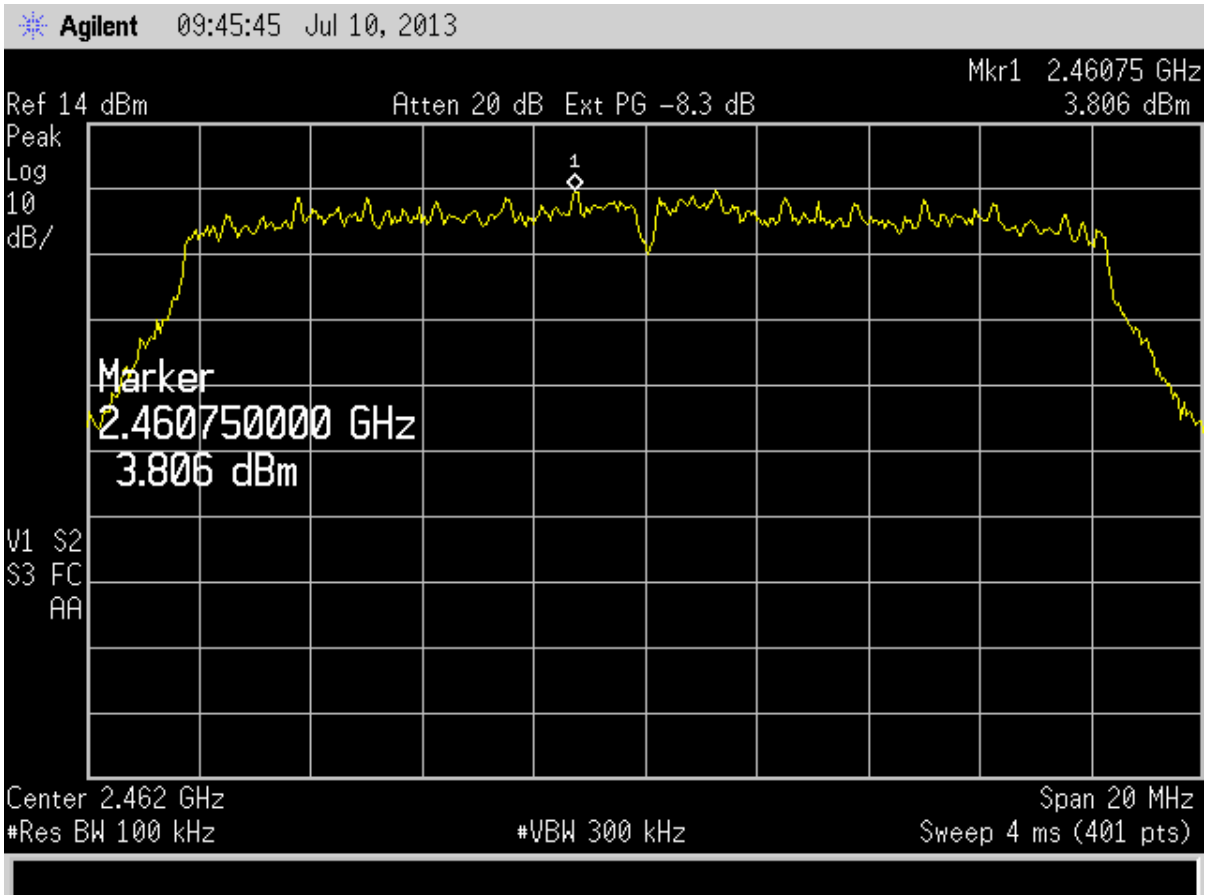

**Figure 63. 802.11(g) Peak Power Spectral Density - Part 15.247 (e) - High Channel**

US Tech Test Report:  
FCC ID:  
IC ID:  
Test Report Number:  
Issue Date:  
Customer:  
Model(s):

FCC Part 15 Certification & IC RSS  
O7P-362  
10147A-362  
13-0186  
July 29, 2013  
Inventek Systems  
ISM43362-M3G-L44-E and ISM43362-M3G-L44-U

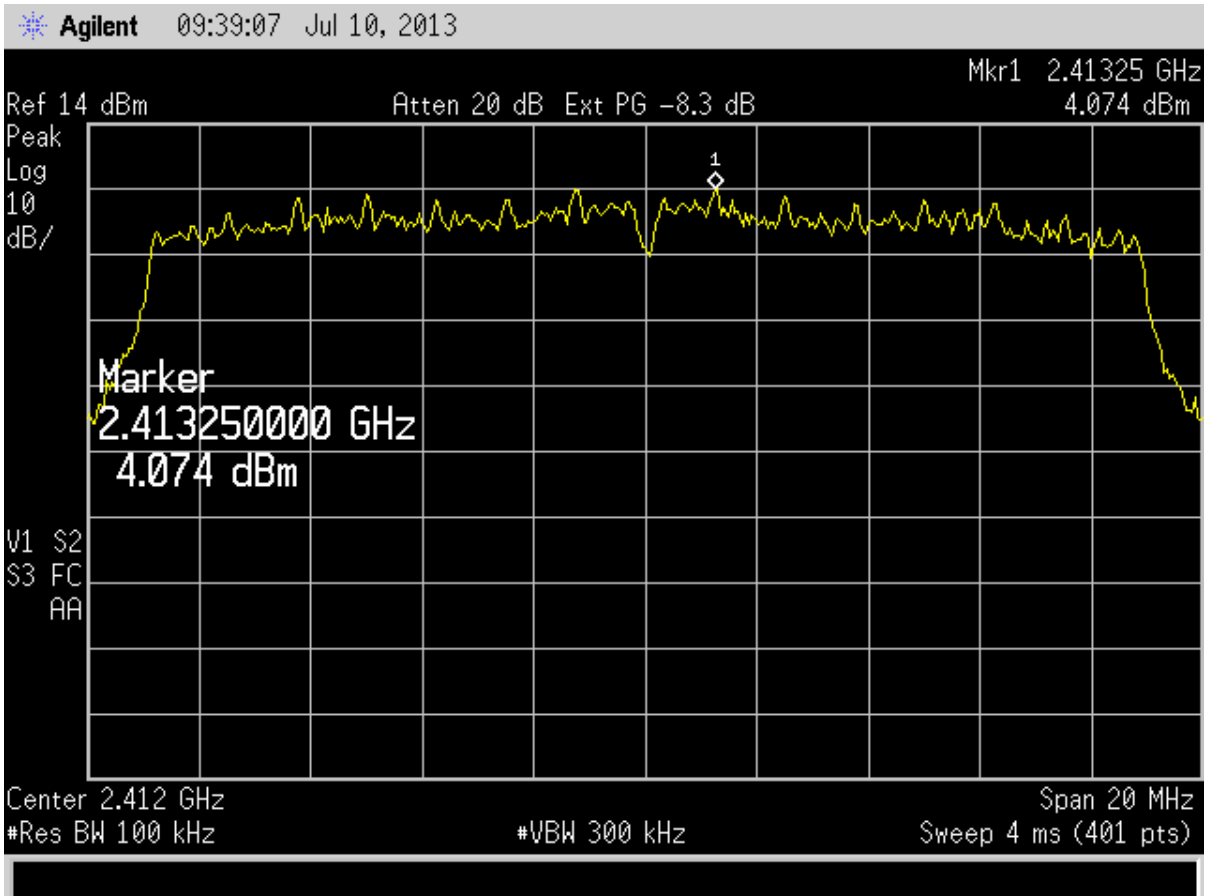

**Figure 64. 802.11(n) Peak Power Spectral Density - Part 15.247 (e) - Low Channel**

US Tech Test Report:  
FCC ID:  
IC ID:  
Test Report Number:  
Issue Date:  
Customer:  
Model(s):

FCC Part 15 Certification & IC RSS  
O7P-362  
10147A-362  
13-0186  
July 29, 2013  
Inventek Systems  
ISM43362-M3G-L44-E and ISM43362-M3G-L44-U

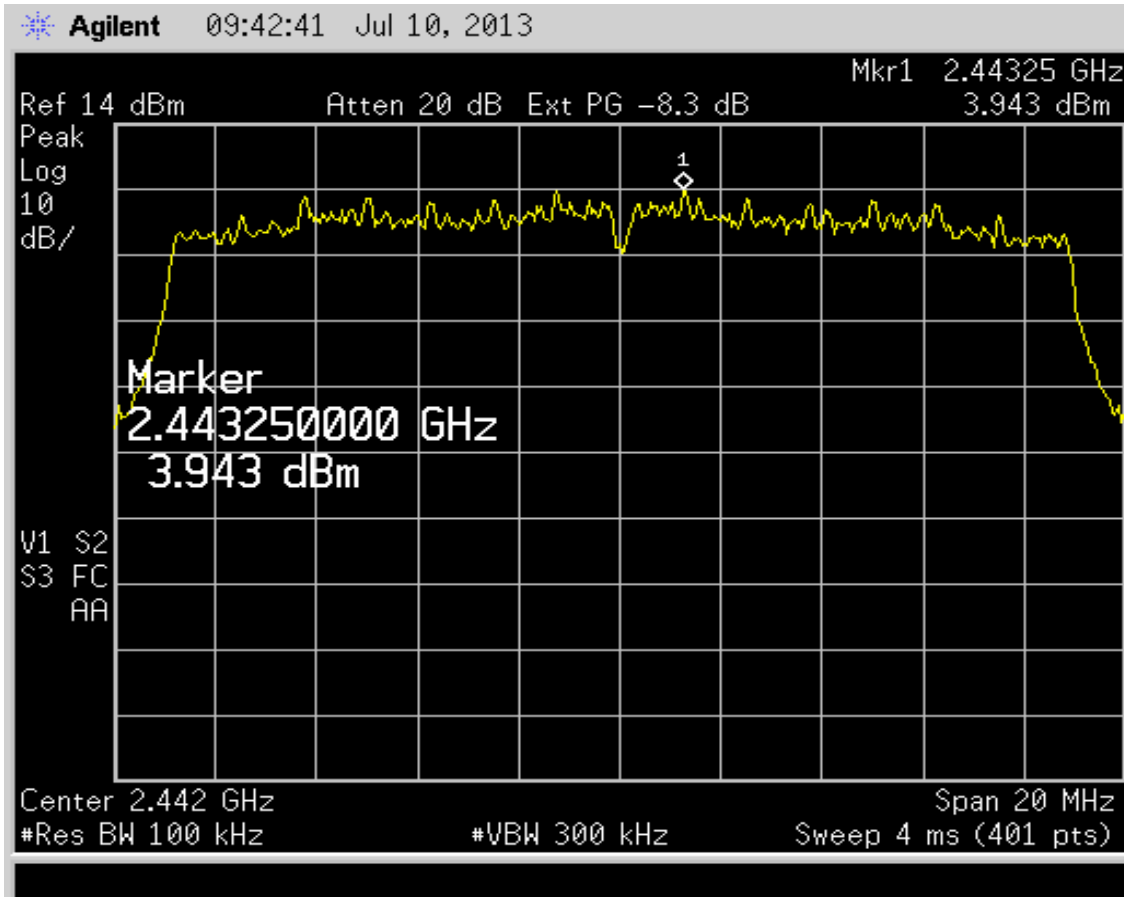
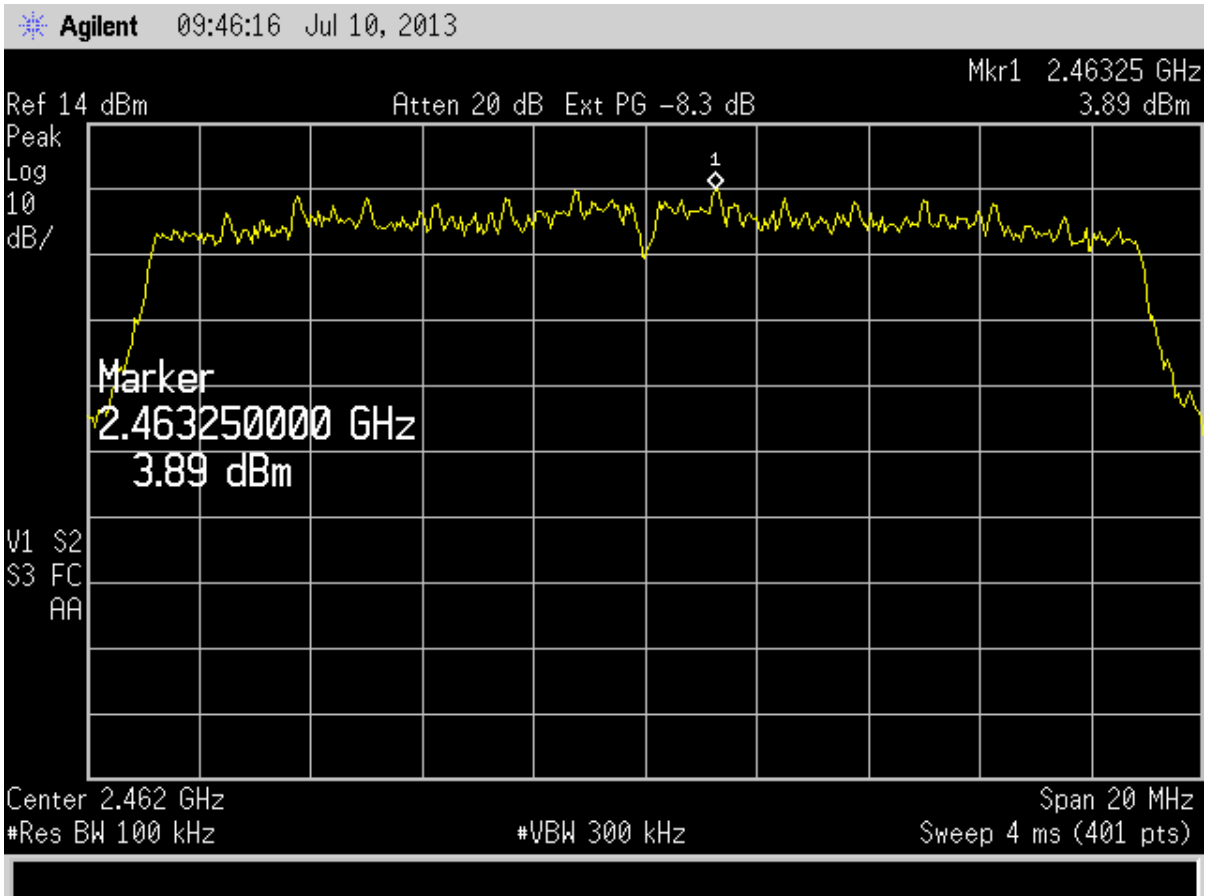

Figure 65. 802.11(n) Peak Power Spectral Density - Part 15.247 (e) - Mid Channel

US Tech Test Report:  
FCC ID:  
IC ID:  
Test Report Number:  
Issue Date:  
Customer:  
Model(s):

FCC Part 15 Certification & IC RSS  
O7P-362  
10147A-362  
13-0186  
July 29, 2013  
Inventek Systems  
ISM43362-M3G-L44-E and ISM43362-M3G-L44-U



**Figure 66. 802.11(n) Peak Power Spectral Density - Part 15.247 (e) - High Channel**

US Tech Test Report:  
FCC ID:  
IC ID:  
Test Report Number:  
Issue Date:  
Customer:  
Model(s):

FCC Part 15 Certification & IC RSS  
O7P-362  
10147A-362  
13-0186  
July 29, 2013  
Inventek Systems  
ISM43362-M3G-L44-E and ISM43362-M3G-L44-U

---

## **2.15 Band Edge Measurements-(CFR 15.247 (d))**

Band Edge measurements are made following the guidelines in FCC KDB Publication No. 558074 with the EUT initially operating on the Lowest Channel and then operating on the Highest Channel within its band of operation. Antenna port conducted measurements are performed to demonstrate compliance with the requirement of 15.247(d) that all emissions outside of the band edges be attenuated by at least 20 dB when compared to its highest in-band value (contained in a 100 kHz band). Because these frequencies occur above 1000 MHz they have both a peak and average requirement.

To capture the band edge, set the Spectrum Analyzer frequency span large enough (usually around 10 MHz) to capture the peak level of the emission operating on the channel closest to the band edge as well as any modulation products falling outside of the authorized band of operation. Conducted measurements are performed with RBW  $\geq 1\%$  of the frequency span. In all cases, the VBW is set  $\geq$  RBW. See the figures below for details.

The limit for the average value of radiated emissions in a Restricted Band is 54 dBuV/m. To compute the average values of the band edge emissions, the duty cycle correction factor of -13.65 dB is applied to the values in the Corrected Results column. After this correction the EUT is found to have met the restrictions placed on average radiated emissions in Restricted Bands. The worst-case measurement is computed below.

US Tech Test Report:  
FCC ID:  
IC ID:  
Test Report Number:  
Issue Date:  
Customer:  
Model(s):

FCC Part 15 Certification & IC RSS  
O7P-362  
10147A-362  
13-0186  
July 29, 2013  
Inventek Systems  
ISM43362-M3G-L44-E and ISM43362-M3G-L44-U

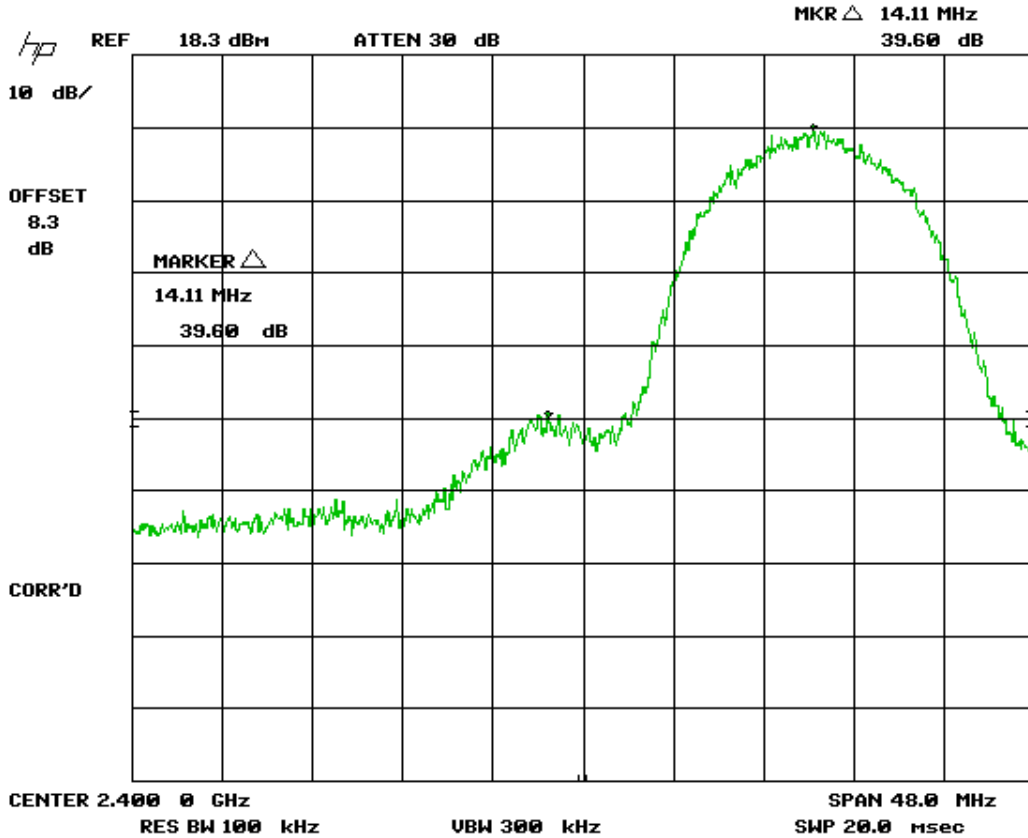
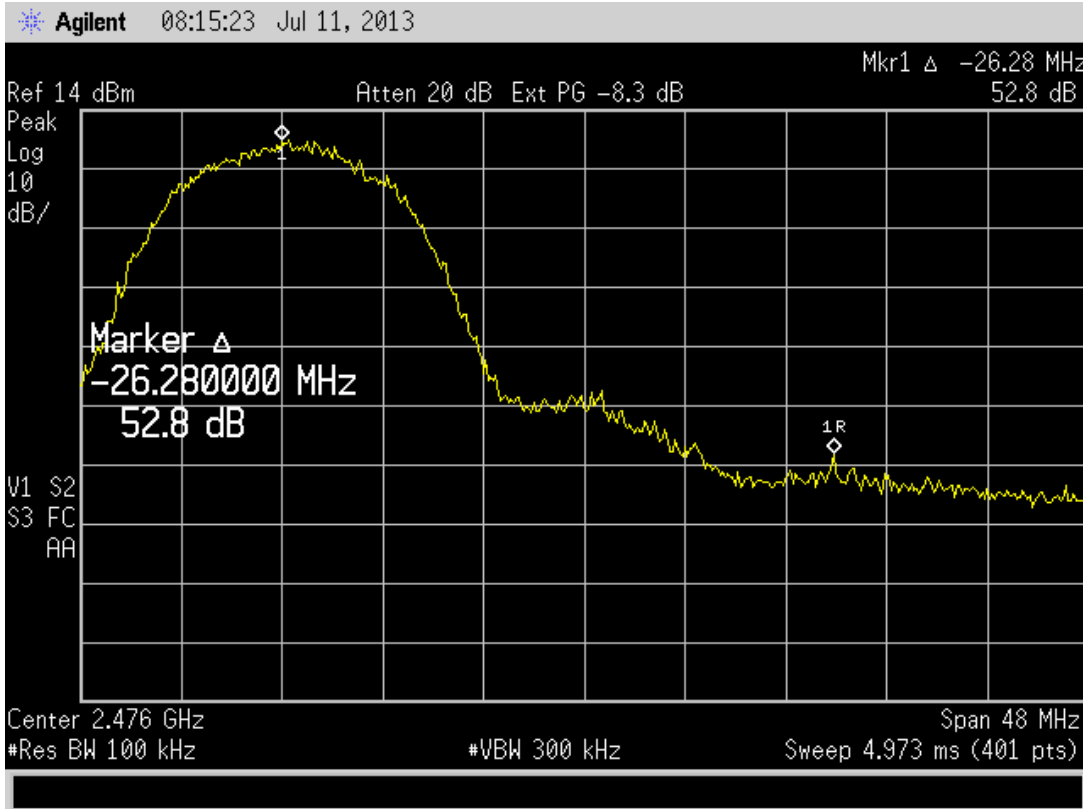

Figure 67. 802.11b – Band Edge Compliance – Low Channel Delta - Peak



**Figure 68. 802.11b – Band Edge Compliance – High Channel Delta - Peak**

**CALCULATION OF WORST-CASE AVERAGE UPPER BAND EDGE MEASUREMENT:**

Fundamental Peak Measurements	110.53 dBuV
Band Edge Delta	-52.8 dB
Duty Cycle	<u>-13.65</u> dB
Calculated Worst Case Restricted Band Emission, Peak	44.08 dBuV
Average Limit	54.00 dBuV
Calculated Worst Case Restricted Band Emission, Peak	<u>-44.08</u> dBuV
Margin below limit	9.92 dB

**Test Result** **Passed**



US Tech Test Report:  
FCC ID:  
IC ID:  
Test Report Number:  
Issue Date:  
Customer:  
Model(s):

FCC Part 15 Certification & IC RSS  
O7P-362  
10147A-362  
13-0186  
July 29, 2013  
Inventek Systems  
ISM43362-M3G-L44-E and ISM43362-M3G-L44-U

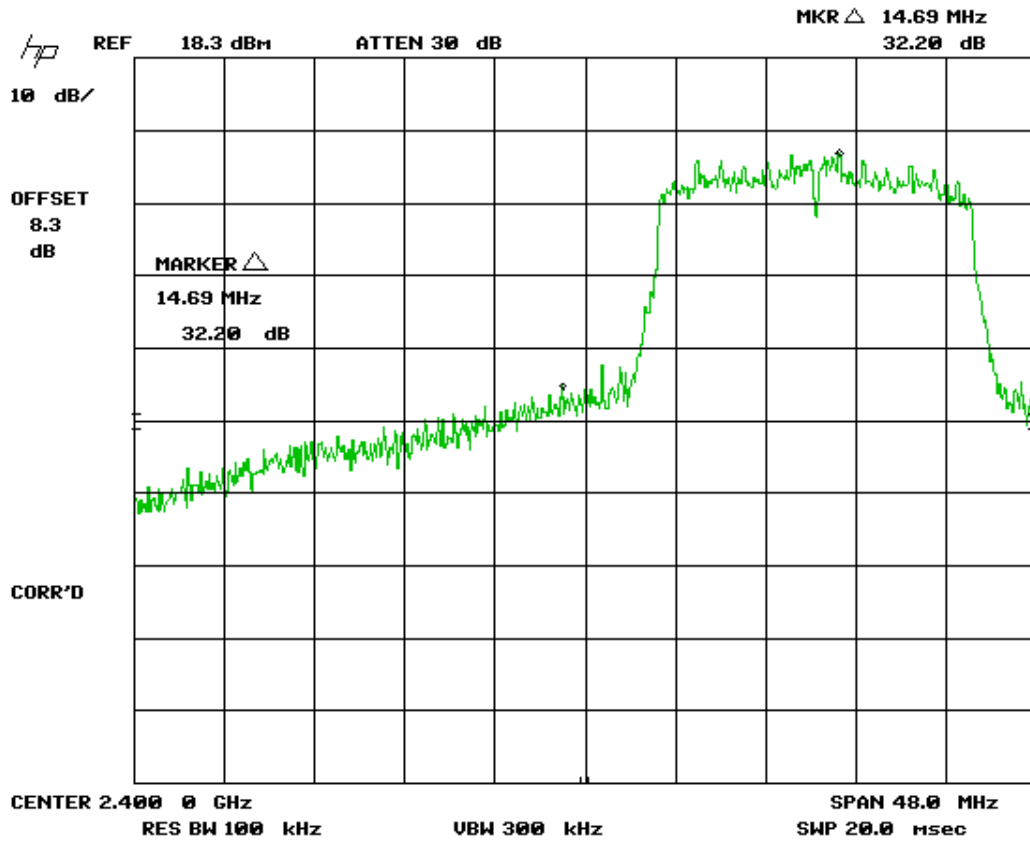
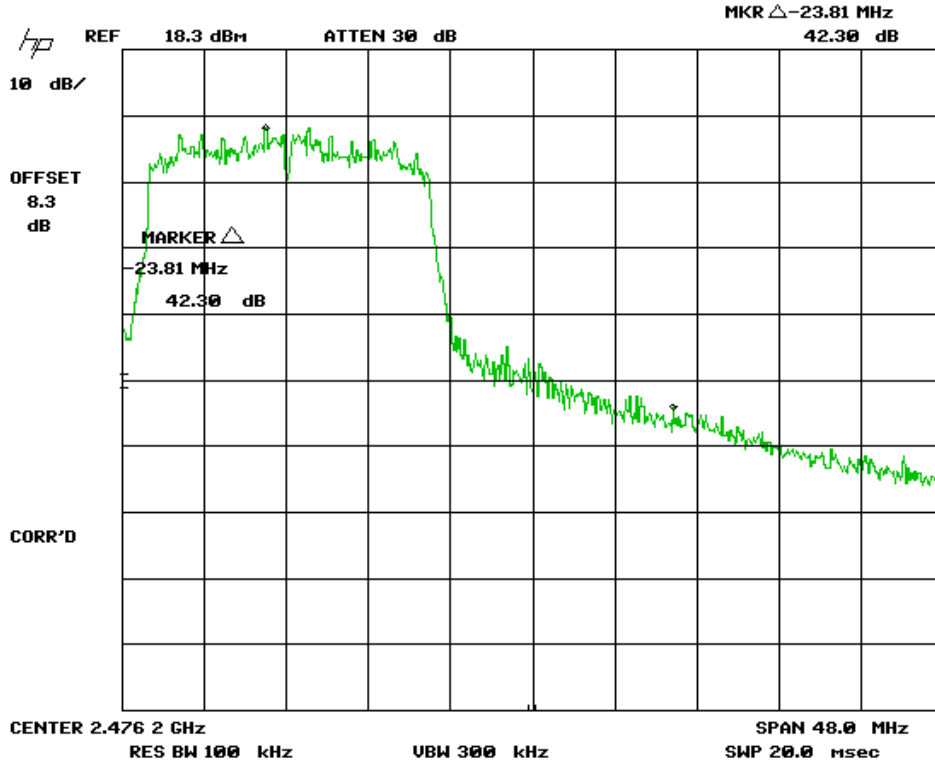

Figure 69. 802.11g – Band Edge Compliance – Low Channel Delta - Peak



**Figure 70. 802.11g – Band Edge Compliance – High Channel Delta - Peak**

Note: Conducted emissions shown here are worst case.

**CALCULATION OF WORST-CASE AVERAGE UPPER BAND EDGE MEASUREMENT:**

Fundamental Peak Measurements from Table 8	109.67 dBuV
Band Edge Delta	-42.3 dB
Duty Cycle	<u>-13.65</u> dB
Calculated Worst Case Restricted Band Emission, Peak	53.72 dBuV
Average Limit	54.00 dBuV
Calculated Worst Case Restricted Band Emission, Peak	<u>-53.72</u> dBuV
Margin below limit	0.28 dB

**Test Result**

**Passed**

US Tech Test Report:  
FCC ID:  
IC ID:  
Test Report Number:  
Issue Date:  
Customer:  
Model(s):

FCC Part 15 Certification & IC RSS  
O7P-362  
10147A-362  
13-0186  
July 29, 2013  
Inventek Systems  
ISM43362-M3G-L44-E and ISM43362-M3G-L44-U

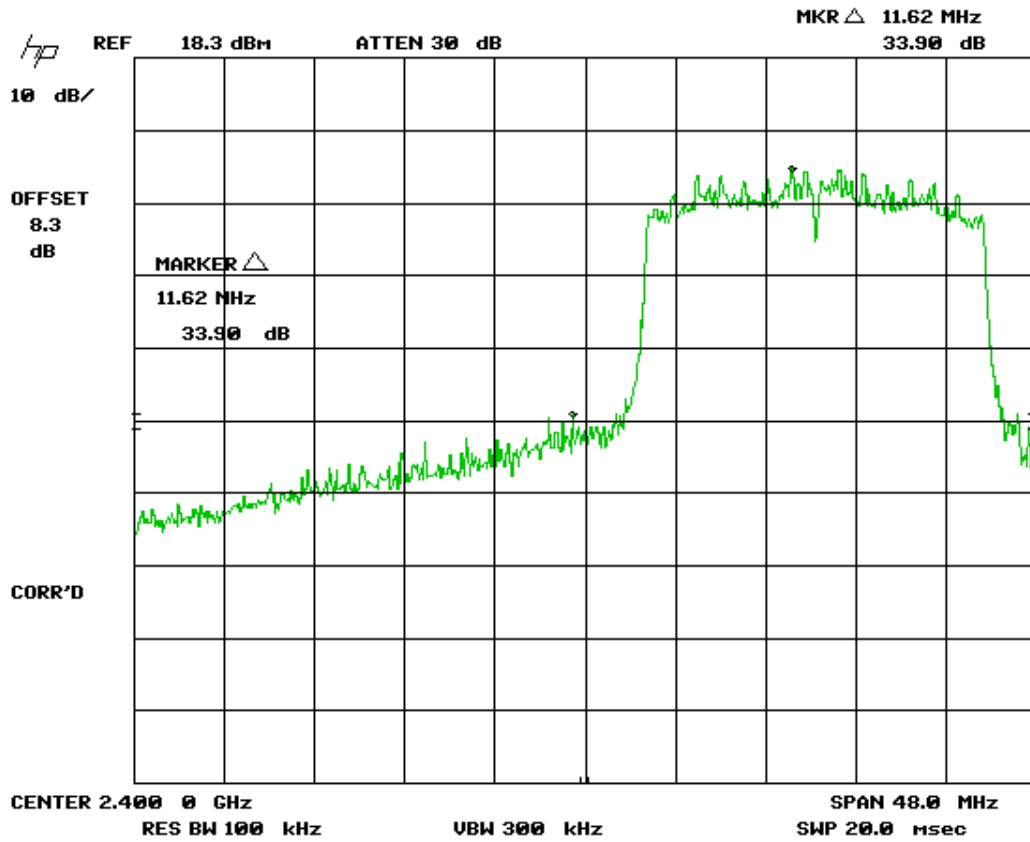
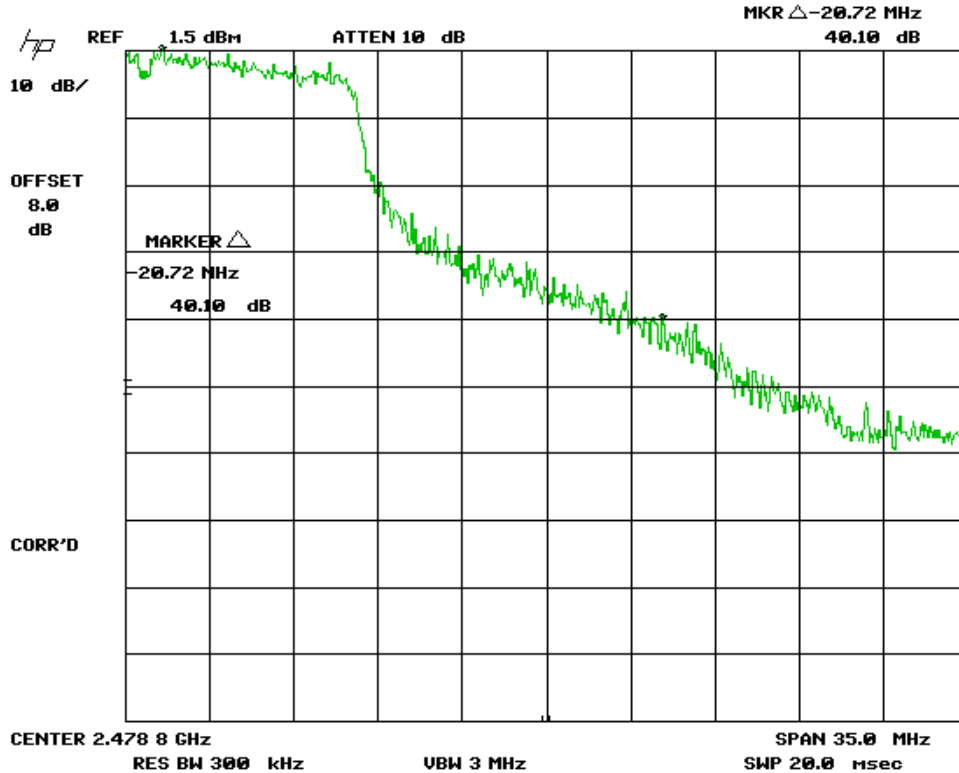

Figure 71. 802.11n – Band Edge Compliance – Low Channel Delta - Peak



**Figure 72. 802.11n – Band Edge Compliance – High Channel Delta - Peak**

Note: Conducted emissions shown here are worst case.

Fundamental Peak Measurements from Table 10	103.84 dBuV
Band Edge Delta	-40.1 dB
Duty Cycle	<u>-13.65</u> dB
Calculated Worst Case Restricted Band Emission, Peak	50.09 dBuV
Average Limit	54.00 dBuV
Calculated Worst Case Restricted Band Emission, Peak	<u>-50.09</u> dBuV
Margin below limit	3.91 dB

**Test Result**

**Passed**

US Tech Test Report:  
 FCC ID:  
 IC ID:  
 Test Report Number:  
 Issue Date:  
 Customer:  
 Model(s):

FCC Part 15 Certification & IC RSS  
 O7P-362  
 10147A-362  
 13-0186  
 July 29, 2013  
 Inventek Systems  
 ISM43362-M3G-L44-E and ISM43362-M3G-L44-U

**2.16 20 dB Bandwidth Measurement per CFR 15.247, 99% Occupied Bandwidth (IC RSS 210, A8.1)**

The EUT antenna port was connected to a spectrum analyzer having a 50 Ω input impedance. Measurements were performed similar to the method of FCC, KDB Publication No. 558074 for a bandwidth of 20 dB. The RBW was set to approximately 1/100 of the manufacturers claimed RBW and with the VBW ≥ RBW. The results of this test are given in Table 21 and Figures 73 through 81.

**Table 21. 802.11b 20 dB Bandwidth and 99% Occupied Bandwidth**

Frequency (MHz)	20 dB Bandwidth (MHz)	99% Occupied Bandwidth (MHz)
802.11b		
2412.0	14.24	14.24
2442.0	14.44	14.44
2462.0	14.98	14.98
802.11g		
2412.0	17.76	17.76
2442.0	17.46	17.46
2462.0	17.42	17.42
802.11n		
2412.0	18.40	18.40
2442.0	18.34	18.34
2462.0	18.40	18.40

Test Date: June 16, 2013

Tested By  
 Signature: 

Name: George Yang

US Tech Test Report:  
FCC ID:  
IC ID:  
Test Report Number:  
Issue Date:  
Customer:  
Model(s):

FCC Part 15 Certification & IC RSS  
O7P-362  
10147A-362  
13-0186  
July 29, 2013  
Inventek Systems  
ISM43362-M3G-L44-E and ISM43362-M3G-L44-U

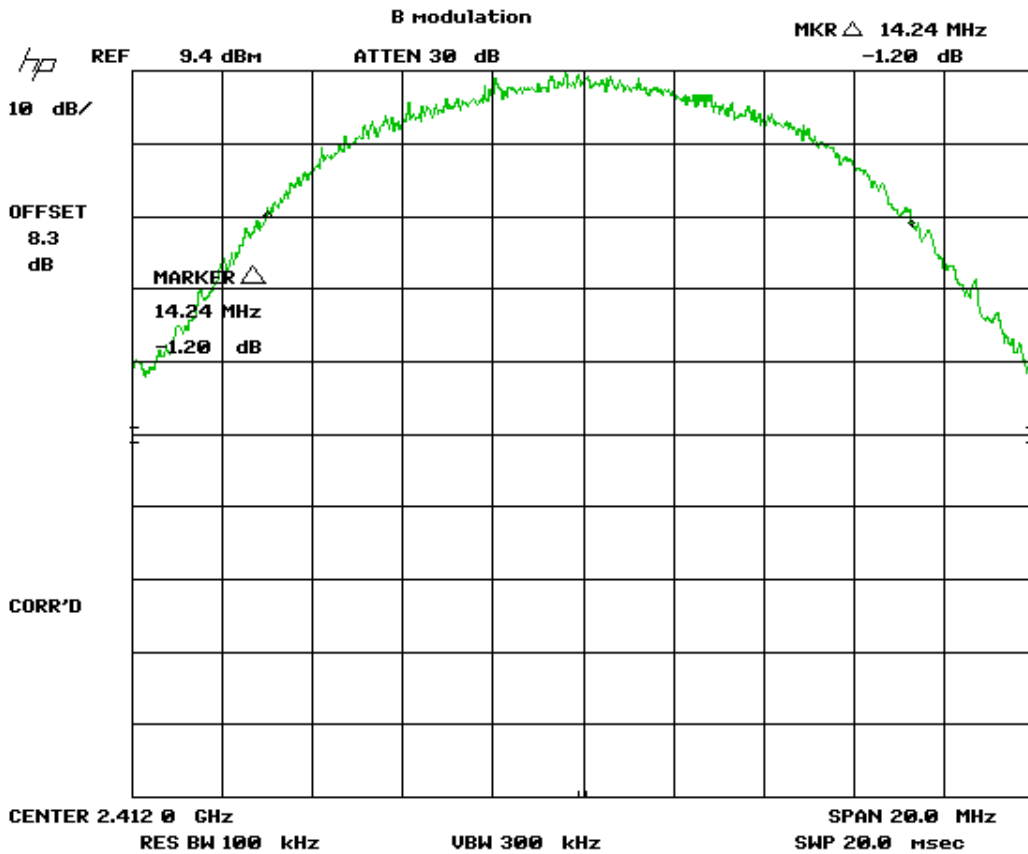

Figure 73. 802.11b - Low Channel 99% Bandwidth

US Tech Test Report:  
FCC ID:  
IC ID:  
Test Report Number:  
Issue Date:  
Customer:  
Model(s):

FCC Part 15 Certification & IC RSS  
O7P-362  
10147A-362  
13-0186  
July 29, 2013  
Inventek Systems  
ISM43362-M3G-L44-E and ISM43362-M3G-L44-U

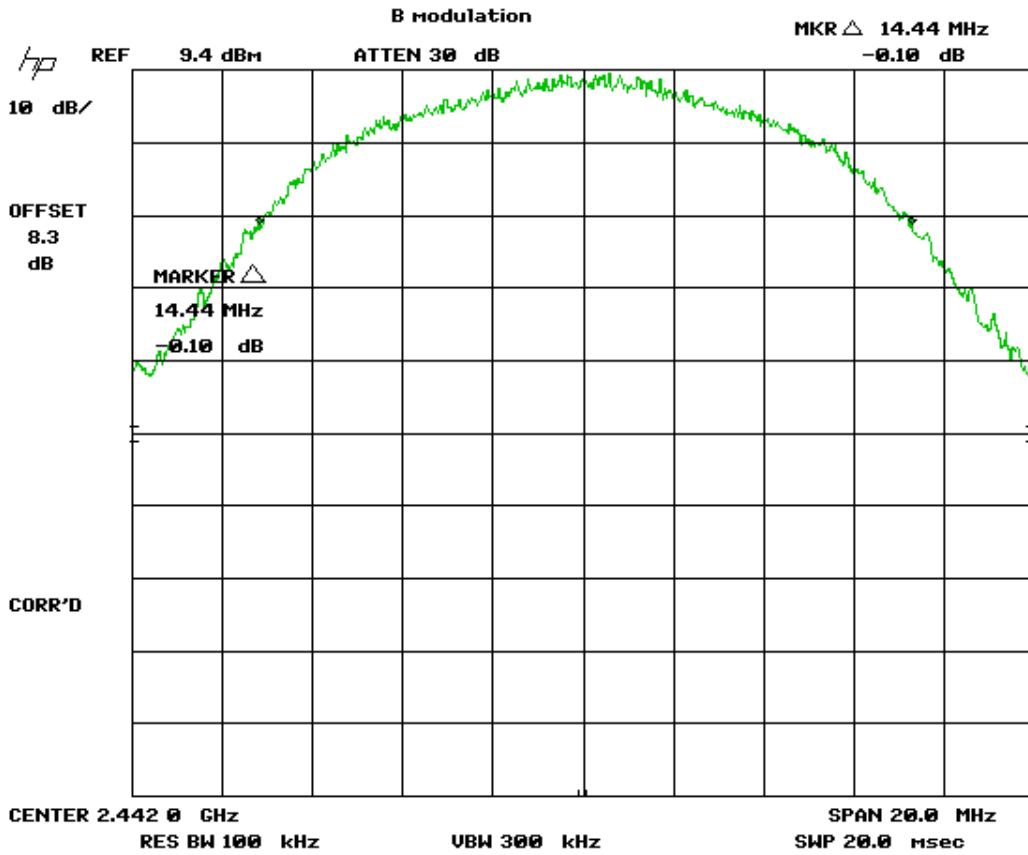

Figure 74. 802.11b - Mid Channel 99% Bandwidth

US Tech Test Report:  
FCC ID:  
IC ID:  
Test Report Number:  
Issue Date:  
Customer:  
Model(s):

FCC Part 15 Certification & IC RSS  
O7P-362  
10147A-362  
13-0186  
July 29, 2013  
Inventek Systems  
ISM43362-M3G-L44-E and ISM43362-M3G-L44-U

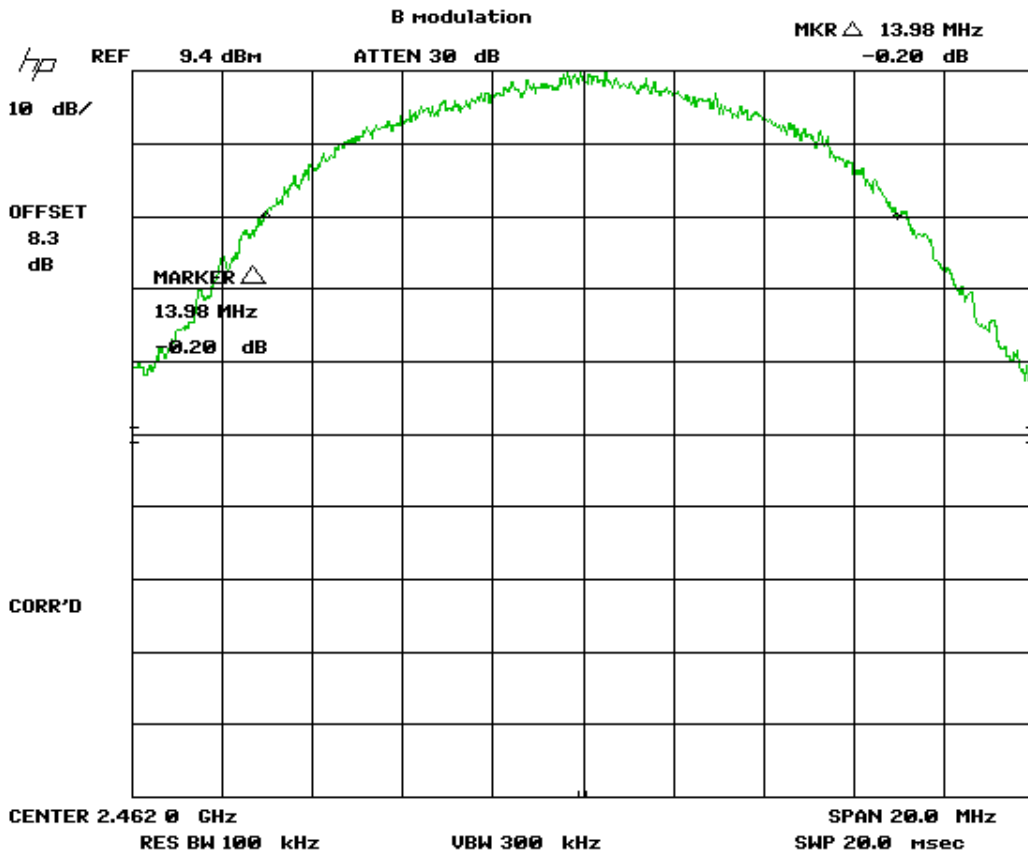

Figure 75. 802.11b - High Channel 99% Bandwidth



US Tech Test Report:  
FCC ID:  
IC ID:  
Test Report Number:  
Issue Date:  
Customer:  
Model(s):

FCC Part 15 Certification & IC RSS  
O7P-362  
10147A-362  
13-0186  
July 29, 2013  
Inventek Systems  
ISM43362-M3G-L44-E and ISM43362-M3G-L44-U

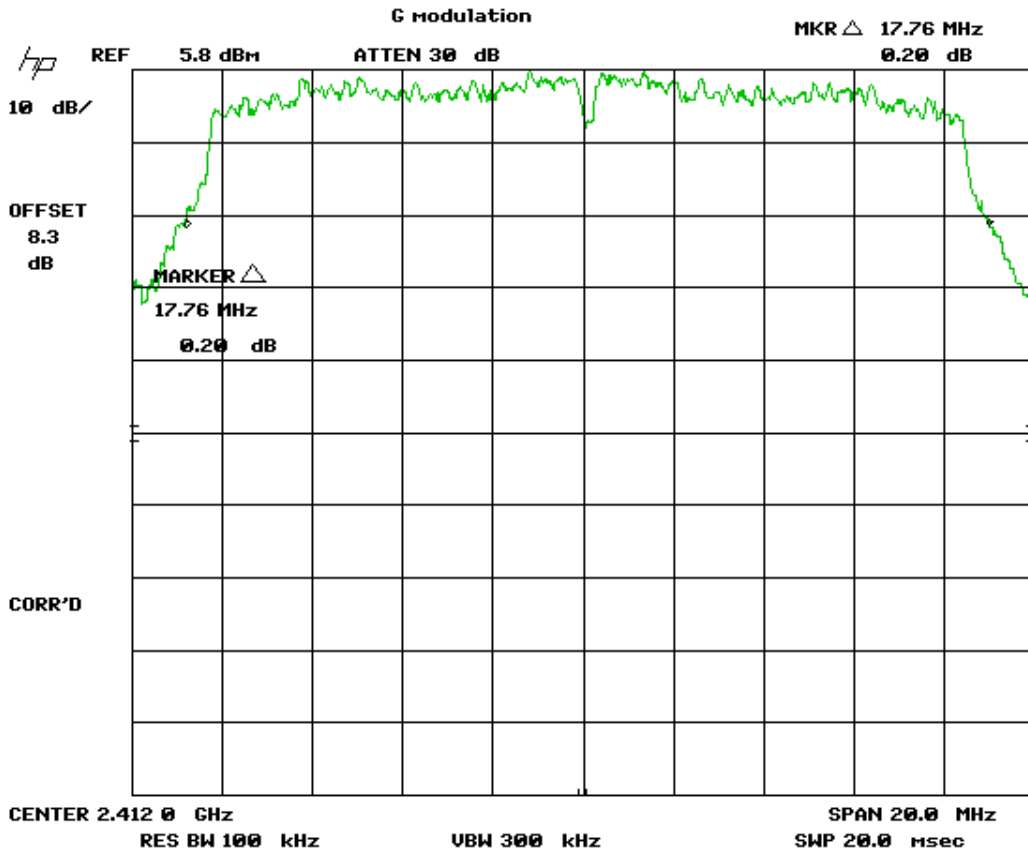

Figure 76. 802.11g - Low Channel 99% Bandwidth

US Tech Test Report:  
FCC ID:  
IC ID:  
Test Report Number:  
Issue Date:  
Customer:  
Model(s):

FCC Part 15 Certification & IC RSS  
O7P-362  
10147A-362  
13-0186  
July 29, 2013  
Inventek Systems  
ISM43362-M3G-L44-E and ISM43362-M3G-L44-U

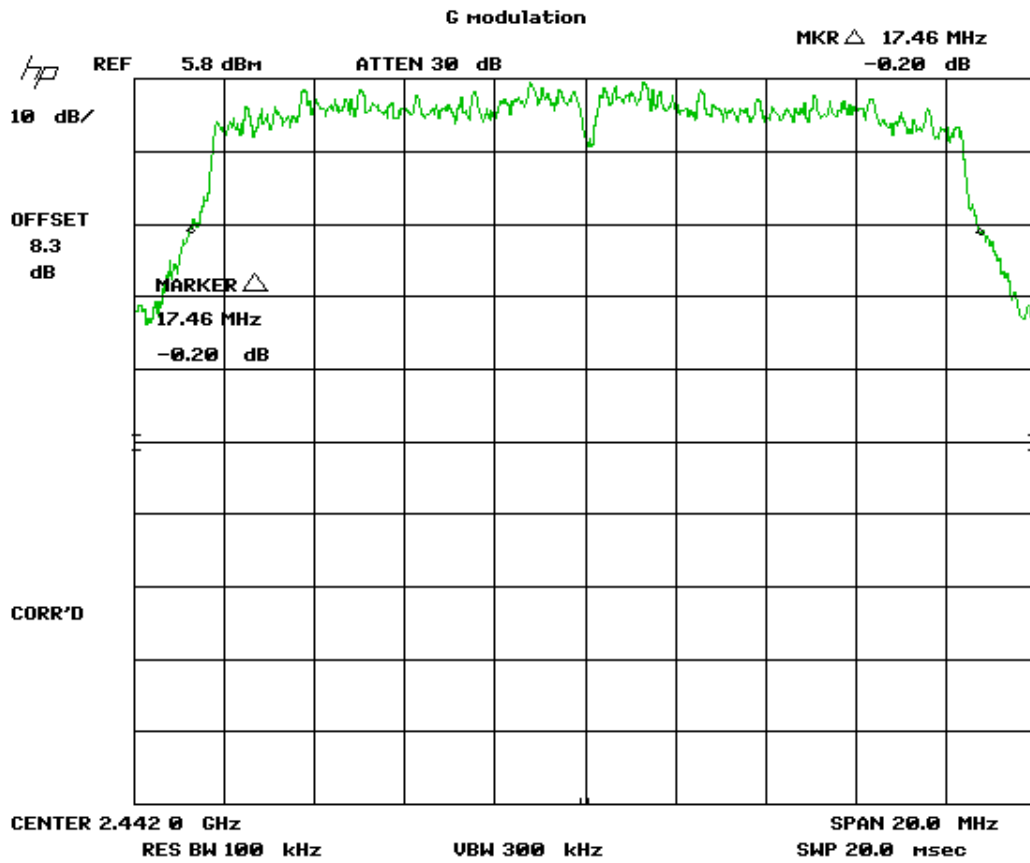

Figure 77. 802.11g - Mid Channel 99% Bandwidth

US Tech Test Report:  
FCC ID:  
IC ID:  
Test Report Number:  
Issue Date:  
Customer:  
Model(s):

FCC Part 15 Certification & IC RSS  
O7P-362  
10147A-362  
13-0186  
July 29, 2013  
Inventek Systems  
ISM43362-M3G-L44-E and ISM43362-M3G-L44-U

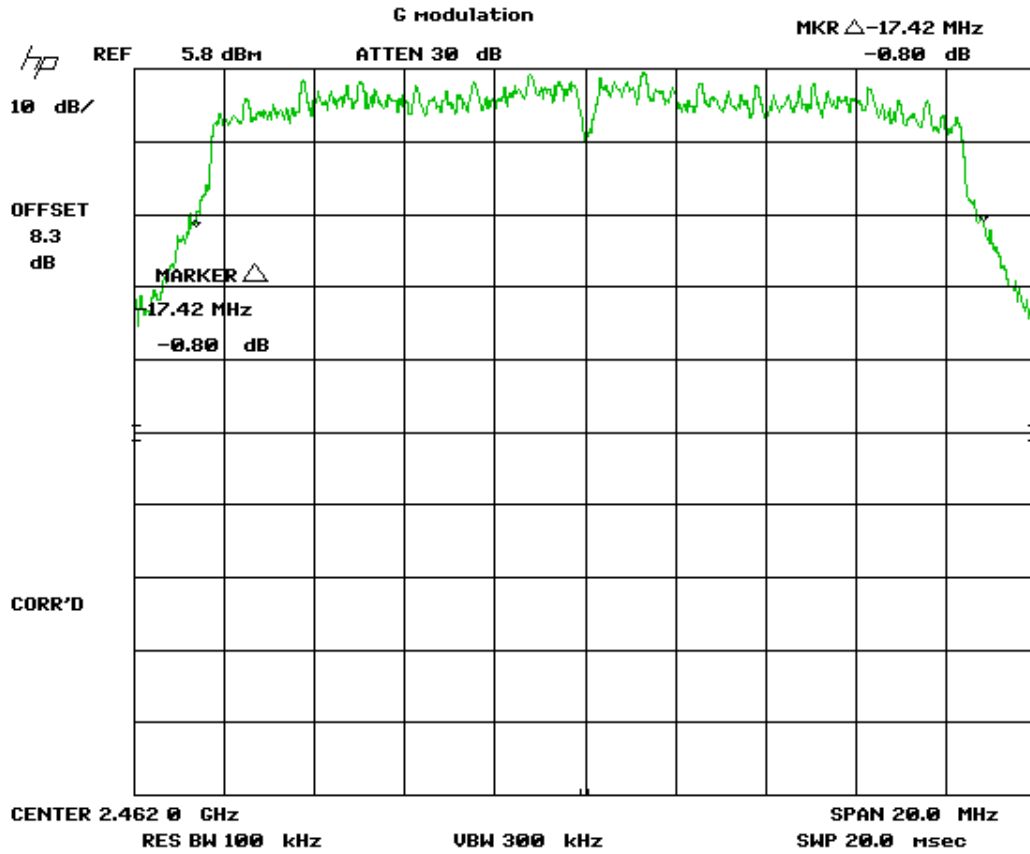

Figure 78. 802.11g - High Channel 99% Bandwidth

US Tech Test Report:  
FCC ID:  
IC ID:  
Test Report Number:  
Issue Date:  
Customer:  
Model(s):

FCC Part 15 Certification & IC RSS  
O7P-362  
10147A-362  
13-0186  
July 29, 2013  
Inventek Systems  
ISM43362-M3G-L44-E and ISM43362-M3G-L44-U

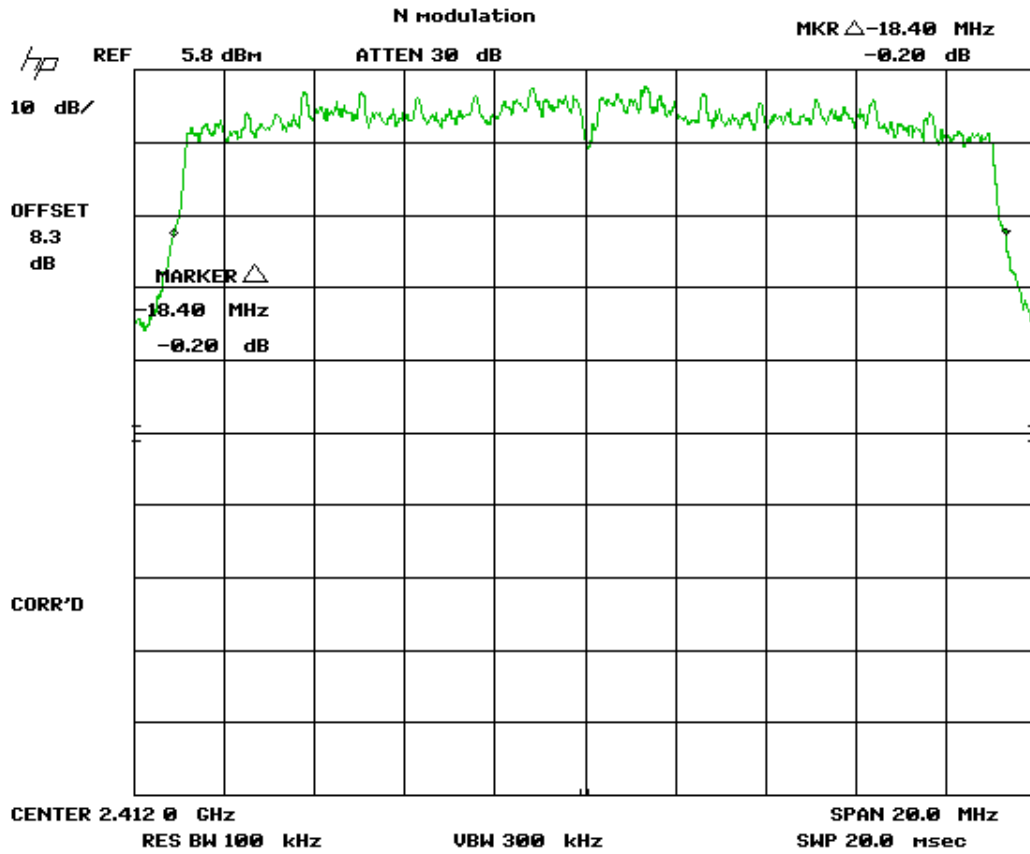

Figure 79. 802.11n - Low Channel 99% Bandwidth

US Tech Test Report:  
FCC ID:  
IC ID:  
Test Report Number:  
Issue Date:  
Customer:  
Model(s):

FCC Part 15 Certification & IC RSS  
O7P-362  
10147A-362  
13-0186  
July 29, 2013  
Inventek Systems  
ISM43362-M3G-L44-E and ISM43362-M3G-L44-U

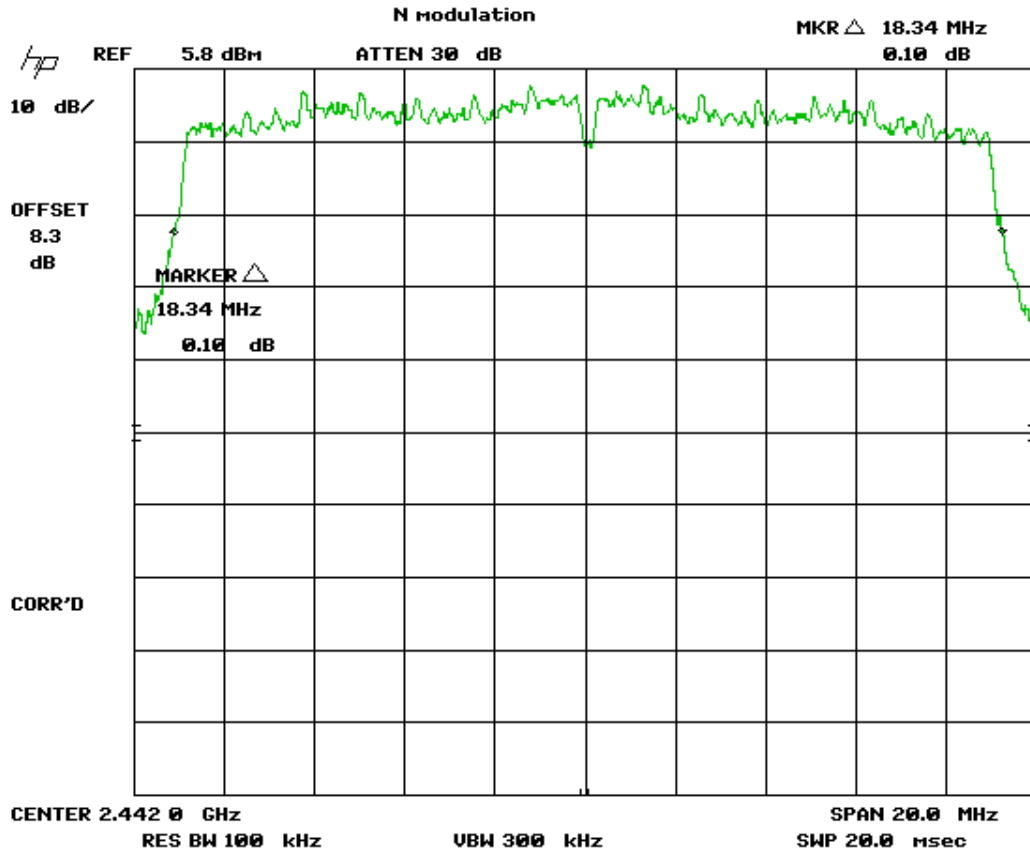

Figure 80. 802.11n - Mid Channel 99% Bandwidth

US Tech Test Report:  
FCC ID:  
IC ID:  
Test Report Number:  
Issue Date:  
Customer:  
Model(s):

FCC Part 15 Certification & IC RSS  
O7P-362  
10147A-362  
13-0186  
July 29, 2013  
Inventek Systems  
ISM43362-M3G-L44-E and ISM43362-M3G-L44-U

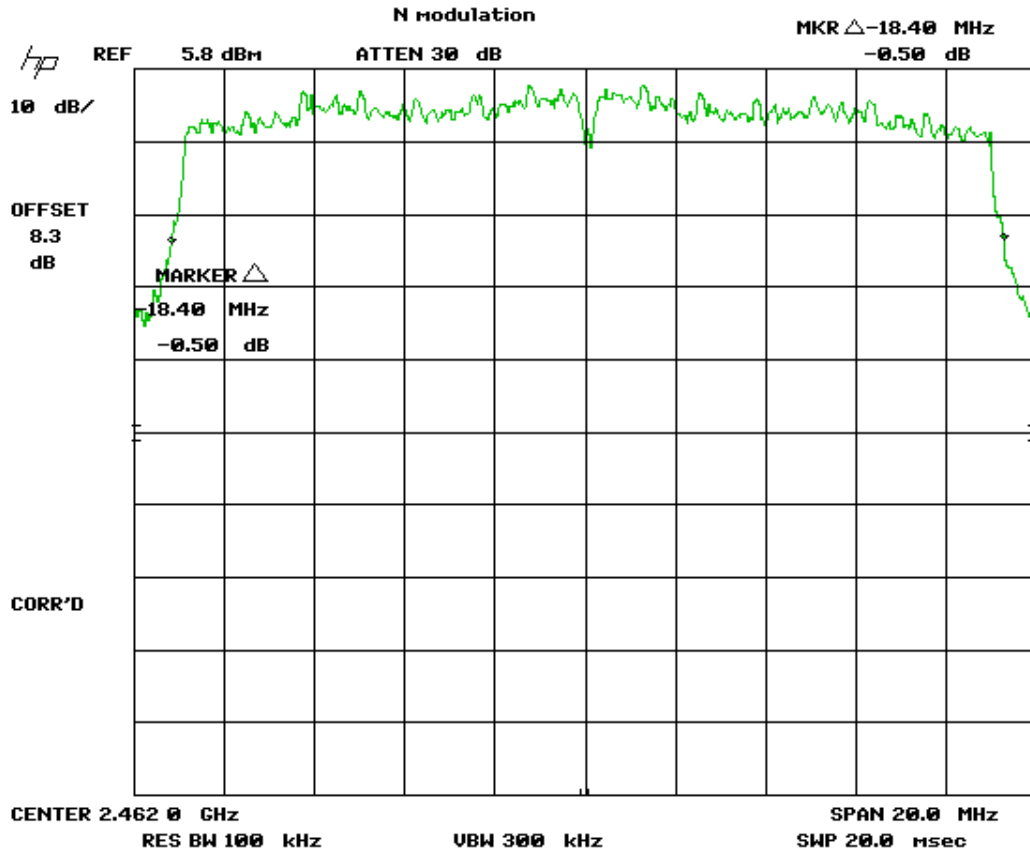

Figure 81. 802.11n - High Channel 99% Bandwidth

US Tech Test Report:  
FCC ID:  
IC ID:  
Test Report Number:  
Issue Date:  
Customer:  
Model(s):

FCC Part 15 Certification & IC RSS  
O7P-362  
10147A-362  
13-0186  
July 29, 2013  
Inventek Systems  
ISM43362-M3G-L44-E and ISM43362-M3G-L44-U

---

## **2.17 Unintentional Radiator Power Lines Conducted Emissions (CFR 15.107)**

The test data provided herein is to support the Verification requirement for the digital apparatus. The power line conducted voltage measurements for Receiver and Digital Devices have been carried out in accordance with CFR 15.107 and ANSI C63.4:2003, Paragraph 7, with a spectrum analyzer connected to an LISN and the EUT placed into an idle condition or a continuous mode of receive (non-transmitting). Please refer to the results as shown in Table 22 below.

The testing was done with the WiFi turned on to expedite the testing. This was considered the worst case scenario. The worst case emission was at 0.6194 MHz, 2.9 dB under the limit on the Neutral line. All other emissions are at least 3.8 dB above the limit. Those results are given in the following table.

US Tech Test Report:  
 FCC ID:  
 IC ID:  
 Test Report Number:  
 Issue Date:  
 Customer:  
 Model(s):

FCC Part 15 Certification & IC RSS  
 O7P-362  
 10147A-362  
 13-0186  
 July 29, 2013  
 Inventek Systems  
 ISM43362-M3G-L44-E and ISM43362-M3G-L44-U

**Table 22. Power Line Conducted Emissions Data, Class B Part 15.107**

Conducted Emissions Tested from 150 KHz to 30 MHz						
Tested By: SS	Specification Requirement: FCC Part 15.207 Class B		Project No.: 13-0186	Manufacturer: Inventek Systems Model: ISM43362-M3G-L44E, ISM43362-M3G-L44-U		
Frequency (MHz)	Test Data (dBuV)	LISN+CL-PA (dB)	Corrected Results (dBuV)	Avg Limits (dBuV)	Margin (dB)	Detector
<b>120 VAC, 60 Hz, Phase Line</b>						
0.1500	50.50	1.65	52.15	56.0	3.8	QP
0.6279	38.70	0.43	39.13	46.0	6.9	QP
3.8560	41.50	0.38	41.88	46.0	4.1	PK
9.3100	42.70	0.46	43.16	50.0	6.8	PK
11.7300	44.20	0.49	44.69	50.0	5.3	PK
20.1100	39.90	0.61	40.51	50.0	9.5	PK
<b>120 VAC, 60 Hz, Neutral Line</b>						
0.1565	49.20	1.50	50.70	55.6	5.0	QP
0.6194	43.00	0.42	43.42	*56.0	12.6	QP
0.6194	42.70	0.42	43.12	46.0	2.9	AVG
2.6600	37.00	0.36	37.36	46.0	8.6	QP
9.9100	42.20	0.46	42.66	50.0	7.3	PK
12.3400	44.90	0.49	45.39	50.0	4.6	PK
20.4300	42.00	0.61	42.61	50.0	7.4	PK

SAMPLE CALCULATIONS: At 20.43 MHz = 42.0 + (0.61) = 42.61 dBuV  
 (\*)= denotes quasi-peak measurement used.

Tested By  
 Signature: Sina Sobhaniyan

Name: Sina Sobhaniyan



US Tech Test Report:  
FCC ID:  
IC ID:  
Test Report Number:  
Issue Date:  
Customer:  
Model(s):

FCC Part 15 Certification & IC RSS  
O7P-362  
10147A-362  
13-0186  
July 29, 2013  
Inventek Systems  
ISM43362-M3G-L44-E and ISM43362-M3G-L44-U

## 2.18 Unintentional Radiator, Radiated Emissions (CFR 15.109, 15.209)

The test data provided herein supports the verification requirement for digital devices. Radiated emissions coming from the EUT in a non-transmit state per 15.109 and radiated emissions coming for the EUT in a transmitting state per 15.209 were evaluated from 9 kHz to 12.5 GHz as detailed in ANSI C63.4:2003, Paragraph 8 and per Part 15.33. The worst case is presented herein.

Measurements were made with the analyzer's resolution bandwidth set to:

RBW	Frequency Range
200 Hz	9kHz to 150 kHz
9 kHz	150 kHz to 30 MHz
120 kHz	30 MHz to 1 GHz
1 MHz	Above 1 GHz

For EUT with oscillator circuits that generate a frequency below 30 MHz, measurements were made with the analyzer's resolution bandwidth set to 9 KHz and a calibrated Loop Antenna was used per the requirements of ANSI C63.4:2003. Measurements were made with the analyzer's resolution bandwidth set to 120 kHz in the band 30 MHz to 1 GHz and 1 MHz for measurements made above 1 GHz. The video bandwidth was set to three times the resolution bandwidth for all testing.

The test data collected was maximized for magnitude by rotating the turntable through 360 degrees and raising and lowering the receiving antenna between 1 to 4 meters in height as a part of the measurement procedure per ANSI C63.4:2003, please see the standard for details regarding this test process.

US Tech Test Report:  
 FCC ID:  
 IC ID:  
 Test Report Number:  
 Issue Date:  
 Customer:  
 Model(s):

FCC Part 15 Certification & IC RSS  
 O7P-362  
 10147A-362  
 13-0186  
 July 29, 2013  
 Inventek Systems  
 ISM43362-M3G-L44-E and ISM43362-M3G-L44-U

**Table 23. Unintentional Radiator, Radiated Emissions.**

Unintentional Radiator, Radiated Emissions							
Test By: SS	Test: FCC Part 15.109, 15.209			Client: Inventek Systems			
	Project: 13-0186 Class: B			Model: ISM43362-M3G-L44E, ISM43362-M3G-L44-U			
Frequency (MHz)	Test Data (dBuV)	AF+CL-PA (dB)	Results (dBuV/m)	Limits (dBuV/m)	Distance /Polarity	Margin (dB)	DETECTOR PK / QP
Tested from 9 kHz to 12.5 GHz							
144.00	42.7	-12.83	29.87	43.5	3m./HORT	13.6	PK
144.02	51.1	-12.53	38.57	43.5	3m./VERT	4.9	PK
168.01	48.7	-11.206	37.494	43.5	3m./VERT	6.0	PK
168.02	45.1	-12.106	32.994	43.5	3m./HORT	10.5	PK
216.00	49.7	-12.6889	37.0111	46	3m./HORT	9.0	PK
528.03	36.3	-4.79	31.51	46	3m./HORT	14.5	PK
1800.52	46.73	-10.3767	36.3533	54	3m./VERT	17.6	PK
2181.45	48.4	-9.72099	38.67901	54	3m./VERT	15.3	PK
2343.10	47.42	-9.18035	38.23965	54	3m./HORT	15.8	PK
3617.98	56.84	-4.85149	51.98851	54	3m./VERT	2.0	PK
3618.05	53.55	-5.05449	48.49551	54	3m./HORT	5.5	PK
4173.90	45.34	-4.51495	40.82505	54	3m./VERT	13.2	PK

No other emissions detected within 20 dB of the FCC Part 15.109 & 15.209 limits  
 AF is antenna factor. CL is cable loss. PA is preamplifier gain  
 SAMPLE CALCULATION: At 216.00 MHz: = 49.7 + (-12.6889) = 37.01 dBuV/m @ 3m  
 Margin = (46 - 37.01) = 9.0 dB

Test Date: June 14, 2013

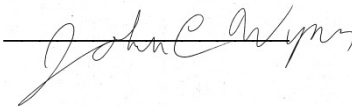
Tested By Signature: 

Name: John Wynn