

2 YEARS LIMITED WARRANTY  
PORTUGAL AND SPAIN CUSTOMERS: 3 YEARS LIMITED WARRANTY  
OR AS REQUIRED BY LOCAL LAWS

We pride ourselves on the quality of our products. For complete warranty details and a list of our Worldwide offices, please visit [www.Targus.Com](http://www.Targus.Com). Targus product warranty does not cover any device or product that is not manufactured by Targus (including, but not limited to, laptops, smartphones, devices, or any other product that may be used in connection with the Targus product).

Targus is a registered trademark of Targus International LLC in the U.S. and in certain other countries. All logos and registered trademarks are the property of their respective owners. ©2022 Targus, 1211 North Miller Street, Anaheim, CA 92806 USA. All rights reserved.

GARANTIE LIMITÉE DE 2 ANS  
CLIENTS DU PORTUGAL ET DE L'ESPAGNE : GARANTIE LIMITÉE 3 ANS  
OU COMME EXIGÉ PAR LES LOIS LOCALES

La qualité de nos produits fait notre fierté. Pour plus de renseignements sur la garantie complète et une liste de nos bureaux à travers le monde, veuillez consulter [www.targus.com](http://www.targus.com). La garantie sur les produits Targus ne couvre pas les appareils ni les produits qui ne sont pas fabriqués par Targus (y compris, sans toutefois y être limité, les ordinateurs portables, les téléphones cellulaires, et autres dispositifs et produits qui peuvent être utilisés en conjonction avec un produit Targus).

Targus est une marque déposée de Targus International LLC, aux États-Unis et dans certains autres pays. Tous les logos et marques déposées sont la propriété exclusive de leur propriétaire. ©2022 Targus, 1211 North Miller Street, Anaheim, CA 92806 USA. Tous droits réservés.

GARANTIA LIMITADA DE PARA 2 AÑOS  
PORTUGAL AND SPAIN CLIENTES: 3 AÑOS DE GARANTIA LIMITADA  
O SEGÚN LO EXIJA LA LEGISLACION LOCAL

Nos enorgullecamos de la calidad de nuestros productos. Para obtener detalles completos de la garantía y una lista de nuestras oficinas en todo el mundo, visite [www.targus.com](http://www.targus.com). La garantía del producto de Targus no cubre ningún dispositivo o producto que no sea fabricado por Targus (incluidos, entre otros, ordenadores portátiles, teléfonos inteligentes, dispositivos o cualquier otro producto que pueda usarse en conexión con el producto de Targus). Targus y EcoSmart son marcas registradas de Targus International LLC en los EE. UU. y en otros países.

Targus es una marca registrada de Targus International LLC en los Estados Unidos y en otros países. Bluetooth es una marca comercial registrada de Bluetooth SIG, Inc. Todos los logotipos y marcas registradas son propiedad de sus respectivos propietarios. ©2022 Targus, 1211 North Miller Street, Anaheim, CA 92806, EE. UU. Reservados todos los derechos.

PORTUGAL AND SPAIN CLIENTES:  
3 ANOS DE GARANTIA LIMITADA. OUTRA REGIÃO  
2 ANOS DE GARANTIA LIMITADA - ou segundo o exija a legislação local



FCC ID: OXM000140  
IC: 27357-00009



# Targus®

## BLUETOOTH® WIRELESS STEREO HEADSET CASQUE STÉRÉO SANS FIL BLUETOOTH® AURICULARES ESTÉRÉO INALÁMBRICOS BLUETOOTH®

# User Guide Guide de l'utilisateur Guía del usuario

Product Name: Wireless Stereo Headset  
Model: AEH104  
SKU: AEH104TT

## Targus Wireless Stereo Headset

### GB - Introduction

Congratulations on your purchase of the Targus Wireless Stereo Headset.

### Contents

- Targus AEH104 Wireless Stereo Headset
- USB-C Charging Cable
- Boom Mic
- 3.5mm Audio Cable
- User Guide

### Product Specifications

- Bluetooth version: Bluetooth V5.0
- Bluetooth Profile: A2DPv1.3.1; AVRCPv1.6; HFPv1.7; HSPv1.2
- Working Frequency: 2.402GHz-2.480GHz
- Speaker sensitivity : 95±3dB
- Frequency Response: 20-20kHz
- Receiving sensitivity: >-89dBm
- Battery type: Lithium polymer
- Mic type and sensitivity: Condenser Microphone -42±3dB
- Battery capacity: 410mAh
- Charging voltage: DC 5V 500mA
- Bluetooth working range: Up to 10m
- Talk time: Up to 18 hours
- Charging time: Approximately 2 hours
- Standby time: Approximately 205 hours

### System requirements

- Windows®
- macOS®
- iOS®
- Android™



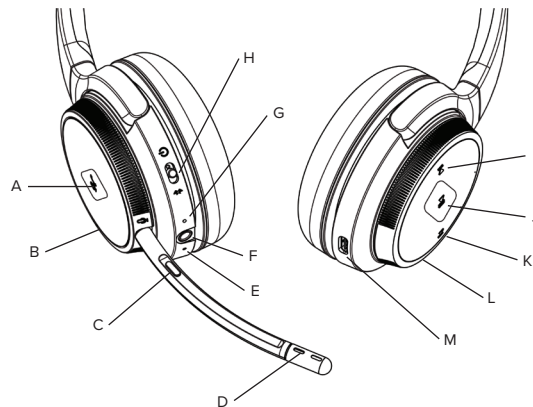







## Targus Wireless Stereo Headset













- A. Answer/End call/Mute/Unmute
- B. Rotate Boom Mic
- C. Boom Mic Mute Switch
- D. Boom microphone
- E. Internal Mic
- F. Audio Input
- G. Bluetooth LED

- H. On/Off/Pairing
- I. Previous track
- J. Play/Pause
- K. Next track
- L. Rotate to adjust volume
- M. USB-C charging port

## Targus Wireless Stereo Headset

Function	Operation
Power on	Slide the switch to the CENTER position
Power off	Slide the switch to the  position
Pairing	Power on the headset: 1. If the headset has not been connected to the last device or reset, it will automatically enter the pairing mode. Search Targus AEH104 in your device's Bluetooth device name list and click connection. 2. If the headset has been connected to the last device, it will automatically reconnect.
Battery status	After power on, press and hold  once to hear the current battery status.
Call mute function	Built-in microphone: Press and hold  for 2 seconds External microphone: Press and hold  for 2 seconds
Connect the second device	Slide the switch to the  position again and hold 6 seconds to enter pairing mode, then search for the Targus AEH104 on your device and click connect.
Answer the call	1. Press  once on the bluetooth headset 2. Press  once on the boom mic
End the call	1. Press  once on the bluetooth headset 2. Press  once on the boom mic
Refuse the call	Press  twice

## Targus Wireless Stereo Headset

Switch between current call and answer another call	Press and hold  for 2 seconds when receiving another call
Keep the current call and answer another call	Press and hold  for 2 seconds when receiving another call
Reject a call when it is answered	Press  twice
Volume +	Turn the volume knob clockwise 
Volume -	Turn volume knob counterclockwise 
Last song	Press  once
Next song	Press  once
Play / pause	Press  once
Reset the headset	Press and hold  /  for 5 seconds at the same time when headset power on, the pink light will be on for 2 seconds, and the headset will enter the pairing mode.
SIRI	Press  twice
Charge high temperature protection	When the temperature of the headset and internal battery reaches 45±3°C, the charging of the headset internal battery stops automatically.
Charge low temperature protection.	When the temperature of the headset and internal battery reaches 0±3°C, the earphone automatically stops charging the internal battery.

### Targus Wireless Stereo Headset

#### How to wear:

1. Insert the detachable Boom Microphone 2.5mm port located on the headset.

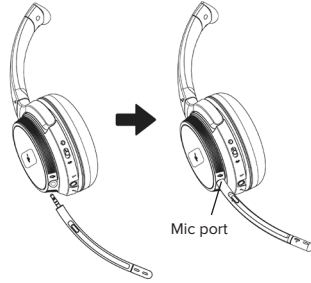

2. The boom microphone can move to accommodate a user's preference for right side or left side wear.



3. Position the microphone to your preference.



### Targus Wireless Stereo Headset

#### Operation:

##### Power On

Slide the switch to the CENTER position.

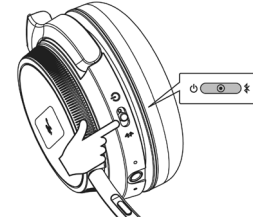

##### Power Off

Slide the switch to  position.

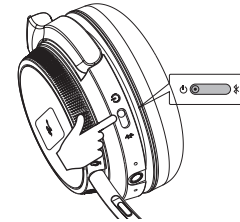

### Targus Wireless Stereo Headset

#### Bluetooth connecting:

How to connect with the first Bluetooth device.

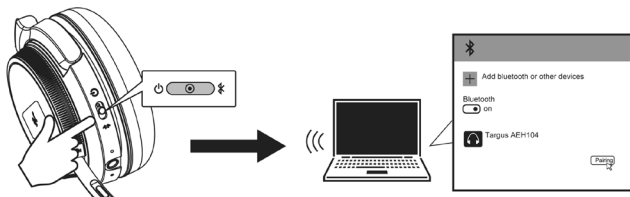

Slide the power switch to the "CENTER" position. The LED will flash red and blue when ready to connect.

Windows 10 PCs and Macs will automatically recognize and install drivers.

#### Connecting to the second Bluetooth device:

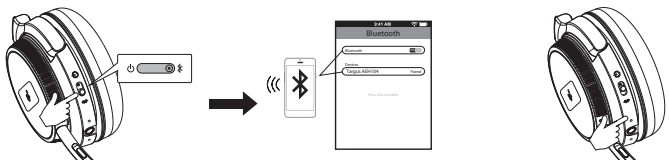

Slide the power switch to the "PAIRING" position and hold until 'pairing' heard or the pairing LED flashes, then select "Targus AEH104" on your device.

Activate "Bluetooth" in your device settings and select "Targus AEH104".

The LED will flash blue to indicate the headphone is connected, and 'connected' is heard.

### Targus Wireless Stereo Headset

#### 3.5mm AUX connecting

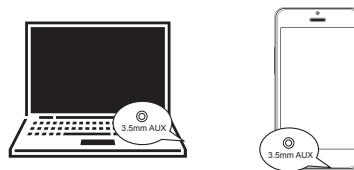

Please make sure your device supports 3.5mm audio.

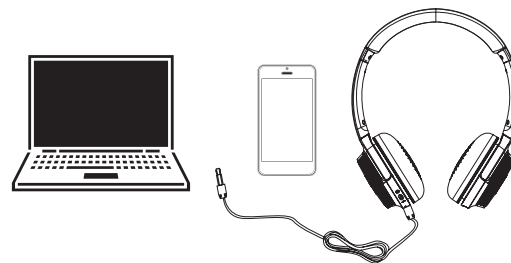

Insert the 3.5mm audio cable into the Bluetooth headset and your device, then it becomes a wired headset with basic functionality.

**Note:** When connected via the AUX wired connection the wireless functions of the headset will be automatically disabled.

### Targus Wireless Stereo Headset

#### Calls with a Smartphone:

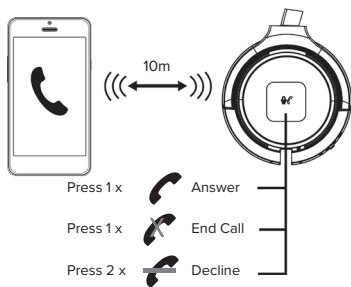

#### Siri / Cortana / Assistance:

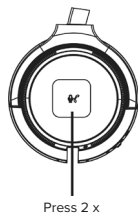

### Targus Wireless Stereo Headset

#### Charging the Headset:

The red LED will indicate charging. When fully charged, the red LED will turn off. The headset remains on during charging.  
 To power off, slide the headset's power switch to the off position.

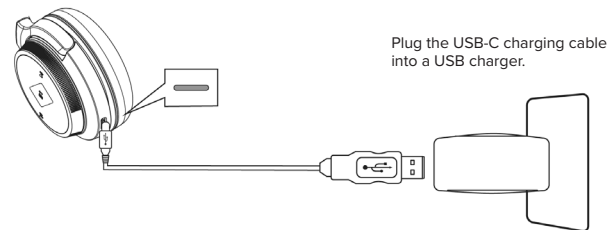
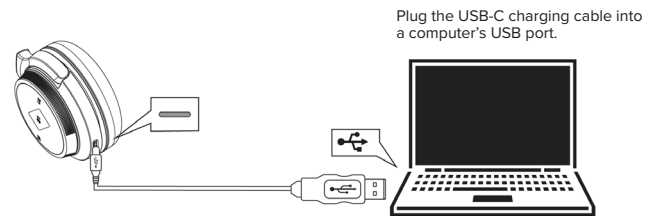

## Targus Wireless Stereo Headset

### Other Operations:

Muting the Boom Mic: Press and hold  for 2 seconds.

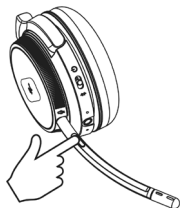

Muting the internal Mic: (When boom mic is not in use) Press and hold  for 2 seconds.

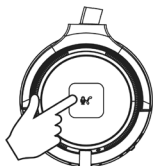

Battery Status: After the headset is powered on, press  briefly to hear the current battery status.

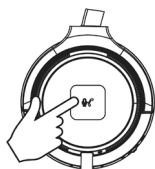

Reset the headset: While the headset is powered on, press and hold  simultaneously for 5 seconds. A pink LED will light for 2 seconds and the headset will then enter pairing mode.

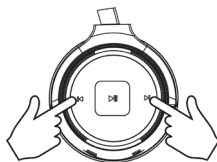

## Targus Wireless Stereo Headset

### Warning

Headsets can deliver sounds at loud volumes and high-pitched tones. Avoid prolonged use of the headset at excessive sound pressure levels. Please read the safety guidelines below prior to using this headset.

#### Safety information

Use of a headset will impair your ability to hear other sounds. Use caution while using your headset when you are engaging in any activity that requires your full attention. This package contains small parts that may be hazardous to children and should be kept out of reach from children.

Do not attempt to dismantle or service the product as this may cause a short circuit or other malfunction which could result in a fire or electric shock. Avoid exposing your product to rain, moisture or other liquids to avoid damage to the product or injury to you. Keep all products, cords, and cables away from operating machinery. Avoid use while operating a motor vehicle.

Built-in battery care: Please observe the following if the product contains a battery. Your product is powered by a rechargeable battery.

The full performance of a new battery is achieved only after two or three complete charge and discharge cycles. The battery can be charged and discharged hundreds of times but will eventually wear out.

Always try to keep the battery between 15°C and 25°C (59°F and 77°F). A product with a hot or cold battery may not work temporarily, even when the battery is fully charged. Battery performance is particularly limited in temperatures well below freezing.

#### Battery warning!

CAUTION: Risk of explosion if the battery is replaced an incorrect disposal of a battery into fire or a hot oven, or mechanically crushing or cutting of a battery, that can result in an explosion; leaving a battery in an extremely high temperature surrounding environment that can result in an explosion or the leakage of flammable liquid or gas; battery subjected to extremely low air pressure that may result in an explosion or the leakage of flammable liquid or gas.

## Targus Wireless Stereo Headset

### Troubleshooting & Support

#### Headphones will not power on:

- Be sure the headphones are fully charged.

#### My mobile device is unable to find the Bluetooth headphones

- Be sure the headphones are fully charged.
- Confirm the headphones are in pairing mode (blue/red LED).
- Remove "Targus AEH104" from your device's Bluetooth device list and try again.
- If the model still does not appear, restart the headset and phone, then try again.

#### After successfully pairing, the headphones disconnect

- Be sure the headphones are fully charged.
- Headphones must be within 10m of most mobile devices.
- Connections may be affected by obstructions such as walls or other electronic devices. Try moving closer to the device you are connected to.

#### When answering a call, I cannot hear anything

- Ensure the mobile device is connected to the Targus AEH104 headphones and not on phone's speaker or other audio option.
- Increase the volume on your mobile device.

#### There is no sound when listening to music

- Increase the volume on your headphones or the mobile device.
- Reestablish the Bluetooth wireless connection between the headphones and your mobile device.
- Check if the audio app has paused or stopped playback.

#### Headphones will not charge

- Confirm that the charging cable is operational or undamaged.
- Ensure that the USB charging cable is fully inserted in the headphones and charger ports.
- Confirm that the USB port is outputting power. Some USB ports shut off when the PC is off.

## Targus Wireless Stereo Headset



### Supplier's Declaration of Conformity



Manufacturer/ Responsible Party :	Targus International LLC	Tel: 1-714-765-5555
Address :	1211 North Miller Street, Anaheim, CA 92806 USA	Fax: 1-714-765-5599 Internet: www.targus.com

Hereby declares that the Product

Trade name: **Targus**

Product name: Wireless Stereo Headset

Model number(Reg#): AEH104

Conforms to the following specifications

**FCC CFR Title 47 Part 15 Subpart B and ANSI C63.4-2014 standard limits**  
The test data & results are referred to the test report Number: SZCR2112024017D1

#### Supplementary Information:

This device complies with part 15 of the FCC Rules. Operation is subject to the following two conditions: (1) This device may not cause harmful interference, and (2) this device must accept any interference received, including interference that may cause undesired operation.

Director, Targus International LLC Function Title	Ngoh, CF Name
1/20/2022 Date	 Signed for and on behalf of Targus



## Targus Wireless Stereo Headset

### FR - Introduction

Nous vous félicitons d'avoir acheté le casque stéréo sans fil Targus.

### Contenu

- Casque stéréo sans fil Targus AEH104
- Câble de charge USB-C
- Micro perche
- Câble audio 3,5 mm
- Guide d'utilisation

### Spécifications du produit

- Version Bluetooth : Bluetooth V5.0
- Profil Bluetooth : A2DPv1.3.1 ; AVRCPv1.6 ; HFPv1.7 ; HSPv1.2
- Fréquence de fonctionnement : 2.402 GHz - 2.480 GHz
- Sensibilité du haut-parleur : 95±3dB
- Réponse en fréquence : 20 - 20 KHZ
- Sensibilité de réception : >-89dBm
- Type de batterie : Lithium polymère
- Type et sensibilité du micro : Microphone à condensateur -42±3dB
- Capacité de la batterie : 410 mAh
- Tension de charge : CC 5 V 500 mA
- Plage de fonctionnement Bluetooth : Jusqu'à 10 m
- Durée de conversation : Jusqu'à 18 heures
- Durée de charge : Environ 2 heures
- Autonomie en veille : Environ 205 heures

### Configuration requise

- Windows®
- macOS®
- iOS®
- Android™

## Targus Wireless Stereo Headset

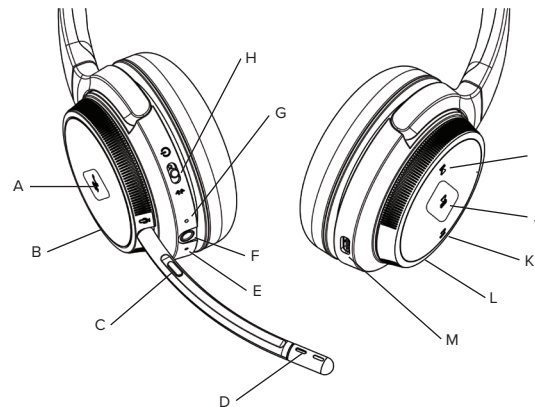

A. Activer / désactiver le son

B. Rotation du microphone à perche

C. Interrupteur de sourdine de la perche

D. Microphone à perche

E. Micro interne

F. Entrée audio

G. Voyant Bluetooth

H. Marche / Arrêt / Appariement

I. Plage précédente











J. Lecture / pause

K. Plage suivante











L. Tourner pour régler le volume

M. Port de chargement USB-C

## Targus Wireless Stereo Headset

Fonction	Fonctionnement
Mise sous tension	Faites glisser l'interrupteur en position CENTRALE
Mise hors tension	Faites glisser l'interrupteur sur la position 
Appariement	Mise sous tension du casque : 1. Si le casque n'a pas été connecté au dernier périphérique ou réinitialisé, il entrera automatiquement en mode d'appariement. Recherchez Targus AEH104 dans la liste des noms d'appareils Bluetooth de votre appareil et cliquez sur connexion. 2. Si le casque a été connecté au dernier périphérique, il se reconnectera automatiquement.
Statut de la batterie	Après la mise sous tension, appuyez  une fois sur la touche et maintenez-la enfoncée pour entendre le statut en cours de la batterie.
Fonction de coupure d'appel	Microphone intégré: Appuyez et maintenez  pendant 2 secondes Microphone externe: Appuyez sur la touche  et maintenez-la enfoncée pendant 2 secondes.
Connecter le deuxième appareil	Faites à nouveau glisser l'interrupteur en position  et maintenez-le enfoncé pendant 6 secondes pour entrer en mode d'appariement, puis recherchez le Targus AEH104 sur votre appareil et cliquez sur Connexion.
Répondre à l'appel	1. Appuyez une fois sur  sur le casque Bluetooth 2. Appuyez une fois sur  sur le microphone à perche
Terminer l'appel	1. Appuyez une fois sur  sur le casque Bluetooth 2. Appuyez une fois sur  sur le microphone à perche
Refuser l'appel	Appuyez deux fois sur 

## Targus Wireless Stereo Headset

Basculer entre l'appel en cours et la réponse à un autre appel	Appuyez et maintenez  pendant 2 secondes lors de la réception d'un autre appel
Conserver l'appel en cours et répondre à un autre appel	Appuyez et maintenez  pendant 2 secondes lors de la réception d'un autre appel
Rejeter un appel lorsqu'il est pris	Appuyez deux fois sur 
Volume +	Tournez le bouton de volume dans le sens des aiguilles d'une montre 
Volume -	Tournez le bouton de volume dans le sens inverse des aiguilles d'une montre 
Dernière chanson	Appuyez une fois sur 
Chanson suivante	Appuyez une fois sur 
Lecture / pause	Appuyez une fois sur 
Réinitialiser le casque	Appuyez et maintenez enfoncé  /  pendant 5 secondes simultanément lorsque le casque est sous tension, le voyant rose s'allumera pendant 2 secondes et le casque entrera en mode d'appariement.
SIRI	Appuyez deux fois sur 
Protection contre les températures élevées de charge	Lorsque la température du casque et de la batterie interne atteint $45 \pm 3$ °C, la charge de la batterie interne du casque s'arrête automatiquement.
Protection contre les basses températures de charge	Lorsque la température du casque et de la batterie interne atteint $0 \pm 3$ °C, le casque arrête automatiquement de charger la batterie interne.

### Targus Wireless Stereo Headset

#### Comment le porter :

1. Insérez le port 2,5 mm du microphone à perche détachable situé sur le casque.

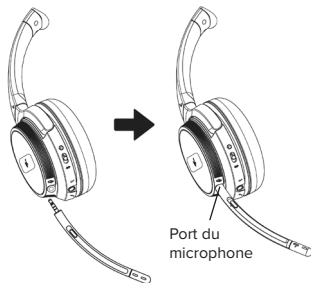

2. Le microphone à perche peut être déplacé pour l'adapter à la préférence de l'utilisateur pour un port sur le côté droit ou sur le côté gauche.



3. Positionnez le microphone selon vos préférences.



### Targus Wireless Stereo Headset

#### Fonctionnement :

##### Mise sous tension

Faites glisser l'interrupteur sur la position CENTRALE.

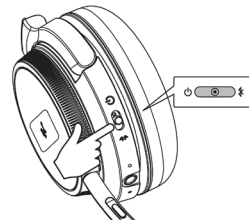

##### Mise hors tension

Faites glisser l'interrupteur sur la position .

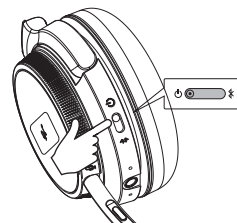

## Targus Wireless Stereo Headset

### Connexion Bluetooth :

Comment le connecter avec le premier périphérique Bluetooth.

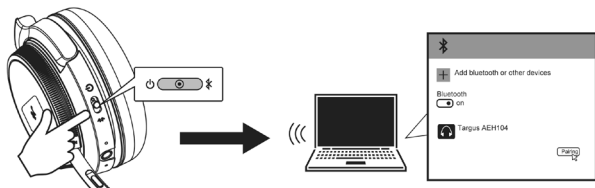

Faites glisser l'interrupteur en position CENTRALE. Le voyant LED clignotera en rouge et bleu lorsqu'il sera prêt à se connecter.

Les PC et Mac sous Windows 10 seront automatiquement reconnus et les pilotes seront installés.

### Connexion au deuxième périphérique Bluetooth :

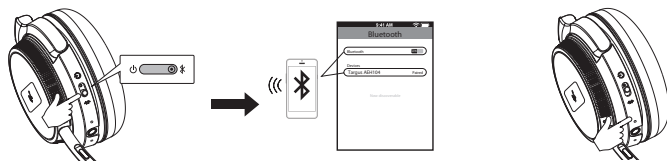

Faites glisser l'interrupteur d'alimentation sur la position « ON » et maintenez-le enfoncé jusqu'à ce que vous entendiez le signal d'appariement ou que le voyant d'appariement clignote, puis sélectionnez « Targus AEH104 » sur votre appareil.

Activez « Bluetooth » dans les paramètres de votre appareil et sélectionnez « Targus AEH104 ».

Le voyant LED clignotera en bleu pour indiquer que le casque est connecté, et le mot « Connecté » est entendu.

## Targus Wireless Stereo Headset

### Connexion AUX 3,5 mm



Veuillez vous assurer que votre appareil prend en charge l'audio 3,5 mm.

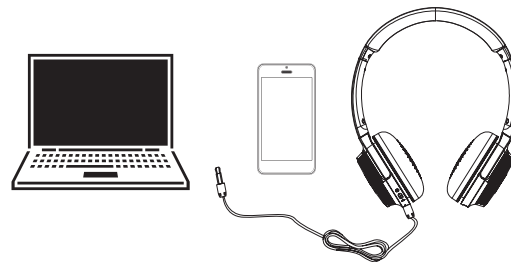

Insérez le câble audio 3,5 mm dans le casque Bluetooth et votre appareil, il devient alors un casque filaire avec des fonctionnalités de base.

**Remarque :** Lorsqu'il est connecté via la connexion filaire AUX, les fonctions sans fil du casque sont automatiquement désactivées.

### Targus Wireless Stereo Headset

#### Llamadas con un smartphone:

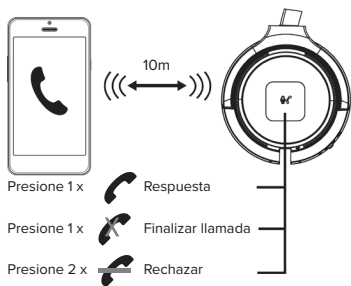

#### Siri / Cortana / Asistencia:

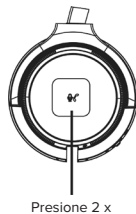

### Targus Wireless Stereo Headset

#### Carga de los auriculares:

El LED rojo indicará que está cargando. Cuando esté completamente cargado, el LED rojo se apagará. Los auriculares permanecen encendidos durante la carga. Para apagarlo, deslice el interruptor de encendido del auricular a la posición de apagado.

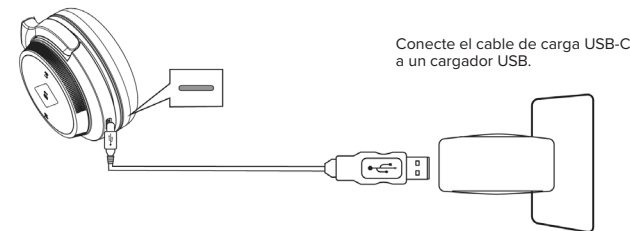
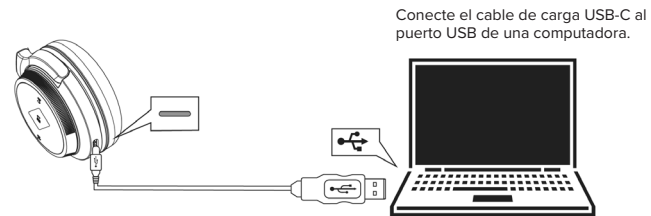

## Targus Wireless Stereo Headset

### Autres opérations :

Désactiver le microphone à perche : Appuyez et maintenez  pendant 2 secondes.

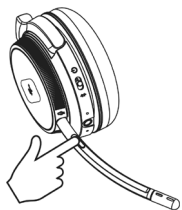

Statut de la batterie : Une fois le casque sous tension, appuyez brièvement sur  pour entendre le statut en cours de la batterie.

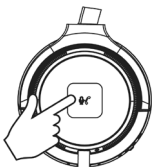

Désactiver le microphone interne : (Lorsque le microphone à perche n'est pas utilisé) Appuyez sur la touche  et maintenez-la enfoncée pendant 2 secondes.

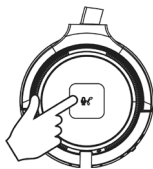

Réinitialiser le casque : Lorsque le casque est sous tension, appuyez simultanément sur  et maintenez-le enfoncé pendant 5 secondes. Un voyant LED rose s'allume pendant 2 secondes et le casque entrera alors en mode d'appariement.

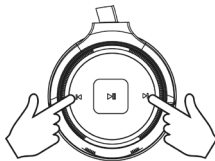

## Targus Wireless Stereo Headset

### Avertissement

Les casques peuvent produire des sons à des volumes élevés et des tonalités aigus. Évitez l'utilisation prolongée du casque à des niveaux de pression acoustique excessifs. Veuillez lire les consignes de sécurité ci-dessous avant d'utiliser ce casque.

#### Consignes de sécurité

L'utilisation d'un casque altérera votre capacité à entendre d'autres sons. Faites preuve de prudence en utilisant votre casque lorsque vous vous livrez à une activité qui requiert toute votre attention. Cet emballage contient de petites pièces qui peuvent être dangereuses pour les enfants et qui doivent être tenues hors de portée des enfants.

N'essayez pas : De démonter ou de réparer le produit, car cela pourrait provoquer un court-circuit ou un autre dysfonctionnement pouvant entraîner un incendie ou un choc électrique. Évitez d'exposer votre produit à la pluie, à l'humidité ou à d'autres liquides pour éviter d'endommager le produit ou de vous blesser. Maintenez tous les produits, cordons et câbles éloignés des machines en marche. Évitez d'utiliser le produit lorsque vous conduisez un véhicule à moteur.

Entretien de la batterie intégrée : Veuillez observer ce qui suit si le produit contient une batterie. Votre produit est alimenté par une batterie rechargeable.

Les performances complètes d'une batterie neuve ne sont atteintes qu'après deux ou trois cycles complets de charge et de décharge. La batterie peut être chargée et déchargée des centaines de fois, mais elle finira par s'user.

Essayez toujours de maintenir la batterie entre 15°C et 25°C (59°F et 77°F). Un produit dont la batterie est chaude ou froide peut ne pas fonctionner temporairement, même si la batterie est entièrement chargée. Les performances de la batterie sont particulièrement limitées à des températures bien inférieures au point de congélation.

#### Avertissement concernant la batterie !

MISE EN GARDE : Risque d'explosion en cas de remplacement de la batterie ; élimination incorrecte d'une batterie dans un feu ou un four chaud, ou écrasement ou découpage mécanique d'une batterie, pouvant entraîner une explosion ; abandon d'une batterie dans un environnement à température extrêmement élevée pouvant entraîner une explosion ou la fuite d'un liquide ou d'un gaz inflammable ; batterie soumise à une pression d'air extrêmement faible pouvant entraîner une explosion ou la fuite d'un liquide ou d'un gaz inflammable, ou de gaz inflammable.

## Targus Wireless Stereo Headset

### Guide de dépannage et assistance

#### Le casque ne se met pas sous tension :

- Assurez-vous que le casque est complètement chargé.

#### Mon appareil mobile ne parvient pas à trouver le casque Bluetooth

- Assurez-vous que le casque est complètement chargé.
- Vérifiez que le casque est en mode d'appariement (LED bleu / rouge)
- Supprimez « Targus AEH104 » de la liste des périphériques Bluetooth de votre appareil et réessayez.
- Si le modèle n'apparaît toujours pas, redémarrez le casque et le téléphone, puis réessayez.

#### Une fois l'appariement réussi, le casque se déconnecte.

- Assurez-vous que le casque est complètement chargé.
- Le casque doit se trouver à moins de 10 m de la plupart des appareils mobiles.
- Les connexions peuvent être affectées par des obstructions telles que des murs ou d'autres appareils électroniques. Essayez de vous rapprocher de l'appareil auquel vous êtes connecté.

#### Lorsque je répons à un appel, je n'entends rien

- Assurez-vous que l'appareil mobile est connecté au casque Targus AEH104 et non au haut-parleur du téléphone ou à une autre option audio.
- Augmentez le volume de votre appareil mobile.

#### Il n'y a pas de son lorsque j'écoute de la musique

- Augmentez le volume de votre casque ou de l'appareil mobile.
- Rétablissez la connexion sans fil Bluetooth entre le casque et votre appareil mobile.
- Vérifiez si l'application audio a mis en pause ou arrêté la lecture.

#### Le casque ne se charge pas

- Confirmez que le câble de charge est opérationnel et en bon état.
- Assurez-vous que le câble de charge USB est entièrement inséré dans les ports du casque et du chargeur.
- Vérifiez que le port USB est alimenté. Certains ports USB se coupent lorsque le PC est éteint.

## Targus Wireless Stereo Headset

Targus®

### Déclaration de conformité du fournisseur



Fabricant/ Partie responsable:	Targus International LLC	Tél. :	1-714-765-5555
Adresse:	1211 North Miller Street Anaheim, CA 92806 USA	Télec.:	1-714-765-5599
		Internet:	www.targus.com

Déclare, par les présentes, que le produit

Dénomination commerciale: **Targus**

Nom du produit: Wireless Stereo Headset

Numéro de modèle: AEH104

Conforme aux spécifications suivantes

**FCC CFR titre 47, section 15, sous-section B et les limites standard ANSI C63.4-2014**  
 Pour obtenir les données et les résultats de test, consultez le rapport de test numéro: [SZCR211202401701](#)

#### Renseignements Supplémentaires:

Cet appareil est conforme à la partie 15 des règlement de la FCC. Le fonctionnement est assujéti aux deux conditions suivantes: (1) Cet appareil ne doit pas causer d'interférences nuisibles, et (2) cet appareil doit accepter toute interférence reçue, y compris les interférences pouvant entraîner un fonctionnement indésirable.

Directeur, Qualité et Conformité, Targus International LLC	CF Ngoh
Titre de la fonction	Nom
1/20/2022	
Date	Signature pour et au nom de Targus

## Targus Wireless Stereo Headset

### ES - Introducción

Felicitaciones por la compra de los auriculares estéreo inalámbricos de Targus.

### Contenido

- Auriculares estéreo inalámbricos Targus AEH104
- Cable de carga USB-C
- Micrófono Boom
- Cable de audio de 3,5 mm
- Guía del usuario

### Especificaciones del producto

- Versión bluetooth: Bluetooth V5.0
- Perfil Bluetooth: A2DPv1.3.1; AVRCPv1.6; HFPv1.7; HSPv1.2
- Frecuencia de funcionamiento: 2.402GHz-2.480GHz
- Sensibilidad del altavoz: 95±3dB
- Respuesta de frecuencia: 20-20kHz
- Sensibilidad de recepción: >-89dBm
- Tipo de batería: Polímero de litio
- Tipo de micrófono y sensibilidad: Micrófono de condensador -42±3dB
- Capacidad de la batería: 410mAh
- Voltaje de carga: CC 5V 500mA
- Alcance de funcionamiento del Bluetooth: Hasta 10 m
- Tiempo de conversación: Hasta 18 horas
- Tiempo de carga: Aproximadamente 2 horas
- Tiempo en espera: Aproximadamente 205 horas

### Requisitos del sistema

- Windows®
- macOS®
- iOS®
- Android™

## Targus Wireless Stereo Headset

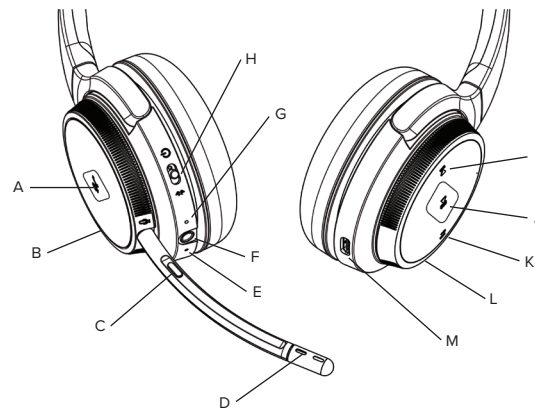











- A. Silenciar/Reactivar sonido
- B. Girar el micrófono Boom
- C. Interruptor de silencio del micrófono Boom
- D. Micrófono Boom
- E. Micrófono interno
- F. Entrada de audio
- G. Bluetooth LED







- H. Activar/Desactivar/Emparejar
- I. Pista anterior
- J. Reproducir/Pausar
- K. Pista siguiente
- L. Girar para ajustar el volumen
- M. Puerto de carga USB-C



## Targus Wireless Stereo Headset

Función	Funcionamiento
Encender	Deslice el interruptor a la posición del CENTRO
Apagar	Deslice el interruptor a la posición 
Emparejar	Encienda los auriculares: 1. Si los auriculares no se han conectado al último dispositivo o no se han restablecido, entrará automáticamente en el modo de emparejamiento. Busque Targus AEH104 en la lista de nombres de dispositivos Bluetooth de su dispositivo y pulse para conectar. 2. Si los auriculares se han conectado al último dispositivo, se volverán a conectar automáticamente.
Estado de la batería	Después de encenderlo, mantenga presionado  una vez para escuchar el estado actual de la batería.
Función de silencio de llamadas	Micrófono incorporado: Mantenga presionado  durante 2 segundos. Micrófono externo: Mantenga presionado  durante 2 segundos.
Conecte el segundo dispositivo	Deslice el interruptor a la posición  nuevamente y mantenga presionado 6 segundos para ingresar al modo de emparejamiento. Luego busque el Targus AEH104 en su dispositivo y pulse para conectar.
Responder a la llamada	1. Presione  una vez en los auriculares Bluetooth. 2. Presione  una vez en el micrófono Boom.
Finalizar la llamada	1. Presione  una vez en los auriculares Bluetooth. 2. Presione  una vez en el micrófono Boom.
Rechazar la llamada	Presione  dos veces

## Targus Wireless Stereo Headset

Cambiar entre la llamada actual y responder a otra llamada	Mantenga presionado  durante 2 segundos cuando reciba otra llamada.
Mantener la llamada actual y responder a otra llamada.	Mantenga presionado  durante 2 segundos cuando reciba otra llamada.
Rechazar una llamada cuando se responde.	Presione  dos veces
Volumen +	Gire el botón de volumen en sentido horario 
Volumen -	Gire el botón de volumen en sentido antihorario 
Última canción	Presione  una vez
Siguiente canción	Presione  una vez
Reproducir / Pausar	Presione  una vez
Restablecer los auriculares	Mantenga presionado  /  durante 5 segundos al mismo tiempo cuando se enciendan los auriculares. La luz rosa estará encendida durante 2 segundos y los auriculares entrarán en el modo de emparejamiento.
SIRI	Presione  dos veces
Protección de carga a alta temperatura.	Cuando la temperatura de los auriculares y la batería interna alcanza los 45±3 °C, la carga de la batería interna de los auriculares se detiene automáticamente.
Protección de carga a baja temperatura.	Cuando la temperatura de los auriculares y la batería interna alcanza los 0±3 °C, los auriculares dejan de cargar automáticamente la batería interna.

### Targus Wireless Stereo Headset

#### Cómo usar:

1. Inserte el puerto desmontable del micrófono Boom de 2,5 mm ubicado en los auriculares.

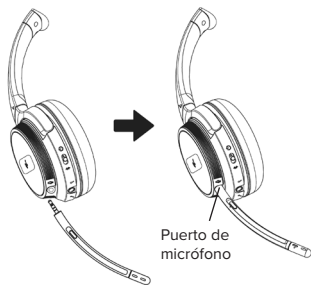

2. El micrófono Boom puede moverse para adaptarse a la preferencia del usuario, del lado derecho o del lado izquierdo.



3. Coloque el micrófono según su preferencia.



### Targus Wireless Stereo Headset

#### Operación:

##### Encendido

Deslice el interruptor a la posición del CENTRO.

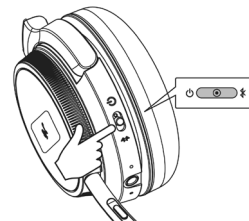

##### Apagado

Deslice el interruptor a la posición .

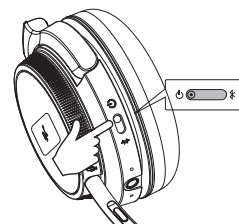

## Targus Wireless Stereo Headset

### Conexión Bluetooth:

Cómo conectarse con el primer dispositivo Bluetooth.

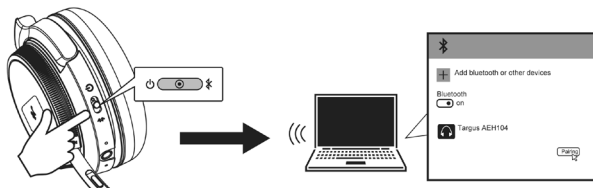

Deslice el interruptor de encendido a la posición del CENTRO. El LED parpadeará en rojo y azul cuando esté listo para conectarse.

Las PC y Mac con Windows 10 reconocerán e instalarán automáticamente los controladores.

### Conexión al segundo dispositivo Bluetooth:

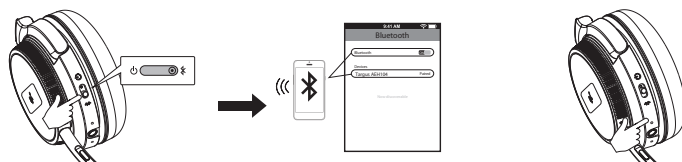

Deslice el interruptor de encendido a la posición "X" y manténgalo presionado hasta que se escuche "emparejamiento" o el LED de emparejamiento parpadee, luego seleccione "Targus AEH104" en su dispositivo.

Active "Bluetooth" en la configuración de su dispositivo y seleccione "Targus AEH104".

El LED parpadeará en azul para indicar que los auriculares están conectados y se escucha "conectado".

## Targus Wireless Stereo Headset

### Cable auxiliar de 3,5 mm

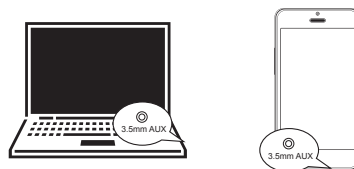

Asegúrese de que su dispositivo admita audio de 3,5 mm.

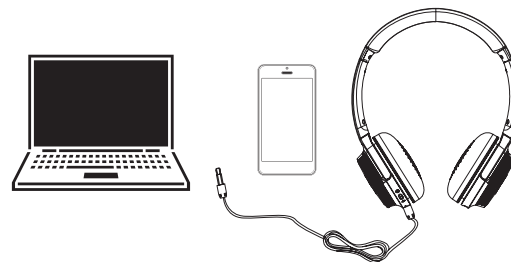

Inserte el cable de audio de 3,5 mm en los auriculares Bluetooth y en su dispositivo, luego se convertirá en un auricular con cable con funcionalidad básica.

**Nota:** Cuando se conecta a través de la conexión por cable AUX, las funciones inalámbricas de los auriculares se desactivarán automáticamente.

### Targus Wireless Stereo Headset

#### Llamadas con un smartphone:

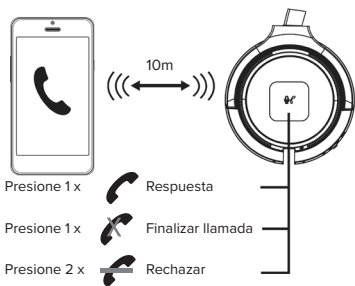

#### Siri / Cortana / Asistencia:

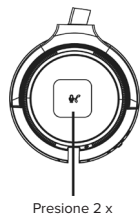

### Targus Wireless Stereo Headset

#### Carga de los auriculares:

El LED rojo indicará que está cargando. Cuando esté completamente cargado, el LED rojo se apagará. Los auriculares permanecen encendidos durante la carga. Para apagarlo, deslice el interruptor de encendido del auricular a la posición de apagado.

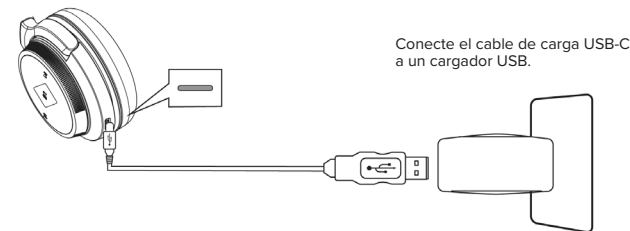
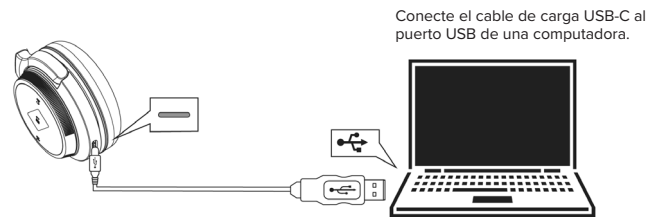

## Targus Wireless Stereo Headset

### Otras operaciones:

Silenciar el micrófono Boom: Mantenga pulsado  durante 2 segundos.

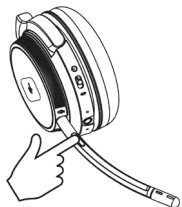

Estado de la batería: Después de encender los auriculares, presione  brevemente para escuchar el estado actual de la batería.

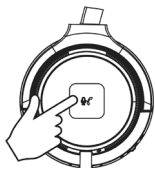

Silenciar el micrófono interno: (Cuando el micrófono Boom no está en uso) Mantenga pulsado  durante 2 segundos.

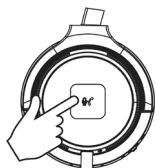

Restablecer los auriculares: Mientras los auriculares están encendidos, mantenga pulsado  simultáneamente durante 5 segundos. Un LED rosa se encenderá durante 2 segundos y los auriculares entrarán en modo de emparejamiento.

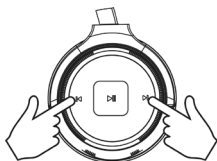

## Targus Wireless Stereo Headset

### Advertencia

Los auriculares pueden emitir sonidos a volúmenes altos y tonos agudos. Evite el uso prolongado de los auriculares a niveles excesivos de presión sonora. Lea las pautas de seguridad a continuación antes de usar estos auriculares.

#### Información de seguridad

El uso de auriculares afectará su capacidad para escuchar otros sonidos. Tenga cuidado al usar los auriculares cuando participe en cualquier actividad que requiera toda su atención. Este paquete contiene piezas pequeñas que pueden ser peligrosas para los niños y deben mantenerse fuera del alcance de los niños.

No intente: Desarmar o reparar el producto, ya que esto puede causar un cortocircuito u otro mal funcionamiento que podría provocar un incendio o una descarga eléctrica. Evite exponer su producto a la lluvia, la humedad u otros líquidos para evitar daños al producto o lesiones físicas. Mantenga todos los productos, cordones y cables alejados de maquinaria en funcionamiento. Evite el uso mientras opera un vehículo motorizado.

Cuidado de la batería incorporada: Tenga en cuenta lo siguiente si el producto contiene una batería. Su producto funciona con una batería recargable.

El rendimiento completo de una batería nueva se logra solo después de dos o tres ciclos completos de carga y descarga. La batería se puede cargar y descargar cientos de veces, pero eventualmente se desgastará. Siempre trate de mantener la batería entre 15 °C y 25 °C (59 °F y 77 °F). Es posible que un producto con una batería caliente o fría no funcione temporalmente, incluso cuando la batería está completamente cargada. El rendimiento de la batería es particularmente limitado en temperaturas muy por debajo del punto de congelación.

#### ¡Advertencia de batería!

PRECAUCIÓN: Riesgo de explosión. Si se sustituye la batería, una eliminación incorrecta de una batería en el fuego o en un horno caliente, o aplastamiento o corte mecánico de una batería puede provocar una explosión; dejar una batería en un entorno de temperatura extremadamente alta puede provocar una explosión o la fuga de líquido o gas inflamable; batería sometida a una presión de aire extremadamente baja puede provocar una explosión o la fuga de líquido o gas inflamable.

## Targus Wireless Stereo Headset

### Resolución de problemas y asistencia

#### Los auriculares no se encienden:

- Asegúrese de que los auriculares estén completamente cargados.

#### Mi dispositivo móvil no puede encontrar los auriculares Bluetooth

- Asegúrese de que los auriculares estén completamente cargados.
- Confirme que los auriculares están en modo de emparejamiento (LED azul / rojo).
- Elimine "Targus AEH104" de la lista de dispositivos Bluetooth de su dispositivo e inténtelo de nuevo.
- Si el modelo sigue sin aparecer, reinicie los auriculares y el teléfono y, a continuación, inténtelo de nuevo.

#### Después de emparejarse correctamente, los auriculares se desconectan

- Asegúrese de que los auriculares estén completamente cargados.
- Los auriculares deben estar a menos de 10 m de la mayoría de los dispositivos móviles.
- Las conexiones pueden verse afectadas por obstrucciones como paredes u otros dispositivos electrónicos. Intente acercarse al dispositivo al que está conectado.

#### Al responder a una llamada, no se escucha nada

- Asegúrese de que el dispositivo móvil esté conectado a los auriculares Targus AEH104 y no en el altavoz del teléfono u otra opción de audio.
- Aumente el volumen en su dispositivo móvil.

#### No hay sonido al escuchar música

- Aumente el volumen de sus auriculares o del dispositivo móvil.
- Restablezca la conexión inalámbrica Bluetooth entre los auriculares y su dispositivo móvil.
- Compruebe si la aplicación de audio ha pausado o detenido la reproducción.

#### Los auriculares no se cargan

- Confirme que el cable de carga está operativo o sin daños.
- Asegúrese de que el cable de carga USB esté completamente insertado en los auriculares y los puertos del cargador.
- Confirme que el puerto USB está emitiendo energía. Algunos puertos USB se apagan cuando el PC está apagado.

## Targus Wireless Stereo Headset

### Technical Support

For technical questions, please visit:

#### US

Internet: <http://targus.com/us/support>

#### Canada

Internet: <http://www.targus.com/ca/support>

#### Australia

Internet: <http://www.targus.com/au/support>

Email: [infoaust@targus.com](mailto:infoaust@targus.com)

Telephone: 1800-641-645

Telephone: 0800-633-222

#### New Zealand

Email: [soporte@targus.com](mailto:soporte@targus.com)

### Product Registration

Targus recommends that you register your Targus accessory shortly after purchasing it. Go to:

[http://targus.com/us/product\\_registration](http://targus.com/us/product_registration)

You will need to provide your full name, email address, country of residence and product information.

### Two Year Warranty

We pride ourselves on the quality of our products. For complete warranty details and a list of our worldwide offices, please visit [www.targus.com](http://www.targus.com). Targus product warranty does not cover any device or product that is not manufactured by Targus (including, but not limited to, laptops, smartphones, devices, or any other product that may be used in connection with the Targus product). Australian customers: For complete warranty details see warranty statement enclosed.

Targus is a registered trademark of Targus International LLC in the U.S. and in certain other countries. Windows is a registered trademark or trademark of Microsoft Corporation in the United States and/or other countries. macOS is a trademark of Apple Inc., registered in the U.S. and other countries. iOS is a trademark or registered trademark of Cisco in the U.S. and other countries and used by Apple Inc. under license. Android is a trademark of Google LLC. Bluetooth is a registered trademark of Bluetooth SIG, Inc. USB Type-C and USB-C are registered trademarks of USB Implementers. All logos and registered trademarks are the property of their respective owners. ©2022 Targus, 1211 North Miller Street, Anaheim, CA 92806 USA. All rights reserved.

## Targus Wireless Stereo Headset

### AUSTRALIAN AND NEW ZEALAND CONSUMERS ONLY

1. Targus warrants to the original purchaser that its products are free from defects in materials and workmanship for one year. This warranty is limited to defects, materials and workmanship. 2. The benefits to the consumer given by the warranty are in addition to other rights and remedies of the consumer under law in relation to the goods to which the warranty relates. 3. The warranty is given by (i) Targus Australia, (ii) Targus Australia's business address is: Suite 2, Level 8, 5 Rider Boulevard, Rhodes NSW 2138 Australia, (iii) Targus Australia's telephone number is 1800 641 645, Email: infoaust@targus.com (iv) To make a warranty claim for goods purchased in New Zealand, the telephone number is: 0800 633 222, or the goods may be returned to the supplier in New Zealand. 4. What the purchaser must do to entitle the purchaser to claim warranty:- (i) The purchaser must call the telephone number for Australia or New Zealand set out above, (ii) The purchaser must provide the purchaser's name, daytime contact number, business hours delivery address, the Targus model number on the product, date and place of purchase with receipt for purchase if required, and describe the fault condition. 5. What Targus must do:- (i) Targus will provide the purchaser with store return information or a return authorisation so that the purchaser may return the product for warranty inspection, (ii) If after inspection Targus finds the product is defective in materials or workmanship, Targus shall replace (or repair) the defective product at the discretion of Targus and ship the product from Targus warehouse at its expense within three business days (Monday to Friday excluding public holidays) of receiving the returned goods. If the product is no longer available Targus reserves the right to replace with the nearest corresponding product of no lesser quality, (iii) Targus will bear the cost of return delivery to the purchaser regardless of the inspection test result. The purchaser must bear the cost of the delivery to Targus. There is no charge for inspection. 6. Our goods come with guarantees that cannot be excluded under the Australian Consumer Law. You are entitled to a replacement or refund for a major failure and for compensation for any other reasonable foreseeable loss or damage. You are also entitled to have the goods repaired or replaced if the goods fail to be of acceptable quality and the failure does not amount to a major failure. 7. Please note: (i) Features and specifications of all Targus products are subject to change without notification, (ii) In some instances: Goods presented for repair may be replaced by refurbished goods of the same type rather than being repaired. Refurbished parts may be used to repair the goods, (iii) If goods accepted for repair retain user-generated data: During the process of repair some or all of your stored data may be lost. Please ensure that you have saved this data elsewhere prior to repair.

### Regulatory Compliance

This device complies with Part 15 of the FCC Rules. Operation is subject to the following two conditions: (1) This device may not cause harmful interference, and (2) This device must accept any interference received, including interference that may cause undesired operation.

The Class [B] digital apparatus meets all requirements of the Canadian Interference-Causing Equipment Regulation. Cet appareil numérique de la classe [B] respecte toutes les exigences du Règlement sur le matériel brouilleur du Canada.

## Targus Wireless Stereo Headset

### FCC Statement

#### Tested to Comply

This device complies with Part 15 of the FCC Rules. Operation is subject to the following two conditions:

- (1) This device may not cause harmful interference, and
  - (2) This device must accept any interference received, including interference that may cause undesired operation.
- Warning: Changes or modifications not expressly approved by the party responsible for compliance could void the user's authority to operate the equipment.

NOTE: This equipment has been tested and found to comply with the limits for a Class B digital device, pursuant to Part 15 of the FCC Rules. These limits are designed to provide reasonable protection against harmful interference in a residential installation.

This equipment generates uses and can radiate radio frequency energy and, if not installed and used in accordance with the instructions, may cause harmful interference to radio communications. However, there is no guarantee that interference will not occur in a particular installation. If this equipment does cause harmful interference to radio or television reception, which can be determined by turning the equipment off and on, the user is encouraged to try to correct the interference by one or more of the following measures:

- Reorient or relocate the receiving antenna.
- Increase the separation between the equipment and receiver.
- Connect the equipment into an outlet on a circuit different from that to which the receiver is connected.
- Consult the dealer or an experienced radio/TV technician for help.

### Declaration of Conformity

Hereby, Targus, declares that this device is in compliance with the essential requirements and other relevant provisions of Directive 2014/53/EU.

### Radiation Exposure statement

This equipment complies with FCC/IC RSS-102 radiation exposure limits set forth for an uncontrolled environment. Cet équipement est conforme aux limites d'exposition aux radiations FCC/IC CNR-102 établies pour un environnement non contrôlé.

This device contains licence-exempt transmitter(s)/receiver(s) that comply with Innovation, Science and Economic Development Canada's licence-exempt RSS(s).

Operation is subject to the following two conditions:

- (1) This device may not cause interference.
- (2) This device must accept any interference, including interference that may cause undesired operation of the device.

L'émetteur/récepteur exempt de licence contenu dans le présent appareil est conforme aux CNR d'Innovation, Sciences et Développement économique Canada applicables aux appareils radio exempts de licence. L'exploitation est autorisée aux deux conditions suivantes :

- (1) L'appareil ne doit pas produire de brouillage;
- (2) L'appareil doit accepter tout brouillage radioélectrique subi, même si le brouillage est susceptible d'en compromettre le fonctionnement.