



FCC - TEST REPORT

Report Number : **68.950.20.0280.01** Date of Issue: June 17, 2020

Model : AKB651

Product Type : Wireless Keyboard

Applicant : Targus International LLC

Address : 1211 North Miller Street Anaheim, CA 92806 USA

Manufacturer : Targus International LLC

Address : 1211 North Miller Street Anaheim, CA 92806 USA

Factory : SHENZHEN WEIJIAN PLASTIC PRODUCT CO., LTD.

Address : Floor 2, Building H, Wanda Industrial Park, Zhoushi Road, Shiyan Street, Baoan District, Shenzhen, China

Test Result : **n Positive** Negative

Total pages including Appendices : 38

TÜV SÜD Certification and Testing (China) Co., Ltd. Shenzhen Branch is a subcontractor to TÜV SÜD Product Service GmbH according to the principles outlined in ISO 17025.

TÜV SÜD Certification and Testing (China) Co., Ltd. Shenzhen Branch reports apply only to the specific samples tested under stated test conditions. Construction of the actual test samples has been documented. It is the manufacturer's responsibility to assure that additional production units of this model are manufactured with identical electrical and mechanical components. The manufacturer/importer is responsible to the Competent Authorities in Europe for any modifications made to the production units which result in non-compliance to the relevant regulations. TÜV SÜD Certification and Testing (China) Co., Ltd. Shenzhen Branch shall have no liability for any deductions, inferences or generalizations drawn by the client or others from TÜV SÜD Certification and Testing (China) Co., Ltd. Shenzhen Branch issued reports.

This report is the confidential property of the client. As a mutual protection to our clients, the public and ourselves, extracts from the test report shall not be reproduced except in full without our written approval



1 Table of Contents

1	Table of Contents	2
2	Details about the Test Laboratory.....	3
3	Description of the Equipment Under Test.....	4
4	Summary of Test Standards	5
5	Summary of Test Results	6
6	General Remarks	7
7	Test Setups	8
8	Systems test configuration	9
9	Technical Requirement	10
9.1	Conducted peak output power.....	10
9.2	20 dB bandwidth and 99% Occupied Bandwidth.....	13
9.3	Carrier Frequency Separation	17
9.4	Number of hopping frequencies.....	19
9.5	Dwell Time	21
9.6	Spurious RF conducted emissions.....	24
9.7	Band edge testing	28
9.8	Spurious radiated emissions for transmitter.....	31
10	Test Equipment List.....	37
11	System Measurement Uncertainty.....	38



2 Details about the Test Laboratory

Details about the Test Laboratory

Test Site 1

Company name: TÜV SÜD Certification and Testing (China) Co., Ltd. Shenzhen Branch
Building 12&13, Zhiheng Wisdomland Business Park,
Nantou Checkpoint Road 2, Nanshan District,
Shenzhen City, 518052,
P. R. China

FCC Registration No.: 514049

Telephone: 86 755 8828 6998
Fax: 86 755 8828 5299

3 Description of the Equipment Under Test

Product:	Wireless Keyboard
Model no.:	AKB651
FCC ID:	OXM000111
Brand Name:	MTG
Options and accessories:	NIL
Rating:	3V DC, 100mA(supplied by 2x1.5V "AAA" non-rechargeable Batteries)
RF Transmission Frequency:	2408-2474MHz
No. of Operated Channel:	34
Modulation:	FSK
Antenna Type:	PCB
Antenna Gain:	-0.61dBi
Description of the EUT:	The Equipment Under Test (EUT) is a Wireless Keyboard operated at 2.4GHz



4 Summary of Test Standards

Test Standards	
FCC Part 15 Subpart C 10-1-2019 Edition	PART 15 - RADIO FREQUENCY DEVICES Subpart C - Intentional Radiators

All the test methods were according to KDB 558074 D01 v05r02 and Public Notice DA 00-705 - Frequency Hopper Spread Spectrum Test Procedure released by FCC on March 30, 2000 and ANSI C63.10-2013.

5 Summary of Test Results

Technical Requirements				
FCC Part 15 Subpart C				
Test Condition		Pages	Test Site	Test Result
§15.207	Conducted emission AC power port	N/A	---	Not Applicable
§15.247(b)(1)	Conducted peak output power	13	Site 2	Pass
§15.247(a)(2)	6dB bandwidth	---	---	N/A
§15.247(a)(1)	20dB bandwidth and 99% Occupied Bandwidth	15	Site 2	Pass
§15.247(a)(1)	Carrier frequency separation	20	Site 2	Pass
§15.247(a)(1)(iii)	Number of hopping frequencies	22	Site 2	Pass
§15.247(a)(1)(iii)	Dwell Time	24	Site 2	Pass
§15.247(e)	Power spectral density*	---	---	N/A
§15.247(d)	Spurious RF conducted emissions	27	Site 2	Pass
§15.247(d)	Band edge	33	Site 2	Pass
§15.247(d) & §15.209 &	Spurious radiated emissions for transmitter and receiver	38	Site 2	Pass
§15.203	Antenna requirement	See note 2		Pass

Note 1: N/A=Not Applicable.

Note 2: The EUT uses a permanently PCB antenna, which gain is -0.61dBi. In accordance to §15.203, It is considered sufficiently to comply with the provisions of this section.

Remark: The EUT power supplied by 2x1.5V" AA" non-rechargeable Batteries.



6 General Remarks

Remarks

This submittal(s) (test report) is intended for FCC ID: OXM000111 complies with Section 15.209, 15.247 of the FCC Part 15, Subpart C Rules.

SUMMARY:

All tests according to the regulations cited on page 5 were

n - Performed

o - **Not** Performed

The Equipment Under Test

n - **Fulfills** the general approval requirements.

o - **Does not** fulfill the general approval requirements.

Sample Received Date: May 13, 2020

Testing Start Date: May 14, 2020

Testing End Date: May 27, 2020

TÜV SÜD Certification and Testing (China) Co., Ltd. Shenzhen Branch

Reviewed by:



John Zhi
EMC Project Manager

Prepared by:

Warlen Song
EMC Project Engineer



Tested by:

Tree Zhan
EMC Test Engineer

7 Test Setups

7.1 AC Power Line Conducted Emission test setups

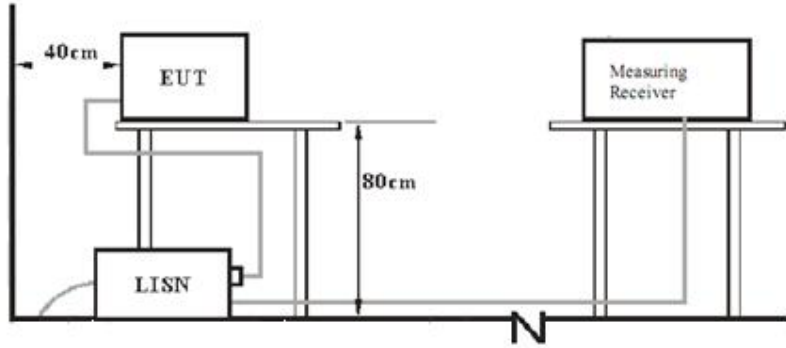

7.2 Radiated test setups

Below 1GHz

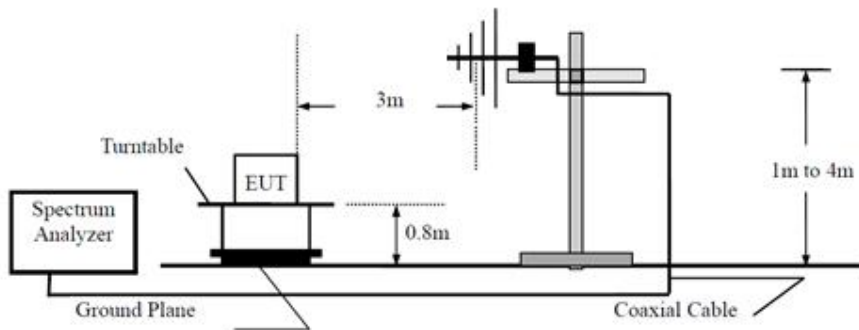

Above 1GHz

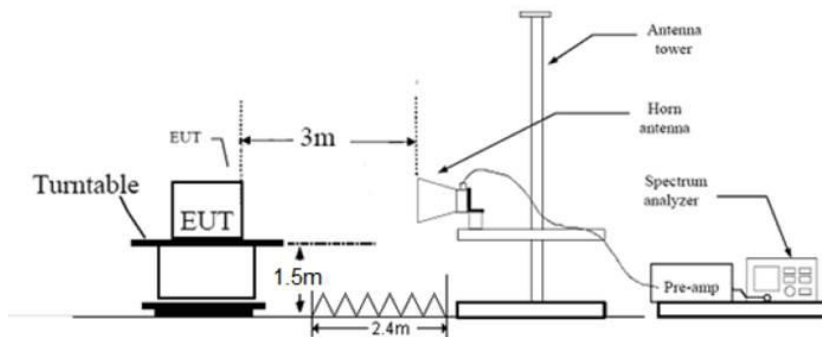

7.3 Conducted RF test setups

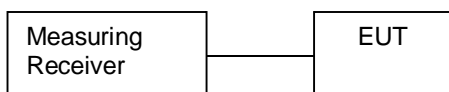

8 Systems test configuration

Auxiliary Equipment Used during Test:

DESCRIPTION	MANUFACTURER	MODEL NO.(SHIELD)	S/N(LENGTH)
PC	Dell	--	---
Notebook	Lenovo	X220	---

The system was configured to hopping mode and non-hopping mode.

Hopping mode: typical working mode (normal hopping status)

Non-hopping mode: The system was configured to operate at a signal channel transmitting. The test software allows the configuration and operation at the worst-case duty and the highest transmit power

9 Technical Requirement

9.1 Conducted peak output power

Test Method

1. Use the following spectrum analyzer settings:
Span = approximately 5 times the 20 dB bandwidth, centered on a hopping channel
RBW > the 20 dB bandwidth of the emission being measured, VBW ≥ RBW,
Sweep = auto, Detector function = peak, Trace = max hold
2. Add a correction factor to the display.
3. Allow the trace to stabilize. Use the marker-to-peak function to set the marker to the peak of the emission. The indicated level is the peak output power

Limits

According to §15.247 (b) (1) conducted peak output power limit as below:

Frequency Range MHz	Limit W	Limit dBm
2400-2483.5	≤1	≤30

Conducted peak output power

FSK modulation Test Result

Frequency MHz	Conducted Peak Output Power dBm	Result
Low channel 2408MHz	-9.16	Pass
Middle channel 2440MHz	-8.91	Pass
High channel 2474MHz	-8.93	Pass

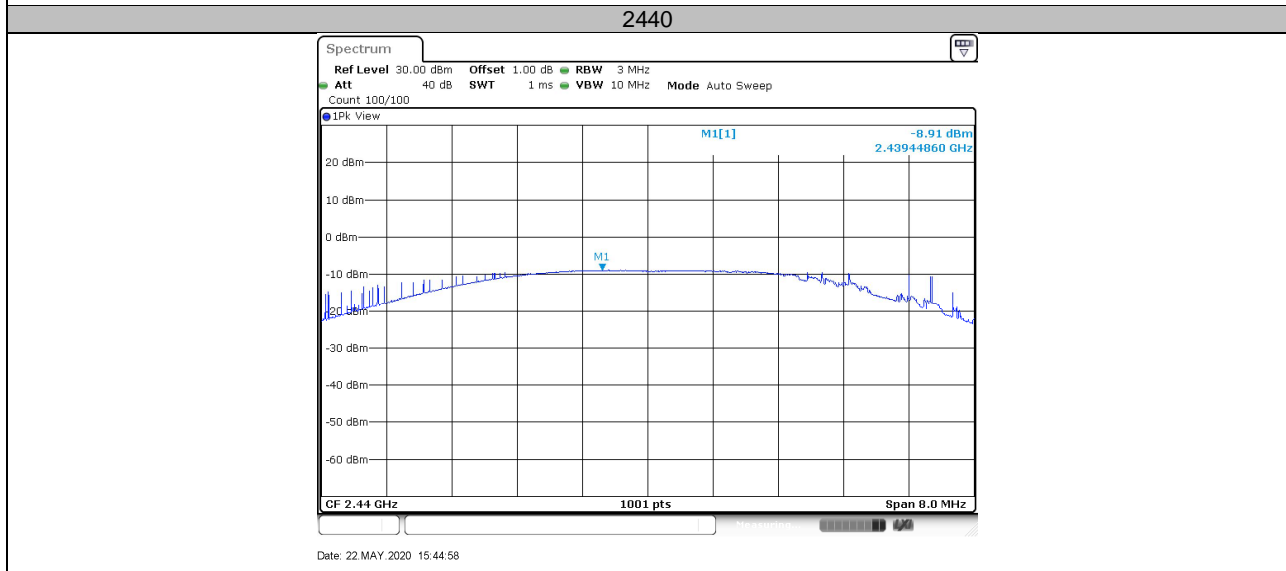
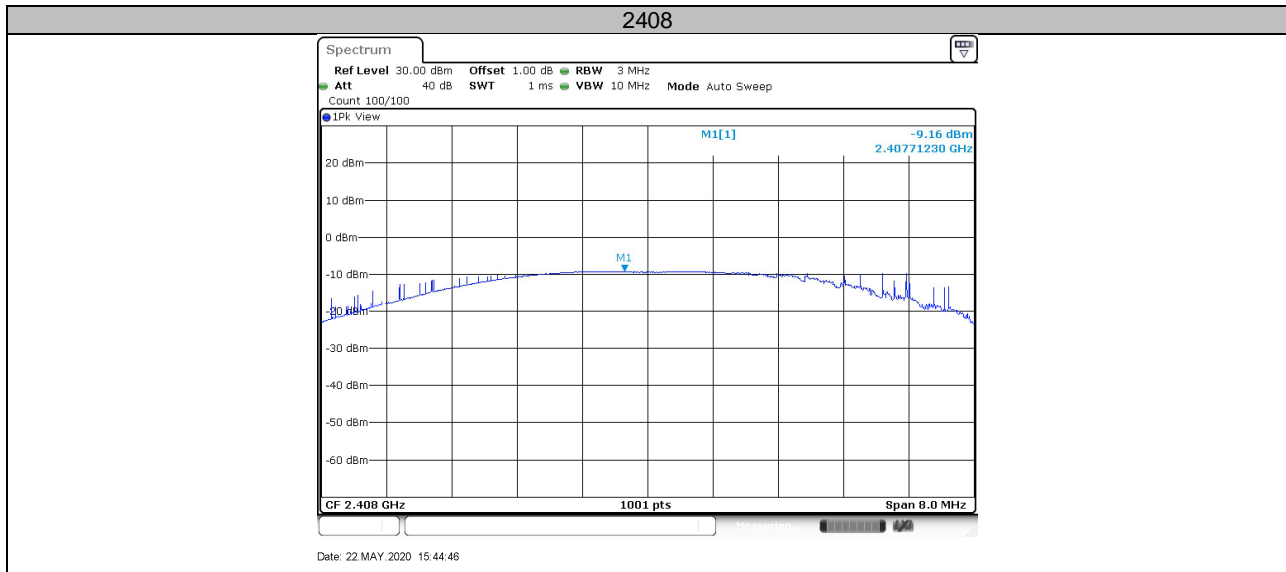

2474

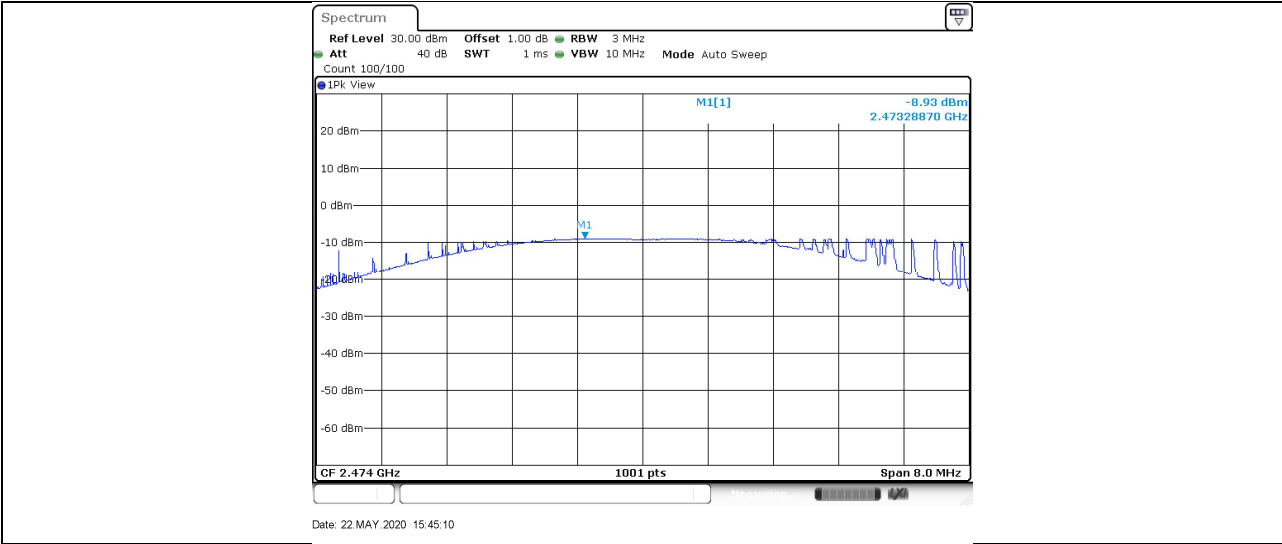

9.2 20 dB bandwidth and 99% Occupied Bandwidth

Test Method

1. Check the calibration of the measuring instrument using either an internal calibrator or a known signal from an external generator.
2. Position the EUT without connection to measurement instrument. Turn on the EUT and connect it to measurement instrument. Then set it to any one convenient frequency within its operating range. Set a reference level on the measuring instrument equal to the highest peak value.
3. Measure the frequency difference of two frequencies that were attenuated 20 dB from the reference level. Record the frequency difference as the emission bandwidth.
4. Repeat above procedures until all frequencies measured were complete.

Limit

Limit [kHz]

N/A

20 dB bandwidth and 99% Occupied Bandwidth

FSK Modulation test result

Frequency MHz	20 dB Bandwidth kHz	99% Bandwidth kHz	Limit kHz	Result
2408	2676	2485	--	Pass
2440	2673	2206	--	Pass
2474	2550	2137	--	Pass

20 dB Bandwidth

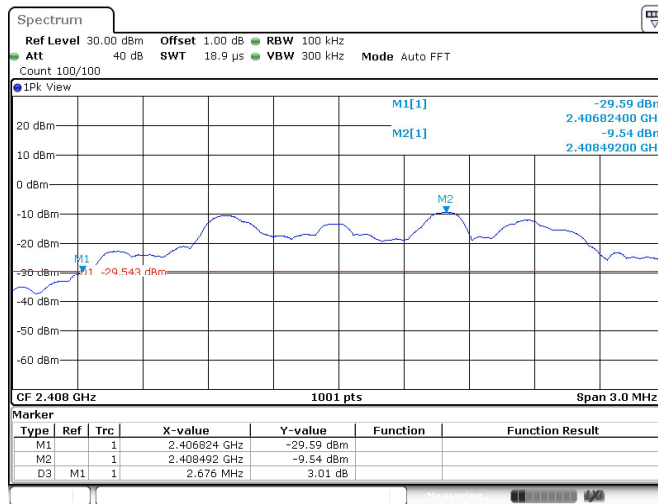

Date: 22 MAY 2020 15:26:19

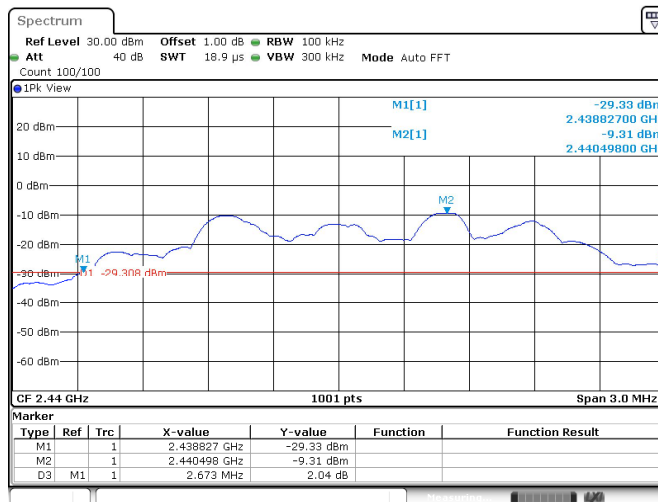

Date: 22 MAY 2020 15:28:06

20 dB Bandwidth

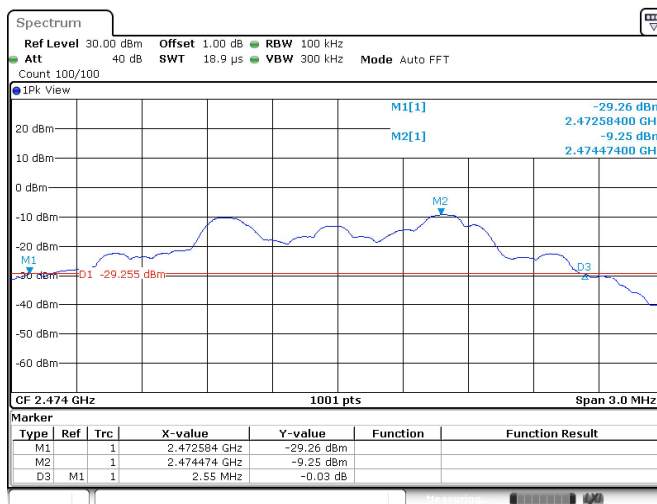

Date: 22.MAY.2020 15:31:49

99% Bandwidth

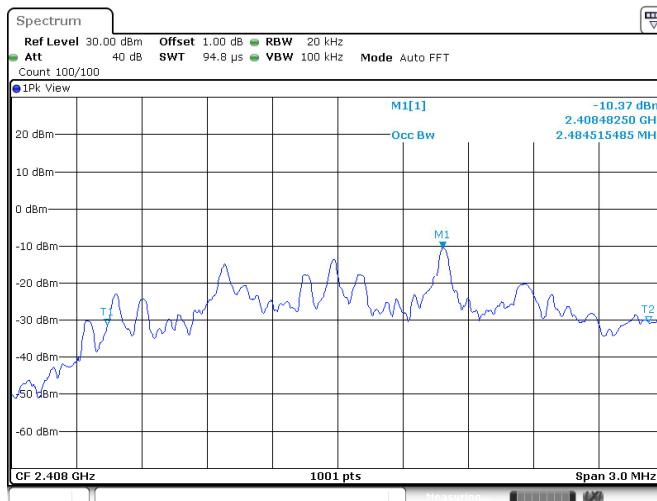

Date: 22.MAY.2020 15:26:30

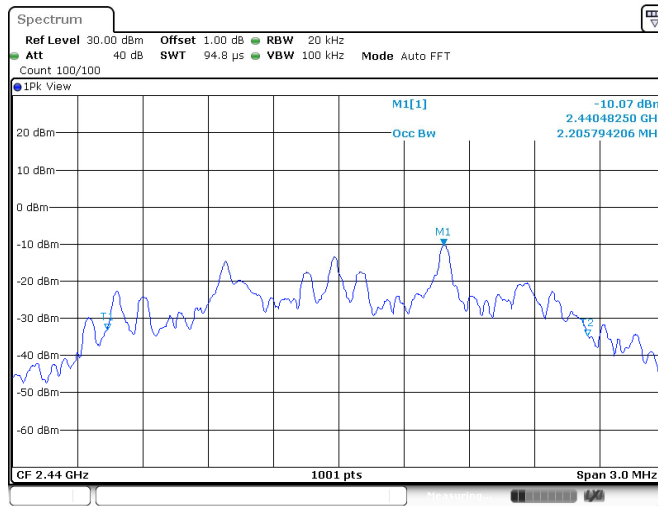

Date: 22.MAY.2020 15:28:17

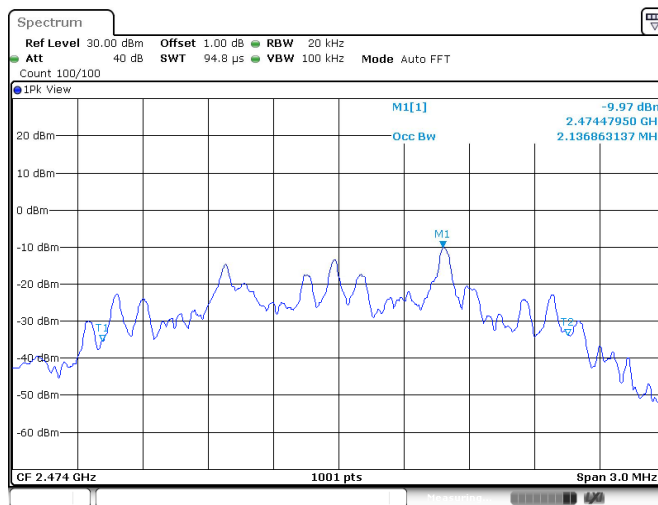

Date: 22.MAY.2020 15:31:59



9.3 Carrier Frequency Separation

Test Method

1. Use the following spectrum analyzer settings:
Span = wide enough to capture the peaks of two adjacent channels, RBW \geq 1% of the span, VBW) \geq RBW, Sweep = auto, Detector function = peak
2. By using the Max-Hold function record the separation of two adjacent channels.
3. Measure the frequency difference of these two adjacent channels by spectrum analyzer marker function.
4. Repeat above procedures until all frequencies measured were complete.

Limit

$$\frac{\text{Limit}}{\text{kHz}} \geq 25\text{KHz or } 2/3 \text{ of the } 20 \text{ dB bandwidth which is greater}$$

FSK Modulation Limit

Frequency MHz	2/3 of 20 dB Bandwidth kHz
2408	1784
2440	1782
2474	1700



Carrier Frequency Separation

Test result: The measurement was performed with the typical configuration (normal hopping status), here FSK modulation mode was used to show compliance.

FSK Modulation test result

Frequency MHz	Carrier Frequency Separation kHz	Result
2440	1994	Pass

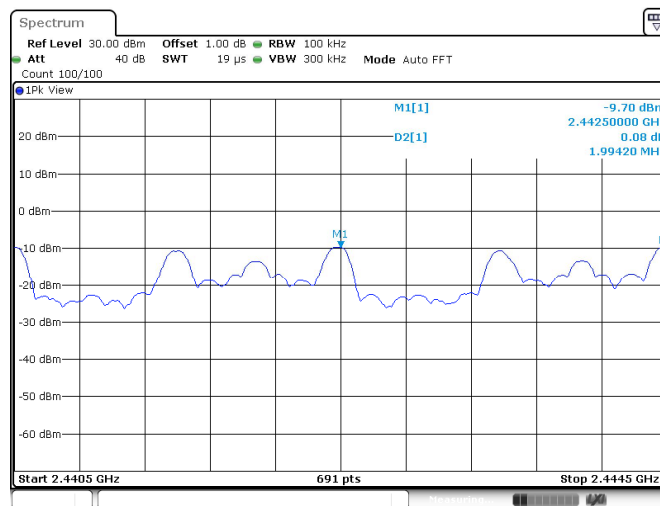

Date: 22 MAY 2020 15:42:28

9.4 Number of hopping frequencies

Test Method

1. Use the following spectrum analyzer settings:
Span = wide enough to capture the peaks of two adjacent channels, $RBW \geq 1\%$ of the span, $VBW \geq RBW$, Sweep = auto, Detector function = peak
2. Set the spectrum analyzer on Max-Hold Mode, and then keep the EUT in hopping mode.
3. Record all the signals from each channel until each one has been recorded.
4. Repeat above procedures until all frequencies measured were complete.

Limit

**Limit
number**

≥ 15



Number of hopping frequencies

Test result: The measurement was performed with the typical configuration (normal hopping status), and the total hopping channels is constant for the all modulation mode according with the Bluetooth Core Specification. Here FSK modulation mode was used to show compliance.

Number of hopping frequencies	Result
34	Pass

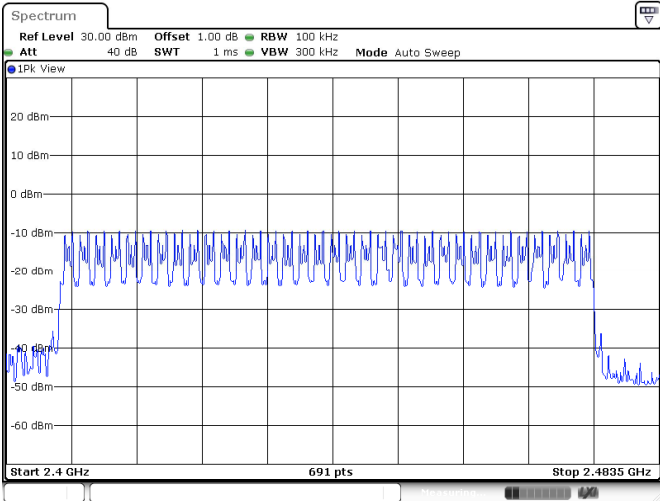

Date: 22.MAY.2020 15:34:50

9.5 Dwell Time

Test Method

1. Connect EUT antenna terminal to the spectrum analyzer with a low loss cable.
Equipment mode: Spectrum analyzer
2. RBW: 1MHz; VBW: 1MHz; SPAN: Zero Span
3. Adjust the center frequency of spectrum analyzer on any frequency be measured.
4. Measure the Dwell Time by spectrum analyzer Marker function.
5. Repeat above procedures until all frequencies measured were complete.

Limit

According to §15.247(a)(1)(iii) The average time of occupancy on any frequency shall not be greater than 0.4 seconds within a period of 0.4 seconds multiplied by the number of hopping channels employed.

Dwell Time

Dwell time

The maximum dwell time shall be 0,4 s.

The Dwell Time = Burst Width * Total Hops. The detailed calculations are showed as follows:

The duration for dwell time calculation: 0.4 [s] * hopping number = 0.4 [s] * 34 [ch] = 13.6 [s*ch];

The burst width, which is directly measured, refers to the duration on one channel hop.

Test Result

Modulation	Mode	Reading (ms)	Total Hops	Test Result (ms)	Limit (ms)	Result
FSK	Hop	15.62	25	390.5	< 400	Pass

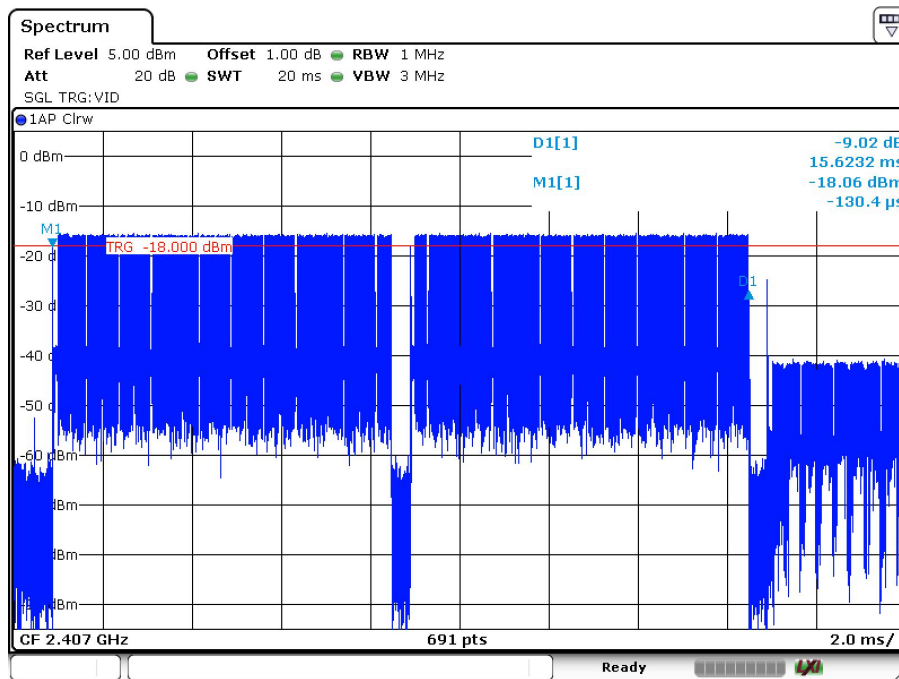

Date: 17.JUN.2020 17:59:31

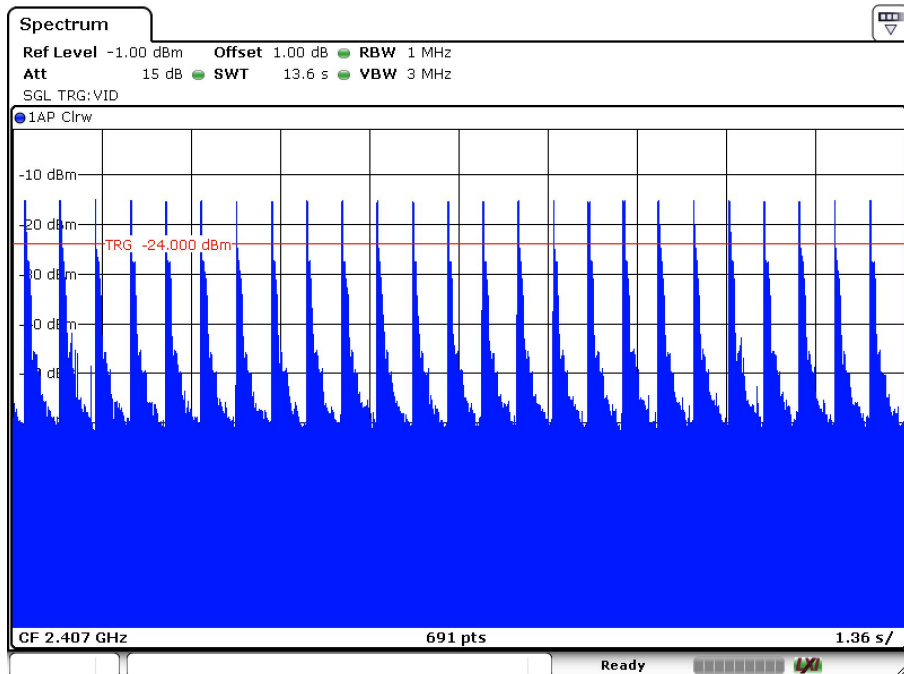

Date: 17.JUN.2020 18:02:04



9.6 Spurious RF conducted emissions

Test Method

1. Use the following spectrum analyzer settings:
 Span = wide enough to capture the peak level of the in-band emission and all spurious emissions (e.g., harmonics) from the lowest frequency generated in the EUT up through the 10th harmonic. Typically, several plots are required to cover this entire span.
 RBW = 100 kHz, VBW ≥ RBW, Sweep = auto, Detector function = peak, Trace = max hold
2. Allow the trace to stabilize. Set the marker on the peak of any spurious emission recorded.
3. The level displayed must comply with the limit specified in this Section. Submit these plots.
4. Repeat above procedures until all frequencies measured were complete.

Limit

Frequency Range MHz	Limit (dBc)
30-25000	-20

Spurious RF conducted emissions 2408MHz

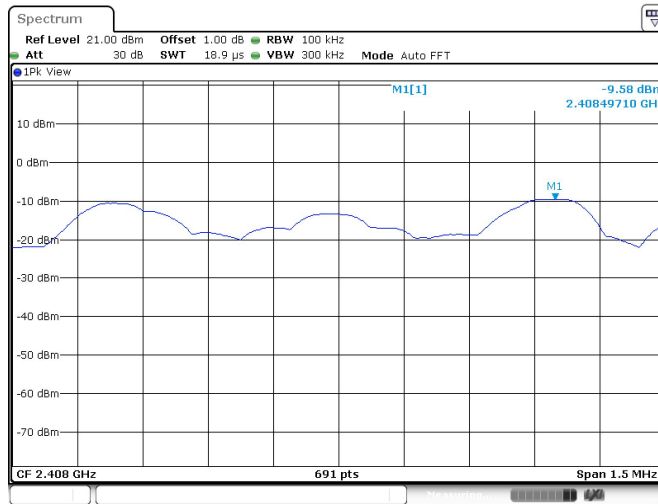

Date: 22.MAY.2020 15:28:46

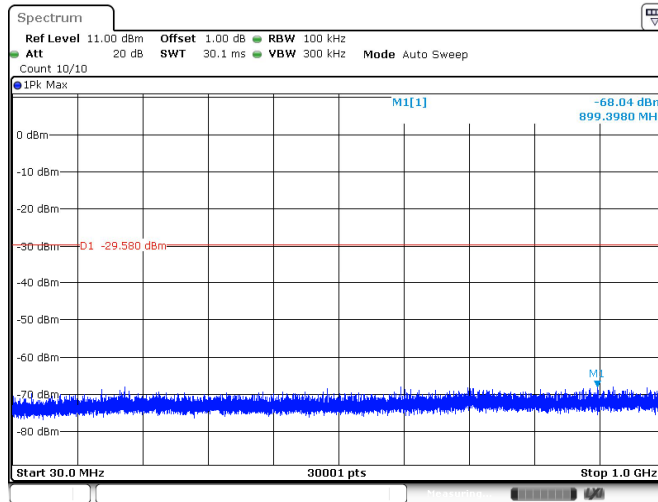

Date: 22.MAY.2020 15:28:52

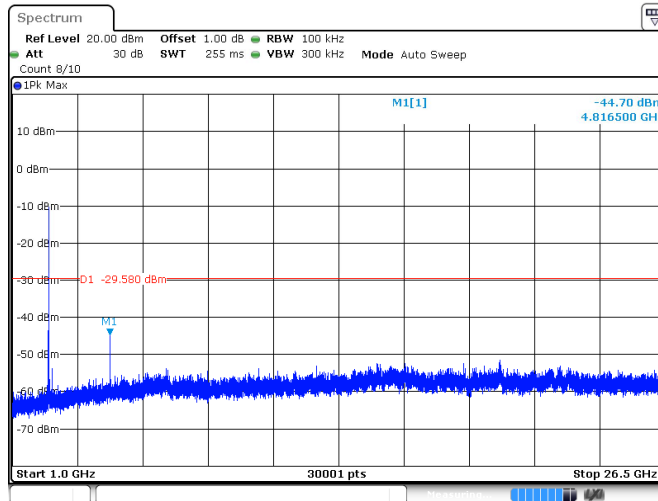

Date: 22.MAY.2020 15:27:00

2440:

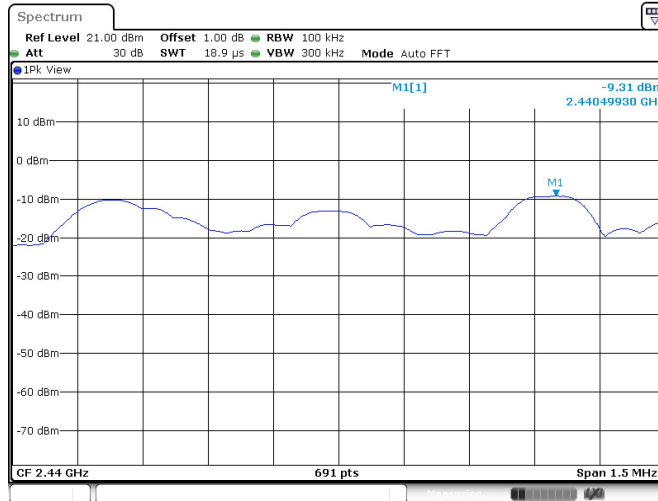

Date: 22.MAY.2020 15:28:22

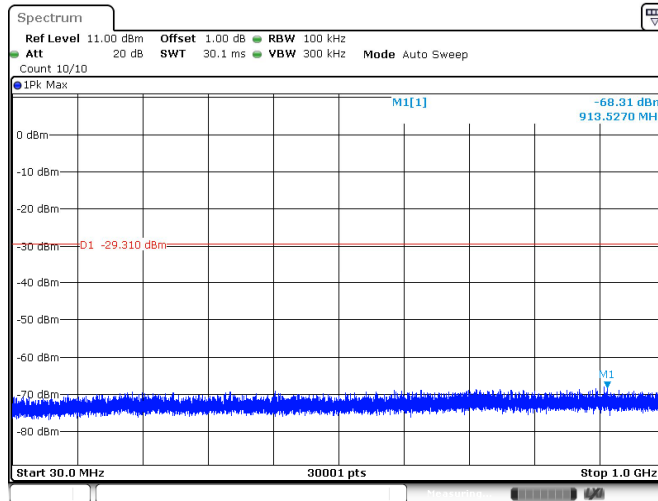

Date: 22.MAY.2020 15:28:28

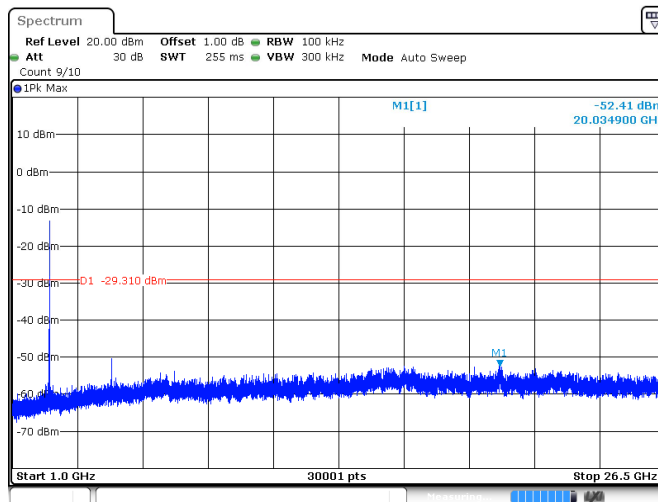

Date: 22.MAY.2020 15:28:36

2474:

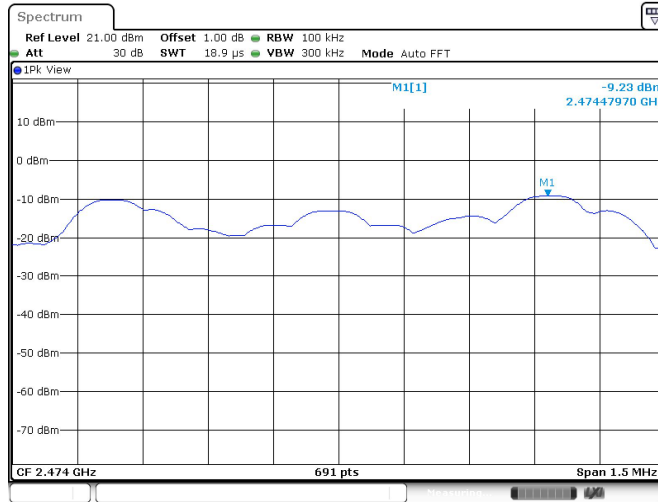

Date: 22 MAY 2020 15:32:14

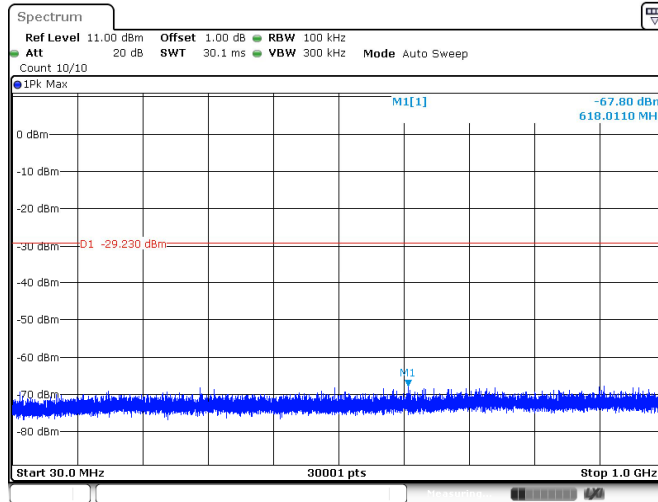

Date: 22 MAY 2020 15:32:20

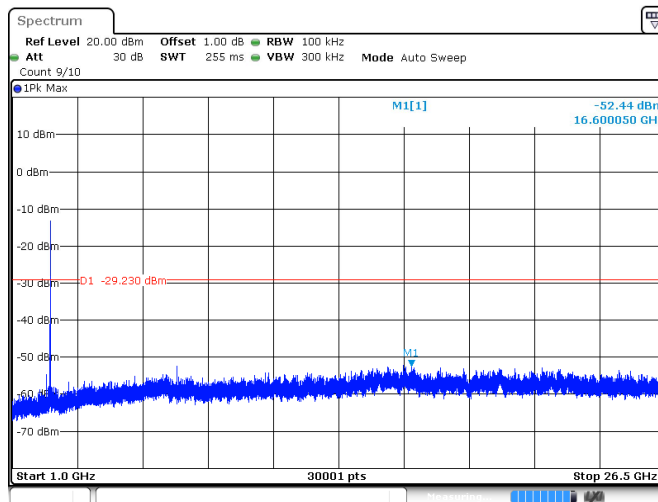

Date: 22 MAY 2020 15:32:28

9.7 Band edge testing

Test Method

- 1 Use the following spectrum analyzer settings:
Span = wide enough to capture the peak level of the in-band emission and all spurious
RBW = 100 kHz, VBW \geq RBW, Sweep = auto, Detector function = peak, Trace = max hold
- 2 Allow the trace to stabilize, use the peak and delta measurement to record the result.
- 3 The level displayed must comply with the limit specified in this Section. .
- 4 Repeat the test at the hopping off and hopping on mode, submit all the plots.

Limit:

According to §15.247(d), in any 100 kHz bandwidth outside the frequency bands in which the spread spectrum intentional radiator is operating, the radio frequency power that is produced by the intentional radiator shall be at least 20 dB below that in the 100 kHz bandwidth within the band that contains the highest level of the desired power, based on either an RF conducted or a radiated measurement, provided the transmitter demonstrates compliance with the peak conducted power limits. In addition, radiated emissions which fall in the restricted bands, as defined in §15.205(a) and RSS-Gen7.2.2, must also comply with the radiated emission limits specified in 15.209(a) (see Section 15.205(c)).

Band edge testing

Test Result:
Hopping on mode:

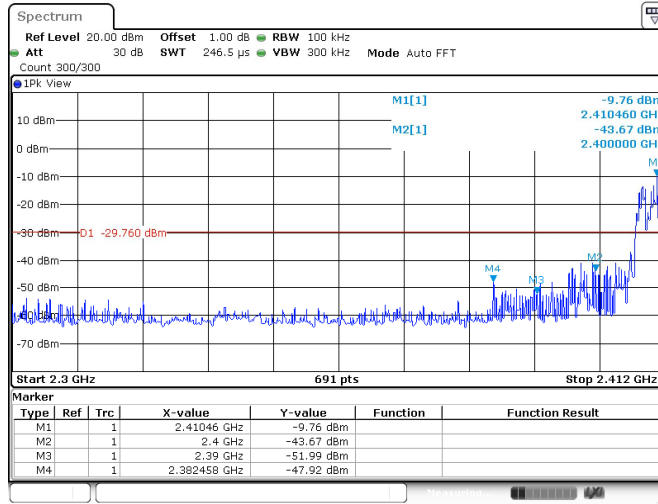

Date: 22 MAY 2020 15:50:59

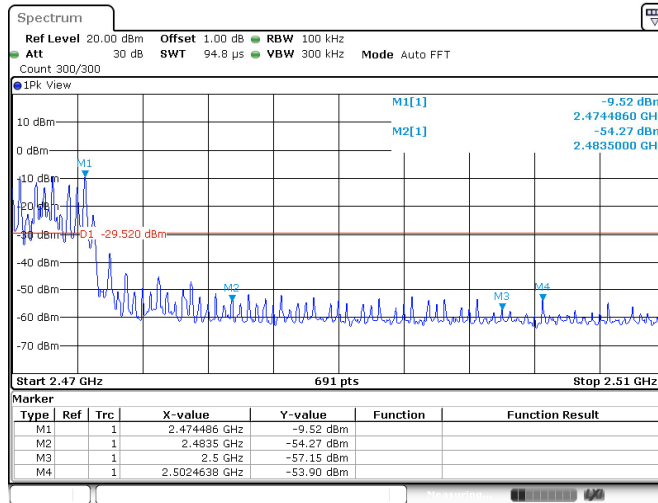

Date: 22 MAY 2020 15:43:56

Band edge testing

Hopping off mode:

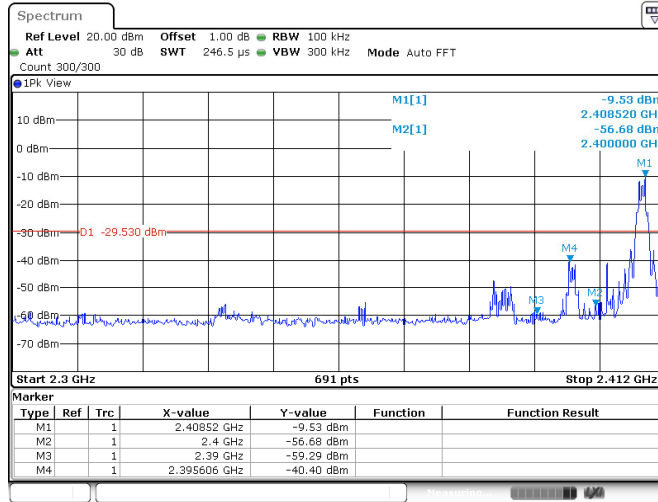

Date: 22 MAY 2020 15:49:28

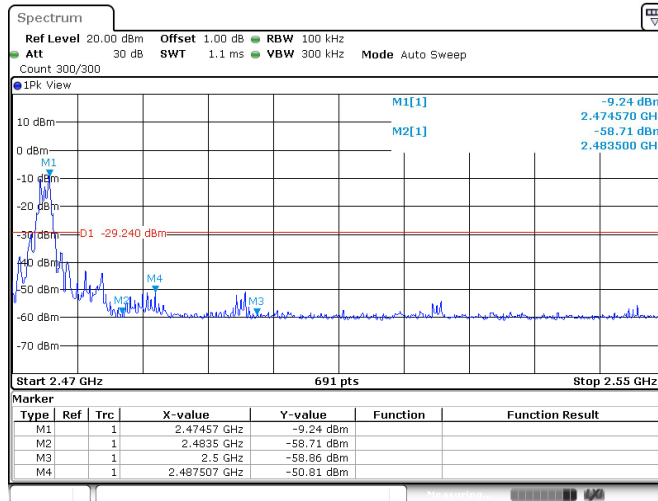

Date: 22 MAY 2020 15:32:08

9.8 Spurious radiated emissions for transmitter

Test Method

1. The EUT is placed on a turntable, which is 0.8m above ground plane.
2. EUT is set 3m away from the receiving antenna, which is varied from 1m to 4m to find out the highest emissions.
3. Use the following spectrum analyzer settings:
Span = wide enough to fully capture the emission being measured, RBW = 1 MHz for $f \geq 1$ GHz, 100 kHz for $f < 1$ GHz, VBW \geq RBW, Sweep = auto, Detector function = peak, Trace = max hold
4. Follow the guidelines in ANSI C63.4-1992 with respect to maximizing the emission by rotating the EUT, adjusting the measurement antenna height and polarization, etc.
The peak reading of the emission, after being corrected by the antenna factor, cable loss, pre-amp gain, etc., is the peak field strength, submit this data. Each emission was to be maximized by changing the polarization of receiving antenna both horizontal and vertical.
5. Set the VBW to 10 Hz, while maintaining all of the other instrument settings. This peak level, once corrected, must comply with the limit specified in Section 15.209. If the duty cycle per channel of the hopping signal is less than 100 ms, then the reading obtained with the 10 Hz VBW may be further adjusted by a "duty cycle correction factor", derived from $20\log(\text{duty cycle}/100 \text{ ms})$, in an effort to demonstrate compliance with the 15.209 limit. Submit this data.

Limit

According to part 15.247(d), the radio emission outside the operating frequency band shall be at least 20 dB below that in the 100 kHz bandwidth within the band that contains the highest level of the desired power. Radiated emissions which fall in the restricted bands, as defined in section 15.205, must comply with the radiated emission limits specified in section 15.209.

Frequency MHz	Field Strength uV/m	Field Strength dB μ V/m	Detector
30-88	100	40	QP
88-216	150	43.5	QP
216-960	200	46	QP
960-1000	500	54	QP
Above 1000	500	54	AV
Above 1000	5000	74	PK

Spurious radiated emissions for transmitter and receiver

According to C63.10, if the peak (or quasi-peak) measured value complies with the average limit, it is unnecessary to perform an average measurement, so AV emission value did not show in below table if the peak value complies with average limit.



Transmitting spurious emission test result as below:

Below 1G:

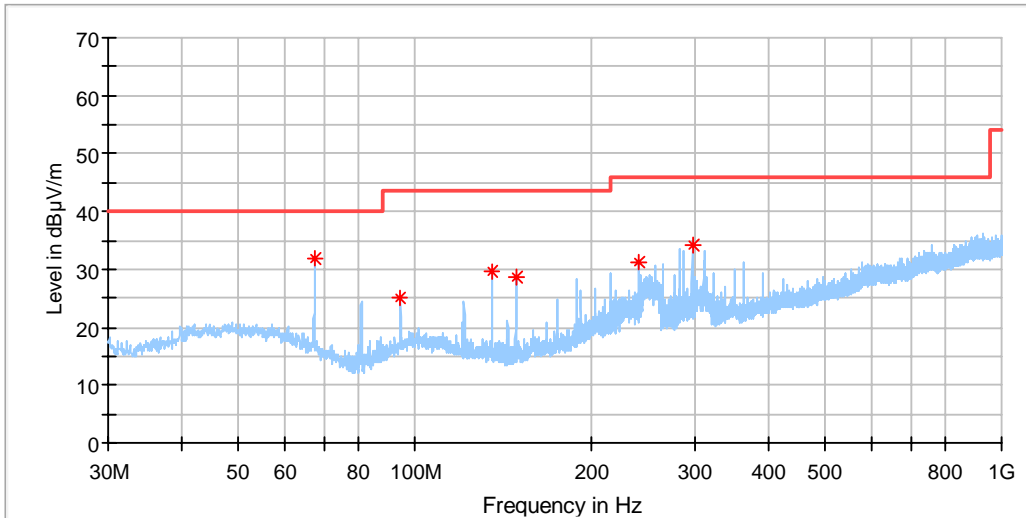

Frequency (MHz)	MaxPeak (dBµV/m)	Limit (dBµV/m)	Margin (dB)	Height (cm)	Pol	Azimuth (deg)	Corr. (dB/m)
67.466250	31.75	40.00	8.25	200.0	H	94.0	15
94.444375	25.15	43.50	18.35	200.0	H	338.0	15
134.941875	29.69	43.50	13.81	200.0	H	260.0	13
148.521875	28.56	43.50	14.94	200.0	H	244.0	12
240.005000	31.15	46.00	14.85	200.0	H	0.0	17
296.931875	34.07	46.00	11.93	100.0	H	5.0	19

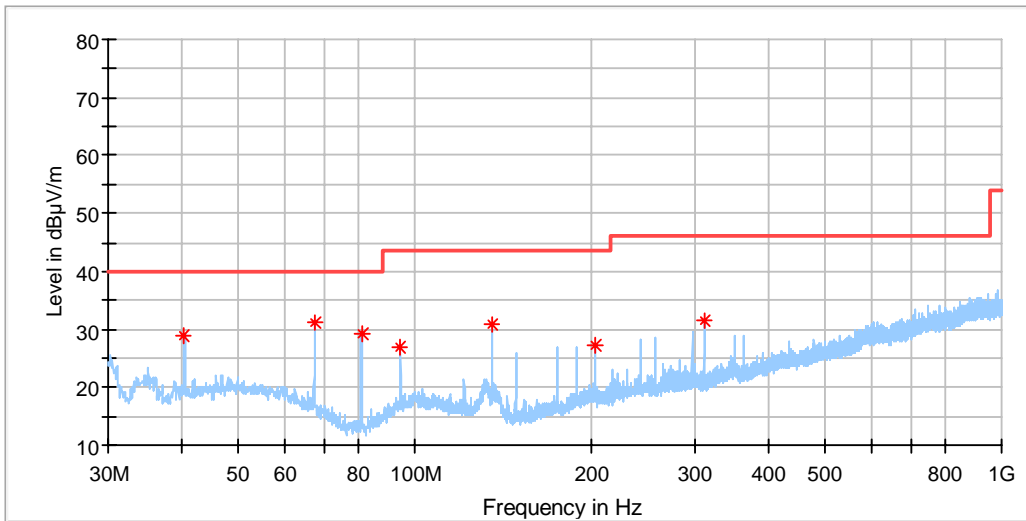

Frequency (MHz)	MaxPeak (dBµV/m)	Limit (dBµV/m)	Margin (dB)	Height (cm)	Pol	Azimuth (deg)	Corr. (dB/m)
40.427500	28.81	40.00	11.19	100.0	V	134.0	17
67.466250	31.04	40.00	8.96	200.0	V	243.0	15
80.985625	29.09	40.00	10.91	200.0	V	0.0	11
94.444375	27.04	43.50	16.46	100.0	V	181.0	15
134.941875	30.84	43.50	12.66	100.0	V	181.0	13
202.478125	27.10	43.50	16.40	100.0	V	142.0	16
310.451250	31.55	46.00	14.45	200.0	V	190.0	19

2408MHz Test Result

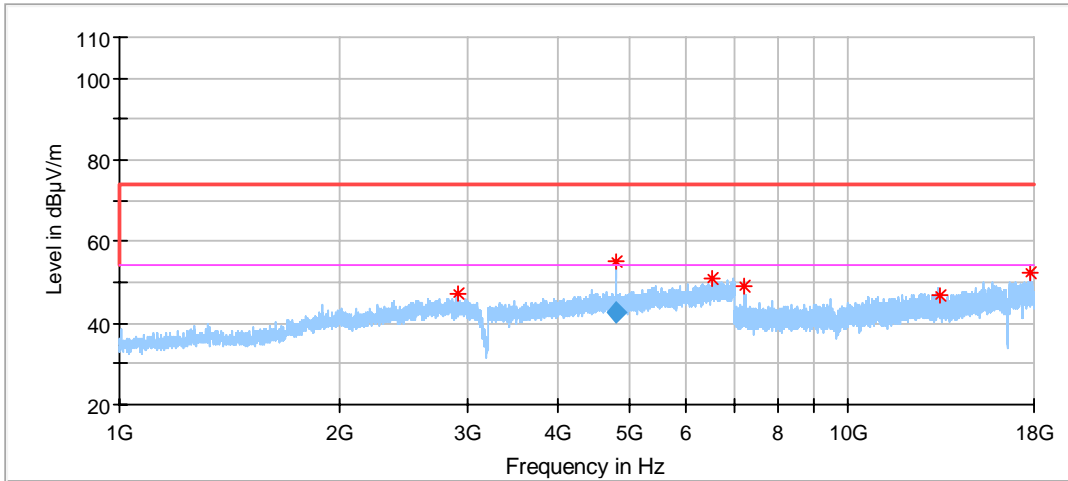

Frequency (MHz)	MaxPeak (dBµV/m)	Limit (dBµV/m)	Margin (dB)	Height (cm)	Pol	Azimuth (deg)	Corr. (dB/m)
2917.000000	47.15	74.00	26.85	150.0	H	119.0	-2.7
4817.000000	55.10	74.00	18.90	150.0	H	0.0	2.5
6521.500000	51.12	74.00	22.88	150.0	H	62.0	6.5
7222.500000	48.99	74.00	25.01	150.0	H	336.0	6.2
13398.500000	46.81	74.00	27.19	150.0	H	62.0	9.8
17772.500000	52.27	74.00	21.73	150.0	H	5.0	17.6
Frequency (MHz)	Average (dBµV/m)	Limit (dBµV/m)	Margin (dB)	Height (cm)	Pol	Azimuth (deg)	Corr. (dB/m)
4817.000000	42.50	54.00	11.50	150.0	H	0.0	2.5

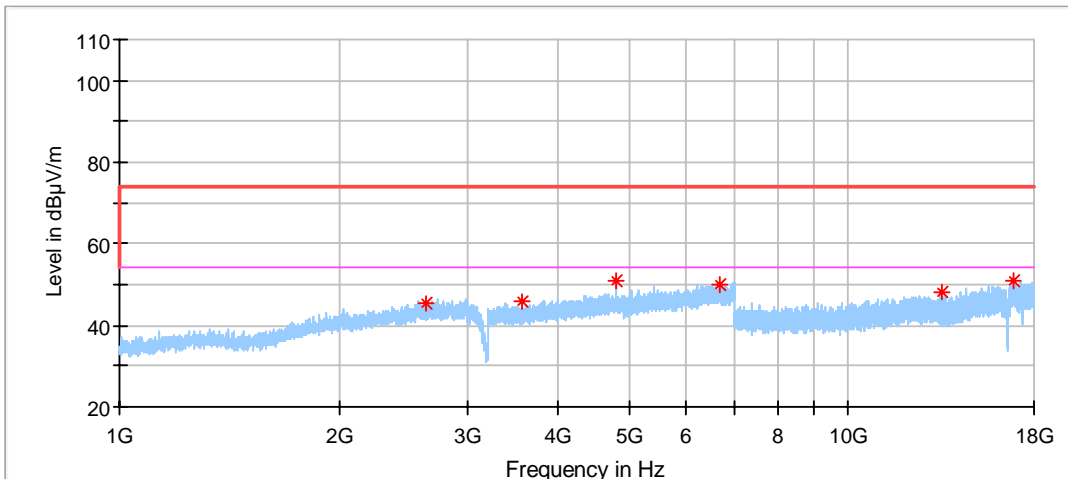

Frequency (MHz)	MaxPeak (dBµV/m)	Limit (dBµV/m)	Margin (dB)	Height (cm)	Pol	Azimuth (deg)	Corr. (dB/m)
2630.500000	45.61	74.00	28.39	150.0	V	216.0	-3.2
3562.000000	45.82	74.00	28.18	150.0	V	182.0	-0.9
4815.500000	50.93	74.00	23.07	150.0	V	188.0	2.5
6656.000000	50.02	74.00	23.98	150.0	V	268.0	6.7
13429.500000	48.19	74.00	25.81	150.0	V	38.0	9.7
16906.000000	50.79	74.00	23.21	150.0	V	140.0	16.5

2440MHz Test Result

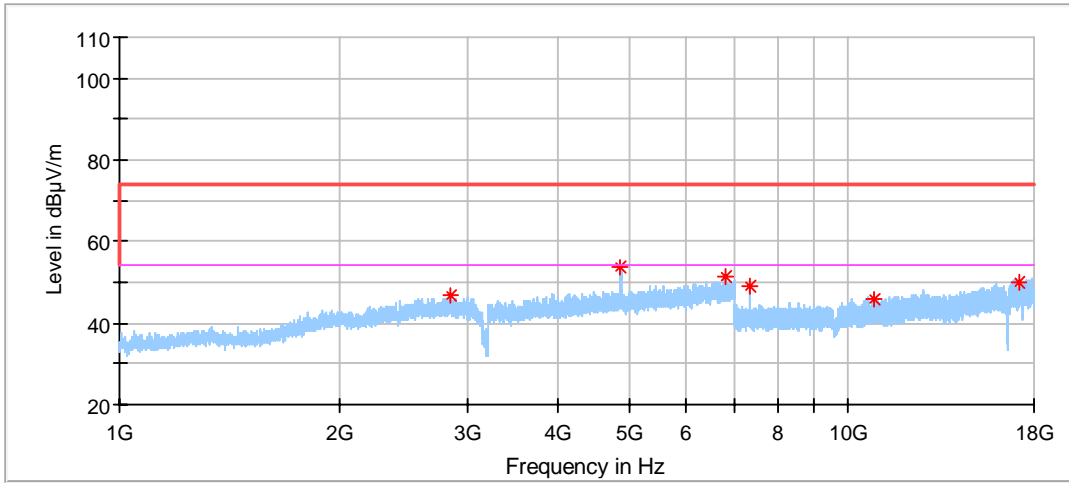

Frequency (MHz)	MaxPeak (dBµV/m)	Limit (dBµV/m)	Margin (dB)	Height (cm)	Pol	Azimuth (deg)	Corr. (dB/m)
2843.500000	46.99	74.00	27.01	150.0	H	196.0	-2.9
4879.000000	53.68	74.00	20.32	150.0	H	348.0	2.5
6792.000000	51.55	74.00	22.45	150.0	H	141.0	6.6
7318.500000	49.25	74.00	24.75	150.0	H	222.0	6.5
10837.500000	45.79	74.00	28.21	150.0	H	29.0	7.9
17152.500000	50.13	74.00	23.87	150.0	H	222.0	16.9

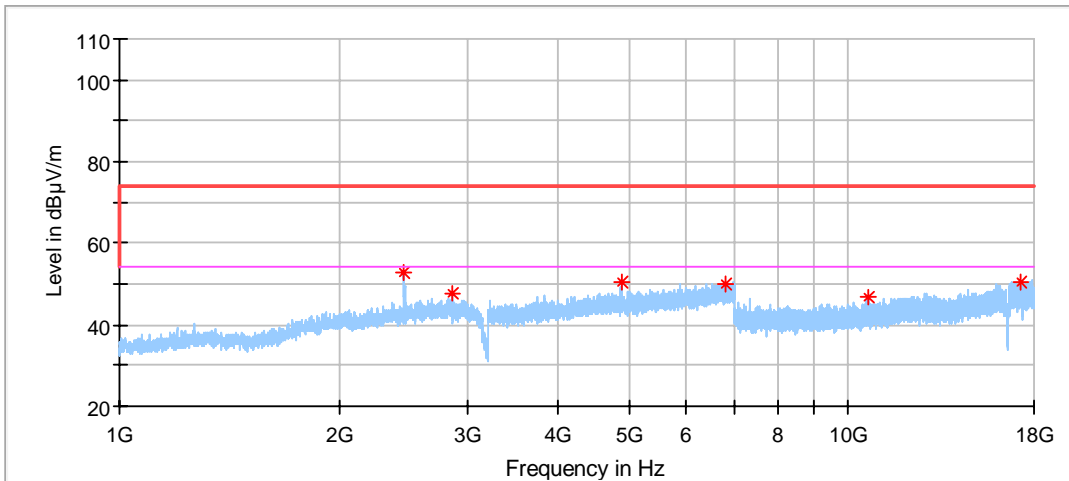

Frequency (MHz)	MaxPeak (dBµV/m)	Limit (dBµV/m)	Margin (dB)	Height (cm)	Pol	Azimuth (deg)	Corr. (dB/m)
2460.500000	52.67	74.00	21.33	150.0	V	236.0	-3.5
2860.000000	47.59	74.00	26.41	150.0	V	117.0	-2.9
4881.000000	50.52	74.00	23.48	150.0	V	177.0	2.6
6800.000000	50.20	74.00	23.80	150.0	V	69.0	6.7
10667.000000	46.90	74.00	27.10	150.0	V	55.0	8.5
17221.000000	50.51	74.00	23.49	150.0	V	333.0	17.4

2474MHz Test Result

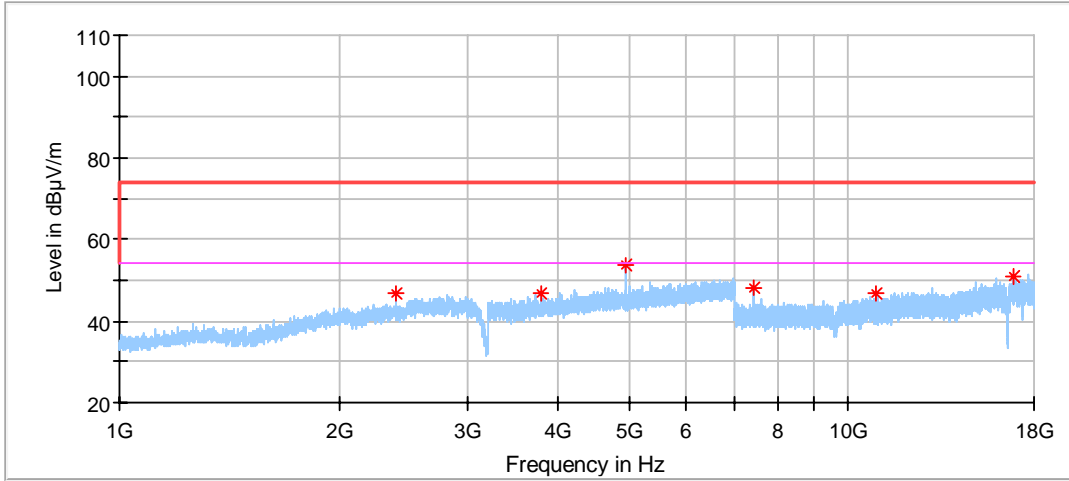

Frequency (MHz)	MaxPeak (dBµV/m)	Limit (dBµV/m)	Margin (dB)	Height (cm)	Pol	Azimuth (deg)	Corr. (dB/m)
2392.500000	46.58	74.00	27.42	150.0	H	335.0	-3.9
3792.500000	46.64	74.00	27.36	150.0	H	19.0	0.1
4949.000000	53.72	74.00	20.28	150.0	H	4.0	1.6
7420.500000	48.34	74.00	25.66	150.0	H	312.0	6.0
10910.500000	46.84	74.00	27.16	150.0	H	312.0	7.9
16833.000000	50.97	74.00	23.03	150.0	H	48.0	16.4

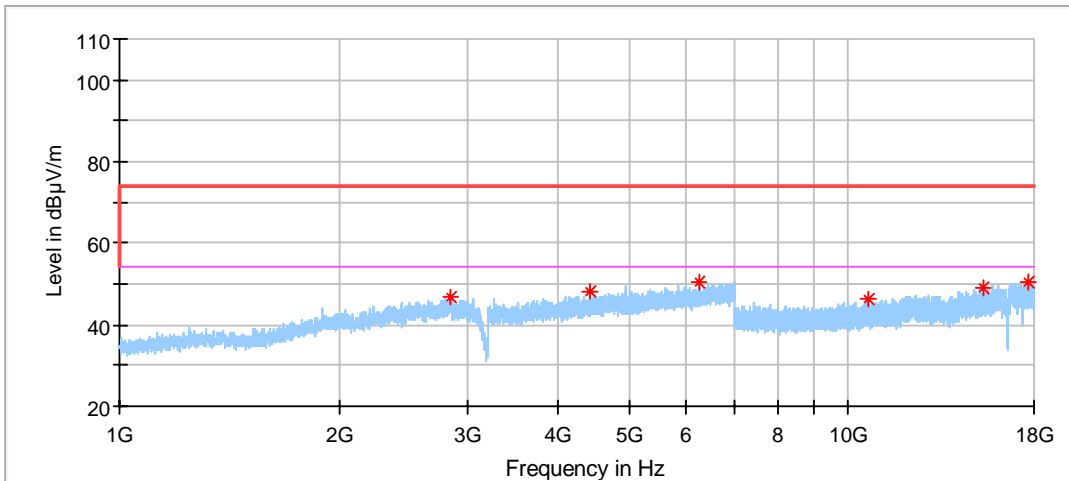

Frequency (MHz)	MaxPeak (dBµV/m)	Limit (dBµV/m)	Margin (dB)	Height (cm)	Pol	Azimuth (deg)	Corr. (dB/m)
2849.000000	46.89	74.00	27.11	150.0	V	314.0	-3.0
4414.500000	47.96	74.00	26.04	150.0	V	141.0	2.2
6244.500000	50.29	74.00	23.71	150.0	V	257.0	5.8
10660.000000	46.48	74.00	27.52	150.0	V	262.0	8.2
15338.000000	49.19	74.00	24.81	150.0	V	173.0	12.7
17720.000000	50.58	74.00	23.42	150.0	V	140.0	17.8



Remark:

- (1) Data of measurement within this frequency range shown “-” in the table above means the reading of emissions are attenuated more than 20db below the permissible limits or the field strength is too small to be measured.
- (2) Level=Reading Level + Correction Factor
Correction Factor=Antenna Factor + Cable Loss – Pre-amplifier
(The Reading Level is recorded by software which is not shown in the sheet)
- (3) The test was applied up to 25GHz, only 30-18GHz test data were put into report, because the reading of 18GHz -25GHz emissions are attenuated more than 20db below the permissible limits or the field strength.

10 Test Equipment List

List of Test Instruments

Radiated Emission Test

Description	Manufacturer	Model no.	Serial no.	cal. due date
EMI Test Receiver	Rohde & Schwarz	ESR 26	101031	2020-6-28
Trilog Super Broadband Test Antenna	Schwarzbeck	VULB 9163	708	2020-6-28
Horn Antenna	Rohde & Schwarz	HF907	102295	2020-7-5
Pre-amplifier	Rohde & Schwarz	SCU 18	102230	2020-6-28
Attenuator	Agilent	8491A	MY39264334	2020-6-28
3m Semi-anechoic chamber	TDK	9X6X6	----	2020-7-7
Test software	Rohde & Schwarz	EMC32	Version 9.15.00	N/A

TS8997 Test System

Description	Manufacturer	Model no.	Serial no.	cal. due date
Signal Analyzer	Rohde & Schwarz	OSP120/OSP-B157	101030	2020-6-28
10dB Attenuator	R&S	DNF	DNF-002	2020-6-28



11 System Measurement Uncertainty

For a 95% confidence level, the measurement expanded uncertainties for defined systems, in accordance with the recommendations of ISO 17025 were:

System Measurement Uncertainty	
Test Items	Extended Uncertainty
Uncertainty for Conducted Emission 150kHz-30MHz (for test using High Voltage Probe TK9420(VT9420))	3.21 dB
Uncertainty for Radiated Emission in 3m chamber 30MHz-1000MHz	Horizontal: 5.12dB; Vertical: 5.10dB;
Uncertainty for Radiated Emission in 3m chamber 1000MHz-18000MHz	Horizontal: 5.01dB; Vertical: 5.00dB;
Uncertainty for Conducted RF test with TS 8997	RF Power Conducted: 1.16dB Frequency test involved: 0.6x10 ⁻⁷ or 1%