

AMP30TT Product Label (for US, LA and possibly CA)

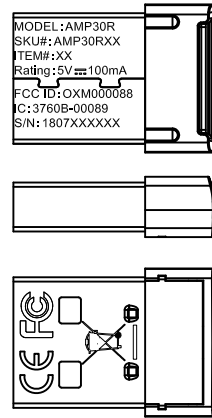

AMP30GL Product Label (黑色版)

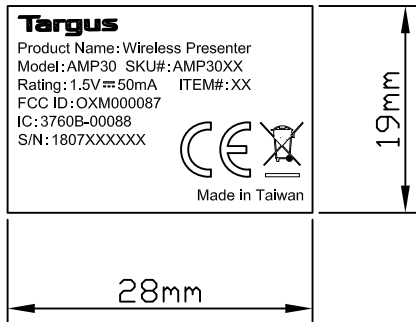
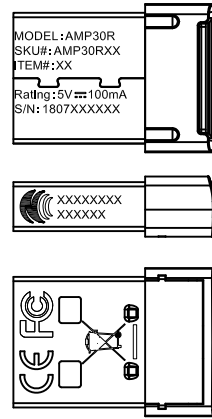

AMP3001GL Product Label (白色版)

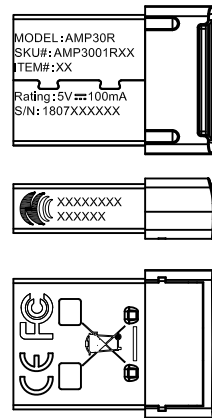
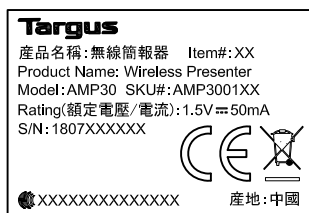

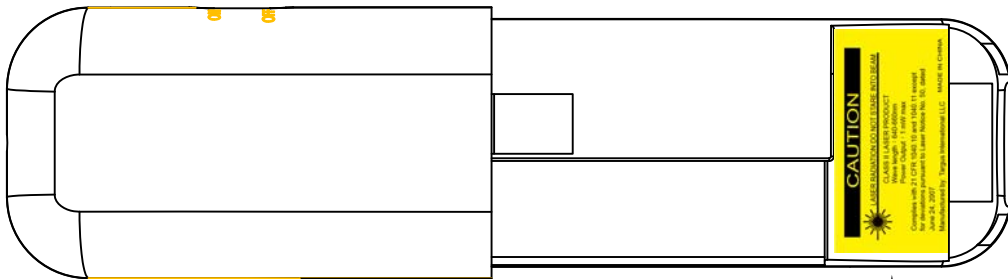

CAUTION LABEL 粘貼位置

For AMP30TT



For AMP30GL



比例 2: 1



比例 2: 1

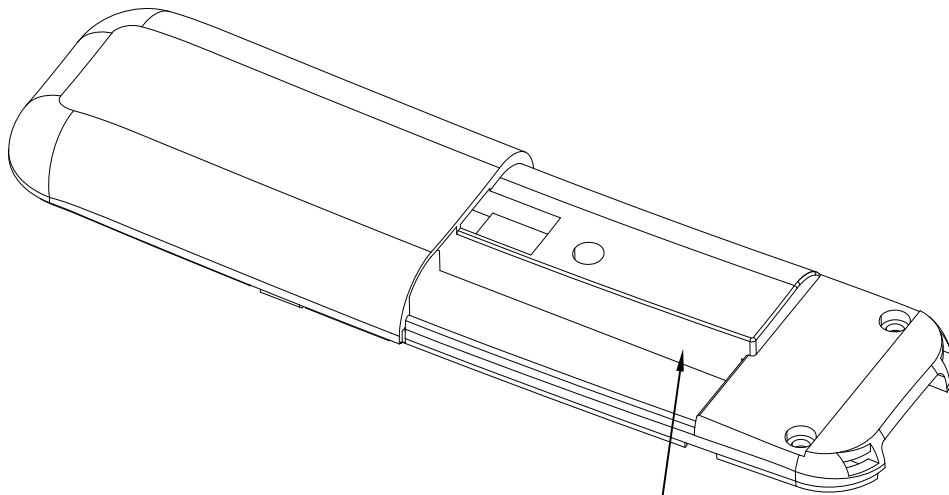

IEC Laser caution 粘貼位置

