

# **FCC RADIO TEST REPORT**

## **FCC ID: OXGZW1502**

**Product** : Z-wave power strip (2 port)

**Trade Name** : Show Home

**Model Name** : ZW1502

**Serial Model** : N/A

### **Prepared for**

Willis Electric CO., Ltd.

No.504-1, Chung-Hua Road, Sec.4 Hsin Chu, 300 Taiwan

### **Prepared by**

DongGuan Precise Testing Service Co., Ltd.

Room 203-204, 2F, Xinye Building, No.67 Shijing, Guanzhang  
Road, Dongguan, China

## TEST RESULT CERTIFICATION

**Applicant's name** ..... : Willis Electric CO., Ltd.  
**Address** ..... : No.504-1, Chung-Hua Road, Sec.4 Hsin Chu, 300 Taiwan  
**Manufacturer's Name**..... : Willis Electric CO., Ltd.  
**Address** ..... : No.504-1, Chung-Hua Road, Sec.4 Hsin Chu, 300 Taiwan

### Product description

**Product name** ..... : Z-wave power strip (2 port)  
**Model and/or type reference** : ZW1502  
**Rating(s)** ..... : AC 120V/60Hz

**Standards** ..... : FCC Part15.231

**Test procedure** ..... ANSI C63.4-2003

This device described above has been tested by PTS, and the test results show that the equipment under test (EUT) is in compliance with the FCC requirements. And it is applicable only to the tested sample identified in the report.

This report shall not be reproduced except in full, without the written approval of PTS, this document may be altered or revised by PTS, personal only, and shall be noted in the revision of the document.

**Date of Test** ..... :  
**Date (s) of performance of tests** ..... : 20 May 2014 ~03 Jun. 2014  
**Date of Issue**..... : 03 Jun. 2014  
**Test Result**..... : **Pass**

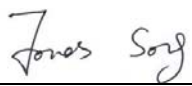
**Testing Engineer** :   
Assistant

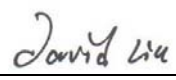
**Technical Manager** :   
Supervisor

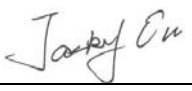
**Authorized Signatory** :   
Jacky Ou / Manager

<b>Table of Contents</b>	<b>Page</b>
<b>1 . SUMMARY OF TEST RESULTS</b>	<b>4</b>
1.1 TEST FACILITY	5
1.2 MEASUREMENT UNCERTAINTY	5
<b>2 . GENERAL INFORMATION</b>	<b>6</b>
2.1 GENERAL DESCRIPTION OF EUT	6
2.2 DESCRIPTION OF TEST MODES	7
2.3 BLOCK DIGRAM SHOWING THE CONFIGURATION OF SYSTEM TESTED	8
2.4 DESCRIPTION OF SUPPORT UNITS(CONDUCTED MODE)	9
2.5 EQUIPMENTS LIST FOR ALL TEST ITEMS	10
<b>3 . ANTENNA REQUIREMENT</b>	<b>11</b>
3.1 STANDARD REQUIREMENT	11
3.2 EUT ANTENNA	11
3.3 CONDUCTED EMISSION MEASUREMENT	12
3.3.1 POWER LINE CONDUCTED EMISSION LIMITS	12
3.3.2 TEST PROCEDURE	13
3.3.3 DEVIATION FROM TEST STANDARD	13
3.3.4 TEST SETUP	13
3.2.5 TEST RESULT	14
3.4 RADIATED EMISSION MEASUREMENT	16
3.4.1 RADIATED EMISSION LIMITS	16
3.4.2 TEST PROCEDURE	17
3.4.3 DEVIATION FROM TEST STANDARD	17
3.4.4 TEST SETUP	18
3.4.5 TEST RESULTS (BLOW 30MHZ)	20
3.4.6 TEST RESULTS	21
<b>4 . BANDWIDTH TEST</b>	<b>23</b>
4.1 TEST PROCEDURE	23
4.2 DEVIATION FROM STANDARD	23
4.3 TEST SETUP	23
4.4 TEST RESULTS	24
<b>5 . TRANSMITTER TIMEOUT</b>	<b>25</b>
5.1 REQUIREMENTS	25
<b>6 . EUT TEST PHOTO</b>	<b>27</b>
<b>APPENDIX-PHOTOGRAPHS OF EUT CONSTRUCTIONAL DETAILS</b>	

## 1. SUMMARY OF TEST RESULTS

Test procedures according to the technical standards:

<b>FCC Part15, Subpart C (15.231)</b>			
<b>Standard Section</b>	<b>Test Item</b>	<b>Judgment</b>	<b>Remark</b>
15.207	Conducted Emission	Pass	
15.203	Antenna Requirement	Pass	
15.231	Radiated Spurious Emission	Pass	
15.231	Occupied Bandwidth	Pass	
15.231	Transmitter Timeout	Pass	

### 1.1 TEST FACILITY

NTEK Testing Technology Co., Ltd

Add. : 1/F, Building E, Fenda Science Park, Sanwei Community, Xixiang Street, Bao'an District, Shenzhen P.R. China.

FCC Registration No.:238937; IC Registration No.:9270A-1

### 1.2 MEASUREMENT UNCERTAINTY

The reported uncertainty of measurement  $y \pm U$ , where expanded uncertainty  $U$  is based on a standard uncertainty multiplied by a coverage factor of  $k=2$ , providing a level of confidence of approximately **95 %**.

No.	Item	Uncertainty
1	Conducted Emission Test	$\pm 1.38\text{dB}$
2	RF power,conducted	$\pm 0.16\text{dB}$
3	Spurious emissions,conducted	$\pm 0.21\text{dB}$
4	All emissions,radiated(<1G)	$\pm 4.68\text{dB}$
5	All emissions,radiated(>1G)	$\pm 4.89\text{dB}$
6	Temperature	$\pm 0.5^{\circ}\text{C}$
7	Humidity	$\pm 2\%$

## 2. GENERAL INFORMATION

### 2.1 GENERAL DESCRIPTION OF EUT

Equipment	Z-wave power strip (2 port)	
Model Name	ZW1502	
Serial Model	N/A	
Model Difference	N/A	
Product Description	The EUT is a Z-wave power strip (2 port)	
	Product Type	Z-wave power strip (2 port)
	Operation Frequency:	908.42MHz
	Modulation Type:	ASK
	Antenna Designation:	Chip antenna
	Antenna Gain(Peak)	0 dBi
	Output Power:	78.69 dBuV/m (PK Max.)
Based on the application, features, or specification exhibited in User's Manual, the EUT is considered as an ITE/Computing Device. More details of EUT technical specification, please refer to the User's Manual.		
Channel List	N/A	
Adapter	N/A	
Battery	N/A	

Note:

1. For a more detailed features description, please refer to the manufacturer's specifications or the User's Manual.

2.

Table for Filed Antenna

Ant	Brand	Model Name	Antenna Type	Connector	Gain (dBi)	NOTE
1	N/A	N/A	Chip Antenna	NA	0	Antenna

## 2.2 DESCRIPTION OF TEST MODES

To investigate the maximum EMI emission characteristics generates from EUT, the test system was pre-scanning tested base on the consideration of following EUT operation mode or test configuration mode which possible have effect on EMI emission level. Each of these EUT operation mode(s) or test configuration mode(s) mentioned above was evaluated respectively.

Pretest Mode	Description
Mode 1	TX

For Conducted Emission	
Final Test Mode	Description
Mode 1	TX

For Radiated Emission	
Final Test Mode	Description
Mode 1	TX

### 2.3 BLOCK DIGRAM SHOWING THE CONFIGURATION OF SYSTEM TESTED

Radiated Spurious Emission Test

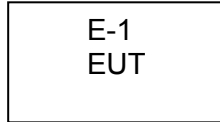

CE Test

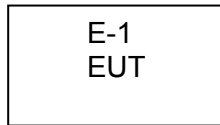



## 2.4 DESCRIPTION OF SUPPORT UNITS(CONDUCTED MODE)

The EUT has been tested as an independent unit together with other necessary accessories or support units. The following support units or accessories were used to form a representative test configuration during the tests.

Item	Equipment	Mfr/Brand	Model/Type No.	Series No.	Note
E-1	Z-wave power strip (2 port)	Show Home	ZW1502	N/A	EUT

Item	Shielded Type	Ferrite Core	Length	Note

**Note:**

- (1) The support equipment was authorized by Declaration of Confirmation.
- (2) For detachable type I/O cable should be specified the length in cm in 『Length』 column.

## 2.5 EQUIPMENTS LIST FOR ALL TEST ITEMS

### Radiation Test equipment

Item	Kind of Equipment	Manufacturer	Type No.	Serial No.	Last calibration	Calibrated until	Calibration period
1	Spectrum Analyzer	Agilent	E4407B	MY45108040	2013.07.06	2014.07.05	1 year
2	Test Receiver	R&S	ESPI	101318	2013.06.07	2014.06.06	1 year
3	Bilog Antenna	TESEQ	CBL6111D	31216	2013.07.06	2014.07.05	1 year
4	50Ω Coaxial Switch	Anritsu	MP59B	6200264416	2013.06.07	2014.06.06	1 year
5	Spectrum Analyzer	ADVANTEST	R3132	150900201	2013.06.07	2014.06.06	1 year
6	Horn Antenna	EM	EM-AH-10180	2011071402	2013.07.06	2014.07.05	1 year
7	Horn Ant	Schwarzbeck	BBHA 9170	9170-181	2013.07.06	2014.07.05	1 year
8	Amplifier	EM	EM-30180	060538	2013.12.22	2014.12.21	1 year
9	Loop Antenna	ARA	PLA-1030/B	1029	2013.06.08	2014.06.07	1 year
10	Power Meter	R&S	NRVS	100696	2013.07.06	2014.07.05	1 year
11	Power Sensor	R&S	URV5-Z4	0395.1619.05	2013.07.06	2014.07.05	1 year

### Conduction Test equipment

Item	Kind of Equipment	Manufacturer	Type No.	Serial No.	Last calibration	Calibrated until	Calibration period
1	Test Receiver	R&S	ESCI	101160	2013.06.06	2014.06.05	1 year
2	LISN	R&S	ENV216	101313	2013.08.24	2014.08.23	1 year
3	LISN	EMCO	3816/2	00042990	2013.08.24	2014.08.23	1 year
4	50Ω Coaxial Switch	Anritsu	MP59B	6200264417	2013.06.07	2014.06.06	1 year
5	Passive Voltage Probe	R&S	ESH2-Z3	100196	2013.06.07	2014.06.06	1 year
6	Absorbing clamp	R&S	MOS-21	100423	2013.06.08	2014.06.07	1 year

### **3. ANTENNA REQUIREMENT**

#### **3.1 STANDARD REQUIREMENT**

15.203 requirement: For intentional device, according to 15.203: an intentional radiator shall be designed to ensure that no antenna other than that furnished by the responsible party shall be used with the device.

#### **3.2 EUT ANTENNA**

The EUT antenna is integral Antenna. It comply with the standard requirement.

### 3.3 CONDUCTED EMISSION MEASUREMENT

#### 3.3.1 POWER LINE CONDUCTED EMISSION Limits (Frequency Range 150KHz-30MHz)

FREQUENCY (MHz)	Class A (dBuV)		Class B (dBuV)		Standard
	Quasi-peak	Average	Quasi-peak	Average	
0.15 -0.5			66 - 56 *	56 - 46 *	CISPR
0.50 -5.0			56.00	46.00	CISPR
5.0 -30.0			60.00	50.00	CISPR

0.15 -0.5			66 - 56 *	56 - 46 *	LP002.
0.50 -5.0			56.00	46.00	LP002.
5.0 -30.0			60.00	50.00	LP002.

Note:

- (1) The tighter limit applies at the band edges.
- (2) The limit of " \* " marked band means the limitation decreases linearly with the logarithm of the frequency in the range.

The following table is the setting of the receiver

Receiver Parameters	Setting
Attenuation	10 dB
Start Frequency	0.15 MHz
Stop Frequency	30 MHz
IF Bandwidth	9 kHz

### 3.3.2 TEST PROCEDURE

- a. The EUT was placed 0.4 meters from the horizontal ground plane with EUT being connected to the power mains through a line impedance stabilization network (LISN). All other support equipments powered from additional LISN(s). The LISN provide 50 Ohm/ 50uH of coupling impedance for the measuring instrument.
- b. Interconnecting cables that hang closer than 40 cm to the ground plane shall be folded back and forth in the center forming a bundle 30 to 40 cm long.
- c. I/O cables that are not connected to a peripheral shall be bundled in the center. The end of the cable may be terminated, if required, using the correct terminating impedance. The overall length shall not exceed 1 m.
- d. LISN at least 80 cm from nearest part of EUT chassis.
- e. For the actual test configuration, please refer to the related Item –EUT Test Photos.

### 3.3.3 DEVIATION FROM TEST STANDARD

No deviation

### 3.3.4 TEST SETUP

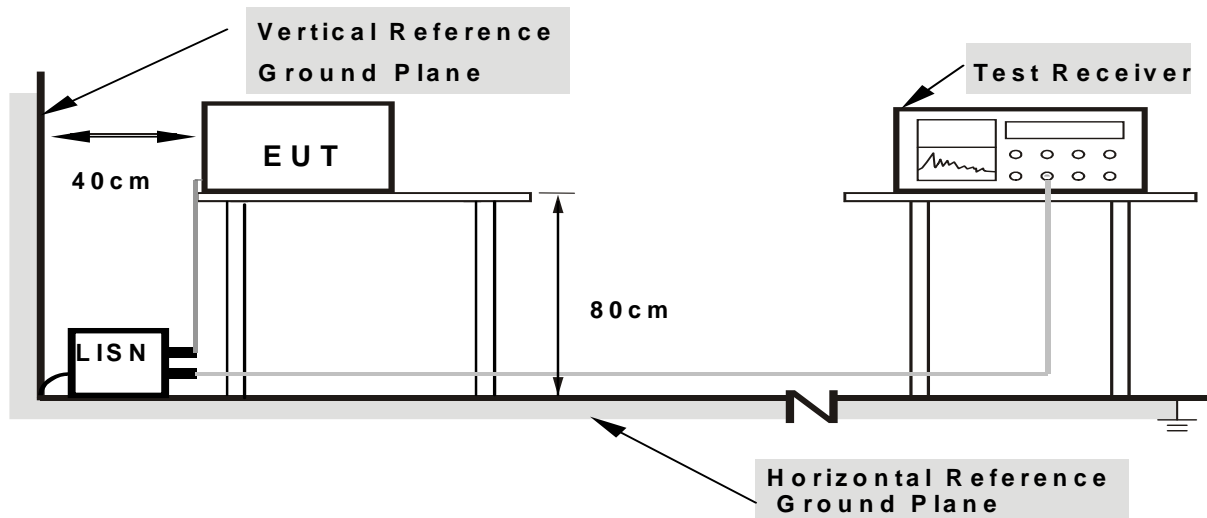

**Note: 1. Support units were connected to second LISN.**

**2. Both of LISNs (AMN) are 80 cm from EUT and at least 80 cm from other units and other metal planes**

### 3.2.5 TEST RESULT

EUT :	Z-wave power strip (2 port)	Model Name. :	ZW1502
Temperature :	26 °C	Relative Humidity :	54%
Pressure :	1010hPa	Phase :	L
Test Voltage :	AC 120V/60Hz	Test Mode :	1

Freq. (MHz)	Reading (dBuV)	Factor (dBuV)	Measurement (dBuV)	Limit (dBuV)	Over (dB)	Detector
0.5540	13.17	10.40	23.57	46.00	-22.43	AVG
0.6180	23.46	10.41	33.87	56.00	-22.13	QP
26.6260	14.29	10.65	24.94	50.00	-25.06	AVG
29.2340	18.52	10.58	29.10	60.00	-30.90	QP

Remark:

1. All readings are Quasi-Peak and Average values.
2. Factor = Insertion Loss + Cable Loss.
3. N/A means All Data have pass Limit.

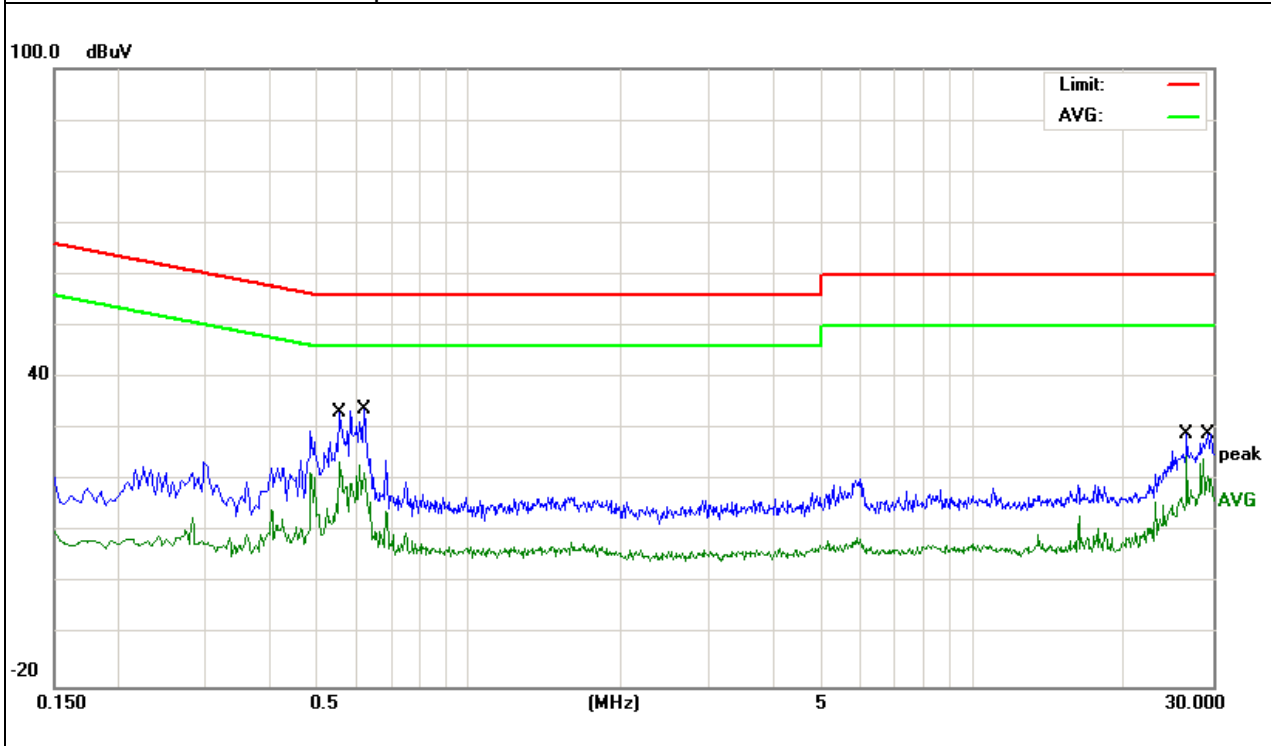

EUT :	Z-wave power strip (2 port)	Model Name. :	ZW1502
Temperature :	26 °C	Relative Humidity :	54%
Pressure :	1010hPa	Phase :	N
Test Voltage :	AC 120V/60Hz	Test Mode :	1

Freq. (MHz)	Reading (dBuV)	Factor (dBuV)	Measurement (dBuV)	Limit (dBuV)	Over (dB)	Detector
0.6180	23.69	10.41	34.10	56.00	-21.90	QP
0.6220	13.98	10.41	24.39	46.00	-21.61	AVG
28.3780	19.08	10.53	29.61	60.00	-30.39	QP
28.6380	14.21	10.56	24.77	50.00	-25.23	AVG

Remark:

1. All readings are Quasi-Peak and Average values.
2. Factor = Insertion Loss + Cable Loss.
3. N/A means All Data have pass Limit.

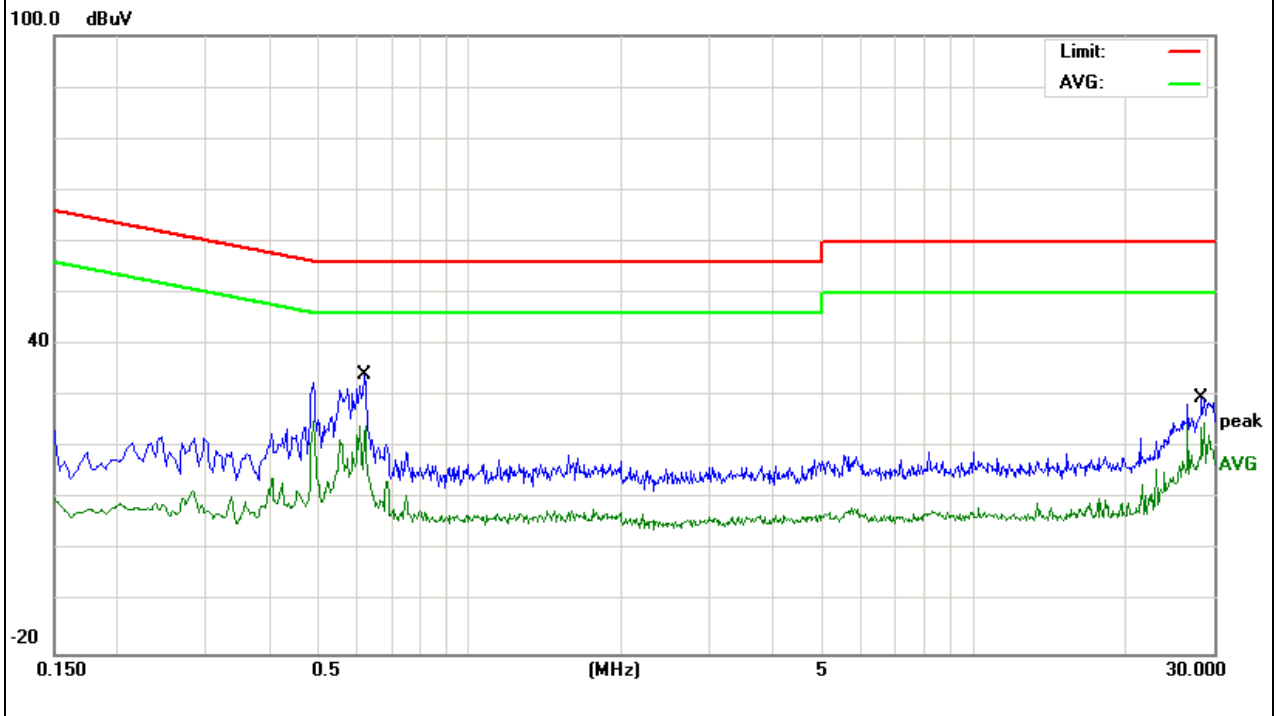

### 3.4 RADIATED EMISSION MEASUREMENT

#### 3.4.1 Radiated Emission Limits ( FCC 15.209 )

Frequencies (MHz)	Field Strength (micorvolts/meter)	Measurement Distance (meters)
0.009~0.490	2400/F(KHz)	300
0.490~1.705	24000/F(KHz)	30
1.705~30.0	30	30
30~88	100	3
88~216	150	3
216~960	200	3
Above 960	500	3

Note:

- (1) The tighter limit applies at the band edges.
- (2) Emission level (dBuV/m)=20log Emission level (uV/m).

#### LIMITS OF RADIATED EMISSION MEASUREMENT ( FCC 15.231)

Fundamental Frequency (MHz)	Field Strength of fundamental (microvolts/meter)	Field Strength of Unwanted Emissions (microvolts/meter)
40.66 - 40.70	2250.00	225.00
70 - 130	1250.00	125.00
130 - 174	1,250 to 3,750 **	125 to 375 **
174 - 260	3750.00	375.00
260 - 470	3,750 to 12,500 **	375 to 1,250 **
Above 470	12500.00	1250.00

Notes:

- (1) \*\* linear interpolations

[Where F is the frequency in MHz, the formulas for calculating the maximum permitted fundamental field strengths are as follows: for the band 130-174 MHz, uV/m at 3 meters = 56.81818(F) - 6136.3636; for the band 260-470 MHz, uV/m at 3 meters = 41.6667(F) - 7083.3333. The maximum permitted unwanted emission level is 20 dB below the maximum permitted fundamental level.]

The limits on the field strength of the spurious emissions in the above table are based on the fundamental frequency of the intentional radiator. Spurious emissions shall be attenuated to the average (or, alternatively, CISPR quasi-peak) limits shown in this table or to the general limits shown in 93 Section 15.209, whichever limit permits a higher field strength.



Spectrum Parameter	Setting
Attenuation	Auto
Start Frequency	1000 MHz
Stop Frequency	10th carrier harmonic
RB / VB (emission in restricted band)	1MHz / 1MHz for Peak

Receiver Parameter	Setting
Attenuation	Auto
Start ~ Stop Frequency	9kHz~150kHz / RB 200Hz for QP
Start ~ Stop Frequency	150kHz~30MHz / RB 9kHz for QP
Start ~ Stop Frequency	30MHz~1000MHz / RB 120kHz for QP

### 3.4.2 TEST PROCEDURE

- a. The measuring distance of at 3 m shall be used for measurements at frequency up to 1GHz. For frequencies above 1GHz, any suitable measuring distance may be used.
- b. The EUT was placed on the top of a rotating table 0.8 meters above the ground at a 3m meter open area test site. The table was rotated 360 degrees to determine the position of the highest radiation.
- c. The height of the equipment or of the substitution antenna shall be 0.8 m; the height of the test antenna shall vary between 1 m to 4 m.
- d. The initial step in collecting conducted emission data is a spectrum analyzer peak detector mode pre-scanning the measurement frequency range. Significant peaks are then marked and then Quasi Peak detector mode re-measured.
- e. If the Peak Mode measured value compliance with and lower than Quasi Peak Mode Limit, the EUT shall be deemed to meet QP Limits and then no additional QP Mode measurement performed.
- f. For the actual test configuration, please refer to the related Item –EUT Test Photos.

Note:

Both horizontal and vertical antenna polarities were tested and performed pretest to three orthogonal axis. The worst case emissions were reported

### 3.4.3 DEVIATION FROM TEST STANDARD

No deviation

### 3.4.4 TEST SETUP

(A) Radiated Emission Test-Up Frequency Below 30MHz

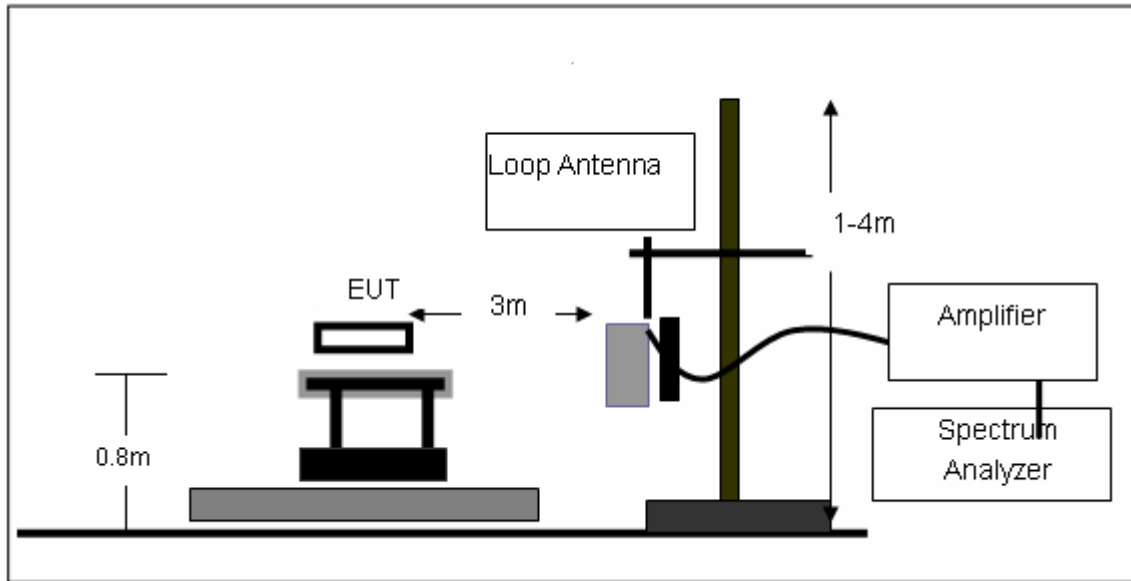

(B) Radiated Emission Test-Up Frequency 30MHz~1GHz

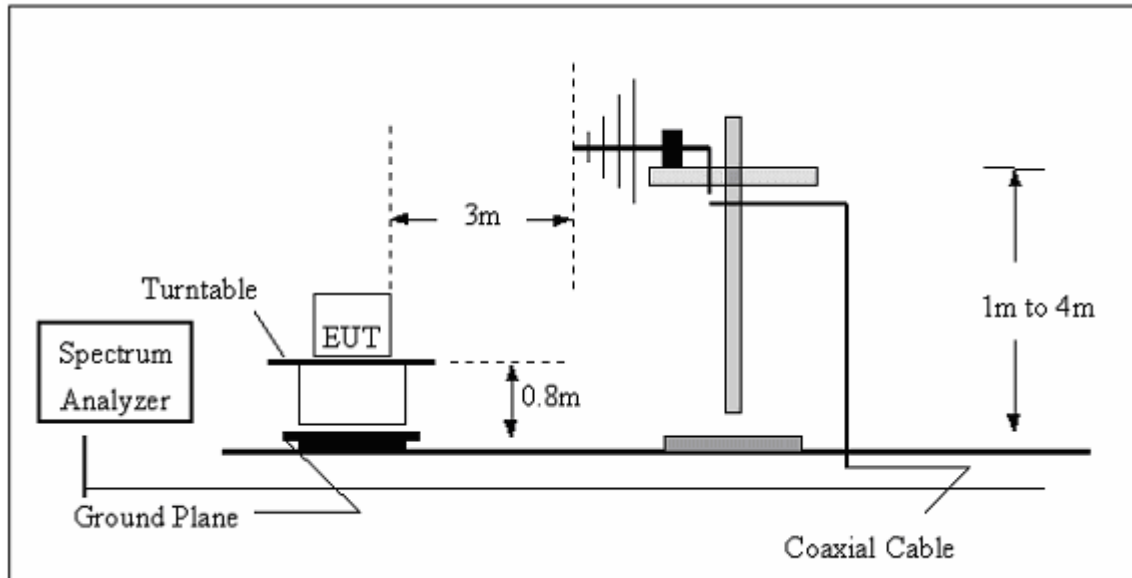

(C) Radiated Emission Test-Up Frequency Above 1GHz

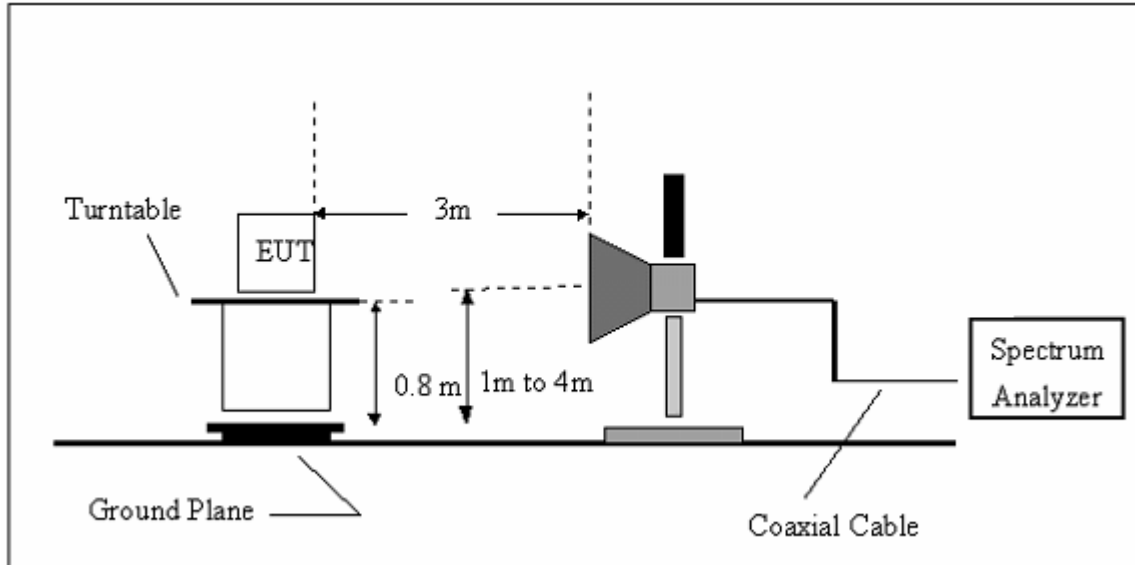

### 3.4.5 TEST RESULTS (BLOW 30MHz)

EUT :	Z-wave power strip (2 port)	Model Name. :	ZW1502
Temperature :	20 °C	Relative Humidity :	48%
Pressure :	1010 hPa	Test Voltage :	AC 120V/60Hz
Test Mode :	TX	Polarization :	--

Freq.	Reading	Limit	Margin	State
(MHz)	(dBuV/m)	(dBuV/m)	(dB)	P/F
--	--	--	--	PASS
--	--	--	--	PASS

**NOTE:**

The amplitude of spurious emissions which are attenuated by more than 20dB below the permissible value has no need to be reported.

Distance extrapolation factor =  $20 \log (\text{specific distance}/\text{test distance})(\text{dB})$ ;

Limit line = specific limits(dBuv) + distance extrapolation factor.

### 3.4.6 TEST RESULTS

Note: Due to the PK results are lower than the AV limits already, the Duty Cycle evaluation and AV measurement are not required for this case.

EUT :	Z-wave power strip (2 port)	Model Name :	ZW1502
Temperature :	20 °C	Relative Humidity :	48%
Pressure :	1010 hPa	Test Voltage :	AC 120V/60Hz
Test Mode :	TX	Polarization :	Horizontal

Frequency	Field Strength	Limit(AV)	State
MHz	dBuV/m (PK)	dBuV/m	
908.82	78.69	82	pass
1817.58	50.16	54	pass
2725.94	47.68	54	pass
3633.15	45.16	54	pass
--	--	54	pass

EUT :	Z-wave power strip (2 port)	Model Name :	ZW1502
Temperature :	20 °C	Relative Humidity :	48%
Pressure :	1010 hPa	Test Voltage :	AC 120V/60Hz
Test Mode :	TX	Polarization :	Vertical

Frequency	Field Strength	Limit(AV)	State
MHz	dBuV/m (PK)	dBuV/m	
908.82	75.67	82	pass
1817.58	51.19	54	pass
2725.94	48.67	54	pass
3633.15	49.68	54	pass
--	--	54.00	pass

**NoTE:**

1. Emissions attenuated more than 20 dB below the permissible value are not reported.
2. \*: Denotes restricted band of operation.

Measurements were made using a peak detector and average detector. Any emission falling within the restricted bands of FCC Part 15 Section 15.205 were compliance with the emission limit of FCC Part 15 Section 15.209.

3. FCC Limit for Average Measurement =  $20\log 12500=82\text{dBuV/m}$

Polar (H/V)	Frequency	Meter Reading	Factor	Emission Level	Limits	Margin	Detector Type
	(MHz)	(dBuV)	(dB)	(dBuV/m)	(dBuV/m)	(dB)	
V	36.57	15.27	10.87	26.14	40	-13.86	QP
V	80.27	17.66	8.97	26.63	40	-13.37	QP
V	188.27	16.52	12.47	28.99	43.5	-14.51	QP
V	543.25	13.75	19.57	33.32	46	-12.68	QP
H	36.57	9.57	10.741	20.311	40	-19.689	QP
H	145.67	10.24	11.21	21.45	43.5	-22.05	QP
H	447.57	9.41	17.35	26.76	46	-19.24	QP
H	587.27	11.37	20.72	32.09	46	-13.91	QP

**Remark:**

Absolute Level= ReadingLevel+ Factor, Margin= Absolute Level - Limit

## 4. BANDWIDTH TEST

### 4.1 TEST PROCEDURE

The bandwidth of the emission shall be no wider than 0.25% of the center frequency for devices operating above 70 MHz and below 900 MHz. For devices operating above 900 MHz, the emission shall be no wider than 0.5% of the center frequency. Bandwidth is determined at the points 20 dB down from the modulated carrier.

### 4.2 DEVIATION FROM STANDARD

No deviation.

### 4.3 TEST SETUP



### 4.4 TEST RESULTS

EUT :	Z-wave power strip (2 port)	Model Name :	ZW1502
Temperature :	26 °C	Relative Humidity :	53%
Pressure :	1020 hPa	Test Power :	AC 120V/60Hz
Test Mode :	TX		

Frequency (MHz)	20 dBc Bandwidth (kHz)	Limit (kHz)
908.42	180	4542

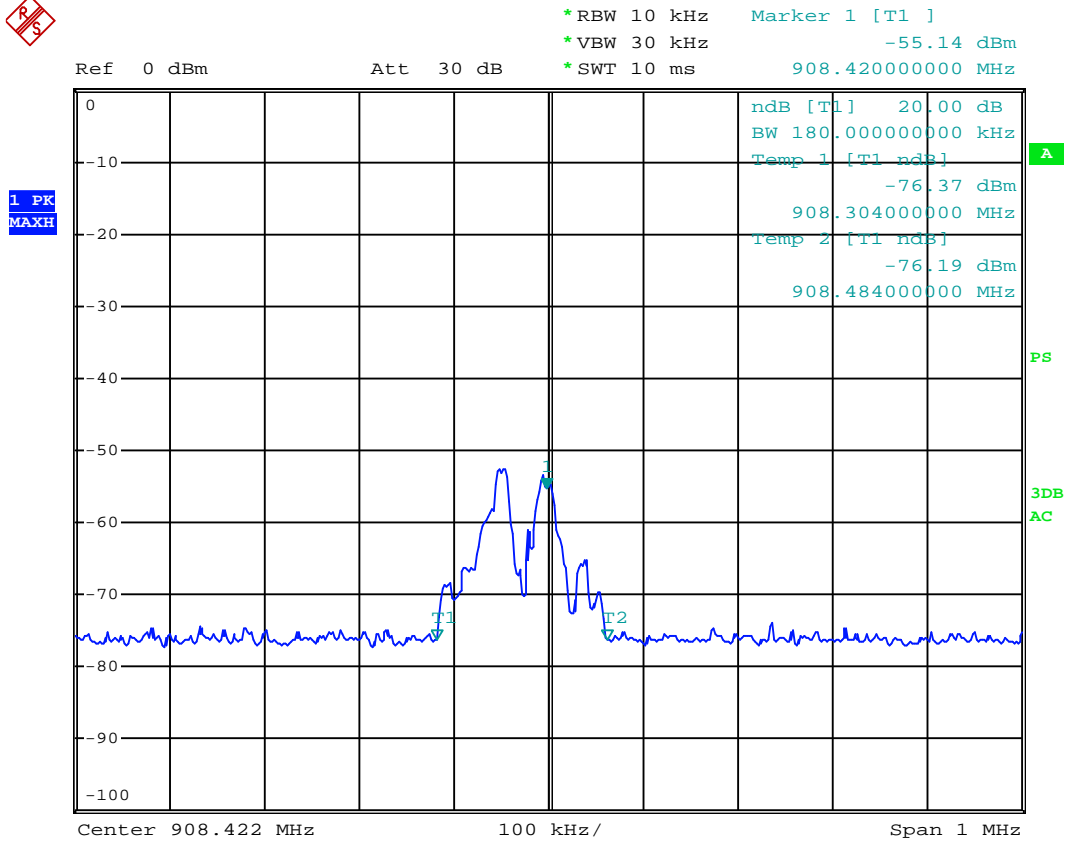

Date: 3.JUN.2014 08:36:10



## 5. TRANSMITTER TIMEOUT

### 5.1 REQUIREMENTS

1 A manually operated transmitter shall employ a switch that will automatically deactivate the transmitter within not more than 5 seconds of being released.

**Result:** The EUT has a manually activated transmitter, please refer to below detail data

2 A transmitter activated automatically shall cease transmission within 5 seconds after activation.

**Result:** The EUT does not have a automatically activated transmitter

3 Periodic transmissions at regular predetermined intervals are not permitted. However, polling or supervision transmissions, including data, to determine system integrity of transmitters used in security or safety applications are allowed if the total duration of transmissions does not exceed more than two seconds per hour for each transmitter. There is no limit on the number of individual transmissions, provided the total transmission time does not exceed two seconds per hour

**Result:** The EUT does not employ periodic transmission.

4 Intentional radiators which are employed for radio control purposes during emergencies involving fire, security, and safety of life, when activated to signal an alarm, may operate during the pendency of the alarm condition.

**Result:** The section is not applicable to EUT.

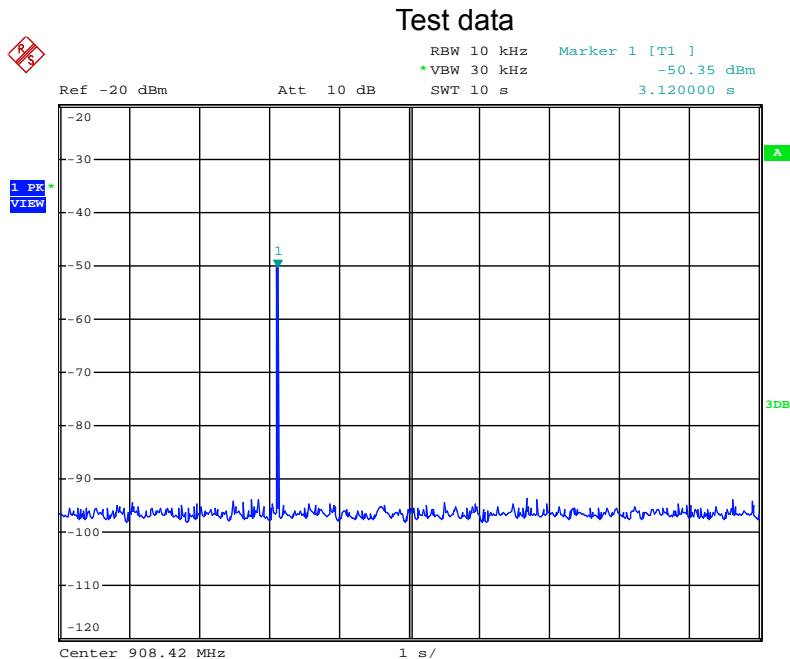

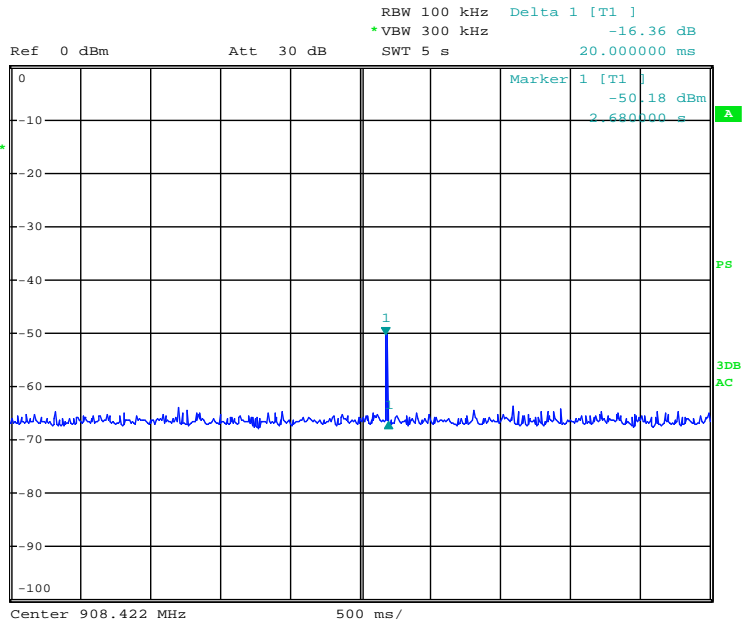

Date: 3.JUN.2014 08:56:19

THE DURATION OF EACH TRANSMISSION	LIMIT	RESULT
0.02s	<5s	PASS

## 6. EUT TEST PHOTO

### Radiated Measurement Photos

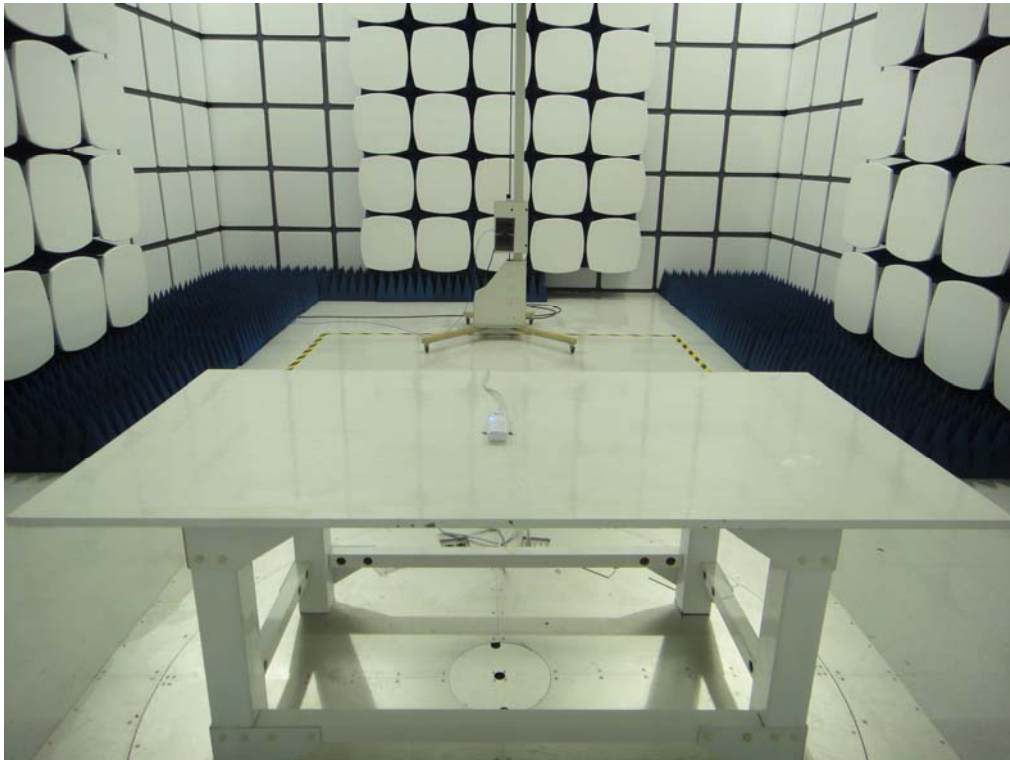
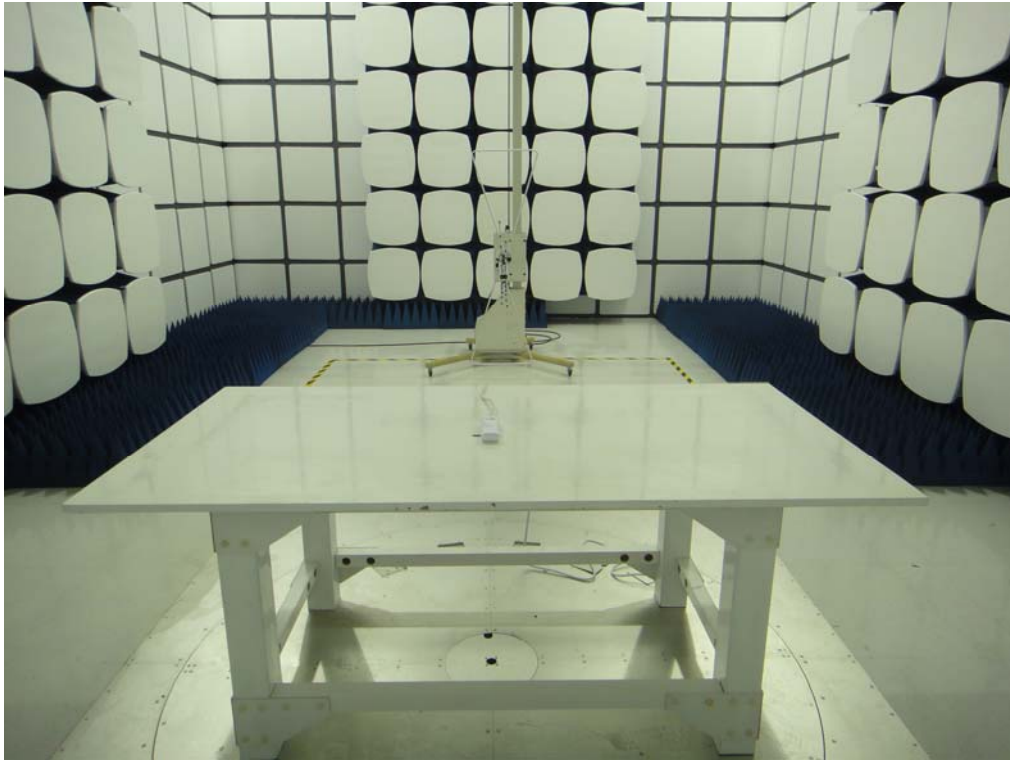

**CE Measurement Photos**

