

HiBOOST Boost Your Bars



User Manual

Commercial 30K Pro
Pro25-5S-LCD

Mobile Signal Booster



CONTENT

WHAT'S INCLUDED	3
HOW IT WORKS	3
HOW TO INSTALL YOUR SIGNAL BOOSTER	3
1.1 Overview	3
1.2 Installation Preparation	4
1.3 How to find the location with the strongest received signal	5
1.4 Install Outdoor Antenna	6
1.5 Install Indoor Antenna	7
1.6 Install Signal Booster	8
1.7 Run coaxial cable	9
1.8 Power up your the Signal Booster	9
SIGNAL BOOSTER STATUS	9
LCD Features	10
LED Status	11
Control Buttons Operation	12
Manual Gain Control (mgc)	12
TROUBLESHOOTING	13
AUTHORIZED KITTING OPTIONS	14
FCC RF EXPOSURE STATEMENT	16
IC RF EXPOSURE STATEMENT	16
WARNING AND STATEMENT	16
SPECIFICATIONS	18
PRODUCT WARRANTY	19

WHAT IS INCLUDED

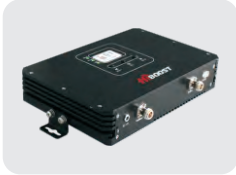

Commercial 30K Pro



12V/3A
AC/DC Power Supply



Booster Mount Hardware

We provide all accessories needed for the signal booster. For more information please visit www.hiboostusa.com.

Warning: Unauthorized antennas, cables, and/or coupling devices are prohibited by new FCC rules. Please contact FCC for details: 1-888-CALL-FCC.

HOW IT WORKS

The HiBoost Commercial 30K Pro signal booster is designed to help mobile users improve signal in homes, offices, and other areas where cellular signal is weak or unreliable. The outdoor antenna receives the signal from the nearest cellular tower, amplifies it, and transmits to the signal booster. Then the indoor antenna will receive the signal and retransmit it to your mobile device. The signals produced by your phone are also amplified by the indoor antenna via the booster and outdoor antenna.

This manual provides simple installation instructions that will have your signal booster kit running in record time.

HOW TO INSTALL YOUR SIGNAL BOOSTER

1.1 Overview

This manual will help you properly install your signal booster kit. It is important to read through all of the installation steps before installing your equipment.

Thoroughly read through the instructions, visualize where all the equipment will need to be installed and do a soft installation by placing the devices where they need to be before mounting any equipment.

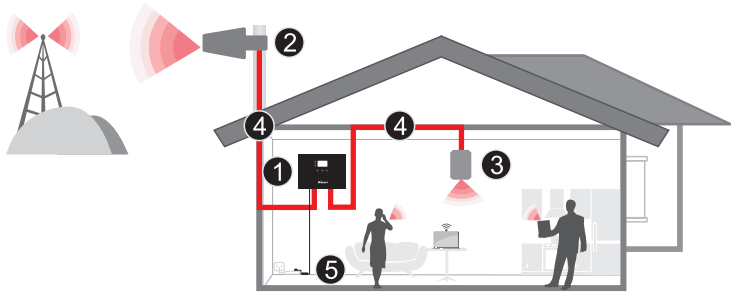

- 1 Commercial 30K Pro Signal Booster
- 2 Outdoor Antenna
- 3 Indoor Antenna
- 4 Cable
- 5 12V/3A, AC/DC Power Supply

1.2 Installation Preparation

Before you install

- Make sure you have sufficient cable length between the proposed outdoor/indoor antenna location and booster connector.
- Make sure the position you install the booster is near to an existing electrical outlet, well ventilated, and away from excessive heat, moisture, and direct sunlight.

Tools Required



Phillips Screwdriver



Drill



Mobile Phone

Before you get started, you will need to plan the layout of your system. This involves finding the location with the strongest received signal from the cellular tower, as well as antenna, booster, and cable placement.

General installation steps:

1. Find the strongest received signal for the location of the outdoor antenna.
2. Install the outdoor antenna on the roof to obtain the strongest downlink

signal from the local cellular towers.

3. Install the indoor antennas where you want to improve the signal level.
4. Mount the booster, connect the cables from the outdoor antenna and indoor antenna at the designated ports, and connect the booster to the AC supply (make sure all the cables are connected before applying power).

1.3 How to find the location with the strongest received signal

The outdoor signal strength the booster receives directly affects the efficiency of the indoor coverage. That is why it is crucially important to install the antenna at a good location and point it properly towards a tower where signal reception is the strongest.

There are many methods that can be used to find the strongest signal from the cellular towers. One is to use the LCD display on the booster that shows the downlink power output of the booster in each band, the other is to use a mobile phone or mobile phone app to test signal strength, and the third is to use a commercially available signal strength meter.

We highly recommend that you use the LCD display on the booster as this method is generally more convenient. However, in situations where the desired carrier's signal is much weaker than the other local signals, using a mobile phone, app or signal level meter can be a more accurate method of homing in on the best signal for installation.

- **LCD Display Method**

Connect the outdoor antenna to the booster's outdoor port. Fix the outdoor antenna on the roof of the building and point it to the nearest cell tower. Then have a look at the gain and output power value displayed on the booster's LCD.

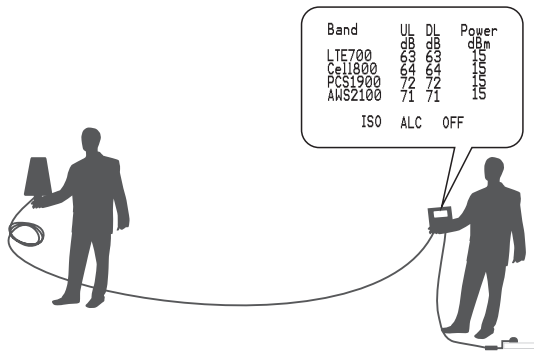

The outdoor antenna receives the strongest signal when the booster's downlink output power reaches its highest level in each band. If the LCD shows maximum



gain and power, and there are not any alarms (no ISO, ALC, OFF legend flashing and no quick flashing green or red in LEDs), it means the present location is the best for ensuring that the booster has maximized performance. The maximum downlink power for Commercial 30K Pro is 15dBm, and the maximum downlink gain is 63-72dB.

Note: These showed values may vary dynamically at times between 1-3 dB which is normal due to outdoor signal conditions.

- **Mobile Phone Method**

You can use a telephone to test signal strength on the top of the building. The number of bars on the network indicator will define approximate strength of the received signal. Normally the roof of the building is the best place to receive the strongest signal. As shown on the drawing below, you need to test the signal in the points from A to E, and select the location with the best signal strength for outdoor installation. It is recommended to use a mobile app that can display in a test mode the signal level in dBm units. It is more accurate than checking the signal bars. For more details refer to <http://blog.hiboostusa.com/signal-strength-measure-instructions/>.

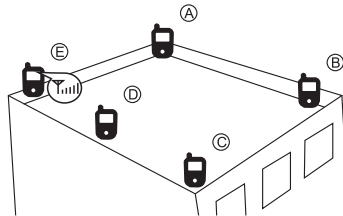

Note: Please try to receive a signal from cell towers that are not overloaded with multiple users. This can be estimated by the population density in the area served by the tower. For example, it is recommended to avoid cell towers near supermarkets, shopping malls, stadiums or any other public places visited by many people regularly. This will help maintain reliable phone call connections and higher speed data services.

Mark the strongest received signal as the installation location and direction for the outdoor antenna.

1.4 Install Outdoor Antenna

Install the outdoor antenna at the the location with the strongest received signal.

IMPORTANT: Testing the signal 3 times in the desired location before installing the outdoor antenna will help ensure the most smooth and stable phone calls and data transmission.

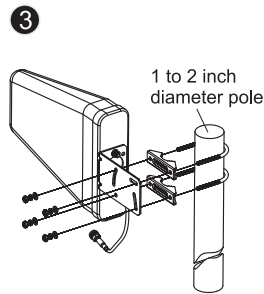
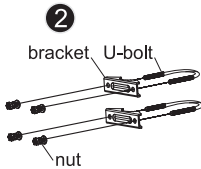
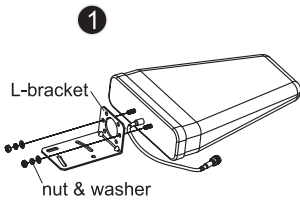

Outdoor wide band directional antenna installation for reference

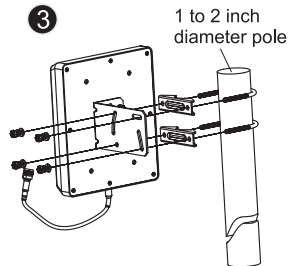
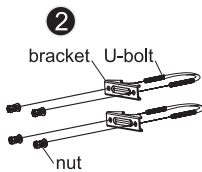
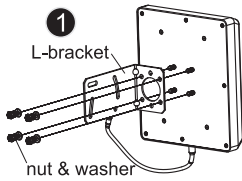

Outdoor wide band panel antenna installation for reference

Note: Be sure the cradle is at the desired height and rotated toward the strongest cellular signal before tightening the nuts. Do not over tighten.

1.5 Install Indoor Antenna

Select a place on a wall in the area where you need better reception. Mount the indoor antenna with the included screws as shown in the figure below.

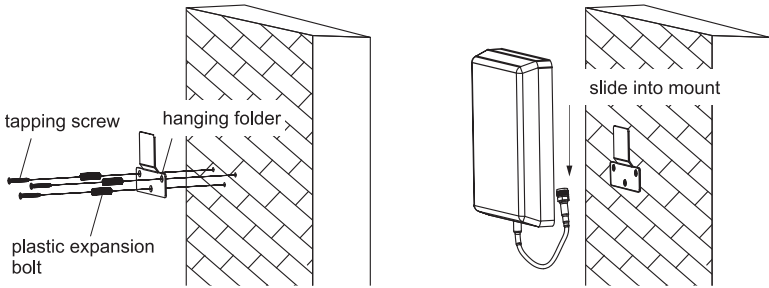

Indoor wide band panel antenna installation for reference

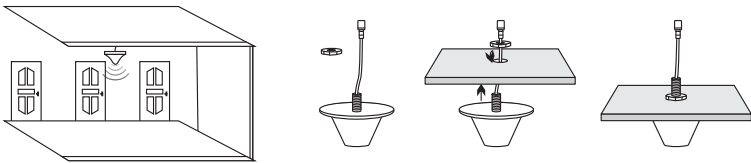

Indoor wide band dome antenna installation for reference

1.6 Install your signal booster

The signal booster should be mounted in an easily accessible area so it's easy to perform general maintenance. The optimal area would be on a wall located near a power outlet. Please use a surge protector rated at a minimum of 1000 Joules between the booster's power adaptor and the AC power outlet on the wall.

Mount the booster with the included screws as shown in the figure below.

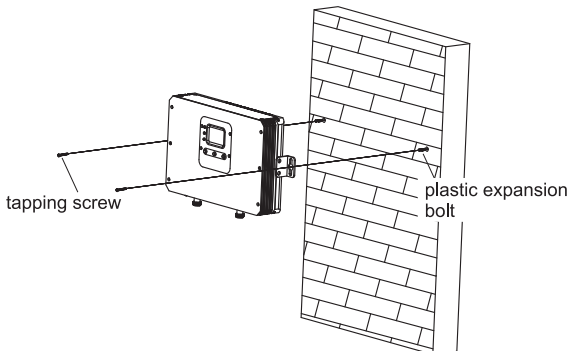

1.7 Run coaxial cable

Loosely run the supplied coaxial cable from your outdoor antenna to your booster connector marked "Outdoor". We recommend applying waterproof tape to fully waterproof the connection.

Connect the indoor antenna cables from your indoor antenna to the booster connector marked "Indoor". Tighten the connection by hand.

(After you have tested the system you can permanently secure the coaxial cable).

As you route and pull cabling, follow these general guidelines:

- Bend cables and route them smoothly, and protect the outer skin against any damage.
- Keep horizontal cables straight and fasten them with a tie every three to five feet.
- Bind and fasten vertical cables every six to eight feet.
- Waterproof all connectors between outdoor antenna and coaxial cables with waterproof tape to avoid water or other kinds of damage.
- Be careful when plugging the connector in so as not to damage the center pins on the connectors.

1.8 Power up your signal booster

Once all the following precautions have been taken, power on the signal booster.

1. Verify that you have left at least 20 feet of vertical separation space between the indoor and outdoor antennas.
2. Never point the front of outdoor antenna towards the inside of the indoor antenna.
3. Verify that the supplied coaxial cables from both the outdoor antenna and the indoor antenna are properly connected to the signal booster before powering it up.
4. Carefully plug in the supplied power adaptor into the signal booster where it is marked 'DC 12V' and connect the other end to a power outlet.

The LED indicator marked power should light up green.

SIGNAL BOOSTER STATUS

Overview: The booster has a smart startup system. When you have finished the booster system installation and power on the booster, it will start its initialization process to check the received downlink signal from the cell site and the isolation status. This an automatic process designed to ensure its best performance. This will take approximately 3-5 seconds.

After the booster starts up, please check if the coverage is good. If it is good, the booster system installation is complete. If the coverage is not adequate, please



fully reread and understand the LCD, LED indications, control buttons and MGC function on your booster, as they will help you identify and solve any potential issues.

- **LCD Features**

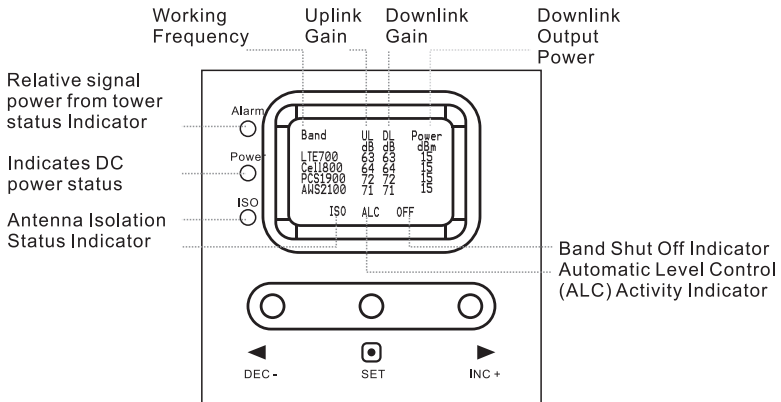

Band: Shows the working frequency bands where the booster is operating.

UL/DL: Shows real-time uplink and downlink gain(dB). These values will change slightly as the ALC or ISO makes changes to the gain to optimize coverage.

Power: Shows real-time downlink power(dBm) that the booster is delivering to the indoor antenna port. When the booster DL output power is lower than -10dBm, the value will display "--".

ISO: When the system does not have enough isolation between the outdoor and indoor antennas, the "ISO" indicator will be flashing showing that the ISO has lowered the gain in some bands to keep the system from oscillating. Press the "SET" key and the LCD screen will display "ISO" value showing the current band or bands affected.

ALC: When the booster is receiving too much DL power from the tower and the DL booster output is close to saturating, the "ALC" indicators will flash showing that the ALC has lowered the gain to prevent this overload condition. Press the "SET" button and the screen will show the band or bands affected.

OFF: In some rare situations the ALC or ISO will not be able to compensate for an oscillation condition or a downlink overload. When this happens the booster will shut off in the affected band and the LCD “OFF” indicator will flash. Pressing the “SET” button will display which band or bands are affected.

ISO flash		
Band	UL	DL
LTE700	---	2
Cell1800	---	3
PCS1900	---	---
AWS2100	---	---

ALC flash		
Band	UL	DL
LTE700	---	2
Cell1800	---	3
PCS1900	---	2
AWS2100	---	---

OFF flash		
Band	UL	DL
LTE700	---	---
Cell1800	---	---
PCS1900	OFF	OFF
AWS2100	OFF	OFF

• **LED Status**

LED	Status	Definition	
Power LED	Green	Normal	
	Off	DC power problem	
Alarm LED	Green	Output power is not maximum.	Check coverage, leave as is if it's good; if the coverage is poor, please check the Troubleshooting section to get solutions.
	Slow Flashing Green	Full output power.	
	Quick Flashing Green	Output power is too high.	Not working properly. Please check the Troubleshooting section to get solutions.
	Quick Flashing Red	The booster automatically shuts off for protection from excessive downlink signal from tower.	
ISO LED	Green	No loopback or no self-oscillation. Working properly.	
	Slow Flashing Green	Slight loop back or self-oscillation.	
	Quick Flashing Green	Deep loop back or self-oscillation.	Not working properly. Please check the Troubleshooting section to get solutions.
	Quick Flashing Red	The booster automatically shuts off for protection due to very severe self-oscillation.	



Control Buttons Operation

When the LCD is in the fixed display mode, press the "SET" key for more than 3 seconds and it will start up in the Gain Setting Mode. Press the "SET" key for more than 3 seconds, and the LCD will return to the fixed display mode. (For more details refer to Manual Gain Control (MGC) below.

When the LCD is in the alarm display mode, press the "SET" key and the LCD screen will display the alarm indication showing the affected band. Pressing the "INC+" (or "DEC-") key and the LCD will switch to help tips. If none of the keys are pushed within 30 seconds, the display will return to the fixed display mode. If none of the control keys are pushed within 5 minutes, the LCD screen will turn off. Pressing any key will return the display to the fixed mode.

Manual Gain Control (MGC)

Since the booster has a self-adaptive smart automatic level control (ALC) and isolation gain processing (ISO), most of the time manual adjustments are not required to achieve good coverage. However, in some cases where the ALC or ISO is working at a very high rate to adjust the gain and the Alarm or ISO LED is flashing more than once a second a manual adjustment might be desired. When the LCD is in the fixed display mode, press the "SET" key for more than 3 seconds. It will go into the "Gain Setting Mode" and make one of the gain values start to blink.

- Briefly press "SET" key, and the LCD will switch to the next gain value and it will start to blink. (Uplink or downlink gain for a different band).
- Press "INC+" key once shortly and the gain will increase by 1dB, Press "DEC-" once shortly and the gain value will be reduced by 1dB.
- Press the "DEC-" and "INC+" key simultaneously for more than 3 seconds, the booster will reset the gain to the default manufacturer settings.
- Press the "SET" key for more than 3 seconds, and the LCD will return to the fixed display mode.

Band	Actual Gain display		MGC Setting Gain		Actual Power display
	UL	DL	UL	DL	
700	63	63	63	61	13
800	64	64	64	63	14
1900	72	72	72	72	15
2100	71	71	71	71	15

Note: When adjusting the gain manually, please ensure that the uplink gain is equal to or not 5 dB less than the downlink gain setting. This avoids interference with the local cell site tower network.

TROUBLESHOOTING

Eliminate Flashing ISO legend and Quick Flashing Green, Quick Flashing Red ISO LED problems:

1. Adjust the outdoor antenna direction, keeping it away from indoor antenna. Restart booster.
2. Increase the vertical or horizontal distance between the outdoor antenna and indoor antenna. Restart booster.
3. Use barriers such as walls to increase the isolation.
4. Change the indoor antenna type to an antenna with a more directional antenna pattern. Orient the indoor antenna and outdoor antenna so they point in opposite directions.
5. Reduce the booster's downlink gain using the manual gain controls. Keep the uplink gain value and downlink gain value the same then restart the booster.

Note: Uplink gain must be equal to or not less than 5dB below the downlink gain, to avoid interference with the local carrier's cell site network.

Target: The ISO issues are solved when the ISO LED is "Green" or "Slow Flashing Green" or no flashing ISO legend.

Eliminate Flashing ALC legend and Quick Flashing Green, Quick Flashing Red Alarm LED problems:

1. Adjust the antennas' directions or locations to lower downlink received signal level.
2. Slowly reduce the downlink gain using the Manual Gain Controls.
3. If the above methods don't work, reduce the booster's gain with an external attenuator in line with the outdoor antenna or replace with lower gain antenna.

Target: The overload issues are fixed when the Alarm LED is "Green" or "Slow Flashing Green" or no flashing ALC legend. Please note that a "Green" LED indication may result in smaller coverage area. This can be improved by adjusting the outdoor antenna to receive a stronger signal.

Eliminate Power "----" legend on LCD and poor coverage problems when Alarm LED is Green:

1. If the signal has not been improved, please check below:
 - The weak downlink signal leads to the low output signal level. Change the direction or position of the outdoor antenna. You may also try replacing the outdoor antenna with a higher gain antenna to increase the incoming signal.
 - Check to see if it is necessary to add more indoor antennas. Barriers such as walls can block the signal indoors. You should also check the booster to make sure the power is maximized. Try installing more indoor antennas or replace the booster with a higher powered one.
2. If the signal in a small section of the building hasn't been improved, try the



following:

- Check to see if the indoor antenna is installed correctly. Try moving the antenna to improve coverage.
- Try adjusting the direction the indoor antenna is pointing.

AUTHORIZED KITTING OPTIONS

The following accessories are authorized by the FCC to be used with the **Commercial 30K Pro Signal Booster**.

Outdoor Antenna & Cable Kit Options

Kit numbers: 11-100400

Wide Band Directional Antenna with 100' 400 N male

Kit numbers: 11-75400

Wide Band Directional Antenna with 75' 400 N male

Kit numbers: 11-50400

Wide Band Directional Antenna with 50' 400 N male

Kit numbers: 11-30400

Wide Band Directional Antenna with 30' 400 N male

Kit numbers: 11-100300

Wide Band Directional Antenna with 100' 300 N male

Kit numbers: 11-75300

Wide Band Directional Antenna with 75' 300 N male

Kit numbers: 11-50300

Wide Band Directional Antenna with 50' 300 N male

Kit numbers: 11-30300

Wide Band Directional Antenna with 30' 300 N male

Kit numbers: 10-100400

Panel Antenna with 100' 400 N male

Kit numbers: 10-75400

Panel Antenna with 75' 400 N male

Kit numbers: 10-50400

Panel Antenna with 50' 400 N male

Kit numbers: 10-30400

Panel 10dbi Antenna with 30' 400 N male

Kit numbers: 10-100300

Panel Antenna with 100' 300 N male

Kit numbers: 10-75300

Panel Antenna with 75' 300 N male

Kit numbers: 10-50300

Panel Antenna with 50' 300 N male

Kit numbers: 10-30300

Panel Antenna with 30' 300 N male

Kit numbers: 9-100400

Wide Band Directional Antenna with 100' 400 N male

Kit numbers: 9-75400

Wide Band Directional Antenna with 75' 400 N male

Kit numbers: 9-50400

Wide Band Directional Antenna with 50' 400 N male

Kit numbers: 9-30400

Wide Band Directional Antenna with 30' 400 N male

Kit numbers: 9-100300

Wide Band Directional Antenna with 100' 300 N male

Kit numbers: 9-75300

Wide Band Directional Antenna with 75' 300 N male

Kit numbers: 9-50300

Wide Band Directional Antenna with 50' 300 N male

Kit numbers: 9-30300

Wide Band Directional Antenna with 30' 300 N male

Kit numbers: 7-100400

Panel Antenna with 100' 400 N male

Kit numbers: 7-75400

Panel Antenna with 75' 400 N male

Kit numbers: 7-50400

Panel Antenna with 50' 400 N male

Kit numbers: 7-30400

Panel Antenna with 30' 400 N male

Kit numbers: 7-100300

Panel Antenna with 100' 300 N male

Kit numbers: 7-75300

Panel Antenna with 75' 300 N male

Kit numbers: 7-50300

Panel Antenna with 50' 300 N male

Kit numbers: 7-30300

Panel Antenna with 30' 300 N male

Kit numbers: 5-10400

Omni Directional Antenna with 100' 400 N male

Kit numbers: 5-75400

Omni Directional Antenna with 75' 400 N male

Kit numbers: 5-50400

Omni Directional Antenna with 50' 400 N male

Kit numbers: 5-30400

Omni Directional Antenna with 30' 400 N male

Kit numbers: 5-100300

Omni Directional Antenna with 100' 300 N male

Kit numbers: 5-75300

Omni Directional Antenna with 75' 300 N male

Kit numbers: 5-50300

Omni Directional Antenna with 50' 300 N male

Kit numbers: 5-30300

Omni Directional Antenna with 30' 300 N male

Indoor Antenna & Cable Kit Options

Kit numbers: 102-100400-50

Panel Antenna with 100' 400 N male & a 50 Ohm 2-Way Splitter

Kit numbers: 73-75400-50

Panel Antenna with 75' 400 N male & a 50 Ohm 3-Way Splitter

Kit numbers: 33-100400-50

Dome Antenna with 100' 400 N male & a 50 Ohm 3-Way Splitter



FCC RF EXPOSURE STATEMENT

This equipment complies with FCC radiation exposure limits set forth for an uncontrolled environment. End users must follow the specific operating instruction for satisfying RF exposure compliance. This transmitter must not be co-located or operating in conjunction with any other antenna or transmitter.

IC RF EXPOSURE STATEMENT

The device is compliance with RF exposure limits. The minimum distance from body to use the device is 20 CM.

Le présent appareil est conforme aux normes de conformité ou aux limites d'intensité de champ RF. La distance minimale du corps à utiliser le dispositif est de 20 CM.

WARNING AND STATEMENT

This is a **CONSUMER** device.

BEFORE USE, you **MUST REGISTER THIS DEVICE** with your wireless provider and have your provider's consent. Most wireless providers consent to the use of signal boosters. Some providers may not consent to the use of this device on their network. If you are unsure, contact your provider.

In Canada, **BEFORE USE** you must meet all requirements set out in ISED CPC-2-1-05.

You **MUST** operate this device with approved antennas and cables as specified by the manufacturer. Antennas **MUST** be installed least 20 cm (8 inches) from (i.e., **MUST NOT** be installed within 20 cm of) any person.

You **MUST** cease operating this device immediately if requested by the FCC (or ISED in Canada) or a licensed wireless service provider.

WARNING. E911 location information may not be provided or may be inaccurate for calls served by using this device.

This device may be operated **ONLY** in a fixed location (i.e., **may operate in a fixed location only**) for in-building use.

Note: This equipment has been tested and found to comply with the limits for a Class B digital device, pursuant to Part 15 of the FCC Rules. These limits are designed to provide reasonable protection against harmful interference in a residential installation. This equipment generates, uses and can radiate radio frequency energy and, if not installed and used in accordance with the

instructions, may cause harmful interference to radio communications. However, there is no guarantee that interference will not occur in a particular installation. If this equipment does cause harmful interference to radio or television reception, which can be determined by turning the equipment off and on, the user is encouraged to try to correct the interference by one or more of the following measures:

- Reorient or relocate the receiving antenna.
- Increase the separation between the equipment and receiver.
- Connect the equipment into an outlet on a circuit different from that to which the receiver is connected.
- Consult the dealer or an experienced radio/TV technician for help.

Changes or modifications not expressly approved by Huaptec could void the user's authority to operate the equipment.

Note: For a complete list of antennas and cables approved for use with these boosters see **Authorized Kitting Options** page 14.

FCC 27.50(d)(4)Statement: Fixed, mobile, and portable (handheld) stations operating in the 1710-1755 MHz band are limited to 1 watt EIRP. Fixed stations operating in the 1710-1755 MHz band are limited to a maximum antenna height of 10 meters above ground.

FURTHER INFORMATION ON SIGNAL BOOSTER END-USE REGISTRATION

The following is currently active contact of US wireless provider for booster register.

<https://www.uscellular.com/uscellular/support/fcc-booster-registration.jsp>

https://www.sprint.com/legal/fcc_boosters.html

<https://www.verizonwireless.com/solutions-and-services/accessories/register-signal-booster/>

<https://support.t-mobile.com/docs/DOC-9827>

<https://securec45.securewebsession.com/attsignalbooster.com/>

IC Statement

This device complies with Innovation, Science and Economic Development Canada ICES-003 Compliance Label: CAN ICES-3 (B)/ NMB-3(B).

Le présent appareil est conforme Innovation, science et développement économique Canada ICES-003 Étiquette de conformité: CAN ICES-3 (B) / NMB-3 (B).

Link to CPC-2-1-05

<http://www.ic.gc.ca/eic/site/smt-gst.nsf/eng/sf08942.html>



SPECIFICATION

RF Parameter	Uplink	Downlink	
Frequency Range	700 MHz Band 12/17	698~716 MHz	728~746 MHz
	700 MHz Band13	776~787 MHz	746~757 MHz
	800 MHz Band	824~849 MHz	869~894 MHz
	PCS1900	1850~1915 MHz	1930~1995 MHz
	AWS2100	1710~1755 MHz	2110~2155 MHz
Band width	700 MHz Band 12/17	18 MHz	
	700 MHz Band 13	11 MHz	
	Cell800	25 MHz	
	PCS1900	65 MHz	
	AWS2100	45 MHz	
Max. Gain	70 dB		
Max. output power	17~24 dBm	15 dBm	
MGC (Step Attenuation)	≥ 25 dB / 1 dB step		
Electrical Parameter	Standard		
Power Supply	Input AC 100~240 V, 50~60 Hz, Output DC 12 V / 3 A		
Input & Output Impedance	50 ohm		
Mechanical Parameter	Standard		
I/O Port	N-Female		
Dimensions	11*7.3*2.2 inch / 280*185*55 mm		
Weight	< 11 lbs / 5 kg		

PRODUCT WARRANTY

30-Day Money-Back: All HiBoost products are protected by a 30-day money-back guarantee. If for any reason the performance of any product is not acceptable, the product may be returned to the reseller with a dated proof of purchase.

3-Year Warranty HiBoost Signal Boosters and kits are warranted for 3 years. Customers can choose to return the Signal Boosters and kits directly to the manufacturer at the purchaser's expense with a dated proof of purchase and a Returned Material Authorization (RMA) number supplied by HiBoost.

HiBoost will supply two options: repair or replace. HiBoost will cover the cost of delivery for the consumers located within the continental U.S.

This warranty does not apply to any Signal Boosters or kits determined by HiBoost to have been subjected to misuse, abuse, neglect, or mishandling that alters or damages physical or electronic properties. Failure to use a surge protected AC Power Strip with at least a 1000 Joule rating will void your warranty. Damage caused by lightning is not covered by this warranty.

All HiBoost products that are packaged with other HiBoost accessory products are intended for resale and used as a single integrated system. Such product kits are required to be sold to the end users or subsequent reseller as packaged. RMA numbers may be obtained by contacting Technical Support at 972-870-5666.





HiBoost USA

6210 N Belt Line Rd., Ste. 110, Irving, TX 75063

Phone/Fax: (972) 870-5666

E-mail: info@hiboostusa.com

Website: www.hiboostusa.com