

TEST REPORT

Applicant: SHENZHEN HUAPTEC CO., LTD
5th FL, E BLDG, Sogood Science Park, Sanwei Community,
Address of Applicant: Hangkong Road, Xixiang, Bao'an, Shenzhen, Guangdong,
China 518102

Equipment Under Test (EUT)

Product Name: Cellular signal booster
Model No.: F10F-CP
FCC ID: OWWF10F-CP
FCC Part 22:2010
Applicable standards: FCC Part 24:2010
2-11-04/EAB/RF
Date of sample receipt: July. 16, 2012
Date of Test: July. 17 to Aug. 21, 2012
Date of report issued: Aug. 21, 2012
Test Result : PASS *

* In the configuration tested, the EUT complied with the standards specified above.

Authorized Signature:



Bruce Zhang
Laboratory Manager

This report details the results of the testing carried out on one sample. The results contained in this test report do not relate to other samples of the same product and does not permit the use of the CCIS product certification mark. The manufacturer should ensure that all products in series production are in conformity with the product sample detailed in this report.

This report may only be reproduced and distributed in full. If the product in this report is used in any configuration other than that detailed in the report, the manufacturer must ensure the new system complies with all relevant standards.

This document cannot be reproduced except in full, without prior written approval of the Company. Any unauthorized alteration, forgery or falsification of the content or appearance of this document is unlawful and offenders may be prosecuted to the fullest extent of the law. Unless otherwise stated the results shown in this test report refer only to the sample(s) tested and such sample(s) are retained for 90 days only."

2 Version

Version No.	Date	Description
00	Aug. 21,2012	Original

Prepared By:

Joe. Zhou

Project Engineer

Date:

Aug. 21,2012

Check By:

Bruce Zhang

Reviewer

Date:

Aug. 21,2012

3 Contents

	Page
1 COVER PAGE.....	1
2 VERSION.....	2
3 CONTENTS.....	3
4 TEST SUMMARY.....	5
5 GENERAL INFORMATION.....	6
5.1 CLIENT INFORMATION.....	6
5.2 GENERAL DESCRIPTION OF E.U.T.....	6
5.3 RELATED SUBMITTAL(S) / GRANT (S).....	7
5.4 TEST METHODOLOGY.....	7
5.5 TEST FACILITY.....	7
5.6 TEST LOCATION.....	7
5.7 TEST INSTRUMENTS LIST.....	8
6 TEST CONFIGURATION AND CONDITIONS.....	9
6.1 EUT CONFIGURATION.....	9
6.2 CONFIGURATION OF TESTED SYSTEM.....	10
6.3 TEST ENVIRONMENTS.....	11
6.4 TEST SIGNAL.....	12
6.5 TEST FREQUENCY SELECTION.....	12
6.6 DESCRIPTION OF TEST MODES.....	13
7 RF POWER OUTPUT MEASUREMENT.....	14
7.1 STANDARD APPLICABLE.....	14
7.2 TEST SETUP.....	14
7.3 MEASUREMENT PROCEDURE.....	14
7.4 TEST RESULT.....	15
7.5 PEAK TO AVERAGE RATIO.....	16
8 OCCUPIED BANDWIDTH.....	17
8.1 STANDARD APPLICABLE.....	17
8.2 TEST SETUP.....	17
8.3 TEST PROCEDURE.....	17
8.4 TEST RESULT.....	18
9 SPURIOUS EMISSION AT ANTENNA TERMINALS.....	42
9.1 STANDARD APPLICABLE.....	42
9.2 TEST SETUP.....	42
9.3 MEASUREMENT PROCEDURE.....	42
9.4 MEASUREMENT RESULT.....	43
9.4.1 Spurious emission.....	43
9.4.2 Band edge emission.....	63
10 INTERMODULATION.....	71
10.1 STANDARD APPLICABLE.....	71
10.2 TEST SETUP.....	71

10.3	MEASUREMENT PROCEDURE	71
10.4	TEST RESULT.....	72
11	FIELD STRENGTH OF SPURIOUS RADIATION MEASUREMENT	80
11.1	STANDARD APPLICABLE.....	80
11.2	EUT SETUP (BLOCK DIAGRAM OF CONFIGURATION)	80
11.3	MEASUREMENT PROCEDURE	80
11.4	TEST RESULT.....	82
12	OUT OF BAND REJECTION.....	83
12.1	STANDARD APPLICABLE.....	83
12.2	EUT SETUP (BLOCK DIAGRAM OF CONFIGURATION)	83
12.3	MEASUREMENT PROCEDURE	83
13	AC POWER LINE CONDUCTED EMISSION TEST	86
13.1	STANDARD APPLICABLE.....	86
13.2	TEST SETUP	86
13.3	TEST PROCEDURE.....	86
13.4	TEST RESULT.....	87
14	TEST SETUP PHOTO.....	89
15	EUT CONSTRUCTIONAL DETAILS.....	91

4 Test Summary

Test Item	Section	Result
Maximum Permissible exposure(MPE)	§1.1307(b)(1), §2.1091	PASS* (Please refer to MPE Report)
RF Output Power	§2.1046(a), §22.913, §24.232(a)	PASS
Occupied Bandwidth	§2.1049	PASS
Spurious Emissions at Antenna Terminal	§2.1051, §22.917, §24.238,RSS-131,RSS-GEN	PASS
Inter-modulation	§2.1051, §22.917, §24.238	PASS
Field Strength of Spurious Radiation	§ 2.1053, §22.917, §24.238	PASS
Out of band emission, Band Edge	§22.917,§ 24.238	PASS
Frequency stability vs. temperature Frequency stability vs. voltage	§ 2.1055, § 22.355 § 24.235	N/A*

Remark:

N/A*: Not application for repeater.

5 General Information

5.1 Client Information

Applicant:	SHENZHEN HUAPTEC CO., LTD
Address of Applicant:	5th FL, E BLDG, Sogood Science Park, Sanwei Community, Hangkong Road, Xixiang, Bao'an, Shenzhen, Guangdong, China 518102
Manufacturer/Factory:	SHENZHEN HUAPTEC CO., LTD
Address of Manufacturer/Factory :	5th FL, E BLDG, Sogood Science Park, Sanwei Community, Hangkong Road, Xixiang, Bao'an, Shenzhen, Guangdong, China 518102

5.2 General Description of E.U.T.

Product Name:	Cellular signal booster		
Model No.:	F10F-CP		
Power supply:	MODEL:GM26-075200-D INPUT: AC 100-240V~50/60Hz 1.0A OUTPUT:DC 7.5V 2.0A Normal test voltage: 120V AC 60Hz		
Operating Temperature:	Remote Unit: -25°C to + 55°C		
Operating Humidity:	5%~85%		
Technical Parameter:			
Frequency Range	CDMA800/GSM850	Downlink	869MHz~894MHz
		Uplink	824MHz~849MHz
	CDMA/PCS1900	Downlink	1930MHz~1990MHz
		Uplink	1850MHz~1900MHz
Channel Spacing(s) / Bandwidth(s)	GSM: 200kHz CDMA: 1.23MHz		
Maximum Output Power	Uplink:10dBm,Downlink:10dBm		
Max Gain	Downlink: 60dB ; Uplink:55 dB ;		
Type of modulation and Designator	GSM(GXW); CDMA(F9W)		
Antenna Type	External antenna (N type)		
Antenna Gain	Uplink:7 dBi ,Downlink:9.5dBi		

5.3 Related Submittal(s) / Grant (s)

No related submittal(s)

5.4 Test Methodology

ANSI C63.4: 2003	Methods of Measurement of Radio-Noise Emissions from Low Voltage Electrical and Electronic Equipment in the Range of 9 kHz to 40 GHz
ANSI/TIA-603-C 2004	Land Mobile FM or PM Communications Equipment Measurement and Performance Standards
2-11-04/EAB/RF	AMPLIFIER, BOOSTER, AND REPEATER REMINDER SHEET

5.5 Test Facility

The test facility is recognized, certified, or accredited by the following organizations:

● **FCC —Registration No.:** 817957

China Certification & Inspection Services Co., Ltd., Shenzhen EMC Laboratory has been registered and fully described in a report filed with the (FCC) Federal Communications Commission. The acceptance letter from the FCC is maintained in our files. Registration 817957, February 27, 2012

● **Industry Canada (IC)**

The 3m Semi-anechoic chamber of China Certification & Inspection Services Co., Ltd. Has been Registered by Certification and Engineering Bureau of Industry Canada for radio equipment testing with Registration No.: 10106A-1.

5.6 Test Location

All tests were performed at:

China Certification & Inspection Services Co., Ltd.
 Address: 1st Floor, Block No.2, Laodong Industrial Zone, Xixiang Road Baoan District, Shenzhen, China
 Tel: 0755-23118282
 Fax: 0755-23116366

5.7 Test Instruments list

Item	Test Equipment	Manufacturer	Model No.	Inventory No.	Cal.Date (mm-dd-yy)	Cal.Due date (mm-dd-yy)
1	3m Semi- Anechoic Chamber	SAEMC	9(L)*6(W)* 6(H)	CCIS0001	June 09 2012	June 09 2013
2	Control Room	ZhongYu Electron	6.2(L)*2.5(W)* 2.4(H)	GTS202	N/A	N/A
3	BiConiLog Antenna	SCHWARZBECK MESS-ELEKTRONIK	VULB9163	CCIS0005	June 04 2012	June 04 2013
4	Double -ridged waveguide horn	SCHWARZBECK MESS-ELEKTRONIK	BBHA9120D	CCIS0006	May 30 2012	May 30 2013
5	EMI Test Software	AUDIX	E3	N/A	N/A	N/A
6	Coaxial Cable	CCIS	N/A	CCIS0016	Apr. 01 2012	Apr. 01 2013
7	Coaxial Cable	CCIS	N/A	CCIS0017	Apr. 01 2012	Apr. 01 2013
8	Coaxial cable	CCIS	N/A	CCIS0018	Apr. 01 2012	Apr. 01 2013
9	Coaxial Cable	CCIS	N/A	CCIS0019	Apr. 01 2012	Apr. 01 2013
10	Coaxial Cable	CCIS	N/A	CCIS0087	Apr. 01 2012	Apr. 01 2013
11	Amplifier(10KHz-1.3GHz)	HP	8447D	CCIS0003	Apr. 01 2012	Apr. 01 2013
12	Amplifier(1GHz-18GHz)	Compliance Direction Systems Inc.	PAP-1G18	CCIS0011	June 09 2012	June 09 2013
13	Printer	HP	HP LaserJet P1007	N/A	N/A	N/A
14	Positioning Controller	UC	UC3000	CCIS0015	N/A	N/A
15	Spectrum Analyzer	Agilent	E4443A	MY4430623	Sept. 10 2011	Sept. 10 2012
16	Splitter	Agilent	11636B	GTS237	May 12 2012	May 11 2013
17	Signal Generator	Agilent	E4421B	MY41001242	Sept. 10 2011	Sept. 10 2012
18	Signal Generator	Agilent	E4433B	MY43350331	Sept. 10 2011	Sept. 10 2012
19	Power Attenuator	HUAPTEC	6dB/10W	040706090	Sept. 10 2011	Sept. 10 2012
20	Spectrum Analyzer	Rohde & Schwarz	FSP	CCIS0023	May.11.2012	May.10.2013
21	Universal radio communication tester	Rohde & Schwarz	CMU200	CCIS0069	May.11.2012	May.10.2013

6 TEST CONFIGURATION AND CONDITIONS

6.1 EUT Configuration

F10F-CP is basically a bi-directional booster, the downlink signals are received by the repeater from BTS by the donor antenna, filtered by its combiner, internal duplexers and FC unit, amplified by low noise amplifier (LNA) and downlink PA unit, and then sent via the server antenna to the coverage area. The bandwidth is wide band frequency. The uplink signal of mobile terminal from the coverage area is input via the server antenna, then filtered by combiner, duplexers and FC unit, amplified by the uplink low noise amplifier (LNA) and the uplink PA unit and finally sent via the donor antenna to the BTS.

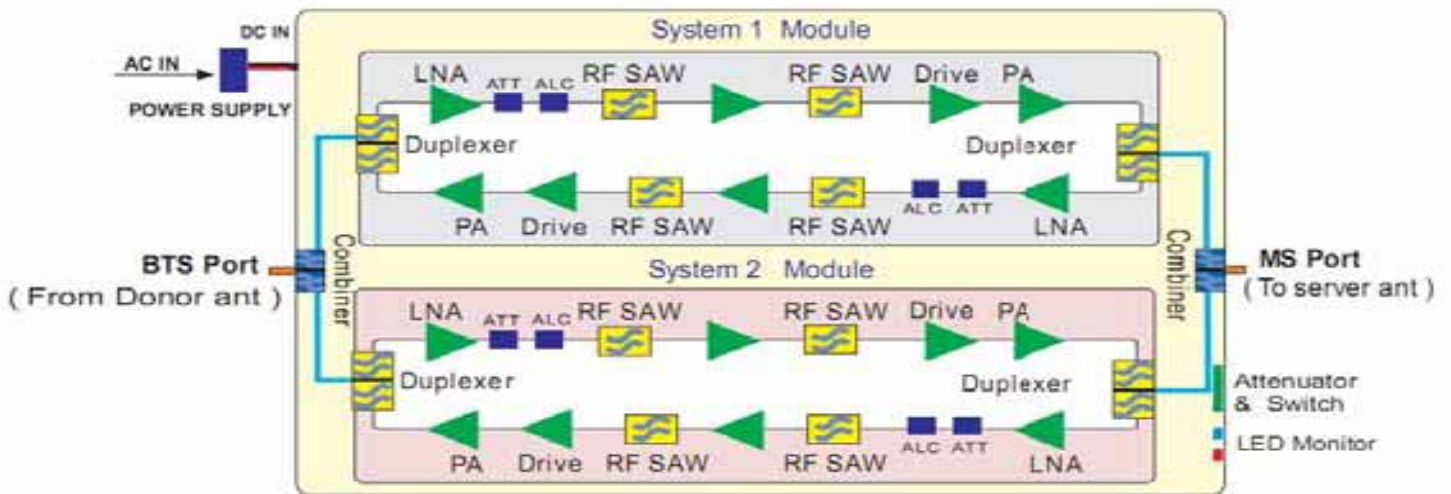

For details, refer to technical document and the user manual.

6.2 Configuration of Tested System

(A) RF Output Power, Occupied Bandwidth, Spurious Emissions at Antenna Terminal, Band Edge, Test Setup

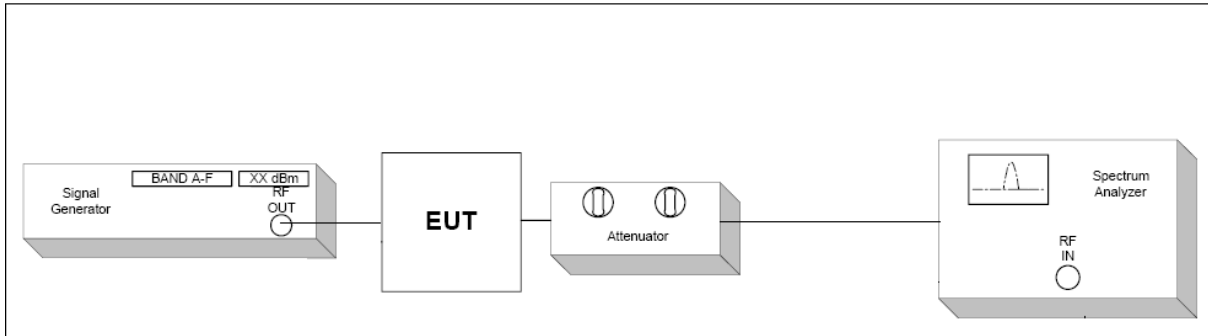

(B) Inter-modulation Test Setup

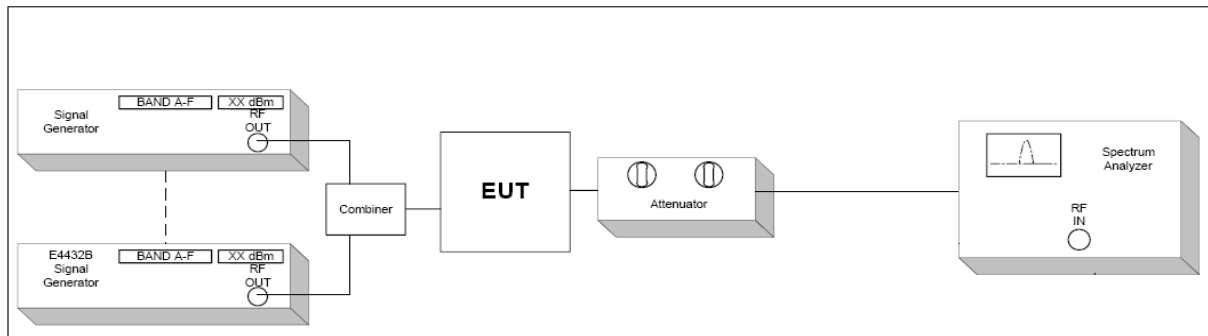

(C) Radiated Emission Test Setup, Frequency below 1000MHz

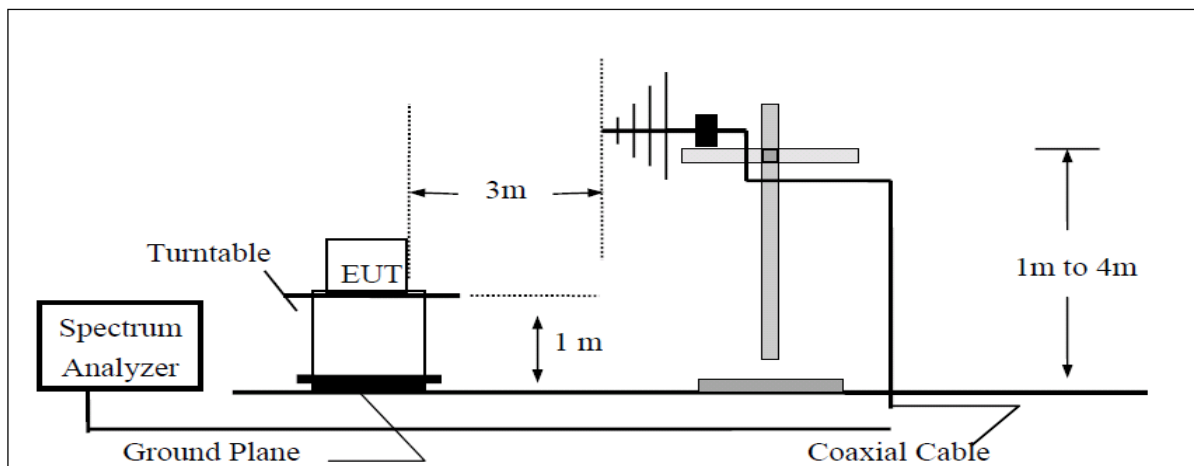

(D) Radiated Emission Test Setup Frequency over 1 GHz

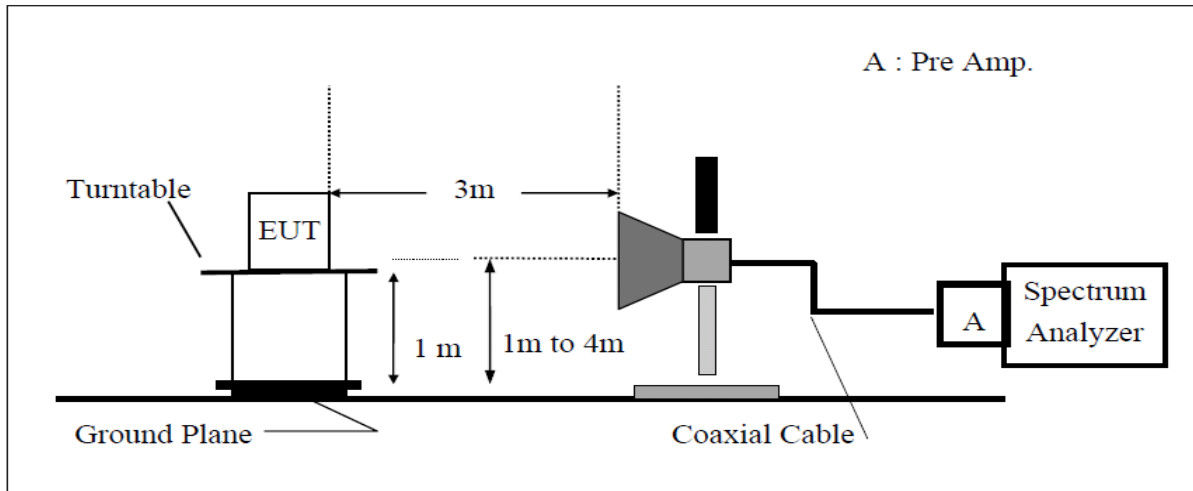

(E) Substituted Method Test Setup

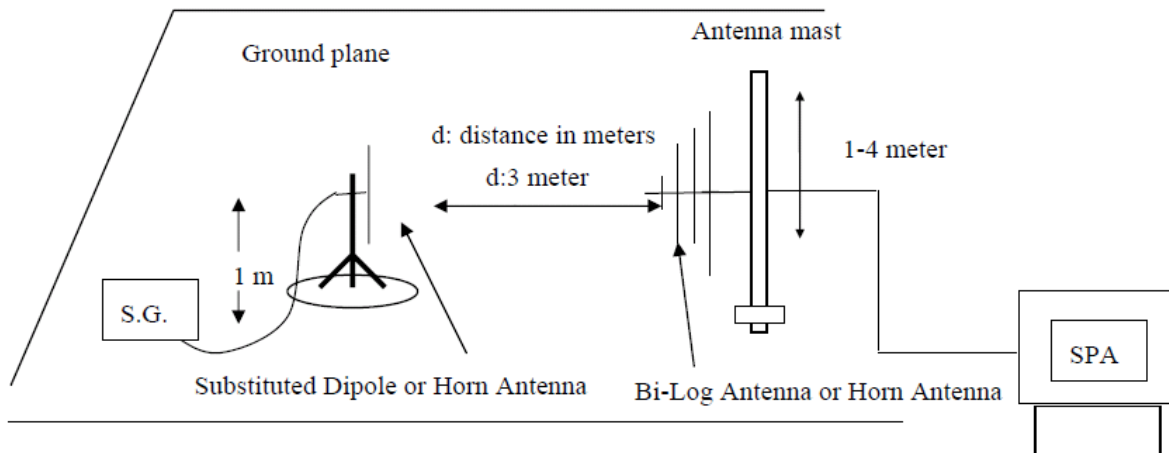

6.3 Test Environments

Condition	Minimum value	Maximum value
Barometric pressure	86 kPa	106 kPa
Temperature	15°C	30°C
Relative Humidity	20 %	75 %
Power supply range	±5% of rated voltages	
Normal Test Condition	(1).Temperature: +15 °C to +30 °C; (2).voltage is 120VAC.60Hz	
Extreme Test Conditions:	(1). Temperatures: -25°C to +55°C. (2). Voltages: 102 VAC to 138VAC.	

6.4 Test signal

1: Test signal GSM

Signal waveform with GMSK modulation in all time slots according to 3GPP TS45.004

2: Test signal CDMA

Signal waveform according to table 6.2-1 of standard specification 3GPP2 C.P0051-0

pilot, sync, paging, 37 traffics, which is equal to the table 6.5.2.1 of 3GPP2 C.S0010-C

6.5 Test frequency selection

Operating Mode(TX)	Direction	Channels frequency (MHz)		
		Low Ch.	Mid Ch.	High Ch.
GSM850	Uplink	824.2	836.6	848.8
	Downlink	869.2	881	893.8
PCS1900	Uplink	1850.2	1880	1899.8
	Downlink	1930.2	1960	1989.8
CDMA800	Uplink	824.7	833.49	848.31
	Downlink	869.7	878.49	893.31
CDMA1900	Uplink	1851.25	1880	1898.75
	Downlink	1931.25	1960	1988.75

6.6 DESCRIPTION OF TEST MODES

Test mode	Detail description of the test mode
Downlink	Low channel; middle channel; high channel
Uplink	Low channel; middle channel; high channel
bandwidth	GSM: 200kHz ; CDMA: 1.23MHz;
Modulation type	GSM/CDMA

Remark:

- 1: The EUT was powered by 120VAC.
- 2: The EUT was configured for maximum gain and maximum output power. The input power was the maximum declared by the manufacturer. This is to ensure that the equipment is operating in the linear output range.
- 3: Signal generator was used to provide the input signals to the EUT. Tests were performed with GSM/CDMA signal input
- 4: Pre-test all test modes as above, only the worst case and typical mode is list in report it.

7 RF POWER OUTPUT MEASUREMENT

7.1 Standard Applicable

According to FCC §2.1046, §22.913 (a), §24.232 (a) and §24.232 (d).

7.2 Test setup

Please refer the section §6.2 Configuration of Tested System.

7.3 Measurement Procedure

1. The output from the EUT antenna connector was connected to the signal generator.
2. The level of RF input signal shall be increased, until the maximum output power per channel, declared by client, is reached.
3. The RF output power was measured at low, middle and high channel of each type of modulation and each type of carrier.

7.4 Test Result

Test mode	Channel	Average Power (dBm)	Result
GSM850 Downlink	Low	9.48	Compliant
	Middle	9.82	Compliant
	High	9.75	Compliant
GSM850Uplink	Low	9.07	Compliant
	Middle	9.25	Compliant
	High	9.13	Compliant
PCS1900 Downlink	Low	9.98	Compliant
	Middle	9.95	Compliant
	High	9.32	Compliant
PCS1900 Uplink	Low	9.55	Compliant
	Middle	9.54	Compliant
	High	9.41	Compliant
CDMA800 Downlink	Low	9.25	Compliant
	Middle	9.62	Compliant
	High	8.96	Compliant
CDMA800 Uplink	Low	9.14	Compliant
	Middle	9.81	Compliant
	High	8.96	Compliant
CDMA1900 Downlink	Low	7.87	Compliant
	Middle	9.08	Compliant
	High	9.06	Compliant
CDMA1900 Uplink	Low	9.17	Compliant
	Middle	9.73	Compliant
	High	8.49	Compliant

7.5 Peak to Average Ratio

Band	Test Mode	Channel	Average Power (dBm)	Peak Power (dBm)	Result
Cellular	GSM-Uplink	Low	9.48	12.37	Compliant
		Middle	9.82	12.65	Compliant
		High	9.75	12.76	Compliant
	GSM-Downlink	Low	9.07	11.91	Compliant
		Middle	9.25	12.13	Compliant
		High	9.13	12.07	Compliant
	CDMA-Uplink	Low	9.98	12.86	Compliant
		Middle	9.95	12.90	Compliant
		High	9.32	12.24	Compliant
	CDMA-Downlink	Low	9.55	12.37	Compliant
		Middle	9.54	12.47	Compliant
		High	9.41	12.34	Compliant
PCS	GSM-Uplink	Low	9.25	12.07	Compliant
		Middle	9.62	12.52	Compliant
		High	8.96	11.77	Compliant
	GSM-Downlink	Low	9.14	12.12	Compliant
		Middle	9.81	12.79	Compliant
		High	8.96	11.76	Compliant
	CDMA-Uplink	Low	7.87	10.11	Compliant
		Middle	9.08	12.01	Compliant
		High	9.06	11.97	Compliant
	CDMA-Downlink	Low	9.17	12.03	Compliant
		Middle	9.73	12.67	Compliant
		High	8.49	11.05	Compliant

8 OCCUPIED BANDWIDTH

8.1 Standard Applicable

CFR 47 §2.1049 and 2-11-04/EAB/RF.

8.2 Test setup

Please refer the section §6.2 Configuration of Tested System.

8.3 Test Procedure

1. The EUT RF output port was connected to spectrum analyzer.
2. The level of RF input signal shall be increased, until the maximum output power per channel, declared by client, is reached.
3. The spectrum analyzer was setup to measure the Occupied Bandwidth (defined as the 99% Power Bandwidth).
4. The Occupied Bandwidth was measured at the input and output ports of the EUT at low, middle and high channel of each type of modulation and each type of carrier signal.

Spectrum analyzer settings:

Detector: PK

GSM: RBW= 3 kHz VBW=10 kHz Span: 1 MHz Sweep: Auto

CDMA: RBW= 30 kHz VBW=100 kHz Span: 3 MHz Sweep: Auto

8.4 Test Result

Input/output Bandwidth Comparison for GSM

GSM 850 Downlink

Output(Low channel)

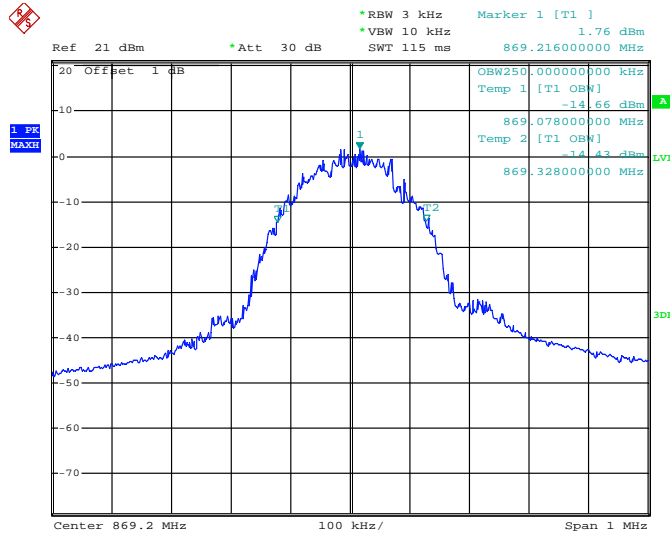

Date: 1.AUG.2012 14:12:39

Output(Middle channel)

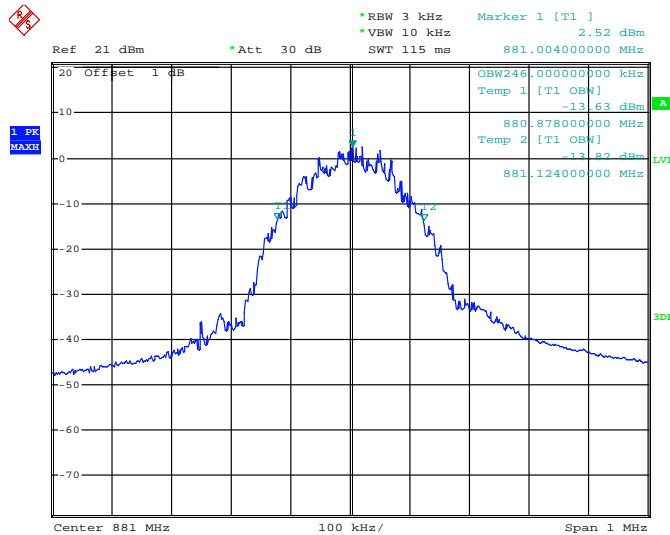

Date: 1.AUG.2012 14:12:00

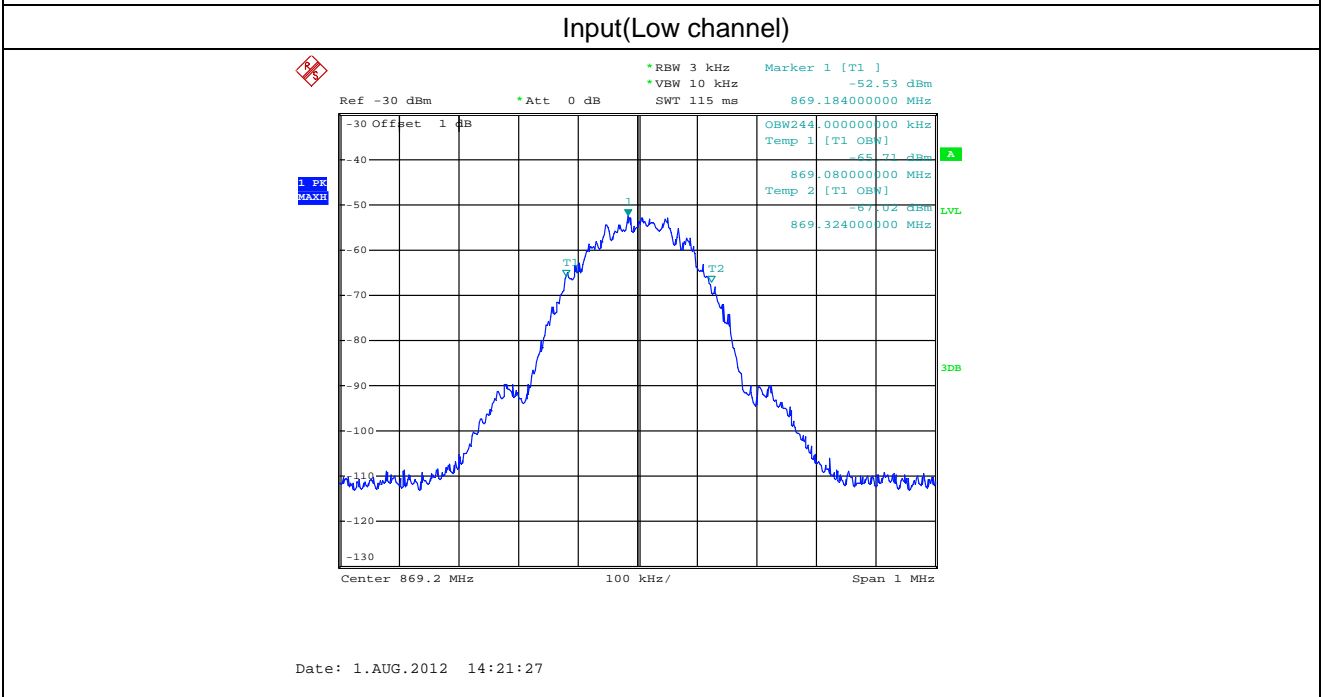
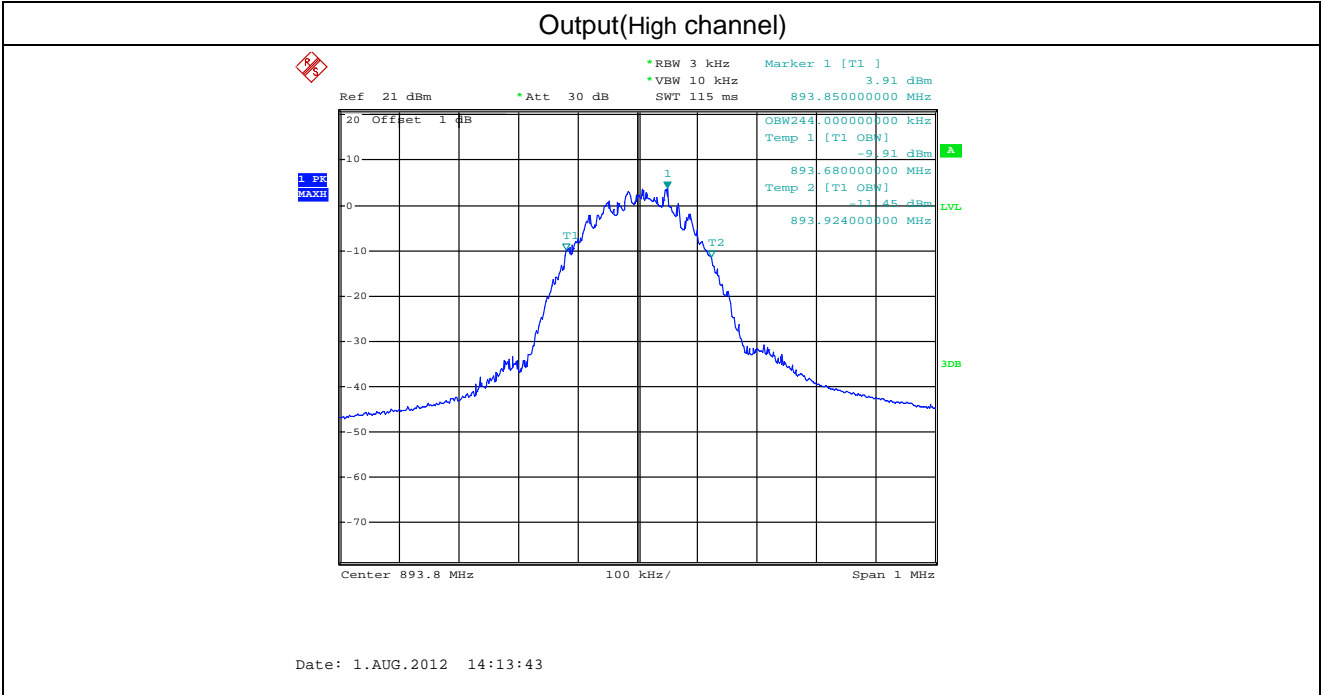

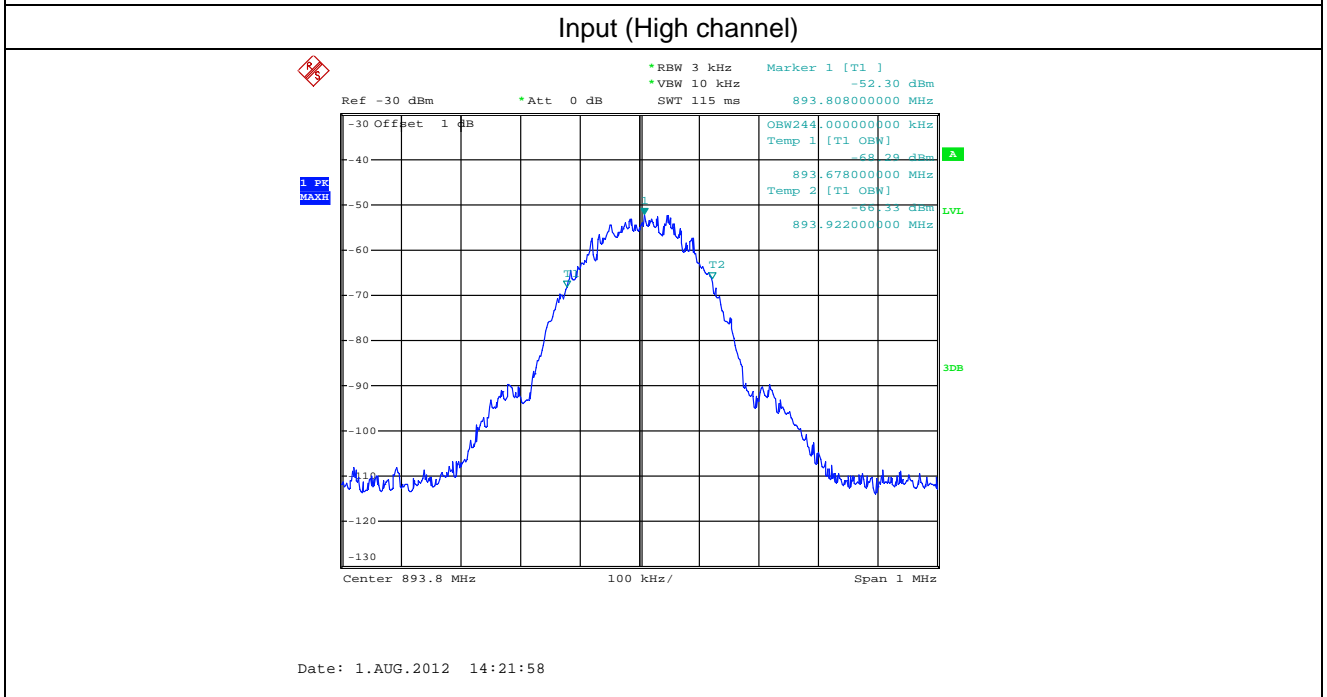
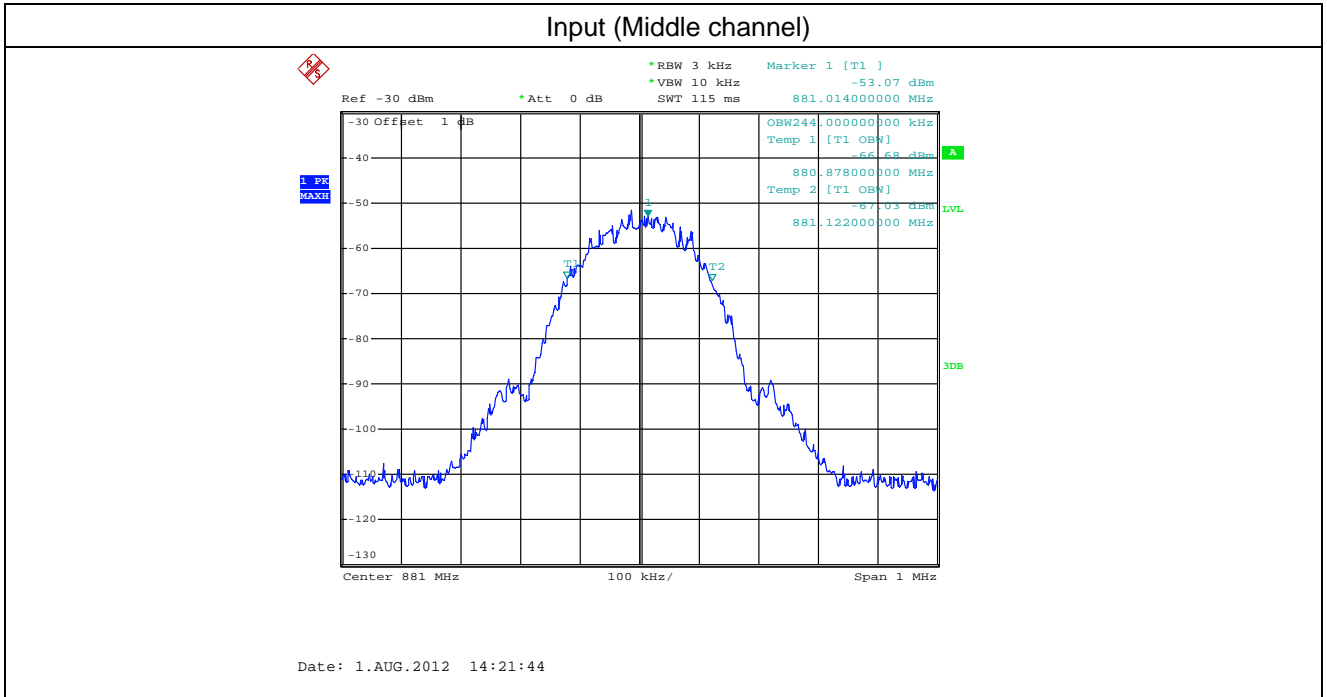

GSM 850 Uplink

Output(Low channel)

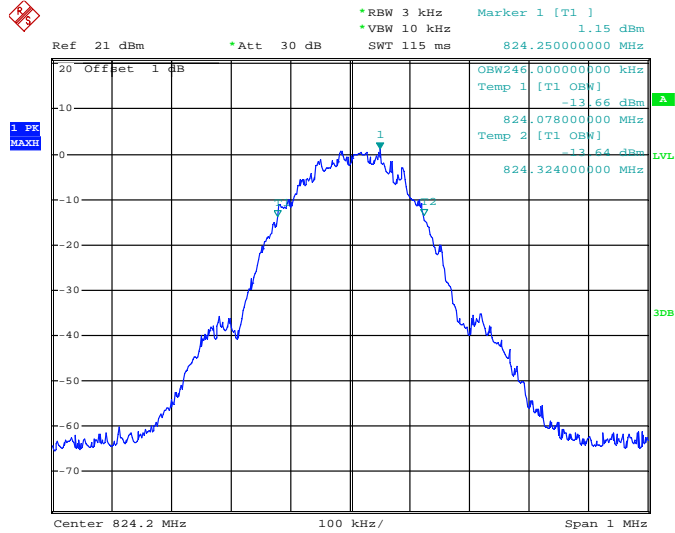

Date: 1.AUG.2012 14:15:23

Output(Middle channel)

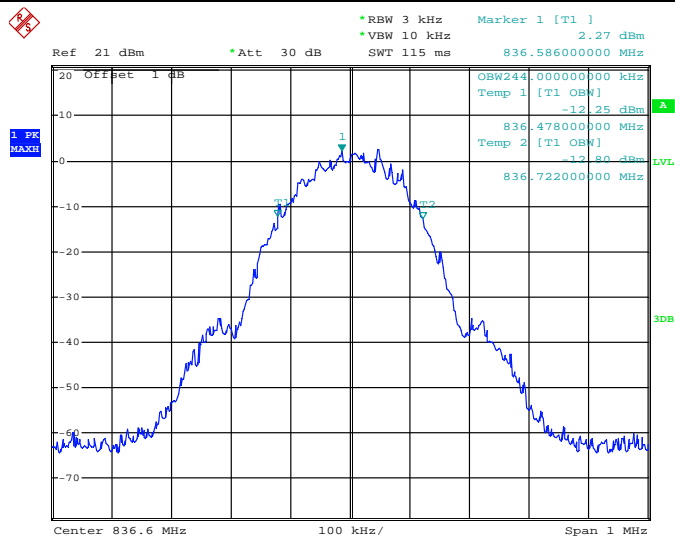

Date: 1.AUG.2012 14:16:26

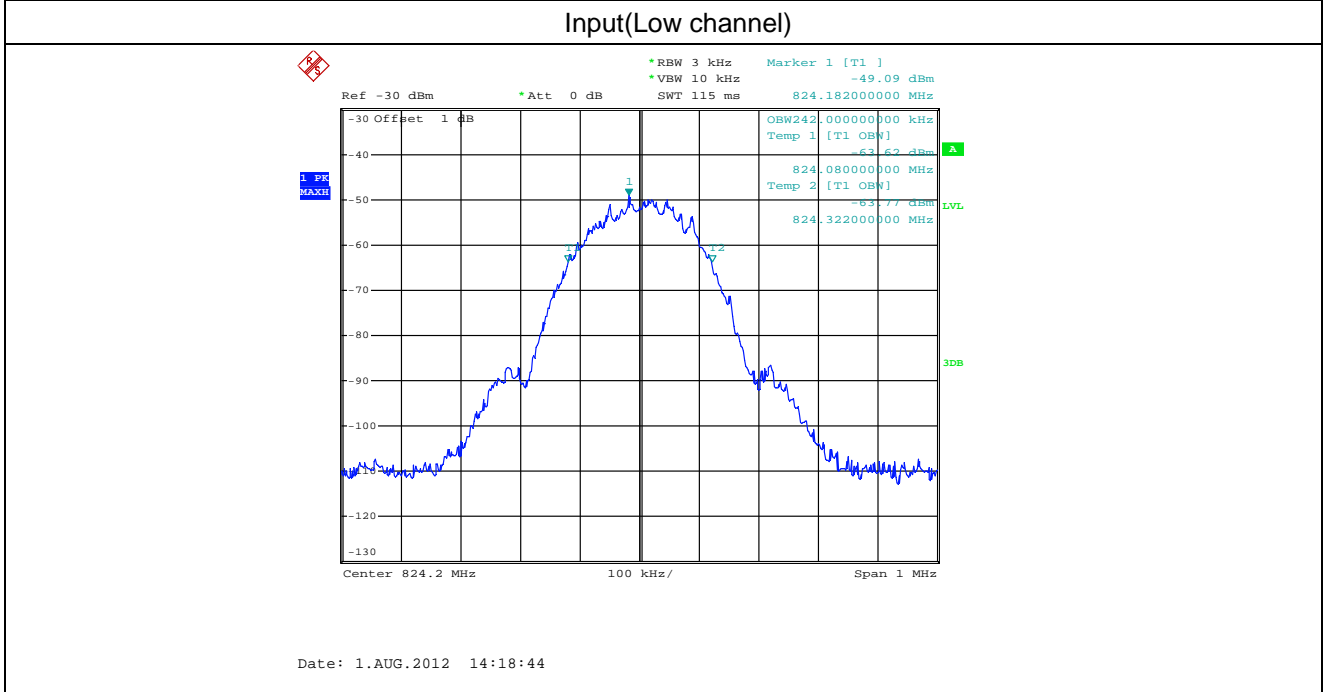
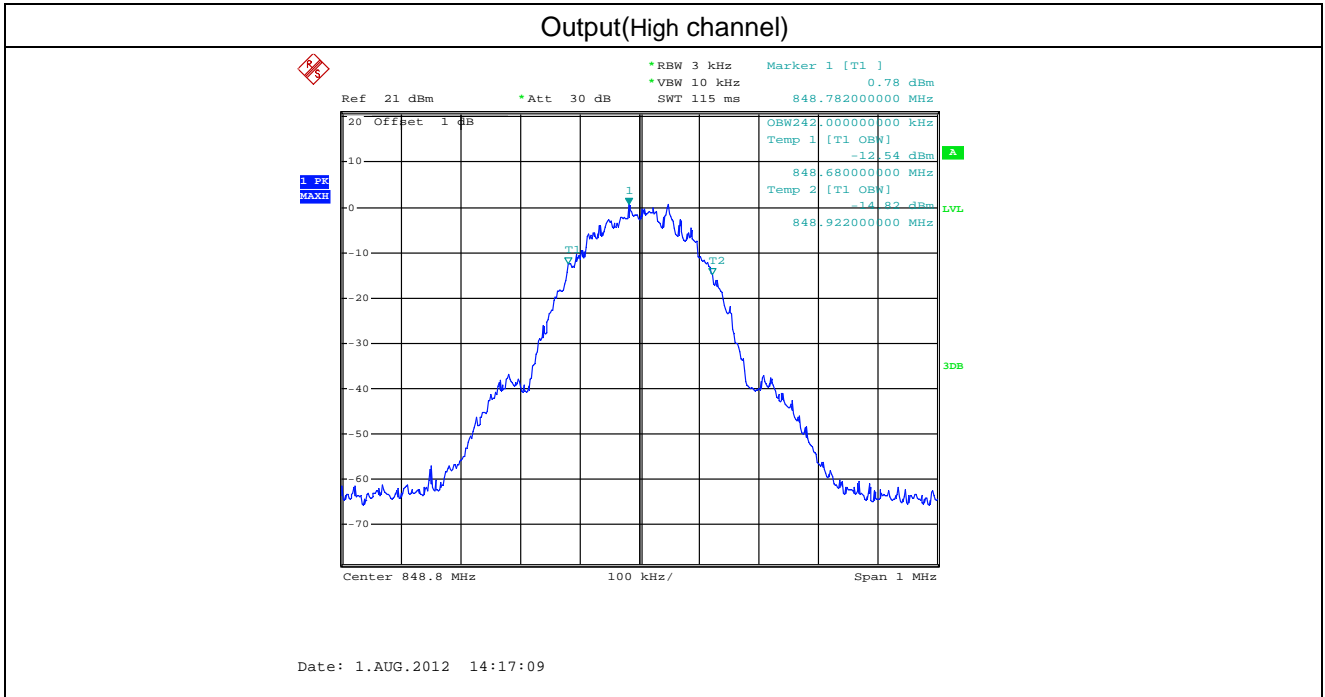

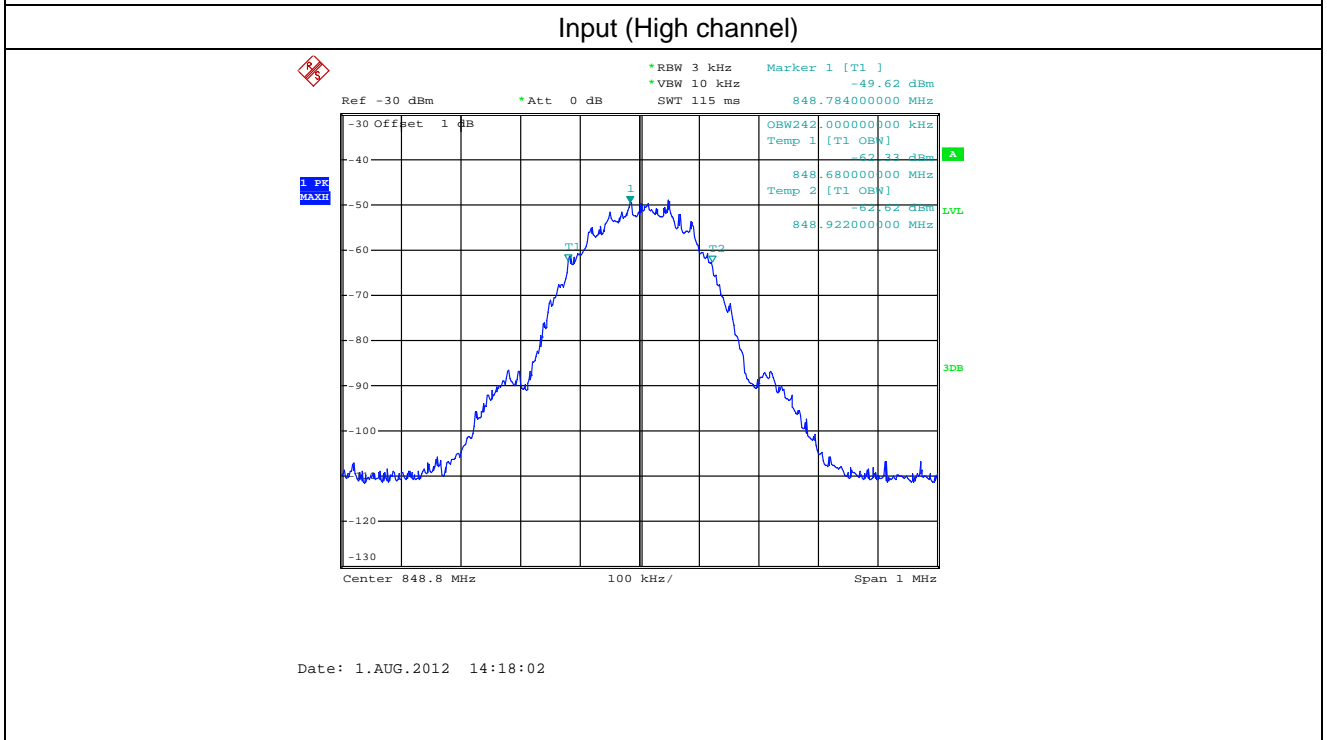
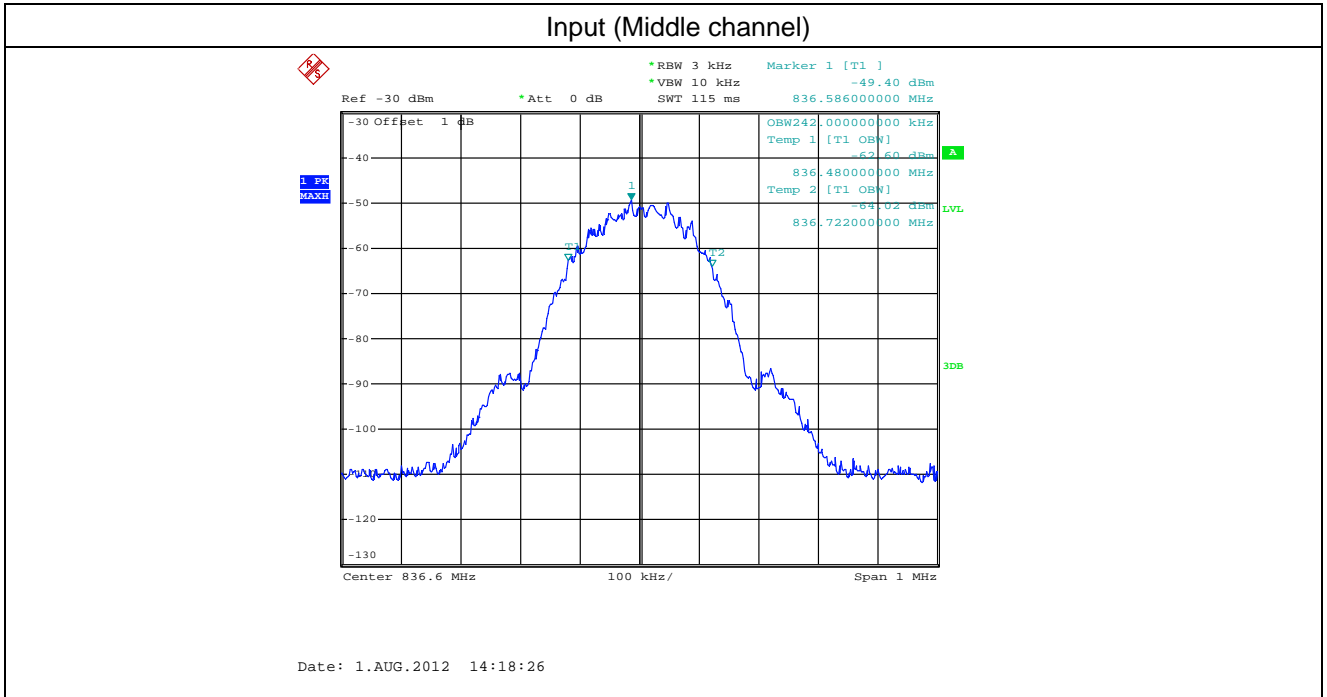

PCS1900 Downlink

Output(Low channel)

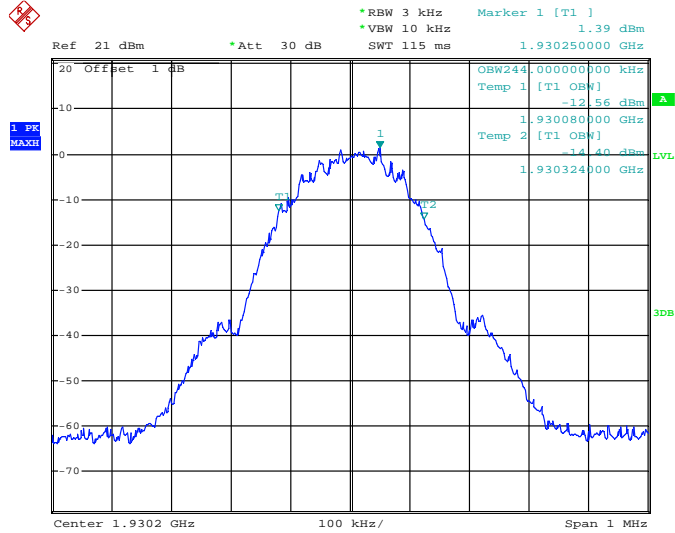

Date: 1.AUG.2012 15:30:57

Output(Middle channel)

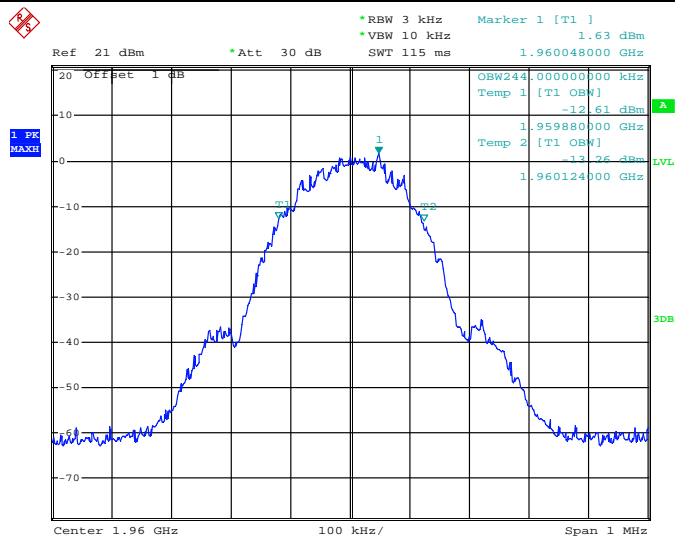

Date: 1.AUG.2012 15:31:49

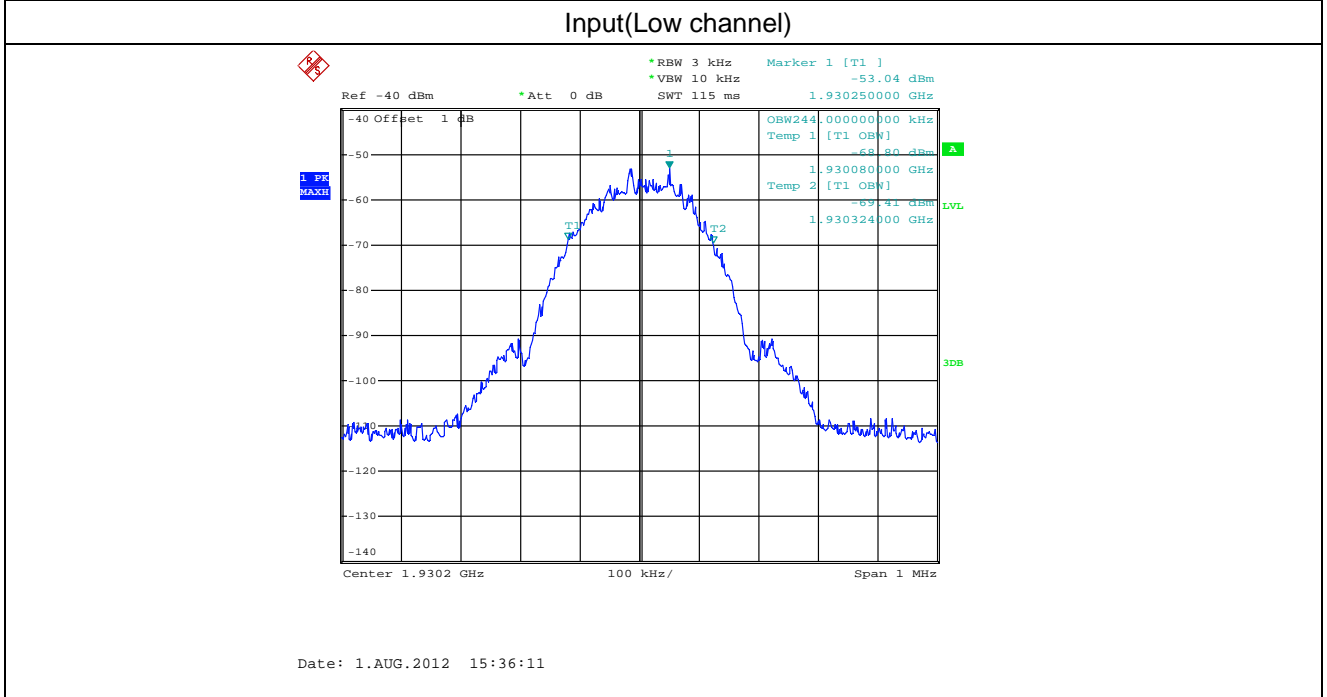
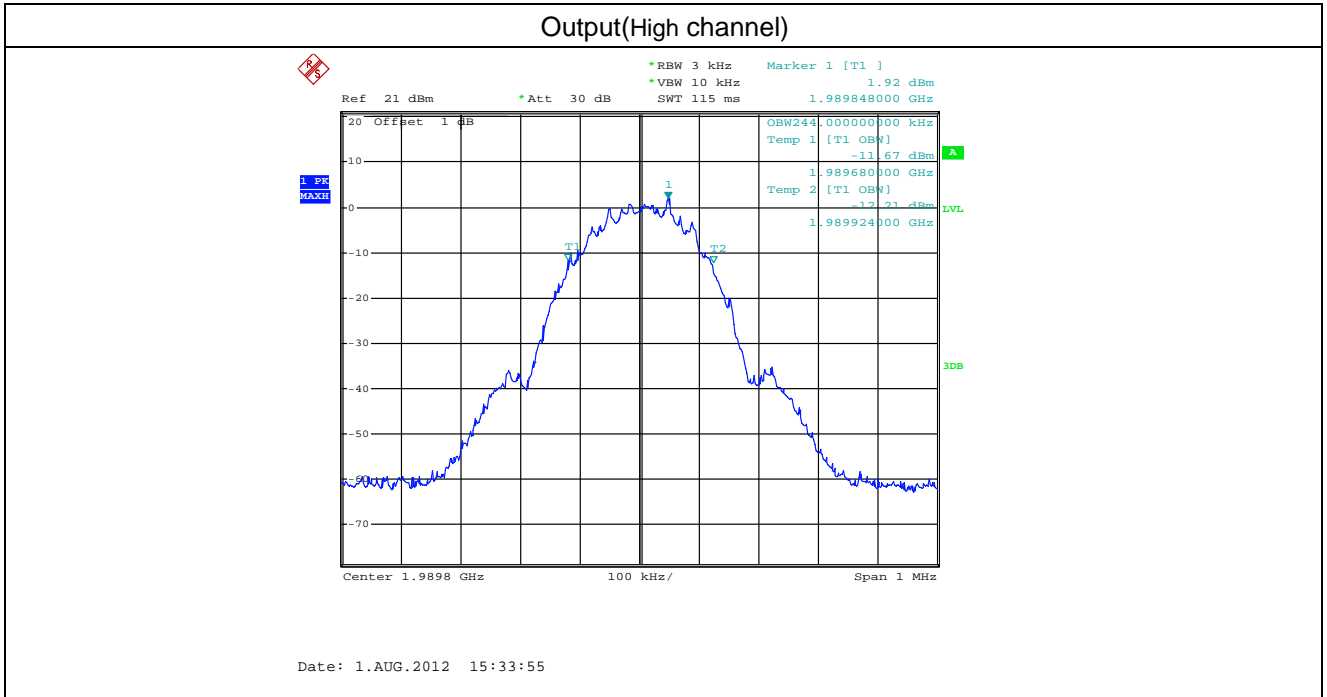

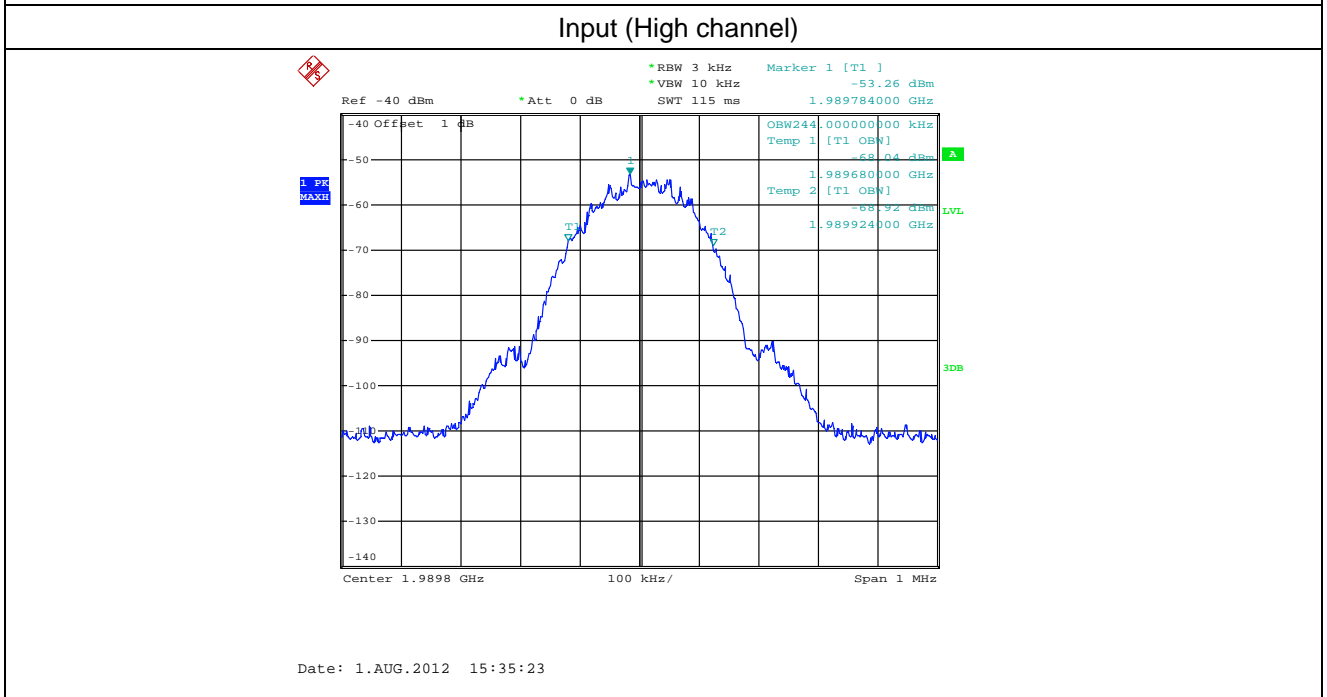
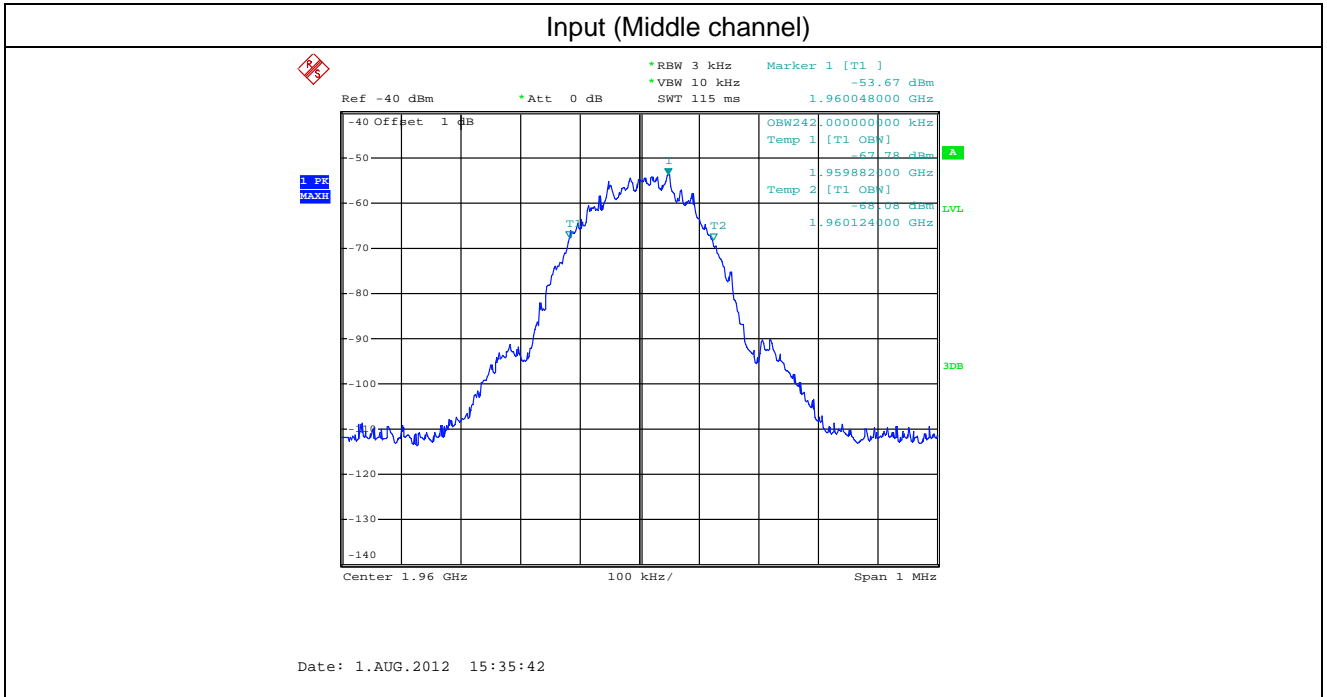

PCS1900 Uplink

Output(Low channel)

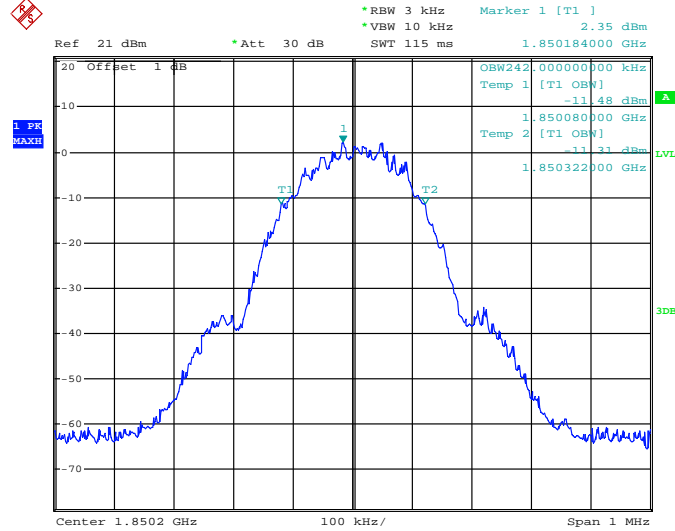

Date: 1.AUG.2012 15:27:28

Output(Middle channel)

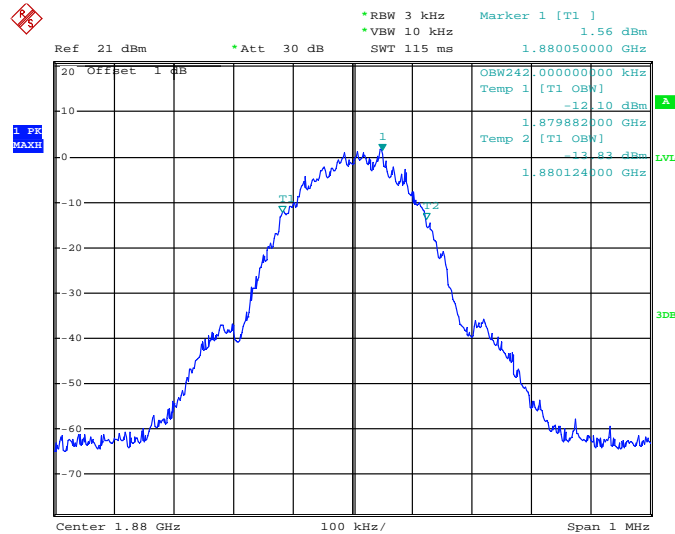

Date: 1.AUG.2012 15:28:05

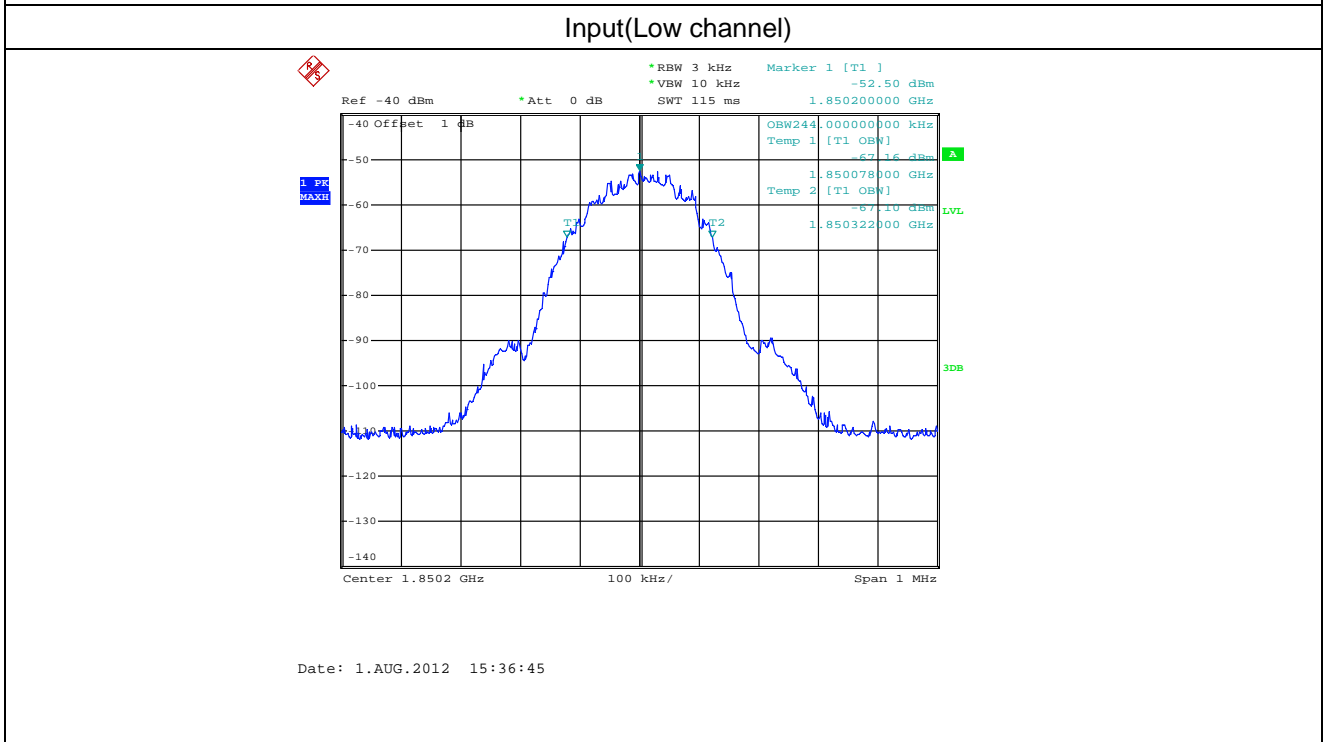
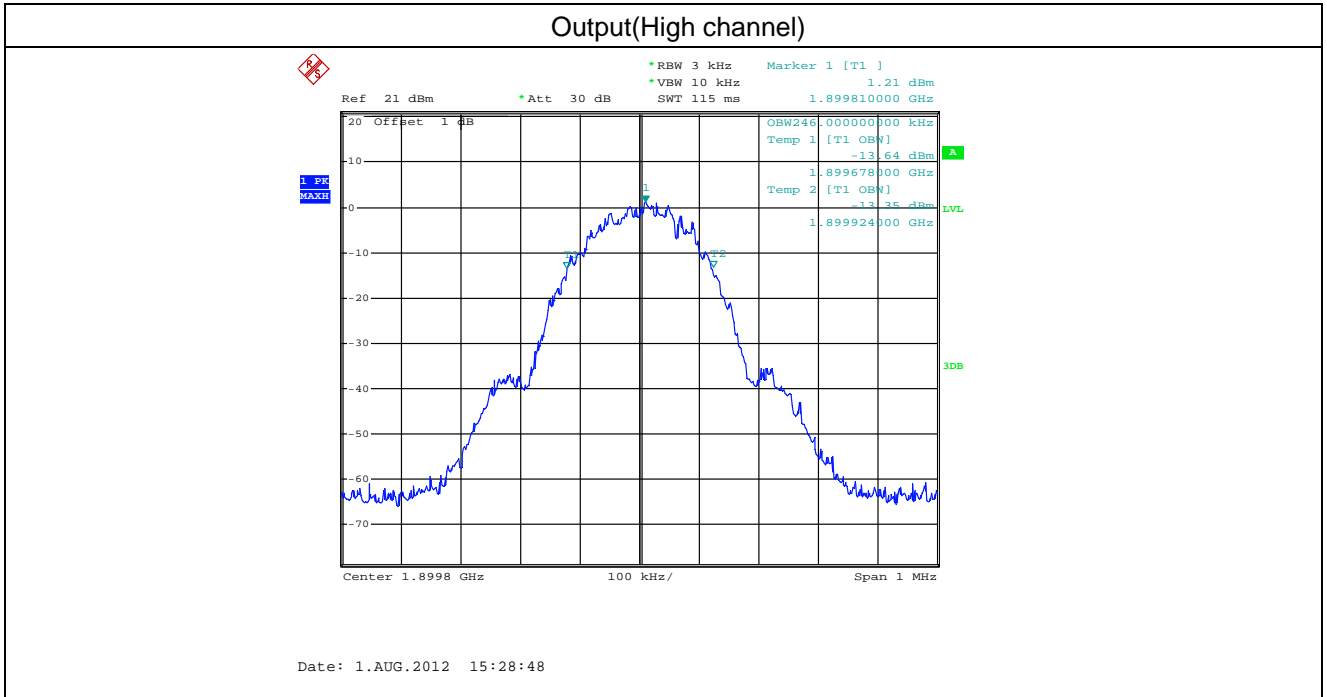

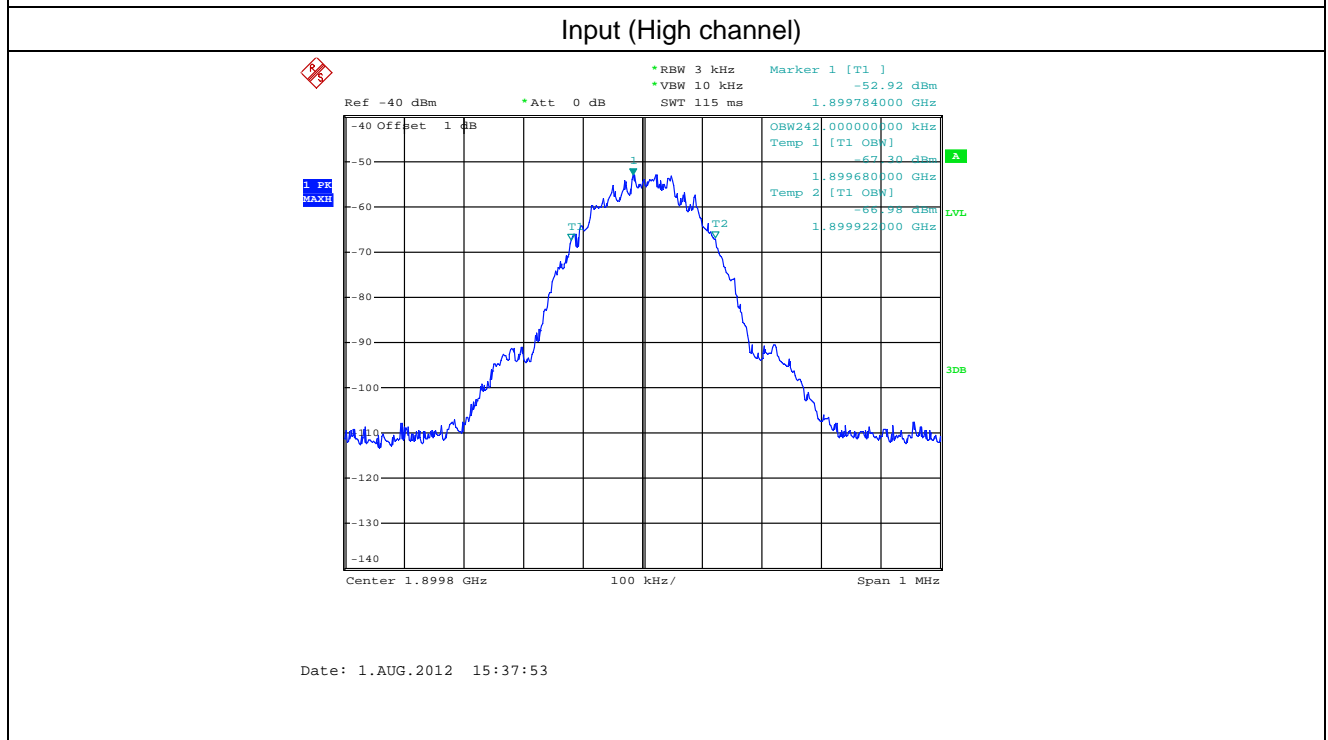
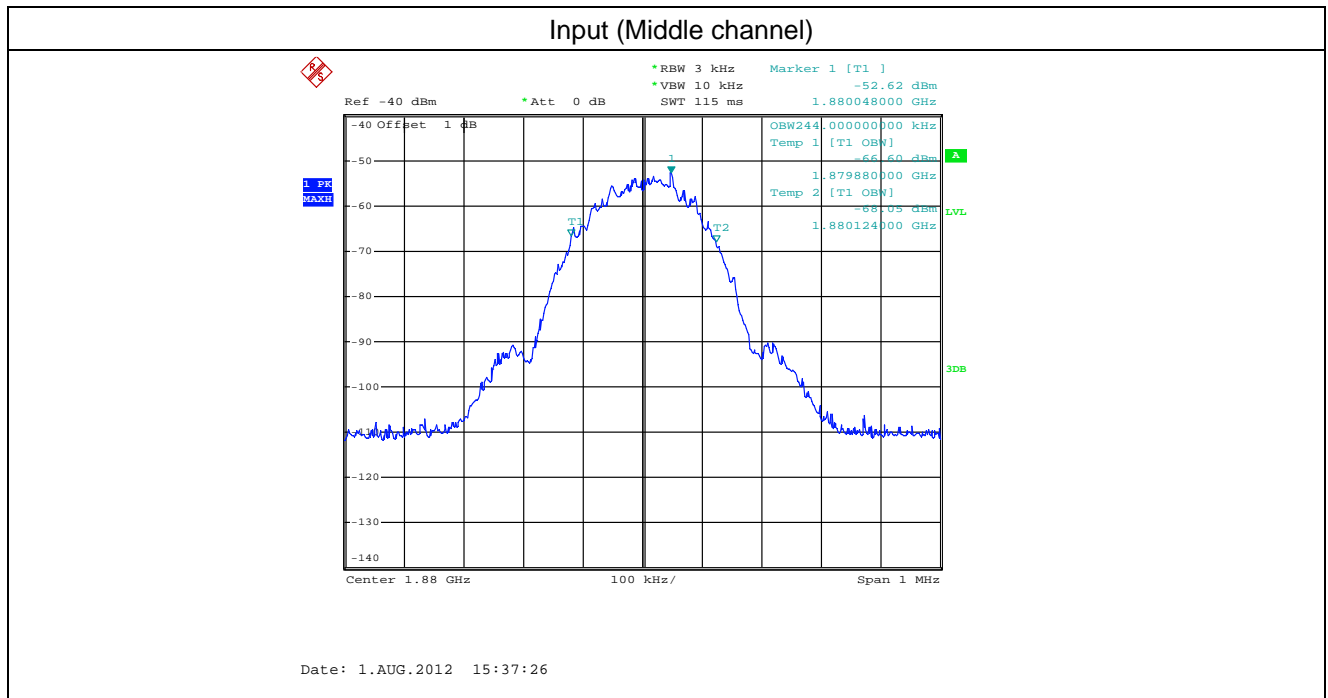

Input/output Bandwidth Comparison for CDMA

CDMA800 Downlink

Output(Low channel)

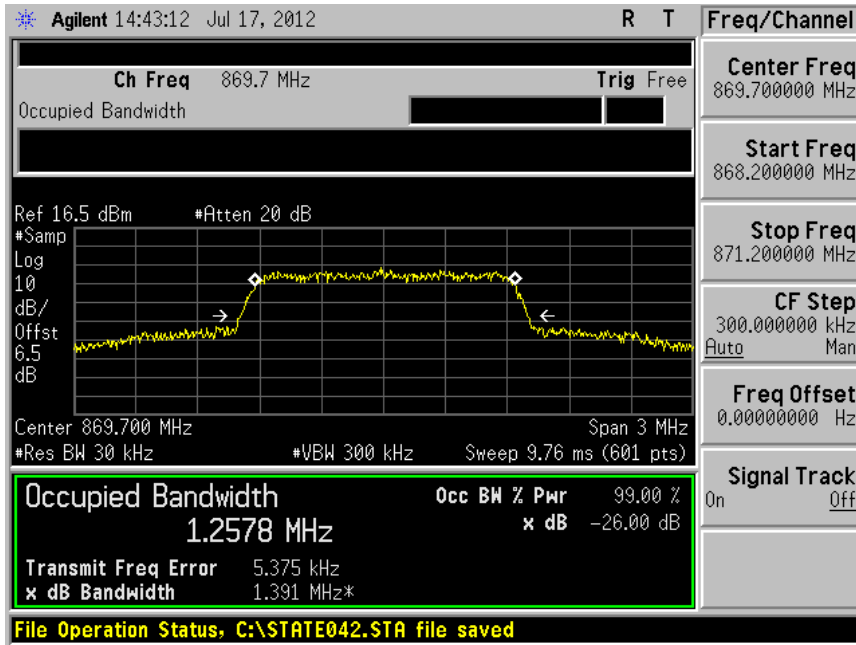

Output(Middle channel)

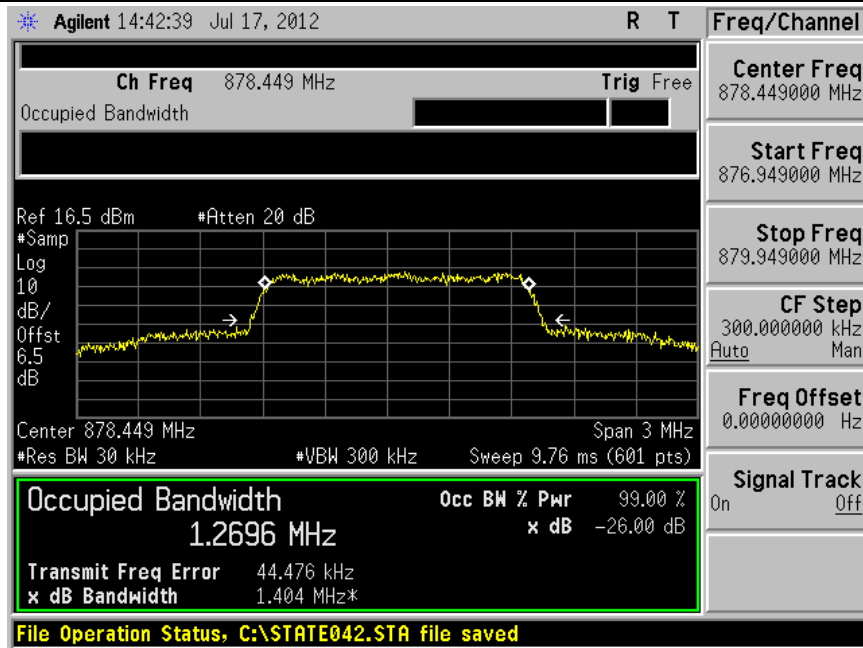

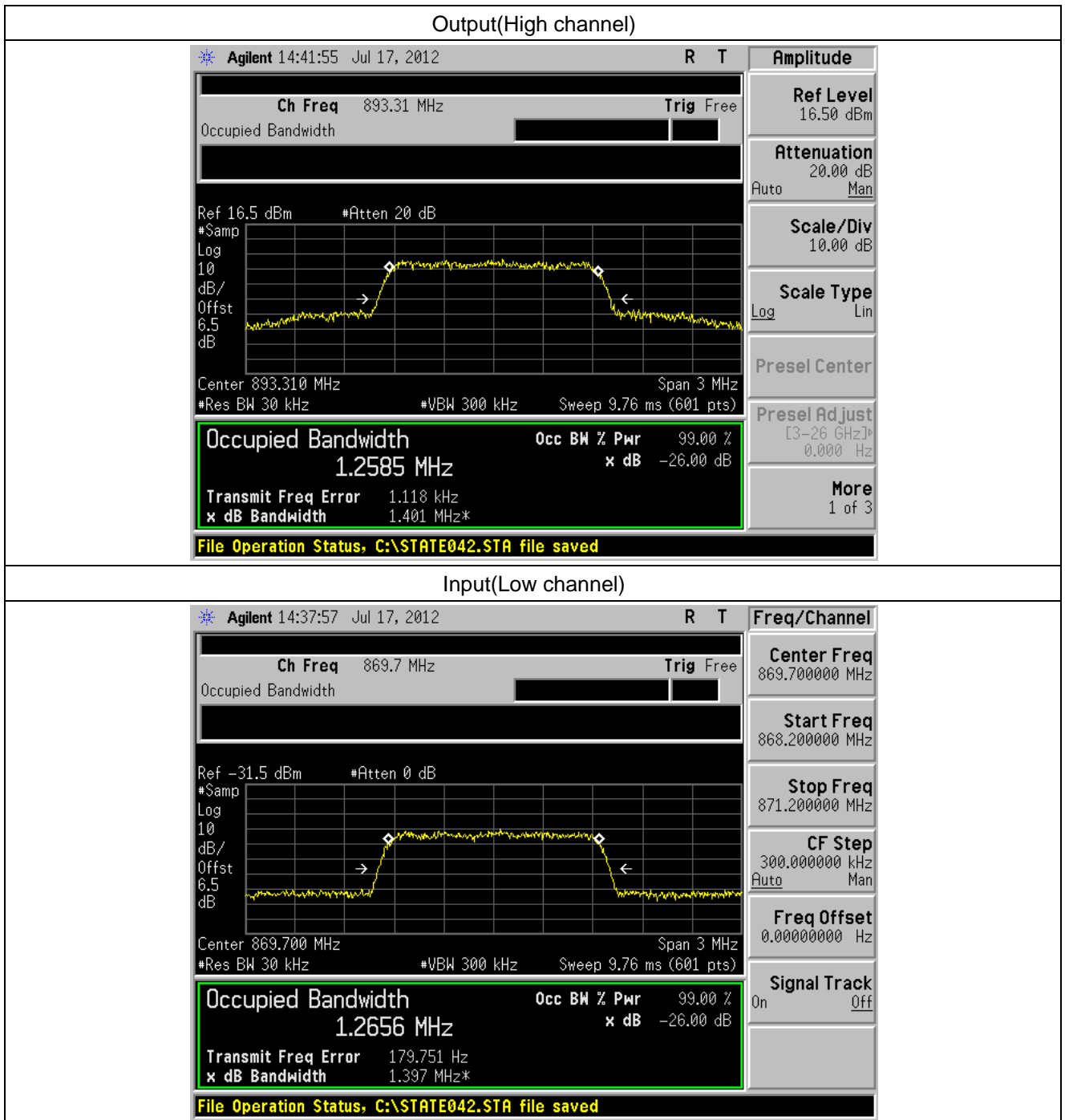

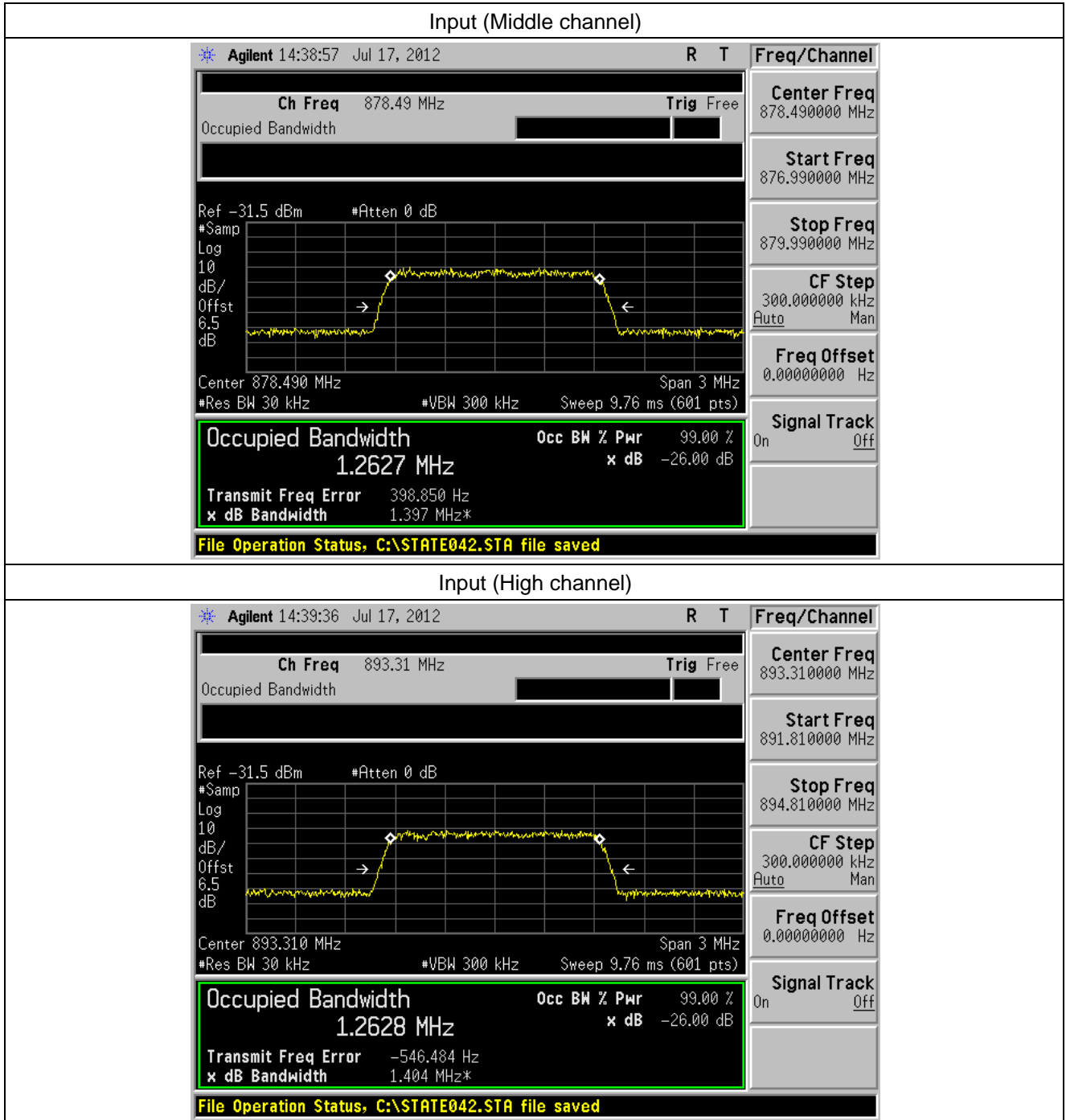

CDMA800 Uplink

Output(Low channel)

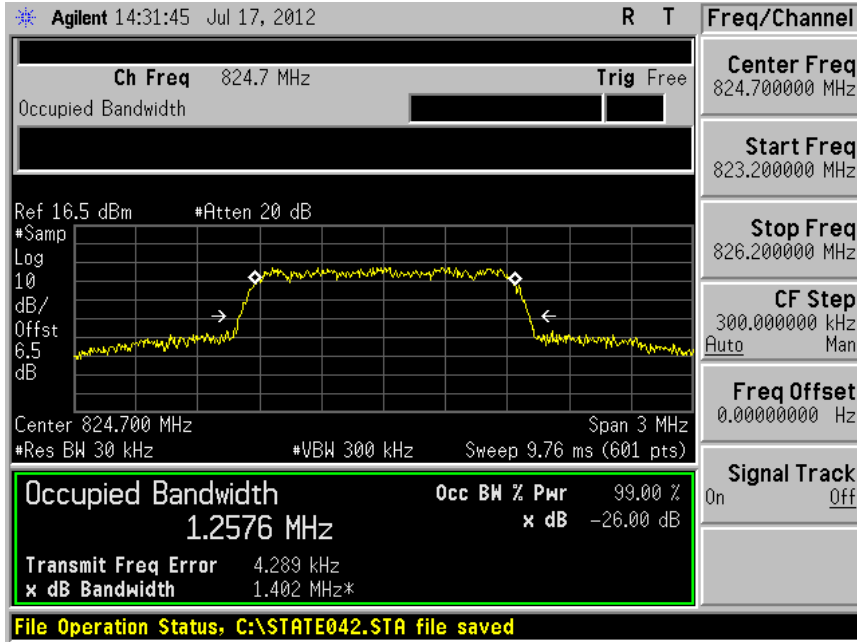

Output(Middle channel)

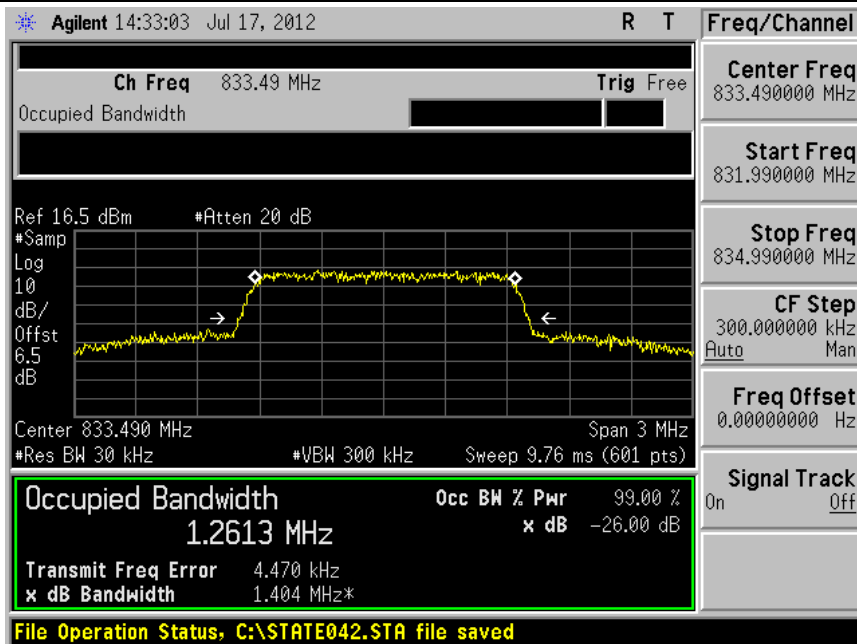

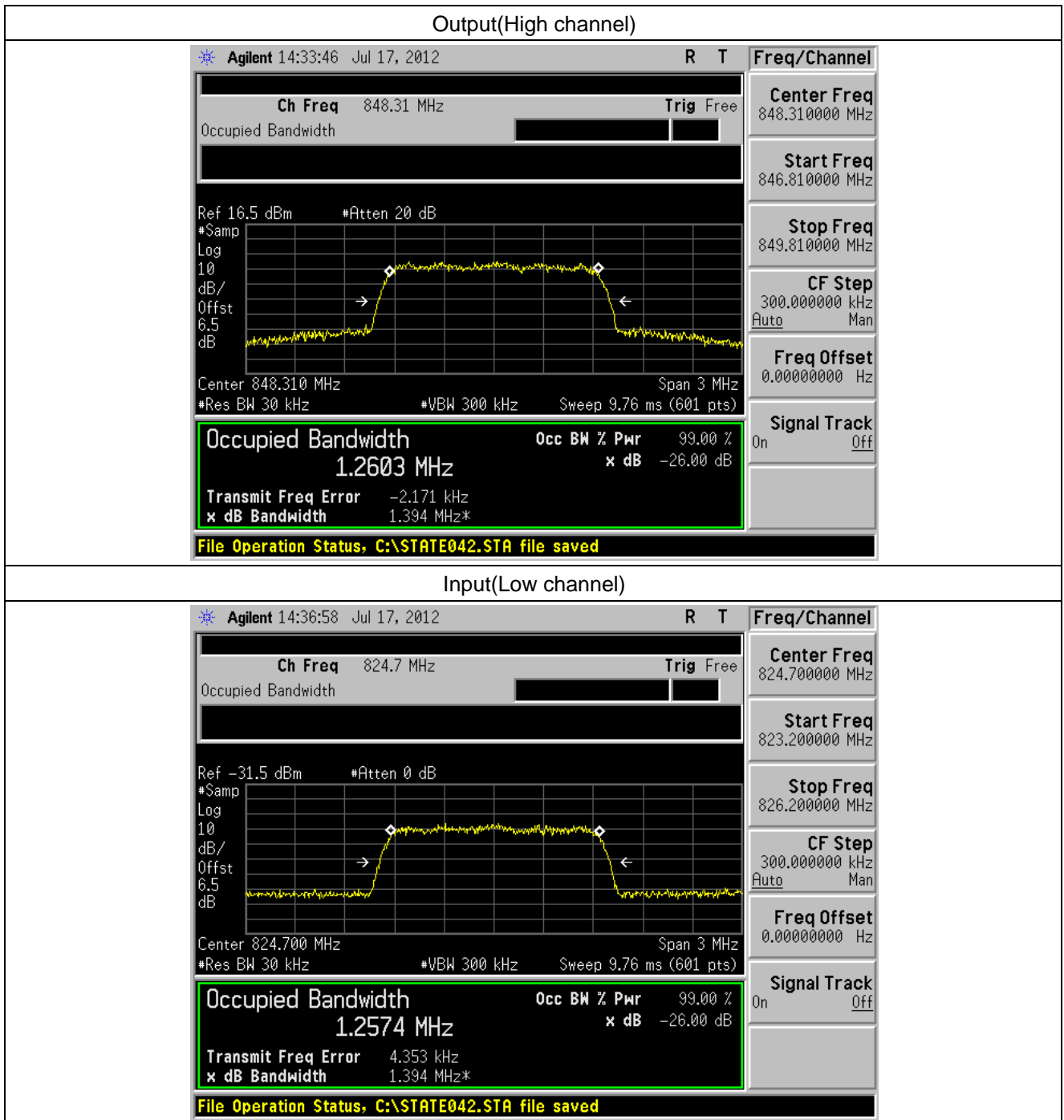

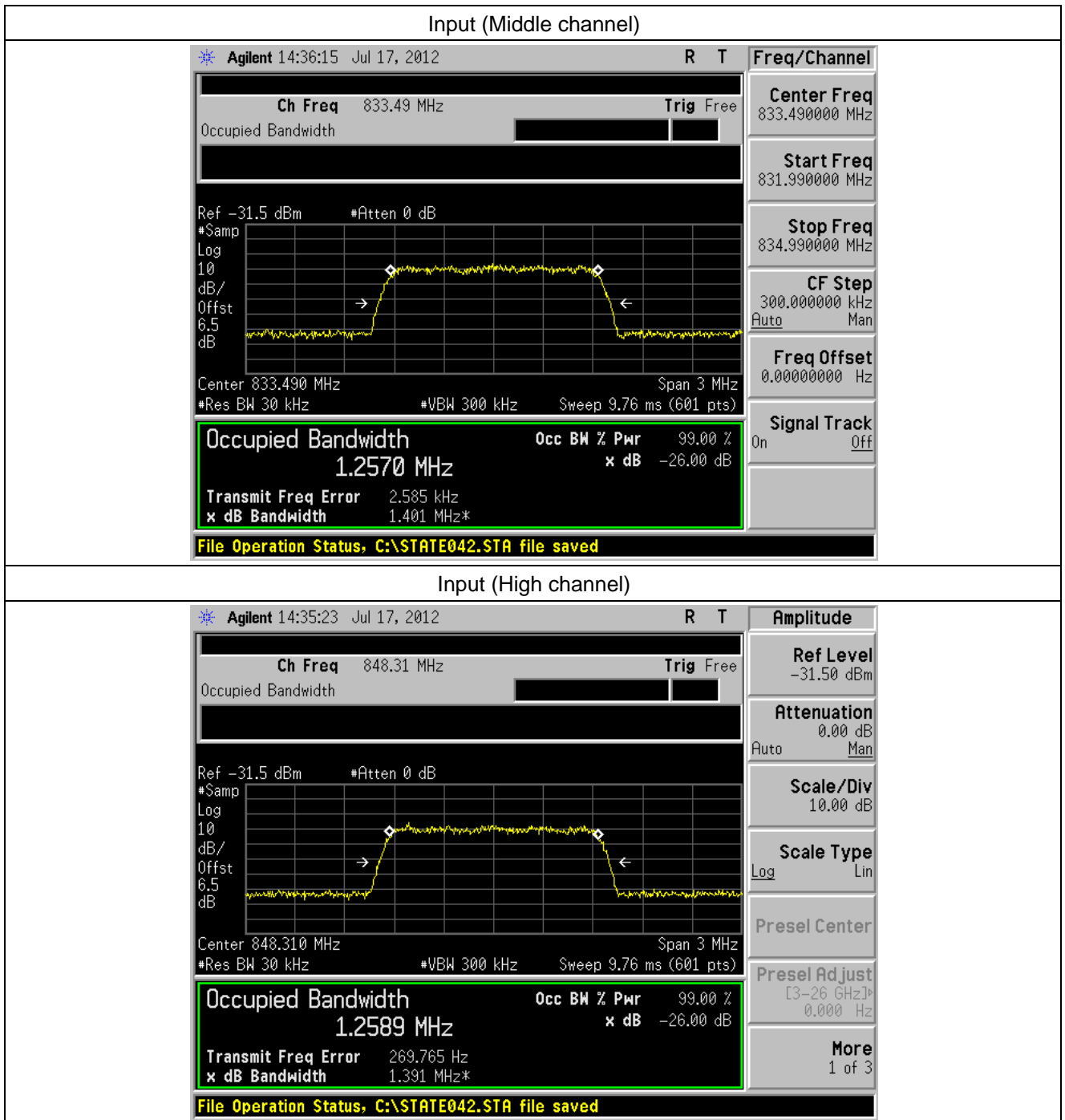

Input/output Bandwidth Comparison for CDMA

CDMA1900 Downlink

Output(Low channel)

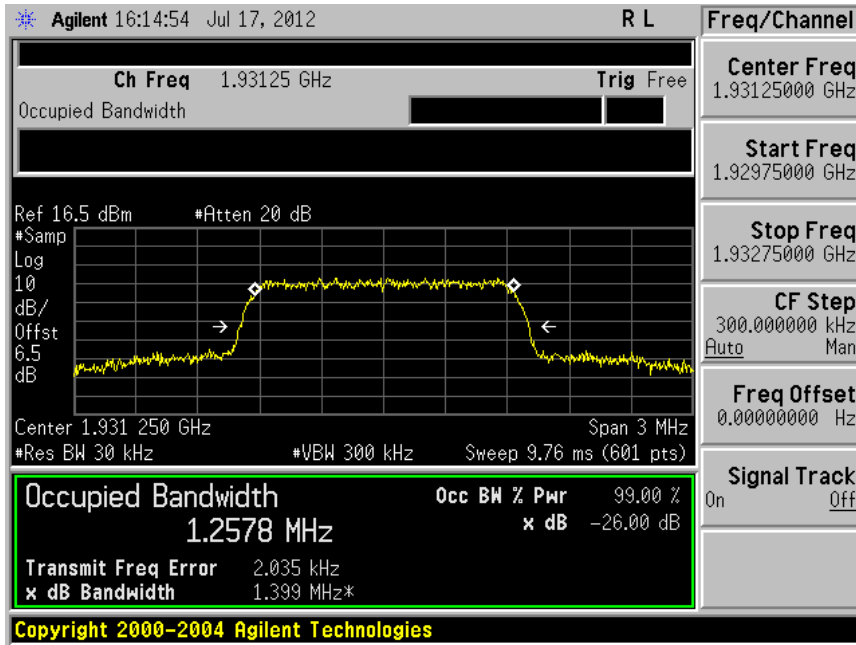

Output(Middle channel)

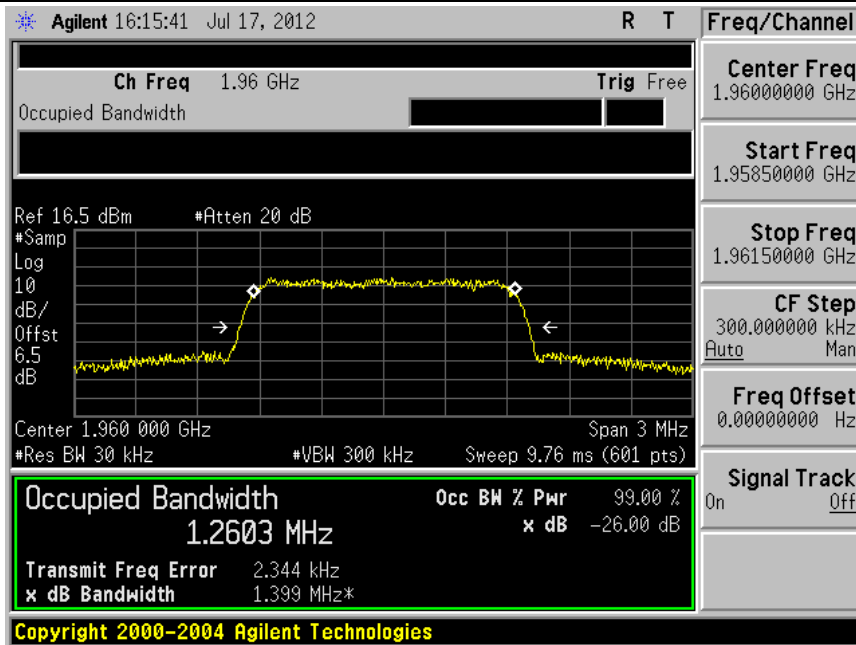

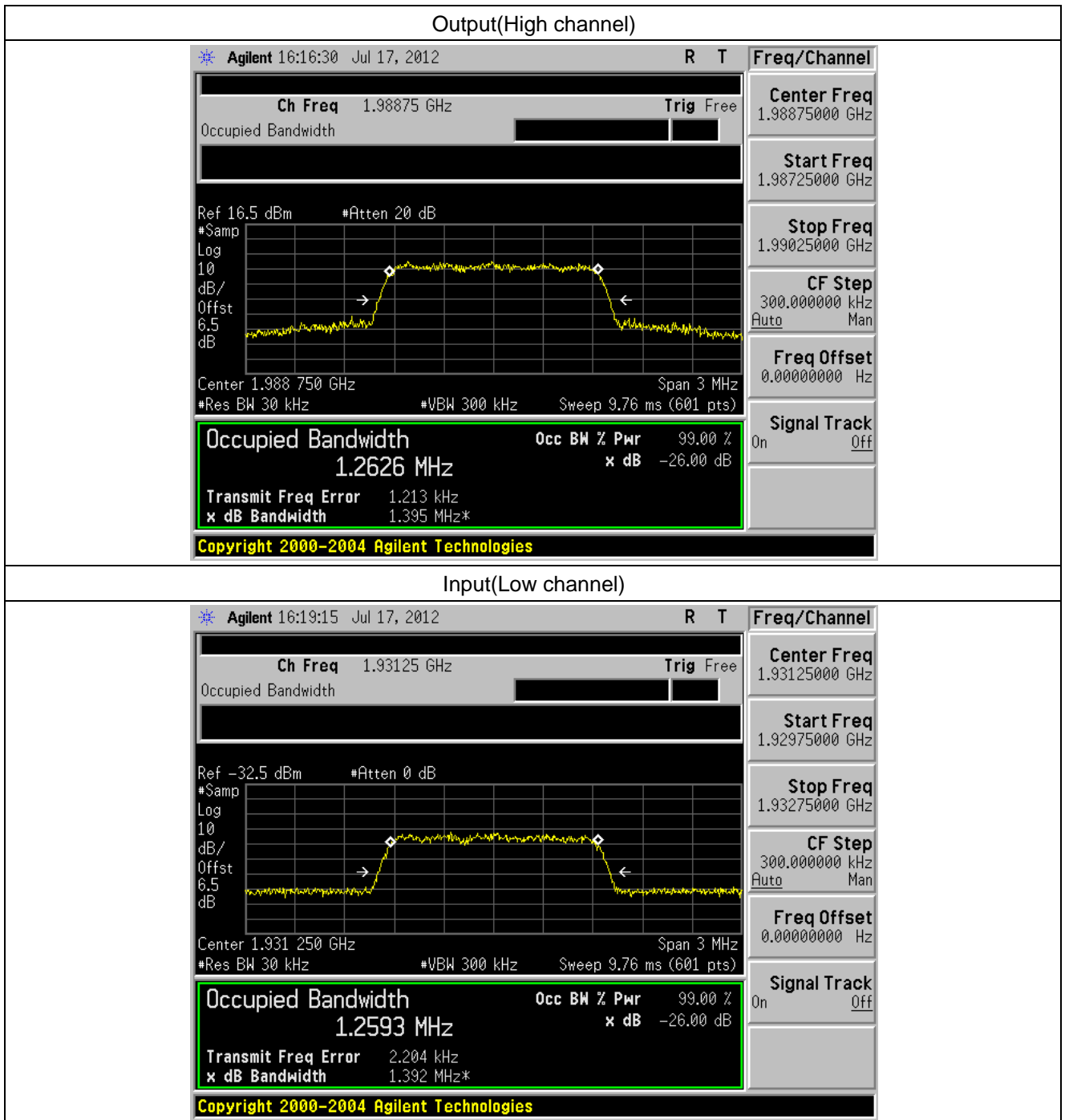

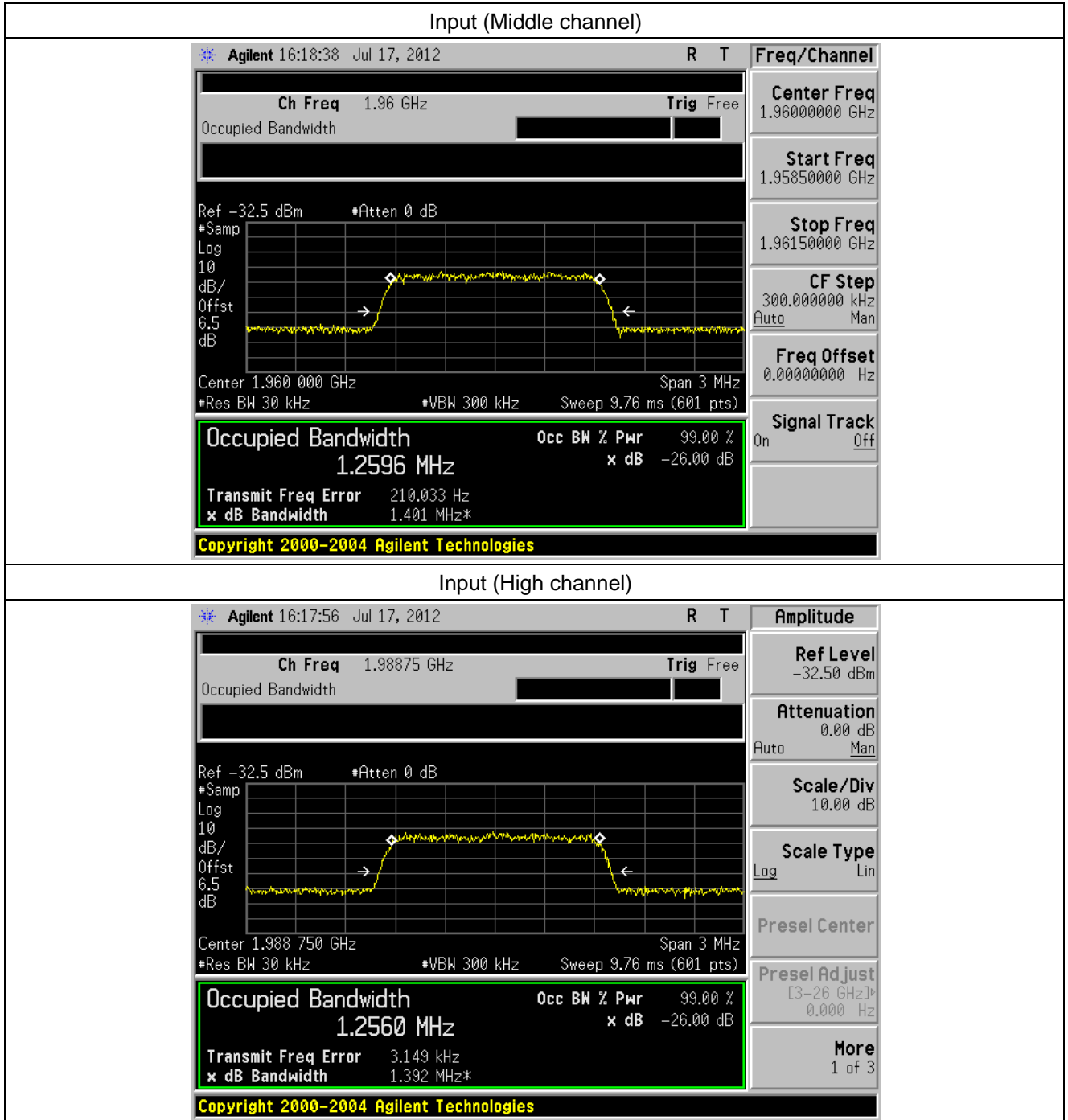

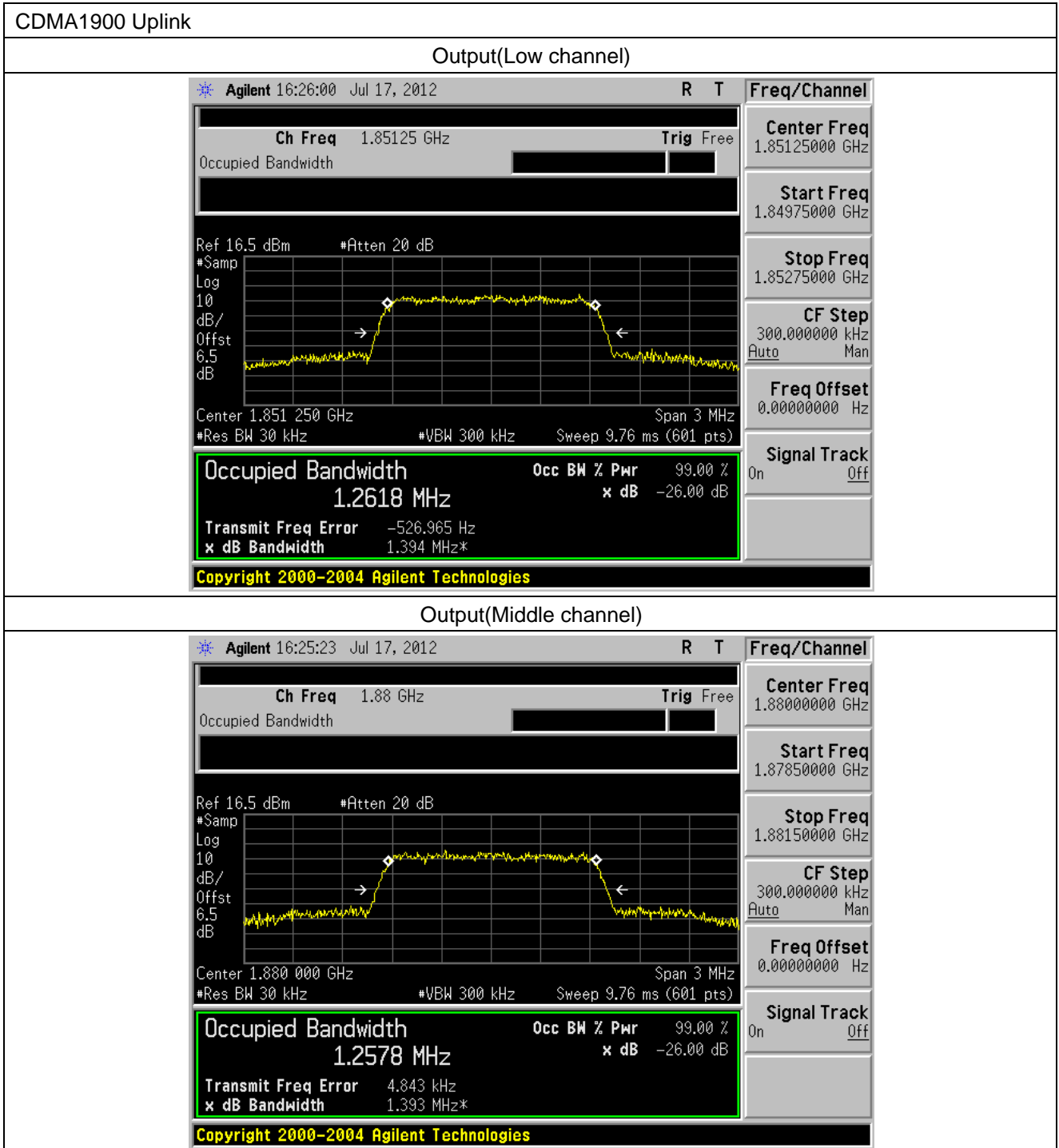

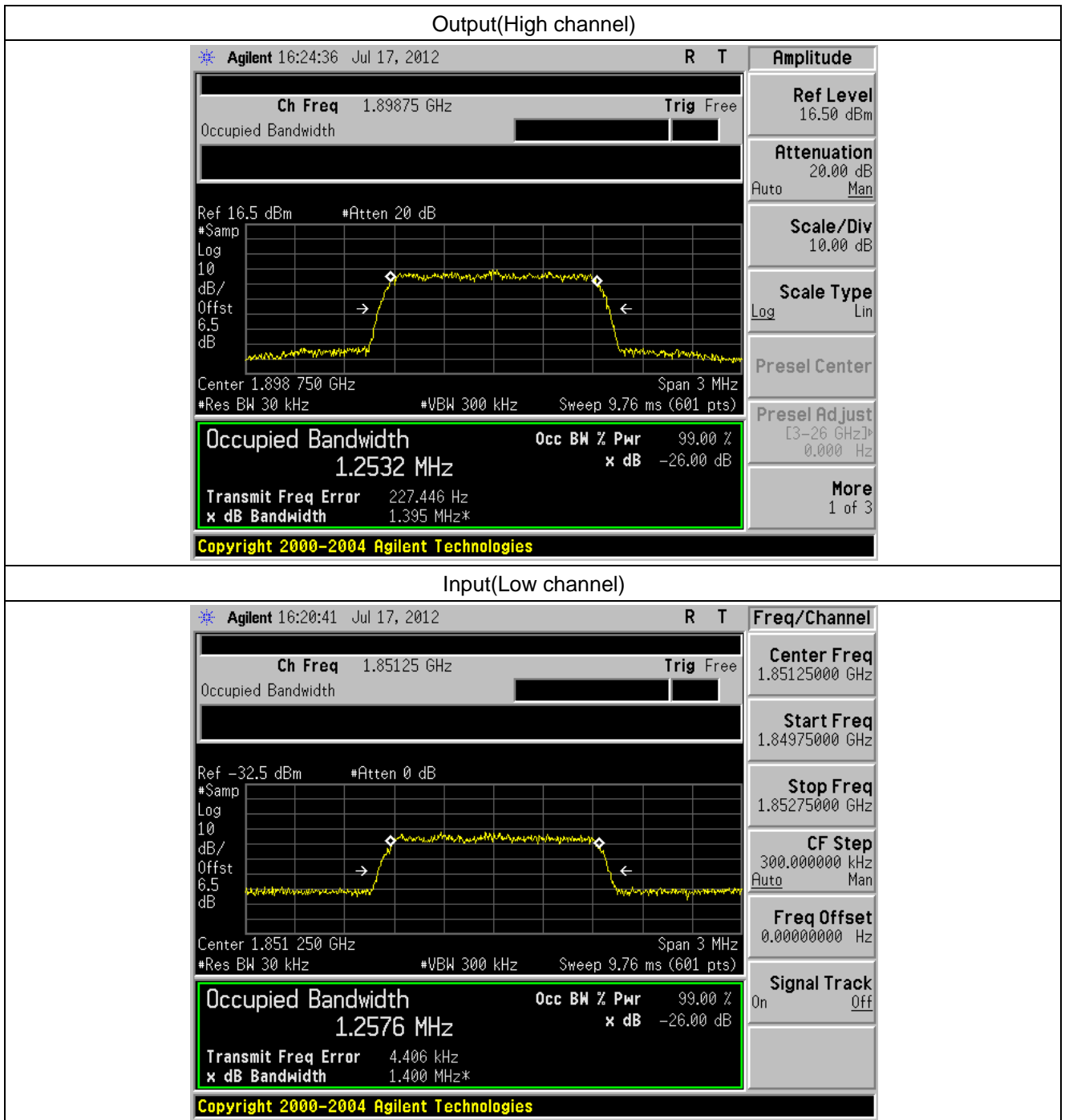

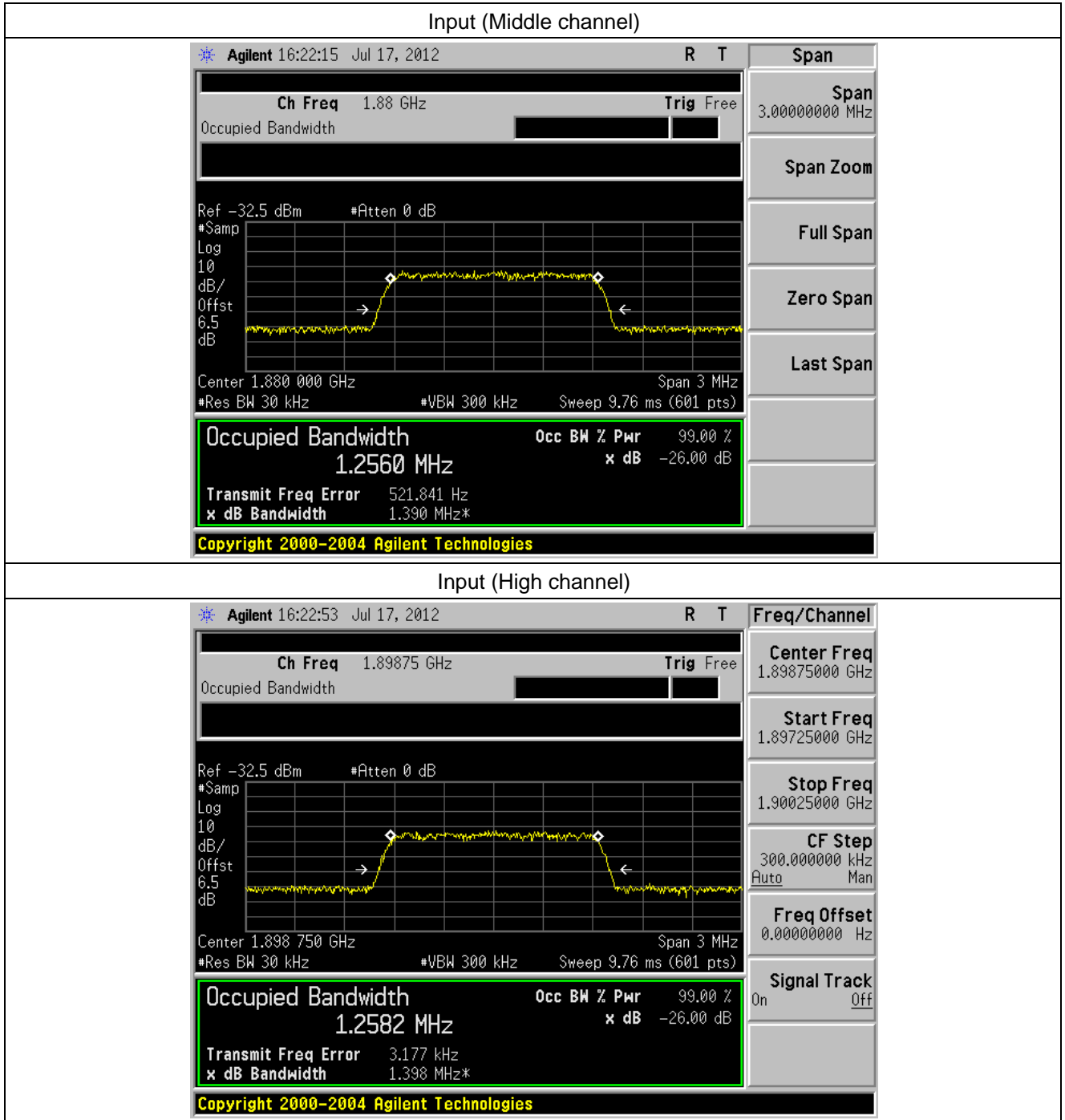

9 SPURIOUS EMISSION AT ANTENNA TERMINALS

9.1 Standard Applicable

According to FCC §2.105,§22.917(a),§24.238(a) and 2-11-04/EAB/RF.

9.2 Test setup

Please refer the section § 6.2 Configuration of Tested System.

9.3 Measurement Procedure

The out of band emissions were measured directly from the EUT antenna output with a spectrum analyzer from 30 MHz to the 10th harmonic of the highest carrier frequency. Test signals used are GSM and CDMA. The different signals were input one at a time to the EUT

Band edge compliance is also demonstrated using a GSM and CDMA signal at the upper and lower limits of the band.

1. The EUT RF output port was connected to spectrum analyzer.
2. The level of RF input signal shall be increased, until the maximum output power per channel, declared by client, is reached.
3. The spurious emissions at antenna were measured at the RF output port of the EUT at middle channel of each type of modulation.

9.4 Measurement Result

9.4.1 Spurious emission

Spurious emission of GSM

GSM 850 Downlink

(Low channel) 30MHz-10GHz

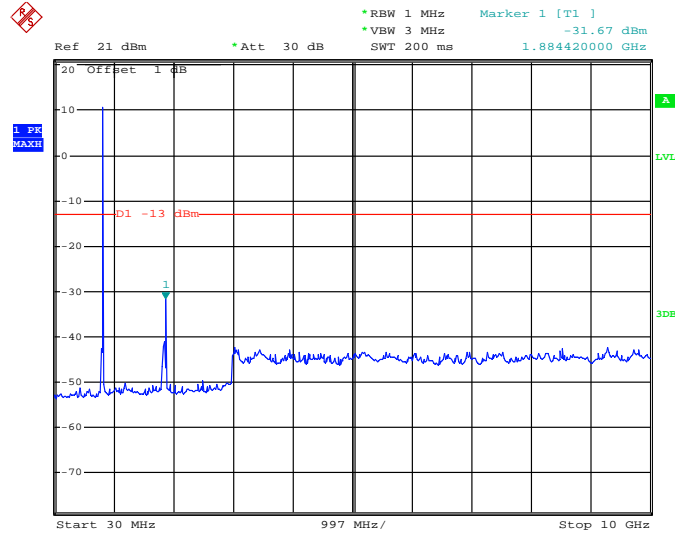

Date: 1.AUG.2012 14:25:55

(Middle channel) 30MHz-10GHz

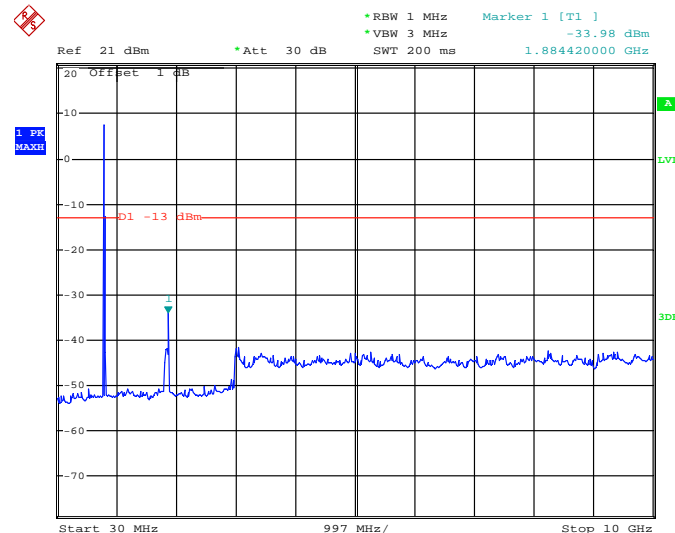

Date: 1.AUG.2012 14:26:24

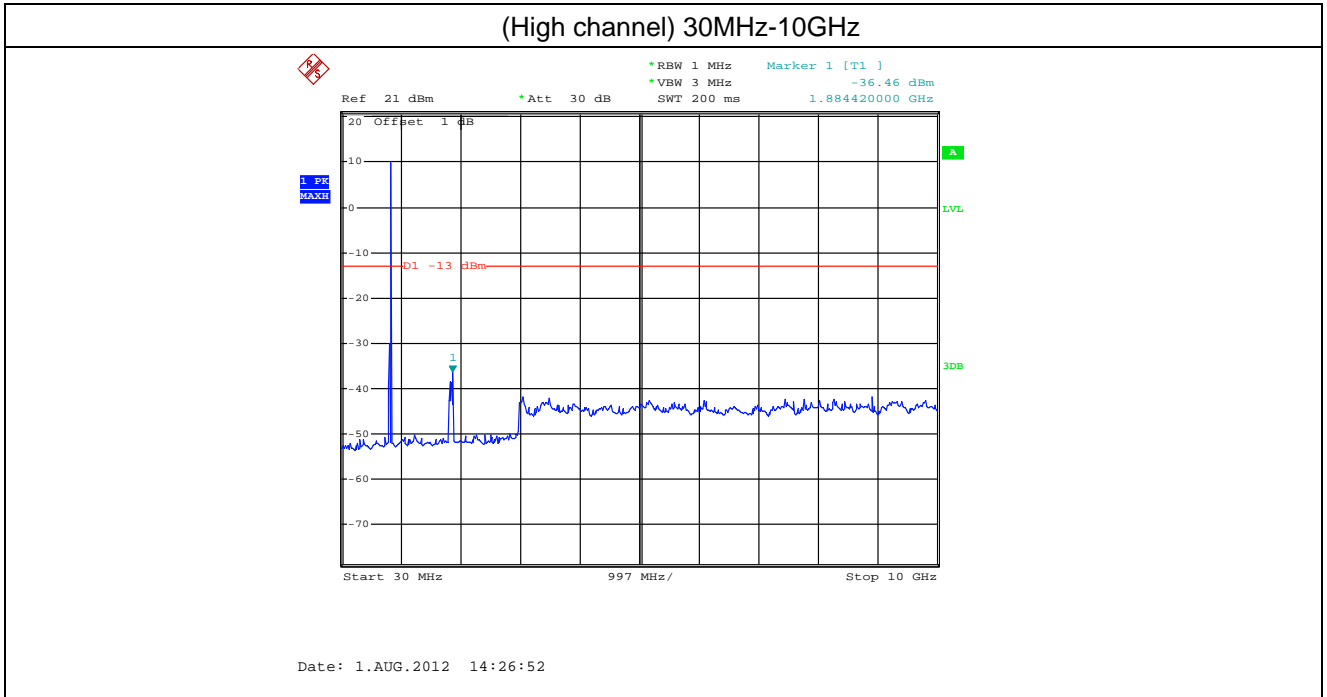

GSM 850 Uplink

(Low channel) 30MHz-10GHz

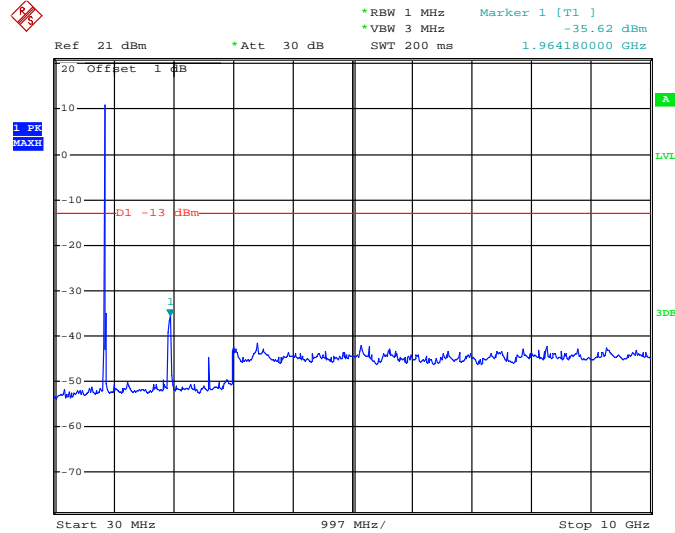

Date: 1.AUG.2012 14:28:23

(Middle channel) 30MHz-10GHz

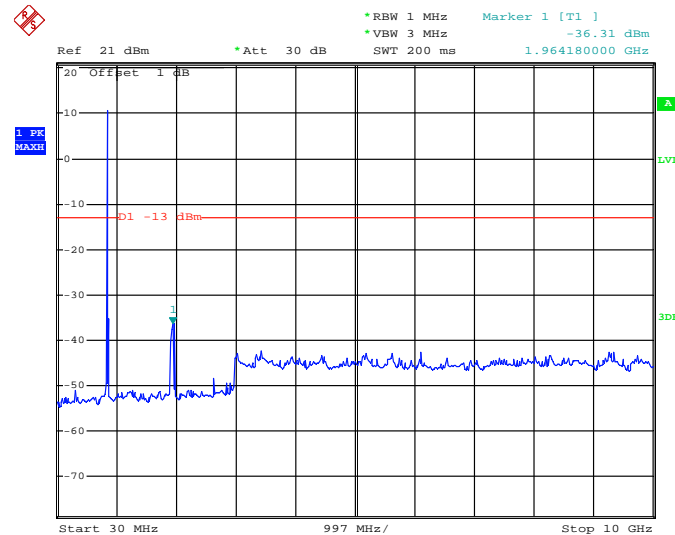

Date: 1.AUG.2012 14:29:02

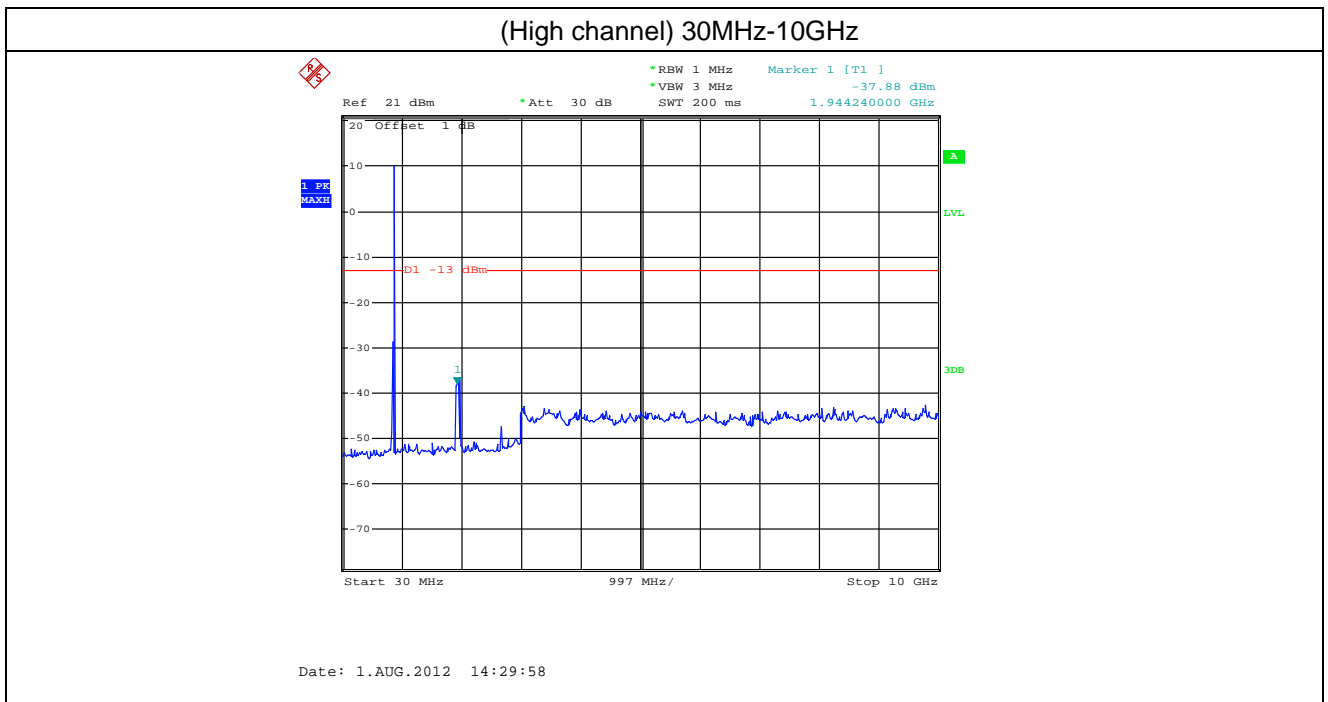

PCS1900 Downlink

(Low channel) 30MHz-20GHz

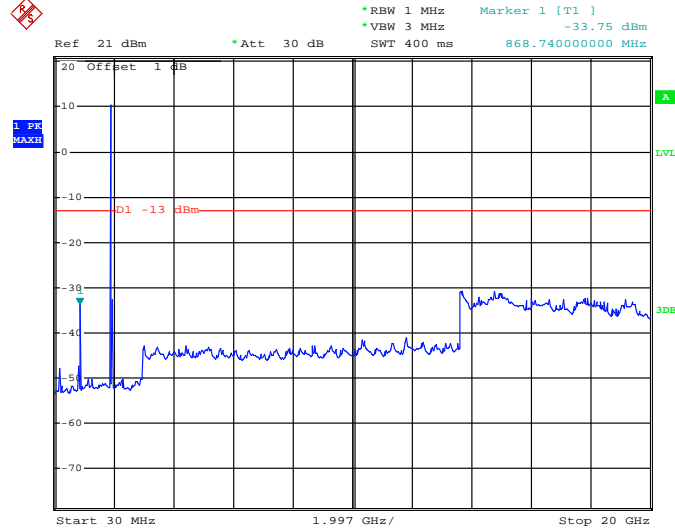

Date: 1.AUG.2012 15:50:38

(Middle channel) 30MHz-20GHz

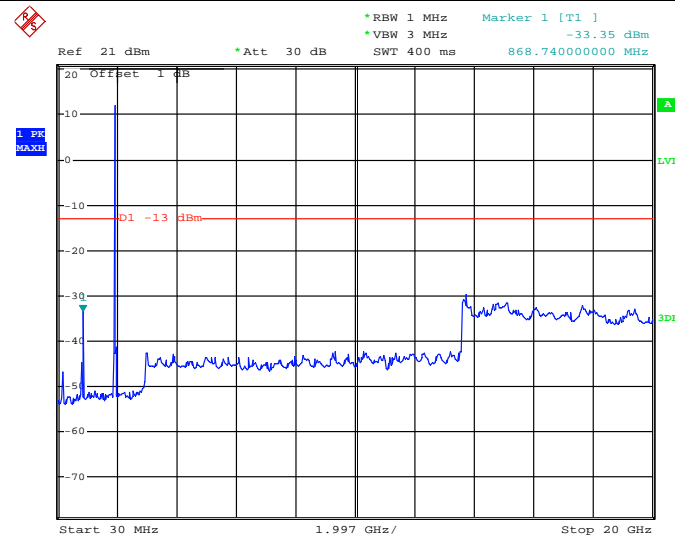

Date: 1.AUG.2012 15:51:00

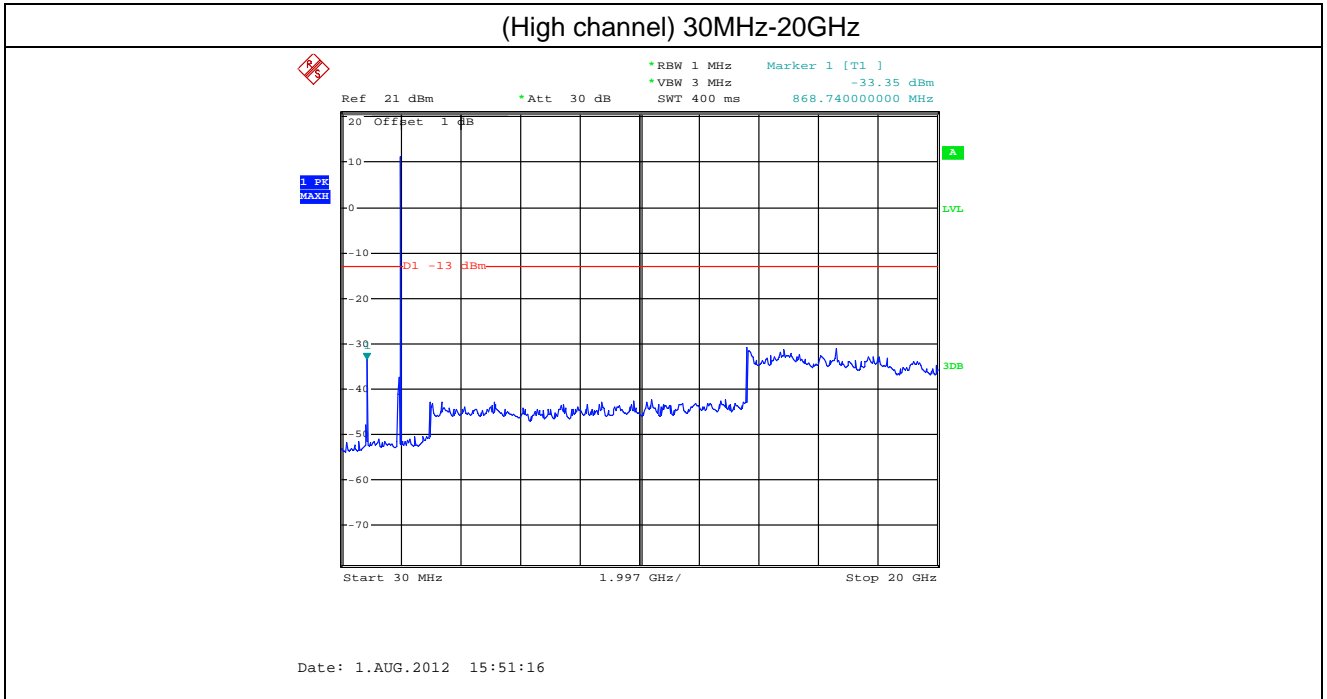

PCS1900 Uplink

(Low channel) 30MHz-20GHz

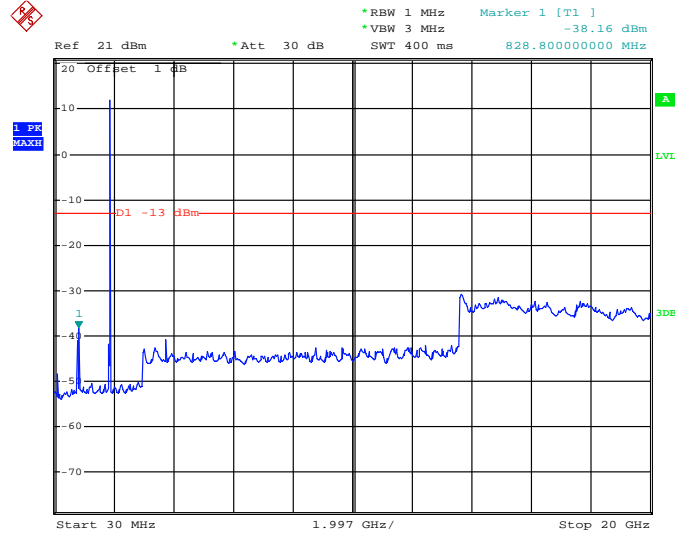

Date: 1.AUG.2012 15:48:39

(Middle channel) 30MHz-20GHz

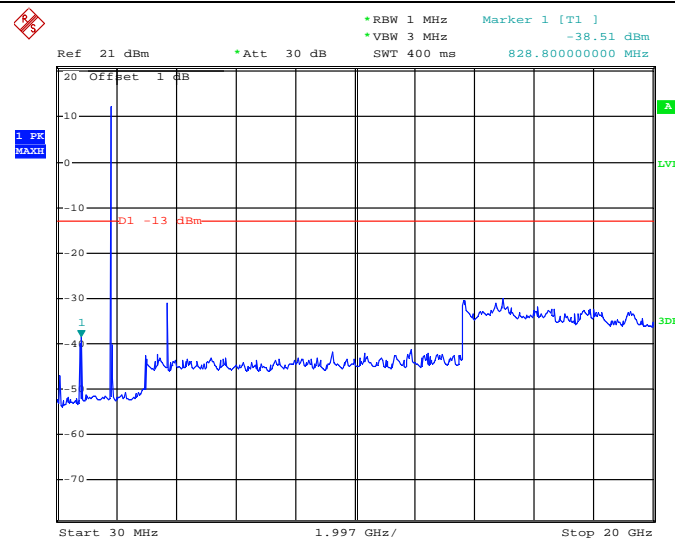

Date: 1.AUG.2012 15:49:09

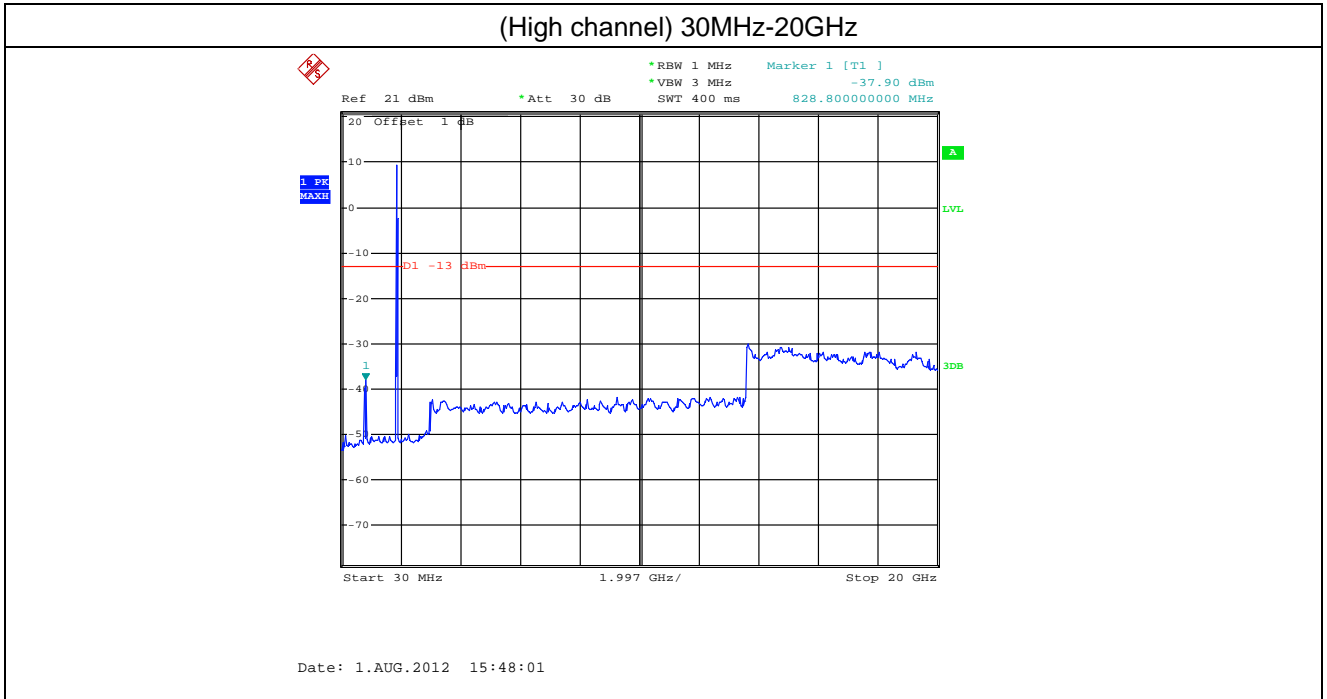

Spurious emission of CDMA

CDMA800 Downlink

Low channel(30MHz-6GHz)

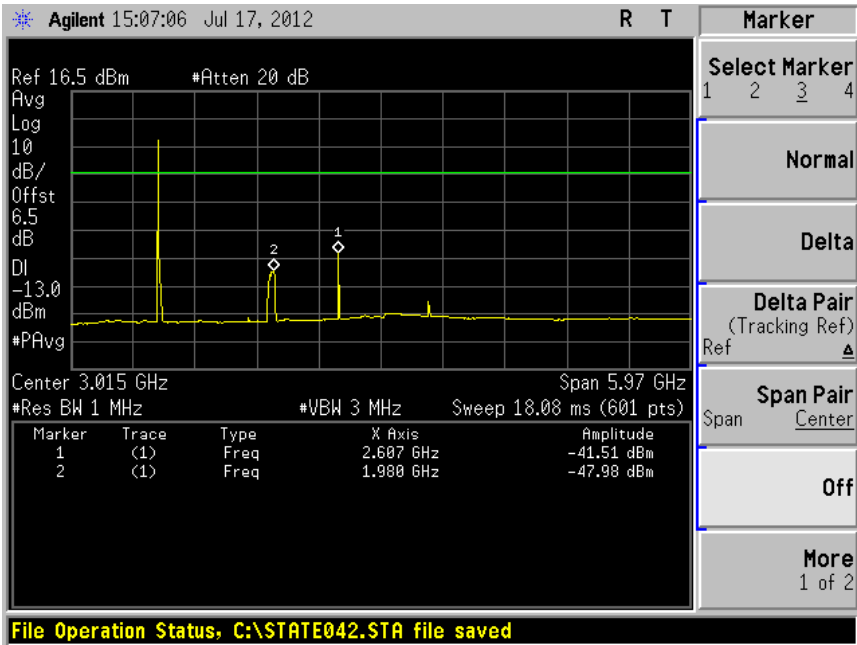

6GHz-10GHz

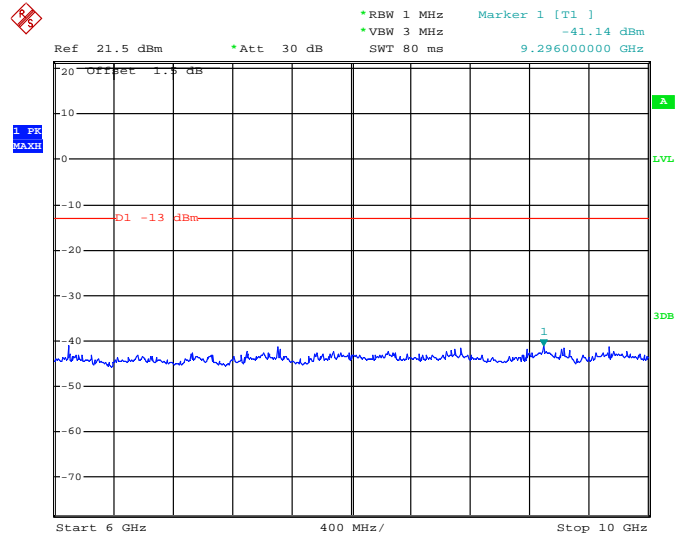

Date: 7.AUG.2012 06:03:27

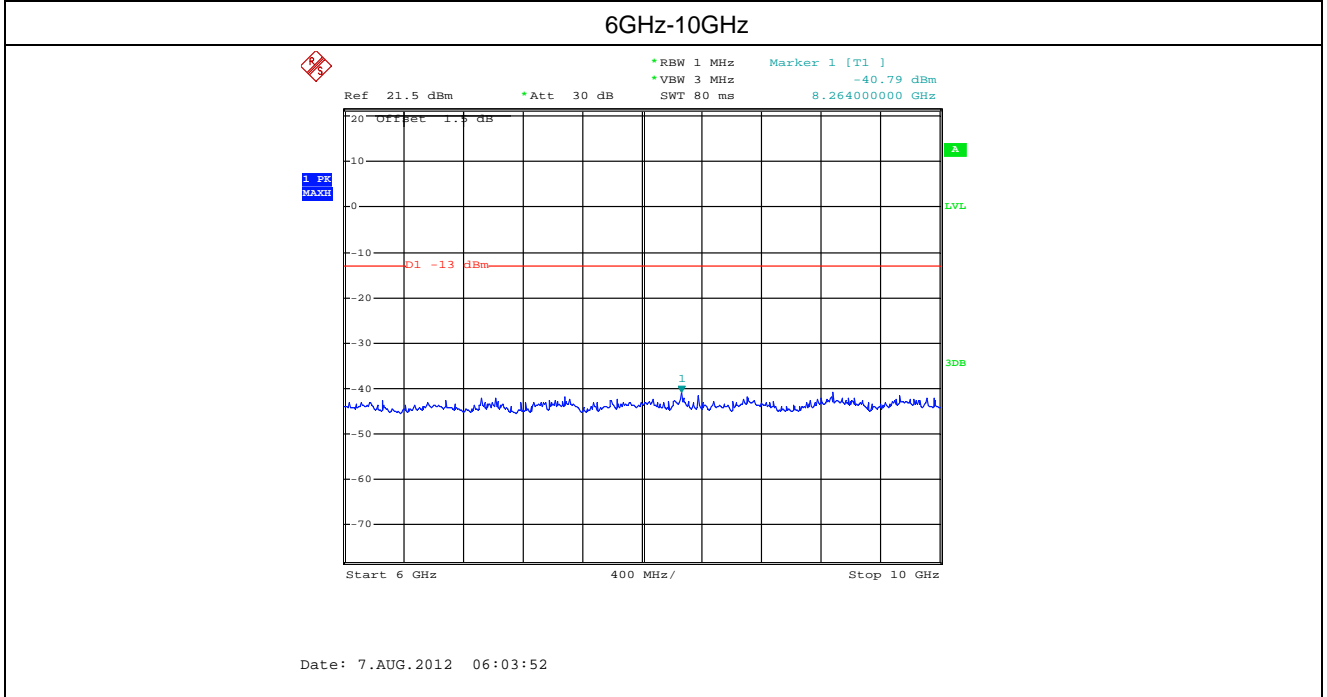
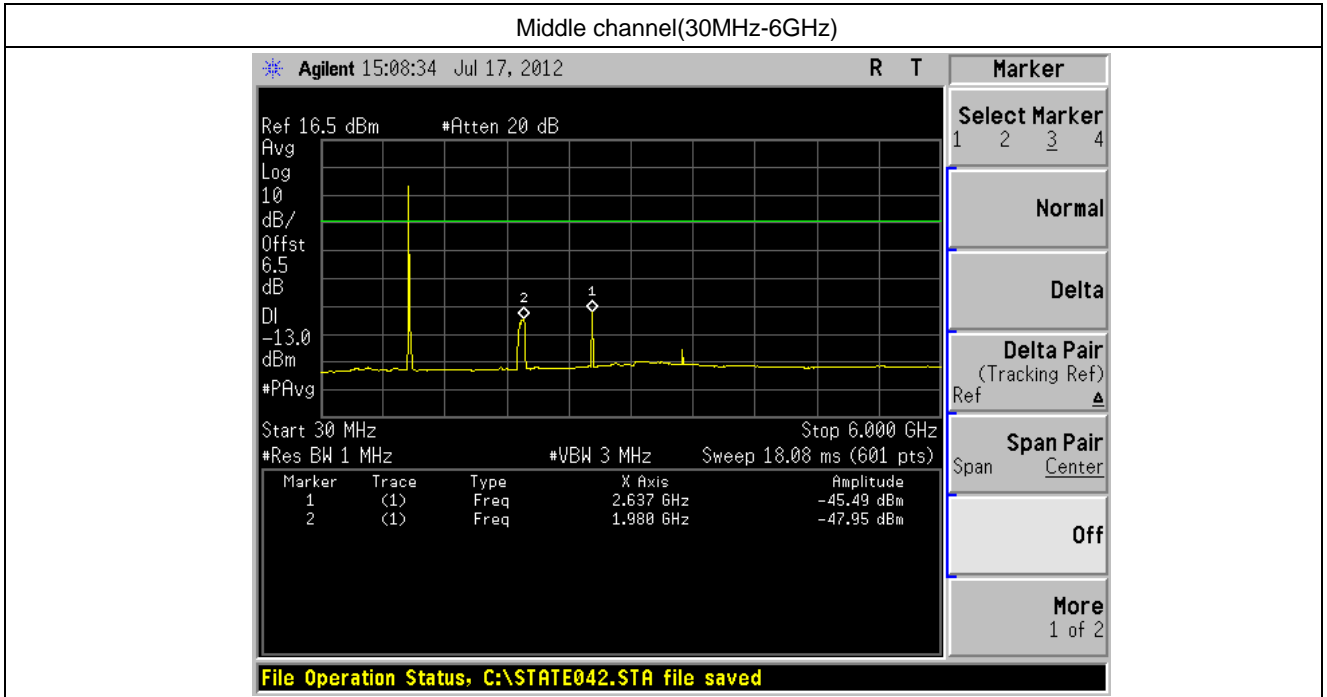

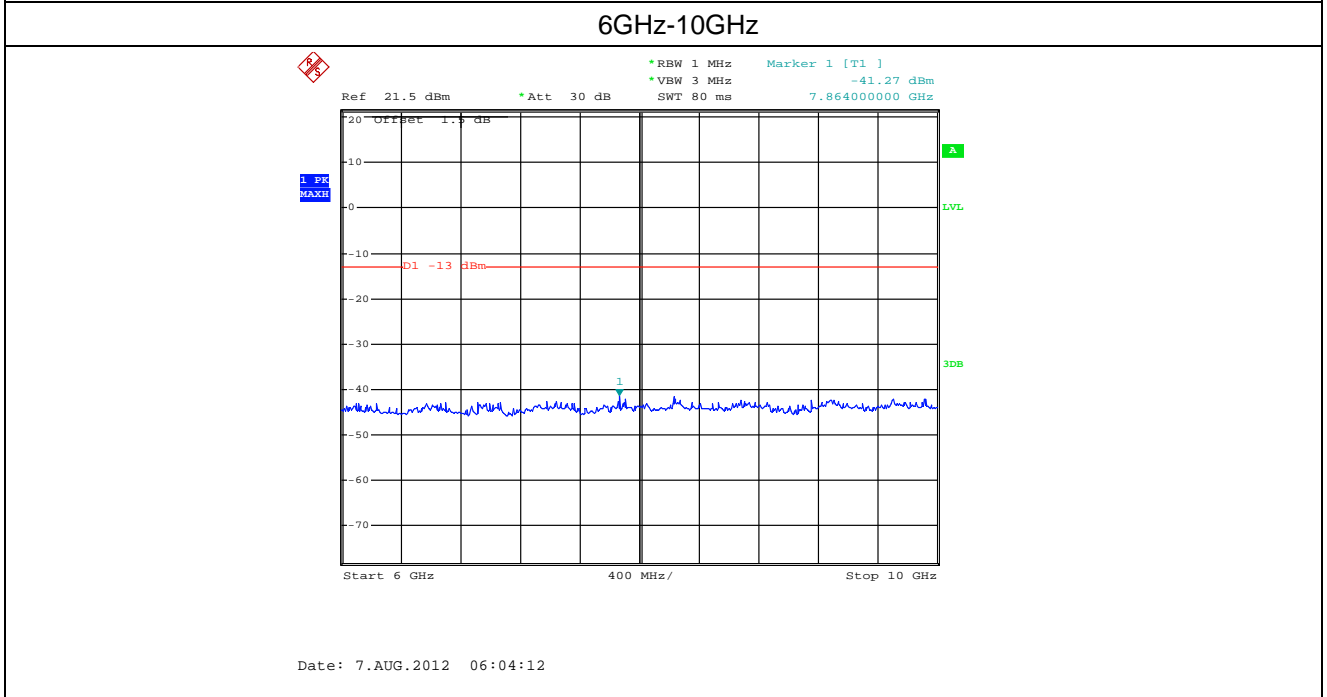
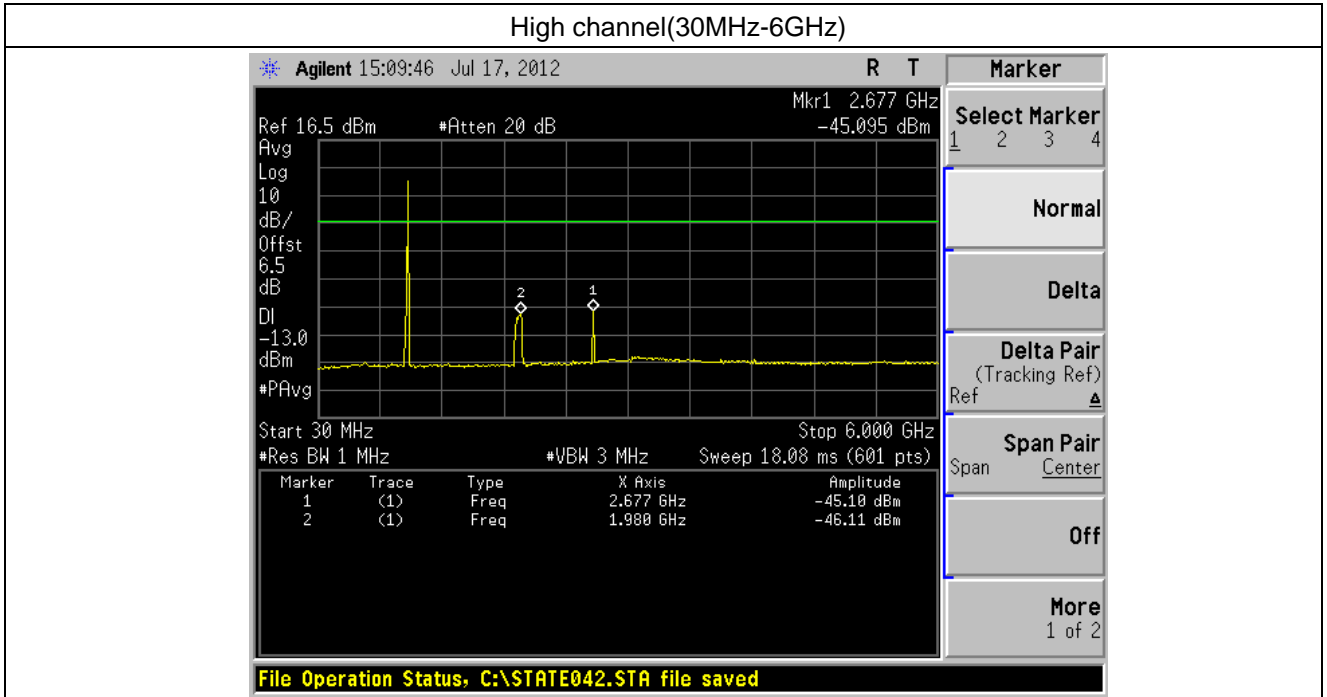

CDMA800 Uplink

Low channel(30MHz-6GHz)

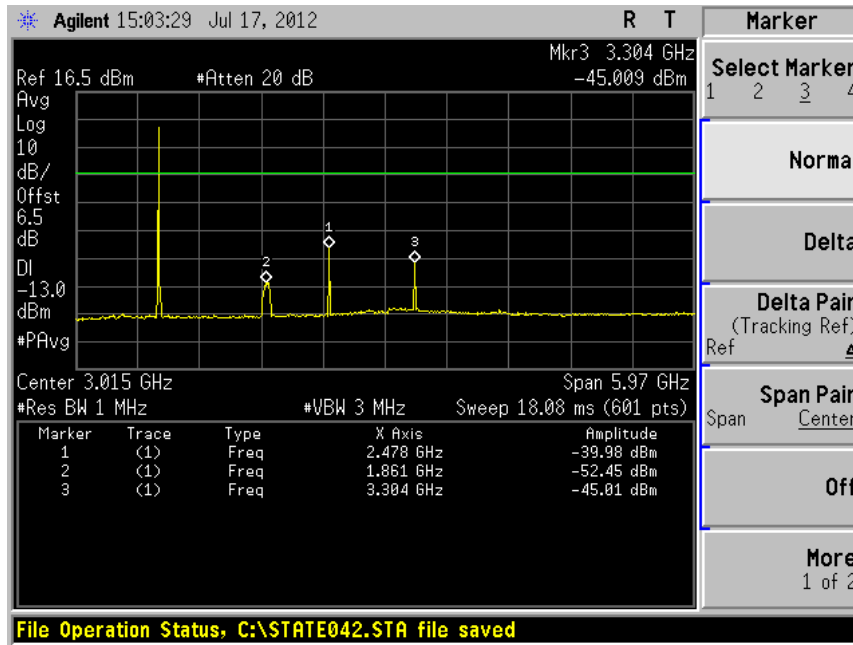

6GHz-10GHz

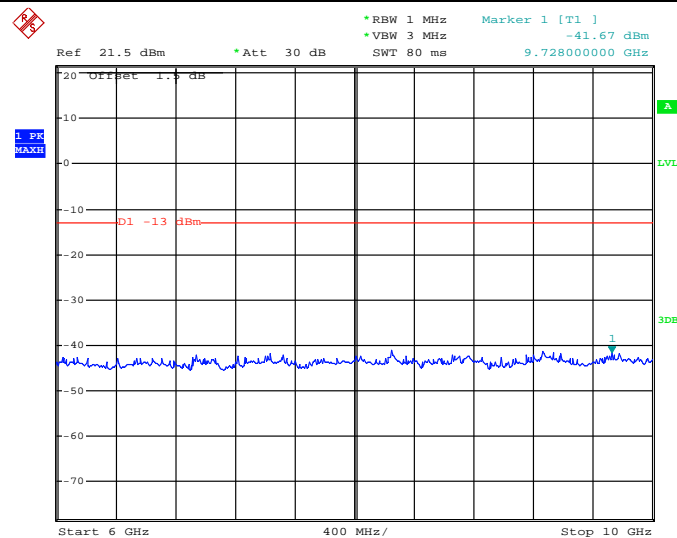

Date: 7.AUG.2012 06:04:53

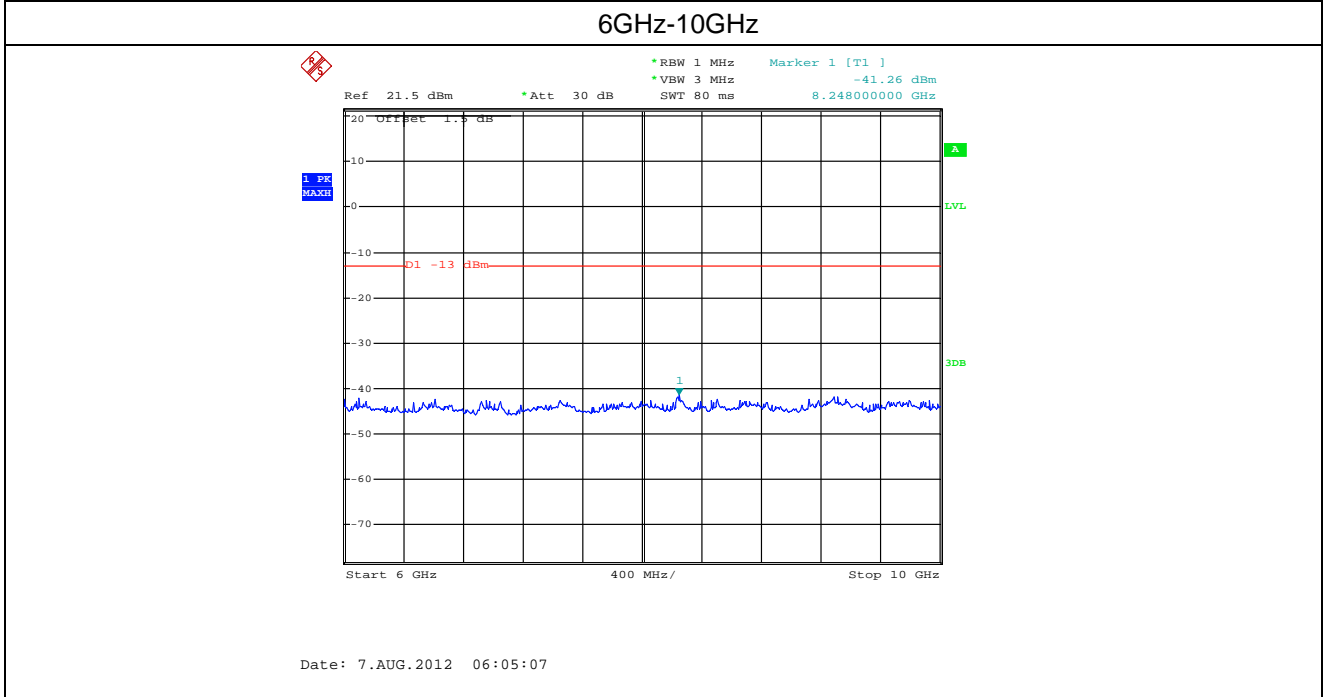
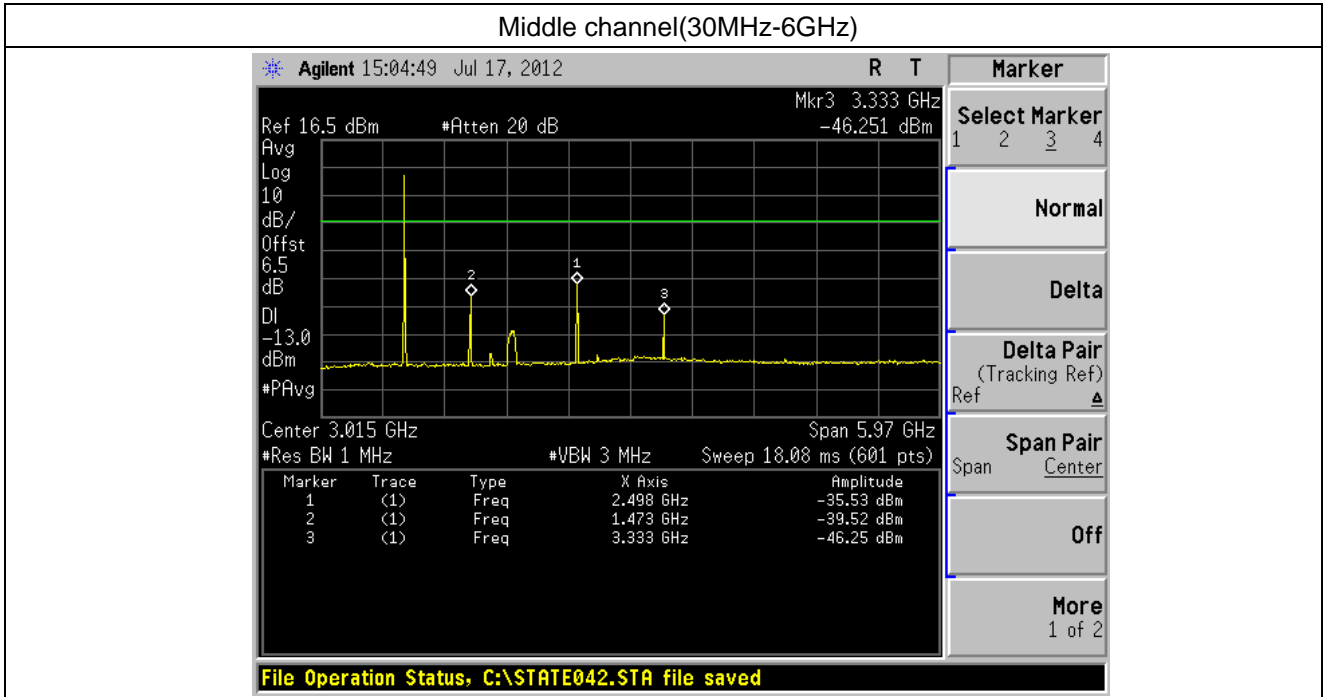

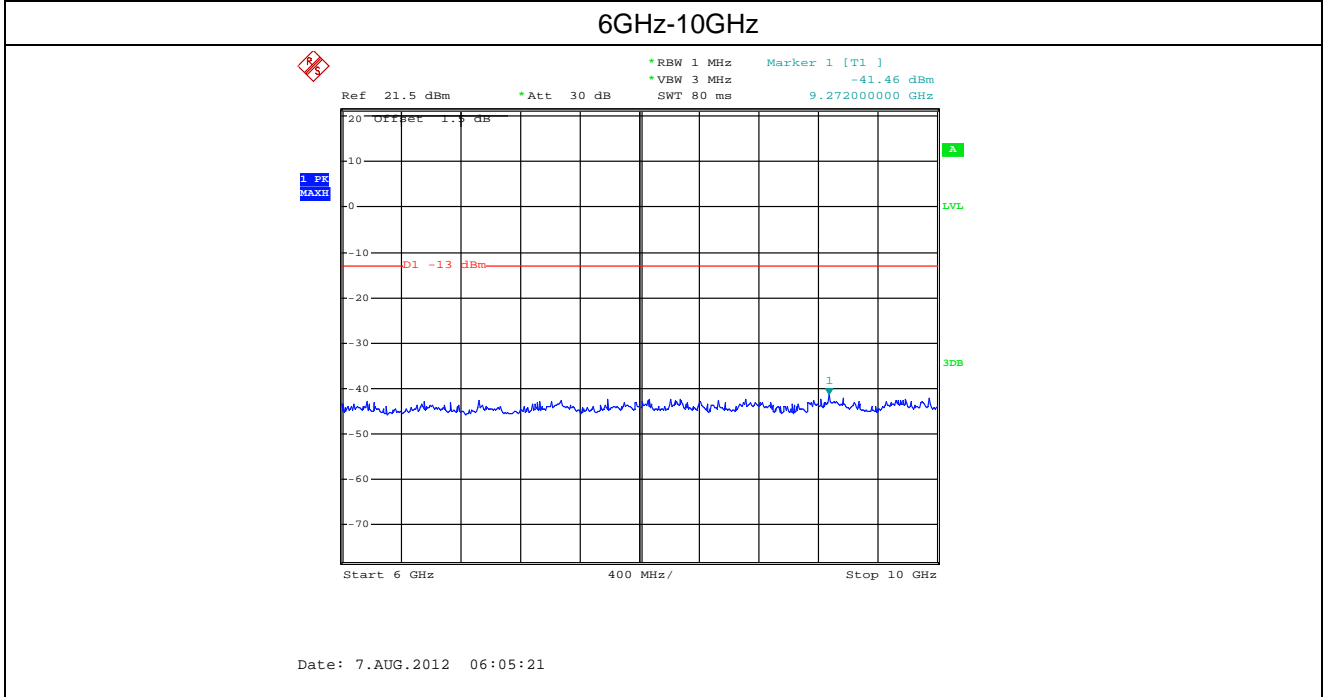
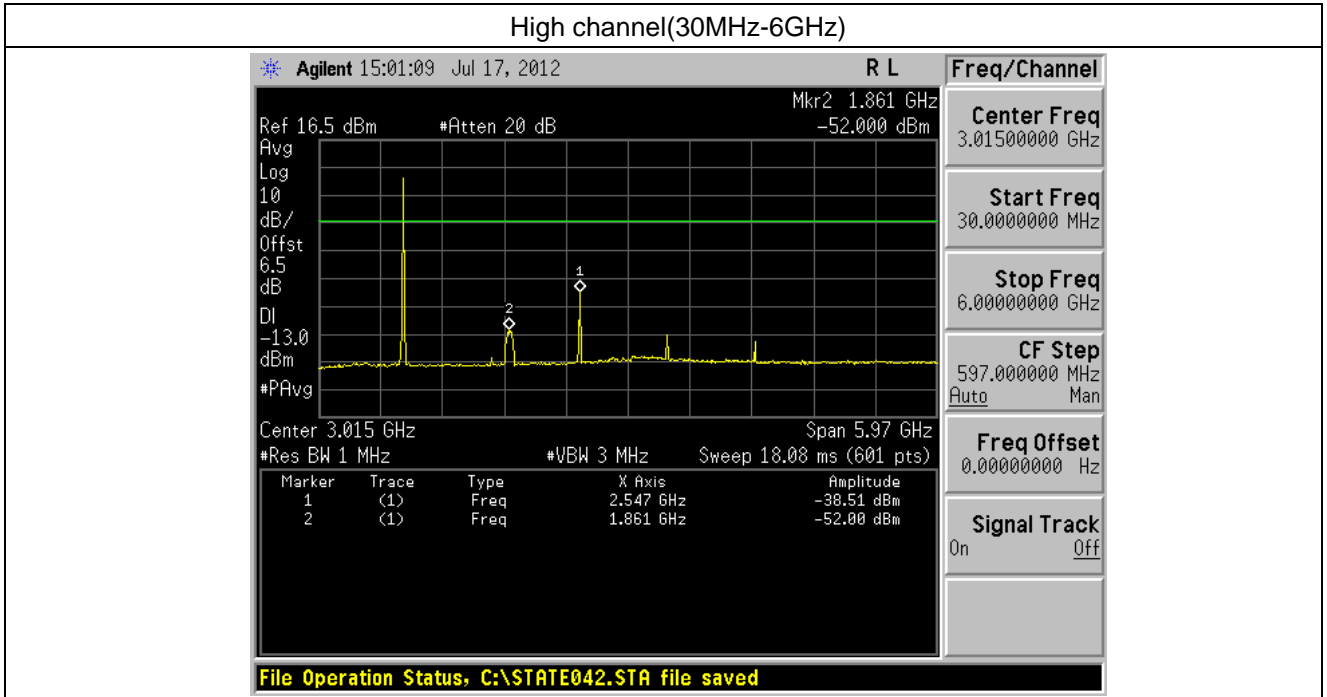

CDMA1900 Downlink

Low channel(30MHz-6GHz)

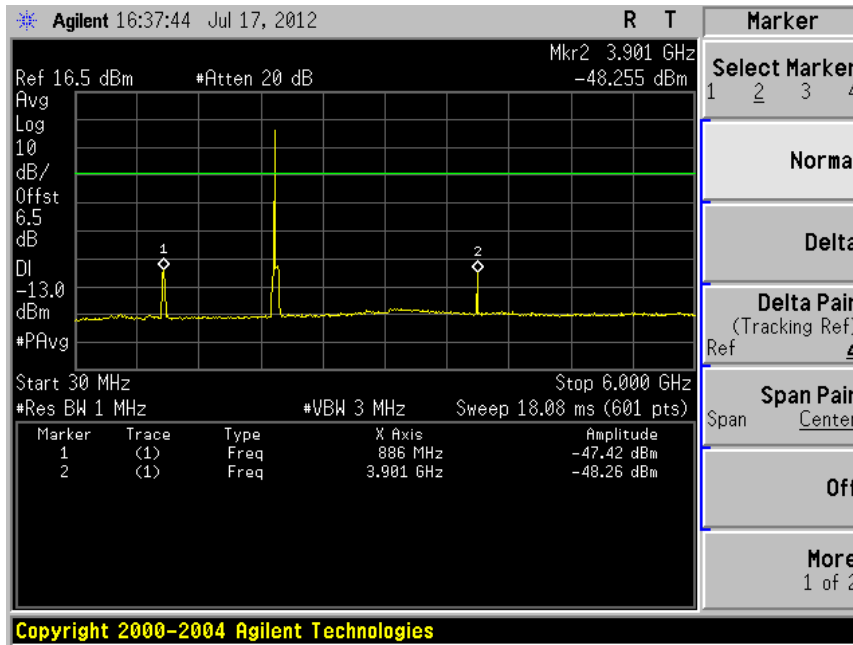

6GHz-20GHz

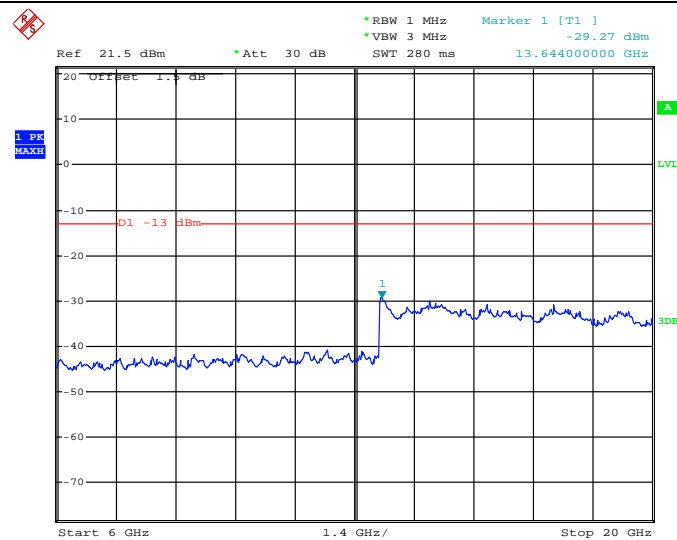

Date: 7.AUG.2012 06:05:50

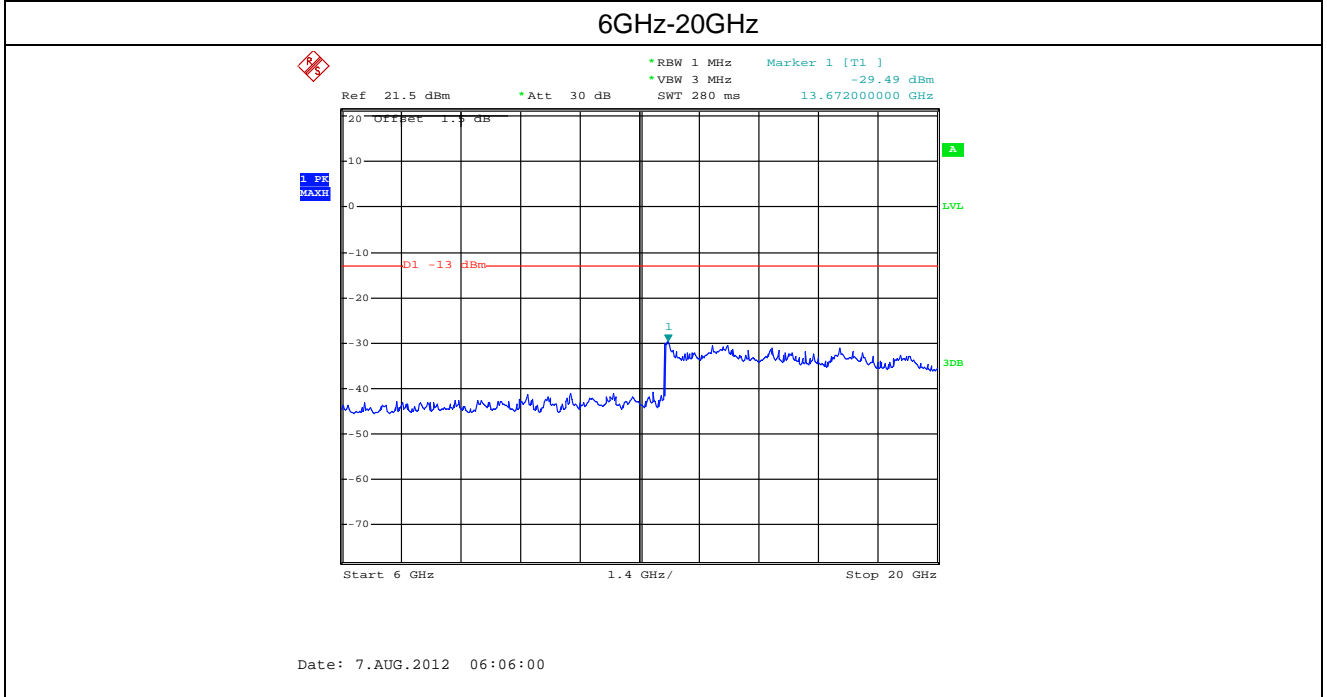
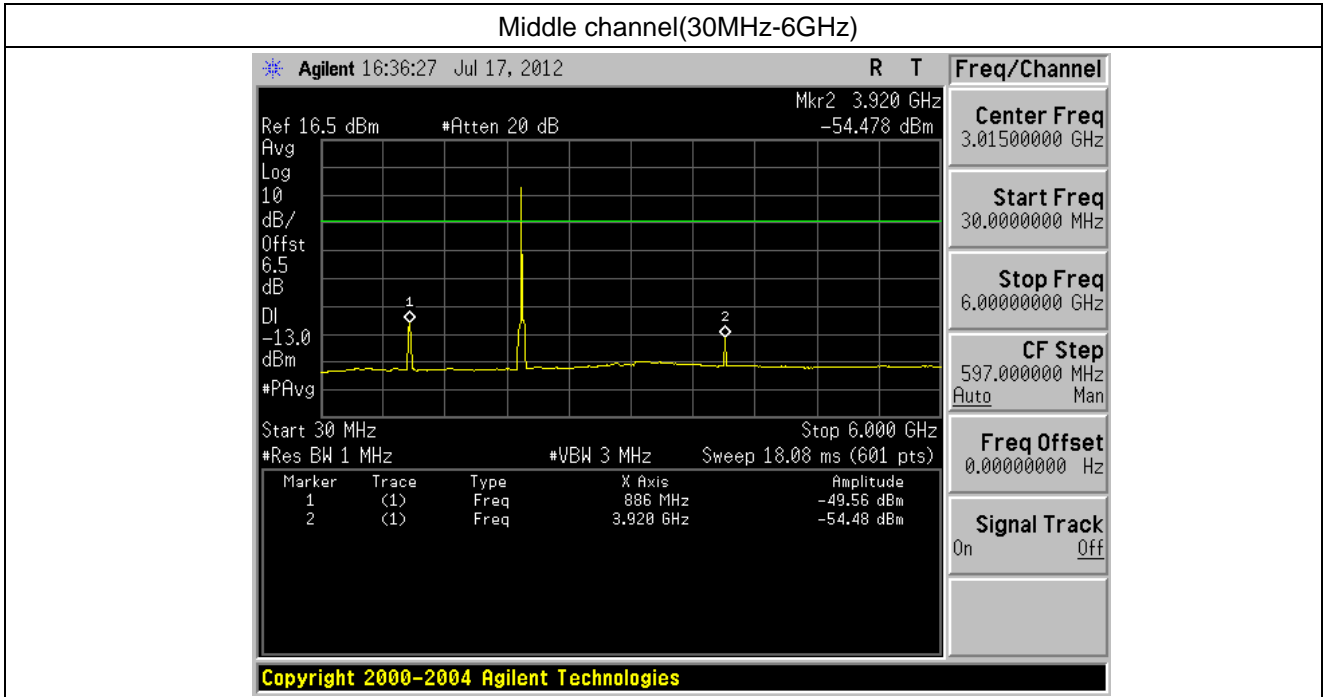

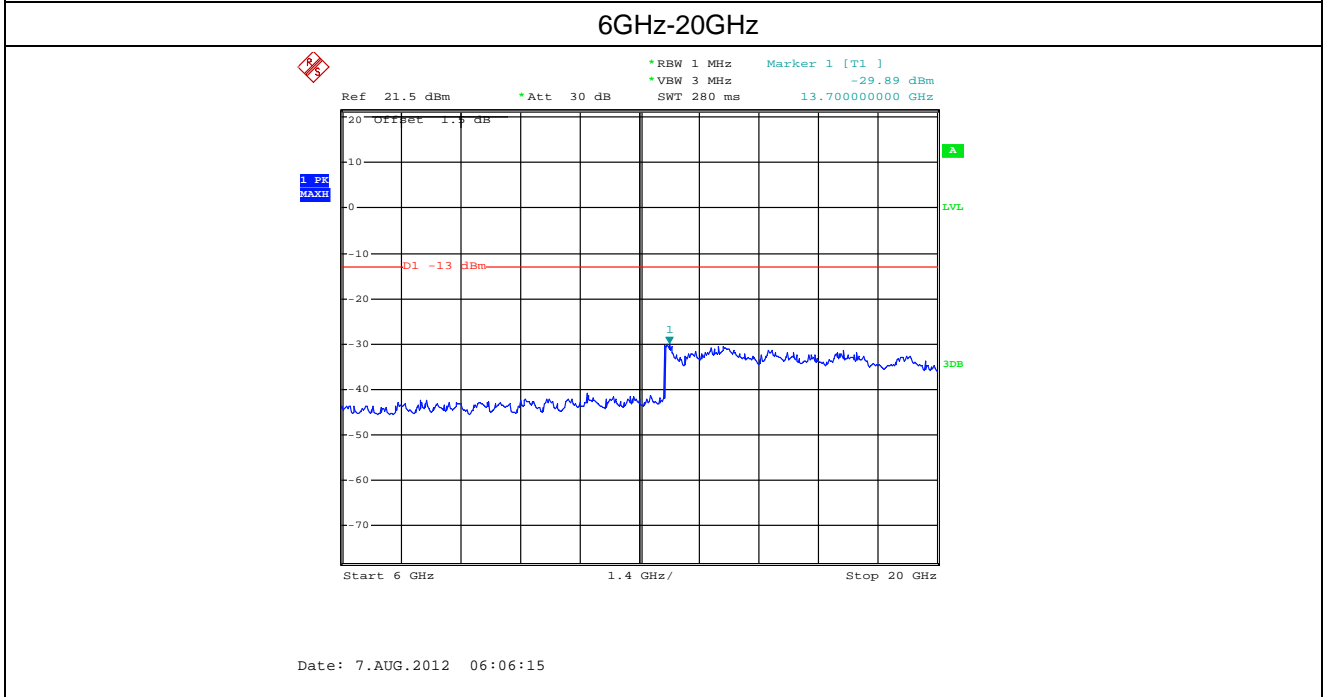
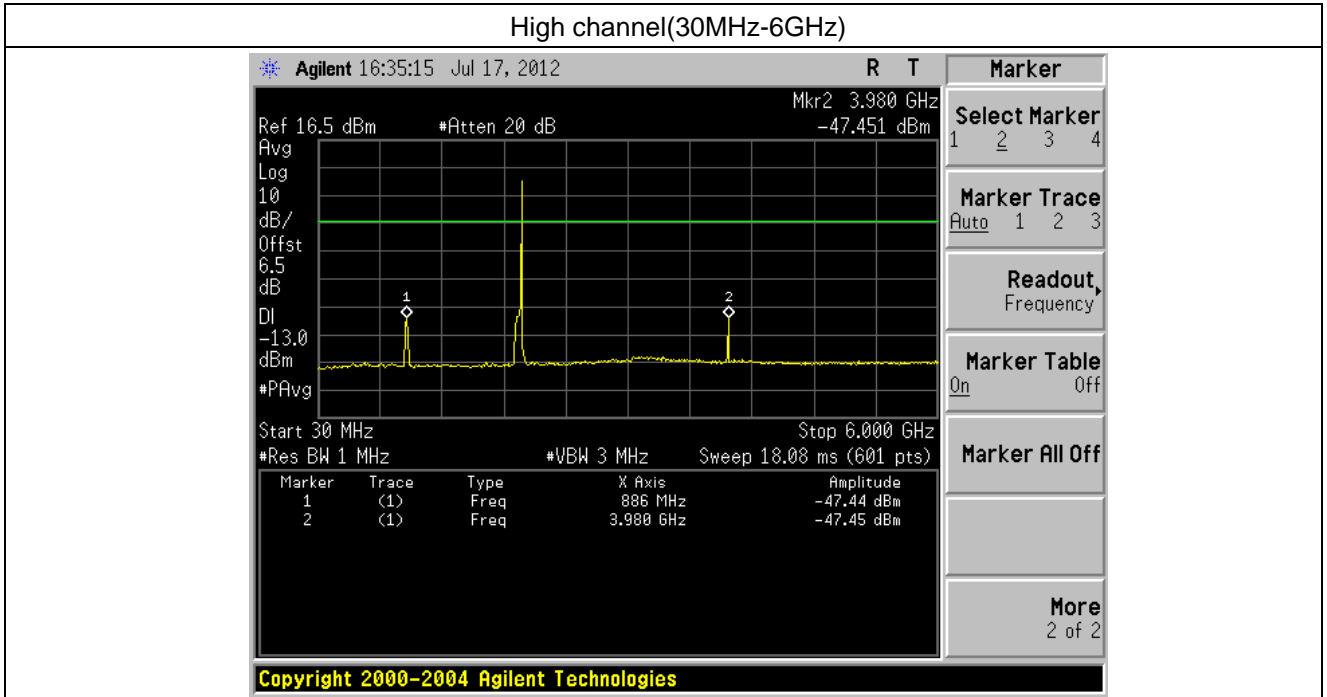

CDMA1900 Uplink

Low channel(30MHz-6GHz)

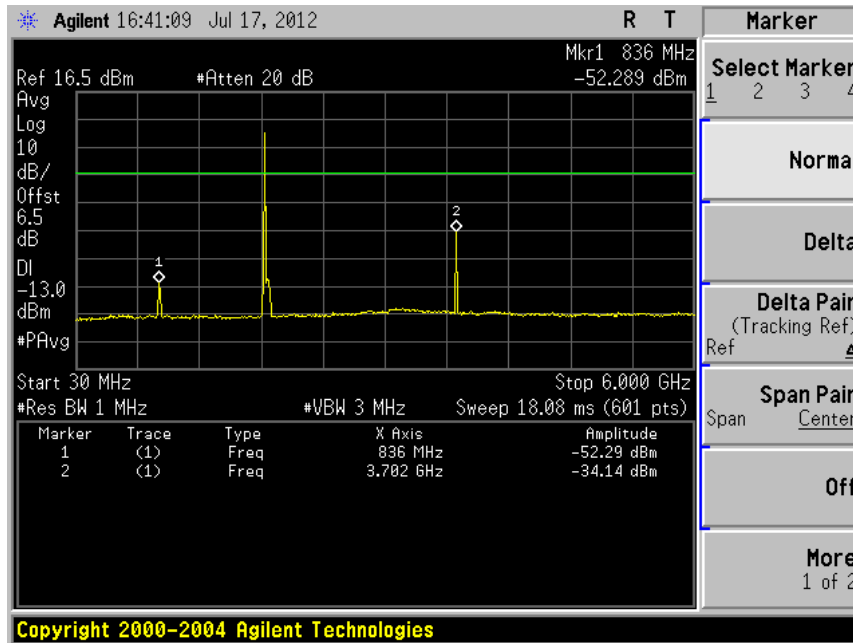

6GHz-20GHz

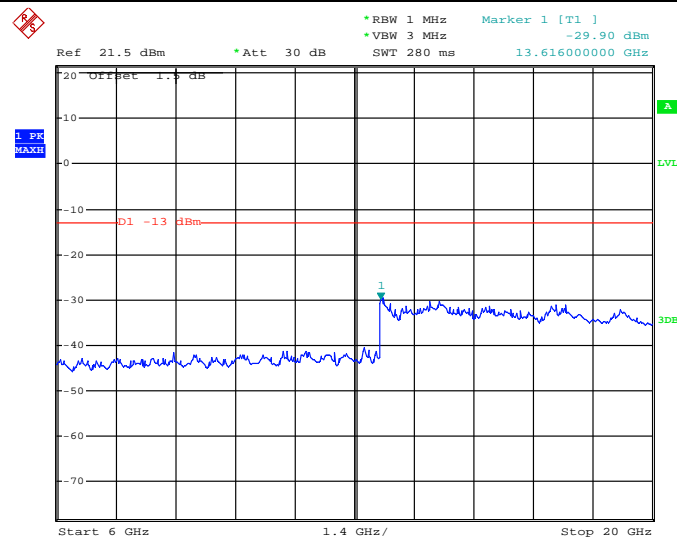

Date: 7.AUG.2012 06:06:32

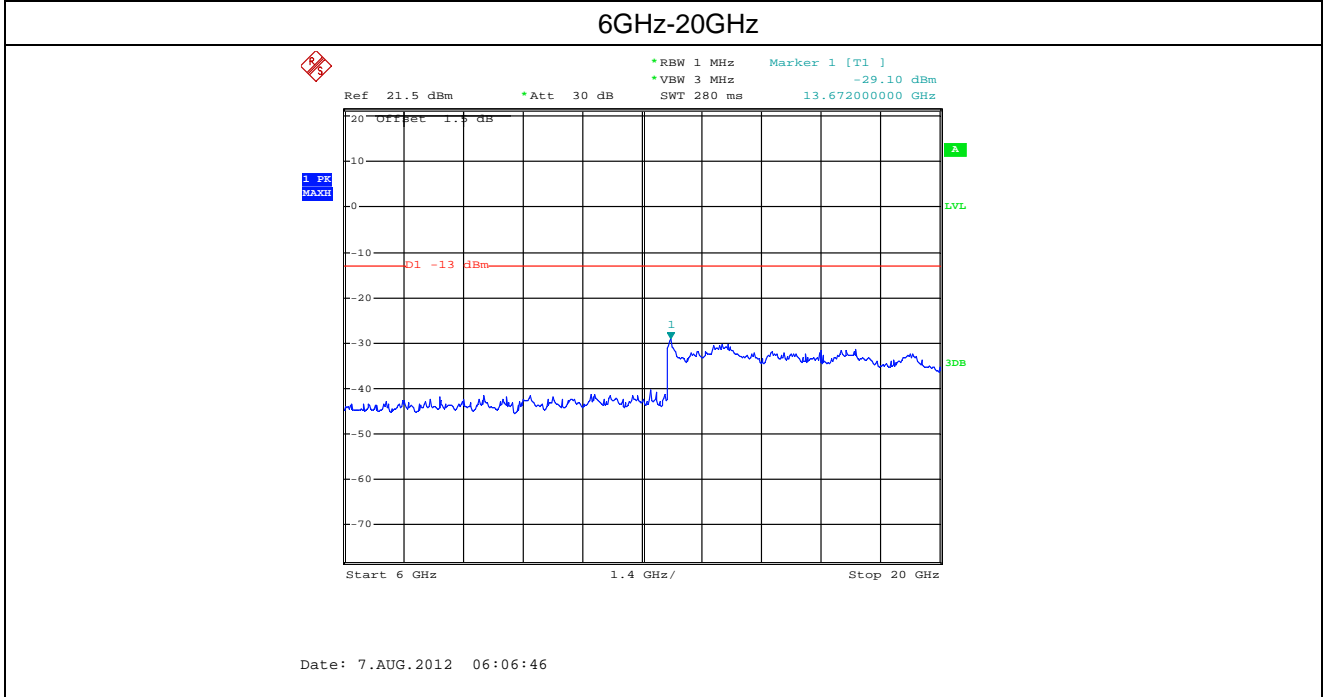
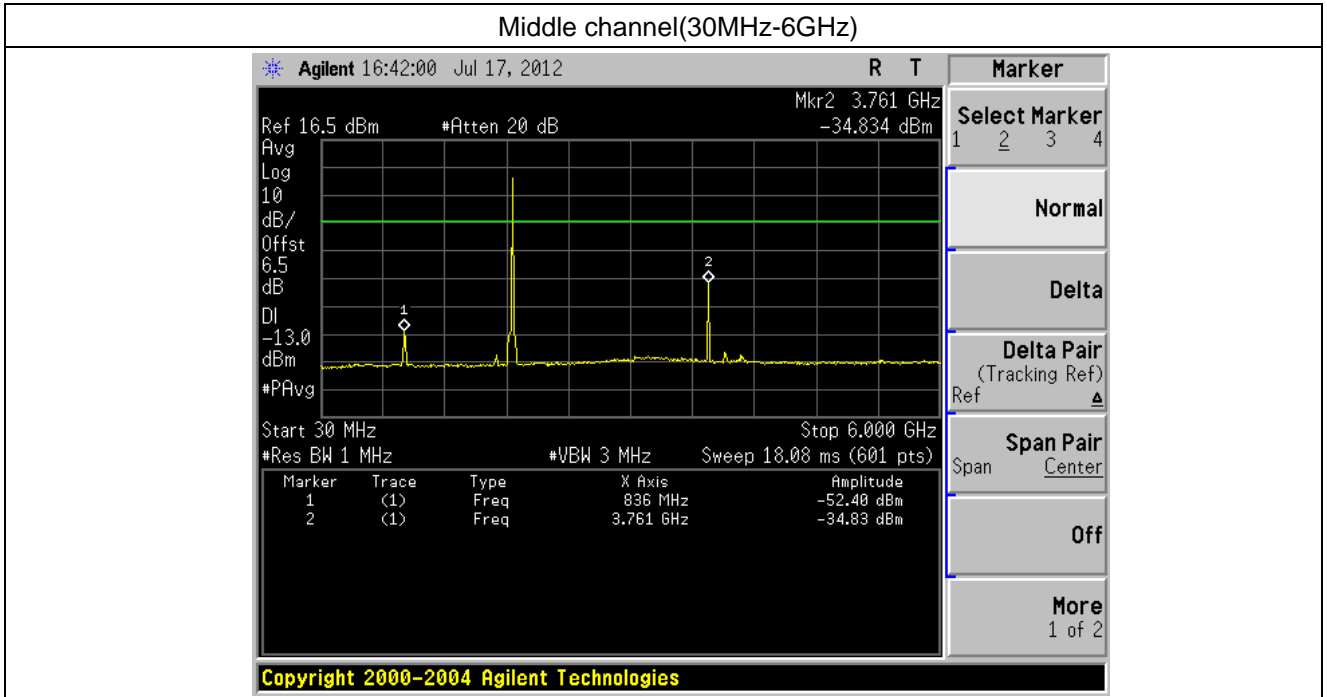

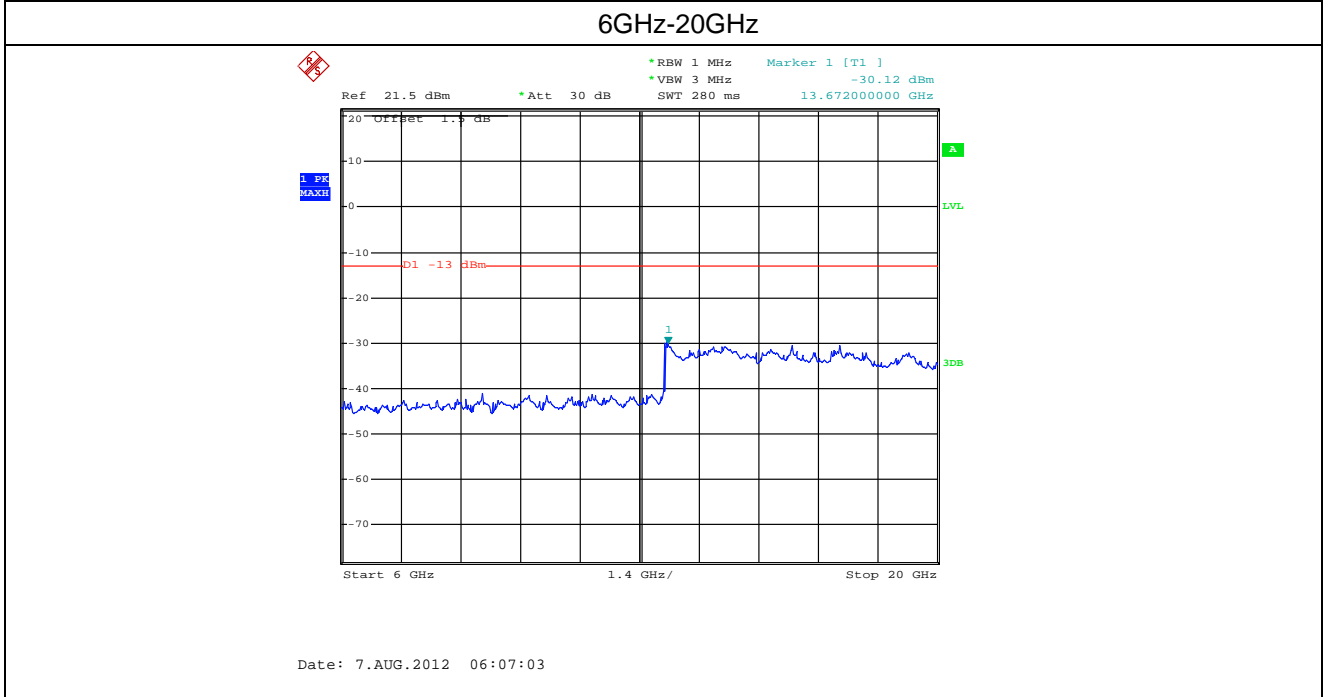
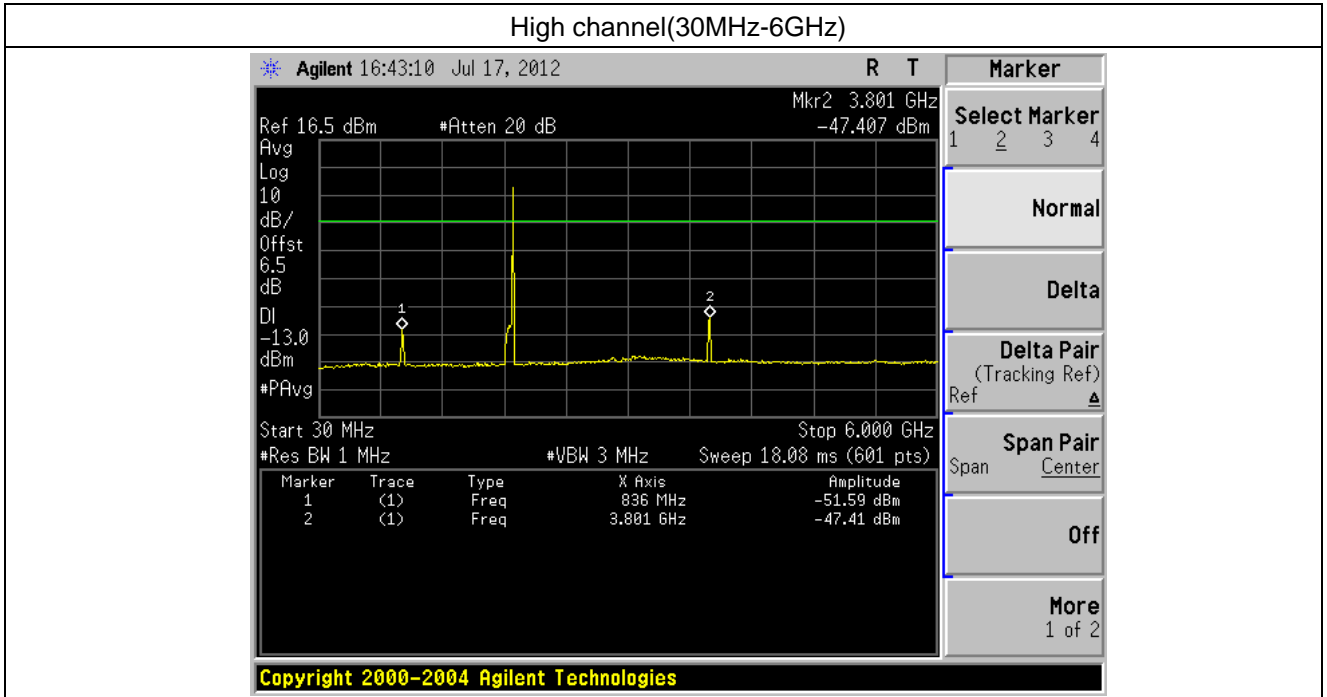

9.4.2 Band edge emission

Band edge of GSM

GSM 850 Downlink

Left edge of band

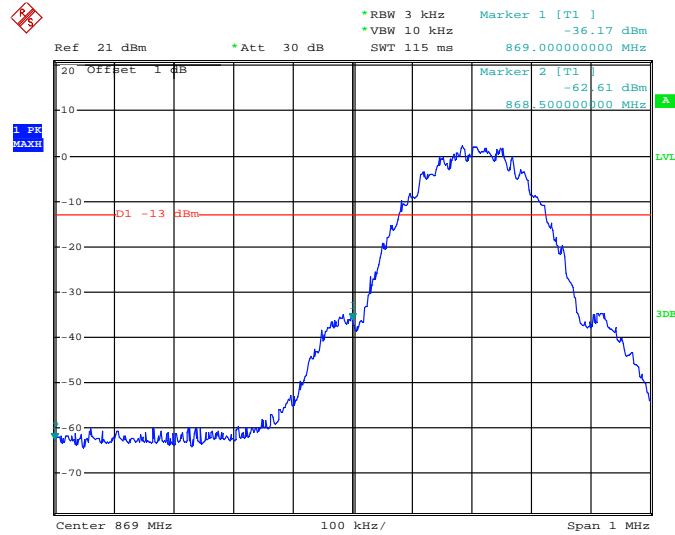

Date: 1.AUG.2012 14:50:28

Right edge of band

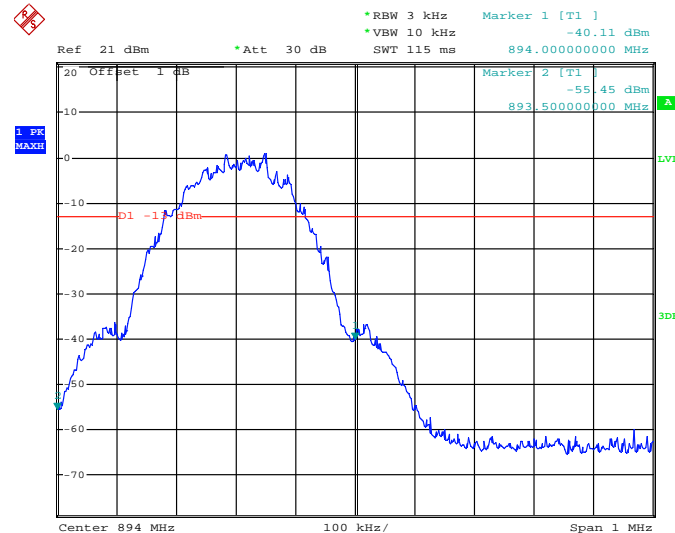

Date: 1.AUG.2012 14:50:54

GSM 850 Uplink

Left edge of band

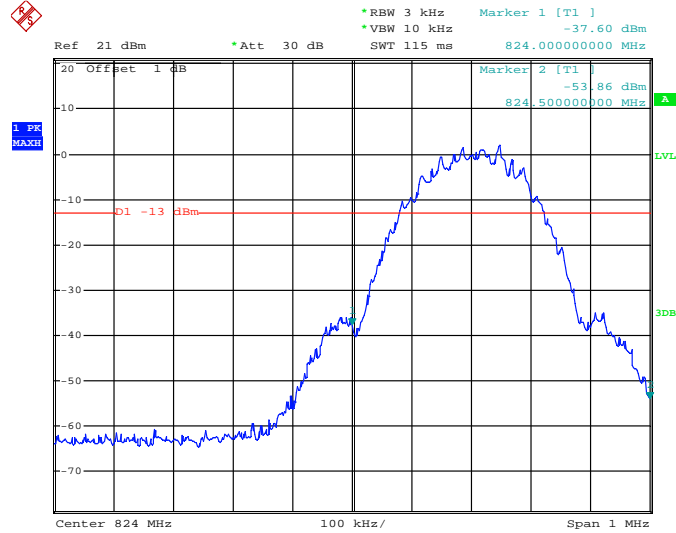

Date: 1.AUG.2012 14:47:45

Right edge of band

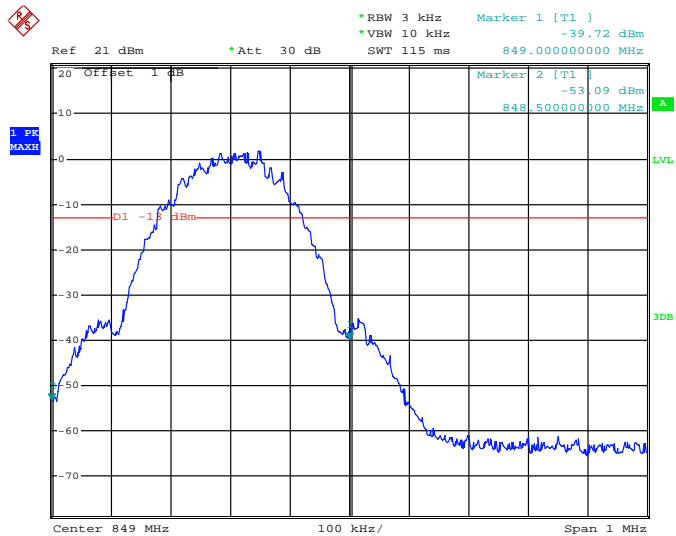

Date: 1.AUG.2012 14:48:37

PCS1900 Downlink

Left edge of band

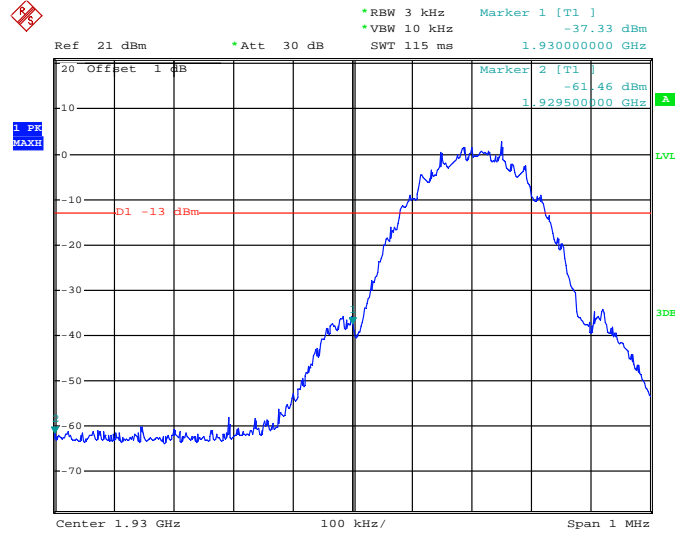

Date: 1.AUG.2012 14:52:03

Right edge of band

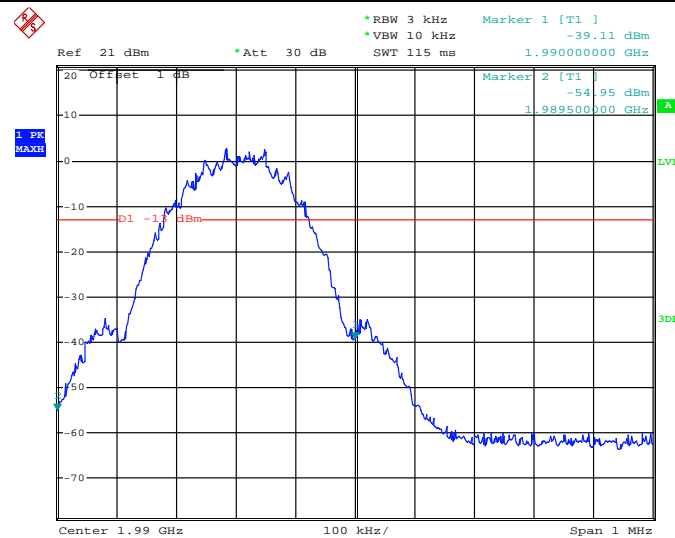

Date: 1.AUG.2012 14:52:57

PCS1900 Uplink

Left edge of band

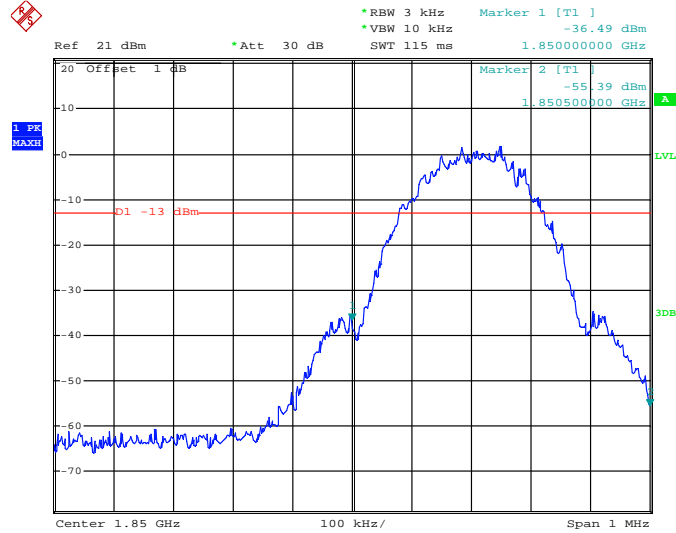

Date: 1.AUG.2012 14:54:24

Right edge of band

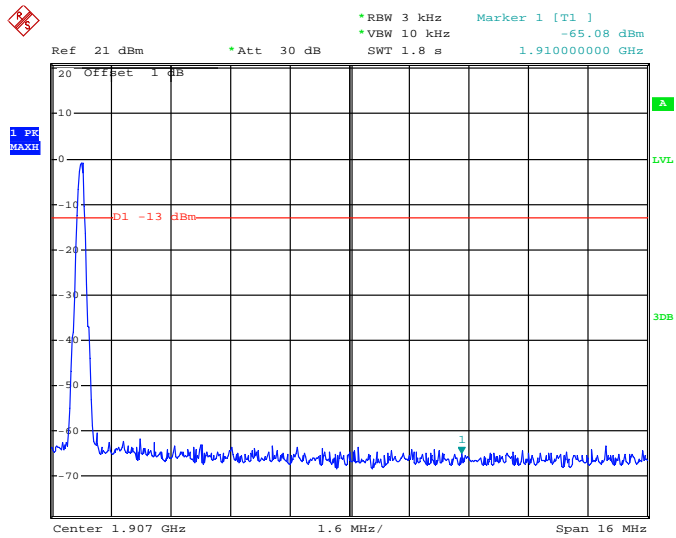

Date: 1.AUG.2012 14:57:25

Band edge of CDMA

CDMA 850 Downlink

Left edge of band

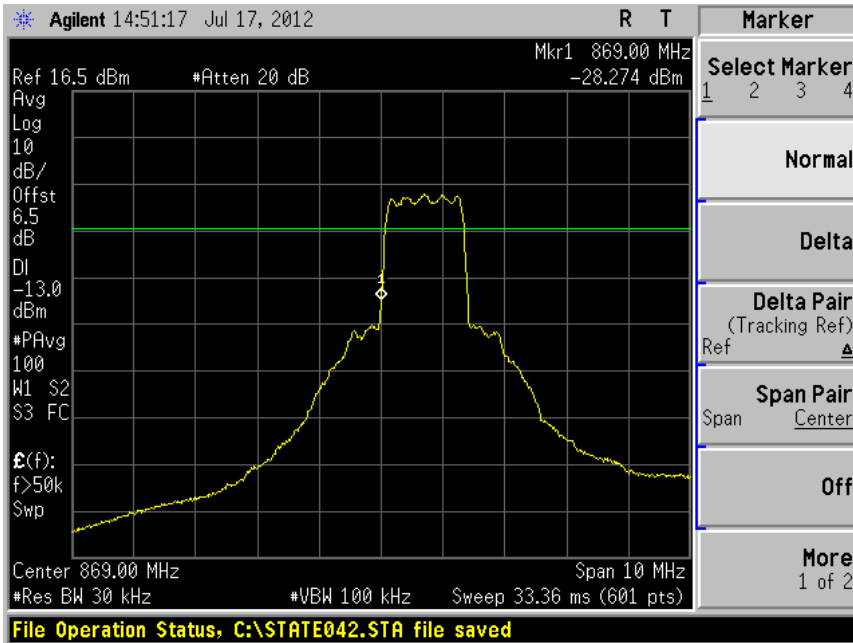

Right edge of band

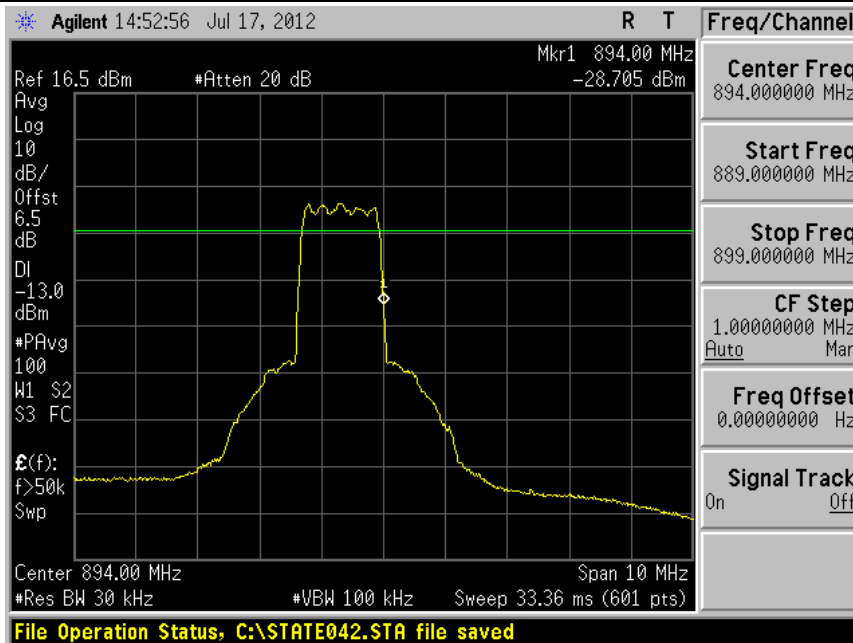

CDMA 850 Uplink

Left edge of band

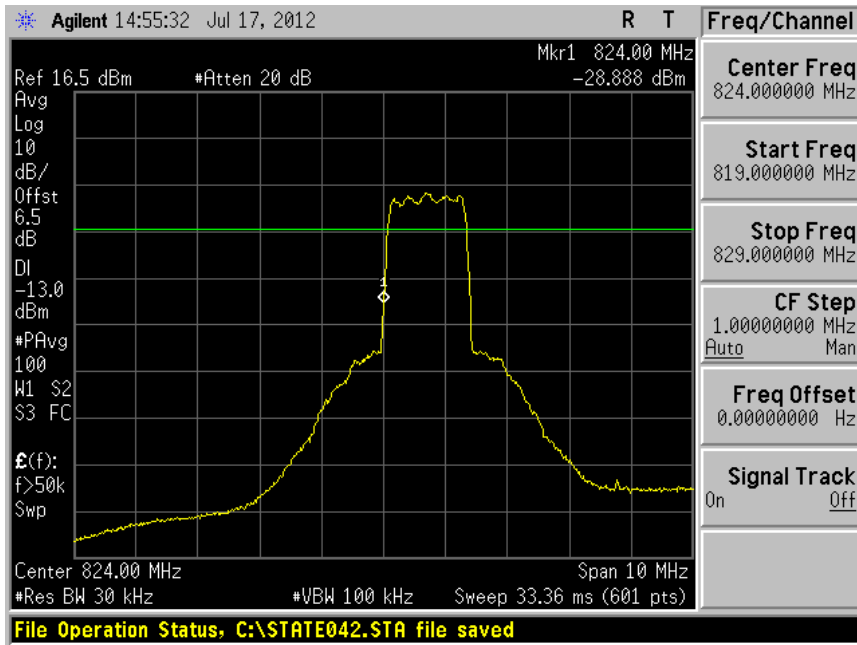

Right edge of band

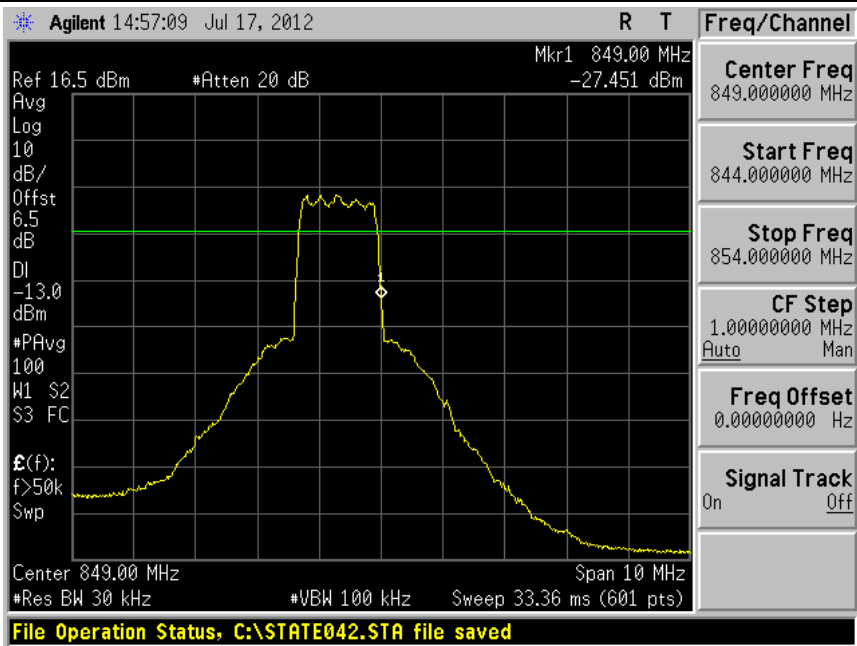

CDMA 1900 Downlink

Left edge of band

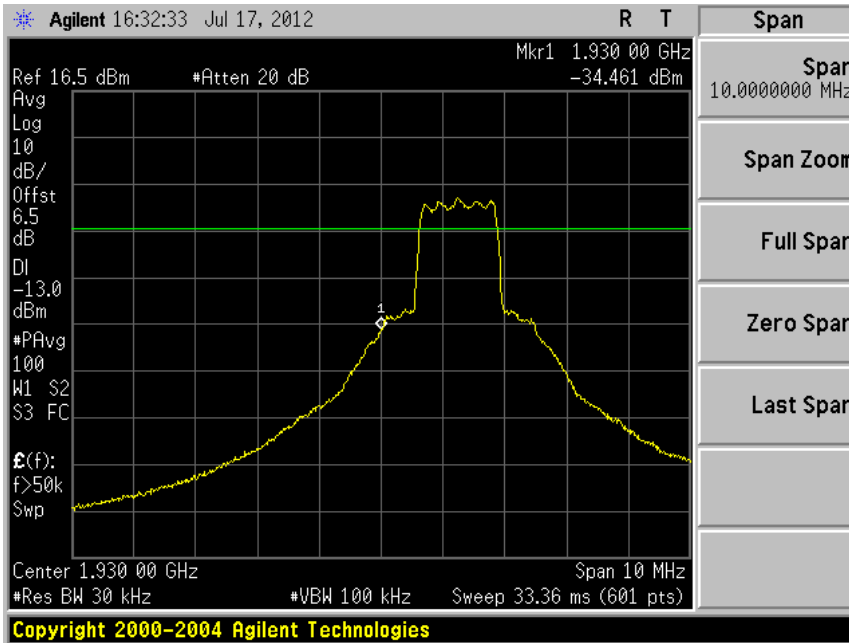

Right edge of band

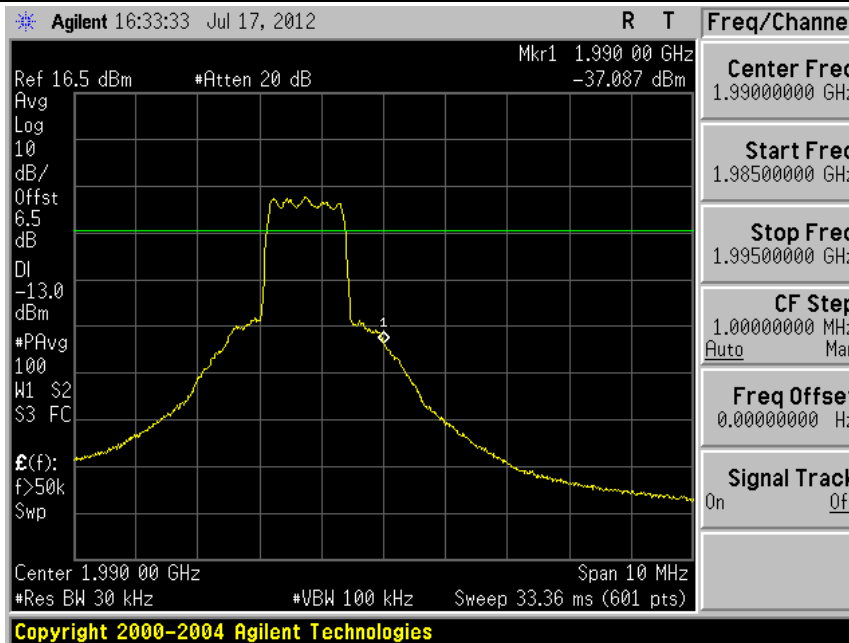

CDMA 1900 Uplink

Left edge of band

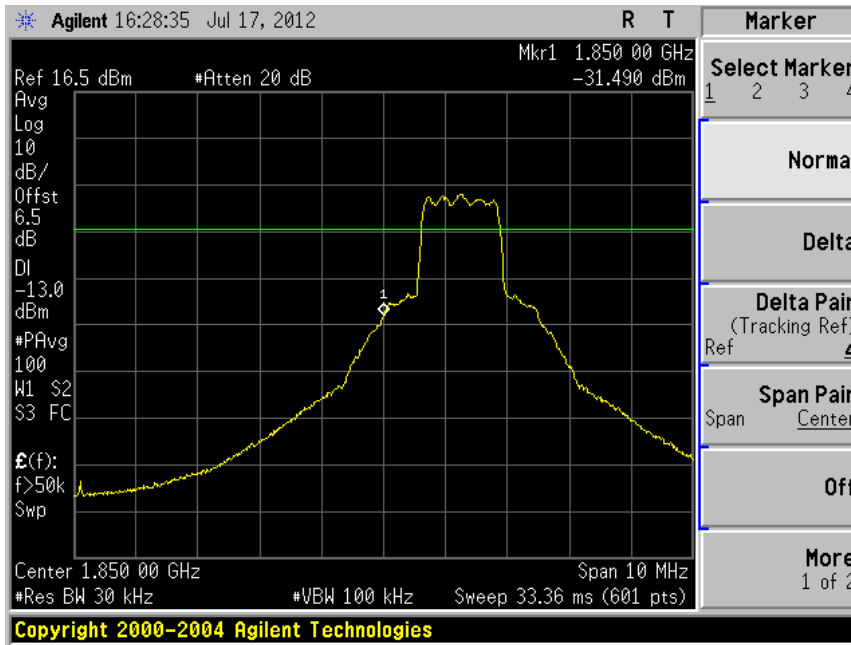

Right edge of band

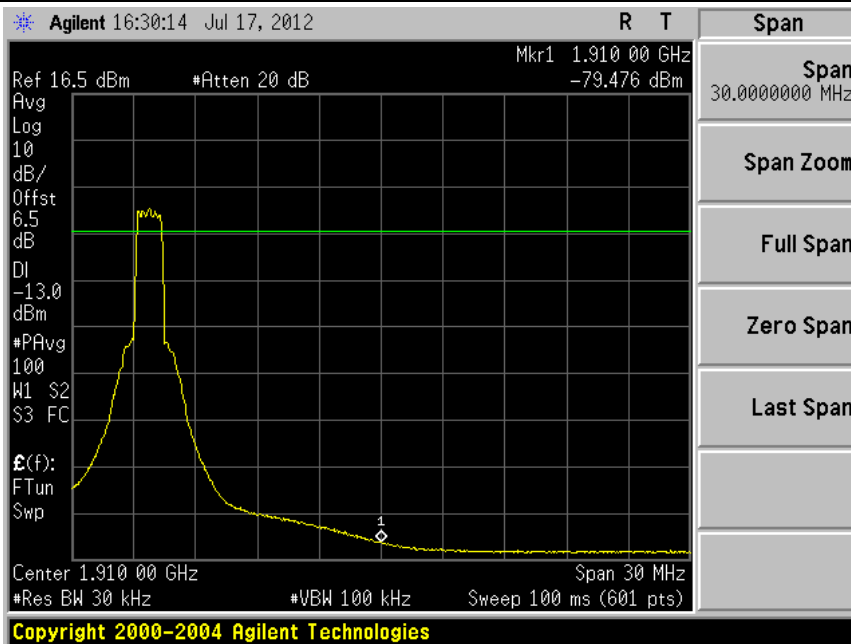

10 INTERMODULATION

10.1 Standard Applicable

According to FCC §2.1051, §22.917(a), §24.238(a) and 2-11-04/EAB/RF.

10.2 Test setup

Please refer the section §6.2 Configuration of Tested System.

10.3 Measurement Procedure

1. The EUT RF output port was connected to spectrum analyzer. The EUT shall be set to maximum gain and maximum rated output power per channel.
2. Two continuous sinusoidal RF signals shall be fed to the input antenna port of the repeater using a combining device. The two channels near each other should be separated by at least one operating channel width.
3. The spurious emissions at antenna were measured at the RF output port of the EUT.
4. The modulation types tested were GSM and CDMA.
5. Spectrum analyzer settings:
 - Detector: PK.
 - Inter-modulation:
 - GSM: RBW=3 kHz; VBW \geq RBW
 - CDMA: RBW=30 kHz; VBW \geq RBW

10.4 Test Result

Inter-modulation of GSM

GSM850 Downlink Inter-modulation

Low channel

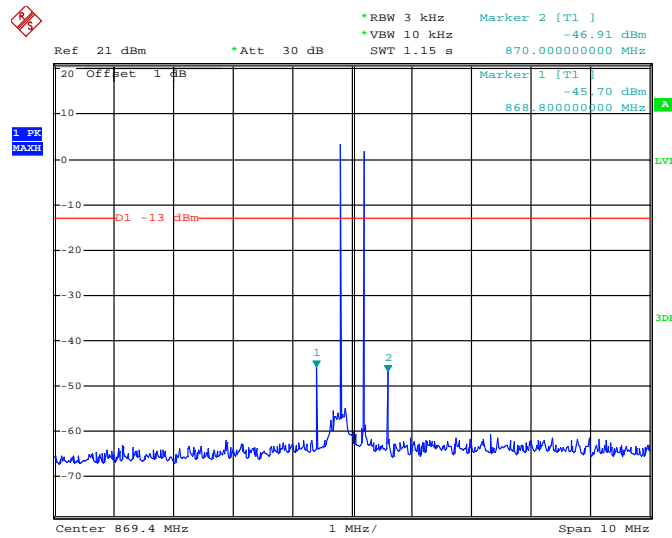

Date: 1.AUG.2012 14:37:57

High channel

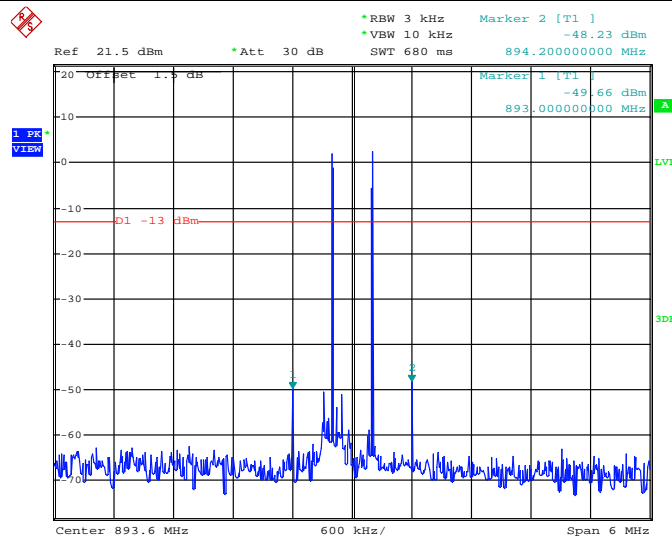

Date: 7.AUG.2012 05:59:31

GSM850 Uplink Inter-modulation

Low channel

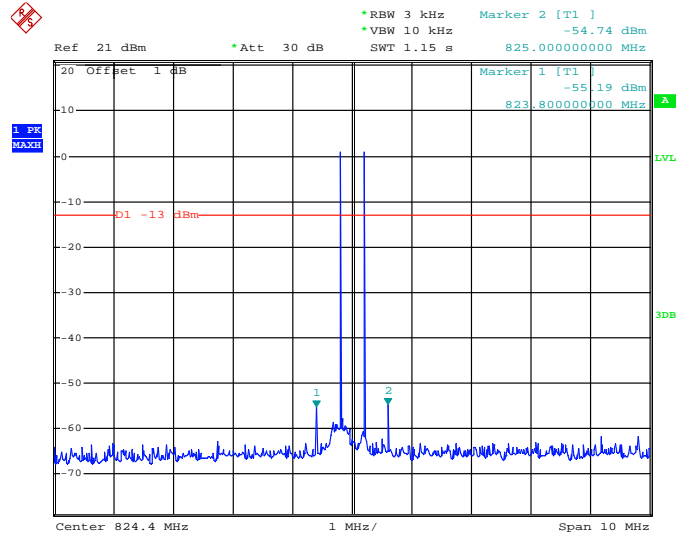

Date: 1.AUG.2012 14:42:42

High channel

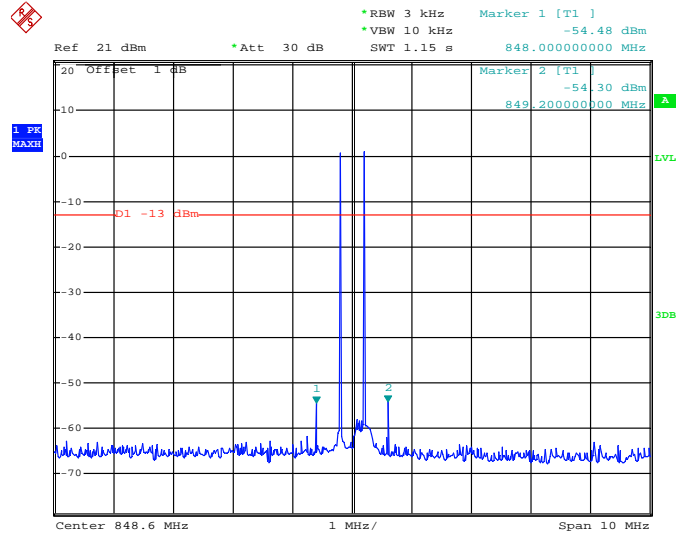

Date: 1.AUG.2012 14:44:03

PCS1900 Downlink Inter-modulation

Low channel

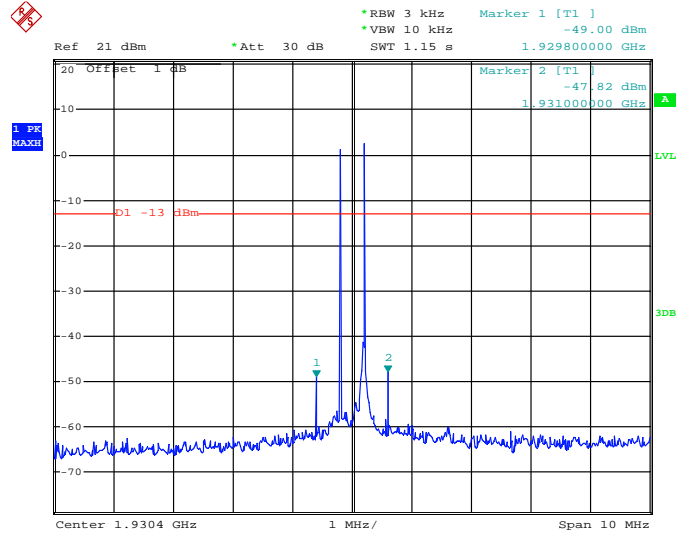

Date: 1.AUG.2012 15:17:47

High channel

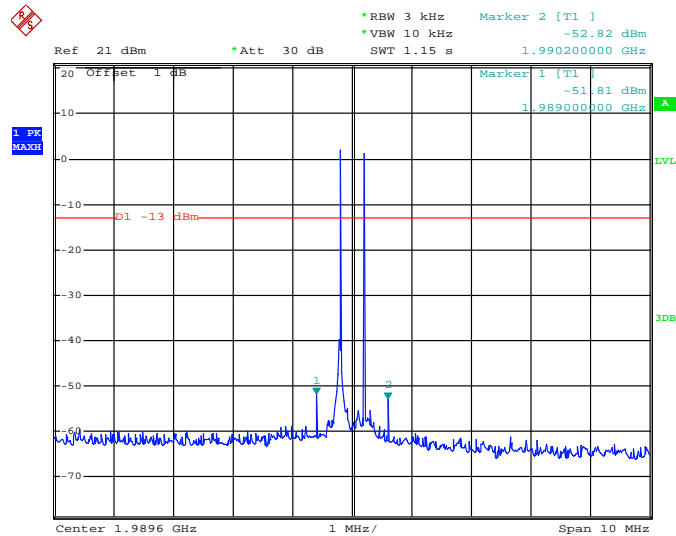

Date: 1.AUG.2012 15:15:21

PCS1900 Uplink Inter-modulation

Low channel

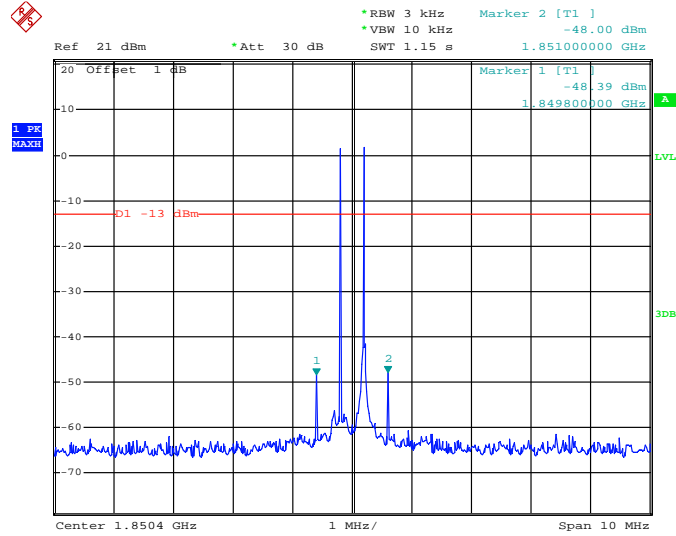

Date: 1.AUG.2012 15:20:23

High channel

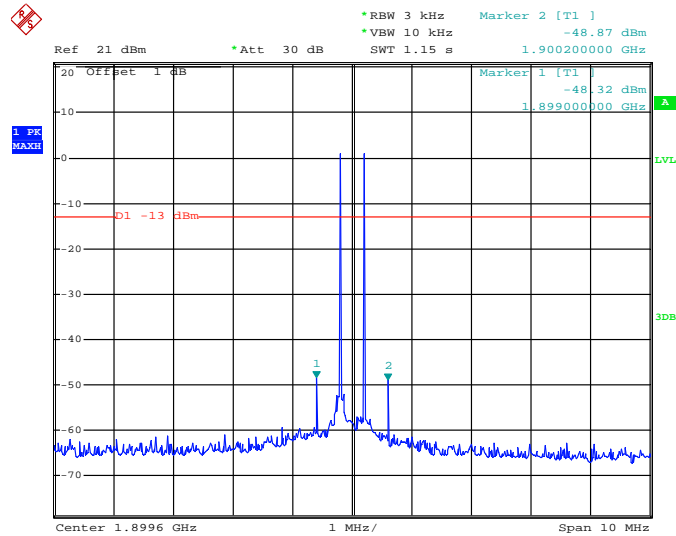

Date: 1.AUG.2012 15:22:03

Inter-modulation of CDMA

CDMA800 Downlink Inter-modulation

Low channel

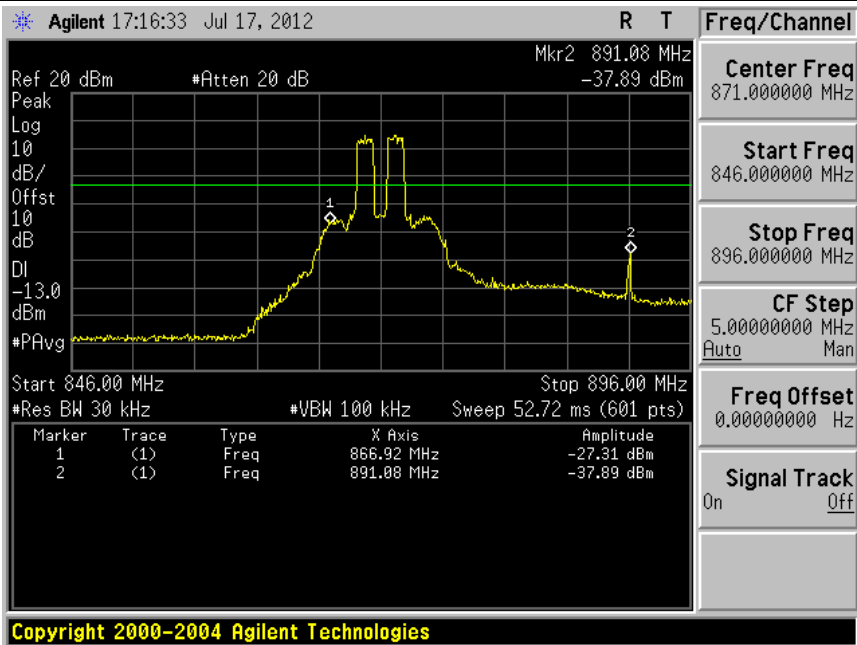

High channel

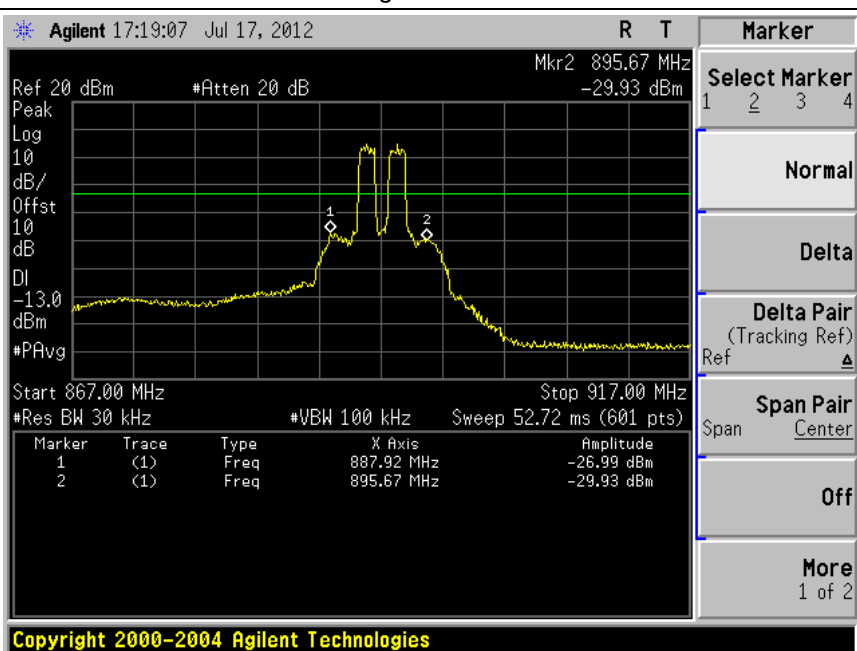

CDMA800 Uplink Inter-modulation

Low channel

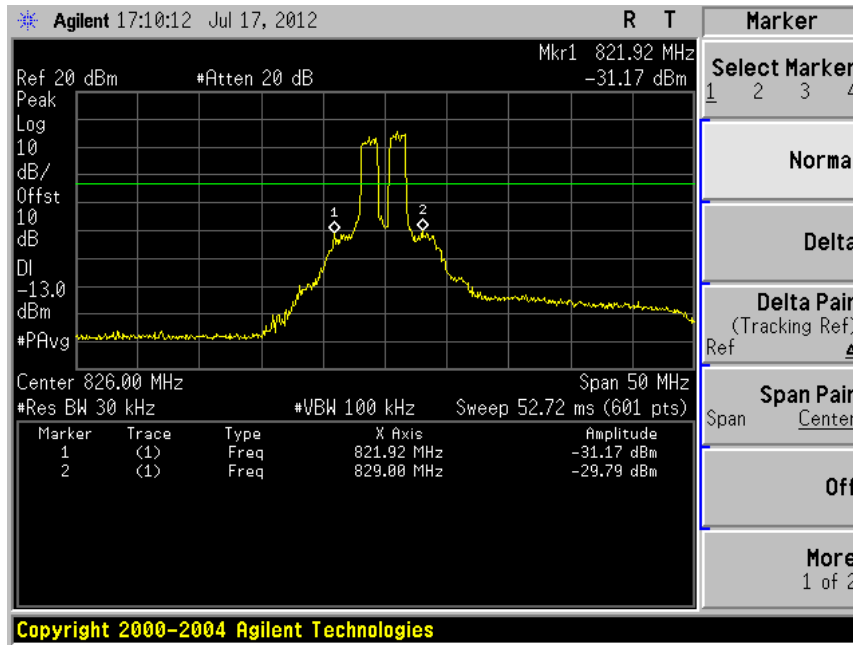

High channel

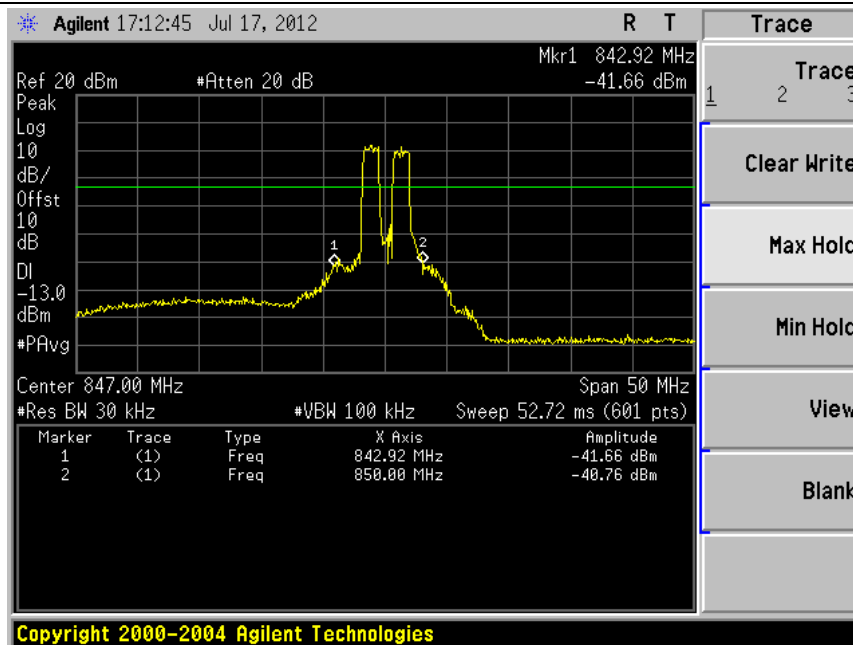

CDMA1900 Downlink Inter-modulation

Low channel

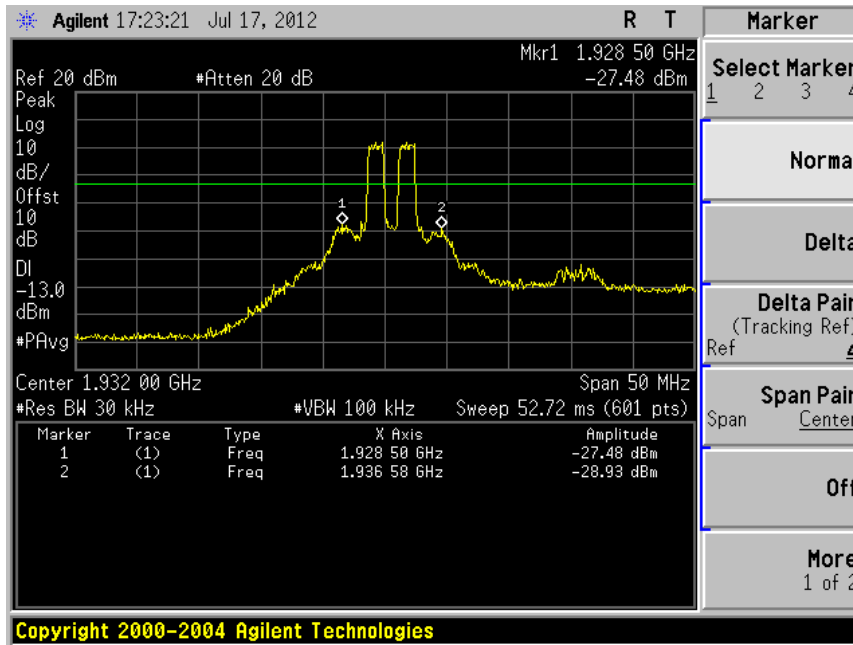

High channel

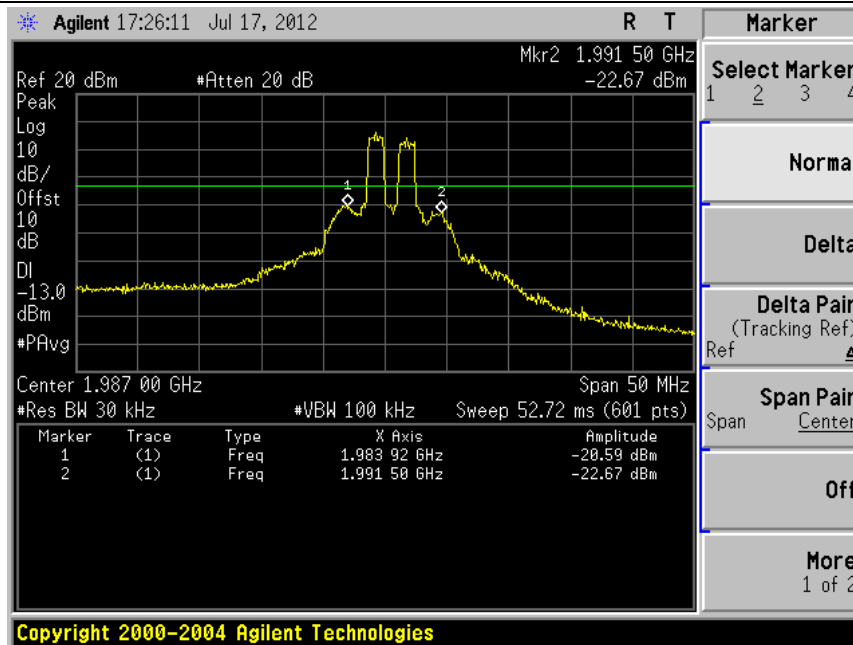

CDMA1900 Uplink Inter-modulation

Low channel

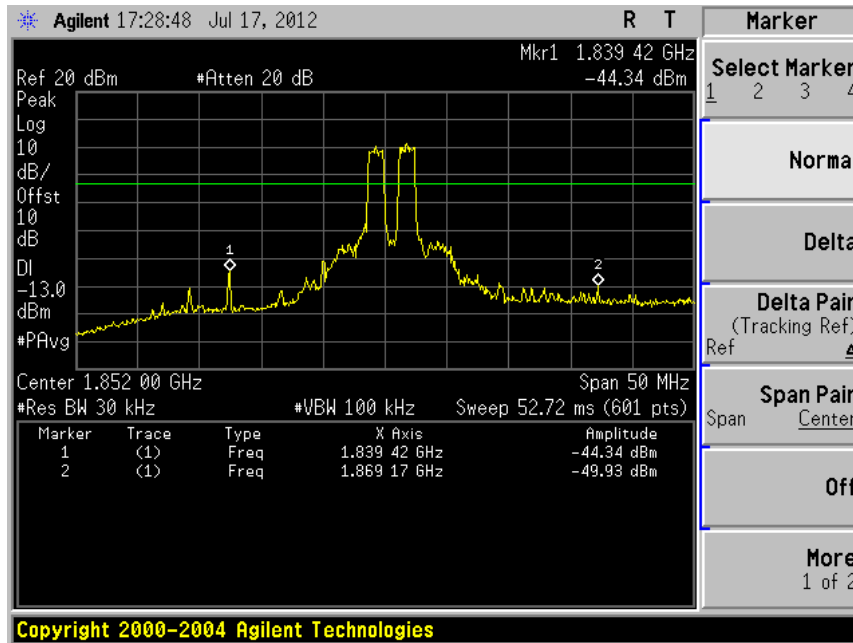

High channel

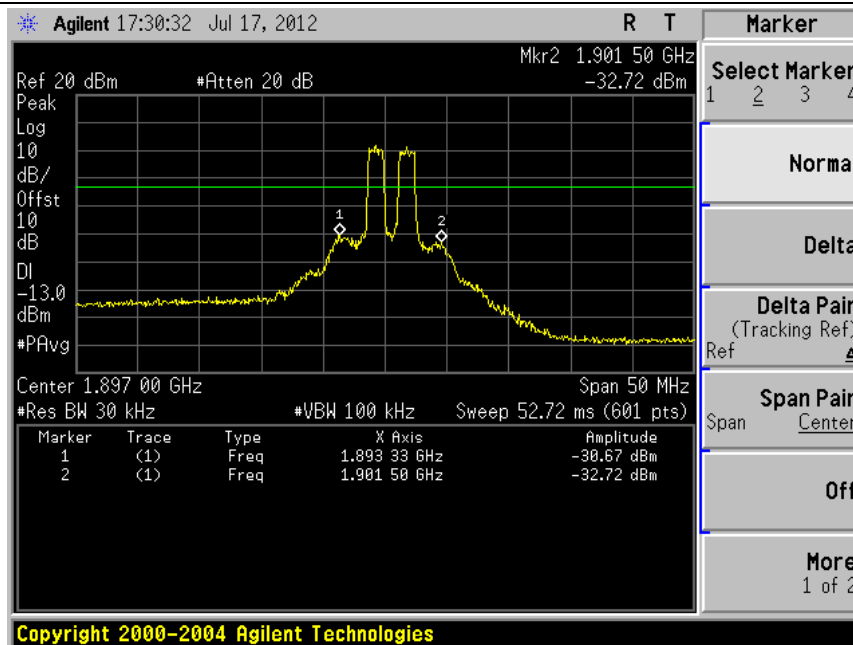

11 FIELD STRENGTH OF SPURIOUS RADIATION MEASUREMENT

11.1 Standard Applicable

According to FCC §2.1053, §22.917, §24.238 and 2-11-04/EAB/RF.

11.2 EUT Setup (Block Diagram of Configuration)

Please refer the section §6.2 Configuration of Tested System.

11.3 Measurement Procedure

1. The EUT RF output port was connected to 50 ohm RF load.
2. The EUT input port was connected to signal generator and was setup to transmit maximum power.
3. The measurement antenna was placed at a distance of 3 meters from the EUT.
4. During the tests, the antenna height and polarization as well as EUT azimuth were varied in order to identify the maximum level of emissions from EUT.
5. The frequency range up to 10-th harmonic of each of the three fundamental frequencies (low, middle and high channels) was investigated. The worst case of emissions was reported.
6. For spurious emissions attenuation, the substitution method was used.
7. The EUT was substituted by a reference antenna (half-wave dipole – below 1 GHz, or Horn antenna – above 1 GHz), connected to a signal generator.
8. The signal generator output level was adjusted to obtain the same reading as from EUT. The EIRP at the spurious emissions frequency was calculated as follows:

$$\text{EIRP} = \text{S.G. output (dBm)} + \text{Antenna Gain(dBi)} - \text{Cable Loss (dB)}$$

9. The antenna substitution method is used to determine the equivalent radiated power at spurious frequencies. The spurious emissions are measured at a distance of 3 meters. The EUT is then replaced with a reference substitution antenna with a known gain referenced to a dipole. This antenna is fed with a signal at the spurious frequency. The level of the signal is adjusted to repeat the previously measured level. The resulting eirp is the signal level fed to the reference antenna corrected for gain referenced to an isotropic dipole
10. From 2-11-04/EAB/RF: Radiated spurs (enclosure) – Use of CW signal (low, mid. and high freq.) is acceptable rather than all modulations.
11. The maximum RFI field strength was determined during the measurement by rotating the turntable (± 180 degrees) and varying the height of the receive antenna ($h = 1 \dots 4$ m) as like defined in ANSI C63.4. A measurement receiver has been used with a RBW 120 kHz up to 1 GHz and 1 MHz above 1 GHz. Steps with during pre measurement was half the RBW.
12. Both, the Fully Anechoic Chamber (FAC) and the Semi Anechoic Chamber (SAC) fulfil the requirements of ANSI C63.4 and CISPR 16-1-4 with regards to NSA and SVSWR.

11.4 Test Result

Test mode:	850 MHz Band		Test channel:	Middle
Frequency (MHz)	Spurious Emission		Limit (dBm)	Result
	Polarization	Level (dBm)		
35.88	Vertical	-51.19	-13.00	Pass
73.62	V	-53.54		
1595.88	V	-55.15		
3069.02	V	-50.48		
7161.43	V	-37.95		
7852.36	V	-37.03		
36.00	Horizontal	-59.91	-13.00	Pass
86.20	H	-59.69		
1256.03	H	-52.37		
3083.19	H	-50.16		
4436.09	H	-45.00		
5807.64	H	-41.40		
Test mode:	1900 MHz Band		Test channel:	Middle
Frequency (MHz)	Spurious Emission		Limit (dBm)	Result
	Polarization	Level (dBm)		
35.68	Vertical	-50.15	-13.00	Pass
74.54	V	-52.46		
1624.75	V	-54.43		
3175.24	V	-50.11		
7260.42	V	-36.78		
37.40	Horizontal	-58.76	-13.00	Pass
88.54	H	-57.24		
1485.38	H	-50.32		
3157.45	H	-49.23		
4527.22	H	-43.53		
5956.25	H	-40.18		

Remark: Pre-scan low, middle, high channels, the worst case were middle channel which recorded.

12 OUT OF BAND REJECTION

12.1 Standard Applicable

According to 2-11-04/EAB/RF.

12.2 EUT Setup (Block Diagram of Configuration)

Please refer the section §6.2 Configuration of Tested System.

12.3 Measurement Procedure

1. The EUT RF output port was connected to spectrum analyzer.
2. The level of RF input signal shall be increased, until the maximum output power per channel, declared by client, is reached.
3. A continuous sinusoidal RF signal shall be fed successively at frequency offsets 100 MHz from the edges of the relevant MS or BTS transmit frequency band into the relevant input port of the repeater.
4. The RF output curve was recorded by spectrum analyzer.

Cellular Band Uplink

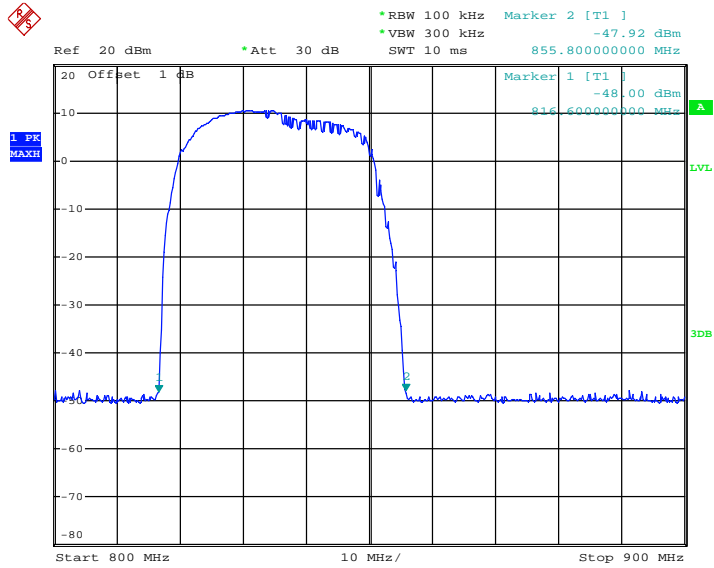

Date: 21.AUG.2012 04:31:40

Cellular Band Downlink

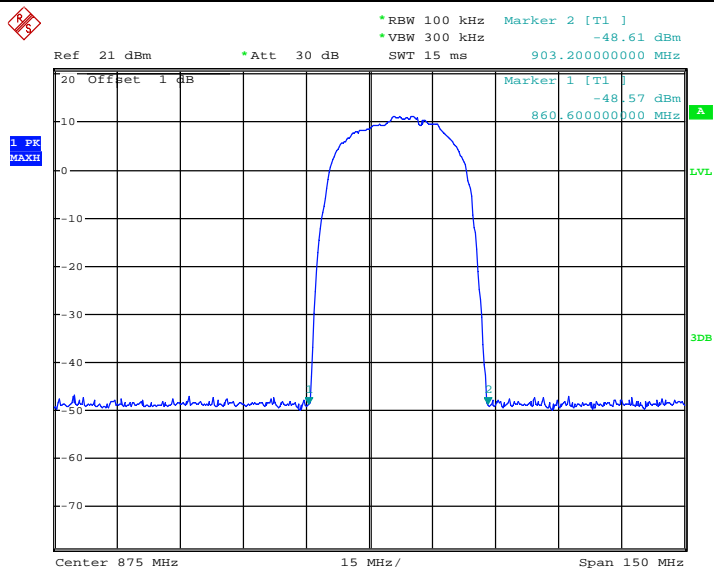

Date: 21.AUG.2012 04:24:07

PCS Band Uplink

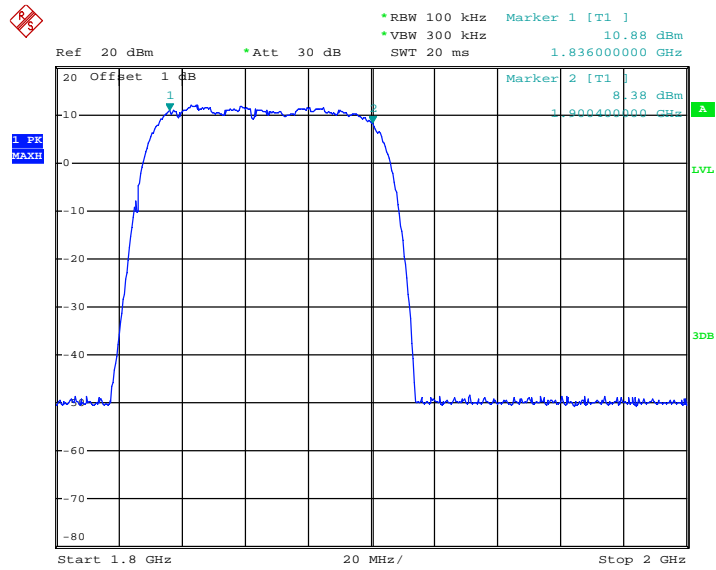

Date: 21.AUG.2012 04:44:36

PCS Band Downlink

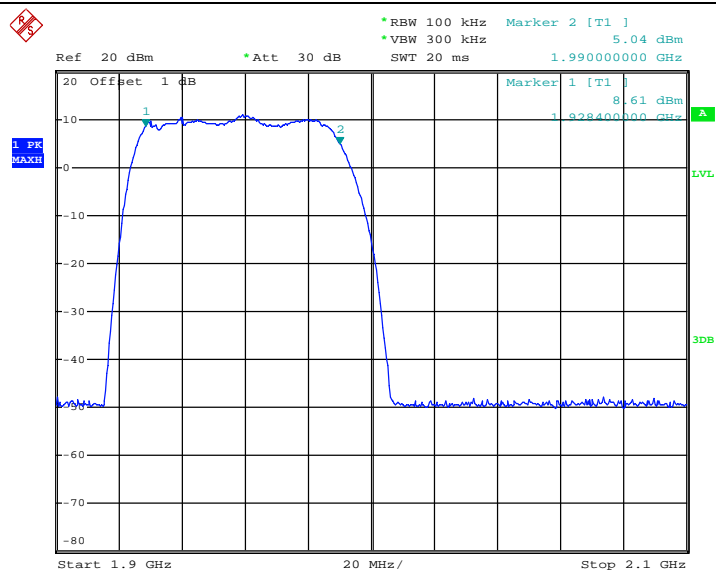

Date: 21.AUG.2012 05:11:43

13 AC POWER LINE CONDUCTED EMISSION TEST

13.1 Standard Applicable

According to FCC §15.207.

The emission value for frequency within 150 kHz to 30MHz shall not exceed criteria of below chart.

Frequency range (MHz)	Limits dB(uV)	
	Quasi-peak	Average
0.15 to 0.50	79	66
0.50 to 30	73	60
<p>Note</p> <p>1.The lower limit shall apply at the transition frequencies</p> <p>2.The limit decreases linearly with the logarithm of the frequency in the range 0.15 MHz to 0.50 MHz.</p>		

13.2 Test setup

1. The conducted emission tests were performed in the test site, using the setup in accordance with the ANSI C63.4-2003.
2. The EUT was plug-in DC power adaptor and was placed on the centre of the back edge on the test table. The peripherals were placed on the side of the EUT. The rear of the EUT and peripherals were placed flushed with the rear of the tabletop.
3. The Power adaptor was connected with 120Vac/60Hz power source.

13.3 Test Procedure

1. The EUT was placed on a table which is 0.8m above ground plane.
2. Maximum procedure was performed on the six highest emissions to ensure EUT compliance.
3. Repeat above procedures until all frequency measured was complete.

13.4 Test Result

Line:

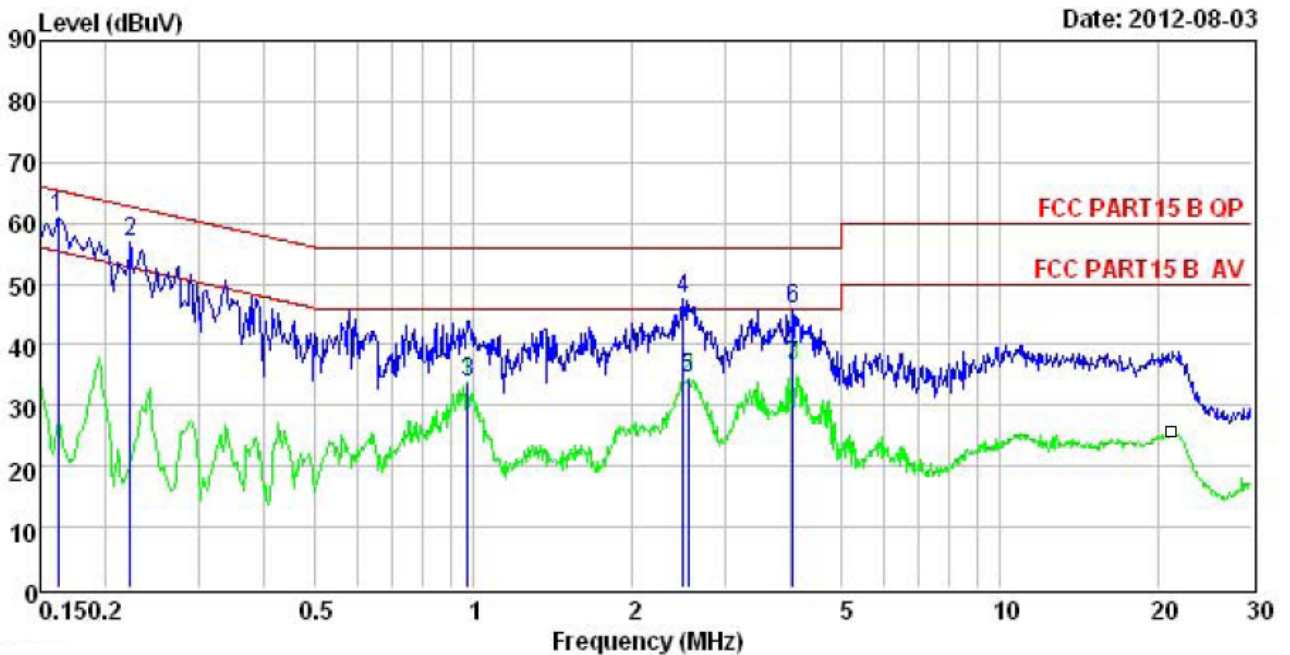

	Read	Cable	Limit	Over		
Freq	Level	Loss	Level	Line	Limit	Remark
MHz	dBuV	dB	dBuV	dBuV	dB	
1	49.81	0.78	60.83	65.34	-4.51	Peak
2	45.76	0.76	56.74	62.74	-6.00	Peak
3	22.62	0.86	33.69	46.00	-12.31	Average
4	36.16	0.94	47.38	56.00	-8.62	Peak
5	23.26	0.94	34.48	46.00	-11.52	Average
6	34.77	0.89	45.95	56.00	-10.05	Peak
7	25.13	0.89	36.31	46.00	-9.69	Average

Neutral:

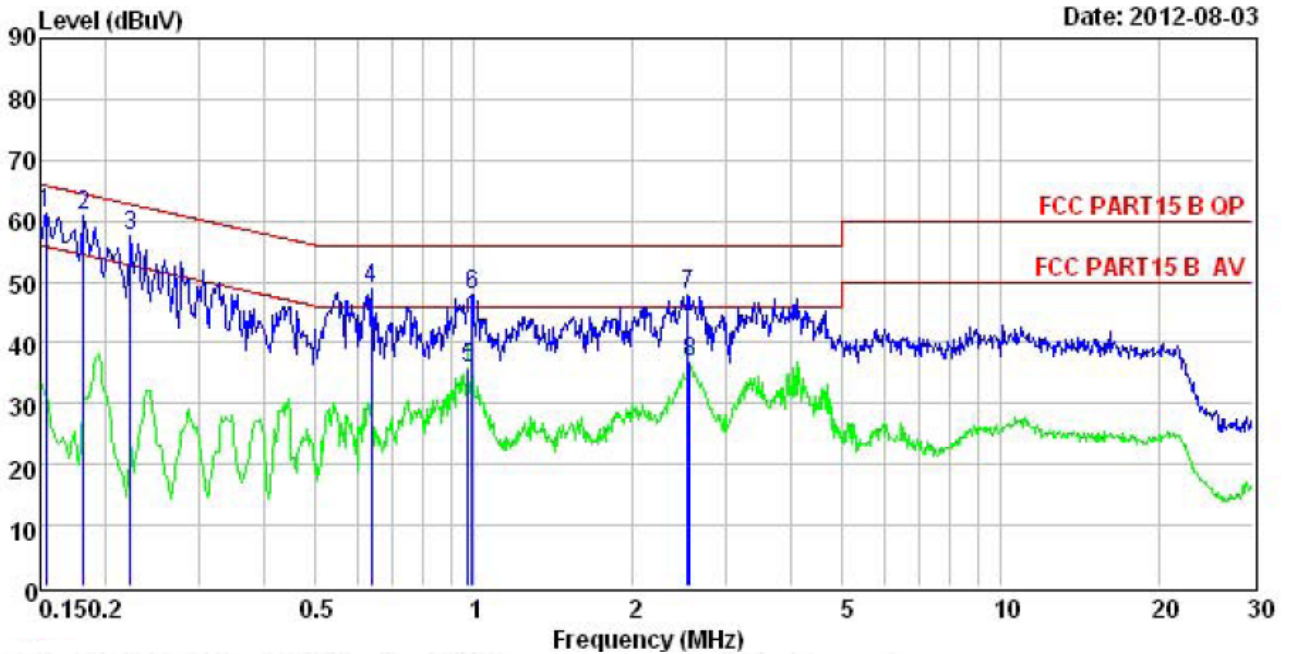

	Read Freq	Cable Loss	Read Level	Limit Line	Over Limit	Remark
	MHz	dB	dBuV	dBuV	dB	
1	0.154	0.79	50.32	65.78	-4.40	Peak
2	0.182	0.77	49.86	64.42	-3.55	Peak
3	0.222	0.76	46.39	62.74	-5.36	Peak
4	0.637	0.77	37.87	56.00	-7.17	Peak
5	0.974	0.86	24.71	46.00	-10.23	Average
6	0.989	0.87	36.69	56.00	-8.24	Peak
7	2.540	0.94	36.55	56.00	-8.24	Peak
8	2.567	0.94	25.54	46.00	-9.25	Average