



TESTING LABORATORY  
CERTIFICATE # 4821.01



# FCC PART 20.21

## TEST REPORT

For

### SHENZHEN HUAPTEC CO., LTD

3rd FL, E BLDG, Sogood Science Park, SanWei community, Hangcheng Street, Bao'an District,  
Shenzhen, China

**FCC ID: OWWC110505S**

<b>Report Type:</b> Original Report	<b>Product Type:</b> Mobile Signal Booster
<b>Report Number:</b> RSZ190723003-00B	
<b>Report Date:</b> 2019-10-15	
<b>Reviewed By:</b> RF Engineer	Jacob Kong 
<b>Prepared By:</b> Bay Area Compliance Laboratories Corp. (Shenzhen) 6/F., West Wing, Third Phase of Wanli Industrial Building, Shihua Road, Futian Free Trade Zone, Shenzhen, Guangdong, China Tel: +86-755-33320018 Fax: +86-755-33320008 <a href="http://www.baclcorp.com.cn">www.baclcorp.com.cn</a>	

**Note:** This report must not be used by the customer to claim product certification, approval, or endorsement by A2LA\* or any agency of the Federal Government. \* This report may contain data that are not covered by the A2LA accreditation and are marked with an asterisk “\*\*”

## TABLE OF CONTENTS

<b>GENERAL INFORMATION.....</b>	<b>4</b>
PRODUCT DESCRIPTION FOR EQUIPMENT UNDER TEST (EUT) .....	4
OBJECTIVE .....	4
RELATED SUBMITTAL(S)/GRANT(S).....	4
TEST METHODOLOGY .....	4
MEASUREMENT UNCERTAINTY .....	5
TEST FACILITY .....	5
<b>SYSTEM TEST CONFIGURATION.....</b>	<b>6</b>
DESCRIPTION OF TEST CONFIGURATION .....	6
EUT EXERCISE SOFTWARE .....	6
SPECIAL ACCESSORIES.....	6
EQUIPMENT MODIFICATIONS .....	7
SUPPORT EQUIPMENT LIST AND DETAILS .....	7
EXTERNAL I/O CABLE.....	7
BLOCK DIAGRAM OF TEST SETUP .....	7
<b>SUMMARY OF TEST RESULTS .....</b>	<b>8</b>
<b>TEST EQUIPMENT LIST .....</b>	<b>9</b>
<b>§ 20.21(E)(3) – AUTHORIZED FREQUENCY BAND VERIFICATION.....</b>	<b>11</b>
APPLICABLE STANDARD .....	11
TEST PROCEDURE .....	11
TEST DATA .....	12
<b>§ 20.21(e)(8)(i)(D) , § 20.21(e)(8)(i)(B)&amp; §20.21(e)(4)– MAXIMUM POWER MEASUREMENT .....</b>	<b>18</b>
APPLICABLE STANDARD .....	18
TEST PROCEDURE .....	18
TEST DATA .....	19
<b>§ 20.21(e)(8)(i)(C)(2), § 20.21(e)(8)(i)(B)&amp;§20.21(e)(4) – MAXIMUM BOOSTER GAIN COMPUTATION ....</b>	<b>22</b>
APPLICABLE STANDARDS.....	22
TEST PROCEDURE .....	22
TEST DATA .....	22
<b>§ 20.21(e)(8)(i)(F)- INTERMODULATION PRODUCT.....</b>	<b>24</b>
APPLICABLE STANDARDS.....	24
TEST PROCEDURE .....	24
TEST DATA .....	25
<b>§ 20.21(e)(8)(i)(E)- OUT OF BAND EMISSIONS .....</b>	<b>36</b>
APPLICABLE STANDARDS.....	36
TEST PROCEDURE .....	36
TEST DATA .....	37
<b>§ 20.21(e)(8)(i)(A), § 20.21(e)(8)(i)(H) &amp;§20.21(e)(4) - NOISE LIMITS .....</b>	<b>98</b>
APPLICABLE STANDARDS.....	98
TEST PROCEDURE .....	98
TEST DATA .....	99

**§ 20.21(e)(8)(i)(I) & §20.21(e)(4) - UPLINK INACTIVITY .....109**  
 APPLICABLE STANDARDS.....109  
 TEST PROCEDURE .....109  
 TEST DATA .....110

**§ 20.21(e)(8)(i)(C)(1) & § 20.21(e)(8)(i)(H) - VARIABLE BOOSTER GAIN.....113**  
 APPLICABLE STANDARDS.....113  
 TEST PROCEDURE .....113  
 TEST DATA .....114

**§ 2.1049 - OCCUPIED BANDWIDTH .....120**  
 APPLICABLE STANDARDS.....120  
 TEST PROCEDURE .....120  
 TEST DATA .....121

**§ 20.21(e)(8)(ii)(A) & §20.21(e)(4) - OSCILLATION DETECTION .....152**  
 APPLICABLE STANDARDS.....152  
 TEST PROCEDURE .....152  
 TEST DATA .....152

**§2.1051- SPURIOUS EMISSIONS AT ANTENNA TERMINALS .....167**  
 APPLICABLE STANDARDS.....167  
 TEST PROCEDURE .....167  
 TEST DATA .....168

**§ 2.1053 - RADIATED SPURIOUS EMISSIONS .....188**  
 APPLICABLE STANDARDS.....188  
 TEST PROCEDURE .....188  
 TEST DATA .....189

## GENERAL INFORMATION

### Product Description for Equipment under Test (EUT)

Product	Mobile Signal Booster
Tested Model	C27G-5S-BTW
Multitple Model	C27G-5S-BTW-RV
Voltage Range	DC5V
Date of Test	2019-07-30~ 2019-10-15
Sample serial number	190723003
Received date	2019-07-23
Sample/EUT Status	Good condition

This device is a mobile wideband consumer and the BoosterOperating frequency bands list below:

Electrical specification	Uplink	Downlink
Frequency Range	698 ~ 716MHz	728 ~ 746MHz
	776 ~ 787MHz	746 ~ 757MHz
	824 ~ 849 MHz	869 ~ 894 MHz
	1850 ~ 1915MHz	1930 ~ 1995MHz
	1710 ~ 1755MHz	2110 ~ 2155MHz

### Objective

This test report is prepared on behalf of *SHENZHEN HUAPTEC CO., LTD* in accordance with Part 2, Part 20.21 and Part 22, Part 24, Part 27 of the Federal Communication Commissions rules.

### Related Submittal(s)/Grant(s)

No related submittal(s).

### Test Methodology

All tests and measurements indicated in this document were performed in accordance with the Code of federal Regulations Title 47 Part 2, Sub-part J as well as the following individual parts:

Applicable Standards: TIA 603-D. KDB 935210 D03 Signal Booster Measurements v04r03.

All emissions measurement was performed at Bay Area Compliance Laboratories Corp. (Shenzhen). The radiated testing was performed at an antenna-to-EUT distance of 3 meters.

**Measurement Uncertainty**

Item		Uncertainty
RF conducted test with spectrum		±0.9dB
Radiated emission	30MHz~1GHz	±5.91dB
	Above 1G	±4.92dB
Occupied Bandwidth		±0.5kHz
Temperature		±1.0°C
Humidity		±6%

**Test Facility**

The test site used by Bay Area Compliance Laboratories Corp. (Shenzhen) to collect test data is located on the 6/F., West Wing, Third Phase of Wanli Industrial Building, Shihua Road, Futian Free Trade Zone, Shenzhen, Guangdong, China.

The test site has been approved by the FCC under the KDB 974614 D01 and is listed in the FCC Public Access Link (PAL) database, FCC Registration No. : 342867, the FCC Designation No. : CN1221.

The test site has been registered with ISED Canada under ISED Canada Registration Number 3062B.

## SYSTEM TEST CONFIGURATION

### Description of Test Configuration

The system was configured for testing in a test mode which has been done in the factory.

Antenna kitting requirement: EUT has one set antenna kitting for marketing, the antenna gain and cable loss for varier band were listed below, fulfill the requirement of FCC Part 20.21(e)(8)(i)(G), more detail information please refer to the user manuals.

Outdoor antenna:

Frequency band (MHz)	Antenna Gain (dBi)		Cable loss (dB)
	Magnetic antenna	Omni antenna	
698-716	1	4	2.2
776-787	1	4	2.3
824-849	2	4	2.3
1710-1755	4	6	4.6
1850-1915	3	5	4.0

Indoor antenna:

Frequency band (MHz)	Antenna Gain (dBi)		Cable loss (dB)
	Magnetic antenna	Panel antenna	
728-746	-1.5	-2	4
746-757	-1.5	-2	4
869-894	-1.5	-2	4
2110-2155	2	0.5	4.5
1930-1995	2.5	0.5	4.5

Note: For magnetic antenna, it include a cable and will not supply with extra cable, so for magnetic antenna calculation is no need consider the cable loss.

### EUT Exercise Software

No exercise software was used.

### Special Accessories

No special accessory was used.

**Equipment Modifications**

No modification was made to the EUT tested.

**Support Equipment List and Details**

Manufacturer	Description	Model	Serial Number
Un-known	Load	Un-known	Un-known
Rohde & Schwarz	Wideband Radio Communication Tester	CMW500	1201.002K50-146520-wh
Panasonic	Storage Battery	LC-P1224ST	N/A

**External I/O Cable**

Cable Description	Length (m)	From Port	To
Shielding Detachable RF Cable	1.2	EUT	CMW500
Un-shielding Detachable DC Cable	1.5	Car charger	EUT
Un-shielding Detachable AC Cable	1.5	Mains	CMW500
Un-shielding Detachable DC Cable	1.0	Car Charger	Battery

**Block Diagram of Test Setup**

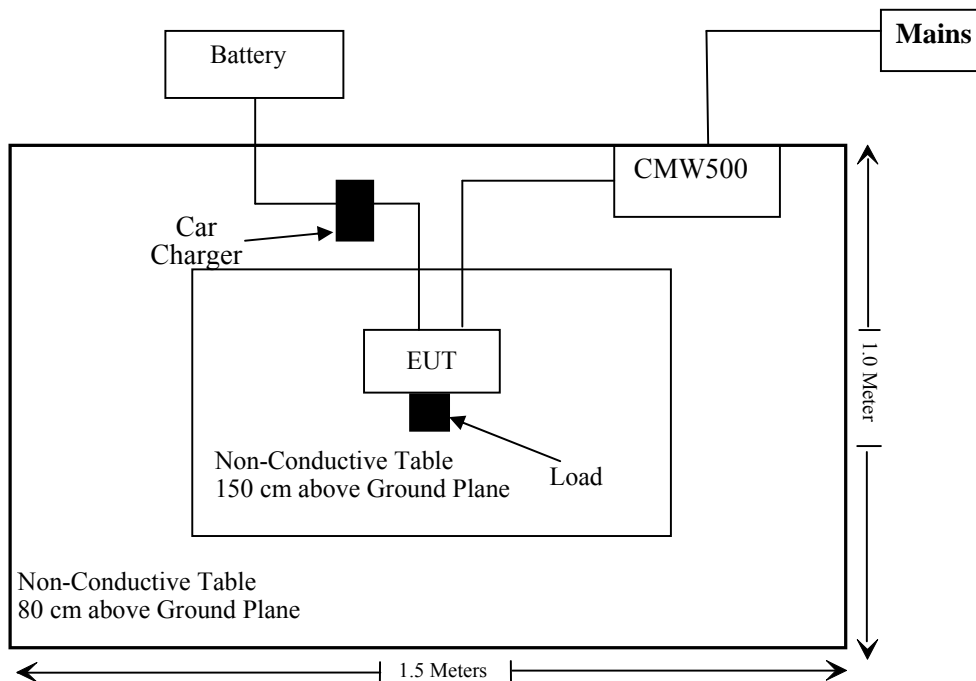

**SUMMARY OF TEST RESULTS**

<b>FCC Rules</b>	<b>Description of Test</b>	<b>Results</b>
§20.21(e)(3)	7.1 Authorized Frequency Band Verification	Compliance
§ 20.21(e)(8)(i)(D) § 20.21(e)(8)(i)(B) & §20.21(e)(4)	7.2 Maximum Power Measurement	Compliance
§ 20.21(e)(8)(i)(C)(2) § 20.21(e)(8)(i)(B) & §20.21(e)(4)	7.3 Maximum Booster Gain Computation	Compliance
§ 20.21(e)(8)(i)(B) § 20.21(e)(3)	7.13 Spectrum block filtering test procedure	Not applicable
§ 20.21(e)(8)(i)(F)	7.4 Intermodulation Product	Compliance
§ 20.21(e)(8)(i)(E)	7.5 Out Of Band Emissions	Compliance
§ 20.21(e)(8)(i)(A) § 20.21(e)(8)(i)(H) &§20.21(e)(4)	7.7 Noise Limits	Compliance
§ 20.21(e)(8)(i)(I) &§20.21(e)(4)	7.8 Uplink Inactivity	Compliance
§ 20.21(e)(8)(i)(C)(1) & § 20.21(e)(8)(i)(H)	7.9 Variable Booster Gain	Compliance
§ 2.1049	7.10 Occupied Bandwidth	Compliance
§ 20.21(e)(8)(ii)(A) &§20.21(e)(4)	7.11 Oscillation Detection	Compliance
§2.1051	7.6 Spurious Emissions At Antenna Terminals	Compliance
§ 2.1053	7.12 Radiated Spurious Emissions	Compliance

Not applicable: This item only for wideband consumer boosters utilizing spectrum block filtering.



**TEST EQUIPMENT LIST**

Manufacturer	Description	Model	Serial Number	Calibration Date	Calibration Due Date
<b>Radiated Emission Test</b>					
Sunol Sciences	Horn Antenna	DRH-118	A052604	2017-12-22	2020-12-21
Rohde & Schwarz	Signal Analyzer	FSEM	845987/005	2019-07-22	2020-07-21
Sunol Sciences	Broadband Antenna	JB1	A040904-1	2017-12-22	2020-12-21
COM-POWER	Pre-amplifier	PA-122	181919	2018-11-12	2019-11-12
Sonoma Instrument	Amplifier	310N	186238	2018-11-12	2019-11-12
Agilent	Signal Generator	N5183A	MY51040755	2018-12-03	2019-12-03
Rohde & Schwarz	EMI Test Receiver	ESR3	102455	2019-07-09	2020-07-08
COM-POWER	Dipole Antenna	AD-100	41000	NCR	NCR
A.H. System	Horn Antenna	SAS-200/571	135	2018-09-01	2021-08-31
UTiFLEX MICRO-COAX	RF Cable	UFA147A-2362-100100	MFR64639 231029-003	2018-11-12	2019-11-12
Ducommun Technologies	RF Cable	104PEA	218124002	2018-11-12	2019-11-12
Ducommun Technologies	RF Cable	RG-214	1	2019-05-21	2019-11-19
Ducommun Technologies	RF Cable	RG-214	2	2018-11-12	2019-11-12
Ducommun Technologies	Horn Antenna	ARH-4223-02	1007726-04	2017-12-29	2020-12-28
Ducommun Technologies	Horn Antenna	ARH-4223-02	1007726-03	2017-12-29	2020-12-28
Ducommun Technologies	Pre-amplifier	ALN-22093530-01	991373-01	2018-08-03	2019-08-03

Manufacturer	Description	Model	Serial Number	Calibration Date	Calibration Due Date
<b>RF Conducted test</b>					
Rohde & Schwarz	Spectrum Analyzer	FSU26	200120	2018-12-24	2019-12-24
Rohde & Schwarz	Wideband Radio Communication Tester	CMW500	1201.002K50-146520-wh	2019-07-09	2020-07-08
Agilent	Signal Generator	N5183A	MY51040755	2018-12-03	2019-12-03
Ducommun Technologies	RF Cable	104PEA	218124002	2018-11-12	2019-11-12
Ducommun technologies	RF Cable	RG-214	3	Each Time	
WEINSCHTEL	3dB Attenuator	6231	666	Each Time	
HP	Adjustable attenuator	8496B	2827A12453	Each Time	
Agilent	Adjustable attenuator	8494B	2812A17263	Each Time	

\* **Statement of Traceability:** Bay Area Compliance Laboratories Corp. (Shenzhen) attests that all calibrations have been performed in accordance to requirements that traceable to National Primary Standards and International System of Units (SI).

## § 20.21(E)(3) – AUTHORIZED FREQUENCY BAND VERIFICATION

### Applicable Standard

According to § 20.21(e)(3) Frequency Bands

This test is intended to confirm that the signal booster only operates on the CMRS frequency bands authorized for use by the NPS. In addition, this test will identify the frequency at which the maximum gain is realized within each CMRS operational band, which then serves as a basis for subsequent tests.

### Test Procedure

- a) Connect the EUT to the test equipment as shown in Figure 1. Begin with the uplink output connected to the spectrum analyzer.
- b) Set the spectrum analyzer RBW for 100 kHz with the VBW  $\geq 3 \times$  the RBW using a PEAK detector with the MAX HOLD function.
- c) Set the center frequency of the spectrum analyzer to the center of the operational band under test with a span of 1 MHz.
- d) Set the signal generator for CW mode and tune to the center frequency of the operational band under test.
- e) Set the initial signal generator power to a level that is at least 6 dB below the AGC level specified by the manufacturer.
- f) Slowly increase the signal generator power level until the output signal reaches the AGC operational level.
- g) Reduce the signal generator power to a level that is 3 dB below the level noted above and manually reset the EUT.
- h) Reset the spectrum analyzer span to  $2 \times$  the CMRS band under test. Adjust the tuned frequency of the signal generator to sweep  $2 \times$  the CMRS band using the sweep function. The AGC must not be activated throughout the entire sweep.
- i) Using three markers, identify the CMRS band edges and the frequency with the highest power. Affirm that the values of all markers are visible on the display of the spectrum analyzer (e.g., marker table set to on).
- j) Capture the spectrum analyzer trace for inclusion in the test report.
- k) Repeat 7.1c) to 7.1j) for all operational uplink and downlink bands.

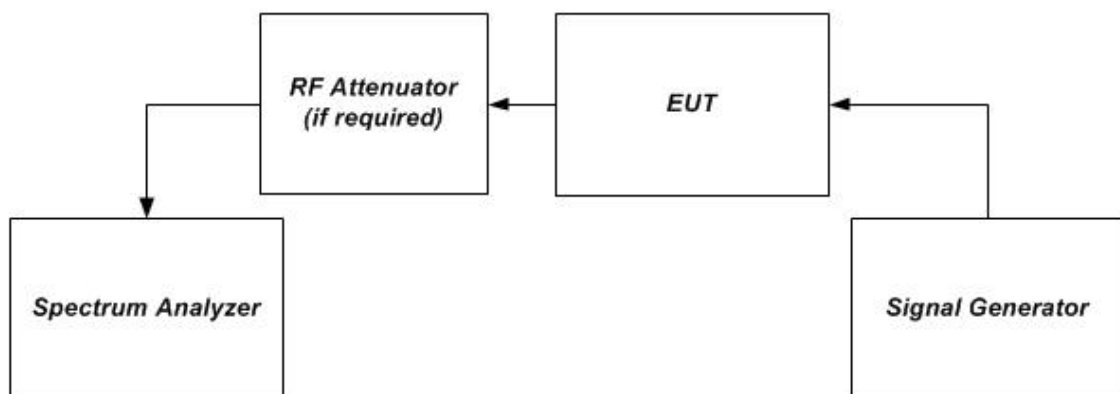

Figure 1 – Band verification test instrumentation setup

**Test Data**

**Environmental Conditions**

<b>Temperature:</b>	23~25 °C
<b>Relative Humidity:</b>	50~52 %
<b>ATM Pressure:</b>	101.0~101.2 kPa

The testing was performed by Kieron Luo on 2019-08-02 and 2019-08-22.

**Test Result:** Compliance. Please refer to following plots.

Uplink:

**Cellular Band**

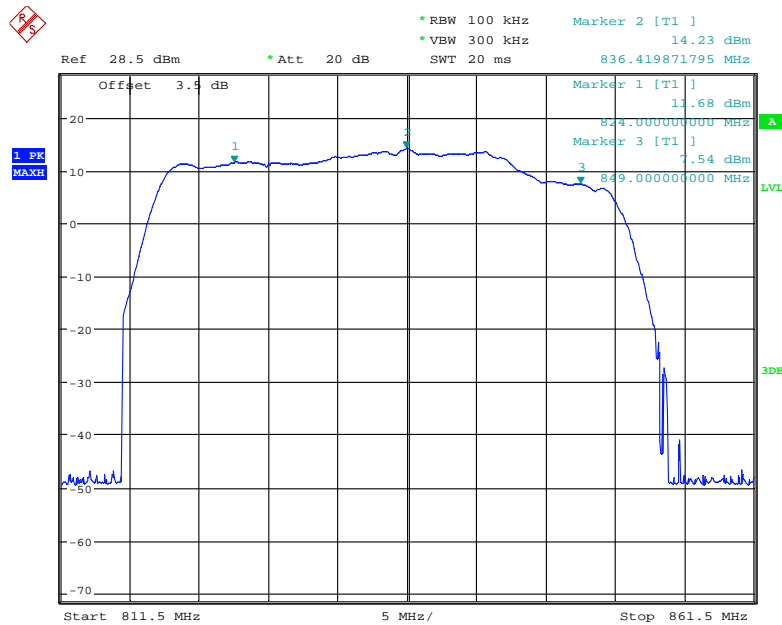

Date: 2.AUG.2019 05:13:54

### PCS Band

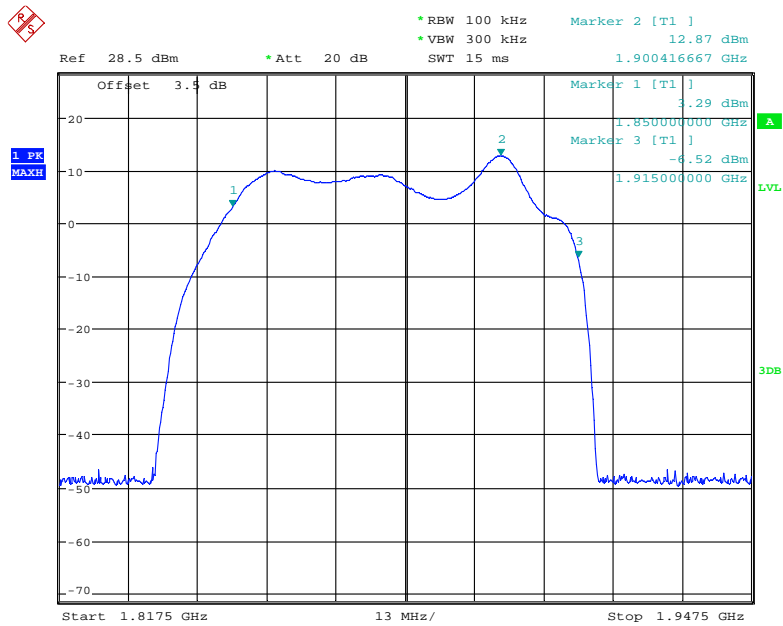

Date: 22.AUG.2019 09:37:28

### AWS Band

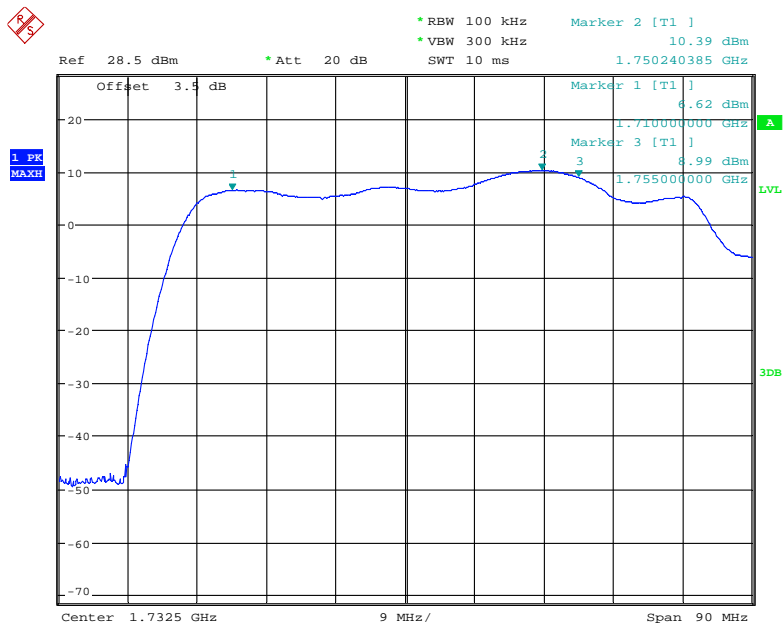

Date: 22.AUG.2019 09:25:59

### Lower 700MHz

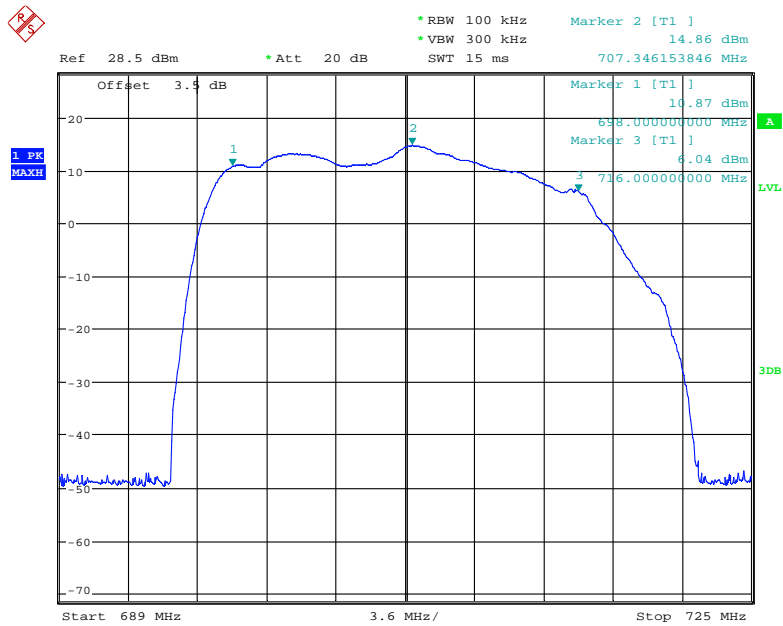

Date: 2.AUG.2019 05:23:40

### Upper 700MHz

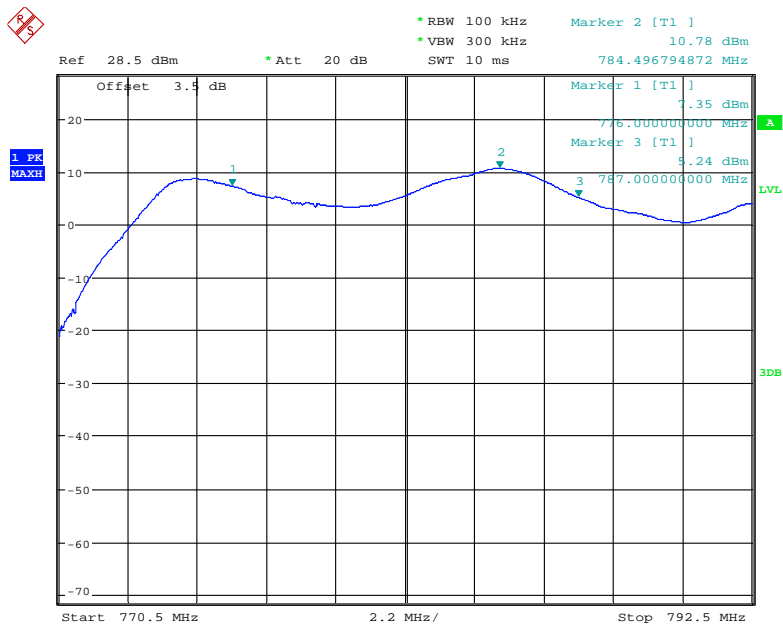

Date: 22.AUG.2019 09:56:43

Downlink:

### Cellular Band

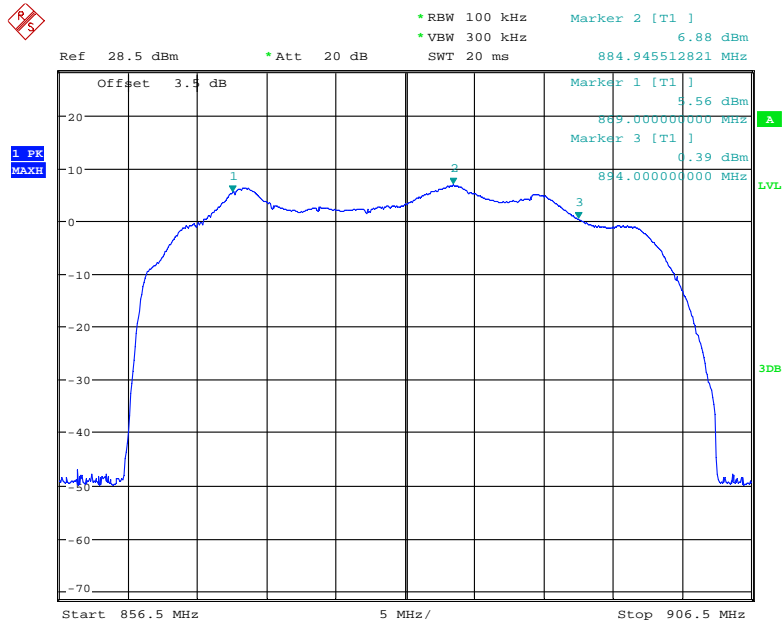

Date: 2.AUG.2019 05:33:09

### PCS Band

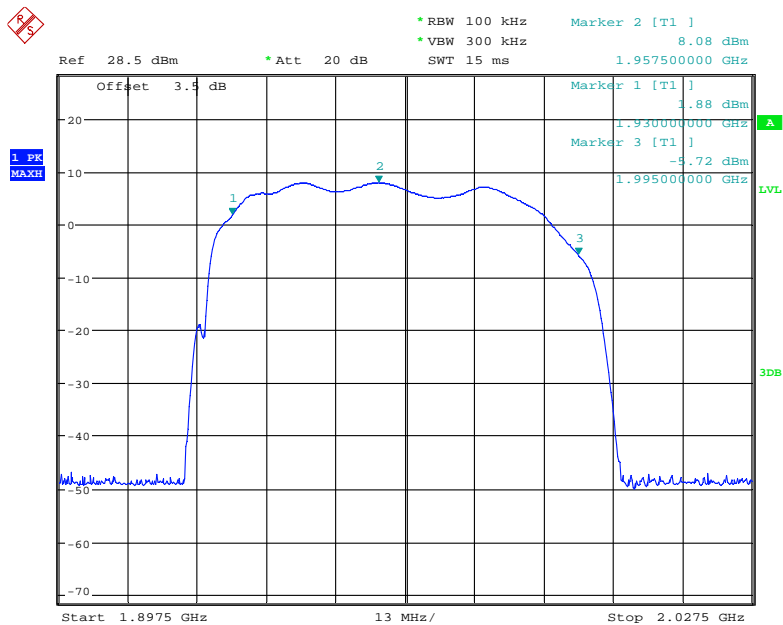

Date: 2.AUG.2019 05:29:52

### AWS Band

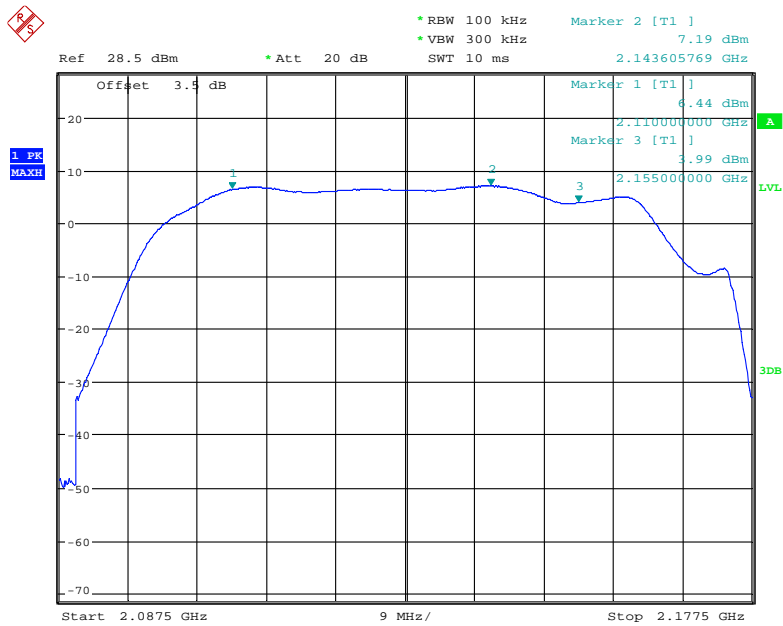

Date: 2.AUG.2019 05:38:23

### Lower 700MHz

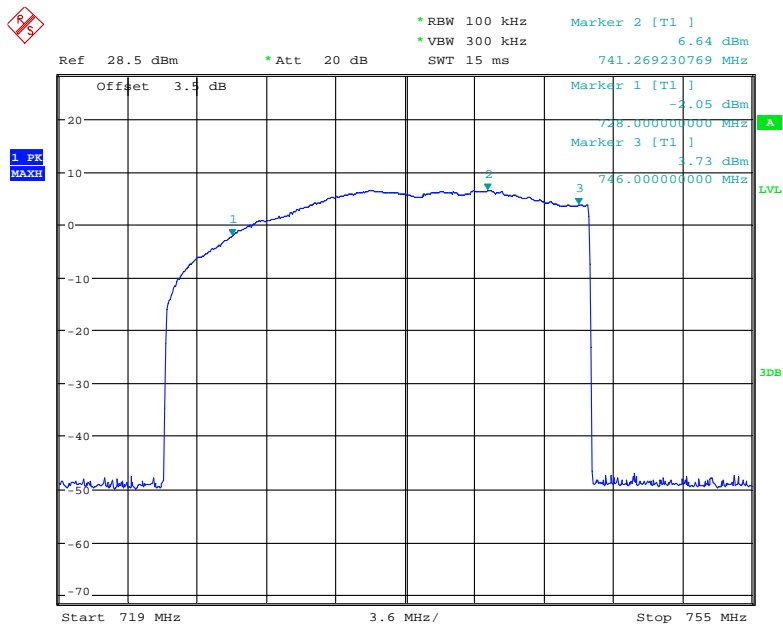

Date: 2.AUG.2019 05:45:30



### Upper 700MHz

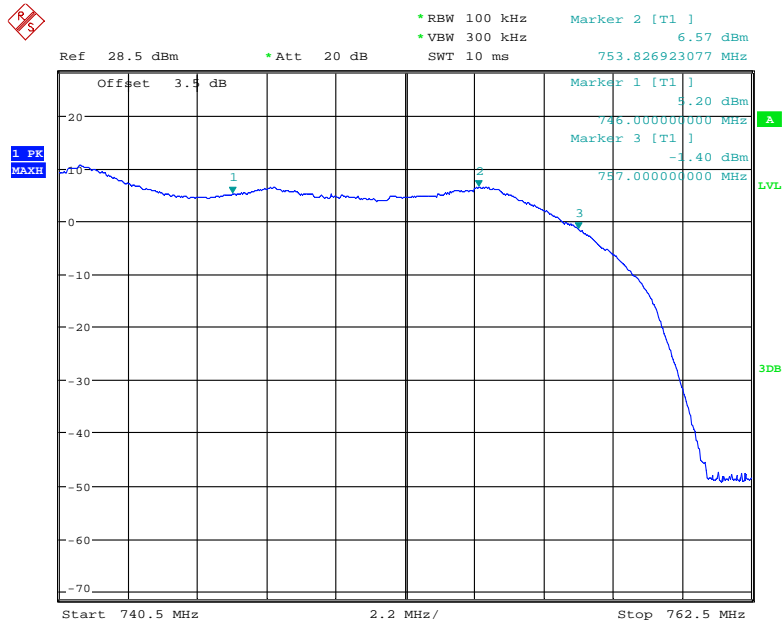

Date: 22.AUG.2019 10:50:53

## **§ 20.21(e)(8)(i)(D) ,§ 20.21(e)(8)(i)(B)& §20.21(e)(4)– MAXIMUM POWER MEASUREMENT**

### **Applicable Standard**

According to § 20.21(e)(8)(i)(D) Power Limits; § 20.21(e)(8)(i)(B) Bidirectional Capability (uplink minimum conducted power output); §20.21(e)(4) Self-monitoring.

This procedure shall be used to demonstrate compliance to the signal booster power limits and requirements as specified in §§ 20.21(e)(8)(i)(D) and 20.21(e)(8)(i)(B) for wideband consumer signal boosters.

- a) Compliance to authorized EIRP limits must be shown using the highest gains from the list of antennas, cabling, and coupling devices declared by the manufacturer for use with the consumer booster.
- b) In addition, the maximum power levels measured in this procedure will be utilized in calculating the maximum gain as described in the next subclause.
- c) The frequency with the highest power level in each operational band as determined in 7.1 is to be measured discretely by applying the following procedure utilizing the stated emission and power detector types independently.
- d) Use a signal generator to create a pulsed CW or GSM signal with a pulse width of 570  $\mu$ s and a duty cycle of 12.5% (i.e., one GSM timeslot), then measure utilizing the burst power function of the measuring instrument.
- e) Use a signal generator to create an AWGN signal with a 99% occupied bandwidth of 4.1 MHz, then measure utilizing the channel power or band power function of the measuring instrumentation.
- f) All modes of operation must be verified to maintain operation within authorized limits at the maximum uplink and downlink test levels per device type as defined in 5.4, by increasing the power level in 2 dB steps from the AGC level to the maximum input level specified in 5.5.

### **Test Procedure**

- a) Connect the EUT to the test equipment as shown in Figure 1. Begin with the uplink output (donor port) connected to the spectrum analyzer.
- b) Configure the signal generator and spectrum analyzer for operation on the frequency determined in 7.1 with the highest power level, but with the center frequency of the signal no closer than 2.5 MHz from the band edge. The spectrum analyzer span shall be set to at least 10 MHz.
- c) Set the initial signal generator power to a level well below that which causes AGC control.
- d) Slowly increase the signal generator power level until the output signal reaches the AGC operational limit (from observation of signal behavior on the spectrum analyzer; i.e., no further increase in output power as input power is increased).
- e) Reduce power sufficiently on the signal generator to ensure that the AGC is not controlling the power output.
- f) Slowly increase the signal generator power to a level just below (within 0.5 dB of) the AGC limit without triggering the AGC. Note the signal generator power level as  $P_{in}$ .
- g) Measure the output power  $P_{out}$  with the spectrum analyzer as follows.
  - 1) Set RBW = 100 kHz for AWGN signal type and 300 kHz for CW or GSM signal type.
  - 2) Set VBW  $\geq 3 \times$  RBW.
  - 3) Select either the BURST POWER or CHANNEL POWER measurement tool, as required for each signal type. The channel power integration bandwidth shall be 99% occupied bandwidth (4.1 MHz).
  - 4) Select the RMS (power averaging) detector.
  - 5) Ensure that the number Note: This requirement
  - 6) Set sweep time = auto

- 7) Trace average at least 100 traces in power averaging (i.e., RMS) mode.
- h) Record the measured power level as P<sub>OUT</sub> with one set of results for the GSM or CW input stimulus and another set of results for the AWGN input stimulus.
- i) Repeat step h) while increasing the signal generator amplitude in 2 dB steps until the maximum input level indicated in 5.5 is reached. If the booster has shut down at any point during the input power steps it should be noted and step h) shall be repeated at an input level 1 dB less than that found to cause the shutdown.
- j) Repeat the entire procedure for each operational uplink and downlink frequency band supported by the booster.
- k) Provide tabulated results in the test report.

**Test Data**

**Environmental Conditions**

<b>Temperature:</b>	25 °C
<b>Relative Humidity:</b>	52 %
<b>ATM Pressure:</b>	101.2 kPa

*The testing was performed by Kieron Luo on 2019-08-22 and 2019-10-15.*

*Test Result: Compliance. Please refer to the following tables*

**AGC level:**

Operation Band	Signal type	AGC Input level	
		Uplink (dBm)	Downlink (dBm)
PCS	AWGN	-28.87	-40.01
	CW	-26.68	-37.66
cellular	AWGN	-29.29	-38.10
	CW	-29.24	-38.58
AWS	AWGN	-28.26	-37.07
	CW	-27.05	-36.89
Lower 700 MHz	AWGN	-29.78	-40.54
	CW	-30.49	-34.81
Upper 700 MHz	AWGN	-30.56	-40.66
	CW	-30.52	-38.73

**Output Power:**

For Omni antenna(outdoor) and panel antenna(indoor):

Mode	Operation Band	Signal type	Pre AGC Input level	Conducted Output level	Antenna Gain	Cable loss	EIRP	Limit
			dBm	dBm	dBi	dB	dBm	dBm
Uplink	PCS	AWGN	-29.07	19.06	5	4.0	20.06	17-30
		CW	-27.08	22.00			23.00	
	cellular	AWGN	-29.59	18.18	4	2.3	19.88	
		CW	-29.44	19.52			21.22	
	AWS	AWGN	-28.56	19.68	6	4.6	21.08	
		CW	-27.25	22.12			23.52	
	Lower 700 MHz	AWGN	-29.98	18.13	4	2.2	19.93	
		CW	-30.79	18.87			20.67	
	Upper 700 MHz	AWGN	-30.76	17.49	4	2.3	19.19	
		CW	-30.82	18.51			20.21	
Downlink	PCS	AWGN	-40.31	7.76	0.5	4.5	3.76	≤17
		CW	-38.26	11.02			7.02	
	cellular	AWGN	-38.40	8.72	-2	4	2.72	
		CW	-38.88	10.85			4.85	
	AWS	AWGN	-37.17	11.73	0.5	4.5	7.73	
		CW	-37.09	12.66			8.66	
	Lower 700 MHz	AWGN	-40.74	7.08	-2	4	1.08	
		CW	-35.01	13.94			7.94	
	Upper 700 MHz	AWGN	-40.96	5.86	-2	4	-0.14	
		CW	-39.03	8.54			2.54	

For Magnetic antenna:

Mode	Operation Band	Signal type	Pre AGC Input level	Conducted Output level	Antenna Gain & Cable Loss	EIRP	Limit
			dBm	dBm	dB	dBm	dBm
Uplink	PCS	AWGN	-29.07	19.06	3	22.06	17-30
		GSM	-27.08	22.00		25.00	
	cellular	AWGN	-29.59	18.18	2	20.18	
		GSM	-29.44	19.52		21.52	
	AWS	AWGN	-28.56	19.68	4	23.68	
		GSM	-27.25	22.12		26.12	
	Lower 700 MHz	AWGN	-29.98	18.13	1	19.13	
		GSM	-30.79	18.87		19.87	
	Upper 700 MHz	AWGN	-30.76	17.49	1	18.49	
		GSM	-30.82	18.51		19.51	
Downlink	PCS	AWGN	-40.31	7.76	2.5	10.26	≤17
		GSM	-38.26	11.02		13.52	
	cellular	AWGN	-38.4	8.72	-1.5	7.22	
		GSM	-38.88	10.85		9.35	
	AWS	AWGN	-37.17	11.73	2	13.73	
		GSM	-37.09	12.66		14.66	
	Lower 700 MHz	AWGN	-40.74	7.08	-1.5	5.58	
		GSM	-35.01	13.94		12.44	
	Upper 700 MHz	AWGN	-40.96	5.86	-1.5	4.36	
		GSM	-39.03	8.54		7.04	

**Maximum Input level:**

Mode	Operation Band	Signal type	Maximum Input level	Maximum Input level Limits	Conducted Output level
			dBm	dBm	dBm
Uplink	PCS	AWGN	-19.4	27.0	19.21
		CW	-18.2		22.09
	Cellular	AWGN	-18.8		18.31
		CW	-16.5		19.66
	AWS	AWGN	-17.4		19.81
		CW	-19.2		22.20
	Lower 700 MHz	AWGN	-16.4		18.25
		CW	-14.8		18.96
	Upper 700 MHz	AWGN	-19.0		17.55
		CW	-18.5		18.63
Downlink	PCS	AWGN	-31.3	-20	7.85
		CW	-28.1		11.28
	Cellular	AWGN	-29.2		8.89
		CW	-26.7		10.93
	AWS	AWGN	-30.4		11.86
		CW	-27.2		12.73
	Lower 700 MHz	AWGN	-30.1		7.21
		CW	-26.6		14.13
	Upper 700 MHz	AWGN	-29.4		5.95
		CW	-29.2		8.66

Note: The output level was measured at input level 1 dB less than the maximum input level.

## § 20.21(e)(8)(i)(C)(2), § 20.21(e)(8)(i)(B) & § 20.21(e)(4) – MAXIMUM BOOSTER GAIN COMPUTATION

### Applicable Standards

According to § 20.21(e)(8)(i)(C)(2) (ii) Booster Gain Limits (maximum gain); § 20.21(e)(8)(i)(B) Bidirectional Capability (equivalent uplink and downlink gain); § 20.21(e)(4) Self-monitoring.

This subclause provides guidance on the computation of the maximum gain based on the results obtained from previous measurements. The NPS limits on maximum gain for fixed and mobile wideband consumer signal boosters are provided in § 20.21(e)(8)(i)(C)(2). Additionally, § 20.21(e)(8)(i)(B) requires that wideband consumer signal boosters be able to provide equivalent uplink and downlink gain (within 9 dB)

### Test Procedure

- a) Calculate the maximum gain of the booster as follows to demonstrate compliance to the applicable gain limits as specified.
- b) For both the uplink and downlink in each supported frequency band, use each of the  $P_{OUT}$  and  $P_{IN}$  result pairs for all signal types used in 7.2 in the following equation to determine the maximum gain (G) of the booster:  

$$G \text{ (dB)} = P_{OUT} \text{ (dBm)} - P_{IN} \text{ (dBm)}$$
- c) Record the maximum gain of the uplink and downlink paths for each supported frequency band, and verify that the each gain value complies with the applicable limit.
- d) Provide tabulated results in the test report.

### Test Data

#### Environmental Conditions

<b>Temperature:</b>	25 °C
<b>Relative Humidity:</b>	52 %
<b>ATM Pressure:</b>	101.2 kPa

*The testing was performed by Kieron Luo on 2019-08-22.*

**Test Result:** Compliance. Please refer to the following tables please refer to section 7.2.

Mode	Operation Band	Signal type	Pre AGC	Conducted	Gain	Limit
			Input level	Output level	dB	dB
			dBm	dBm		
Uplink	PCS	AWGN	-29.07	19.06	48.13	50
		CW	-27.08	22.00	49.08	
	Cellular	AWGN	-29.59	18.18	47.77	50
		CW	-29.44	19.52	48.96	
	AWS	AWGN	-28.56	19.68	48.24	50
		CW	-27.25	22.12	49.37	
	Lower 700 MHz	AWGN	-29.98	18.13	48.11	50
		CW	-30.79	18.87	49.66	
	Upper 700 MHz	AWGN	-30.76	17.49	48.25	50
		CW	-30.82	18.51	49.33	
Downlink	PCS	AWGN	-40.31	7.76	48.07	50
		CW	-38.26	11.02	49.28	
	Cellular	AWGN	-38.4	8.72	47.12	50
		CW	-38.88	10.85	49.73	
	AWS	AWGN	-37.17	11.73	48.9	50
		CW	-37.09	12.66	49.75	
	Lower 700 MHz	AWGN	-40.74	7.08	47.82	50
		CW	-35.01	13.94	48.95	
	Upper 700 MHz	AWGN	-40.96	5.86	46.82	50
		CW	-39.03	8.54	47.57	

Note: Mobile Booster maximum gain shall not exceed 50 dB when using an inside antenna.

**Equivalent Uplink and downlink gain:**

Operating Band	Signal type	Uplink	Downlink	Calculated	Limit
MHz		Gain	Gain	Value	dB
		dB	dB	dB	
PCS	AWGN	48.13	48.07	0.06	±9
	CW	49.08	49.28	-0.20	
Cellular	AWGN	47.77	47.12	0.65	
	CW	48.96	49.73	-0.77	
AWS	AWGN	48.24	48.9	-0.66	
	CW	49.37	49.75	-0.38	
Lower 700 MHz	AWGN	48.11	47.82	0.29	
	CW	49.66	48.95	0.71	
Upper 700 MHz	AWGN	48.25	46.82	1.43	
	CW	49.33	47.57	1.76	

## § 20.21(e)(8)(i)(F)- INTERMODULATION PRODUCT

### Applicable Standards

According to § 20.21(e)(8)(i)(F) Intermodulation Limits.

### Test Procedure

The following procedures shall be used to demonstrate compliance to the intermodulation limit specified in § 20.21(e)(8)(i)(F) for wideband consumer signal boosters.

- a) Connect the signal booster to the test equipment as shown in **Figure 2**. Begin with the uplink output connected to the spectrum analyzer.
- b) Set the spectrum analyzer RBW = 3 kHz.
- c) Set the VBW  $\geq 3 \times$  RBW.
- d) Select the RMS detector
- e) Set the spectrum analyzer center frequency to the center of the supported operational band under test.
- f) Set the span to 5 MHz. Affirm that the number of measurement points per sweep  $\geq (2 \times \text{span})/\text{RBW}$ .
- g) Configure the two signal generators for CW operation with generator 1 tuned 300 kHz below the operational band center frequency and generator 2 tuned 300 kHz above the operational band center frequency.
- h) Set the signal generator amplitudes so that the power from each into the RF combiner is equivalent, then turn on the RF output.
- i) Increase the signal generators' amplitudes equally until just before the EUT begins AGC and affirm that all intermodulation products (if any exist) are below the specified limit of -19 dBm.
- j) Utilize the trace averaging function of the spectrum analyzer and wait for the trace to stabilize. Place a marker at the highest amplitude intermodulation product.
- k) Record the maximum intermodulation product amplitude level that is observed.
- l) Capture the spectrum analyzer trace for inclusion in the test report.
- m) Repeat 7.4e) to 7.4l) for all uplink and downlink operational bands.

**Note:** *If using a single signal generator with dual outputs, affirm that intermodulation products are not the result of the generator.*

- n) Increase the signal generator amplitude in 2 dB steps to 10 dB above the AGC threshold determined in 7.4i), but to not to exceed the maximum input level in 5.5, to affirm that the EUT maintains compliance with the intermodulation limit

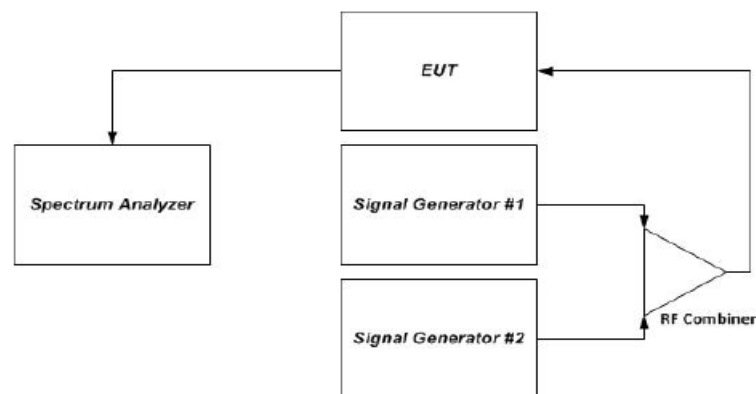

Figure 2 – Intermodulation product instrumentation test setup



**Test Data**

**Environmental Conditions**

<b>Temperature:</b>	25 °C
<b>Relative Humidity:</b>	52 %
<b>ATM Pressure:</b>	101.2 kPa

The testing was performed by Kieron Luo on 2019-08-03.

**Test Result:** Compliance. Please refer to following plots.

**Downlink**

**Cellular Pre-AGC**

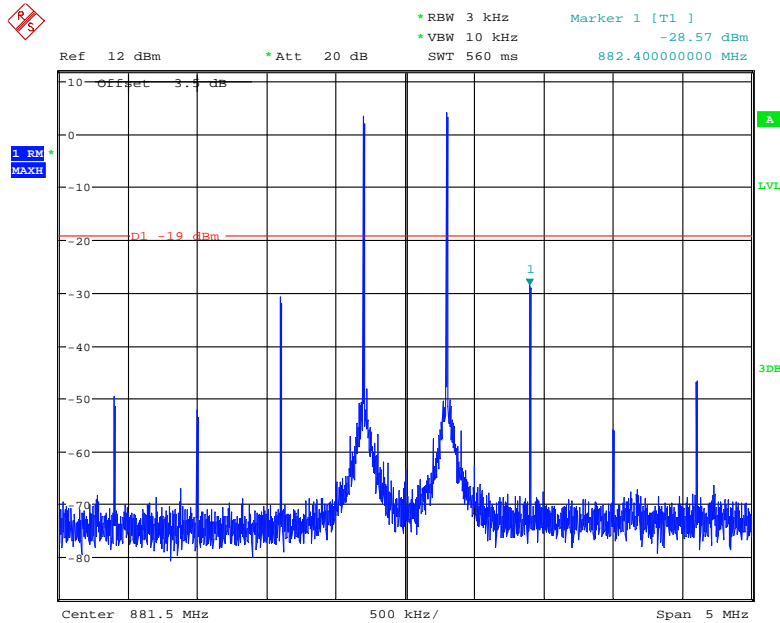

Date: 3.AUG.2019 13:16:19

### Cellular Above AGC

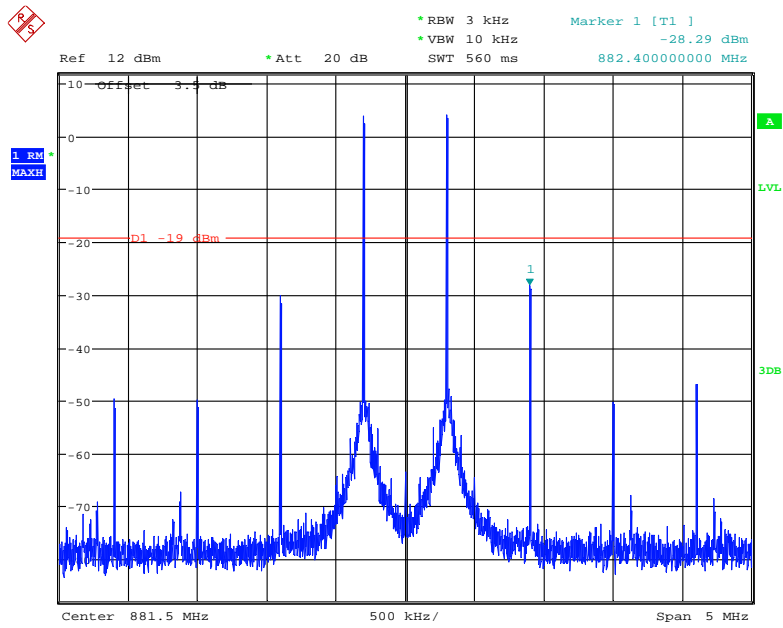

Date: 3.AUG.2019 13:16:46

### PCS Pre-AGC

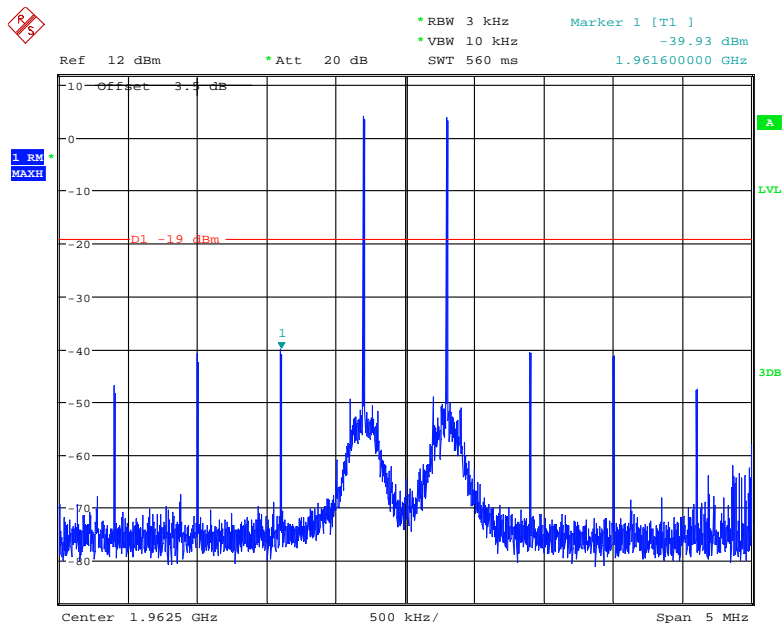

Date: 3.AUG.2019 13:18:18

### PCS Above AGC

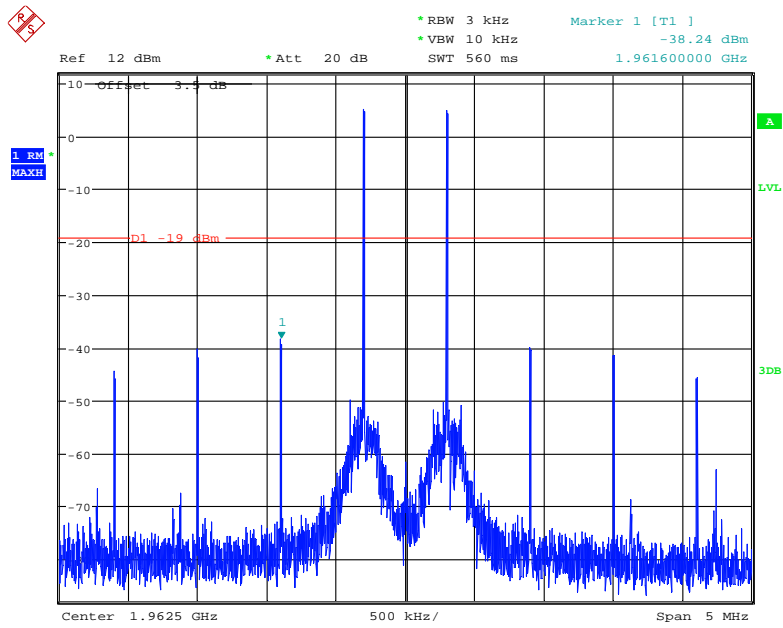

Date: 3.AUG.2019 13:19:04

### AWS Pre-AGC

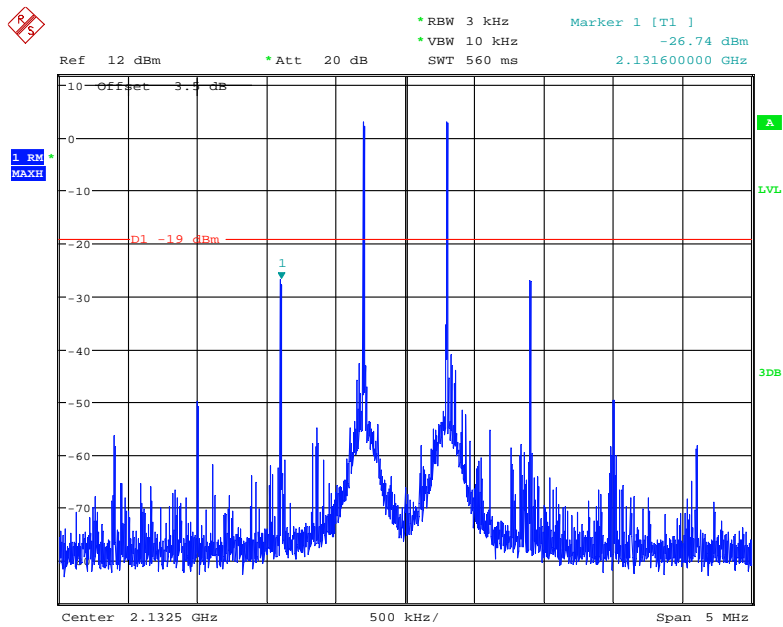

Date: 3.AUG.2019 13:21:16

### AWS Above AGC

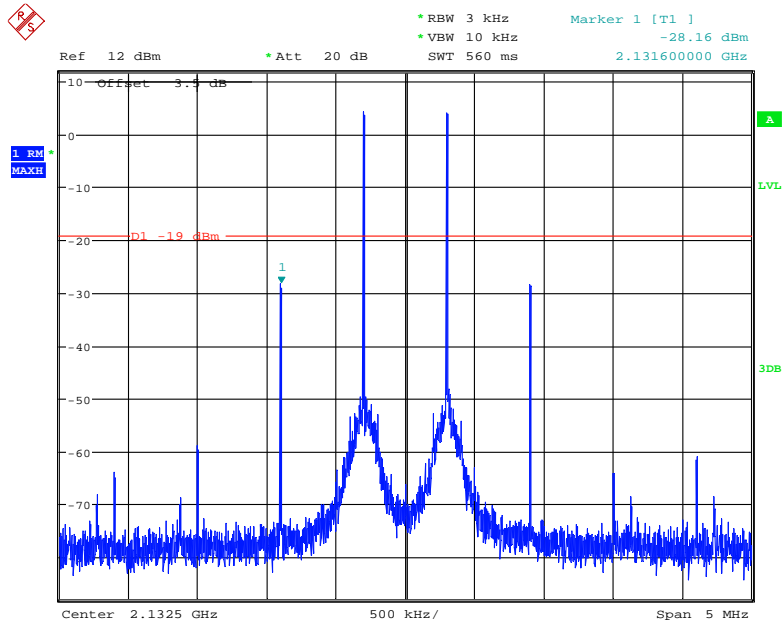

Date: 3.AUG.2019 13:21:43

### Lower 700MHz Pre-AGC

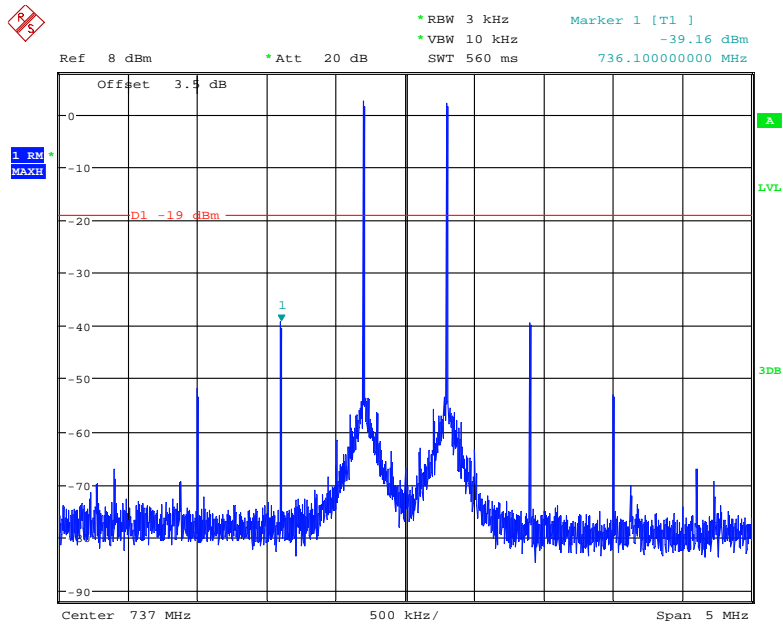

Date: 3.AUG.2019 13:25:30

### Lower 700MHz Above AGC

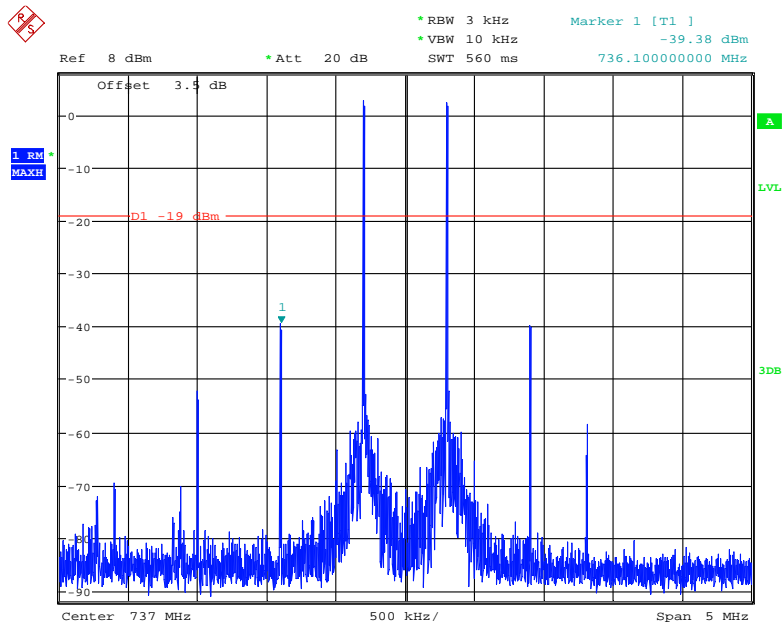

Date: 3.AUG.2019 13:25:59

### Upper 700MHz Pre-AGC

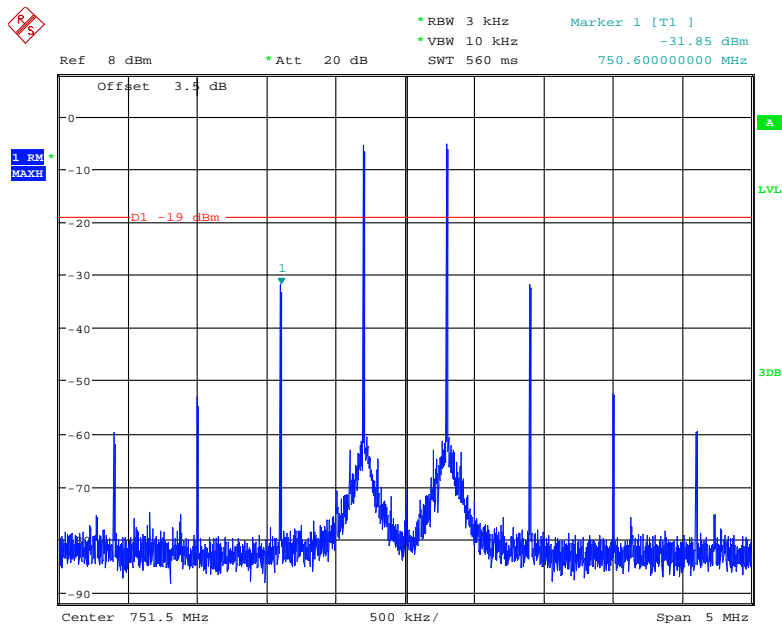

Date: 3.AUG.2019 13:28:23

### Upper 700MHz Above AGC

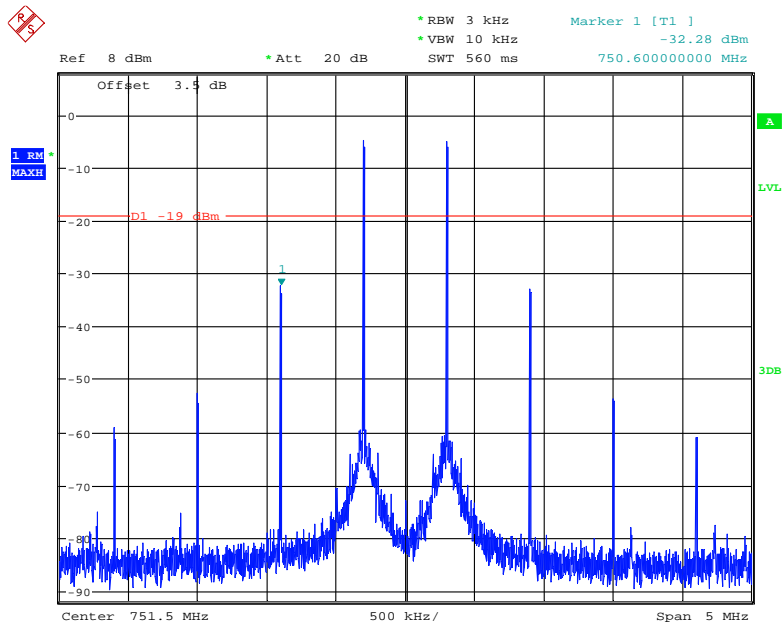

Date: 3.AUG.2019 13:28:54

### Uplink

### Cellular Pre-AGC

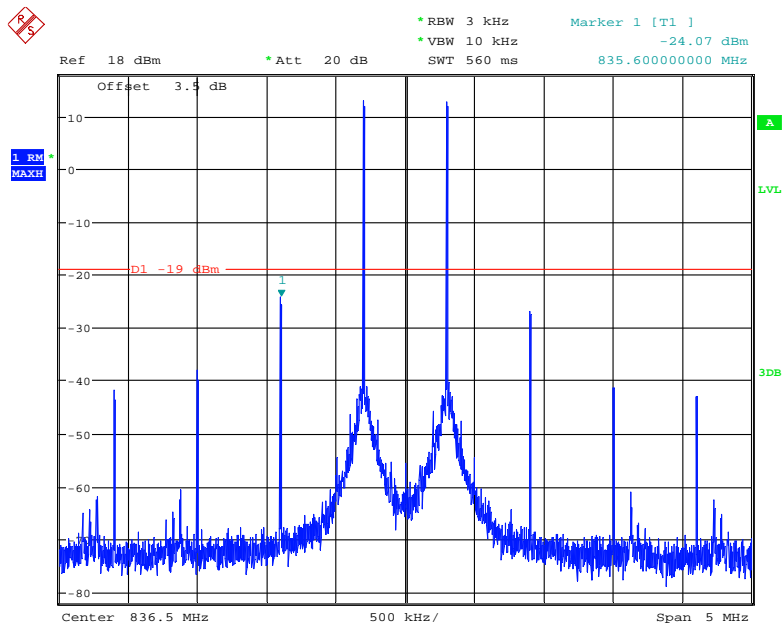

Date: 3.AUG.2019 13:35:39

### Cellular Above AGC

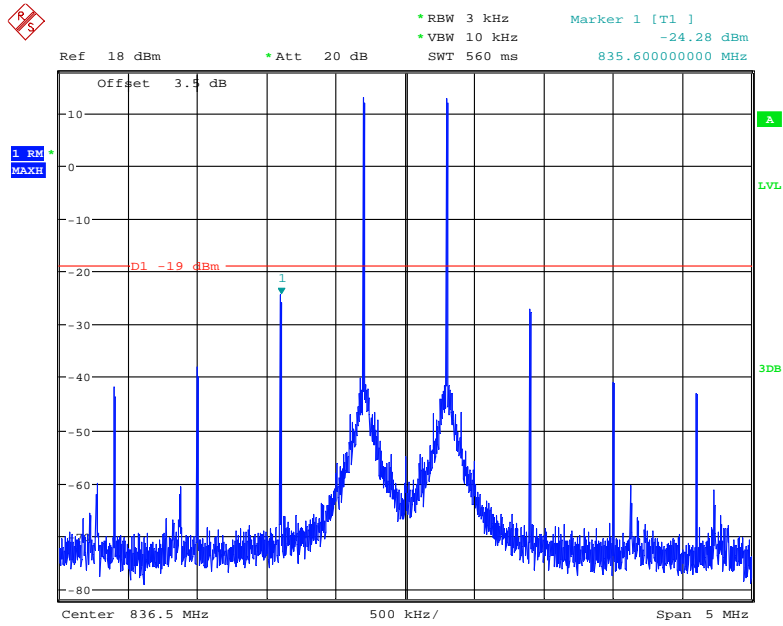

Date: 3.AUG.2019 13:36:51

### PCS Pre-AGC

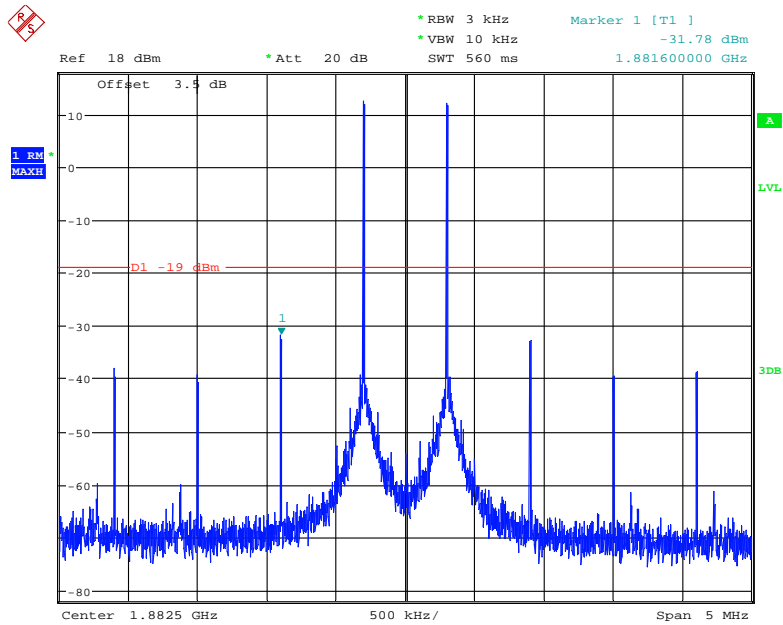

Date: 3.AUG.2019 13:38:02

### PCS Above AGC

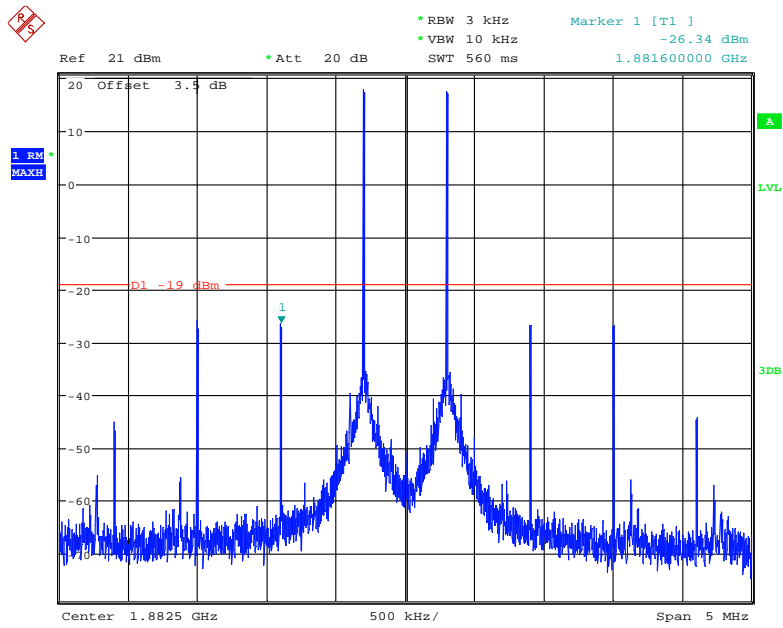

Date: 3.AUG.2019 13:43:25

### AWS Pre-AGC

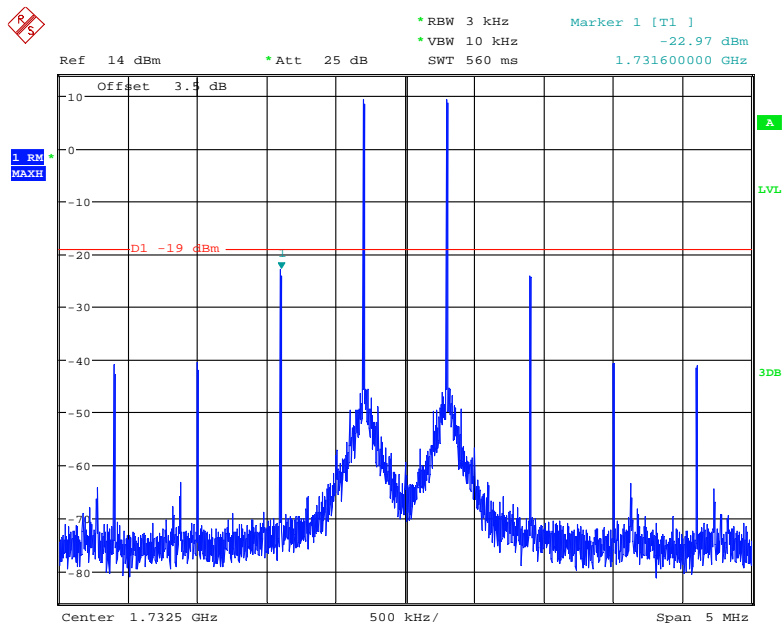

Date: 3.AUG.2019 13:47:47



### AWS Above AGC

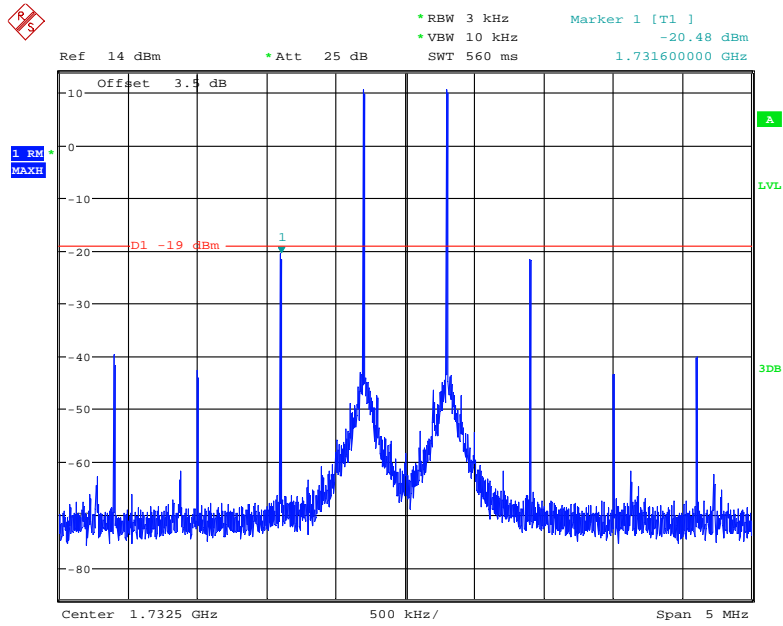

Date: 3.AUG.2019 13:48:18

### Lower 700MHz Pre-AGC

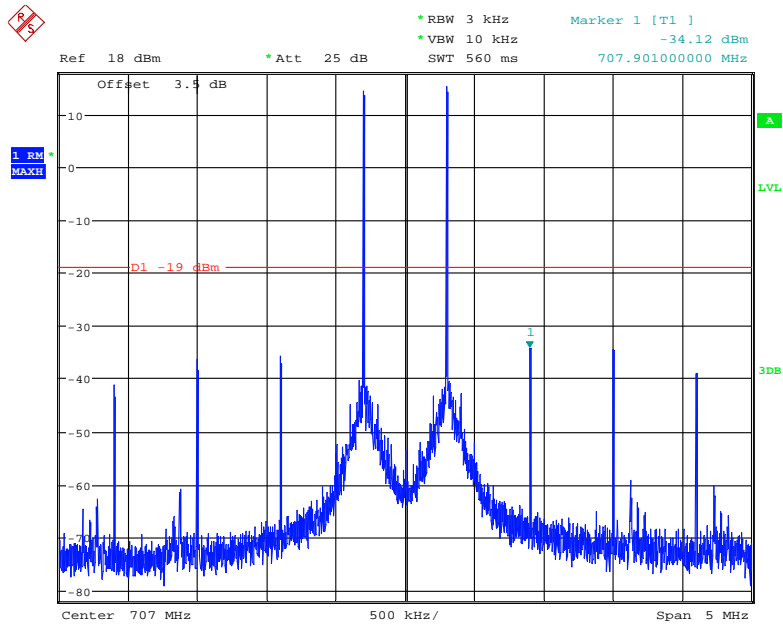

Date: 3.AUG.2019 13:50:22

### Lower 700MHz Above AGC

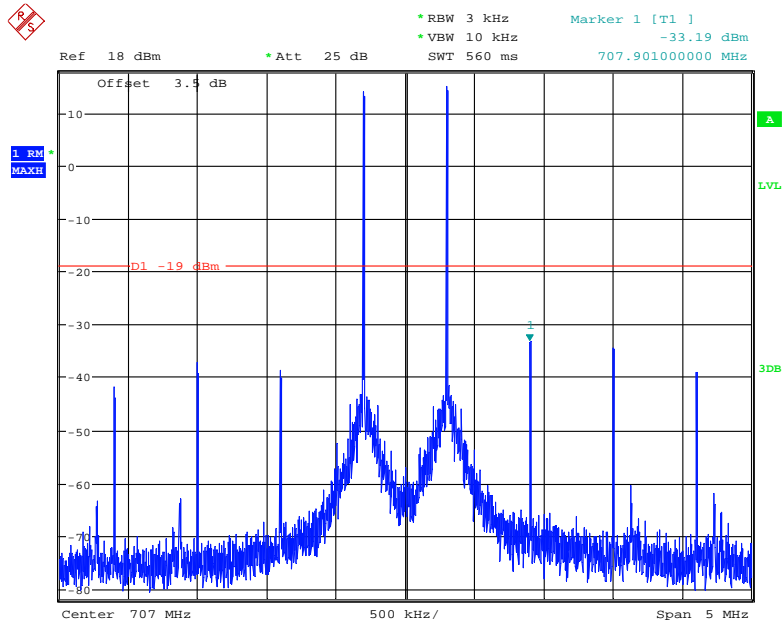

Date: 3.AUG.2019 13:51:07

### Upper 700MHz Pre-AGC

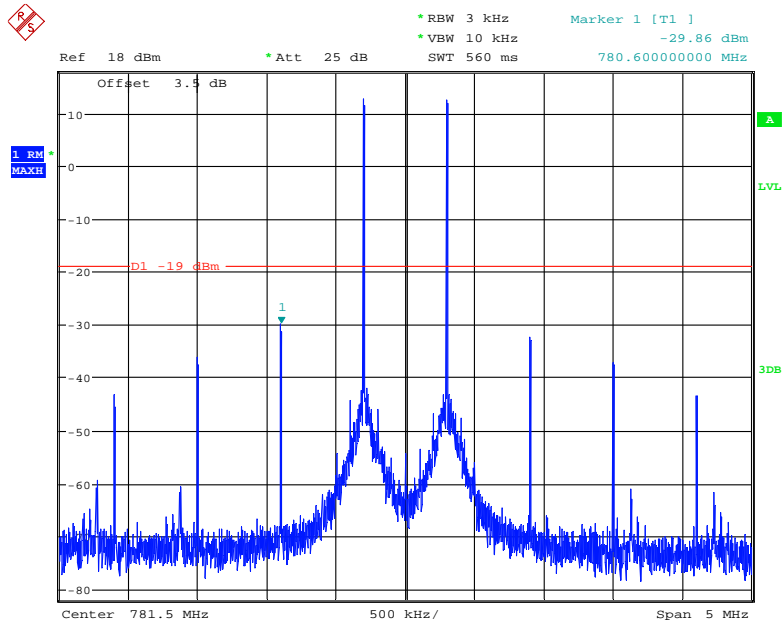

Date: 3.AUG.2019 13:52:40

### Upper 700MHz Above AGC

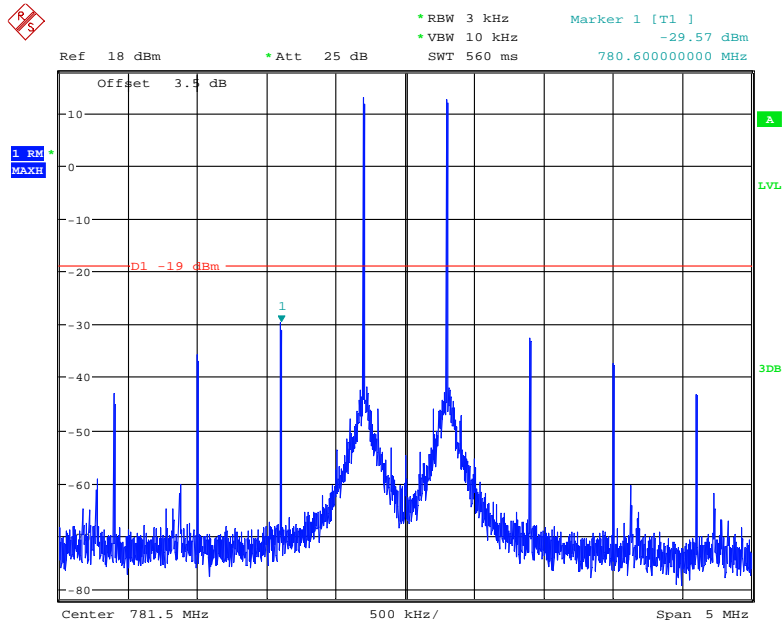

Date: 3.AUG.2019 13:53:33

## § 20.21(e)(8)(i)(E)- OUT OF BAND EMISSIONS

### Applicable Standards

According to § 20.21(e)(8)(i)(E) Out of Band Emission Limits.

### Test Procedure

This measurement is intended to demonstrate compliance to the limit specified in § 20.21(e)(8)(i)(E). The mobile emission limit applicable to the supported band of operation can be determined from the applicable rule part as listed in Annex A for each authorized operating band.

- a) Connect the EUT to the test equipment as shown in **Figure 1**. Begin with the uplink output connected to the spectrum analyzer.
- b) Configure the signal generator for the appropriate operation for all uplink and downlink bands:
  - i) GSM: 0.2 MHz from upper and lower band edges.
  - ii) LTE (5 MHz): 2.5 MHz from upper and lower band edges.
  - iii) CDMA: 1.25 MHz from upper and lower band edges, except for cellular band as follows (only the upper and lower frequencies need to be tested):

824.88 MHz, 845.73 MHz, 836.52 MHz, 848.10 MHz, 869.88 MHz, 890.73 MHz, 881.52 MHz, 893.10 MHz.

**Note 1:** *Alternative test modulation types:*

- CDMA (alternative 1.25 MHz AWGN)
- LTE 5 MHz (alternative W-CDMA or 4.1 MHz AWGN)

**Note 2:** *For LTE, the signal generator should utilize the uplink and downlink signal types for these modulations in uplink and downlink tests, respectively. LTE shall use 5 MHz signal, 25 resource blocks transmitting.*

**Note 3:** *When using an AWGN test signal, the bandwidth shall be the measured 99% occupied bandwidth.*

- c) Set the signal generator amplitude to the maximum power level prior to AGC similar to the procedures in 7.2.2e) to 7.2.2f) of power measurement procedure for appropriate modulations.
- d) Set RBW = measurement bandwidth specified in the applicable rule section for the supported frequency band (*see Annex A for cross-reference to applicable rule section*).
- e) Set VBW =  $3 \times$  RBW.
- f) Select the RMS (power averaging) detector.
- g) Sweep time = auto-couple.
- h) Set the analyzer start frequency to the upper band/block edge frequency and the stop frequency to the upper band/block edge frequency plus 300 kHz (when operational frequency is  $< 1$  GHz) or 3 MHz (when operational frequency is  $\geq 1$  GHz).
- i) Trace average at least 100 traces in power averaging (i.e., RMS) mode.
- j) Use peak marker function to find the maximum power level.
- k) Capture the spectrum analyzer trace of the power level for inclusion in the test report.
- l) Increase the signal generator amplitude in 2 dB steps until the maximum input level indicated in 5.5 is reached. Affirm that the EUT maintains compliance with the OOB limits.
- m) Reset the analyzer start frequency to the lower band/block edge frequency minus 300 kHz (when operational frequency is  $< 1$  GHz) or 3 MHz (when operational frequency is  $\geq 1$  GHz), and the stop frequency to the lower band/block edge frequency and repeat 7.5j) to 7.5l).
- n) Repeat 7.5b) through 7.5m) for each uplink and downlink operational band.

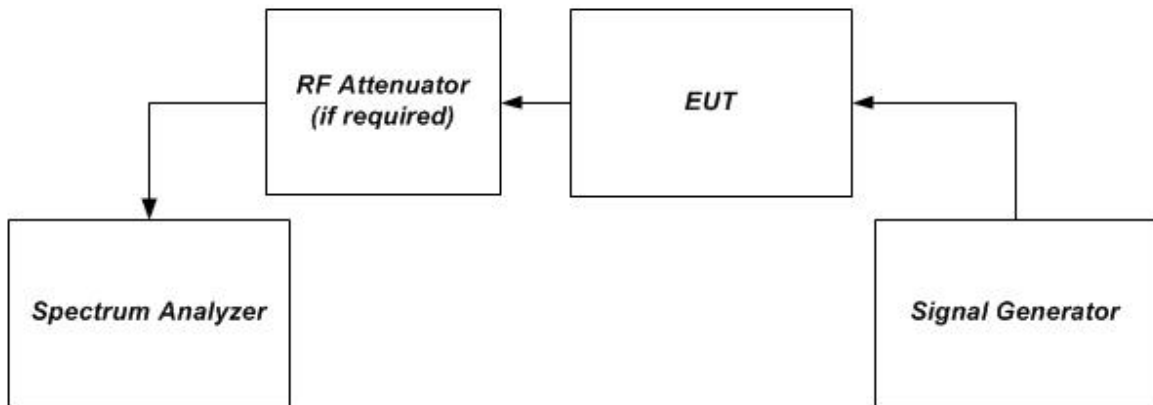

**Figure 1 – Band verification test instrumentation setup**

**Test Data**

**Environmental Conditions**

<b>Temperature:</b>	25 °C
<b>Relative Humidity:</b>	52 %
<b>ATM Pressure:</b>	101.2 kPa

*The testing was performed by Kieron Luo from 2019-07-30 to 2019-08-08.*

**Test Result:** Compliance. Please refer to following plots.

Downlink

Lower 700MHz CDMA Left Side Pre-AGC

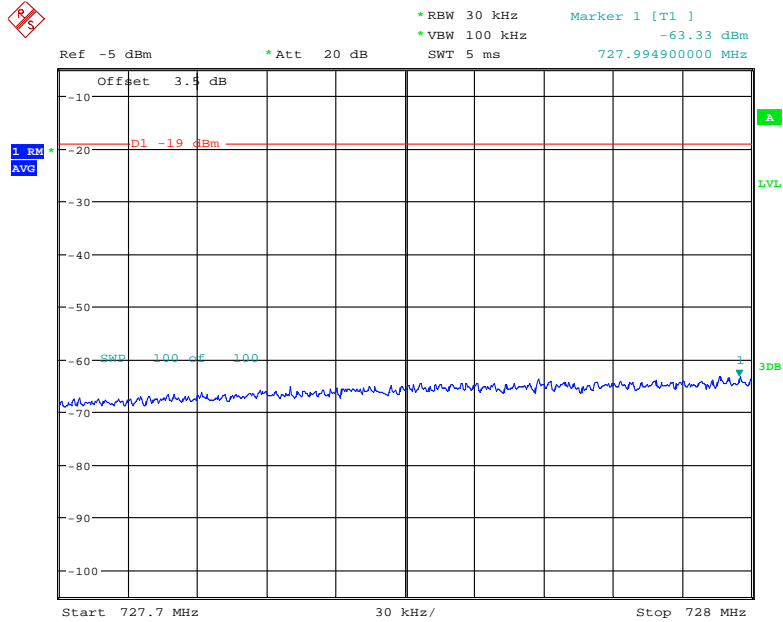

Date: 8.AUG.2019 14:25:30

Lower 700MHz CDMA Left Side Above AGC

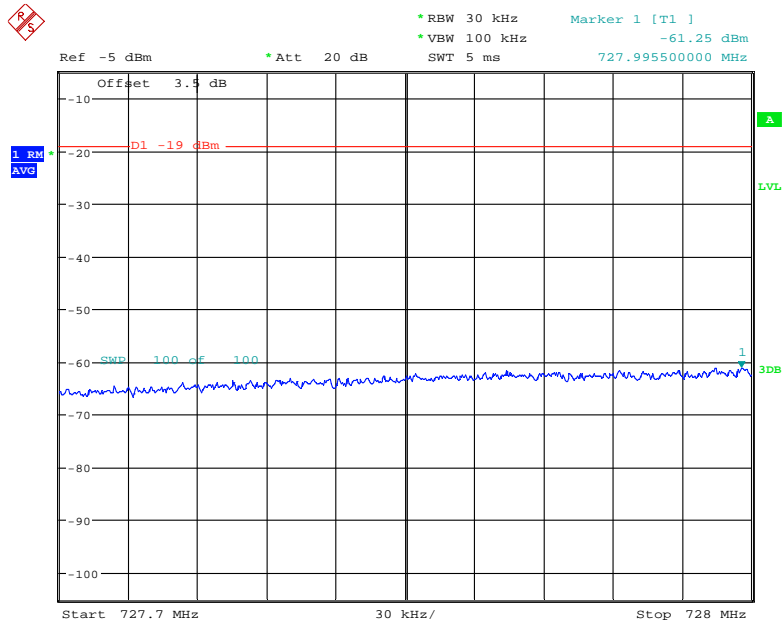

Date: 8.AUG.2019 14:26:05

### Lower 700MHz GSM Left Side Pre-AGC

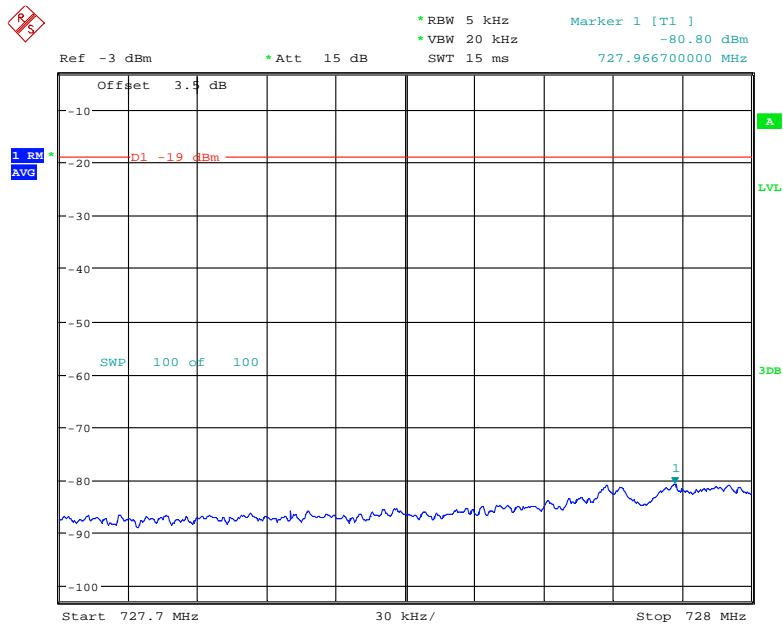

Date: 8.AUG.2019 13:30:02

### Lower 700MHz GSM Left Side Above AGC

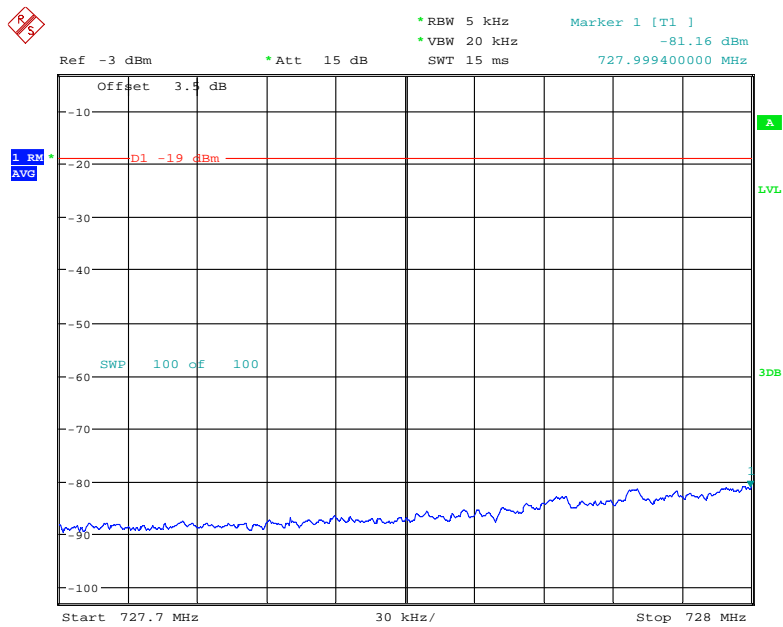

Date: 8.AUG.2019 13:30:29

### Lower 700MHz LTE Left Side Pre-AGC

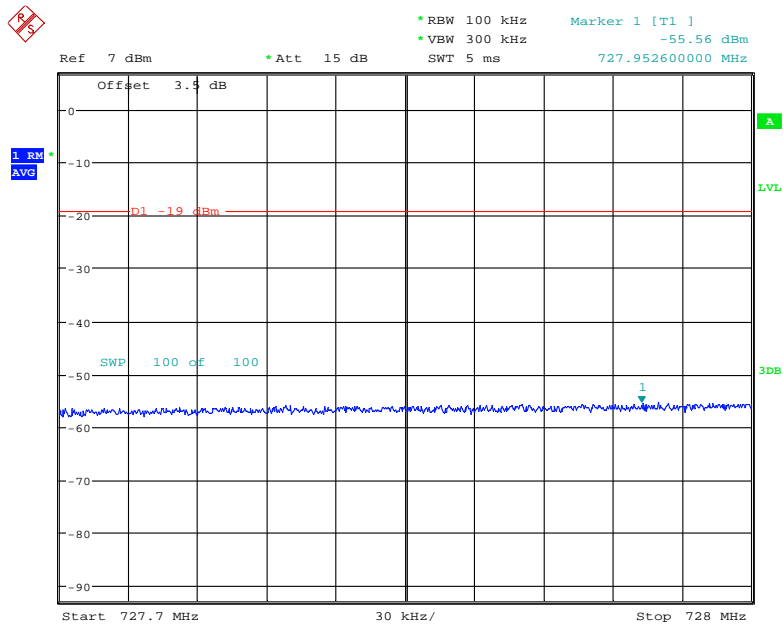

Date: 8.AUG.2019 12:56:52

### Lower 700MHz LTE Left Side Above AGC

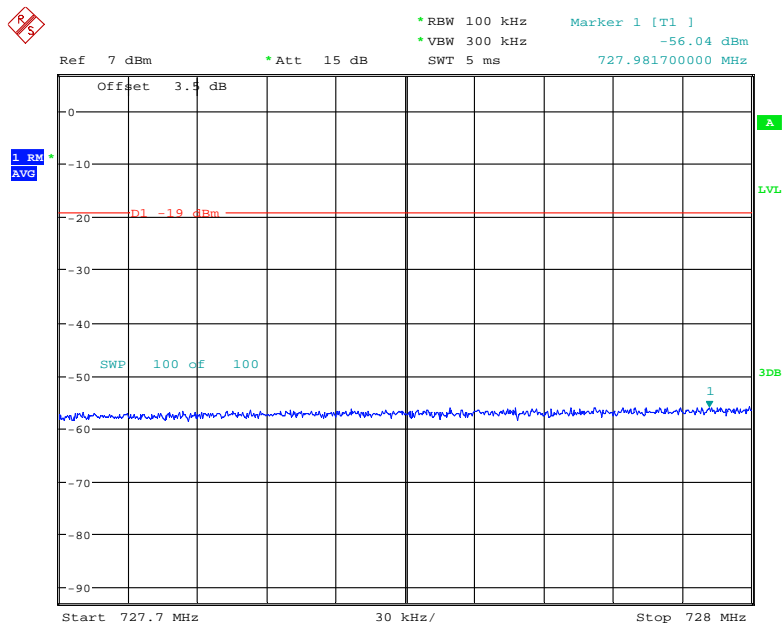

Date: 8.AUG.2019 12:57:13



### Lower 700MHz CDMA Right Side Pre-AGC

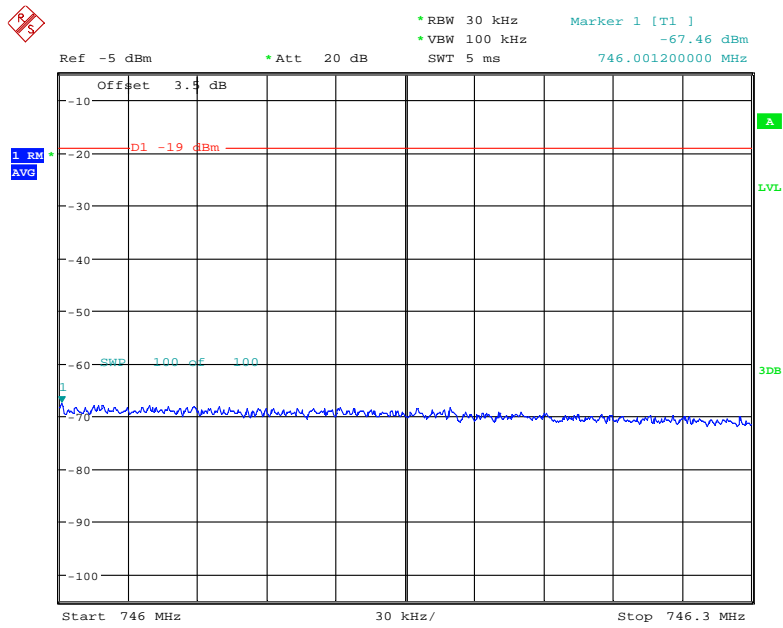

Date: 8.AUG.2019 14:26:32

### Lower 700MHz CDMA Right Side Above AGC

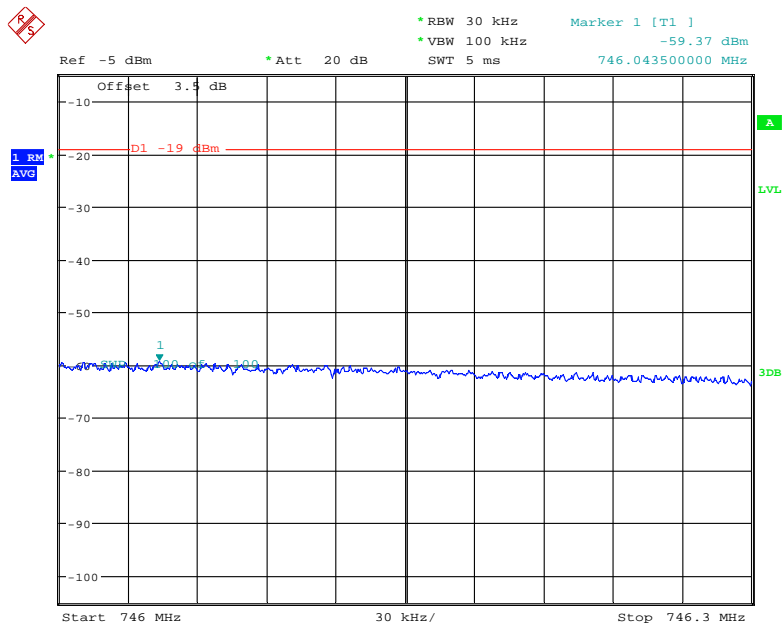

Date: 8.AUG.2019 14:26:53

### Lower 700MHz GSM Right Side Pre-AGC

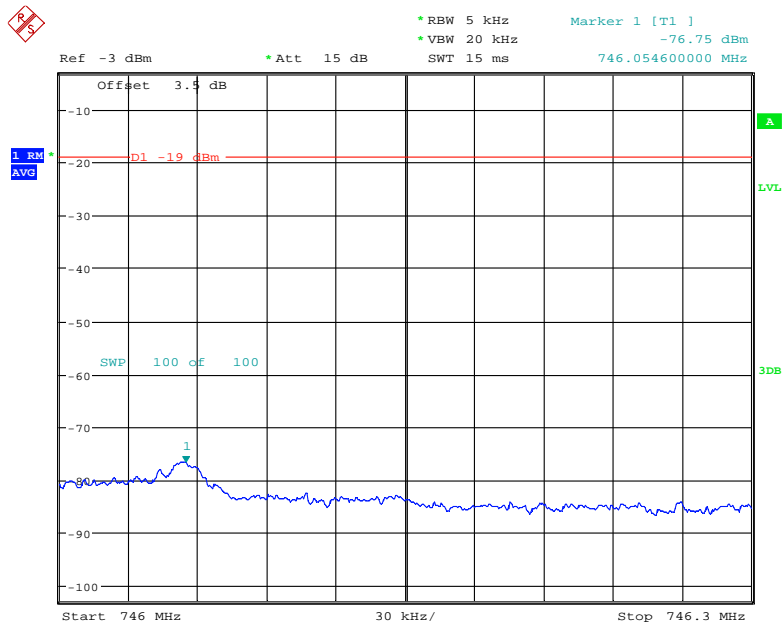

Date: 8.AUG.2019 13:30:58

### Lower 700MHz GSM Right Side Above AGC

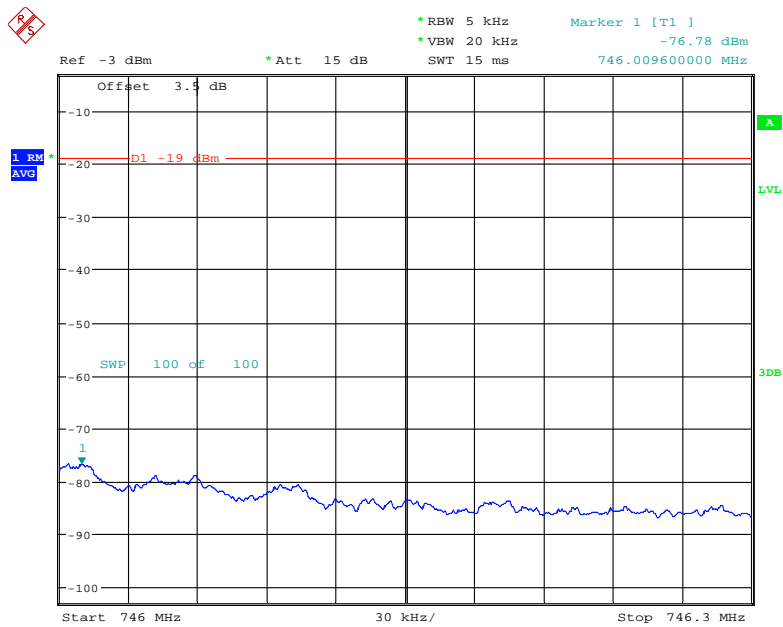

Date: 8.AUG.2019 13:31:16

### Lower 700MHz LTE Right Side Pre-AGC

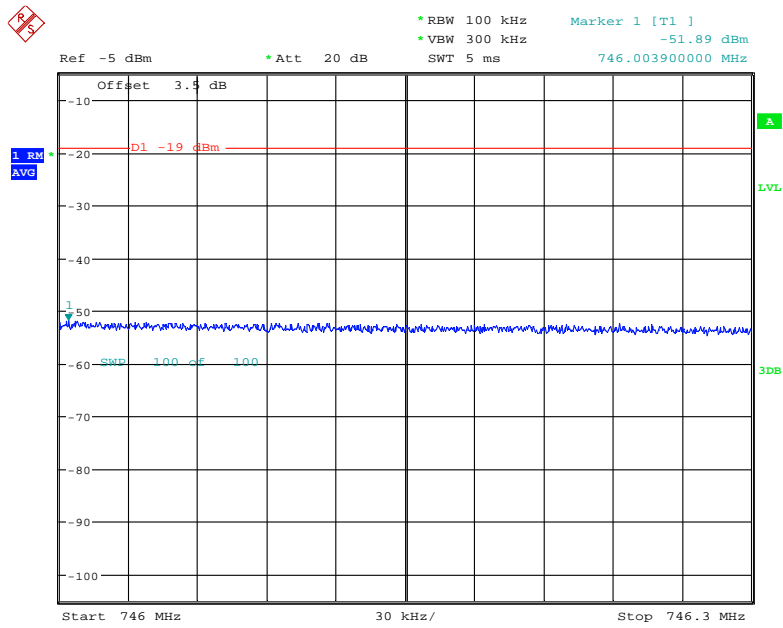

Date: 8.AUG.2019 14:35:57

### Lower 700MHz LTE Right Side Above AGC

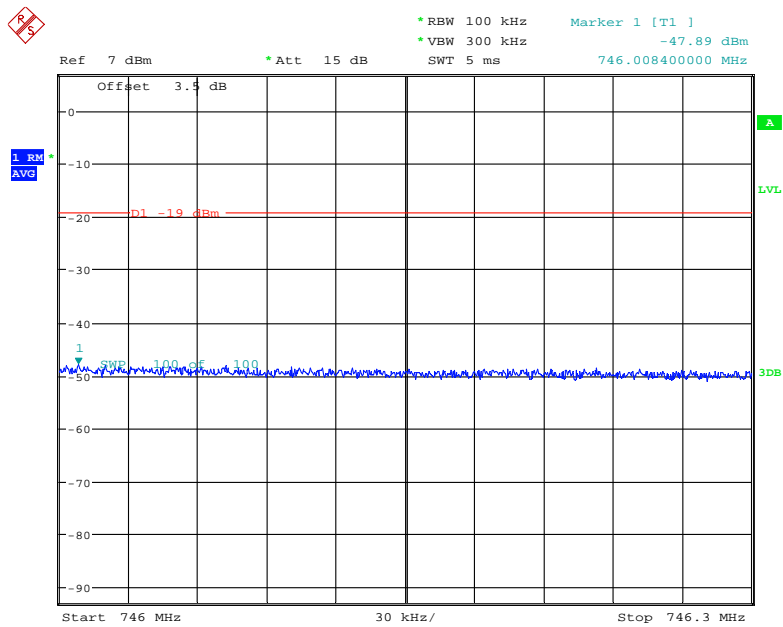

Date: 8.AUG.2019 12:58:07

### Upper 700MHz CDMA Left Side Pre-AGC

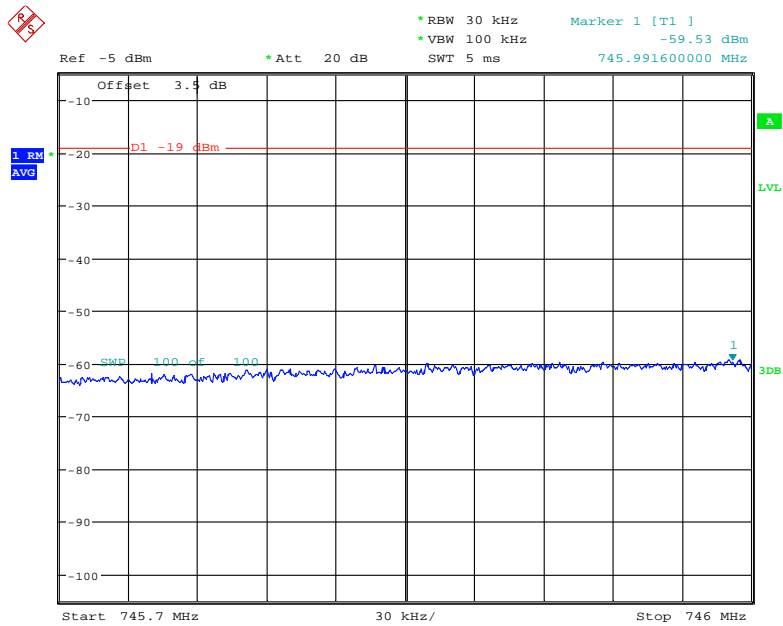

Date: 8.AUG.2019 14:27:26

### Upper 700MHz CDMA Left Side Above AGC

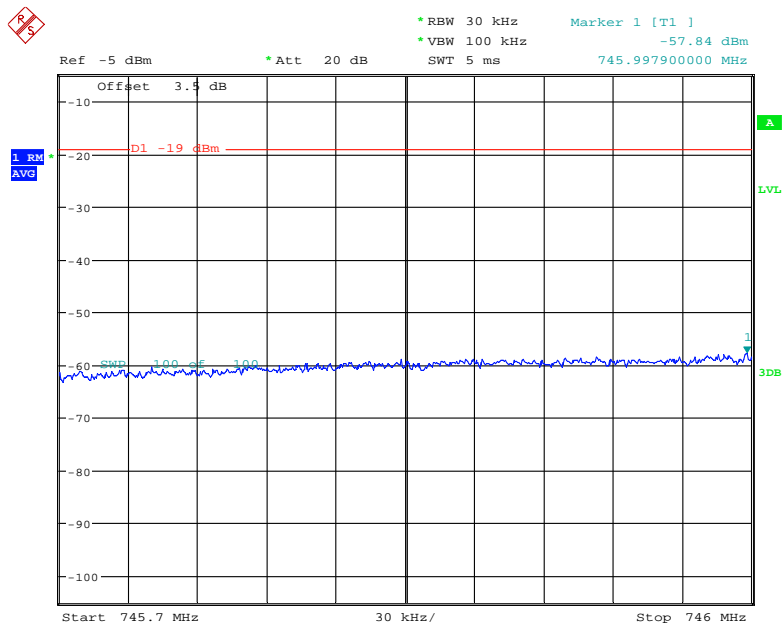

Date: 8.AUG.2019 14:27:53

### Upper 700MHz GSM Left Side Pre-AGC

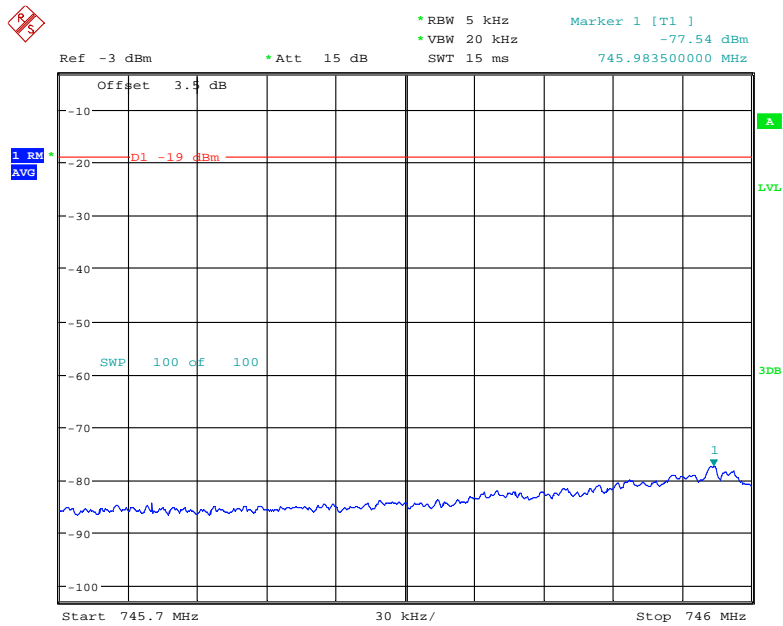

Date: 8.AUG.2019 13:32:03

### Upper 700MHz GSM Left Side Above AGC

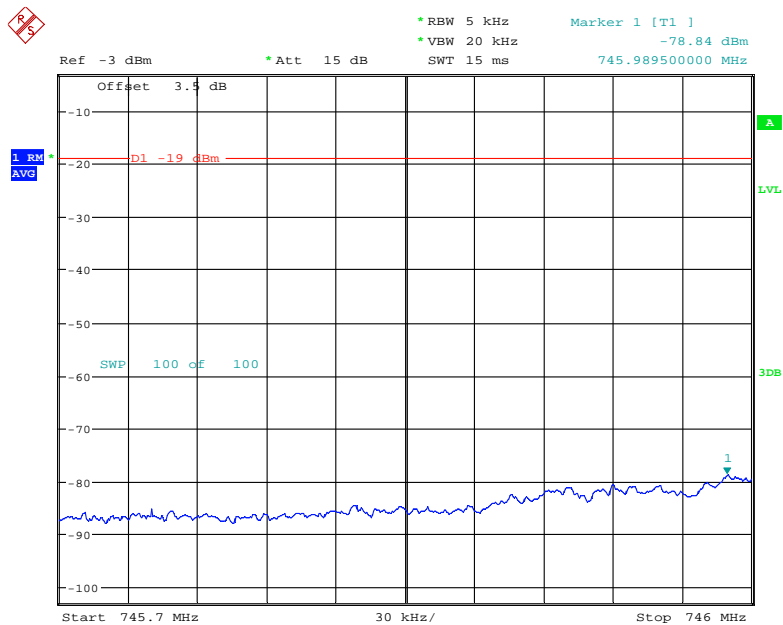

Date: 8.AUG.2019 13:32:35

### Upper 700MHz LTE Left Side Pre-AGC

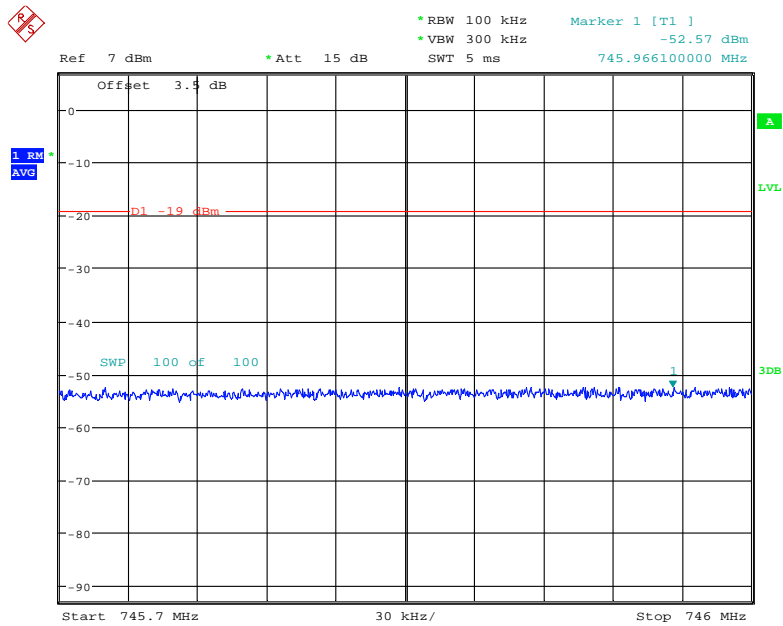

Date: 8.AUG.2019 12:59:07

### Upper 700MHz LTE Left Side Above AGC

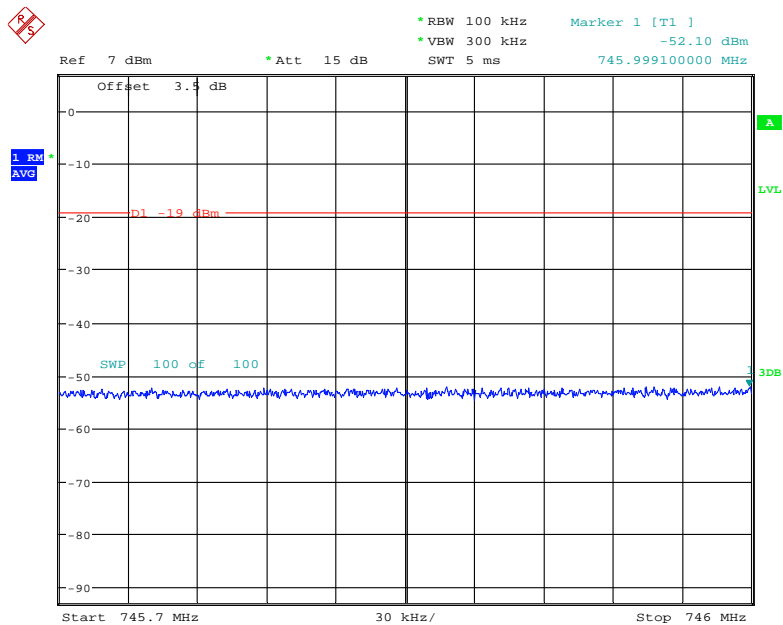

Date: 8.AUG.2019 12:59:46

### Upper 700MHz CDMA Right Side Pre-AGC

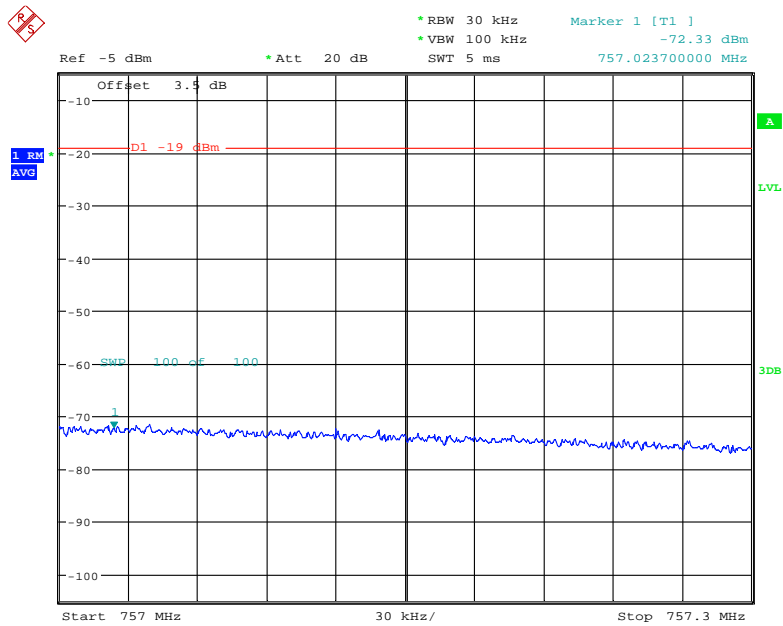

Date: 8.AUG.2019 14:28:49

### Upper 700MHz CDMA Right Side Above AGC

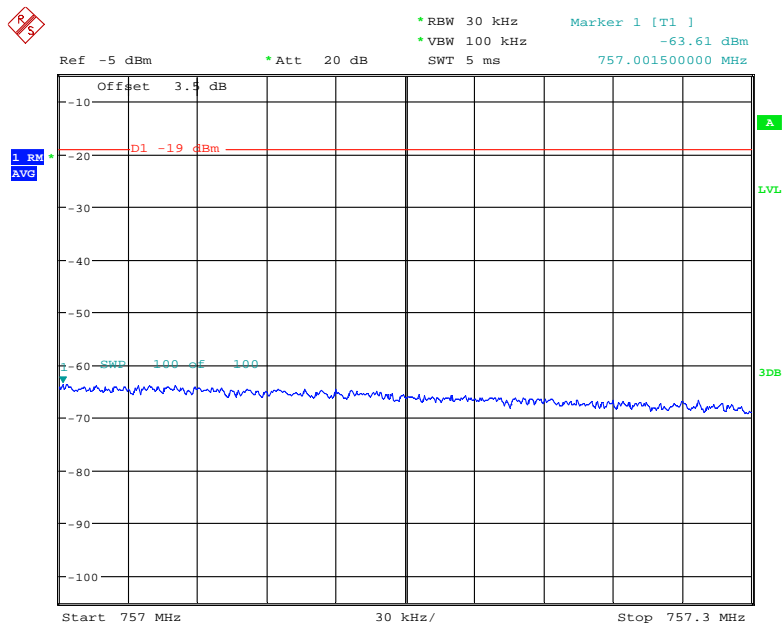

Date: 8.AUG.2019 14:29:28

### Upper 700MHz GSM Right Side Pre-AGC

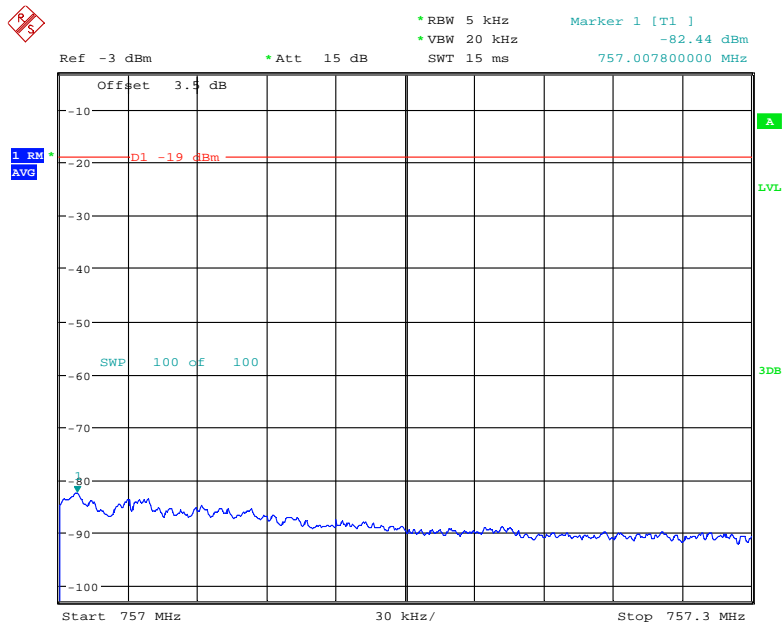

Date: 8.AUG.2019 13:33:17

### Upper 700MHz GSM Right Side Above AGC

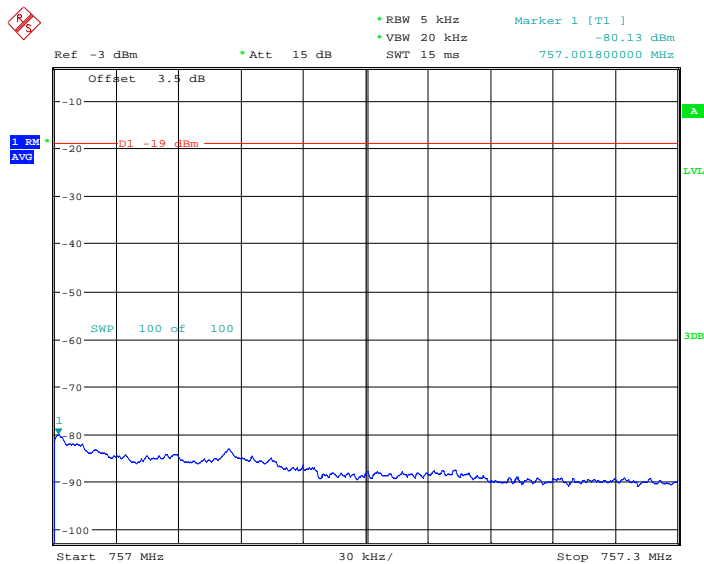

Date: 8.AUG.2019 13:34:02



### Upper 700MHz LTE Right Side Pre-AGC

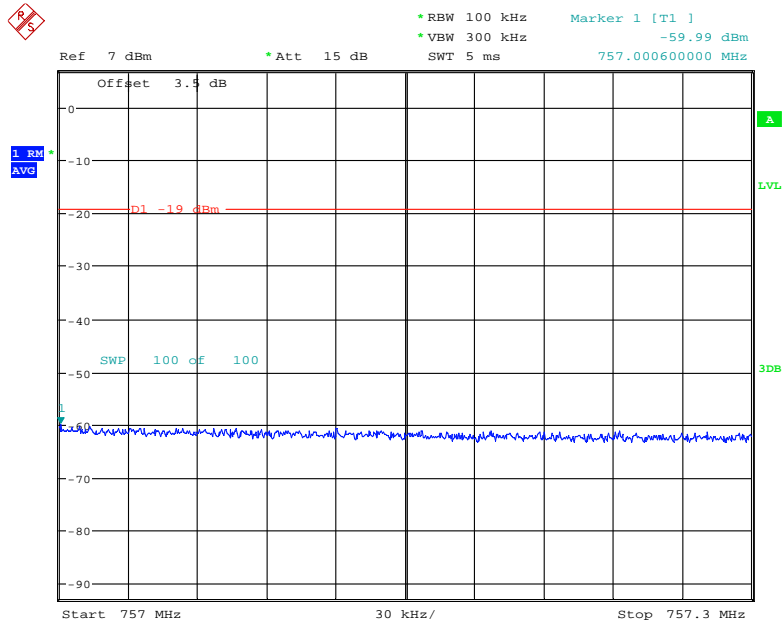

Date: 8.AUG.2019 13:03:51

### Upper 700MHz LTE Right Side Above AGC

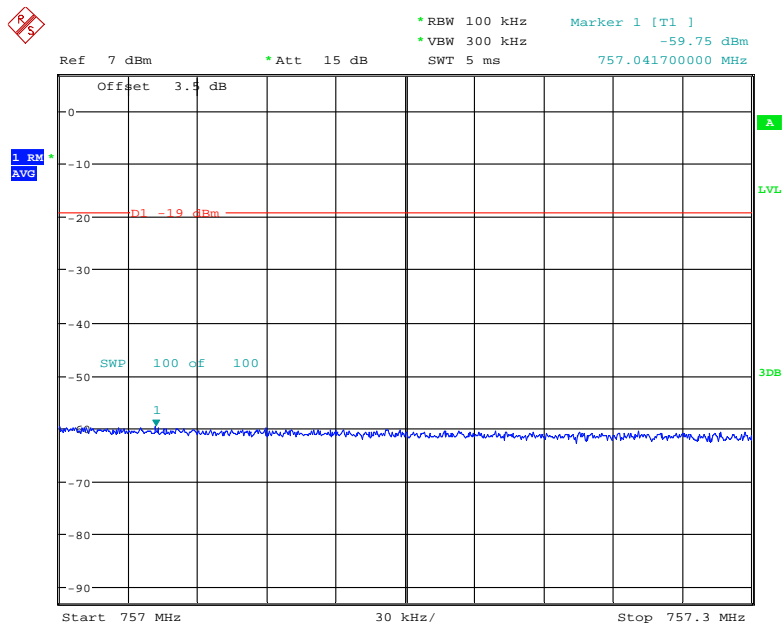

Date: 8.AUG.2019 13:04:14

### Cellular Band CDMA Left Side Pre-AGC

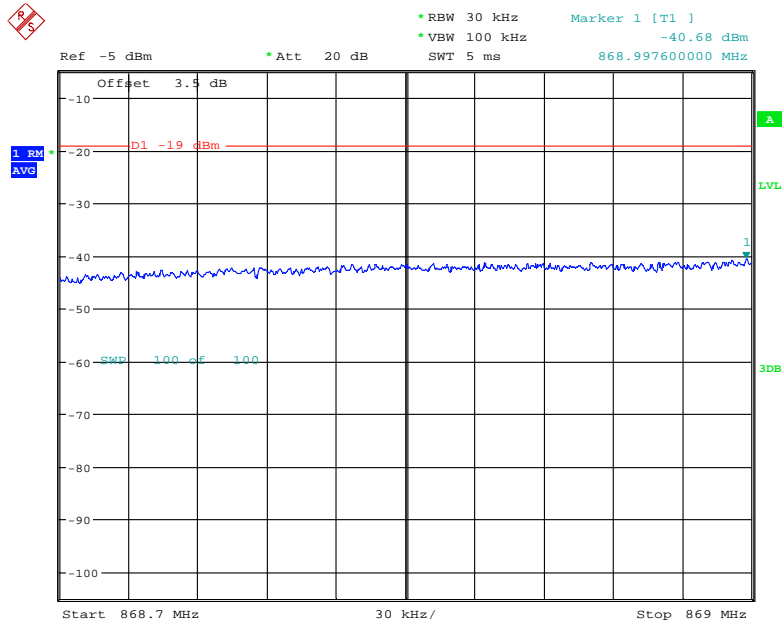

Date: 8.AUG.2019 14:30:20

### Cellular Band CDMA Left Side Above AGC

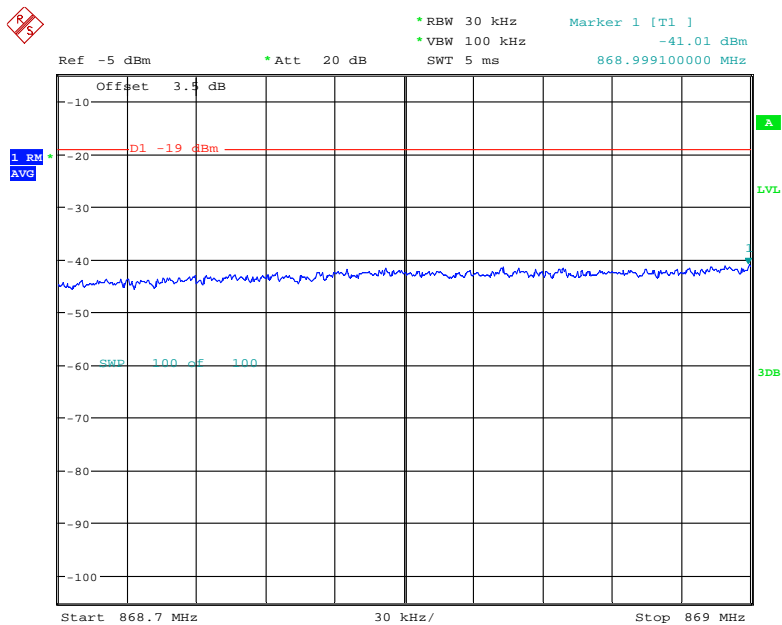

Date: 8.AUG.2019 14:30:37

### Cellular Band GSM Left Side Pre-AGC

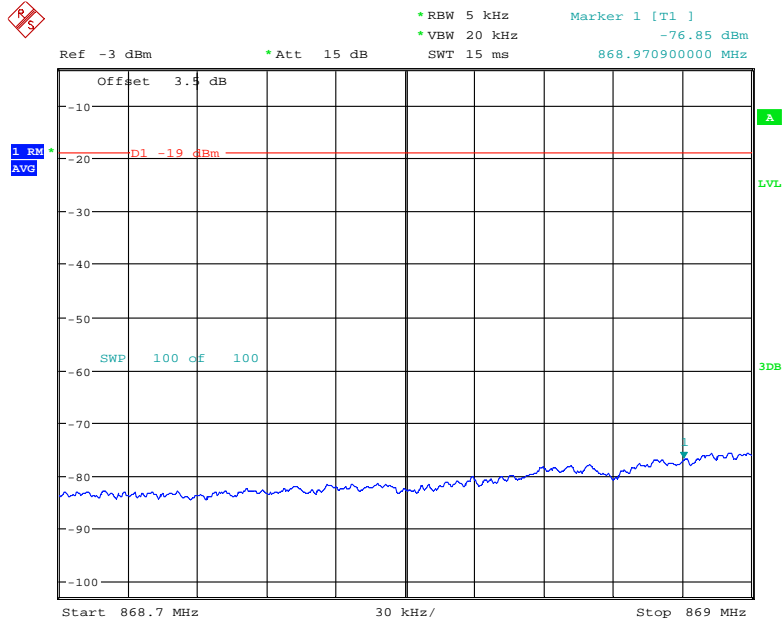

Date: 8.AUG.2019 13:23:13

### Cellular Band GSM Left Side Above AGC

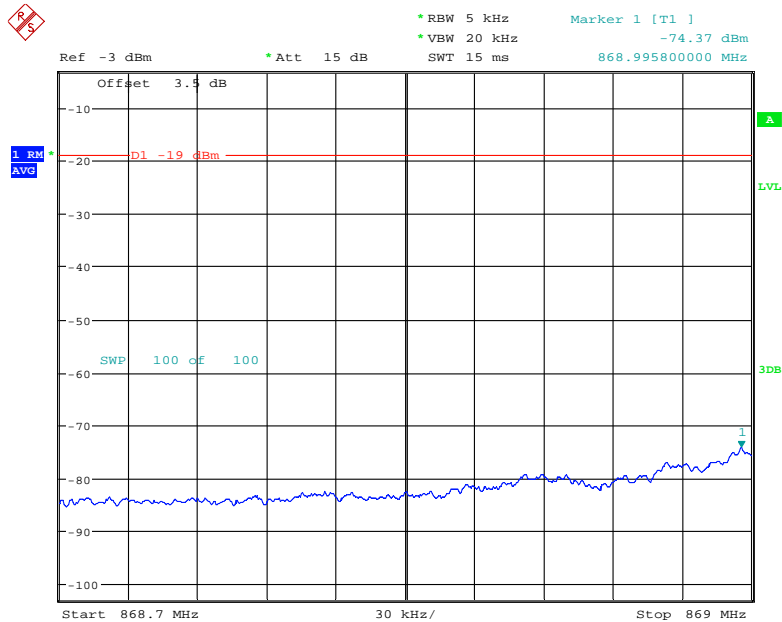

Date: 8.AUG.2019 13:23:54

### Cellular Band LTE Left Side Pre-AGC

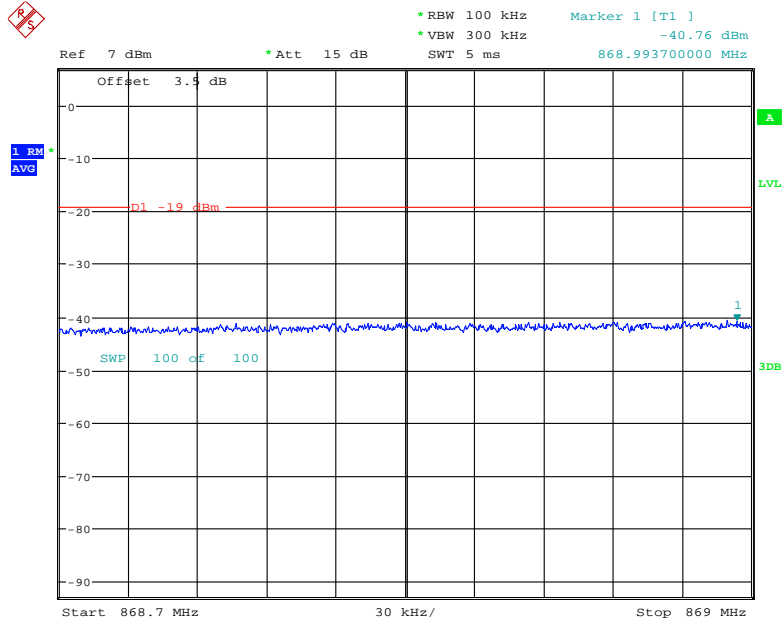

Date: 8.AUG.2019 13:00:33

### Cellular Band LTE Left Side Above AGC

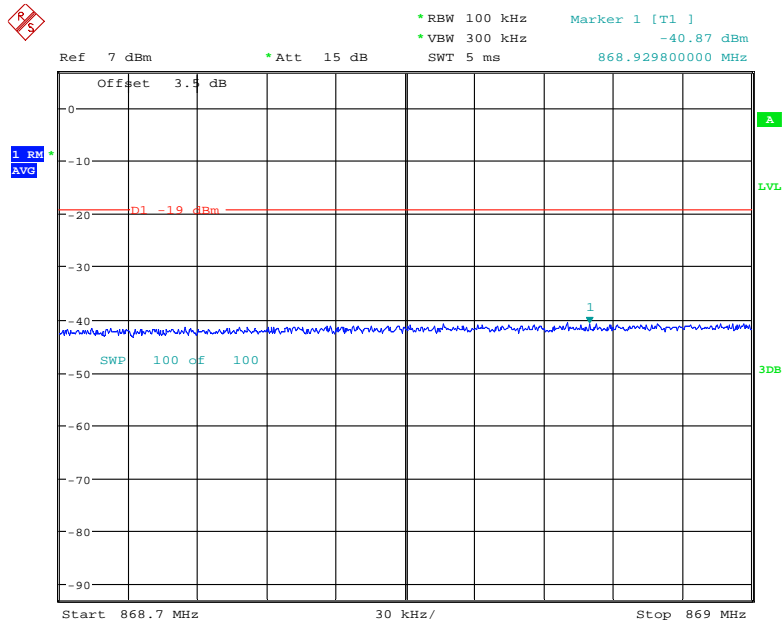

Date: 8.AUG.2019 13:00:49

### Cellular Band CDMA Right Side Pre-AGC

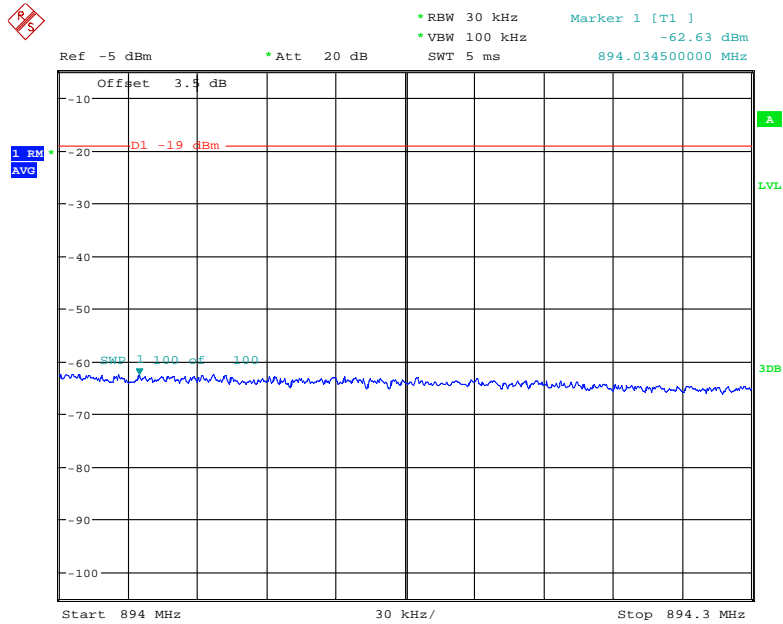

Date: 8.AUG.2019 14:31:12

### Cellular Band CDMA Right Side Above AGC

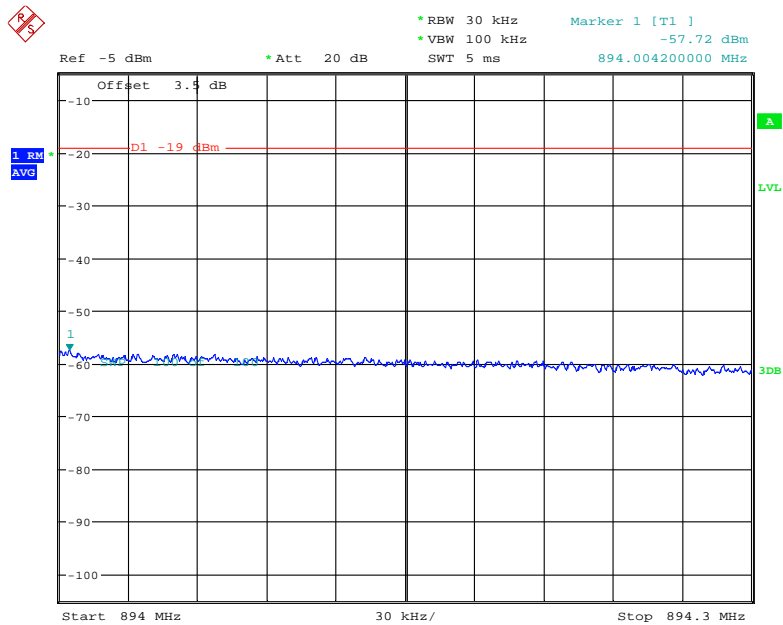

Date: 8.AUG.2019 14:31:33

### Cellular Band GSM Right Side Pre-AGC

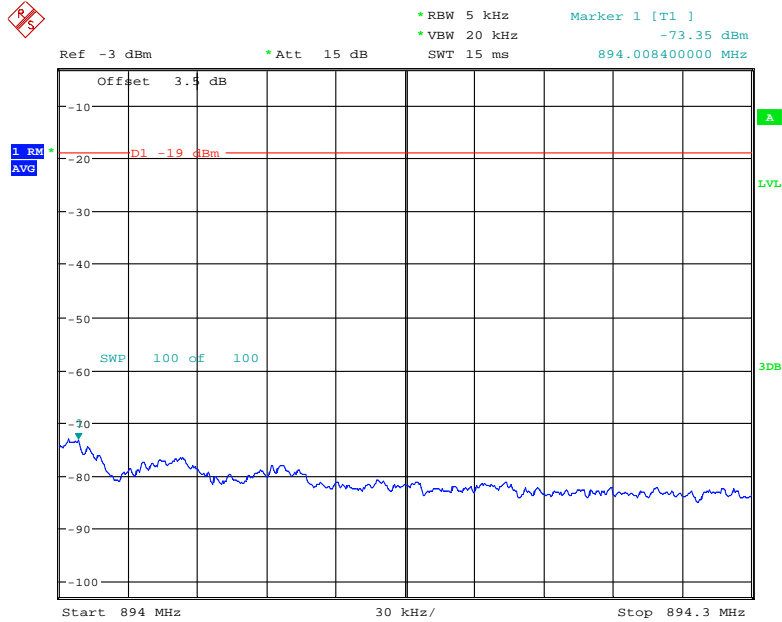

Date: 8.AUG.2019 13:24:23

### Cellular Band GSM Right Side Above AGC

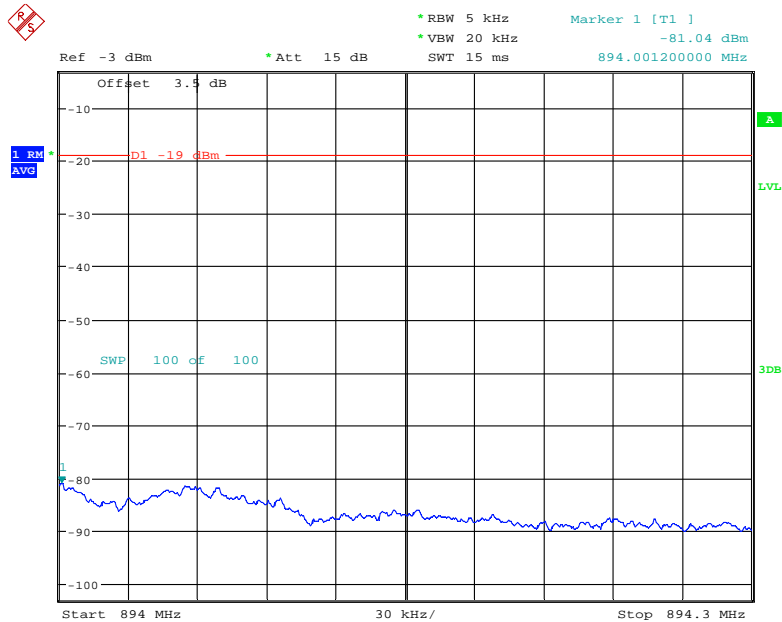

Date: 8.AUG.2019 13:24:44

### Cellular Band LTE Right Side Pre-AGC

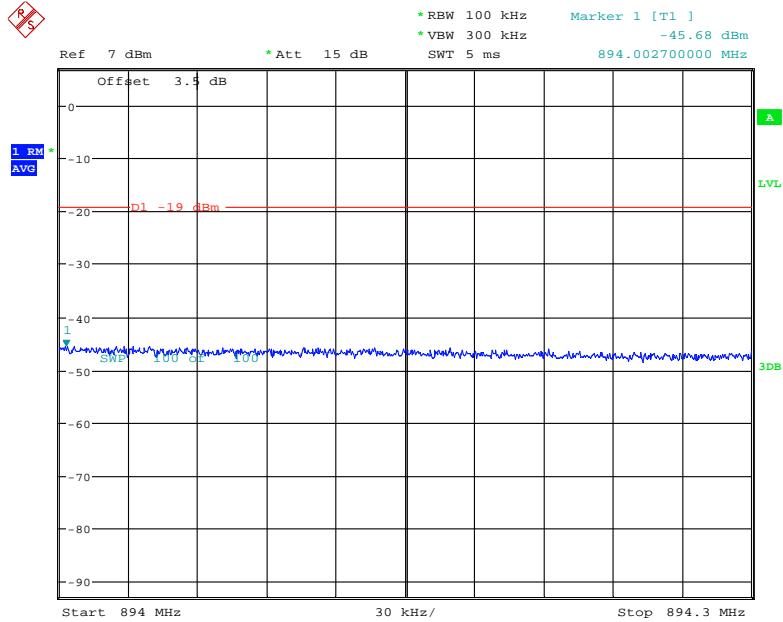

Date: 8.AUG.2019 13:01:21

### Cellular Band LTE Right Side Above AGC

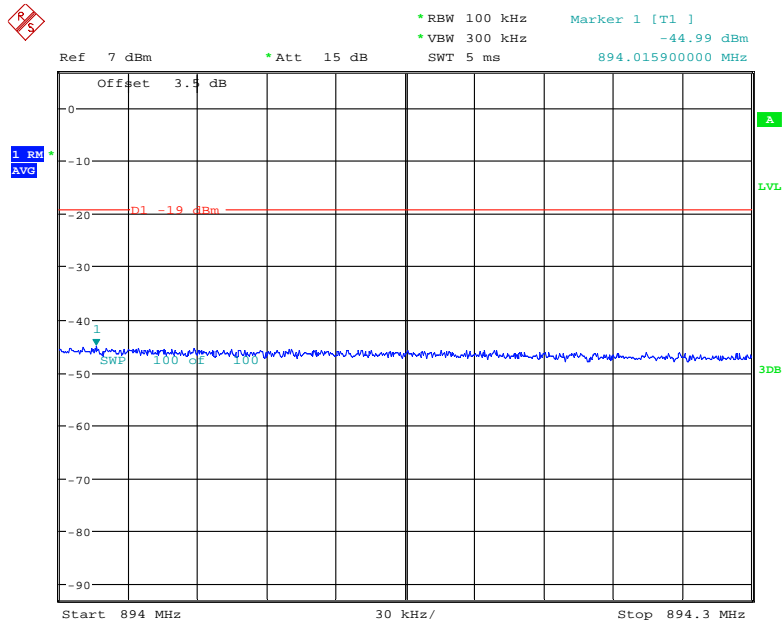

Date: 8.AUG.2019 13:01:42

### PCS Band CDMA Left Side Pre-AGC

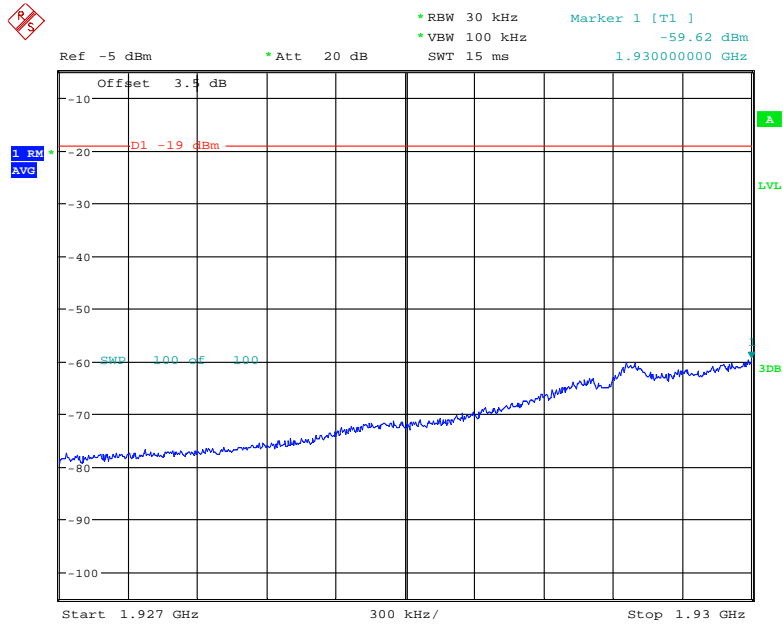

Date: 8.AUG.2019 14:21:50

### PCS Band CDMA Left Side Above AGC

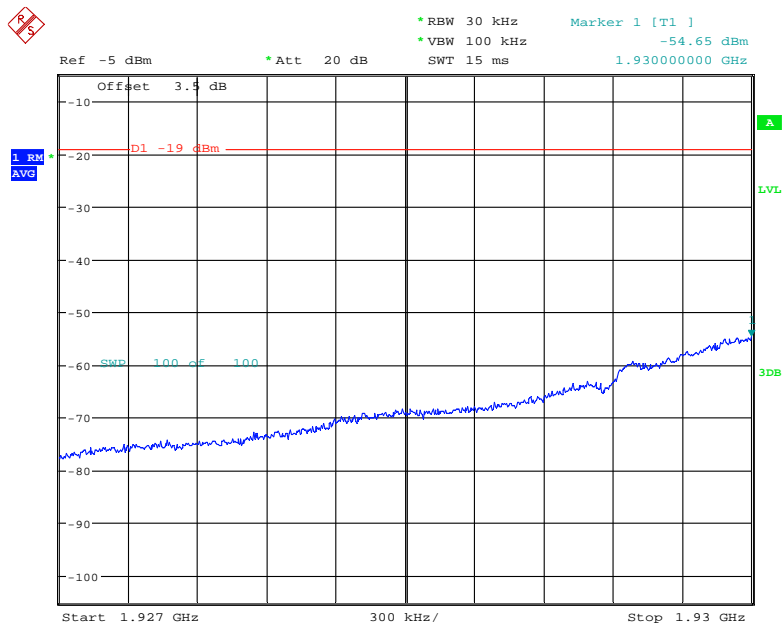

Date: 8.AUG.2019 14:21:24



### PCS Band GSM Left Side Pre-AGC

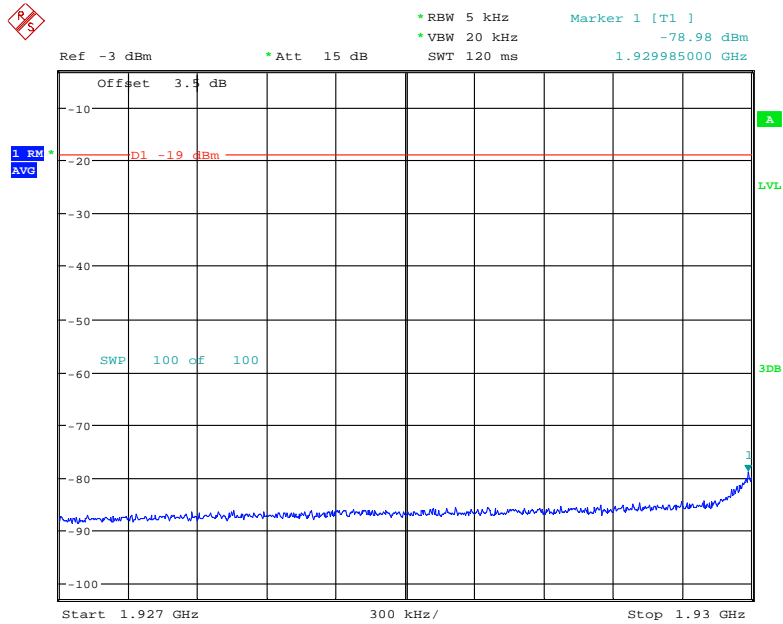

Date: 8.AUG.2019 13:19:19

### PCS Band GSM Left Side Above AGC

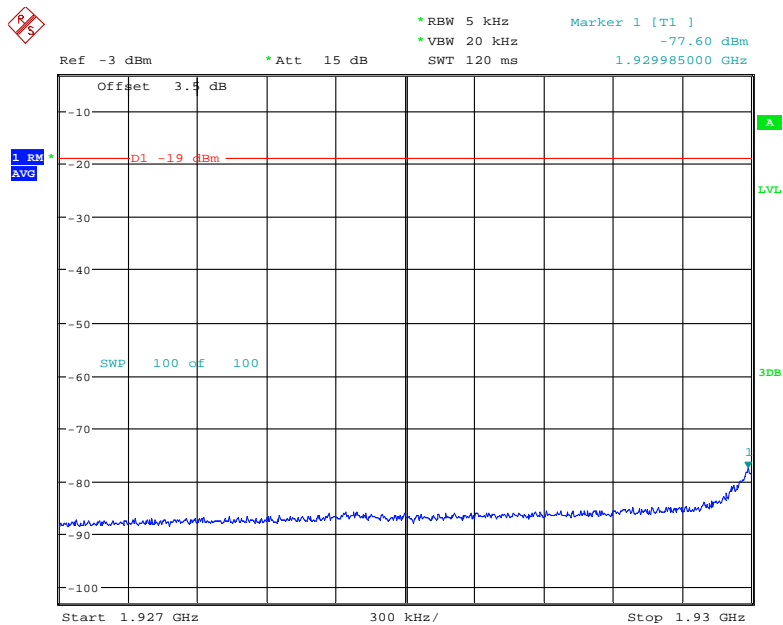

Date: 8.AUG.2019 13:19:41

### PCS Band LTE Left Side Pre-AGC

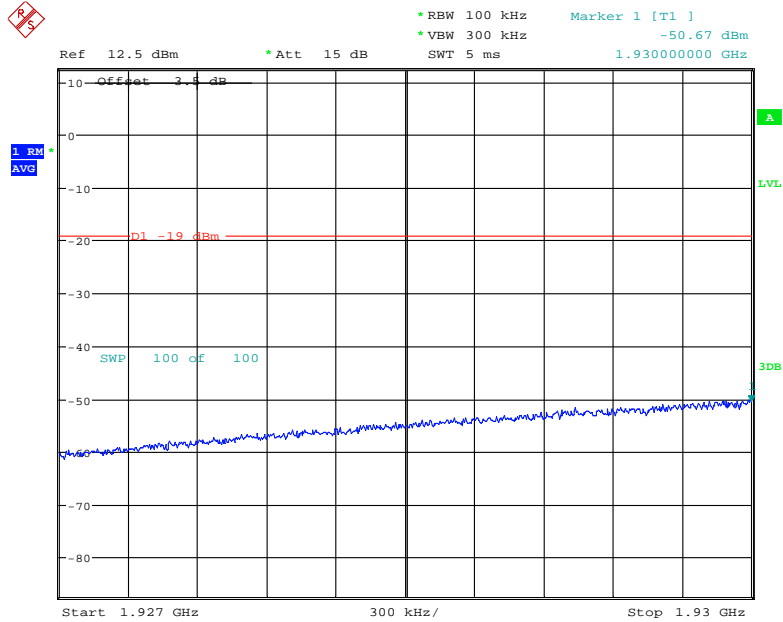

Date: 8.AUG.2019 12:48:14

### PCS Band LTE Left Side Above AGC

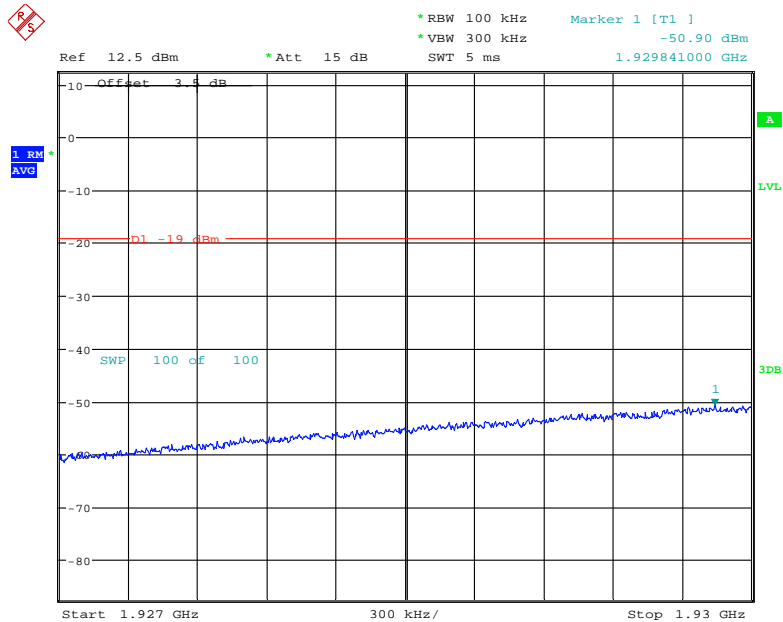

Date: 8.AUG.2019 12:49:37

### PCS Band CDMA Right Side Pre-AGC

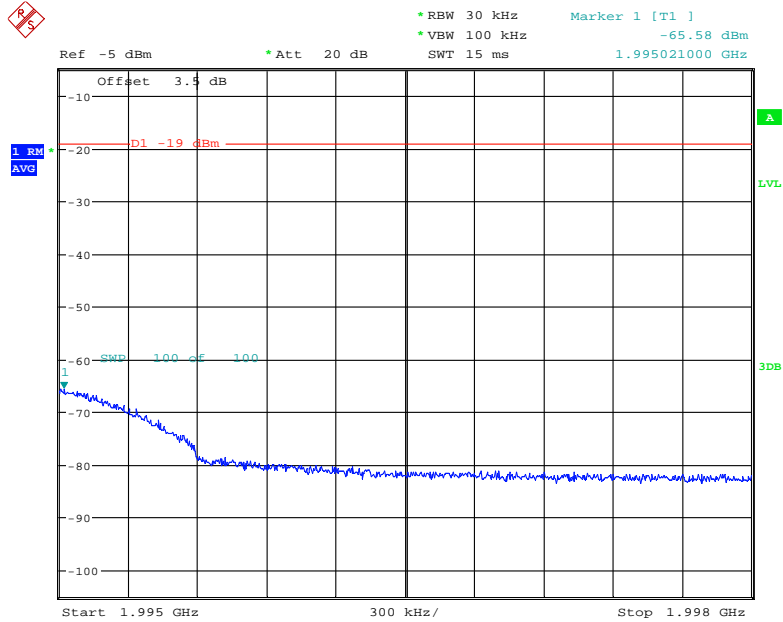

Date: 8.AUG.2019 14:22:42

### PCS Band CDMA Right Side Above AGC

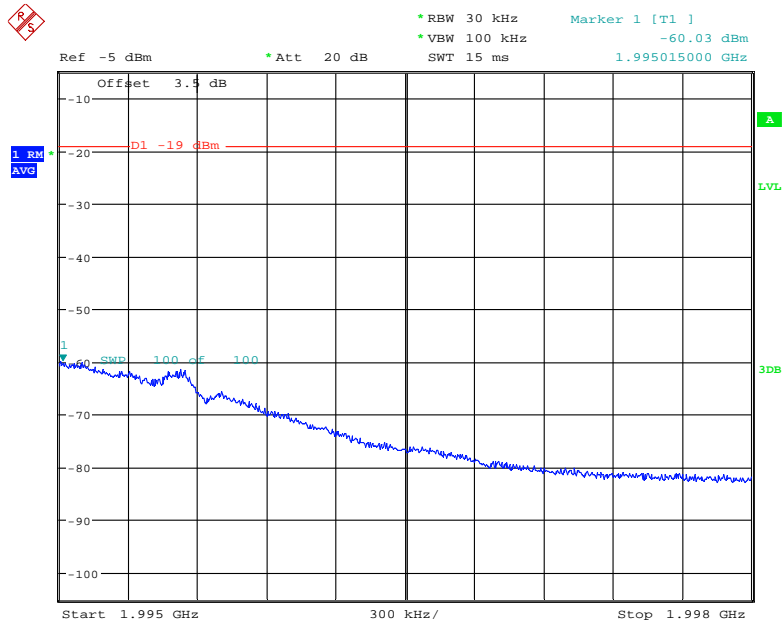

Date: 8.AUG.2019 14:23:01

### PCS Band GSM Right Side Pre-AGC

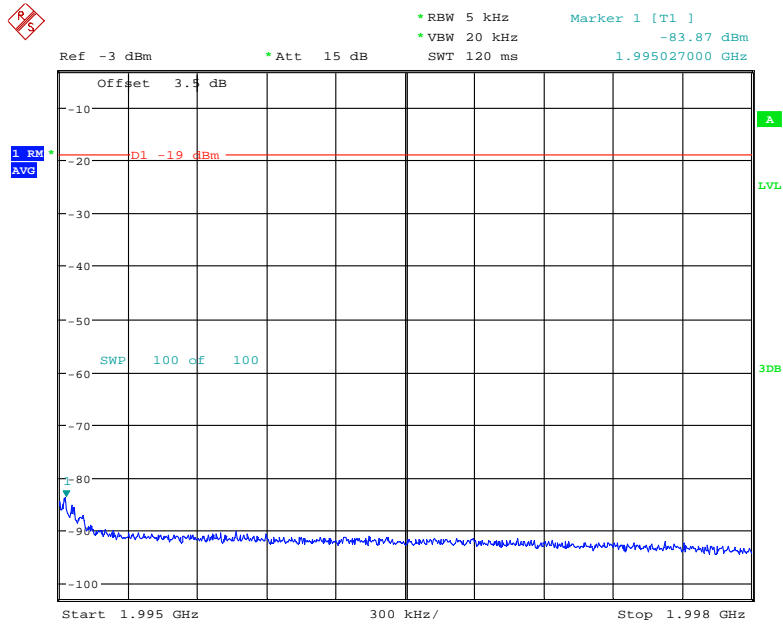

Date: 8.AUG.2019 13:21:06

### PCS Band GSM Right Side Above AGC

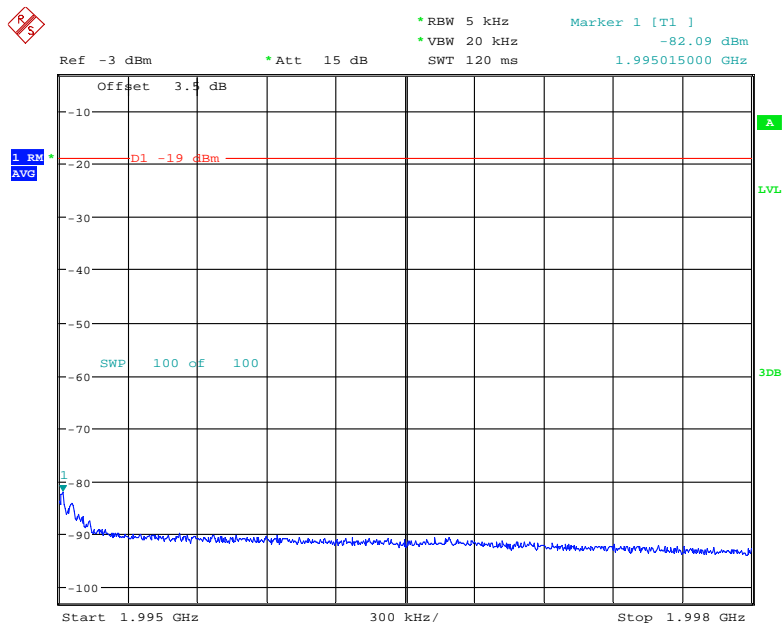

Date: 8.AUG.2019 13:21:18

### PCS Band LTE Right Side Pre-AGC

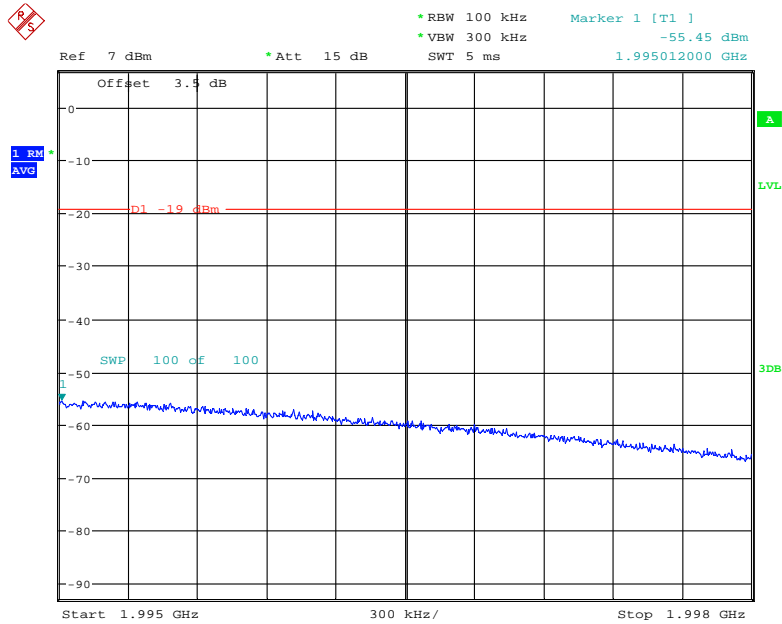

Date: 8.AUG.2019 12:50:56

### PCS Band LTE Right Side 2107MHz Above AGC

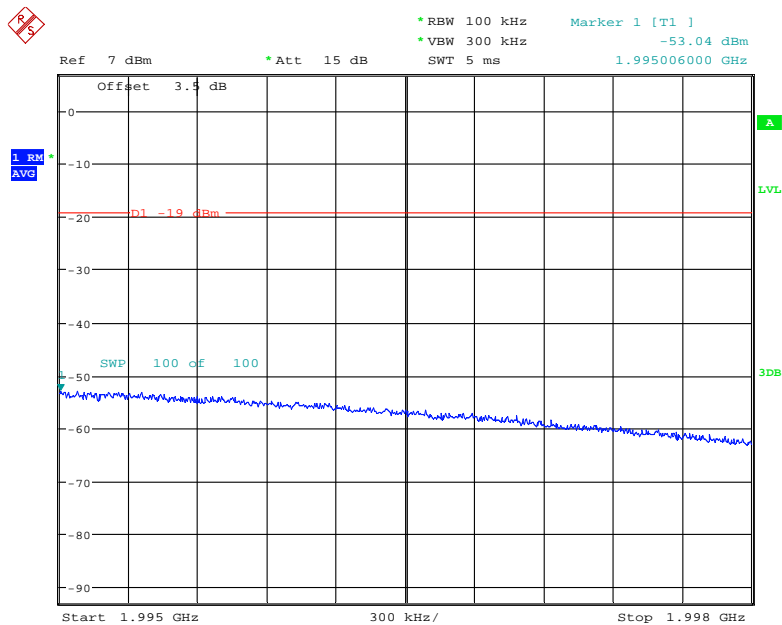

Date: 8.AUG.2019 12:51:31

### AWS Band CDMA Left Side Pre-AGC

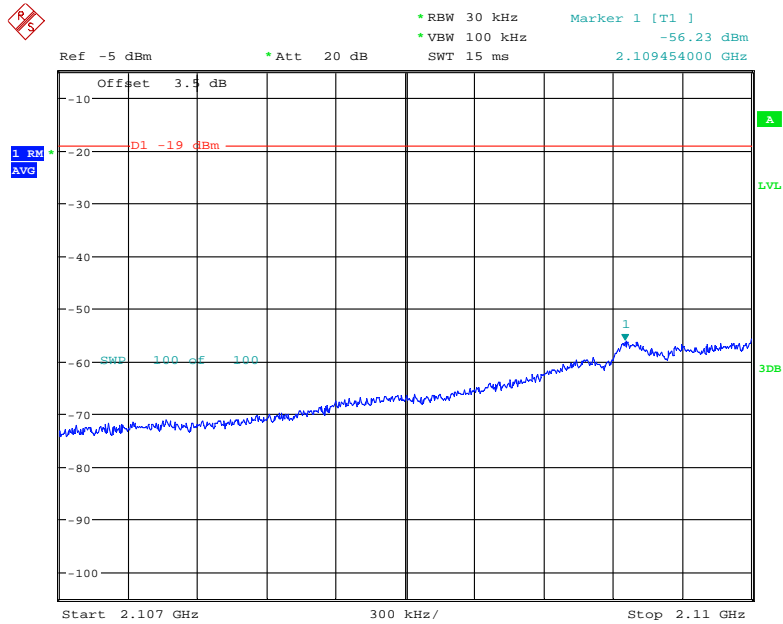

Date: 8.AUG.2019 14:23:48

### AWS Band CDMA Left Side Above AGC

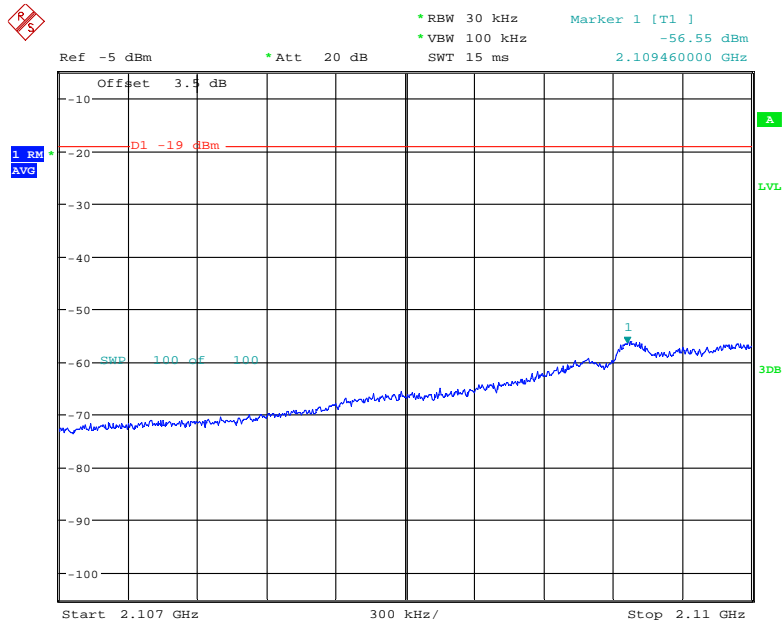

Date: 8.AUG.2019 14:24:04

### AWS Band GSM Left Side Pre-AGC

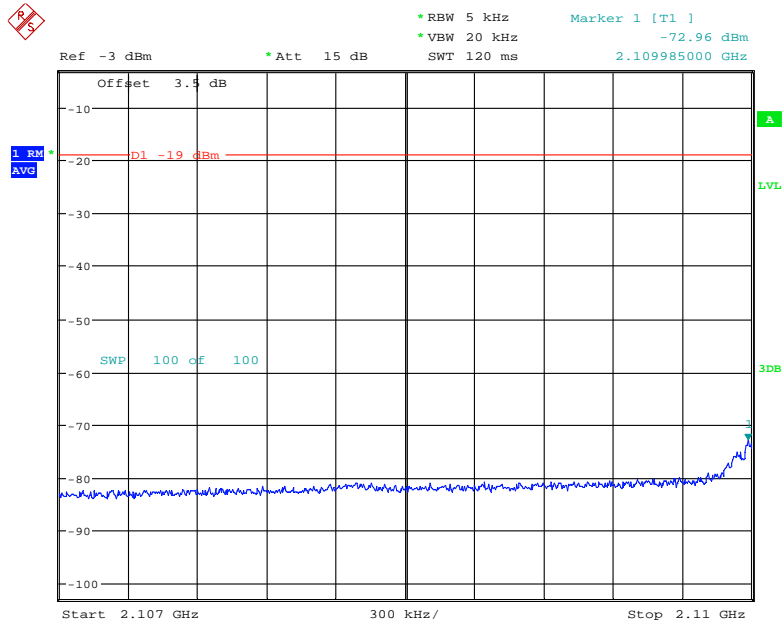

Date: 8.AUG.2019 13:25:49

### AWS Band GSM Left Side Above AGC

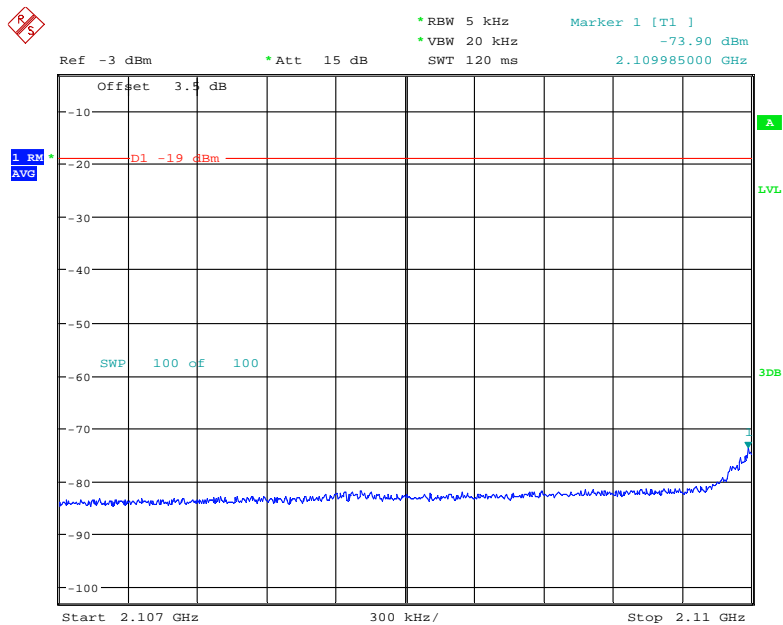

Date: 8.AUG.2019 13:26:26

### AWS Band LTE Left Side Pre-AGC

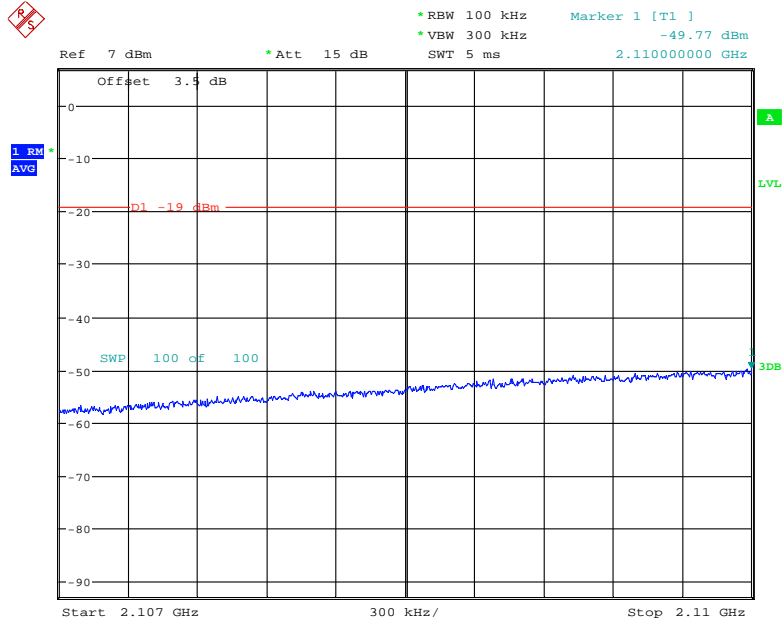

Date: 8.AUG.2019 12:52:46

### AWS Band LTE Left Side Above AGC

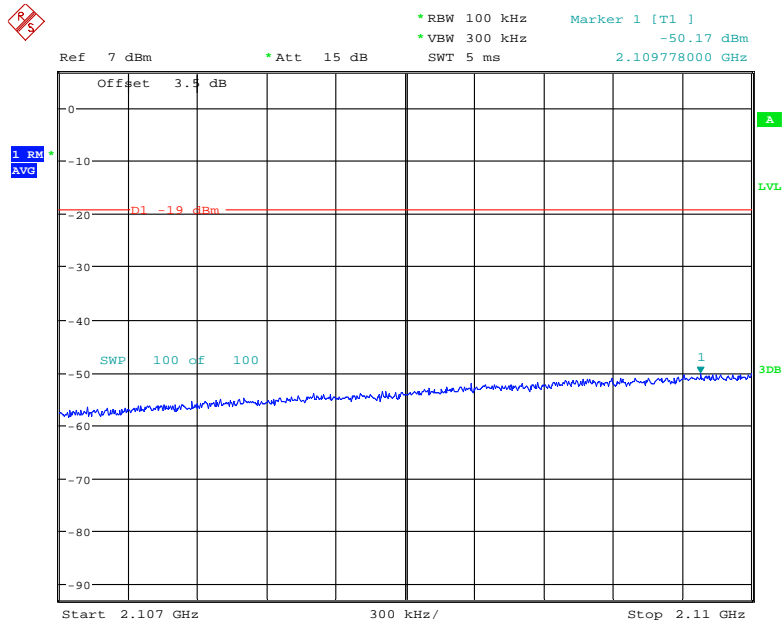

Date: 8.AUG.2019 12:53:29



### AWS Band CDMA Right Side Pre-AGC

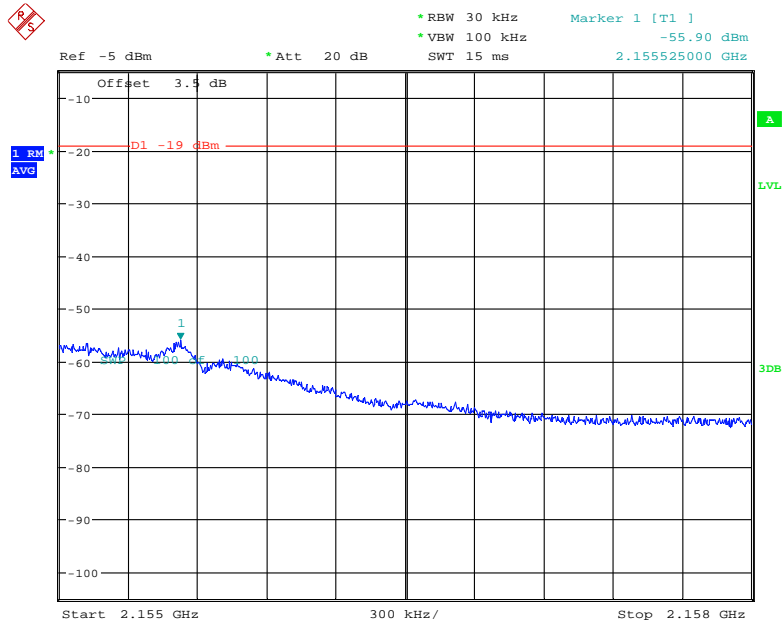

Date: 8.AUG.2019 14:24:34

### AWS Band CDMA Right Side Above AGC

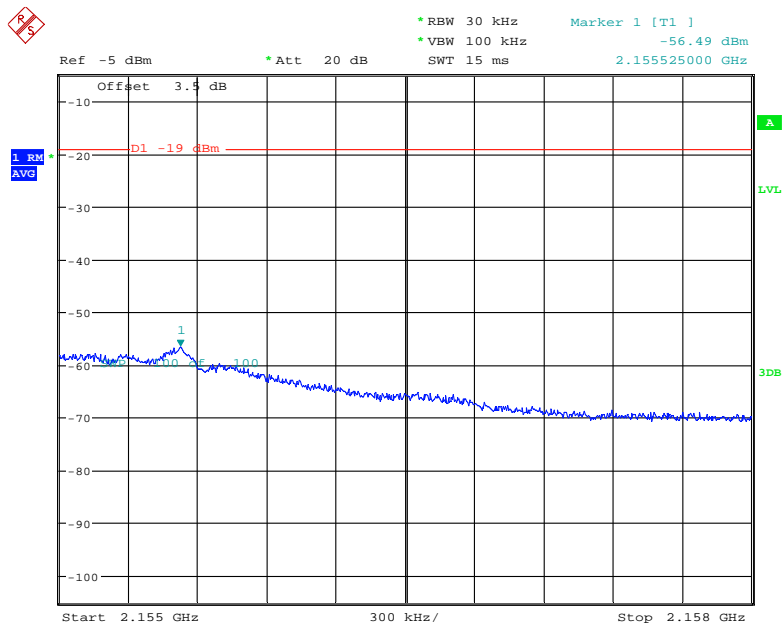

Date: 8.AUG.2019 14:24:55

### AWS Band GSM Right Side Pre-AGC

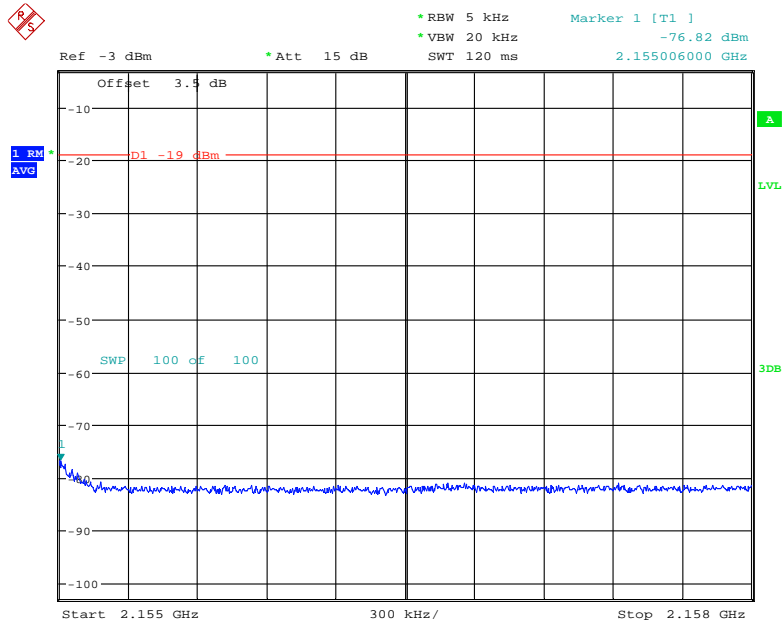

Date: 8.AUG.2019 13:27:51

### AWS Band GSM Right Side Above AGC

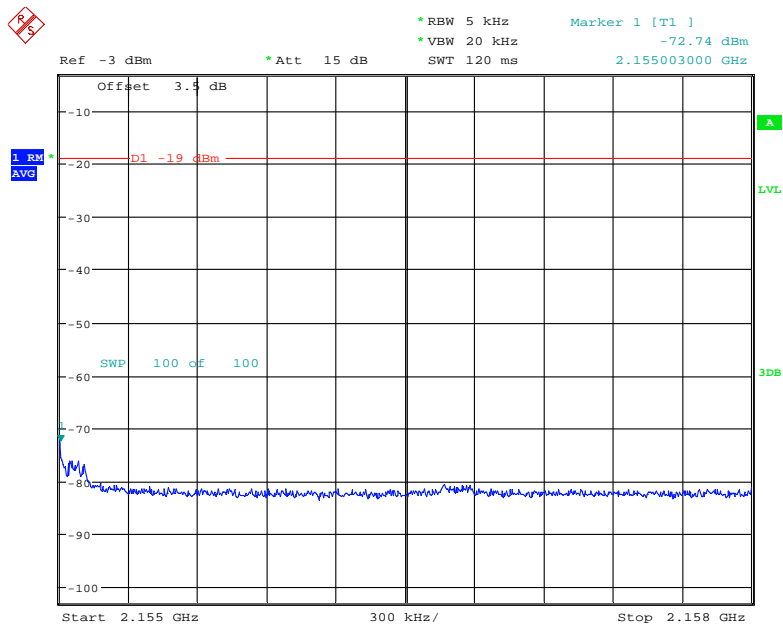

Date: 8.AUG.2019 13:27:27

### AWS Band LTE Right Side Pre-AGC

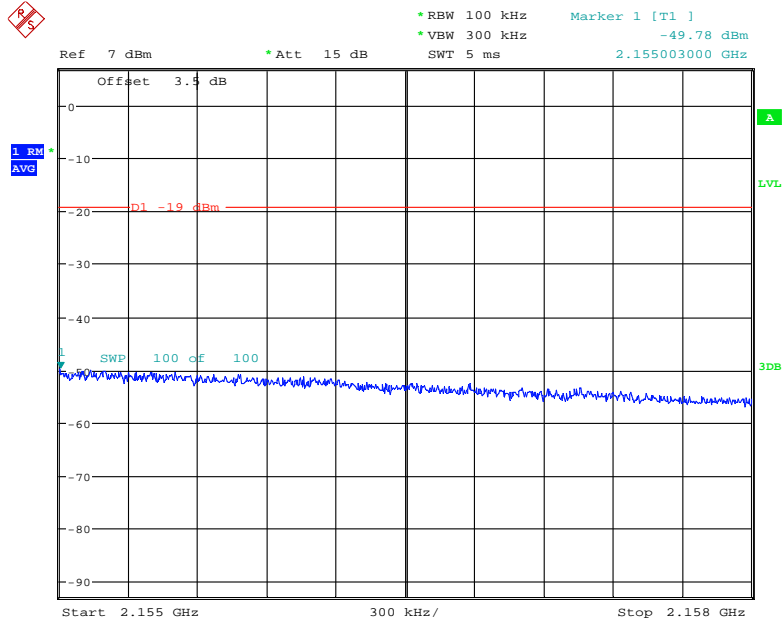

Date: 8.AUG.2019 12:54:03

### AWS Band LTE Right Side Above AGC

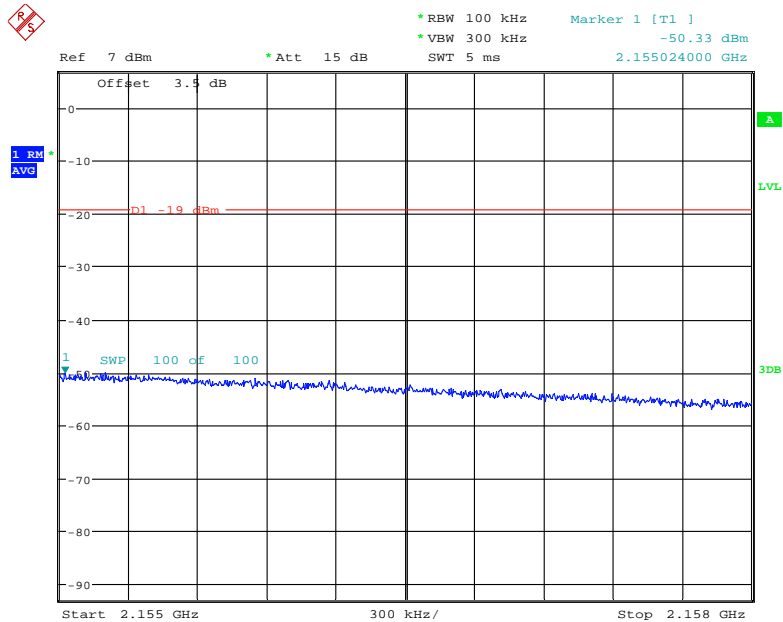

Date: 8.AUG.2019 12:54:23

Uplink

Lower 700MHz CDMA Left Side Pre-AGC

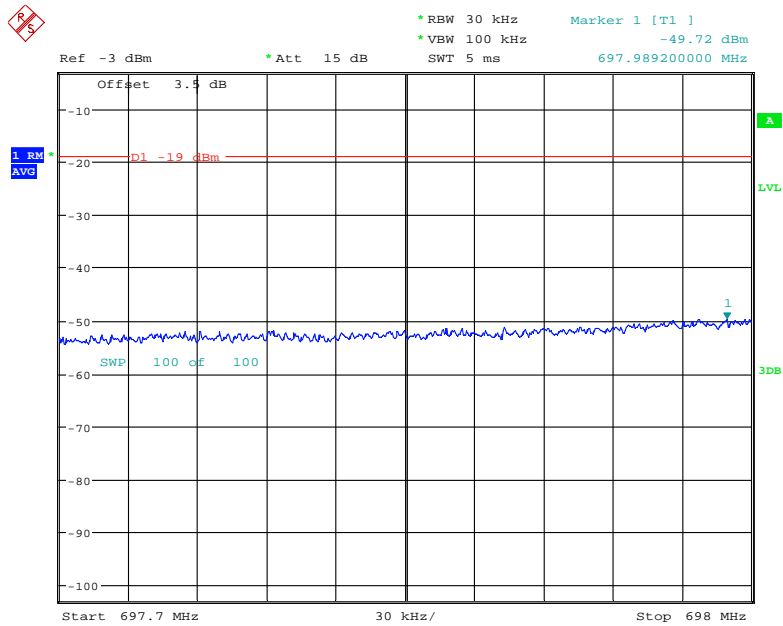

Date: 8.AUG.2019 14:01:11

Lower 700MHz CDMA Left Side Above AGC

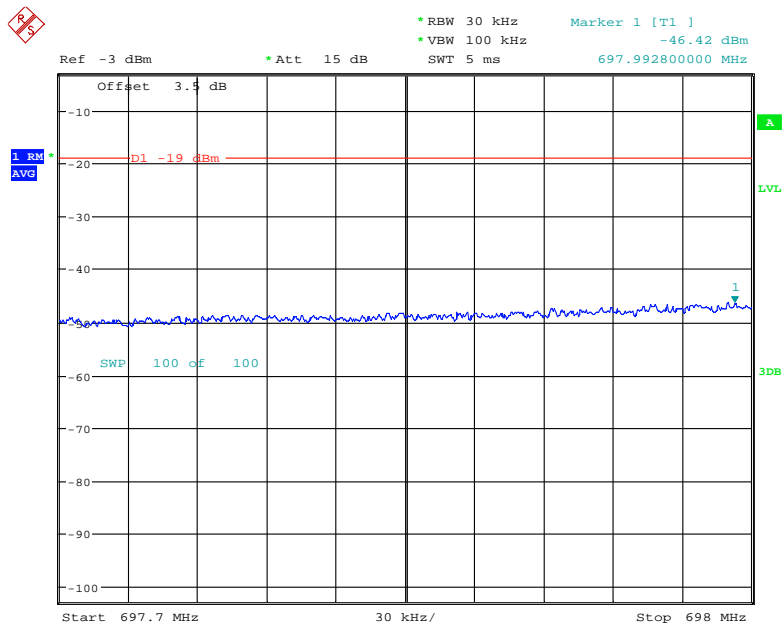

Date: 8.AUG.2019 14:02:38

### Lower 700MHz GSM Left Side Pre-AGC

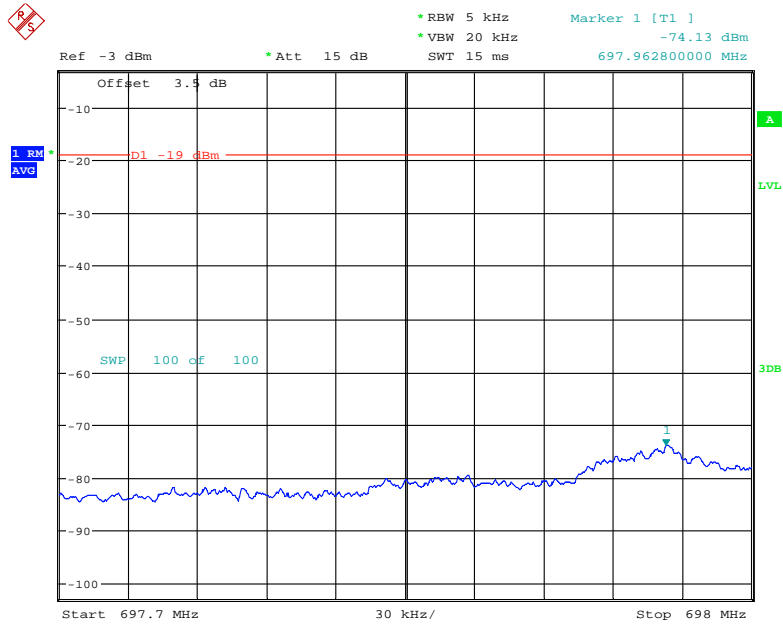

Date: 8.AUG.2019 13:43:43

### Lower 700MHz GSM Left Side Above AGC

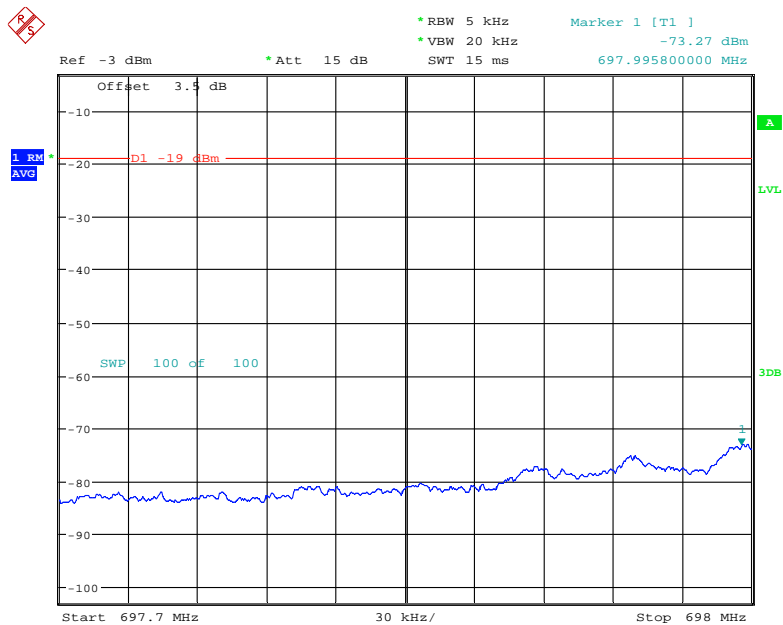

Date: 8.AUG.2019 13:44:12

### Lower 700MHz LTE Left Side Pre-AGC

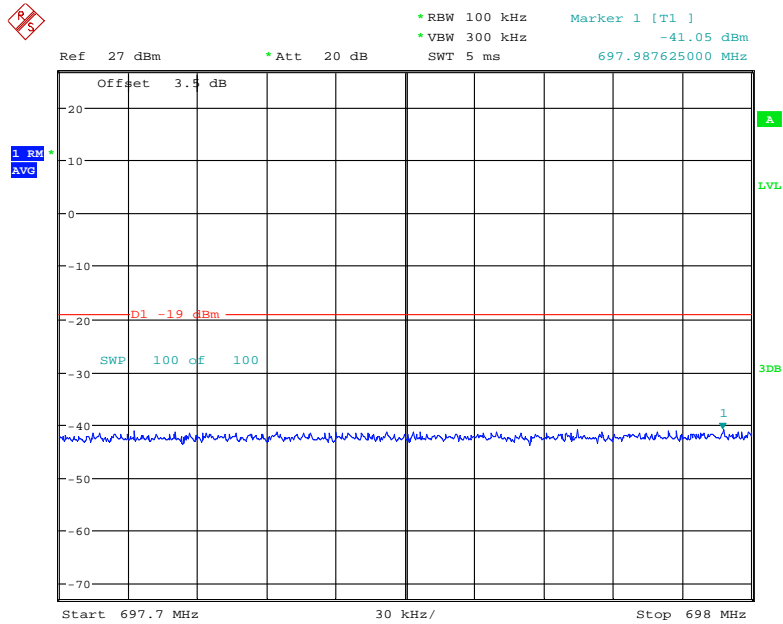

Date: 30.JUL.2019 18:49:27

### Lower 700MHz LTE Left Side Above AGC

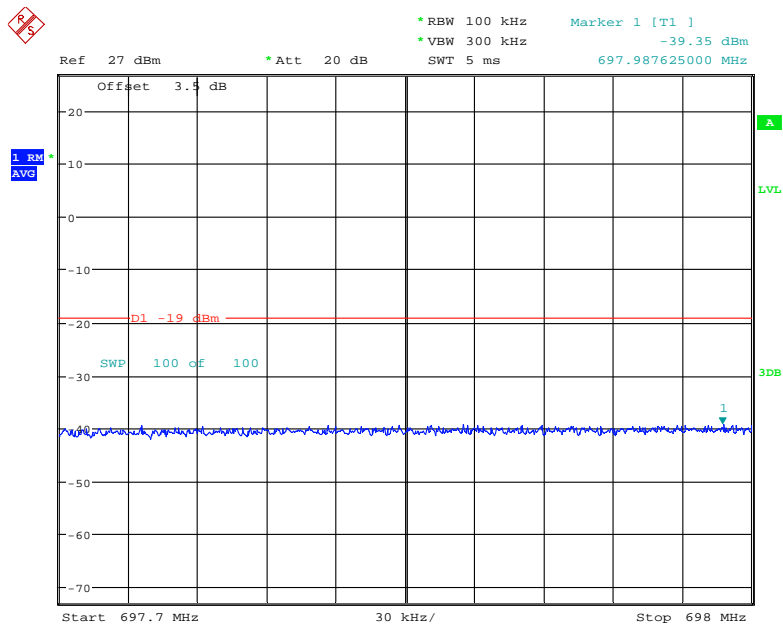

Date: 30.JUL.2019 18:49:47

### Lower 700MHz CDMA Right Side Pre-AGC

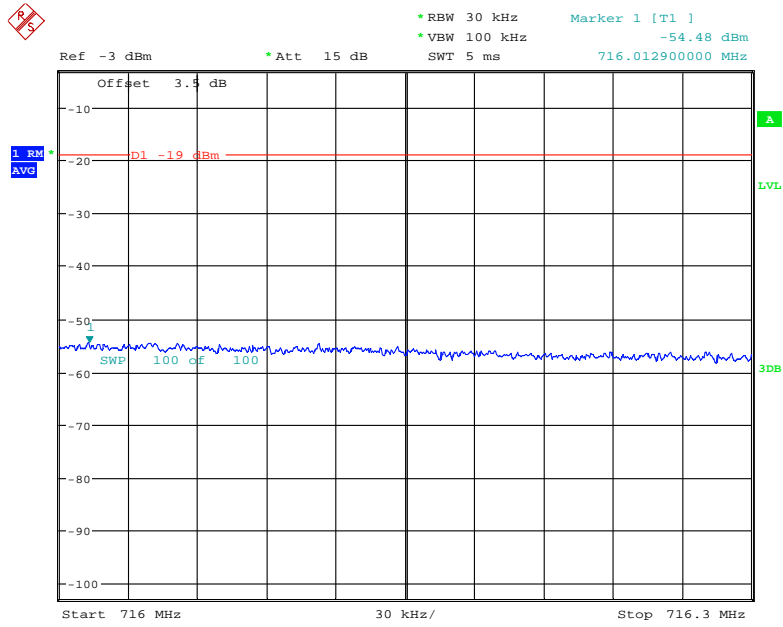

Date: 8.AUG.2019 14:03:41

### Lower 700MHz CDMA Right Side Above AGC

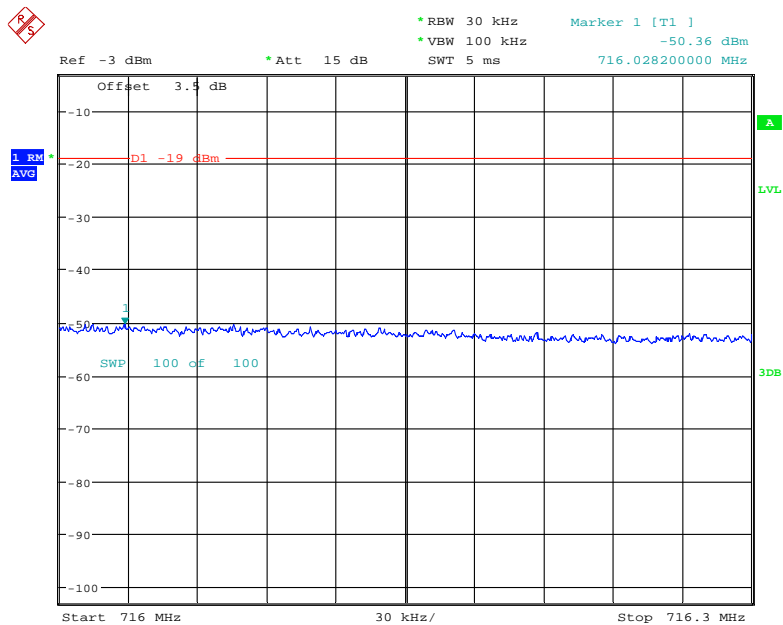

Date: 8.AUG.2019 14:04:10

### Lower 700MHz GSM Right Side Pre-AGC

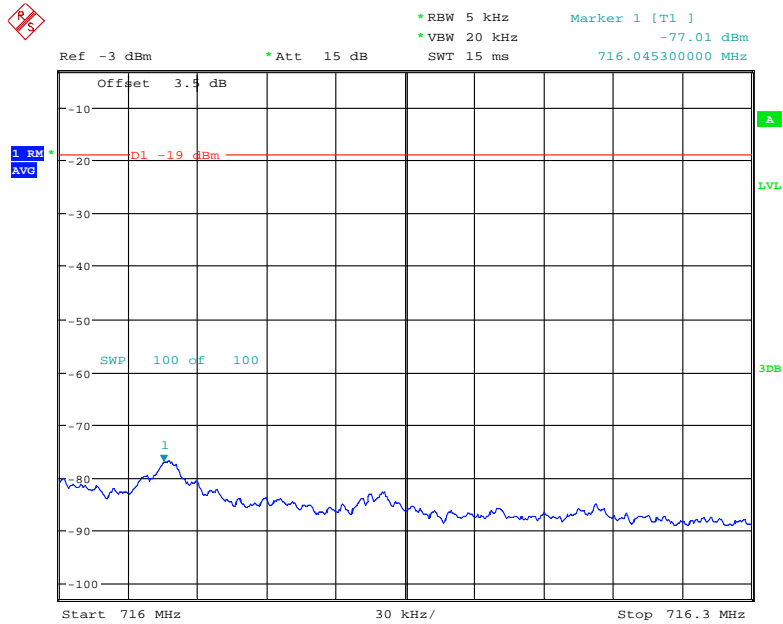

Date: 8.AUG.2019 13:44:39

### Lower 700MHz GSM Right Side Above AGC

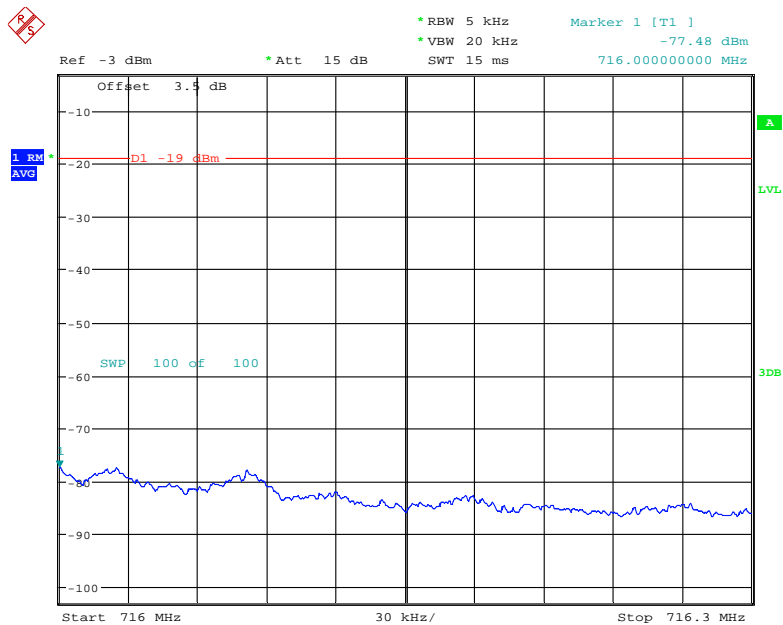

Date: 8.AUG.2019 13:44:52



### Lower 700MHz LTE Right Side Pre-AGC

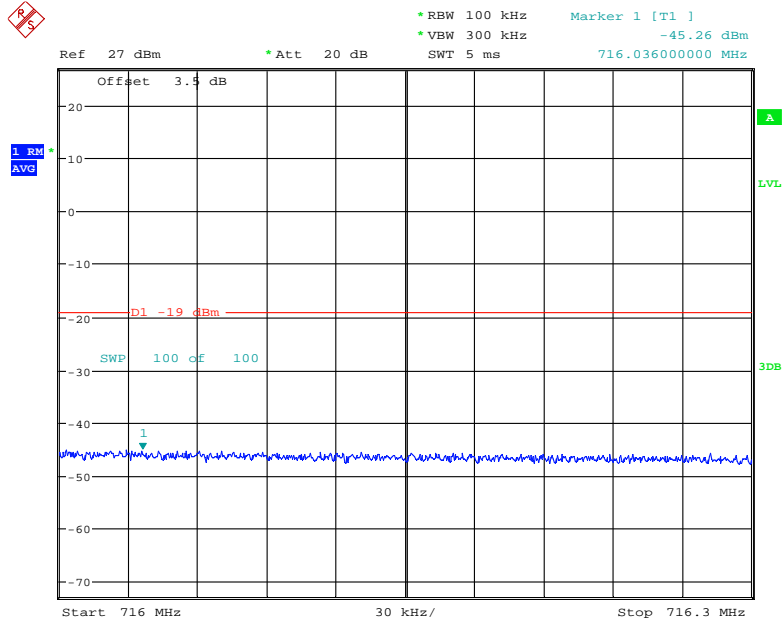

Date: 30.JUL.2019 18:47:21

### Lower 700MHz LTE Right Side Above AGC

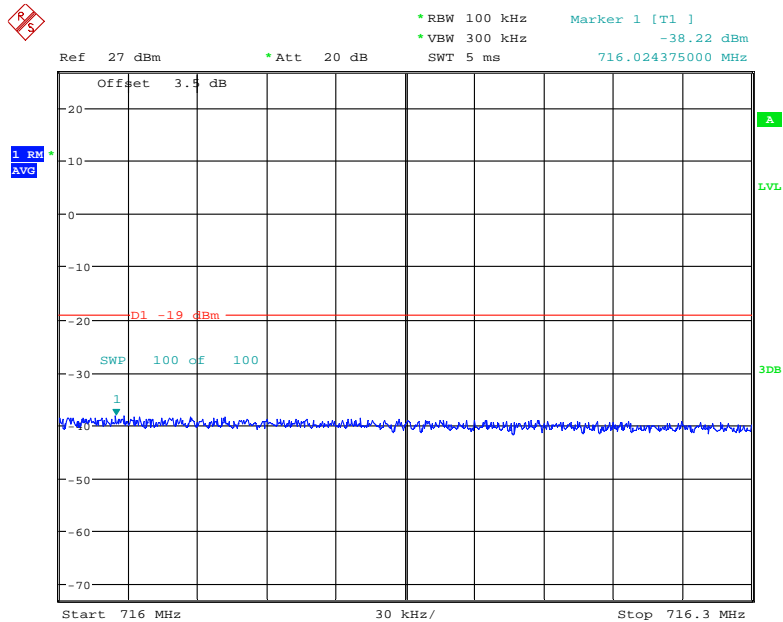

Date: 30.JUL.2019 18:47:42

### Upper 700MHz CDMA Left Side Pre-AGC

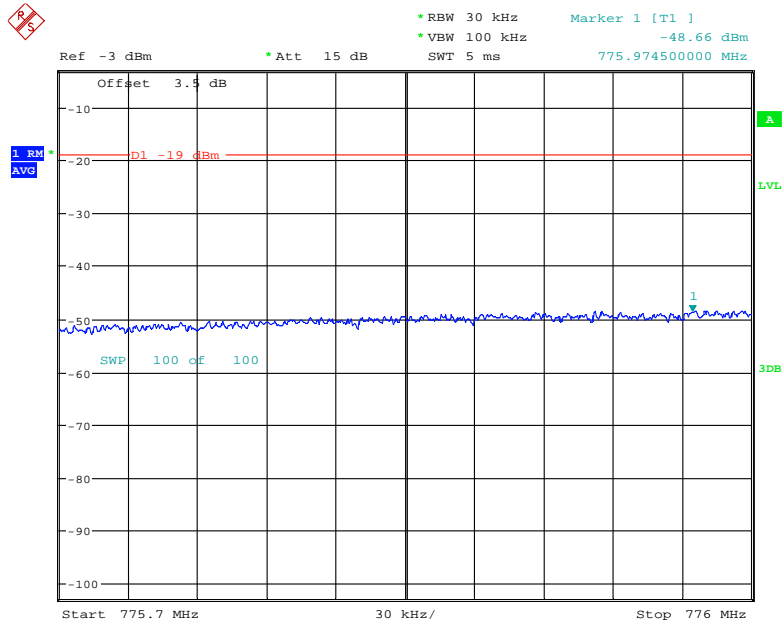

Date: 8.AUG.2019 14:04:49

### Upper 700MHz CDMA Left Side Above AGC

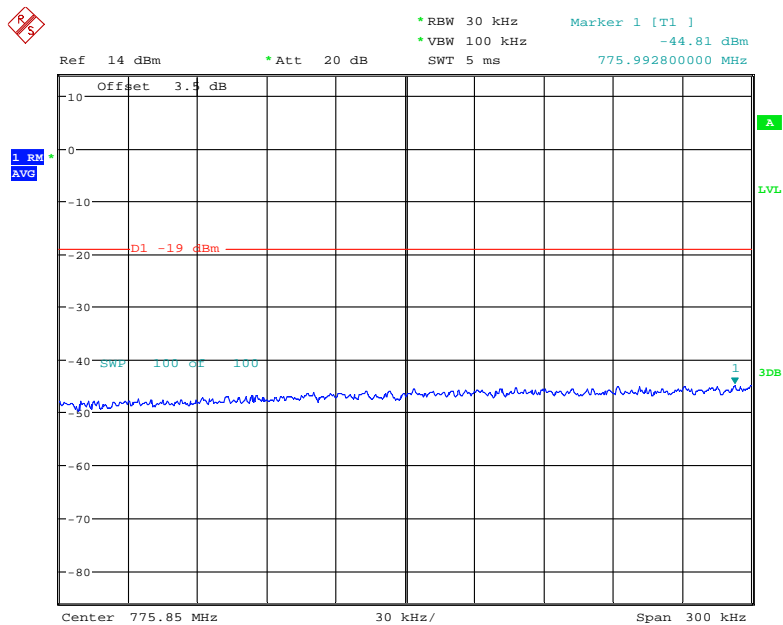

Date: 8.AUG.2019 14:10:31

### Upper 700MHz GSM Left Side Pre-AGC

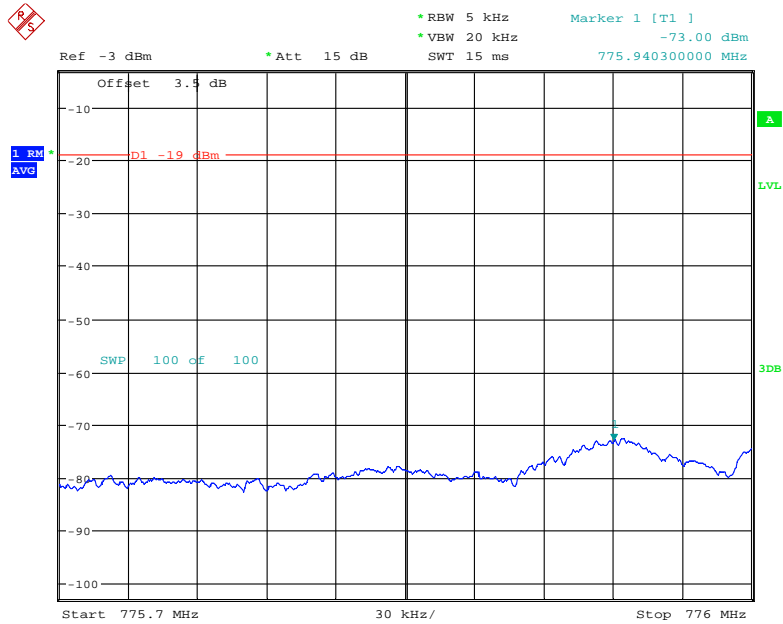

Date: 8.AUG.2019 13:46:56

### Upper 700MHz GSM Left Side Above AGC

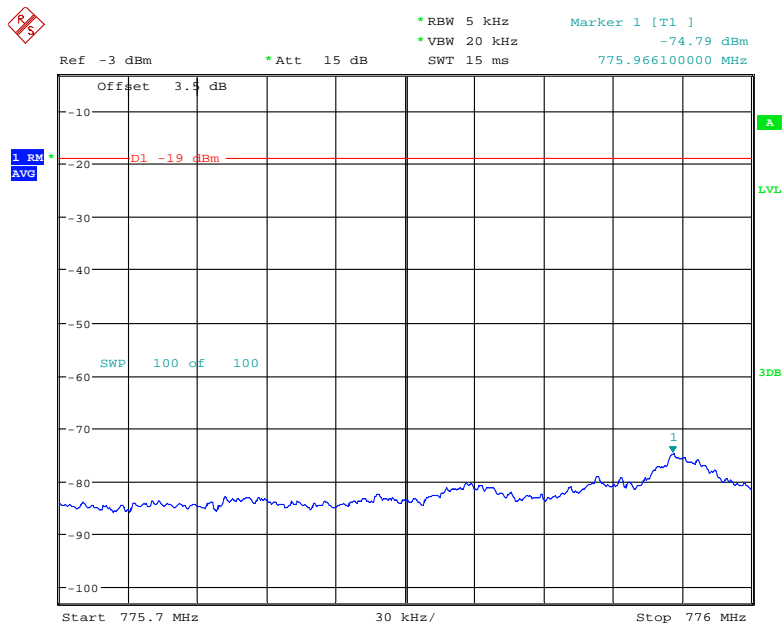

Date: 8.AUG.2019 13:47:23

### Upper 700MHz LTE Left Side Pre-AGC

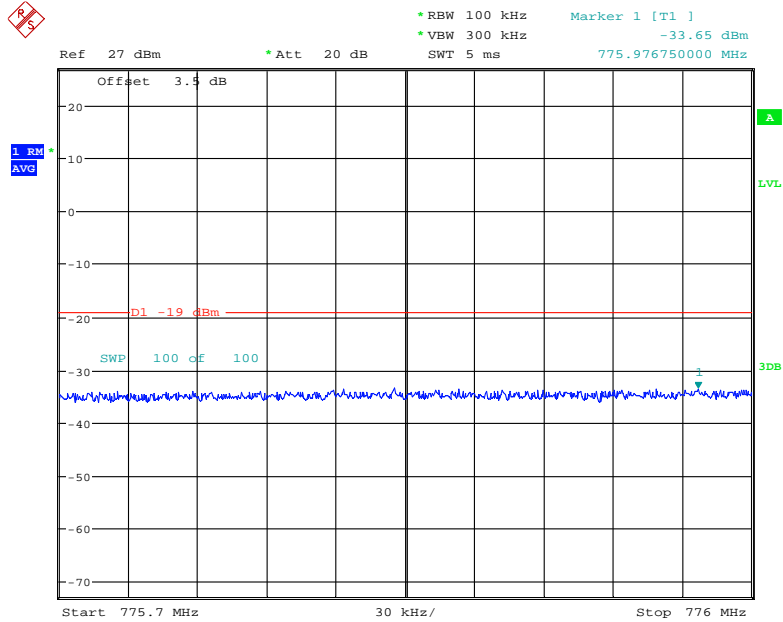

Date: 30.JUL.2019 18:45:08

### Upper 700MHz LTE Left Side Above AGC

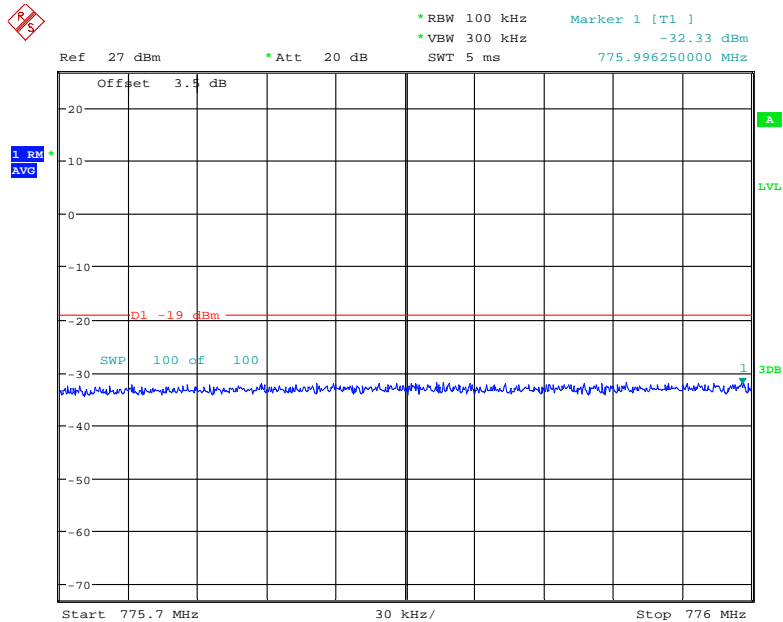

Date: 30.JUL.2019 18:45:22

### Upper 700MHz CDMA Right Side Pre-AGC

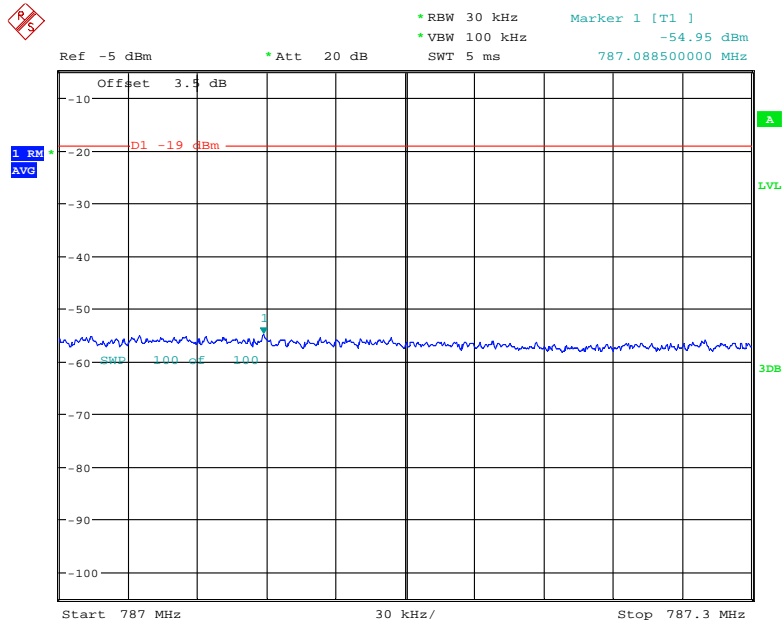

Date: 8.AUG.2019 14:18:46

### Upper 700MHz CDMA Right Side Above AGC

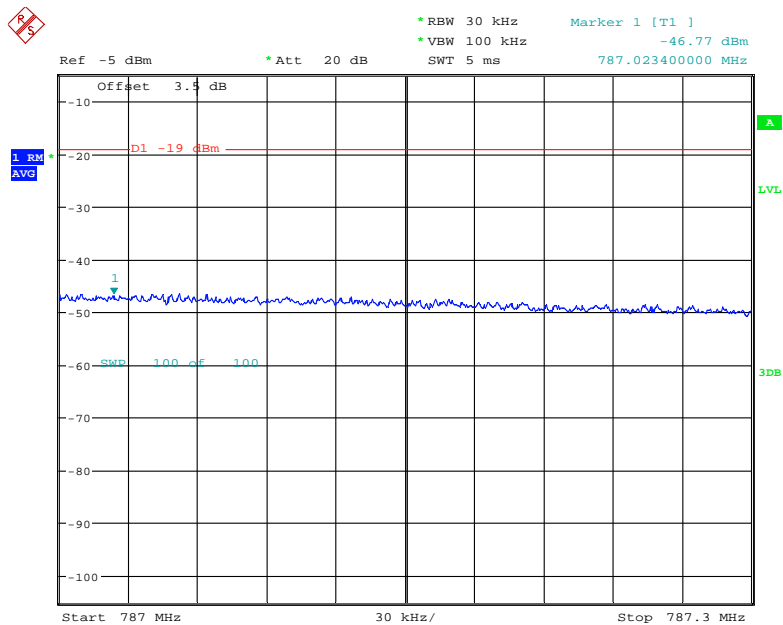

Date: 8.AUG.2019 14:19:36

### Upper 700MHz GSM Right Side Pre-AGC

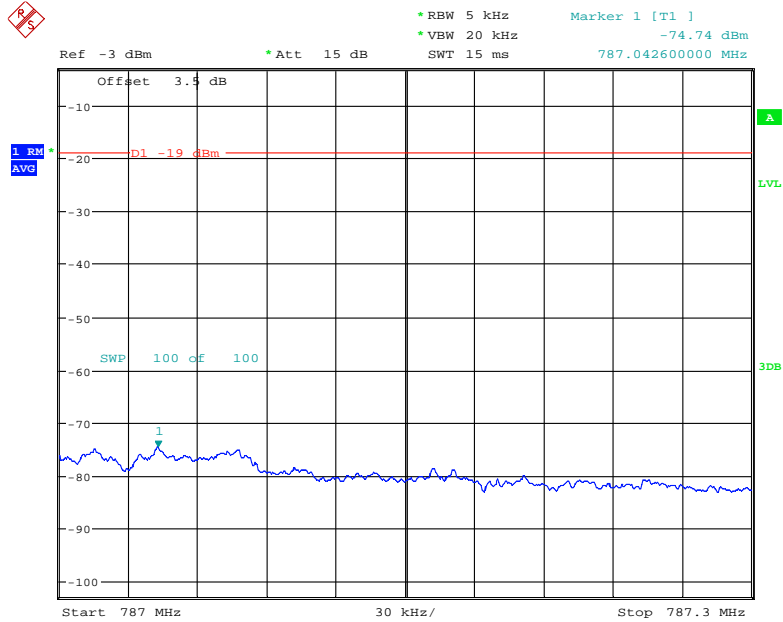

Date: 8.AUG.2019 13:49:05

### Upper 700MHz GSM Right Side Above AGC

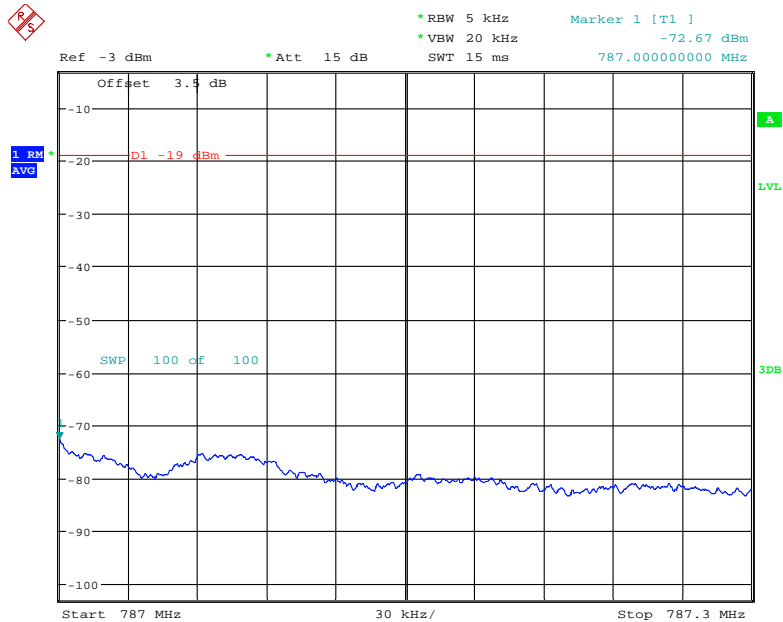

Date: 8.AUG.2019 13:49:23

### Upper 700MHz LTE Right Side Pre-AGC

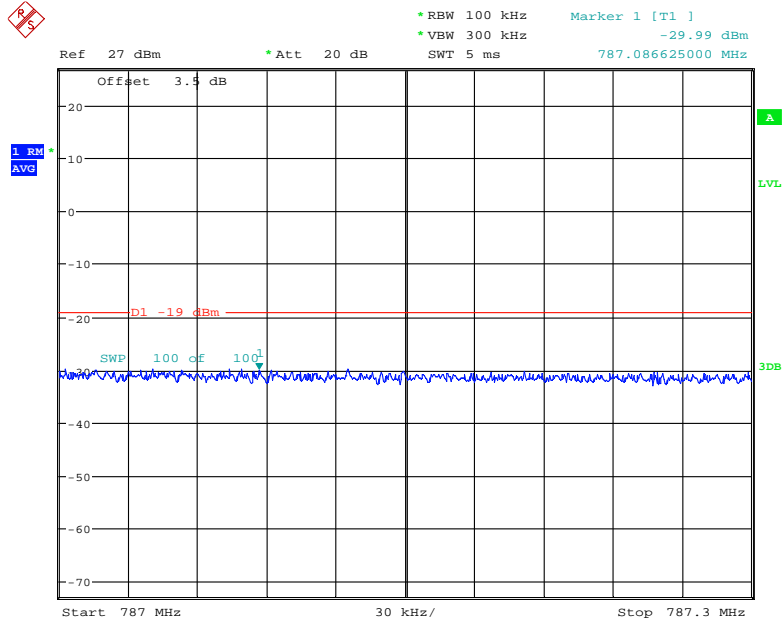

Date: 30.JUL.2019 18:43:08

### Upper 700MHz LTE Right Side Above AGC

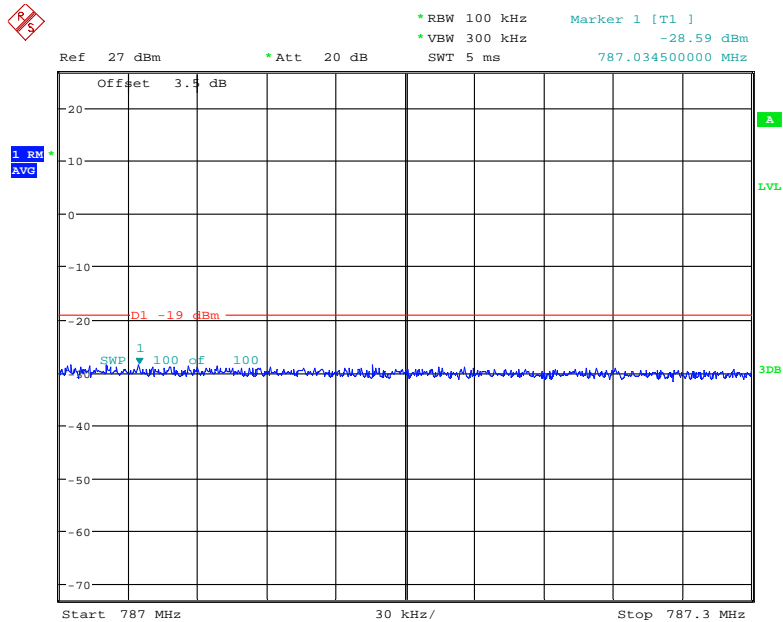

Date: 30.JUL.2019 18:43:34

### Cellular Band CDMA Left Side Pre-AGC

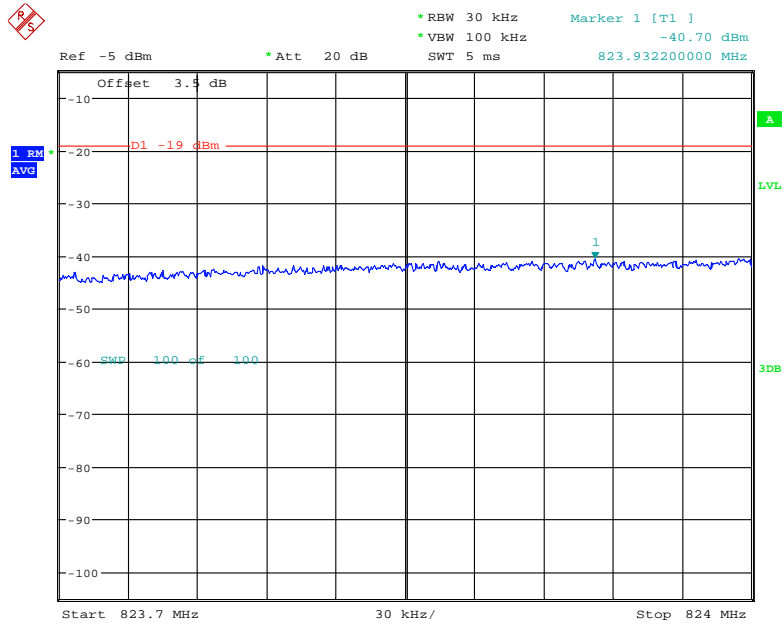

Date: 8.AUG.2019 14:14:08

### Cellular Band CDMA Left Side Above AGC

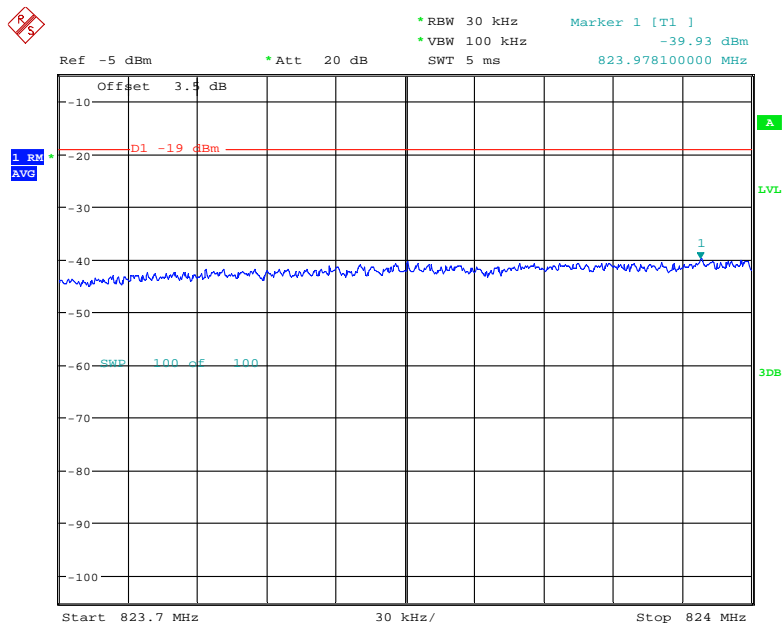

Date: 8.AUG.2019 14:14:48



### Cellular Band GSM Left Side Pre-AGC

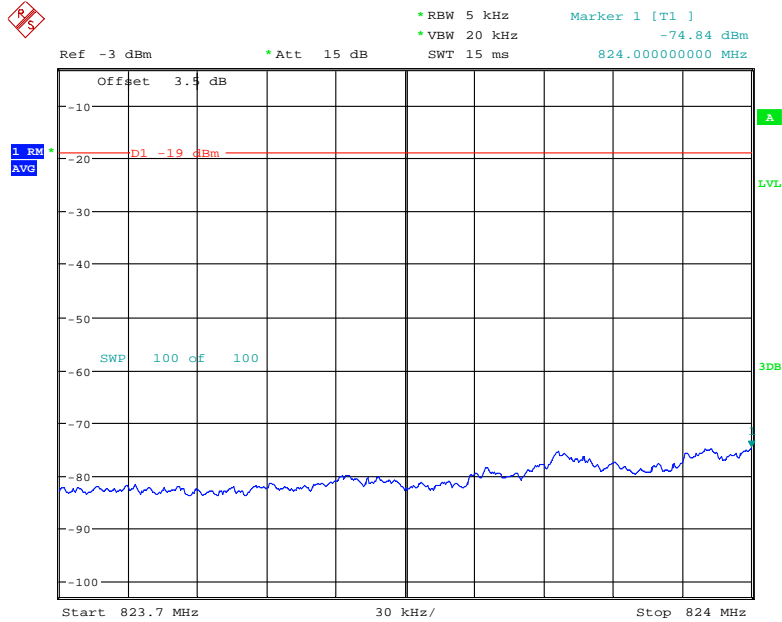

Date: 8.AUG.2019 13:39:33

### Cellular Band GSM Left Side Above AGC

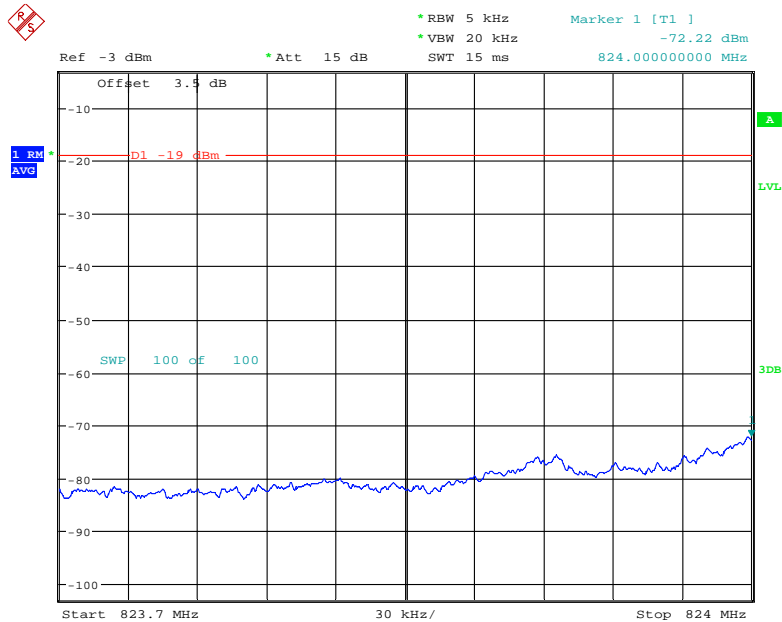

Date: 8.AUG.2019 13:39:50

### Cellular Band LTE Left Side Pre-AGC

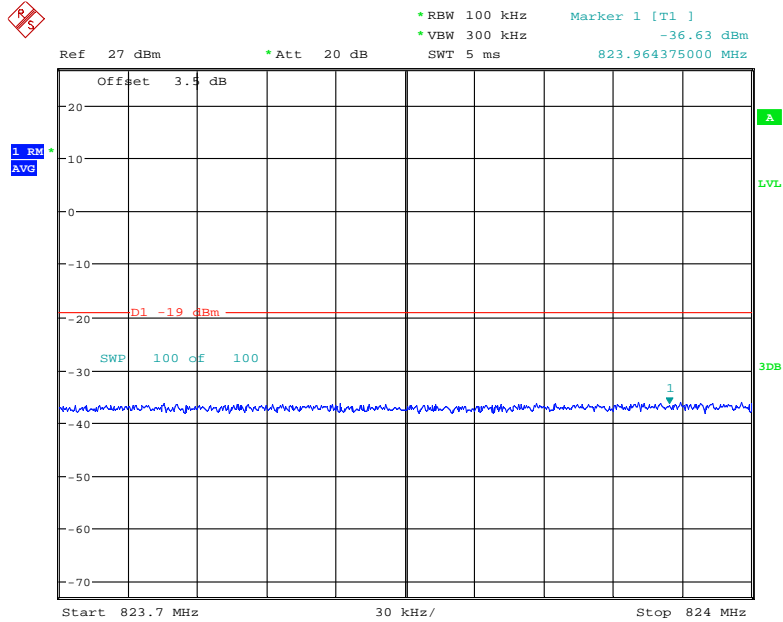

Date: 30.JUL.2019 18:32:23

### Cellular Band LTE Left Side Above AGC

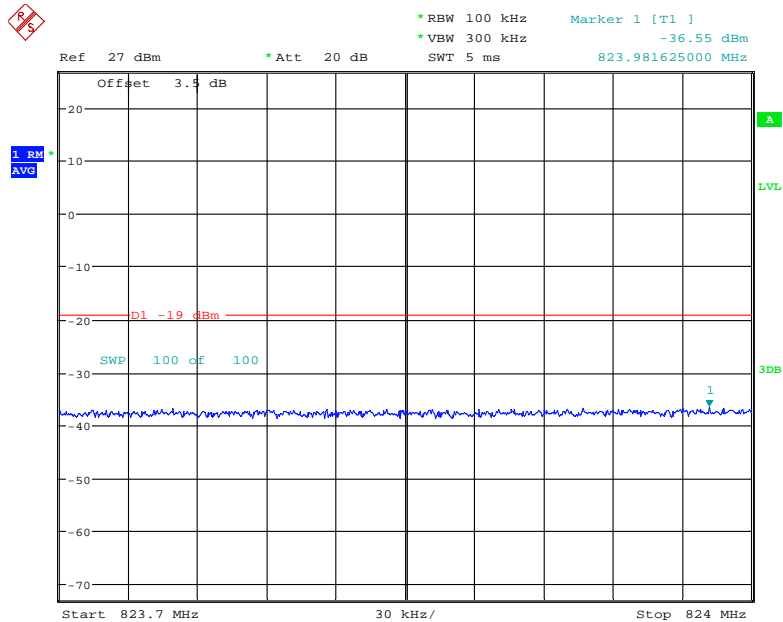

Date: 30.JUL.2019 18:33:26

### Cellular Band CDMA Right Side Pre-AGC

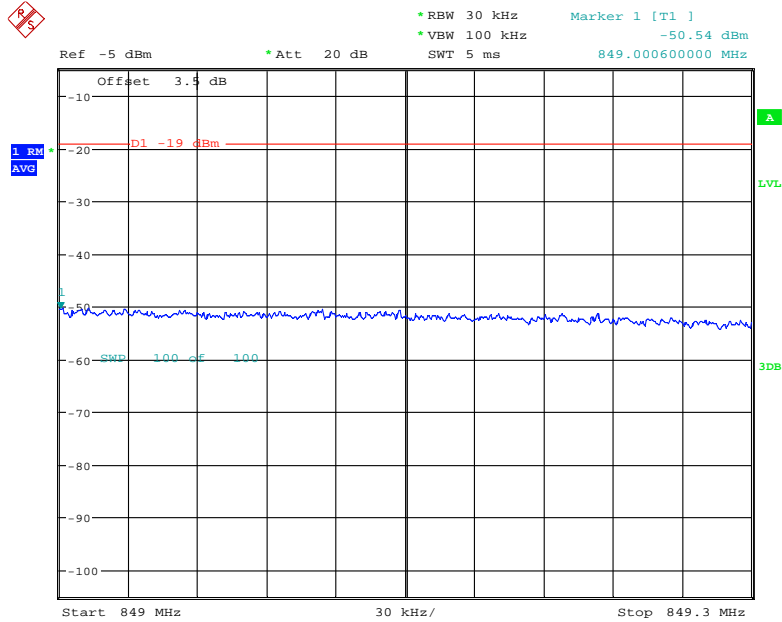

Date: 8.AUG.2019 14:15:28

### Cellular Band CDMA Right Side Above AGC

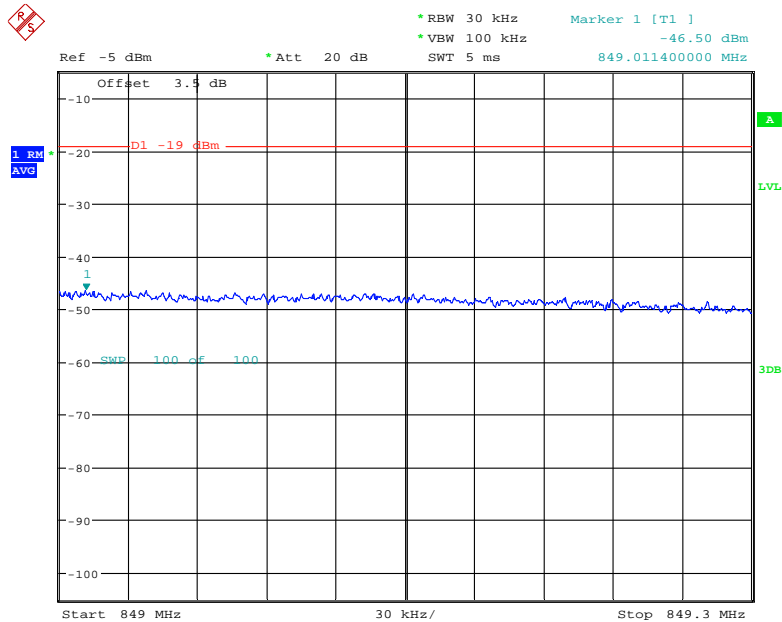

Date: 8.AUG.2019 14:16:06

### Cellular Band GSM Right Side Pre-AGC

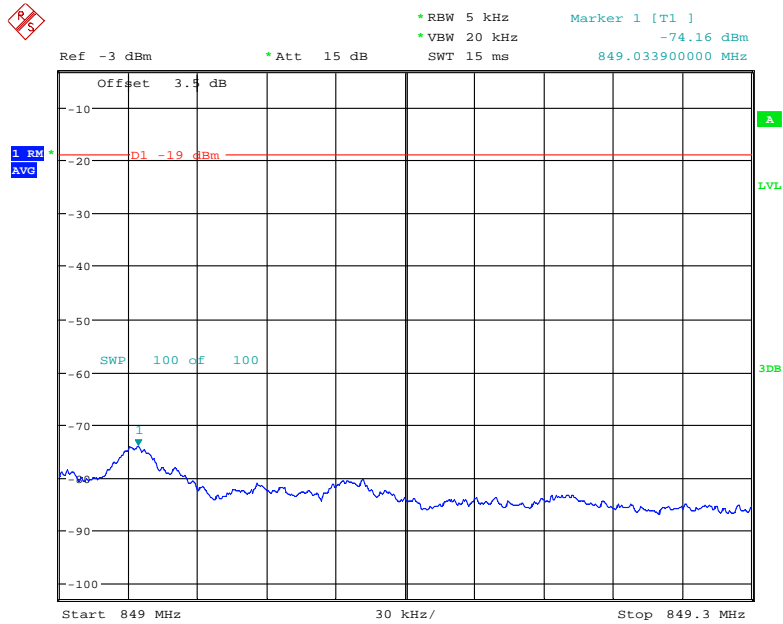

Date: 8.AUG.2019 13:40:30

### Cellular Band GSM Right Side Above AGC

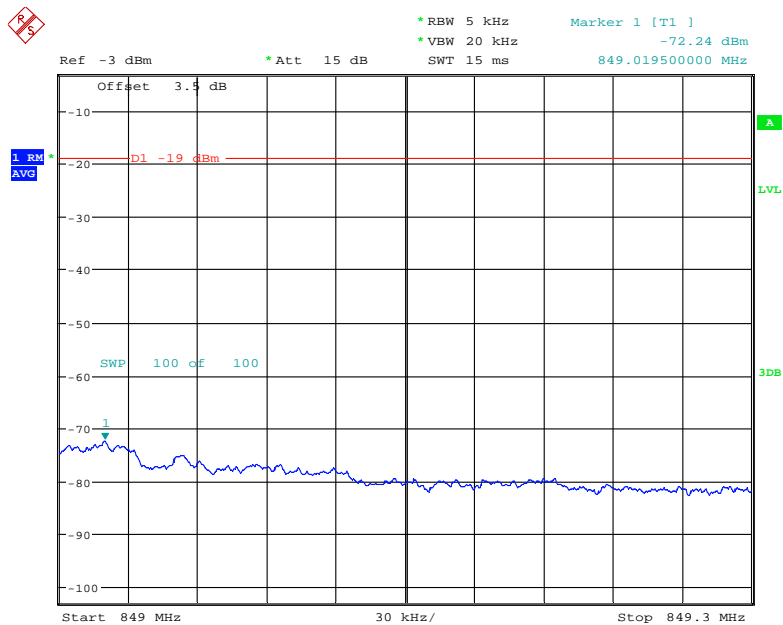

Date: 8.AUG.2019 13:40:44

### Cellular Band LTE Right Side Pre-AGC

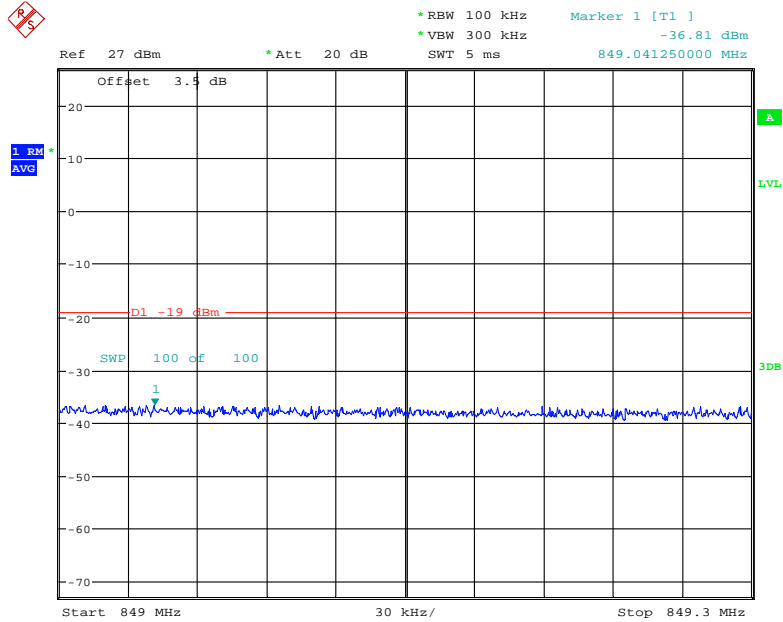

Date: 30.JUL.2019 18:40:34

### Cellular Band LTE Right Side Above AGC

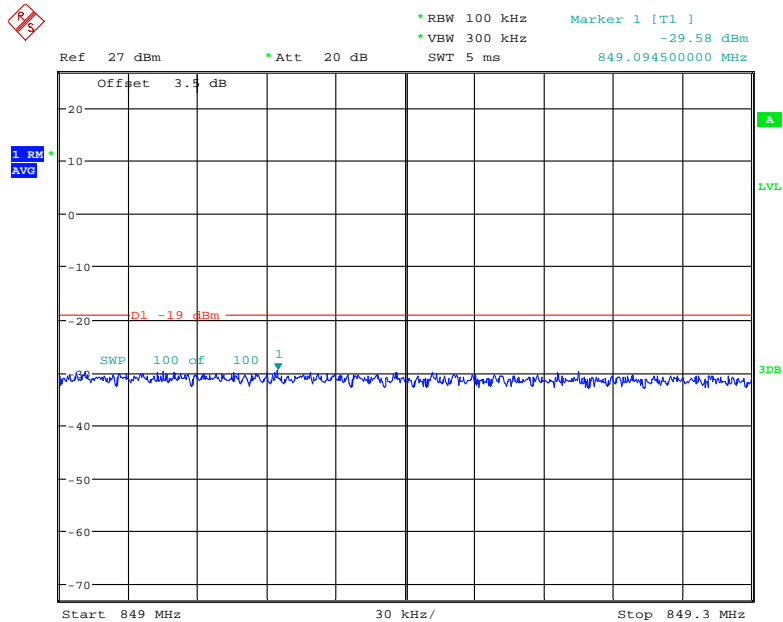

Date: 30.JUL.2019 18:41:04

### PCS Band CDMA Left Side Pre-AGC

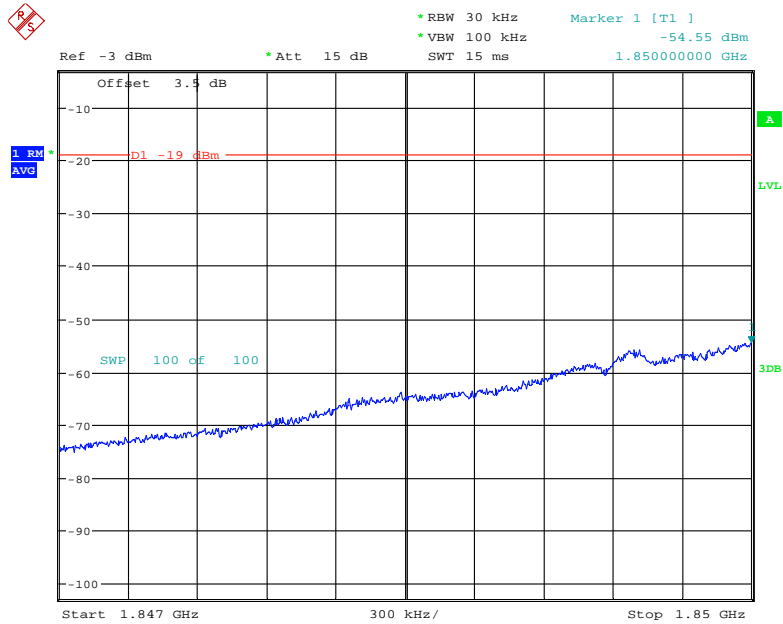

Date: 8.AUG.2019 13:52:53

### PCS Band CDMA Left Side Above AGC

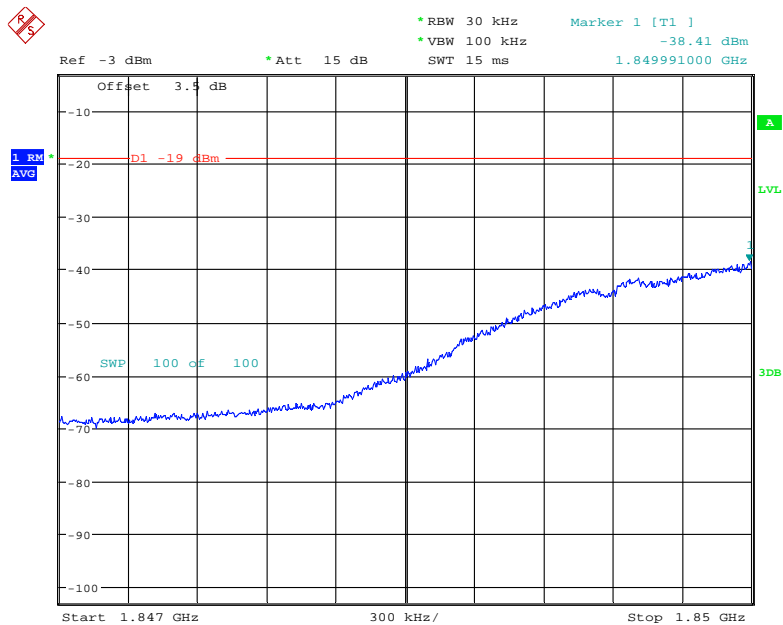

Date: 8.AUG.2019 13:54:52

### PCS Band GSM Left Side Pre-AGC

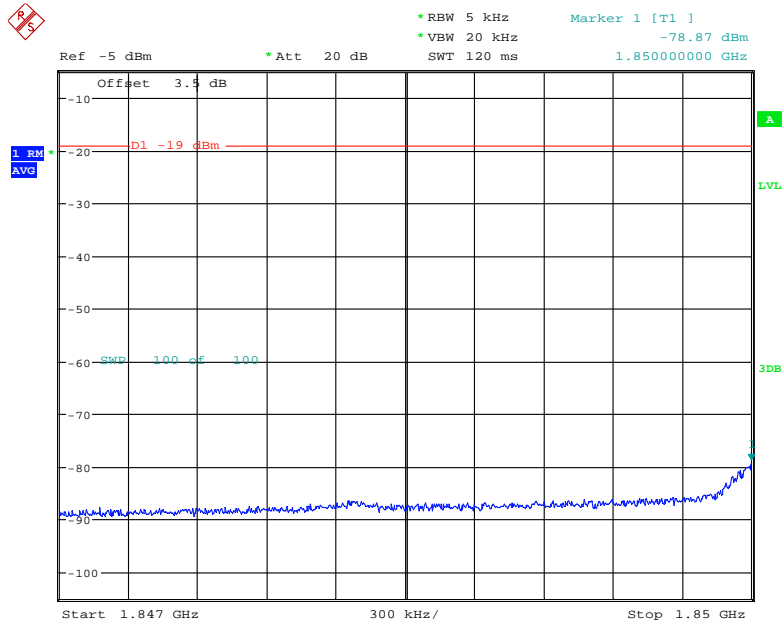

Date: 8.AUG.2019 14:52:16

### PCS Band GSM Left Side Above AGC

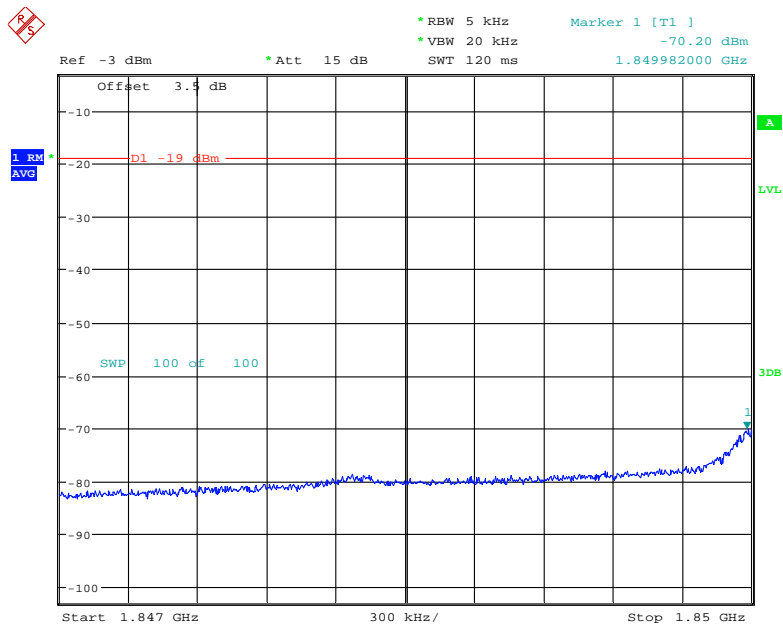

Date: 8.AUG.2019 13:37:12

### PCS Band LTE Left Side Pre-AGC

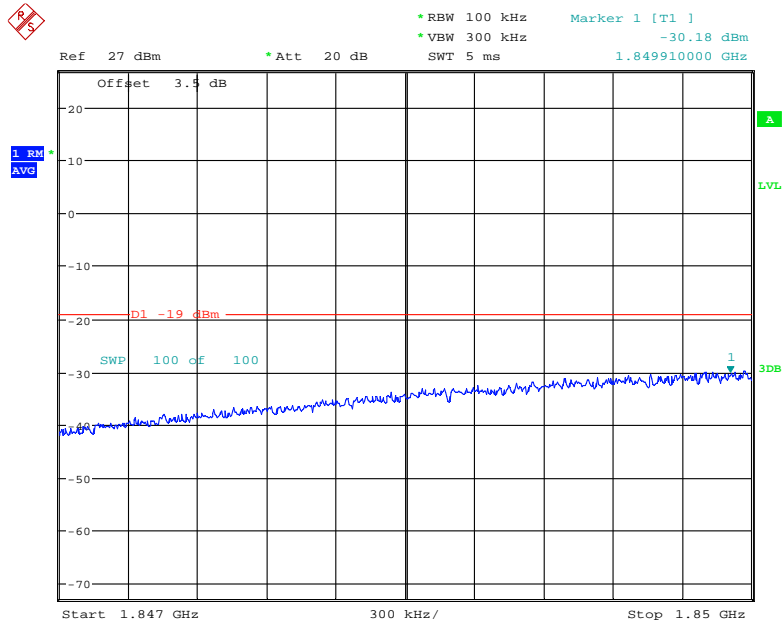

Date: 30.JUL.2019 18:07:09

### PCS Band LTE Left Side Above AGC

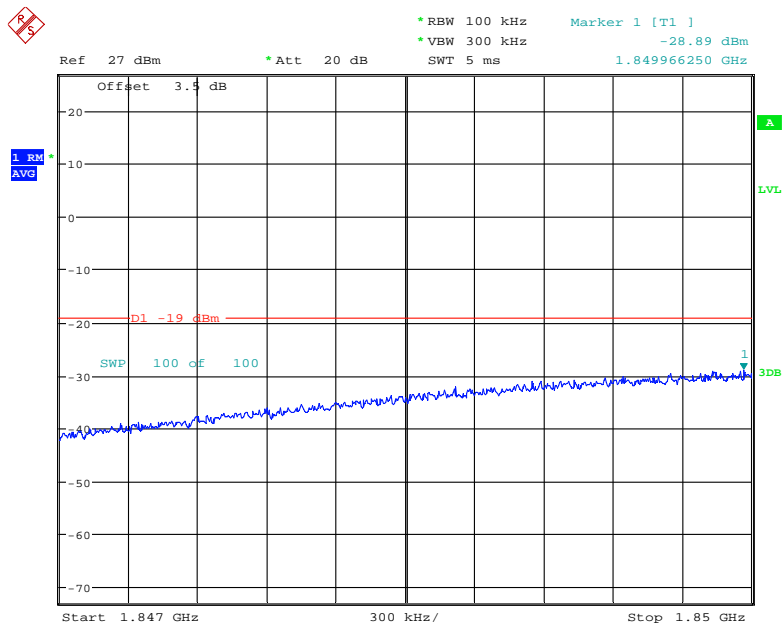

Date: 30.JUL.2019 18:09:41



### PCS Band CDMA Right Side Pre-AGC

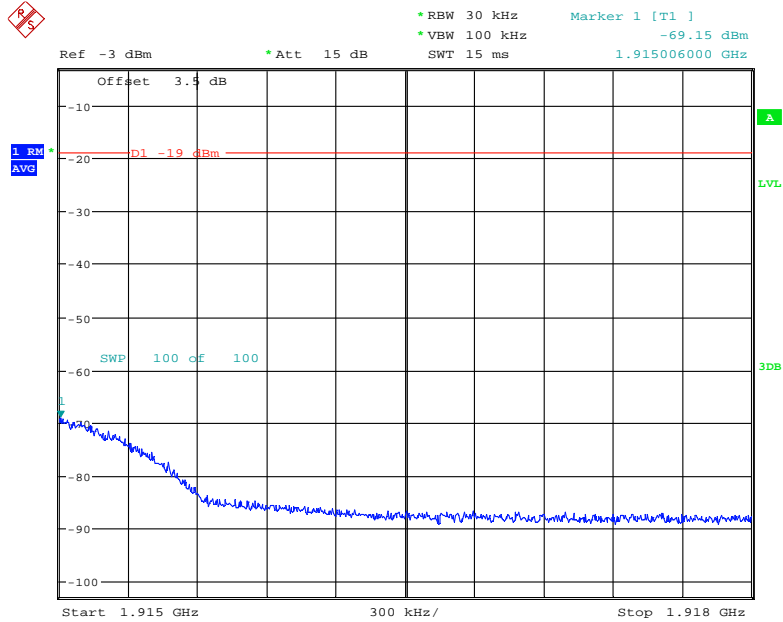

Date: 8.AUG.2019 13:55:27

### PCS Band CDMA Right Side Above AGC

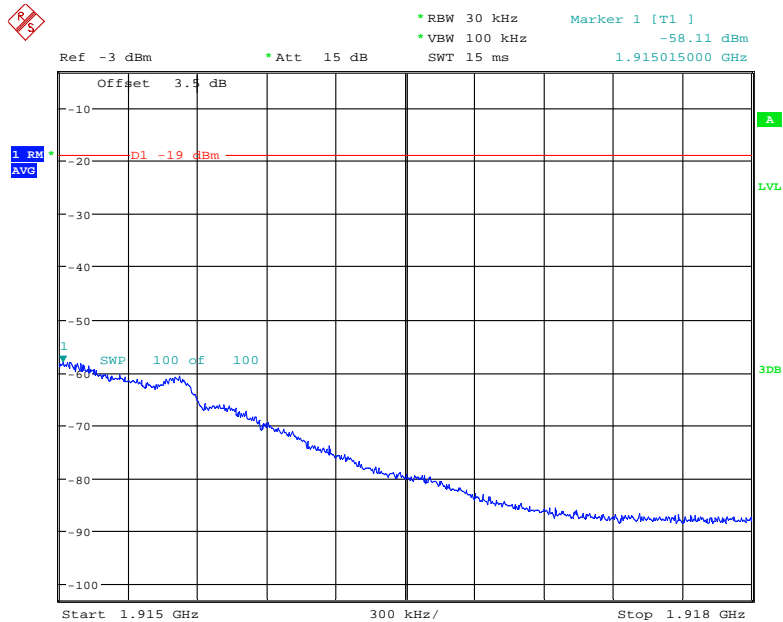

Date: 8.AUG.2019 13:55:50

### PCS Band GSM Right Side Pre-AGC

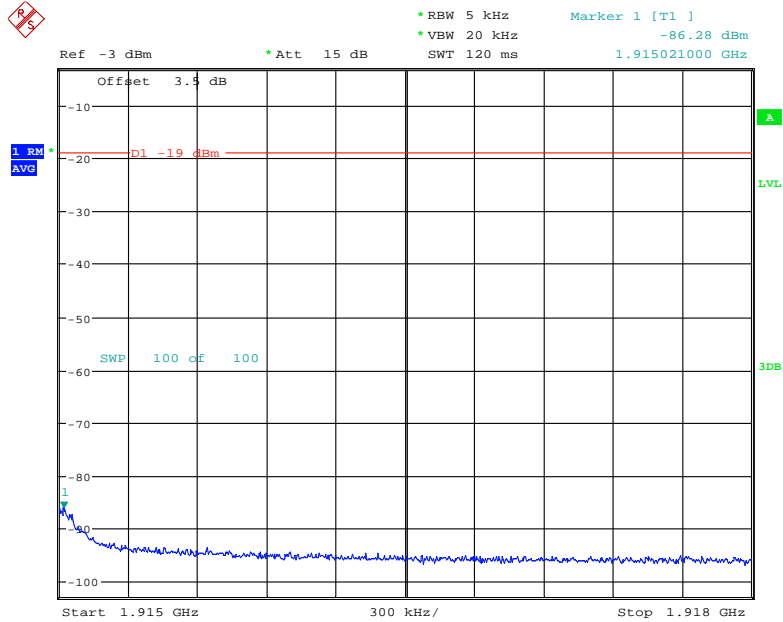

Date: 8.AUG.2019 13:38:23

### PCS Band GSM Right Side Above AGC

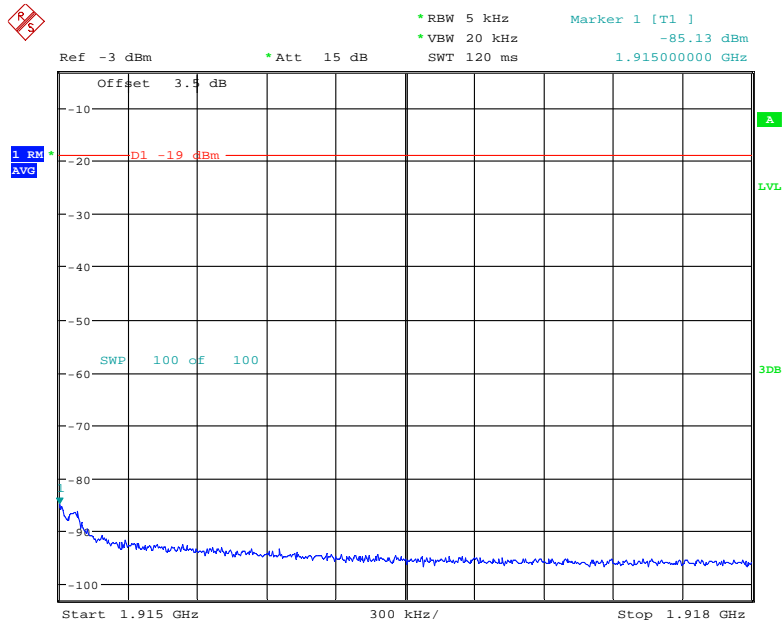

Date: 8.AUG.2019 13:38:35

### PCS Band LTE Right Side Pre-AGC

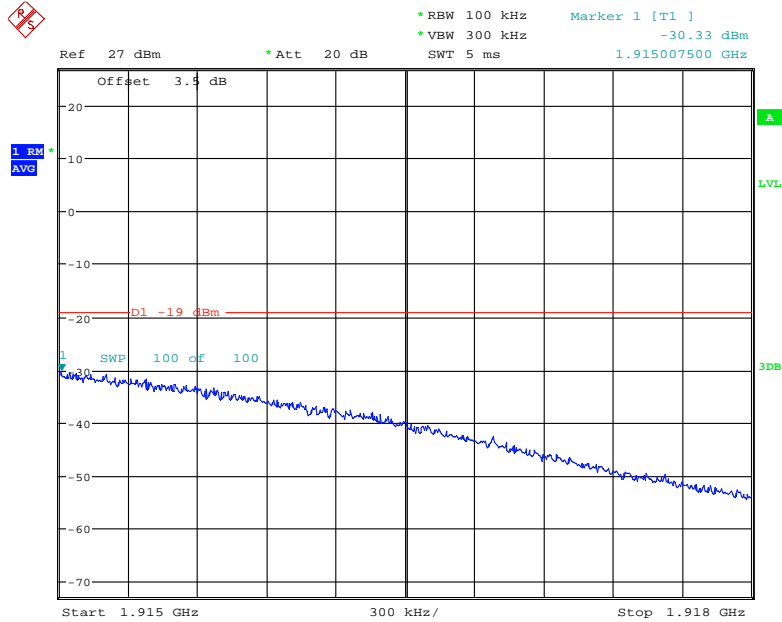

Date: 30.JUL.2019 18:16:19

### PCS Band LTE Right Side Above AGC

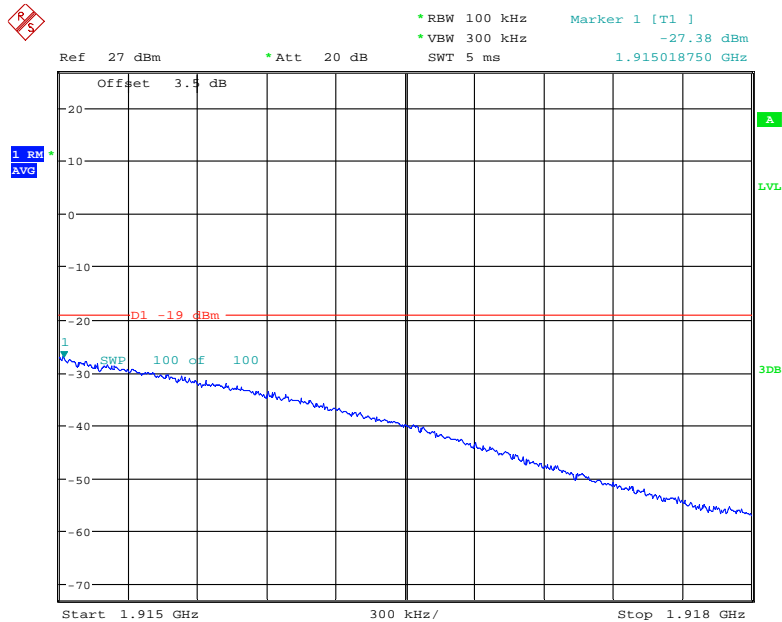

Date: 30.JUL.2019 18:23:12

### AWS Band CDMA Left Side Pre-AGC

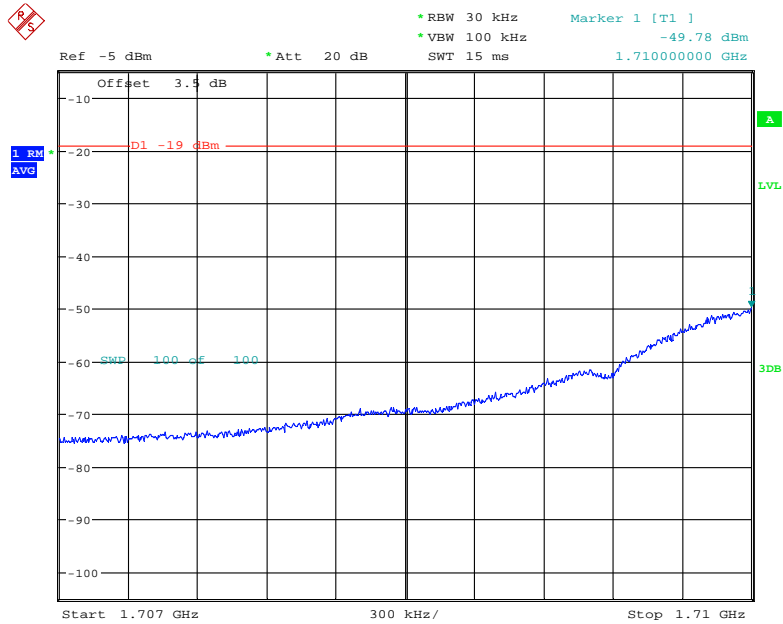

Date: 8.AUG.2019 14:48:29

### AWS Band CDMA Left Side Above AGC

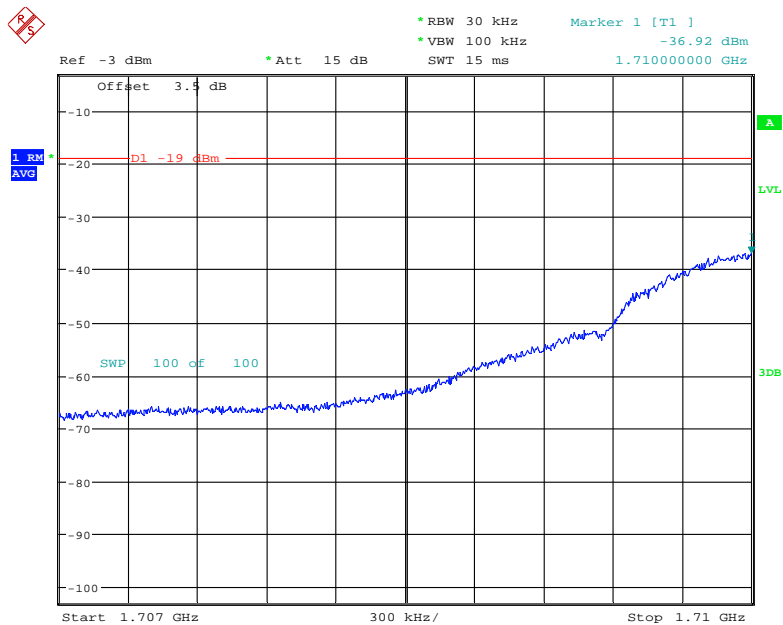

Date: 8.AUG.2019 13:57:34

### AWS Band GSM Left Side Pre-AGC

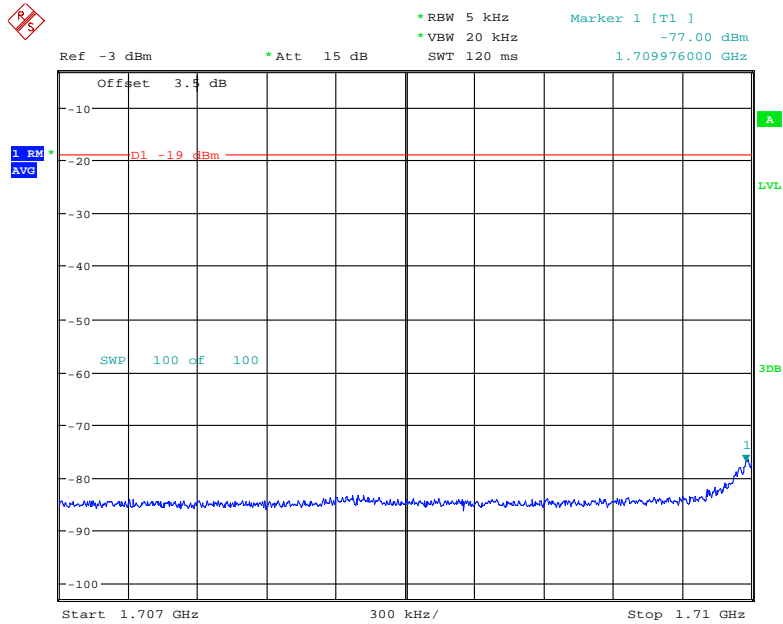

Date: 8.AUG.2019 13:41:39

### AWS Band GSM Left Side Above AGC

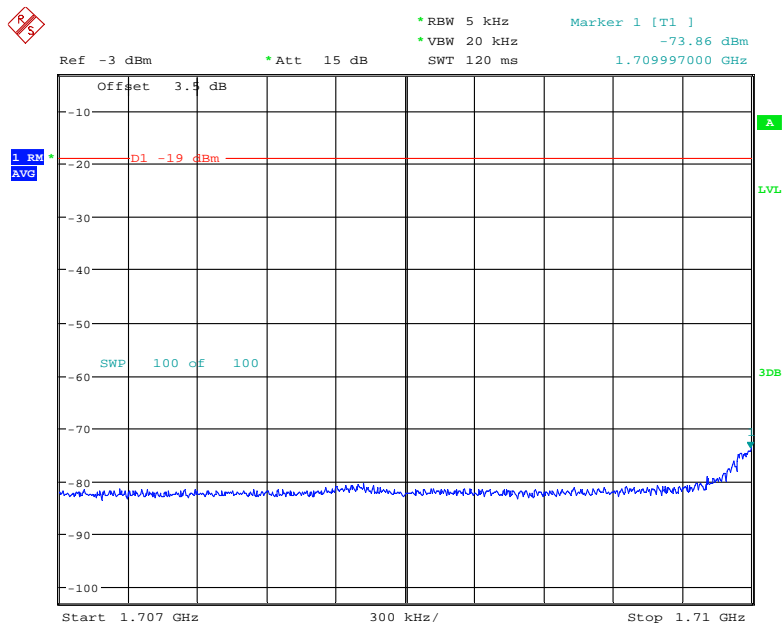

Date: 8.AUG.2019 13:41:56

### AWS Band LTE Left Side Pre-AGC

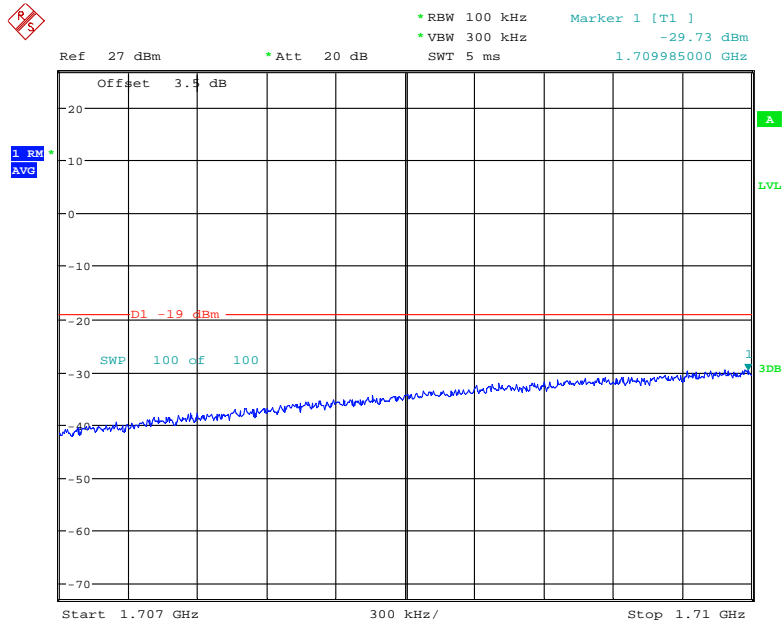

Date: 30.JUL.2019 18:25:39

### AWS Band LTE Left Side Above AGC

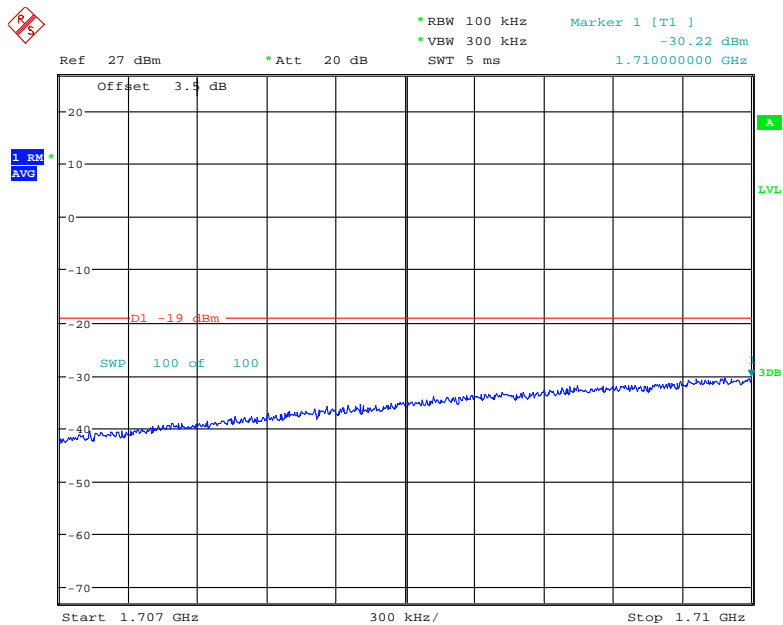

Date: 30.JUL.2019 18:26:29

### AWS Band CDMA Right Side Pre-AGC

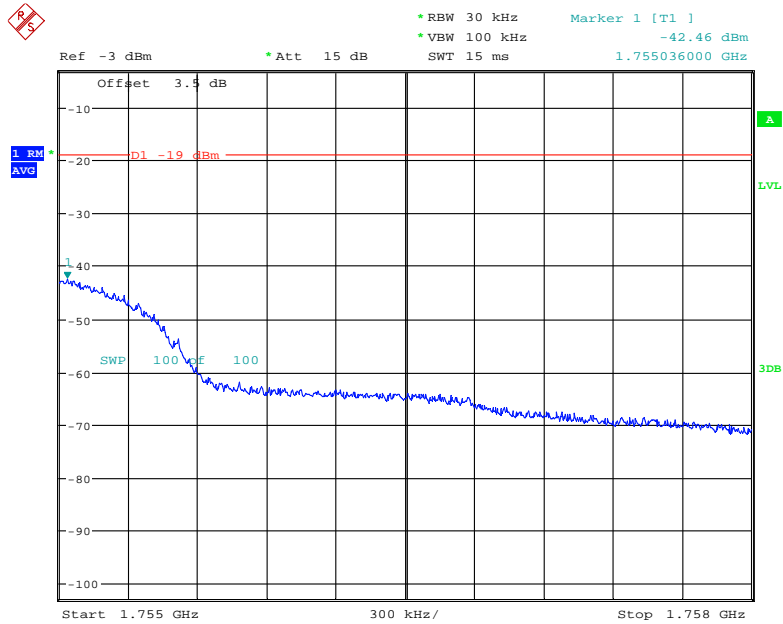

Date: 8.AUG.2019 13:59:32

### AWS Band CDMA Right Side Above AGC

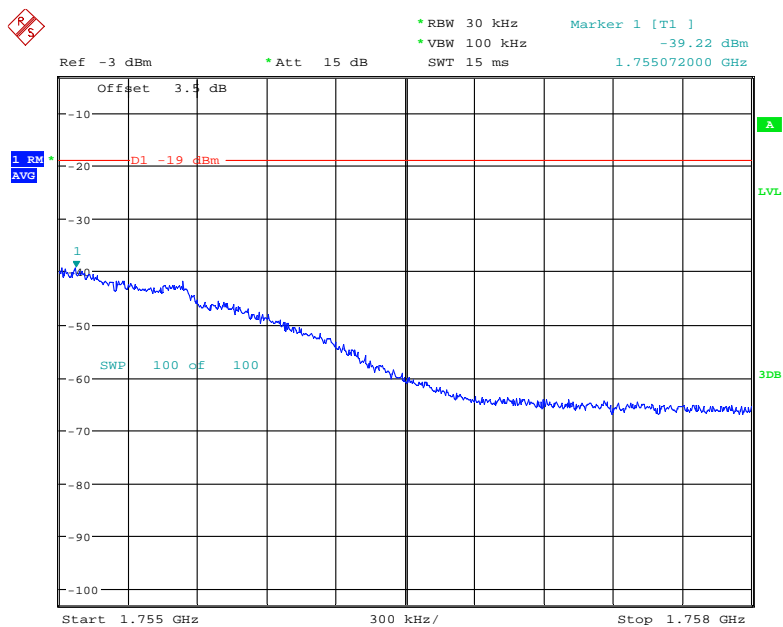

Date: 8.AUG.2019 13:59:08

### AWS Band GSM Right Side Pre-AGC

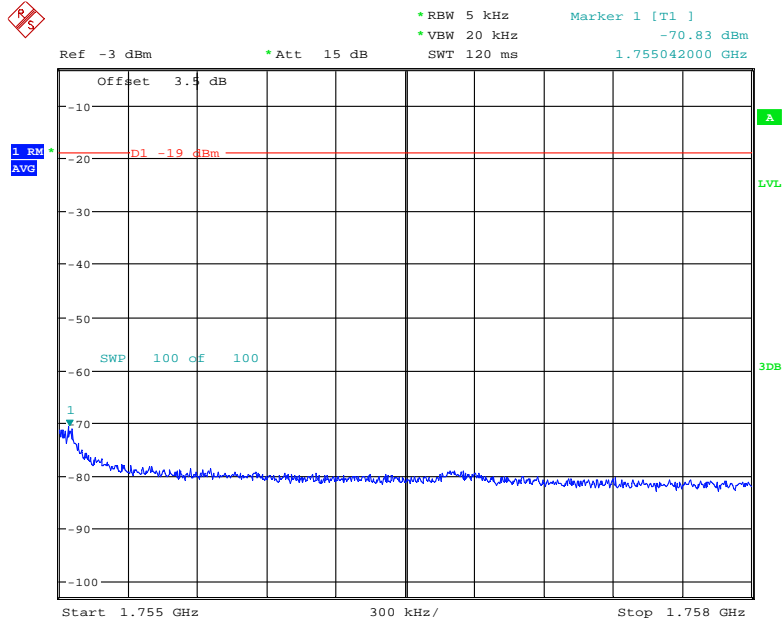

Date: 8.AUG.2019 13:42:31

### AWS Band GSM Right Side Above AGC

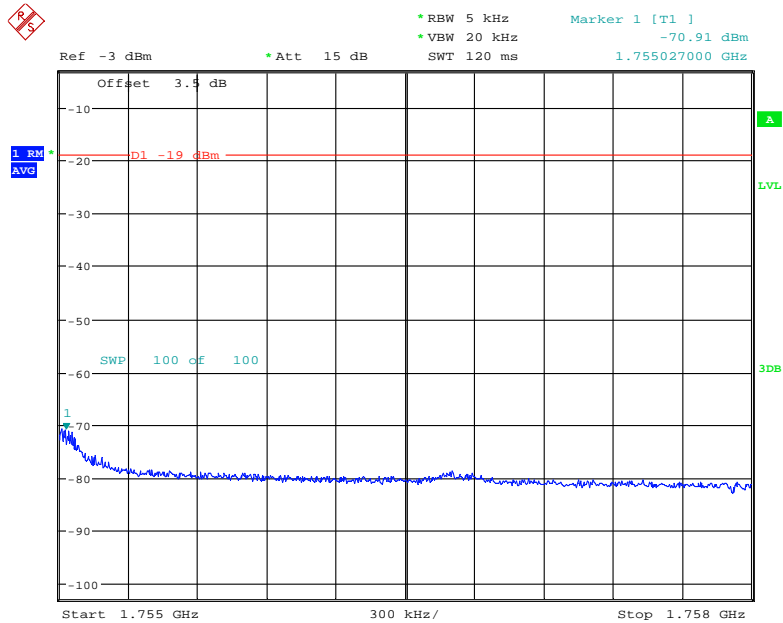

Date: 8.AUG.2019 13:42:47



### AWS Band LTE Right Side Pre-AGC

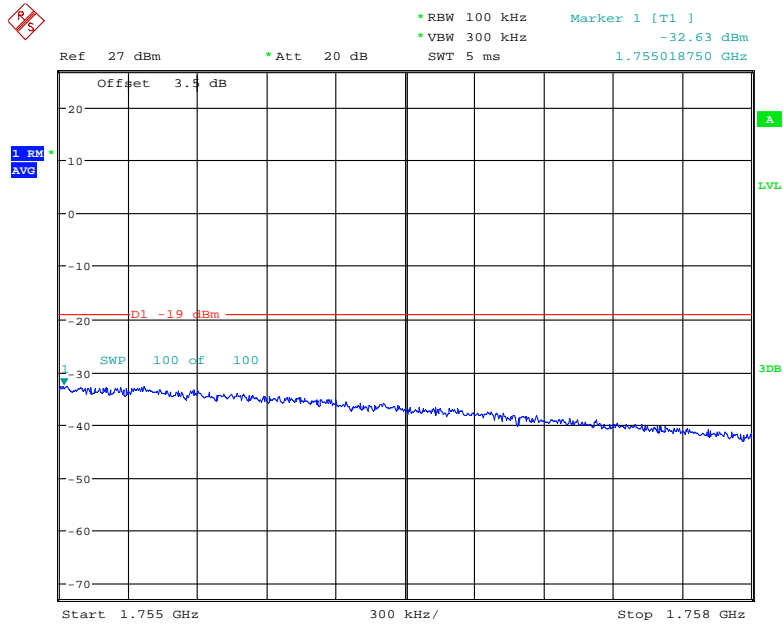

Date: 30.JUL.2019 18:29:10

### AWS Band LTE Right Side Above AGC

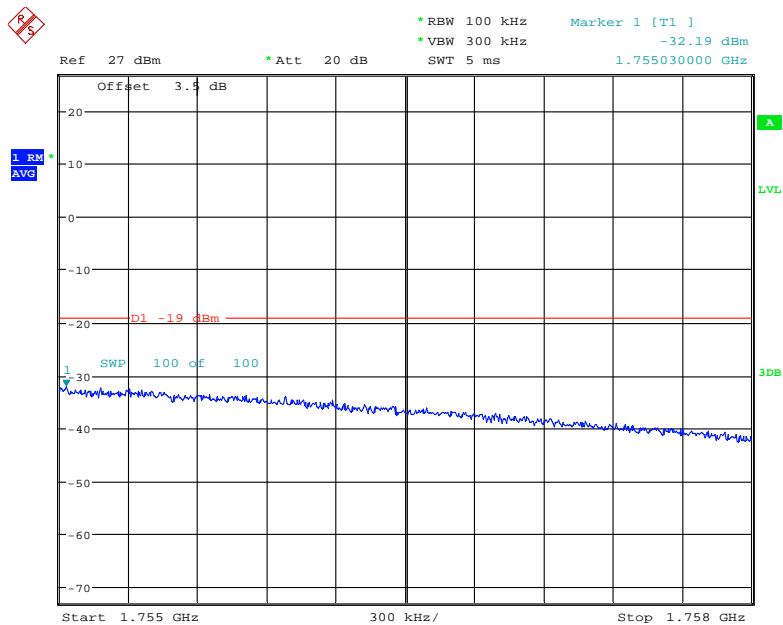

Date: 30.JUL.2019 18:29:56

## § 20.21(e)(8)(i)(A), § 20.21(e)(8)(i)(H) & § 20.21(e)(4) - NOISE LIMITS

### Applicable Standards

According to § 20.21(e)(8)(i)(A) Noise Limits; § 20.21(e)(8)(i)(H) Transmit Power Off Mode (uplink and downlink noise power); § 20.21(e)(4) Self-monitoring.

### Test Procedure

Maximum transmitter noise power level

- a) Connect the EUT to the test equipment as shown in **Figure 3**. Begin with the uplink output connected to the spectrum analyzer. When measuring downlink noise, connect the downlink output to the spectrum analyzer.
- b) Set the spectrum analyzer RBW to 1 MHz with the VBW  $\geq 3 \times$  RBW.
- c) Select the power averaging (RMS) detector and trace average over at least 100 traces.
- d) Set the center frequency of the spectrum analyzer to the center of the CMRS band under test with the span  $\geq 2 \times$  the CMRS band.
- e) Measure the maximum transmitter noise power level.
- f) Save the spectrum analyzer plot as necessary for inclusion in the final test report.
- g) Repeat 7.7b) to 7.7f) for all operational uplink and downlink bands.
- h) Connect the EUT to the test equipment as shown in **Figure 4** for uplink. Affirm the coupled path of the RF coupler is connected to the spectrum analyzer.
- i) Configure the signal generator for 4.1 MHz AWGN operation.
- j) Set the spectrum analyzer RBW for 1 MHz with the VBW  $\geq 3 \times$  RBW with a power averaging (rms) detector with at least 100 trace averages.
- k) Set the center frequency of the spectrum analyzer to the center of the CMRS band under test with the span  $\geq 2 \times$  the CMRS band. This shall include all spectrum blocks in the particular CMRS band under test (see Annex A).
- l) For uplink noise measurements, set the spectrum analyzer center frequency for the uplink band under test and tune the signal generator to the center of the paired downlink band.
- m) Measure the maximum transmitter noise power level when varying the downlink signal generator output level from  $-90$  dBm to  $-20$  dBm, as measured at the input port, in 1 dB steps inside the RSSI-dependent region and in 10 dB steps outside the RSSI-dependent region. Report the six values closest to the limit with at least two points within the RSSI-dependent region of the limit. See noise limit in Annex D.
- n) Repeat 7.7.1h) through 7.7.1m) for all operational uplink.

Variable uplink noise timing

Variable uplink noise timing is to be measured as follows.

- a) Set the spectrum analyzer to the uplink frequency to be measured.
- b) Set the span to 0 Hz with a sweep time of 10 seconds.
- c) Set the power level of signal generator 1 to the lowest level of the RSSI-dependent noise.
- d) Select MAX HOLD and increase the power level of signal generator 1 by 10 dB for mobile boosters and 20 dB for fixed boosters.
- e) Confirm that the uplink noise decreases to the specified level within 1 second for mobile devices and 3 seconds for fixed devices
- f) Repeat 7.7.2a) to 7.7.2e) for all operational uplink bands.
- g) Include plots and summary table in test report.

**Note:** Some signal boosters will require a signal generator input because they will not operate unless a signal is received at the input terminals. If this is the case, connect a second signal generator and cycle the RF output to simulate this function.

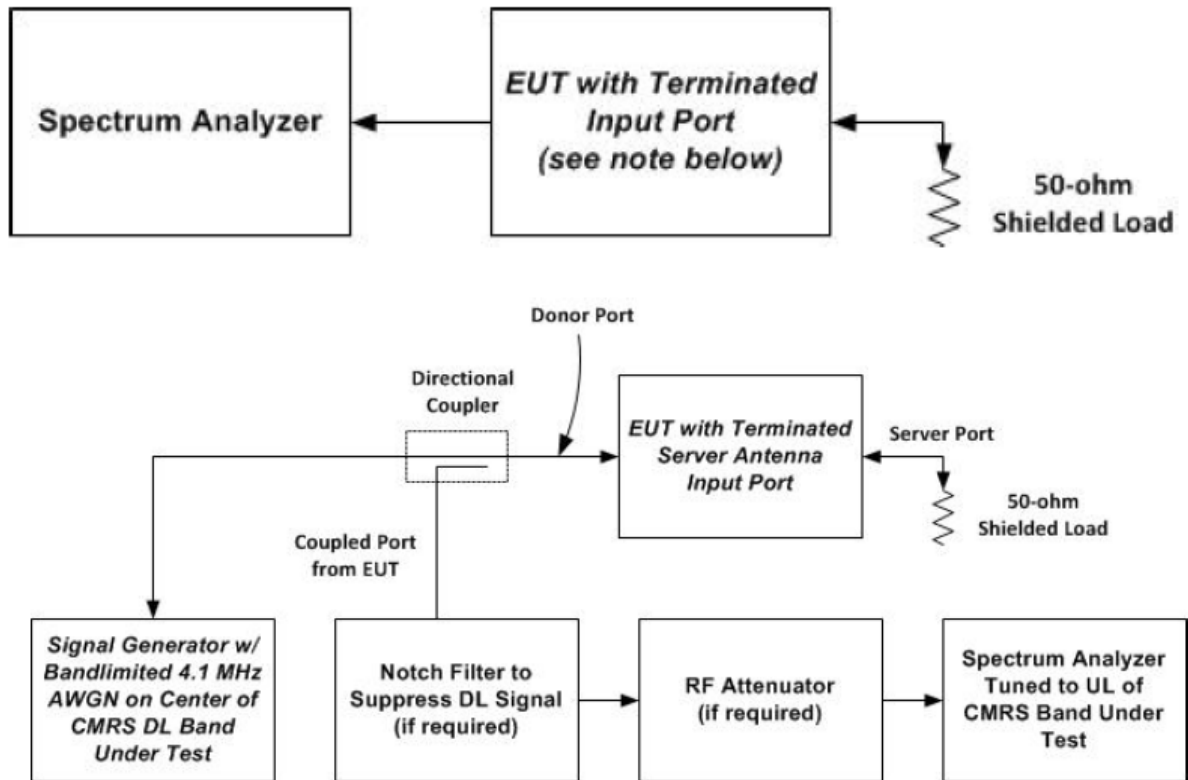

**Test Data**

**Environmental Conditions**

<b>Temperature:</b>	25 °C
<b>Relative Humidity:</b>	52 %
<b>ATM Pressure:</b>	101.2 kPa

*The testing was performed by Kieron Luo on 2019-07-30.*

**Test Result:** Compliance. Please refer to following table.

**Maximum Noise:**

Mode	Operation Bands	Measured Value	Limit	Result
		dBm/MHz	dBm/MHz	
Uplink	cellular	-61.57	-59	Compliance
	PCS	-61.45	-59	Compliance
	AWS	-60.41	-59	Compliance
	Lower 700MHz	-61.79	-59	Compliance
	Upper 700MHz	-61.85	-59	Compliance
Downlink	cellular	-60.02	-59	Compliance
	PCS	-60.91	-59	Compliance
	AWS	-59.88	-59	Compliance
	Lower 700MHz	-61.18	-59	Compliance
	Upper 700MHz	-63.69	-59	Compliance

Note: Mobile booster maximum noise power shall not exceed -59 dBm/MHz.

**Variable uplink Noise limit test result:**

Operation Bands	RSSI	Measured Value	Limit	Results
	dBm	dBm/MHz	dBm/MHz	
cellular	-90	-60.30	-59	Compliance
	-60	-60.52	-59	Compliance
	-53	-60.71	-59	Compliance
	-52	-61.65	-59	Compliance
	-51	-61.74	-59	Compliance
	-50	-62.13	-59	Compliance
PCS	-90	-59.25	-59	Compliance
	-51	-59.75	-59	Compliance
	-50	-60.65	-59	Compliance
	-49	-61.45	-59	Compliance
	-48	-62.15	-59	Compliance
	-47	-62.45	-59	Compliance
AWS	-90	-59.77	-59	Compliance
	-52	-60.07	-59	Compliance
	-51	-60.57	-59	Compliance
	-50	-61.68	-59	Compliance
	-49	-62.17	-59	Compliance
	-48	-62.37	-59	Compliance
Lower 700MHz	-90	-60.72	-59	Compliance
	-60	-60.78	-59	Compliance
	-55	-60.93	-59	Compliance
	-54	-61.01	-59	Compliance
	-53	-61.92	-59	Compliance
	-52	-62.11	-59	Compliance
Upper 700MHz	-90	-60.52	-59	Compliance
	-60	-60.83	-59	Compliance
	-55	-61.01	-59	Compliance
	-53	-61.92	-59	Compliance
	-52	-62.01	-59	Compliance
	-51	-62.38	-59	Compliance

Note 1: The Limit refer to KDB935210 D03 APPENDIX D Figure D1.

Note 2: The EUT shut down before entering RSSI-dependent region, so not recorded.

Note 3: RSSI is the downlink composite received signal power in dBm at the booster donor port for all base stations in the band of operation.

### Uplink Cellular Band

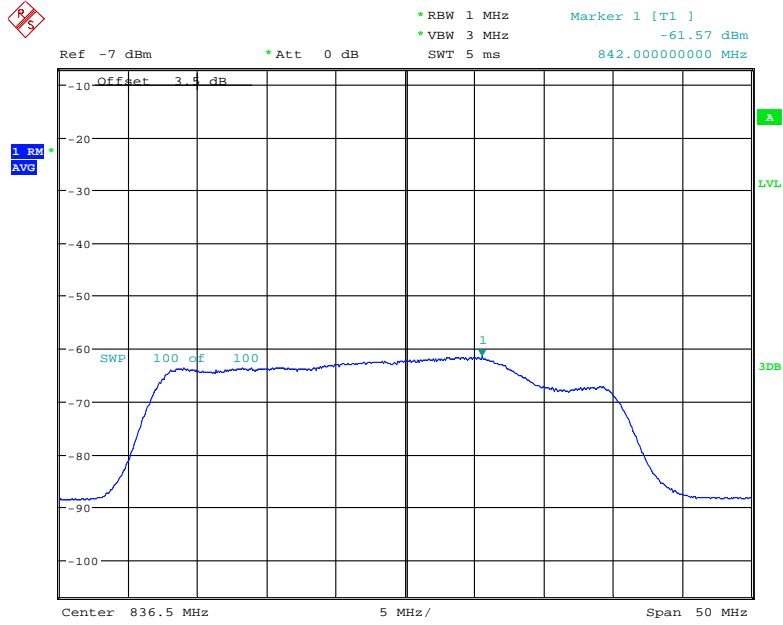

Date: 30.JUL.2019 15:07:36

### Uplink PCS Band

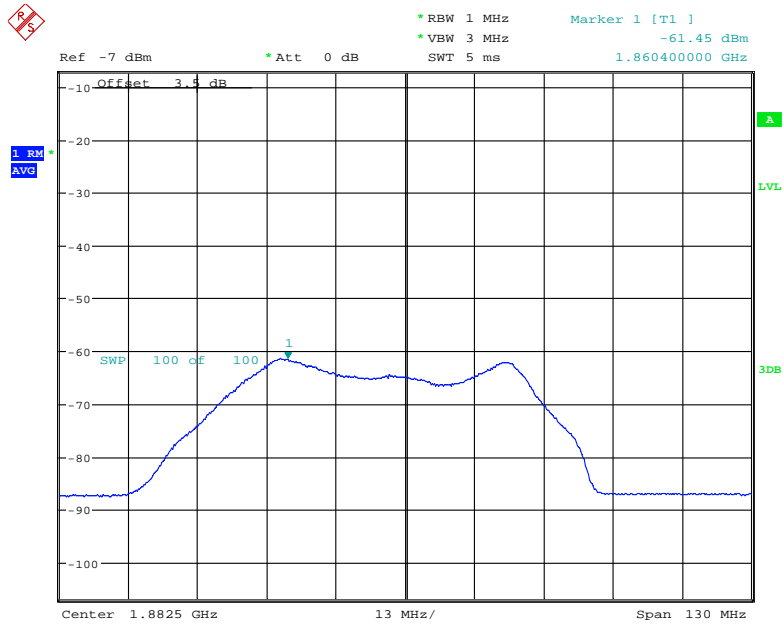

Date: 30.JUL.2019 15:06:07

### Uplink AWS

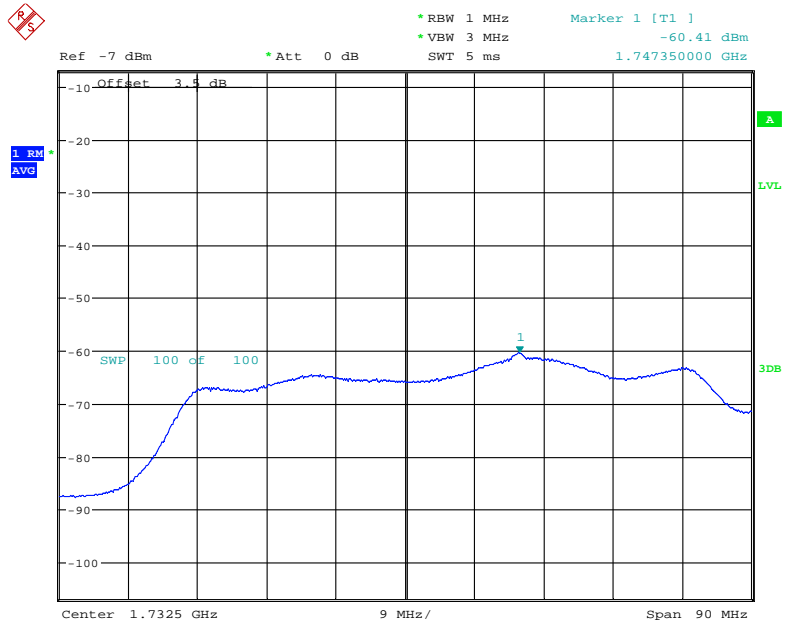

Date: 30.JUL.2019 15:08:23

### Uplink Lower 700MHz

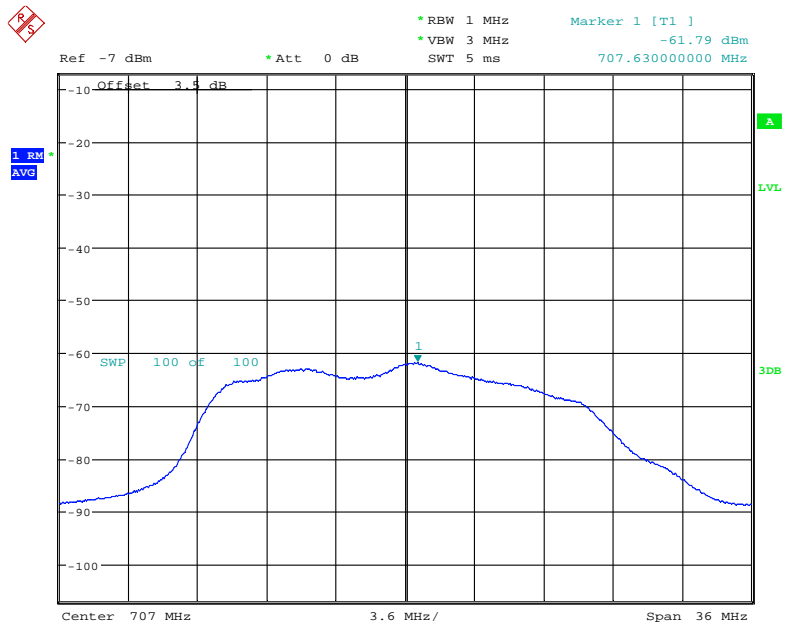

Date: 30.JUL.2019 15:09:54

### Uplink Upper 700MHz

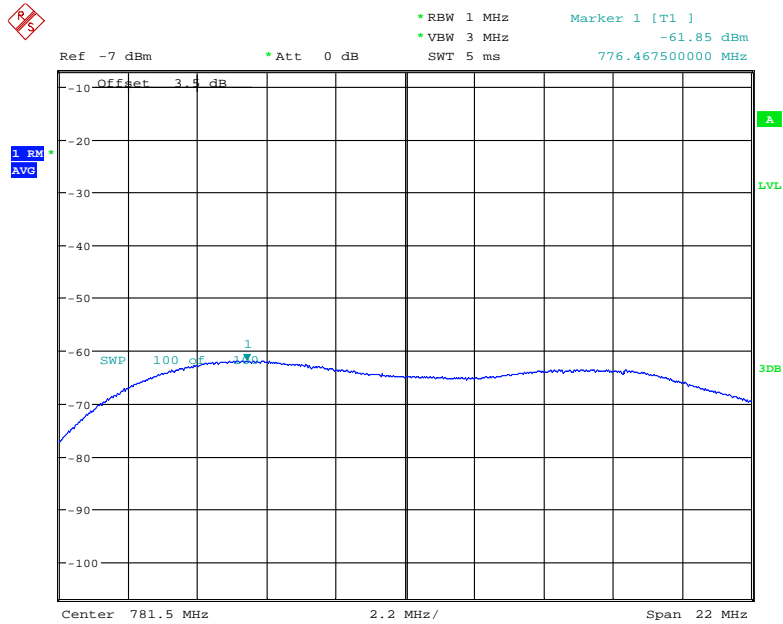

Date: 30.JUL.2019 15:11:05

### Downlink Cellular Band

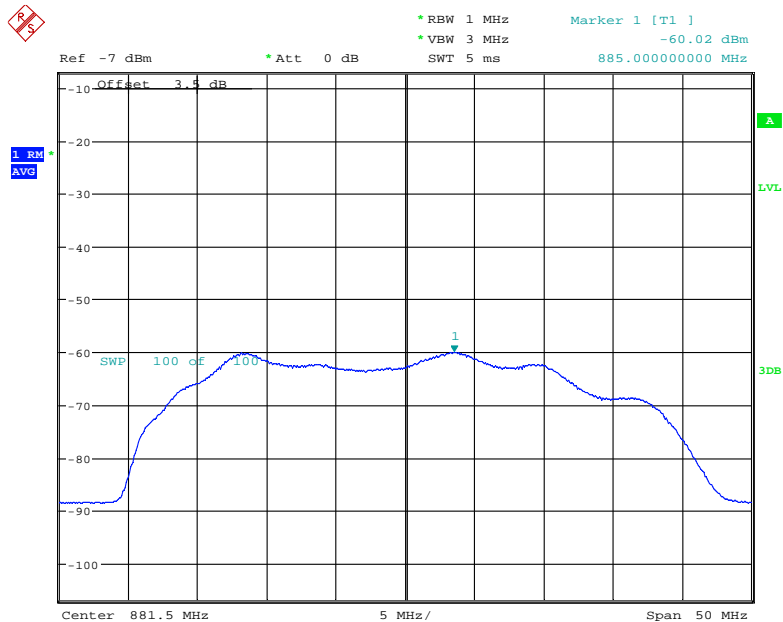

Date: 30.JUL.2019 15:15:10

### Downlink PCS Band

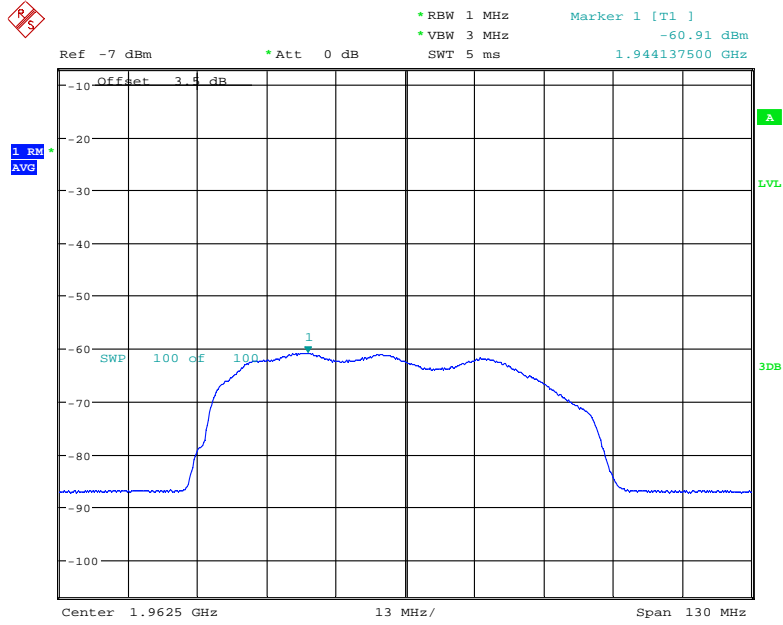

Date: 30.JUL.2019 15:16:08

### Downlink AWS Band

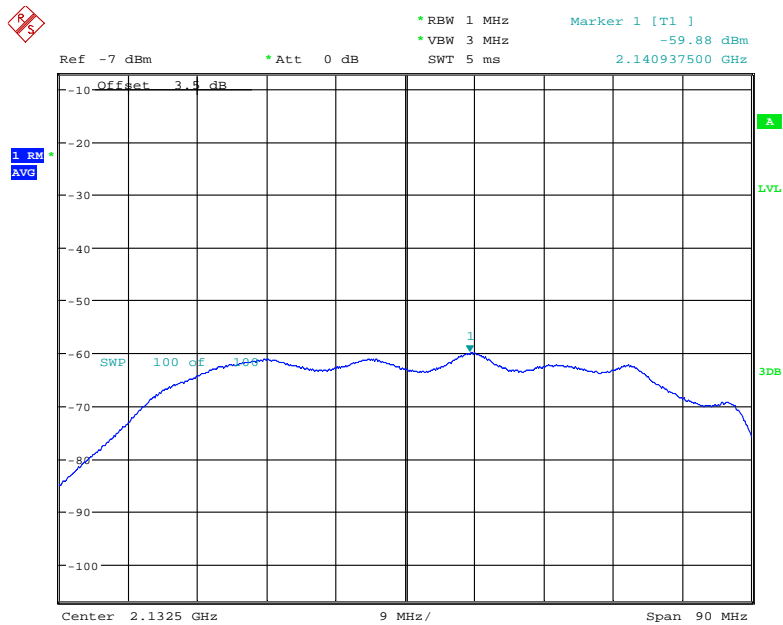

Date: 30.JUL.2019 15:14:26



### Downlink Lower 700MHz

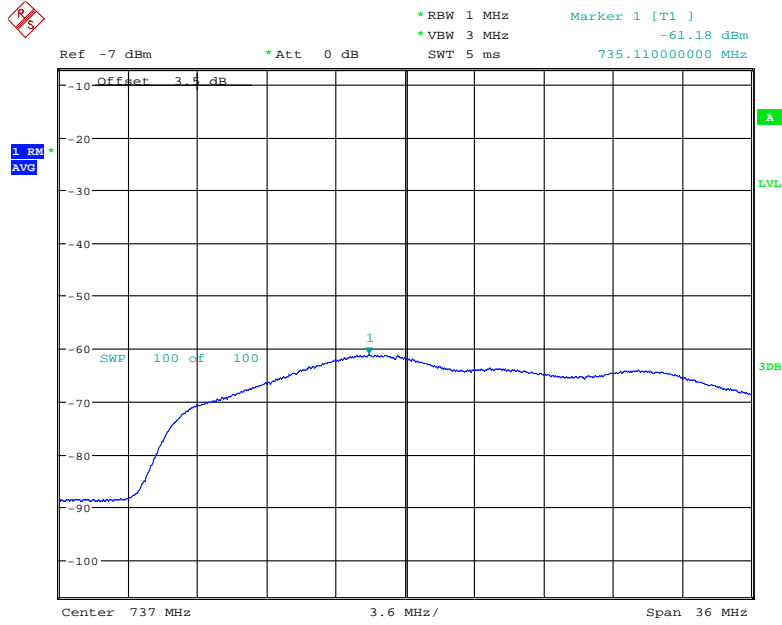

Date: 30.JUL.2019 15:13:45

### Downlink Upper 700MHz

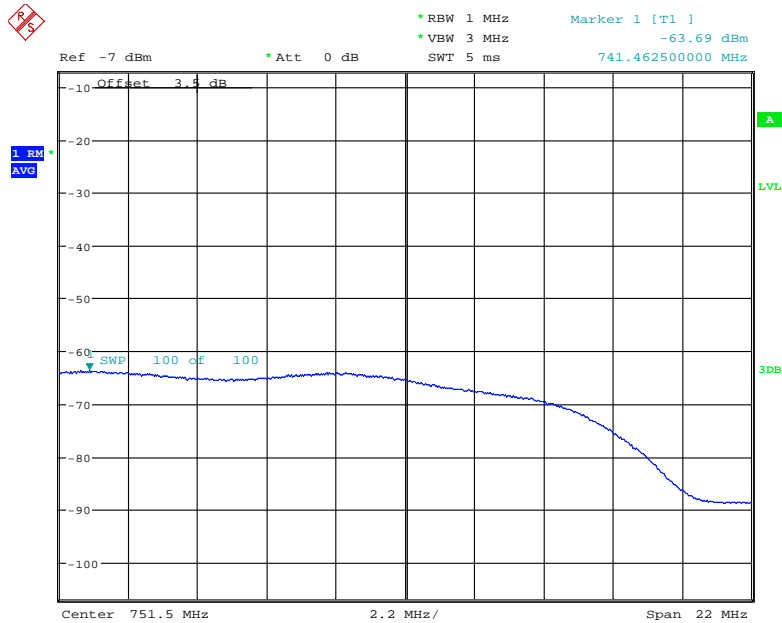

Date: 30.JUL.2019 15:13:13

**Variable Uplink Noise Timing:**

Operating Band	Measured Value	Limit	Results
	s	s	
PCS	0.057	1	Compliance
cellular	0.016	1	Compliance
AWS	0.032	1	Compliance
Lower 700MHz	0.022	1	Compliance
Upper 700MHz	0.016	1	Compliance

Note: The uplink noise decreases to the specified level within 1 second for mobile devices and 3 seconds for fixed devices.

**Cellular Band**

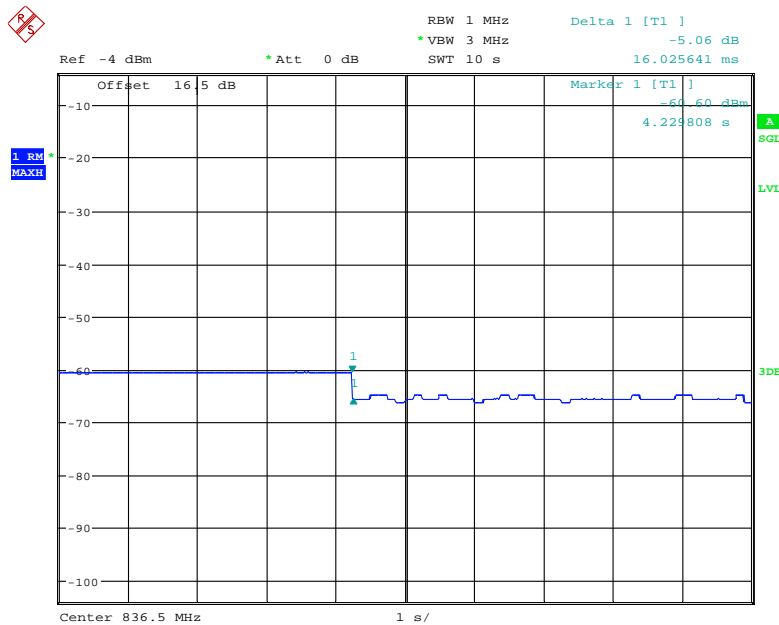

Date: 30.JUL.2019 17:14:09

### PCS Band

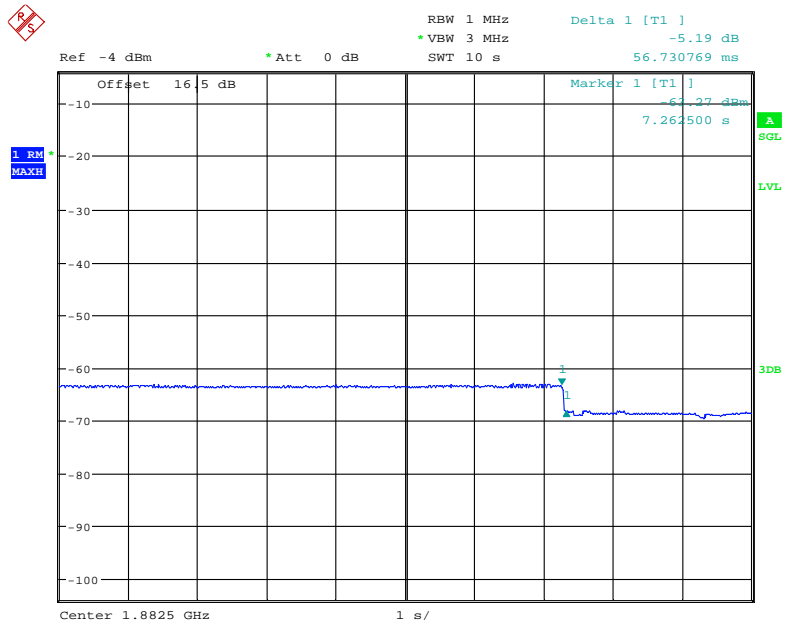

Date: 30.JUL.2019 17:08:47

### AWS Band

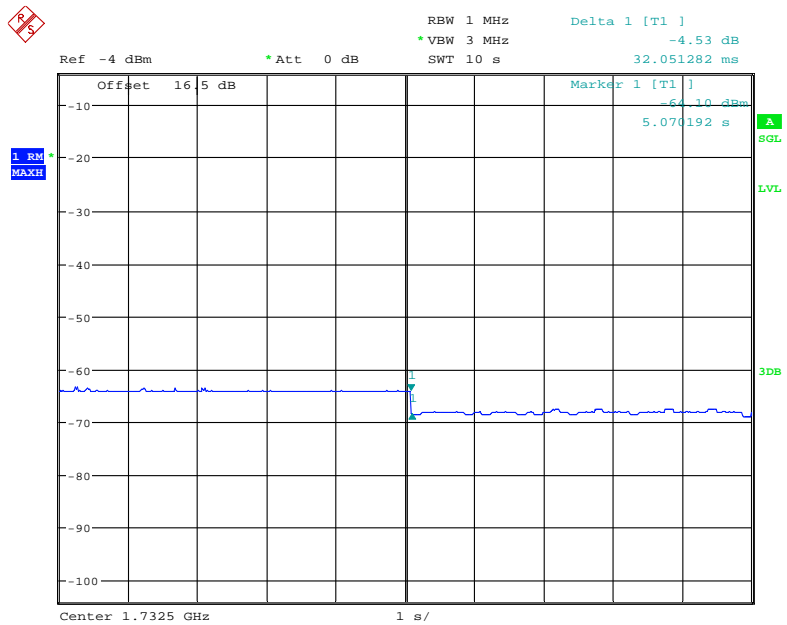

Date: 30.JUL.2019 17:15:39

### Lower 700MHz

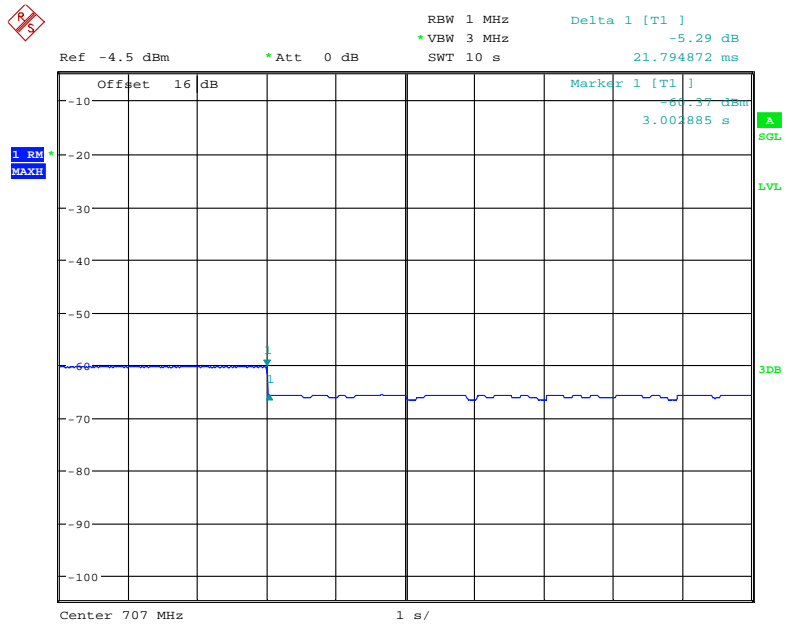

Date: 30.JUL.2019 17:16:48

### Upper 700MHz

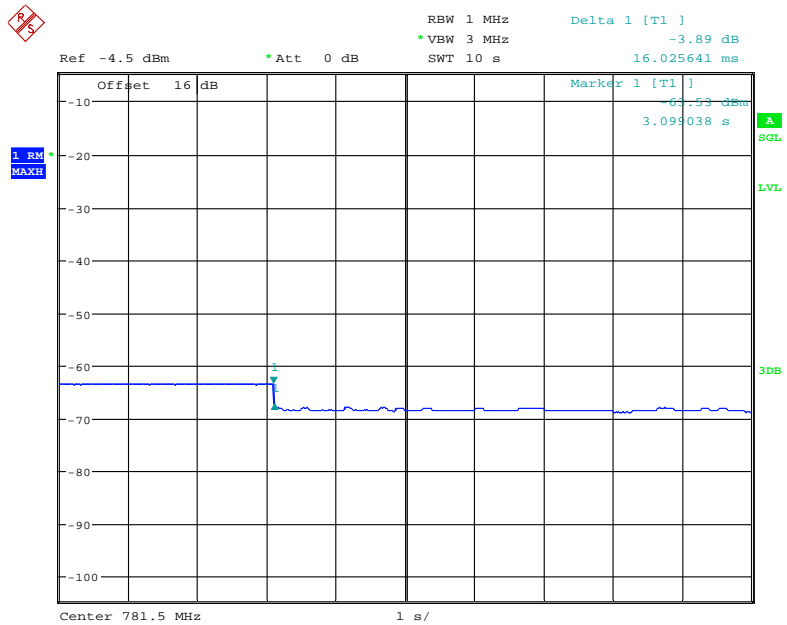

Date: 30.JUL.2019 17:17:56

## § 20.21(e)(8)(i)(I) & §20.21(e)(4) - UPLINK INACTIVITY

### Applicable Standards

According to § 20.21(e)(8)(i)(I) Uplink Inactivity & §20.21(e)(4); §20.21(e)(4) Self-monitoring.

### Test Procedure

This measurement procedure is intended to demonstrate compliance to the uplink inactivity requirements specified for wideband consumer signal boosters in § 20.21(e)(8)(i)(I).

- a) Connect the EUT to the test equipment as shown in **Figure 3** with the uplink output connected to the spectrum analyzer.
- b) Select the RMS power averaging detector.
- c) Set the spectrum analyzer RBW for 1 MHz with the  $VBW \geq 3 \times RBW$ .
- d) Set the center frequency of the spectrum analyzer to the center of the uplink operational band.
- e) Set the span for 0 Hz with a single sweep time for a minimum of 330 seconds.
- f) Start to capture a new trace using MAX HOLD.
- g) After approximately 15 seconds turn on the EUT power.
- h) Once the full spectrum analyzer trace is complete place a MARKER on the leading edge of the pulse and use the DELTA MARKER METHOD to measure the time until the uplink becomes inactive.
- i) Affirm that the noise level for the squelched signal is below the uplink inactivity noise power limit, as specified by the rules.
- j) Capture the plot for inclusion in the test report.
- k) Measure noise using procedures in 7.7.1a) to 7.7.1f).
- l) Repeat 7.8d) through 7.8k) for all operational uplink bands.

**Note:** Some signal boosters will require a signal generator input because they will not operate unless a signal is received at the input terminals. If this is the case, connect a signal generator and cycle the RF output to simulate this function.

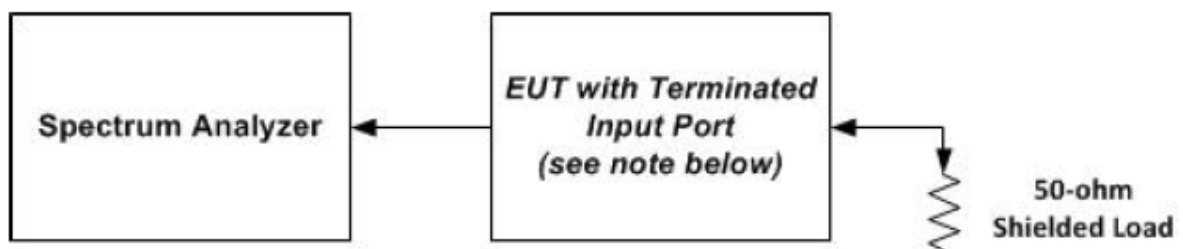

**Test Data**

**Environmental Conditions**

<b>Temperature:</b>	23~25 °C
<b>Relative Humidity:</b>	50~52 %
<b>ATM Pressure:</b>	101.0~101.2 kPa

The testing was performed by Kieron Luo on 2019-08-02.

**Test Result:** Compliance. Please refer to following table.

Operation Band	Measured value	Limit	Result
	s	s	
cellular	295.96	300	Compliance
PCS	297.21		Compliance
AWS	296.15		Compliance
Lower 700MHz	295.63		Compliance
Upper 700MHz	295.63		Compliance

Note: When the consumer booster is not serving an active device connection after 5 minutes the uplink noise power not exceed -70 dBm/MHz.

**Cellular Band**

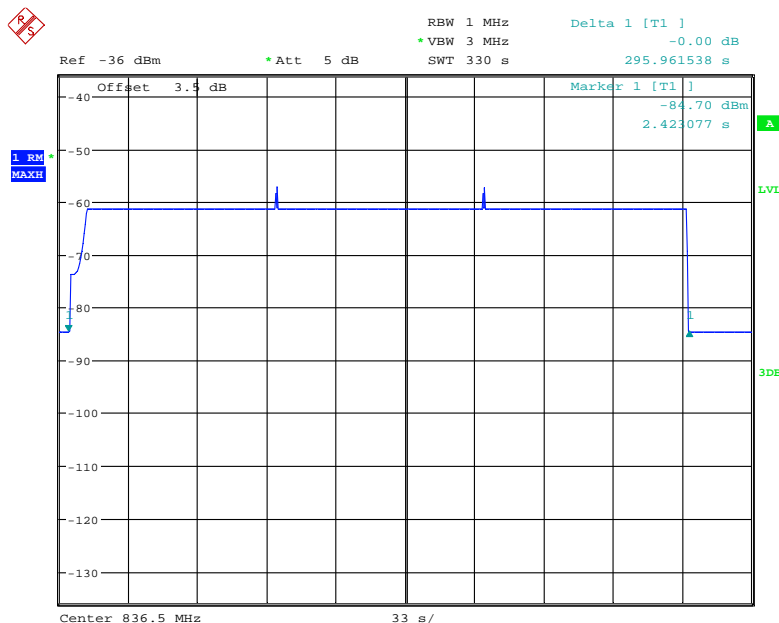

Date: 2.AUG.2019 14:09:33

### PCS Band

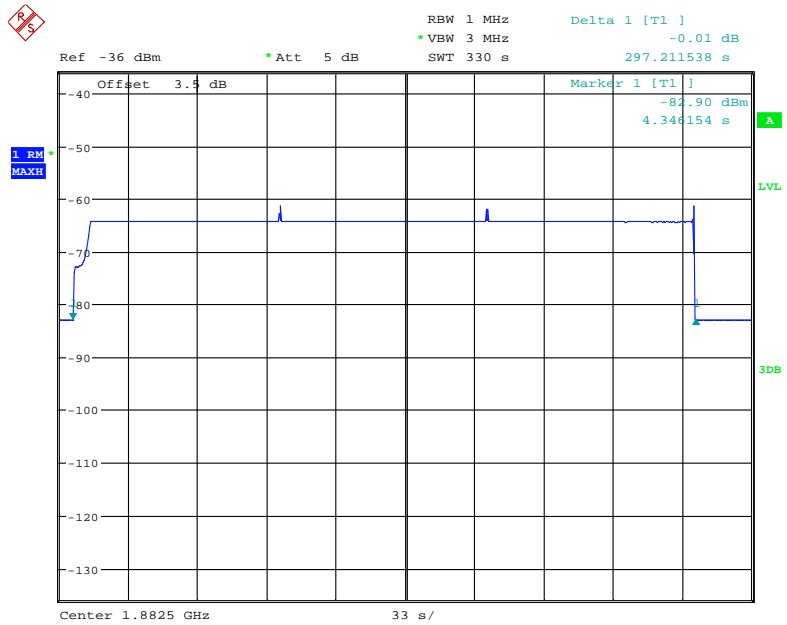

Date: 2.AUG.2019 14:16:04

### AWS Band

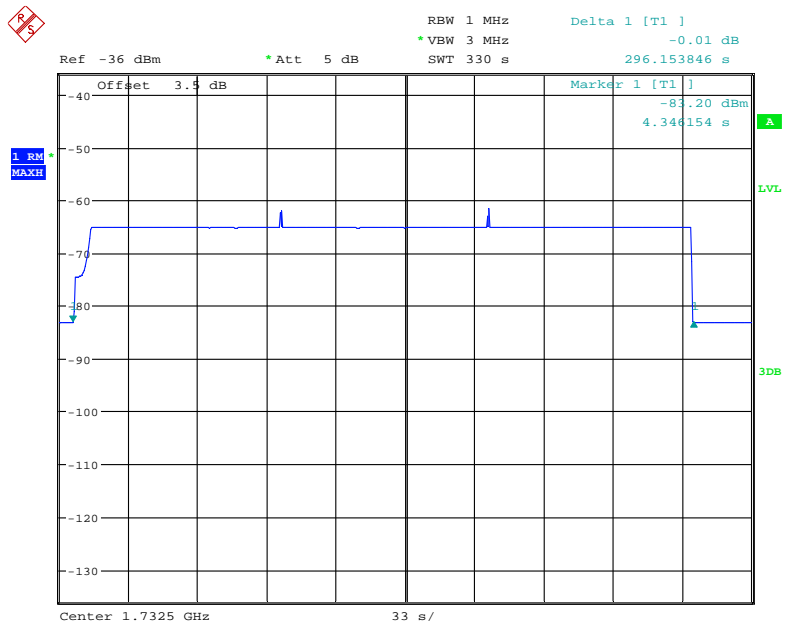

Date: 2.AUG.2019 14:54:19

### Lower 700MHz

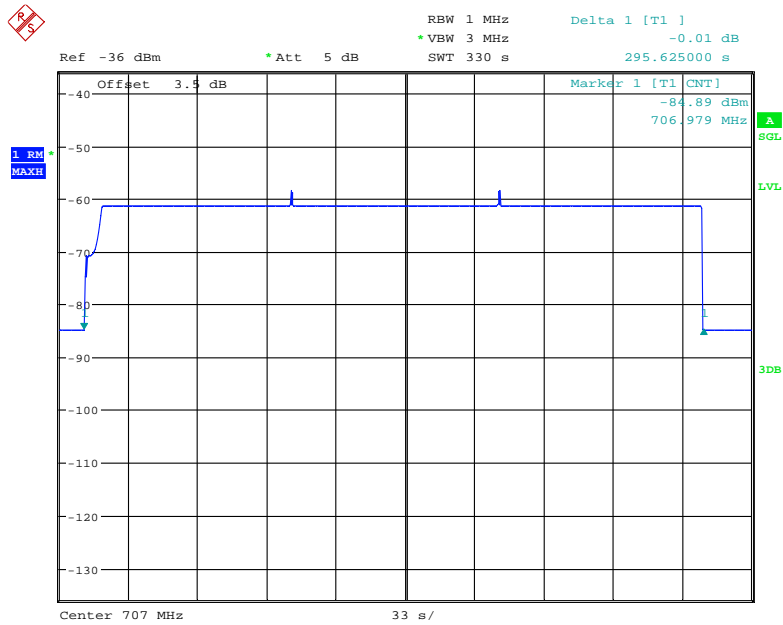

Date: 2.AUG.2019 15:07:14

### Upper 700MHz

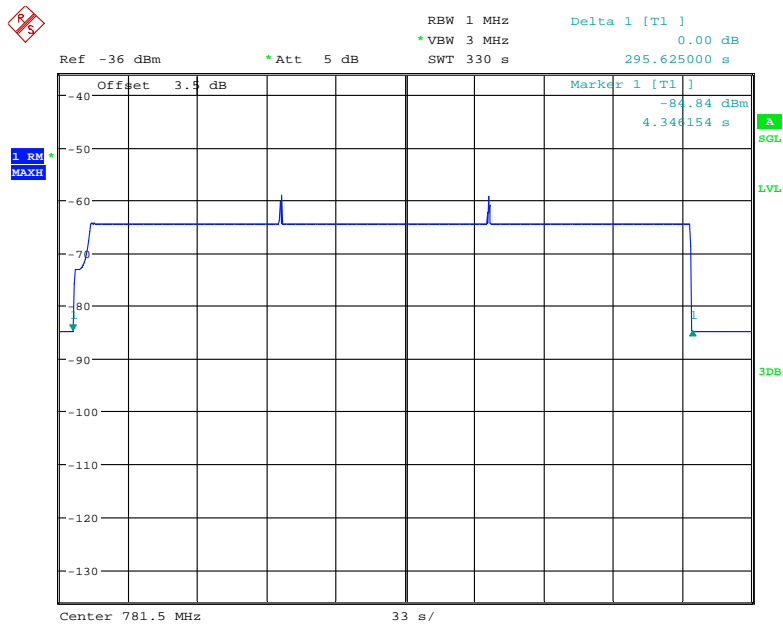

Date: 2.AUG.2019 15:13:19



## **§ 20.21(e)(8)(i)(C)(1) & § 20.21(e)(8)(i)(H) - VARIABLE BOOSTER GAIN**

### **Applicable Standards**

Rule paragraph(s): § 20.21(e)(8)(i)(C)(1) *Booster Gain Limits* (variable gain); § 20.21(e)(8)(i)(H) *Transmit Power Off Mode* (uplink gain).

### **Test Procedure**

#### **Maximum gain**

This procedure shall be used to demonstrate compliance to the booster gain limits specified for wideband consumer signal boosters in § 20.21(e)(8)(i)(C) or § 20.21(e)(8)(i)(H). The variable booster gain limits are expressed as a function of RSSI and MSCL. The RSSI is varied over a range of values as specified within the procedure. Refer to Annex B of this document for guidance on determining the applicable MSCL value.

- a) Connect the EUT to the test equipment as shown in **Figure 5** with the uplink output connected to signal generator 1. Confirm that the coupled path of the RF coupler is connected to the spectrum analyzer.
- b) Configure downlink signal generator 1 for AWGN operation with a 99% occupied bandwidth of 4.1 MHz tuned to the center of the operational band.
- c) Set the power level and frequency of signal generator 2 to a value 5 dB below the AGC level determined from 7.2. The signal type is AWGN with a 99% OBW of 4.1 MHz.
- d) Set RBW = 100 kHz.
- e) Set VBW  $\geq$  300 kHz.
- f) Select the CHANNEL POWER measurement mode.
- g) Select the RMS (power averaging) detector.
- h) Ensure that the number of measurement points per sweep  $\geq (2 \times \text{span})/\text{RBW}$ .
- i) Sweep time = auto couple or as necessary (but no less than auto couple value).
- j) Trace average at least 10 traces in power averaging (i.e., RMS) mode.
- k) Measure the maximum channel power and compute maximum gain when varying the signal generator 1 output to a level from -90 dBm to -20 dBm as measured at the input port in 1 dB steps inside the RSSI-dependent region and 10 dB steps outside the RSSI-dependent region and report the six values closest to the limit, including at least two points from within the RSSI-dependent region of operation. See gain limit in charts in Annex D for uplink gain requirements. Additionally, document that the EUT provides equivalent uplink and downlink gain, and when operating in shutoff mode the uplink and downlink gain is within the transmit power off mode gain limits.
- l) Repeat 7.9.1b) to 7.9.1k) for all operational uplink bands.

#### **Variable uplink gain timing**

Variable uplink gain timing is to be measured as follows.

- a) Set the spectrum analyzer to the uplink frequency to be measured.
- b) Set the span to 0 Hz with a sweep time of 10 seconds.
- c) Set the power level of signal generator 1 to the lowest level of the RSSI-dependent gain.
- d) Select MAX HOLD and increase the power level of signal generator 1 by 10 dB for mobile boosters and 20 dB for fixed indoor boosters. Signal generator 2 remains same, as described in 7.9.1c).
- e) Confirm that the uplink gain decreases to the specified levels within 1 second for mobile devices and 3 seconds for fixed devices.
- f) Repeat 7.9.2a) to 7.9.2e) for all operational uplink bands.

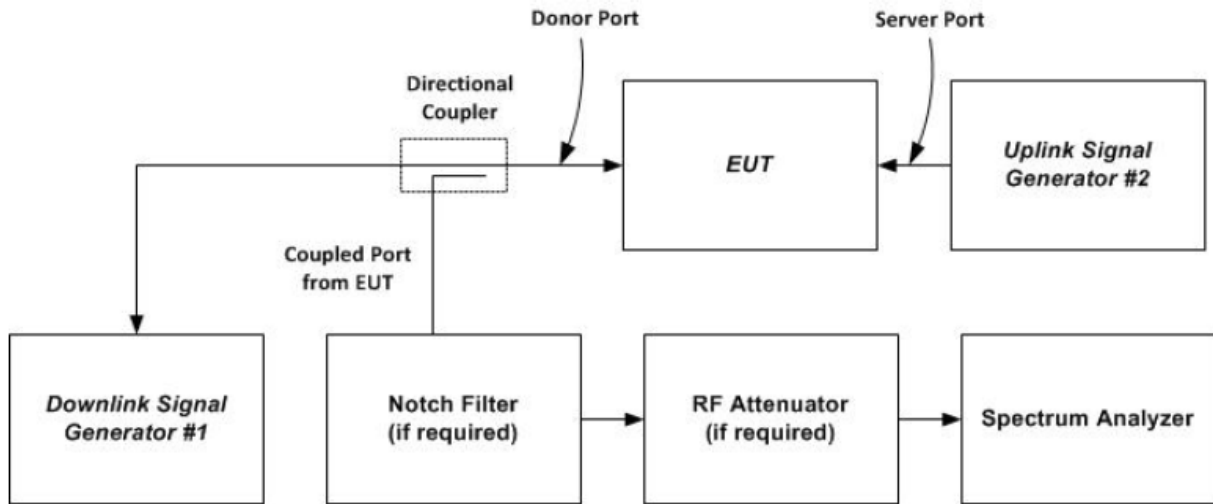

Figure 5 – Variable gain instrumentation test setup

**Test Data**

**Environmental Conditions**

<b>Temperature:</b>	24 °C
<b>Relative Humidity:</b>	52 %
<b>ATM Pressure:</b>	101.2 kPa

The testing was performed by Kieron Luo on 2019-08-08.

**Test Result:** Compliance. Please refer to following table.

**MSCL calculation:**

Operation Bands	Frequency	Distance	Path Loss	Indoor Antenna Gain	Indoor Cable Loss	Polarity Loss	MSCL
	MHz						
Cellular	836.5	0.5	24.93	-1.5	0	3.01	29.44
PCS	1882.5	0.5	31.97	2.5	0	3.01	32.48
AWS	1732.5	0.5	31.25	2	0	3.01	32.26
Upper 700MHz	781.5	0.5	24.34	-1.5	0	3.01	28.85
Lower 700MHz	707.0	0.5	23.47	-1.5	0	3.01	27.98

Note:

Path loss=20logf+20logd-27.50

Polarity loss=20log(1/sin(45))=3.01

MSCL= Path loss + Indoor Cable Loss - Mobile Antenna Gain- Indoor Antenna Gain+ Polarity Loss

Mobile Antenna Gain=0

The above table was list the lowest MSCL value using all the authorized antennas and cables.

**Variable booster gain:**

Operation Bands	RSSI	P <sub>in</sub>	P <sub>out</sub>	MSCL	Measured Value	Limit	Result
	dBm	dBm	dBm	dB	dB	dB	
Cellular	-58	-36.45	13.2	29.44	49.65	50	Compliance
	-57	-36.45	13.0	29.44	49.45	50	Compliance
	-56	-36.45	12.9	29.44	49.35	50	Compliance
	-55	-36.45	12.6	29.44	49.05	50	Compliance
	-54	-36.45	11.8	29.44	48.25	49.44	Compliance
	-53	-36.45	11.0	29.44	47.45	48.44	Compliance
PCS	-54	-36.50	13.0	32.48	49.50	50	Compliance
	-53	-36.50	12.8	32.48	49.30	50	Compliance
	-52	-36.50	12.0	32.48	48.50	50	Compliance
	-51	-36.50	11.0	32.48	47.50	49.48	Compliance
	-50	-36.50	10.0	32.48	46.50	48.48	Compliance
	-49	-36.50	9.0	32.48	45.50	47.48	Compliance
AWS	-55	-38.50	11.2	32.26	49.70	50	Compliance
	-54	-38.50	11.2	32.26	49.70	50	Compliance
	-53	-38.50	11.0	32.26	49.50	50	Compliance
	-52	-38.50	10.3	32.26	48.80	50	Compliance
	-51	-38.50	9.0	32.26	47.50	49.26	Compliance
	-50	-38.50	8.0	32.26	46.50	48.26	Compliance
Lower 700MHz	-60	-35.50	14.2	27.98	49.70	50	Compliance
	-59	-35.50	13.3	27.98	48.80	50	Compliance
	-58	-35.50	13.0	27.98	48.50	50	Compliance
	-57	-35.50	12.5	27.98	48.00	50	Compliance
	-56	-35.50	12.0	27.98	47.50	49.98	Compliance
	-55	-35.50	11.5	27.98	47.00	48.98	Compliance
Upper 700MHz	-58	-36.50	11.5	28.85	48.00	50	Compliance
	-57	-36.50	11.0	28.85	47.50	50	Compliance
	-56	-36.50	10.8	28.85	47.30	50	Compliance
	-55	-36.50	10.3	28.85	46.80	49.85	Compliance
	-54	-36.50	9.6	28.85	46.10	48.85	Compliance
	-53	-36.50	9.3	28.85	45.80	47.85	Compliance

Note 1: According to KDB 935210 D03 Signal Booster Measurements v04r03 Annex D, the Variable booster gain is -34dB-RSSI+MSCL in RSSI-Dependent Region, out of RSSI-Dependent Region, it is 50dB.

Note 2: RSSI is the downlink composite received signal power in dBm at the booster donor port for all base stations in the band of operation.

**Variable gain timing:**

<b>Operation Bands</b>	<b>Measured value</b>	<b>Limit</b>	<b>Results</b>
<b>MHz</b>	<b>s</b>	<b>s</b>	
PCS	0.027	1	Compliance
Cellular	0.020		Compliance
AWS	0.034		Compliance
Lower 700MHz	0.029		Compliance
Upper 700MHz	0.029		Compliance

Note: The uplink gain decreases to the specified level within 1 second for mobile devices and 3 seconds for fixed devices.

### Cellular Band

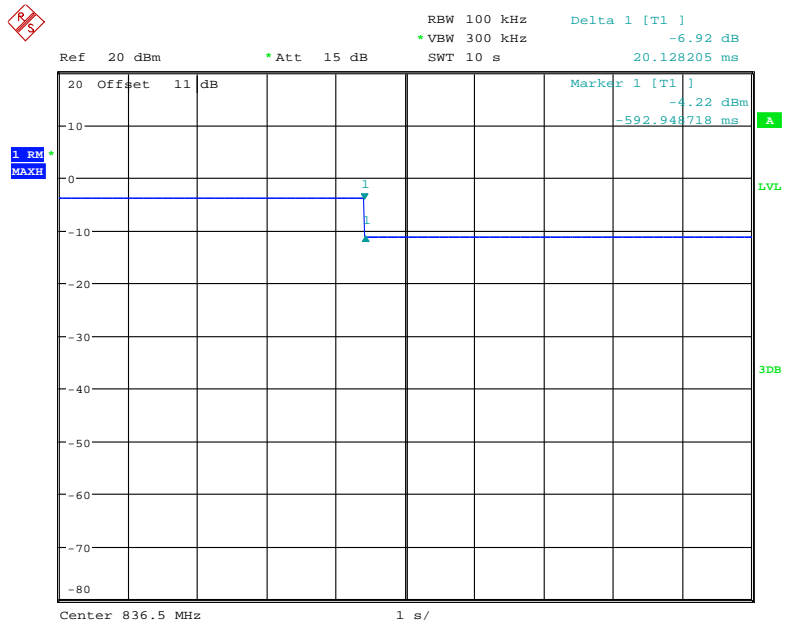

Date: 8.AUG.2019 12:21:45

### PCS Band

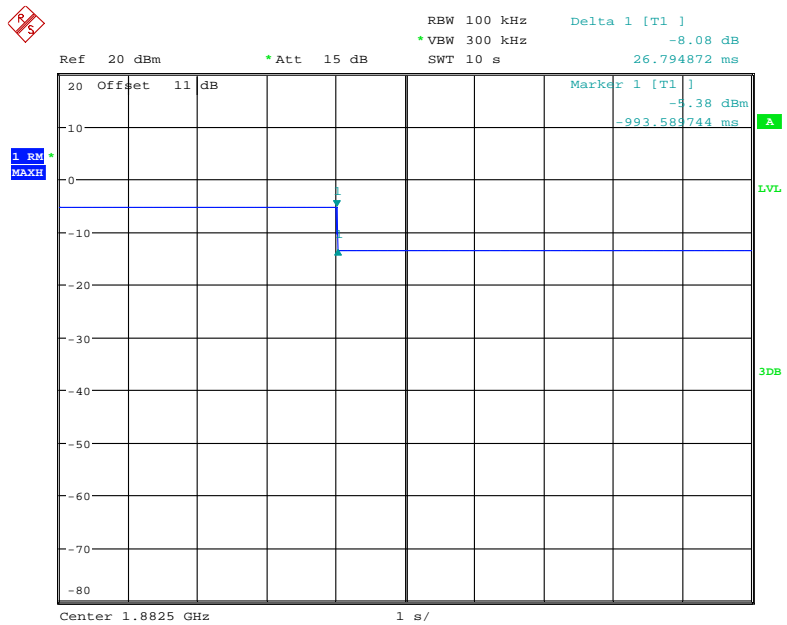

Date: 8.AUG.2019 12:26:31

### AWS Band

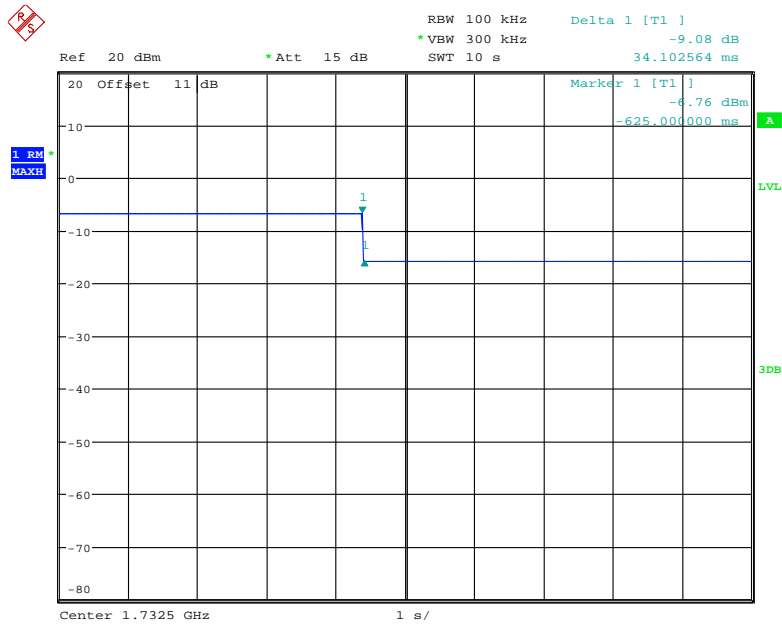

Date: 8.AUG.2019 12:27:28

### Lower 700MHz

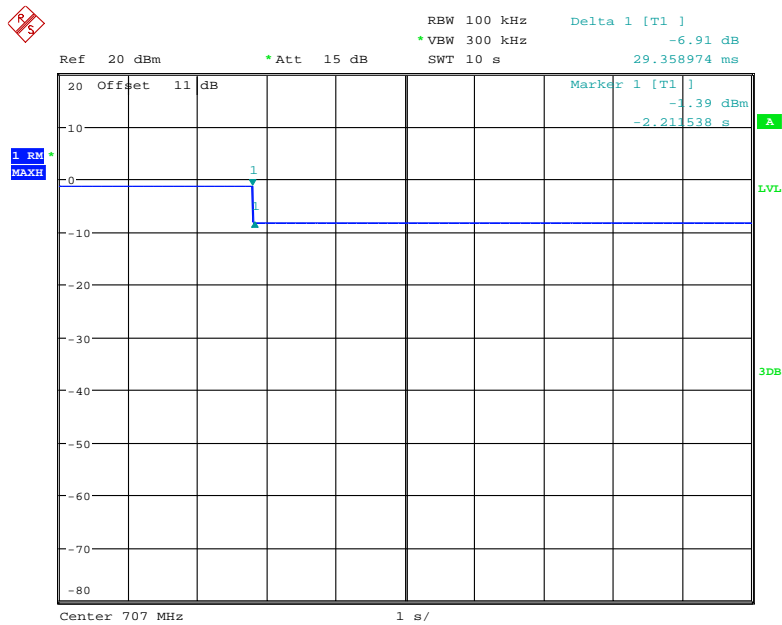

Date: 8.AUG.2019 12:25:10

### Upper 700MHz

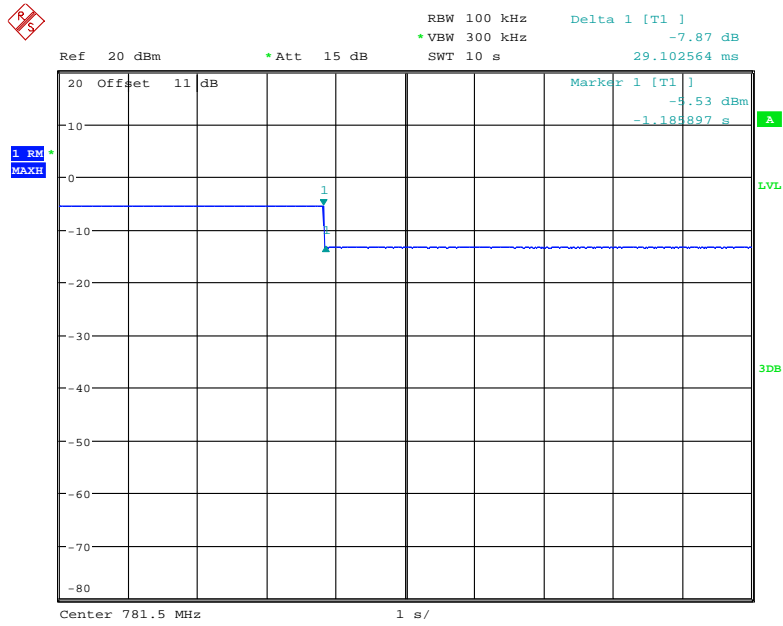

Date: 8.AUG.2019 12:29:53

## § 2.1049 - OCCUPIED BANDWIDTH

### Applicable Standards

According to § 2.1049 Measurements required: Occupied bandwidth.

### Test Procedure

This measurement is required to compare the uniformity of the output signal relative to the input signal and to satisfy the requirements of § 2.1049.

- a) Connect the test equipment as shown in **Figure 6** to measure the characteristics of the test signals produced by the signal generator.
- b) Set VBW to  $\geq 3 \times \text{RBW}$ .
- c) Set the center frequency of the spectrum analyzer to the center of the operational band. The span will be adjusted for each modulation type and occupied bandwidth as necessary for accurately viewing the signals.
- d) Set the signal generator for power level to match the values obtained in 7.2.
- e) Set the signal generator modulation type for GSM with a PRBS pattern and allow the trace on the signal generator to stabilize adjusting the span as necessary.
- f) Set the spectrum analyzer RBW for 1% to 5% of the emissions bandwidth.
- g) Capture the spectrum analyzer trace for inclusion in the test report.
- h) Repeat 7.10c) to 7.10g) for CDMA and W-CDMA modulation adjusting the span as necessary for all uplink and downlink operational bands. AWGN or LTE may be used in place of W-CDMA, as an option.
- i) Connect the test equipment as shown in **Figure 1**. Begin with the uplink output connected to the spectrum analyzer.
- j) Repeat 7.10c) to 7.10h) in this new configuration.

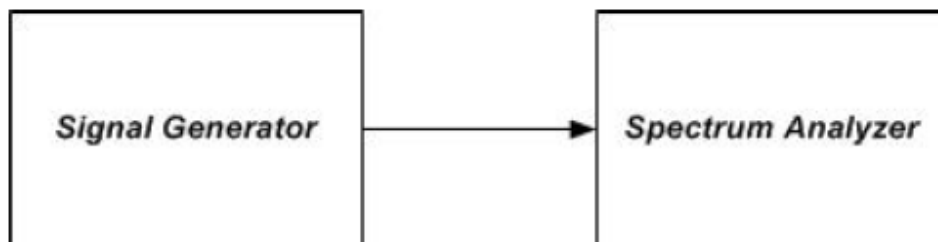

**Figure 6 – Occupied bandwidth instrumentation test setup**

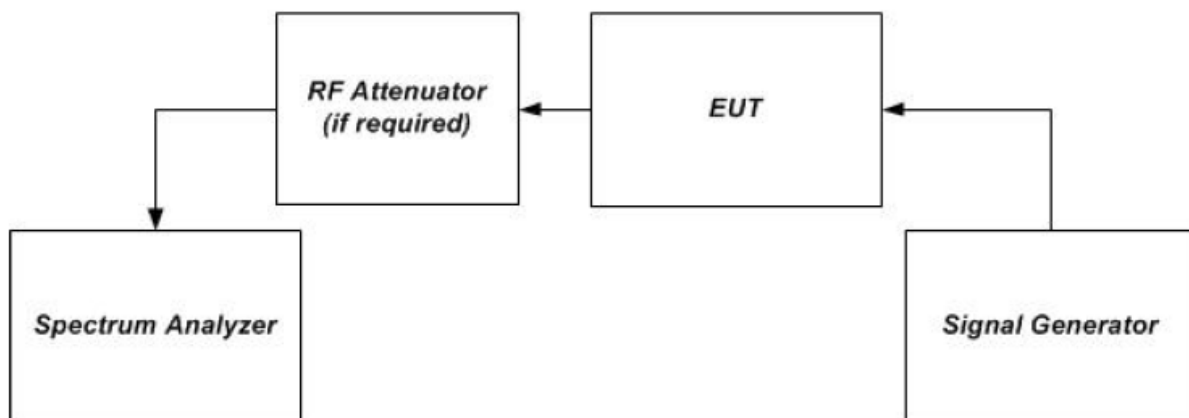

**Figure 1 – Band verification test instrumentation setup**



**Test Data**

**Environmental Conditions**

<b>Temperature:</b>	24 °C
<b>Relative Humidity:</b>	52 %
<b>ATM Pressure:</b>	101.0~101.2 kPa

*The testing was performed by Kieron Luo on 2019-08-02.*

**Test Result:** Compliance. Please refer to following table.

**Input-versus-output signal comparison**

Mode	Operation Band	Signal type	Input	Output	Results
			MHz	MHz	
Uplink	cellular	GSM	0.247	0.242	Compliance
		CDMA	1.274	1.274	Compliance
		WCDMA	4.215	4.167	Compliance
	PCS	GSM	0.244	0.245	Compliance
		CDMA	1.279	1.274	Compliance
		WCDMA	4.199	4.183	Compliance
	AWS	GSM	0.245	0.242	Compliance
		CDMA	1.279	1.279	Compliance
		WCDMA	4.215	4.215	Compliance
	Lower 700MHz	GSM	0.245	0.244	Compliance
		CDMA	1.274	1.274	Compliance
		WCDMA	4.263	4.183	Compliance
Upper 700MHz	GSM	0.245	0.245	Compliance	
	CDMA	1.274	1.274	Compliance	
	WCDMA	4.199	4.199	Compliance	
Downlink	cellular	GSM	0.247	0.247	Compliance
		CDMA	1.284	1.284	Compliance
		WCDMA	4.327	4.215	Compliance
	PCS	GSM	0.247	0.245	Compliance
		CDMA	1.279	1.274	Compliance
		WCDMA	4.407	4.183	Compliance
	AWS	GSM	0.250	0.244	Compliance
		CDMA	1.284	1.279	Compliance
		WCDMA	4.519	4.199	Compliance
	Lower 700MHz	GSM	0.245	0.240	Compliance
		CDMA	1.284	1.279	Compliance
		WCDMA	4.263	4.183	Compliance
	Upper 700MHz	GSM	0.247	0.240	Compliance
		CDMA	1.284	1.279	Compliance
		WCDMA	4.295	4.167	Compliance

### Uplink, 836.5MHz -CDMA (Input)

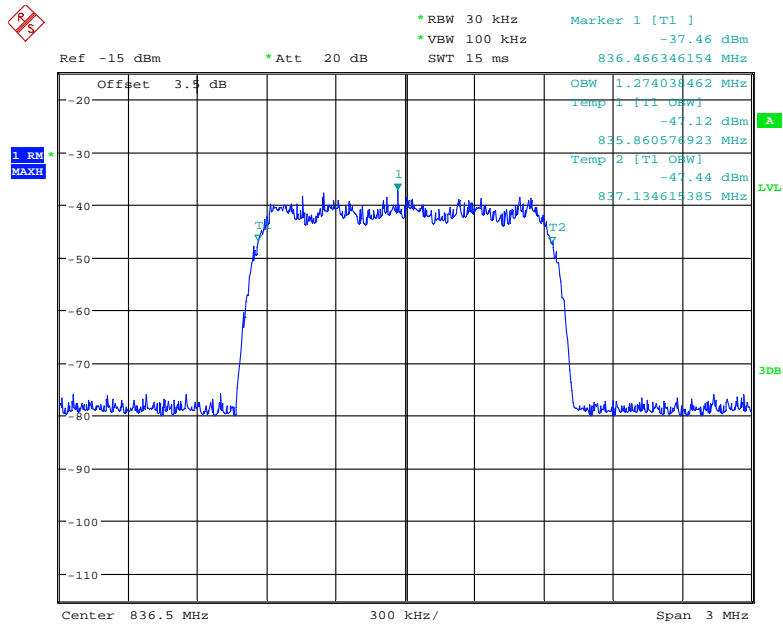

Date: 2.AUG.2019 06:52:59

### Uplink, 836.5MHz -CDMA (Output)

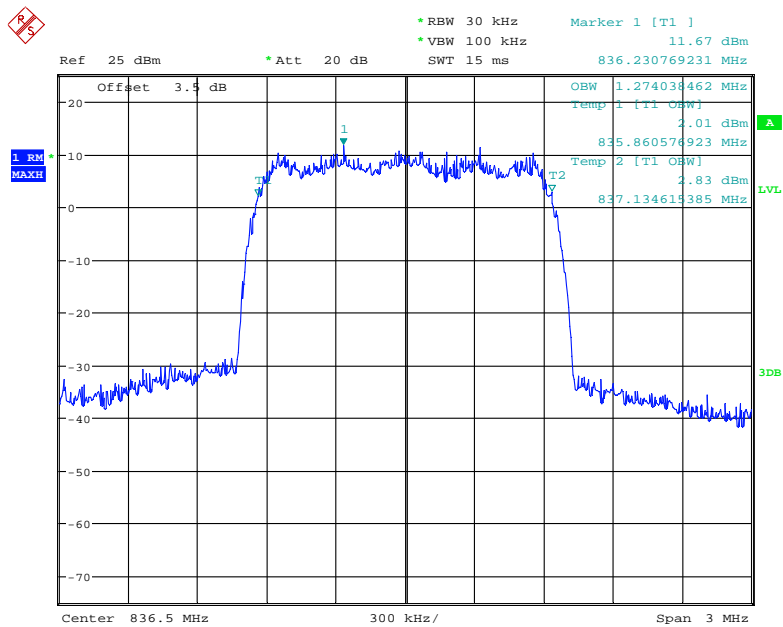

Date: 2.AUG.2019 07:07:14

### Uplink, 836.5MHz -GSM(Input)

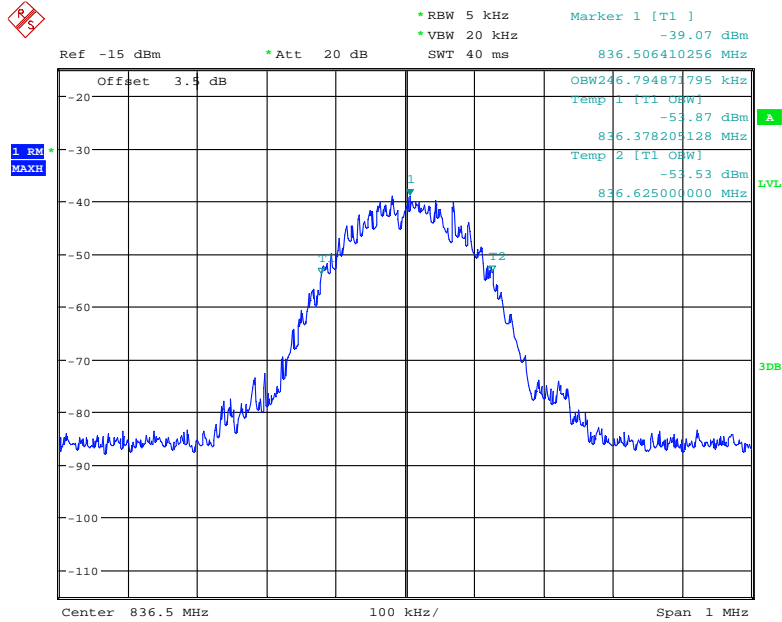

Date: 2.AUG.2019 06:40:59

### Uplink, 836.5MHz -GSM (Output)

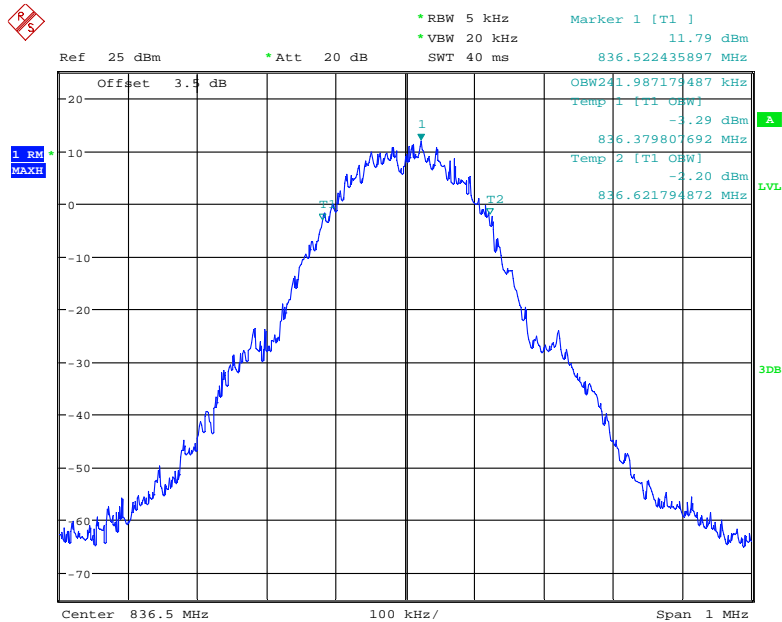

Date: 2.AUG.2019 06:31:48

**Uplink, 836.5MHz –WCDMA (Input)**

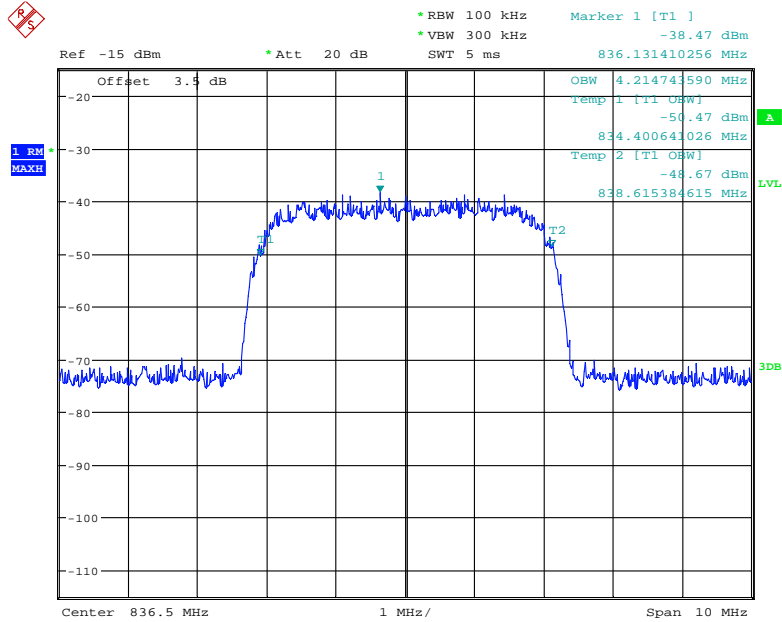

Date: 2.AUG.2019 06:58:30

**Uplink, 836.5MHz –WCDMA (Output)**

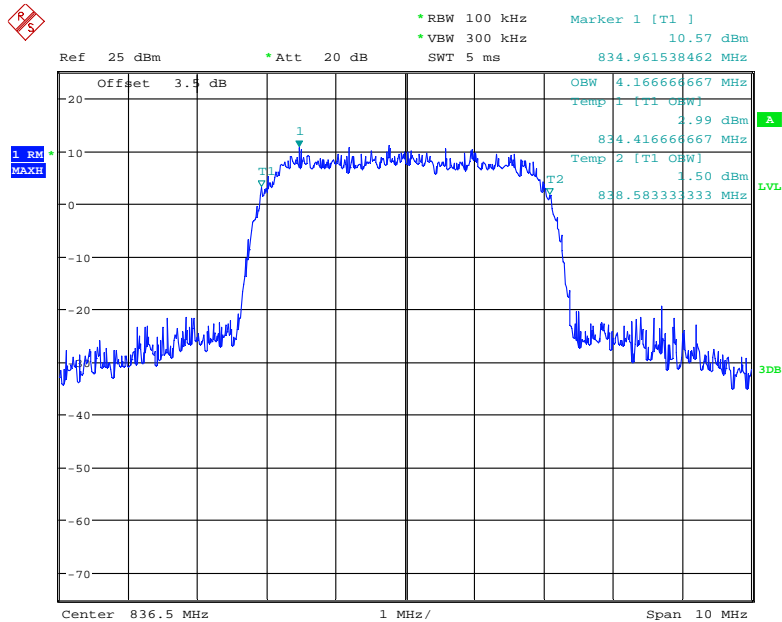

Date: 2.AUG.2019 07:04:10

### Uplink, 1882.5MHz-CDMA(Input)

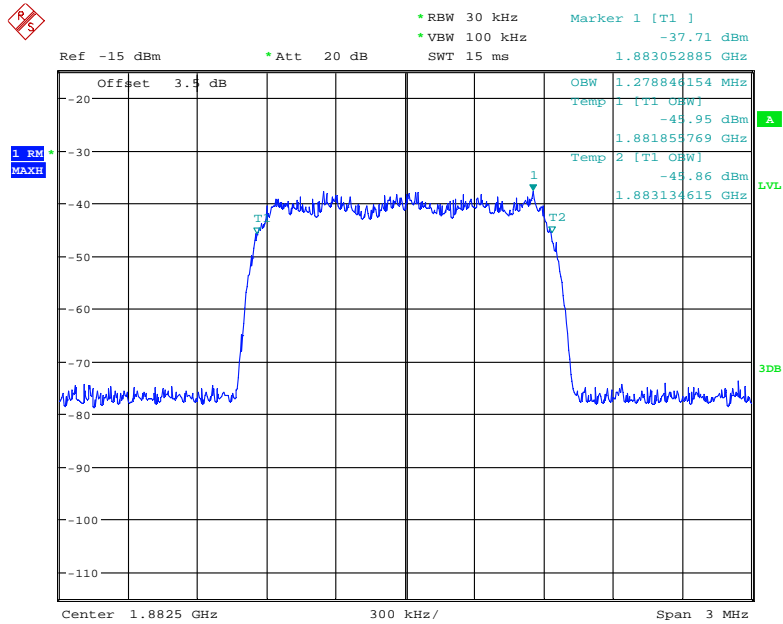

Date: 2.AUG.2019 06:52:27

### Uplink, 1882.5MHz-CDMA (Output)

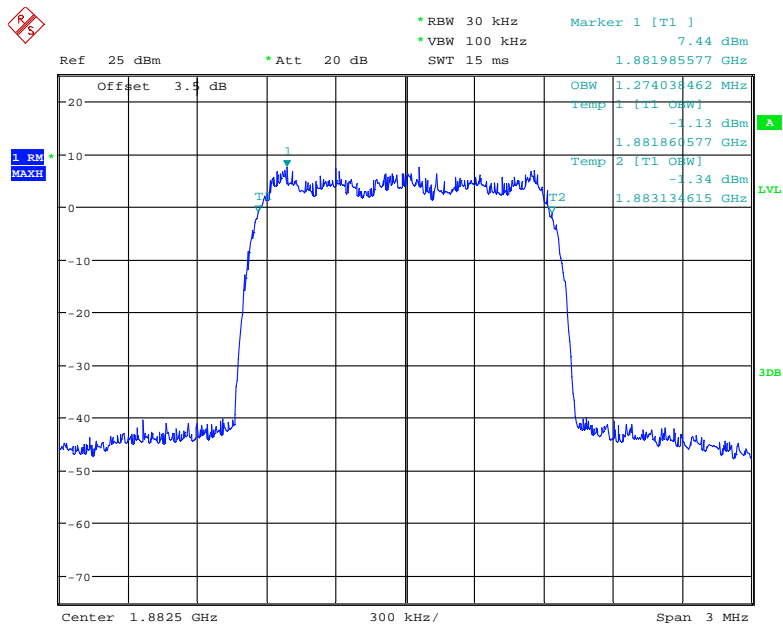

Date: 2.AUG.2019 07:07:33

### Uplink, 1882.5MHz-GSM(Input)

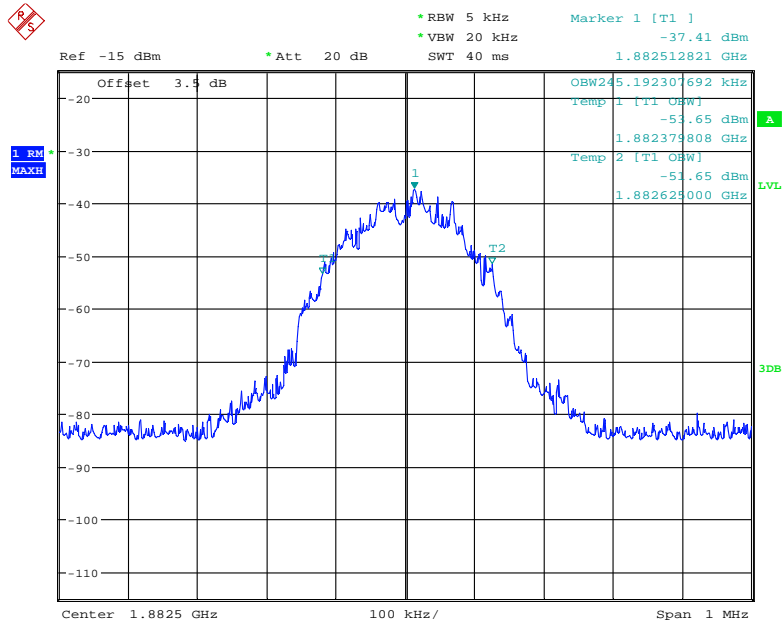

Date: 2.AUG.2019 06:41:26

### Uplink, 1882.5MHz-GSM (Output)

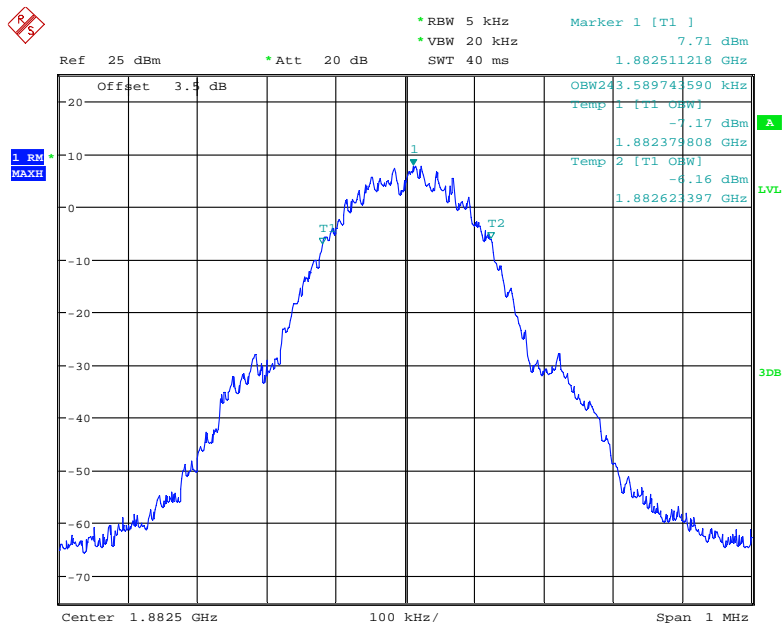

Date: 2.AUG.2019 06:30:03

### Uplink, 1882.5MHz-WCDMA (Input)

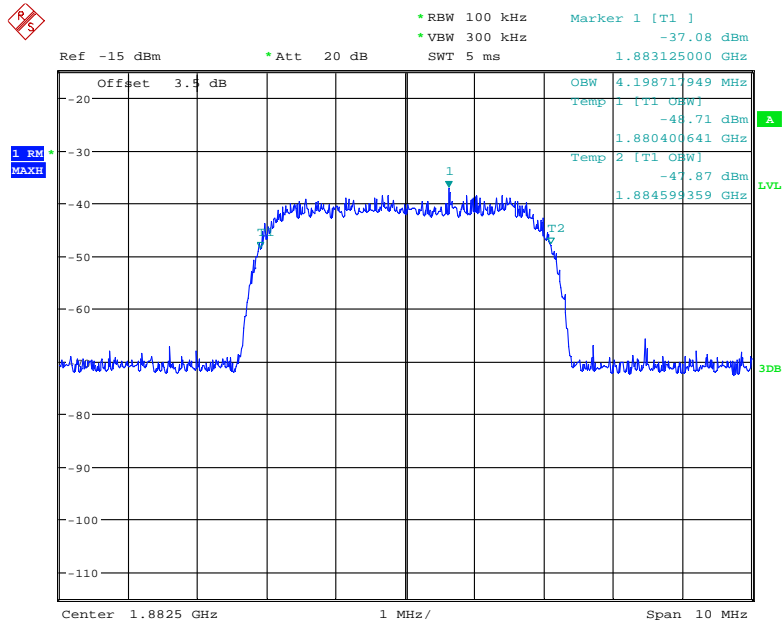

Date: 2.AUG.2019 06:58:49

### Uplink, 1882.5MHz- WCDMA (Output)

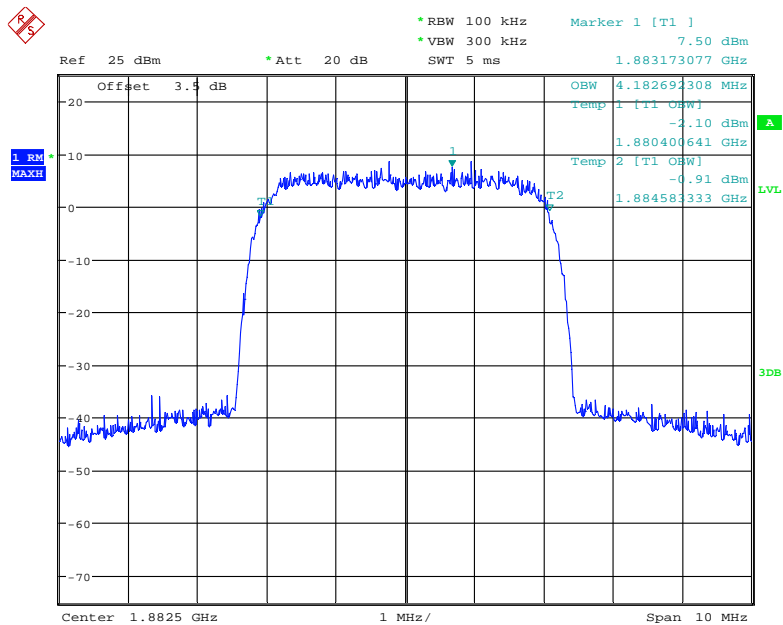

Date: 2.AUG.2019 07:03:05

### Uplink, 1732.5MHz -CDMA (Input)

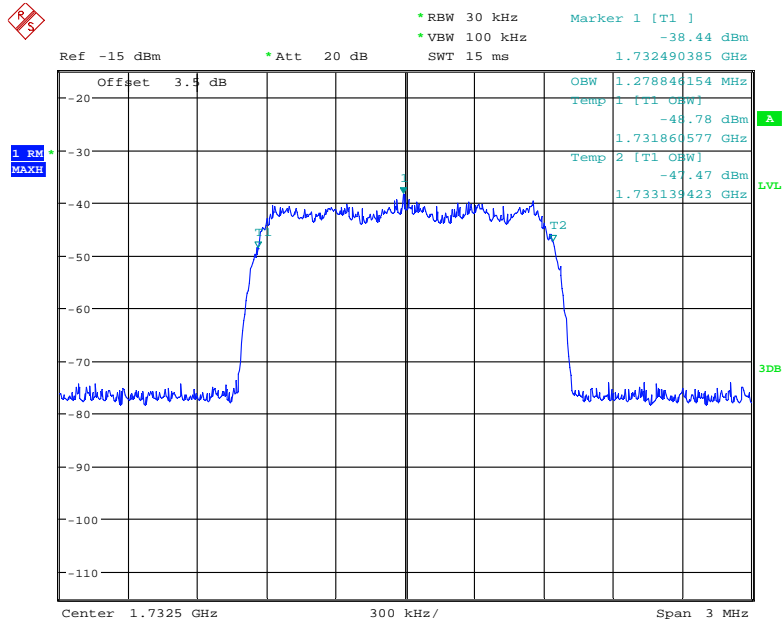

Date: 2.AUG.2019 06:53:32

### Uplink, 1732.5MHz -CDMA (Output)

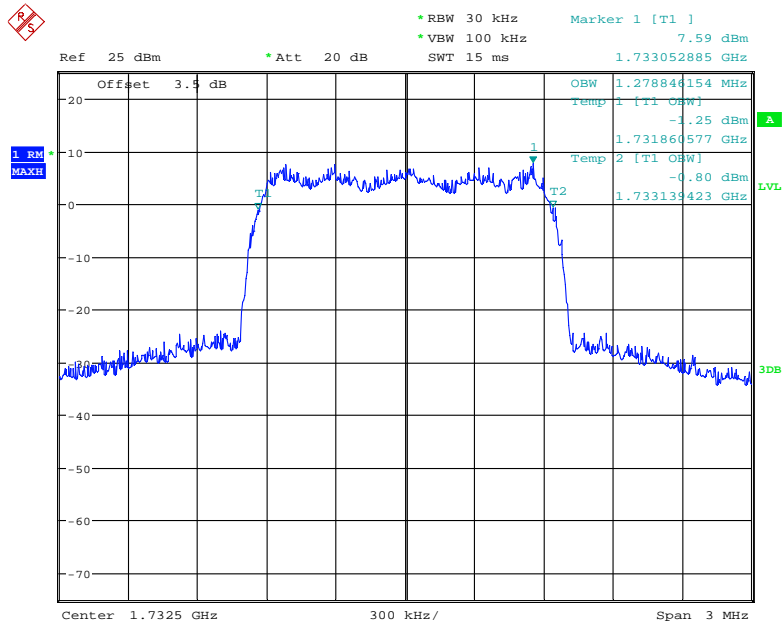

Date: 2.AUG.2019 07:06:57



### Uplink, 1732.5MHz -GSM(Input)

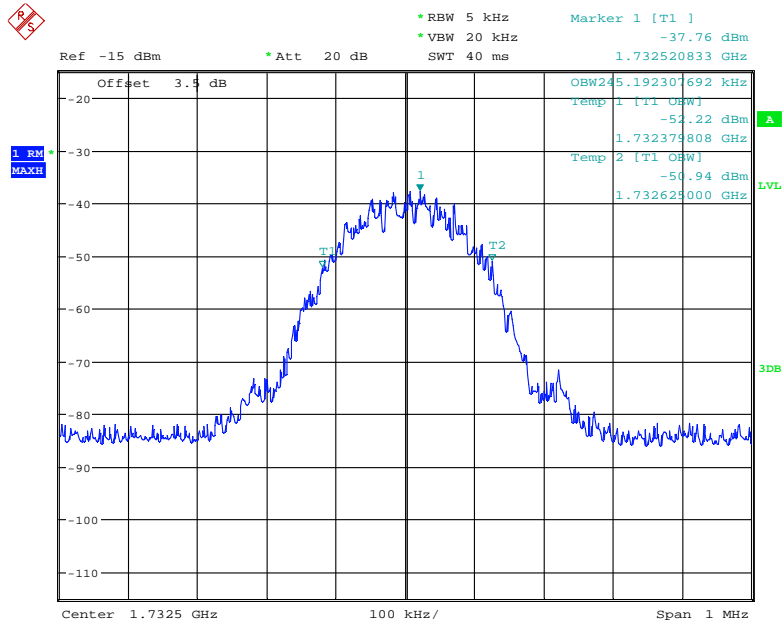

Date: 2.AUG.2019 06:40:25

### Uplink, 1732.5MHz -GSM (Output)

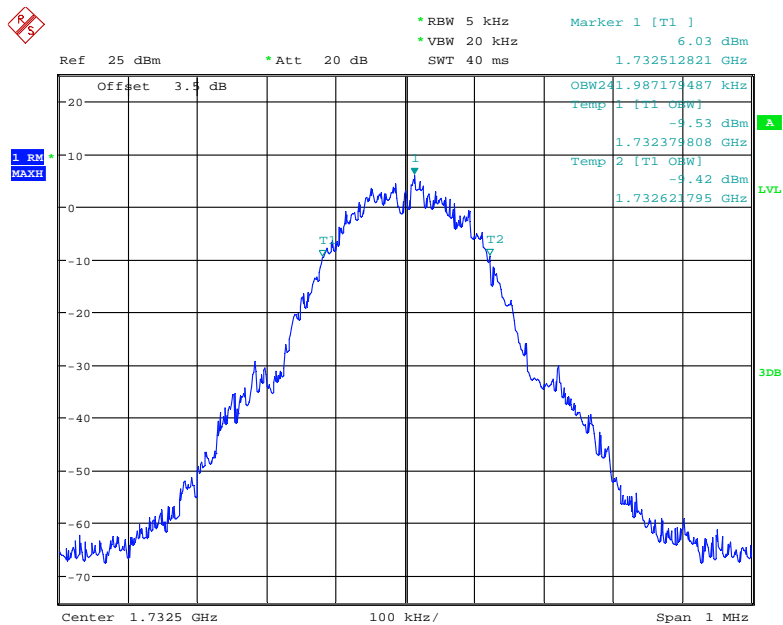

Date: 2.AUG.2019 06:32:34

### Uplink, 1732.5MHz –WCDMA (Input)

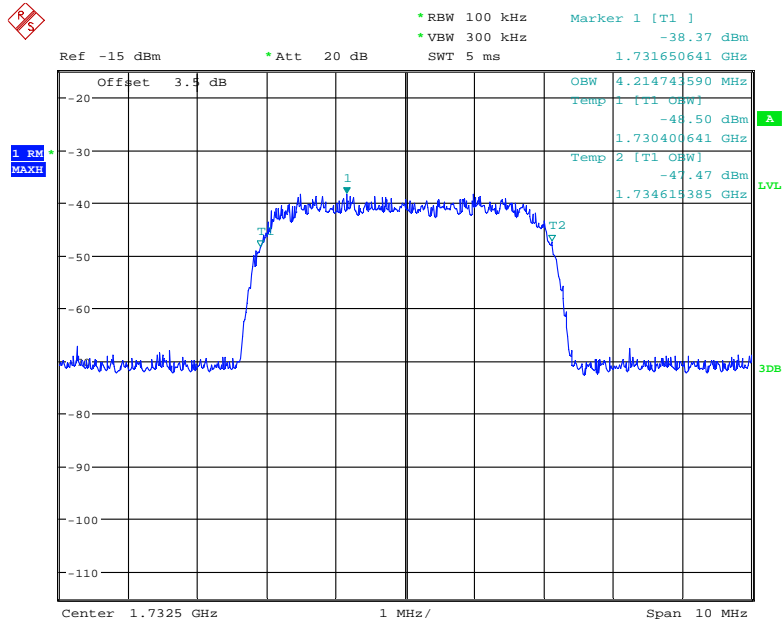

Date: 2.AUG.2019 06:58:13

### Uplink, 1732.5MHz –WCDMA (Output)

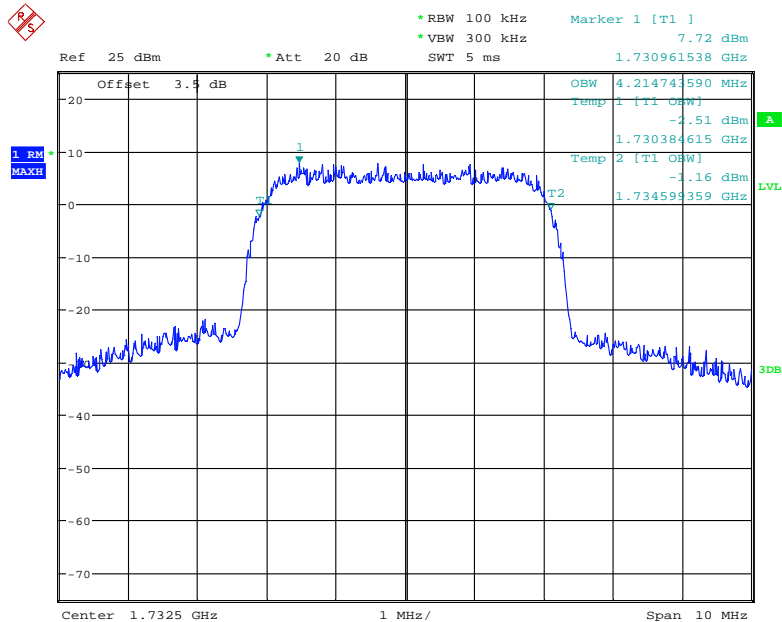

Date: 2.AUG.2019 07:04:30

### Uplink, 707MHz-CDMA(Input)

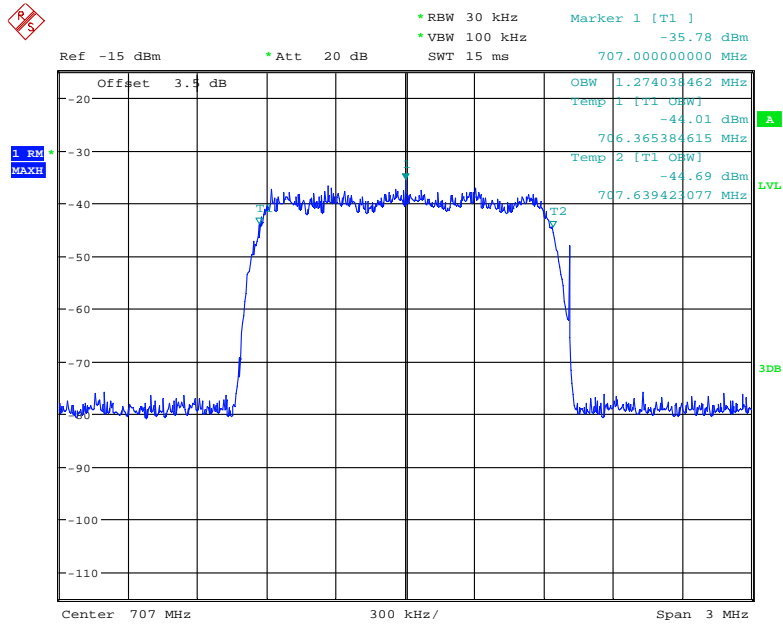

Date: 2.AUG.2019 06:53:57

### Uplink, 707MHz-CDMA (Output)

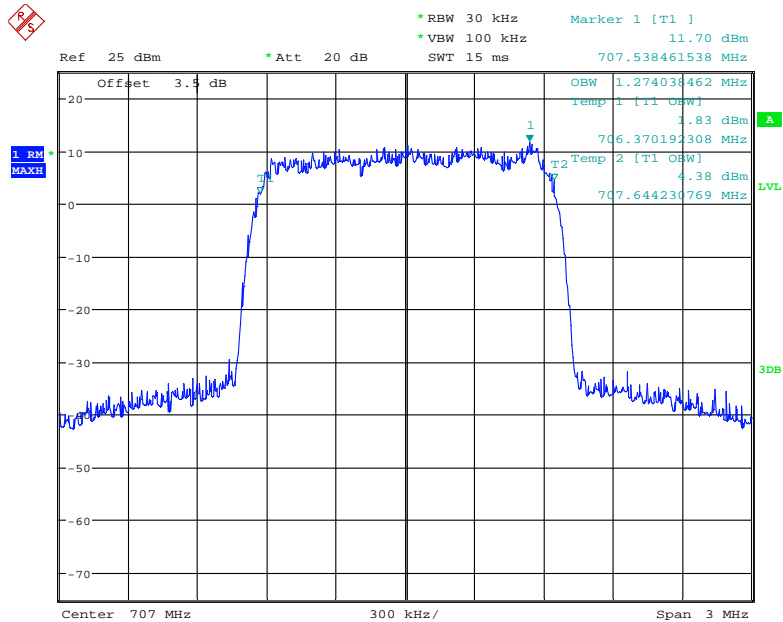

Date: 2.AUG.2019 07:06:38

### Uplink, 707MHz -GSM (Input)

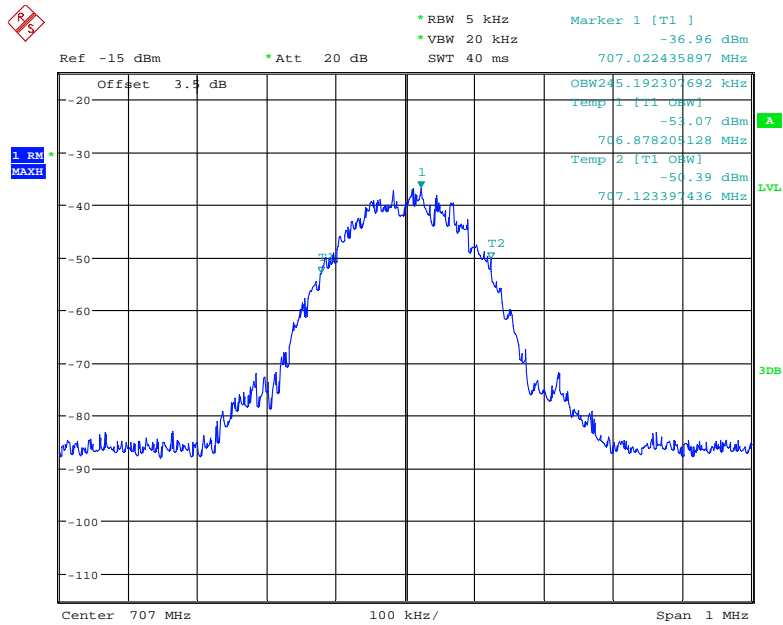

Date: 2.AUG.2019 06:39:27

### Uplink, 707MHz -GSM (Output)

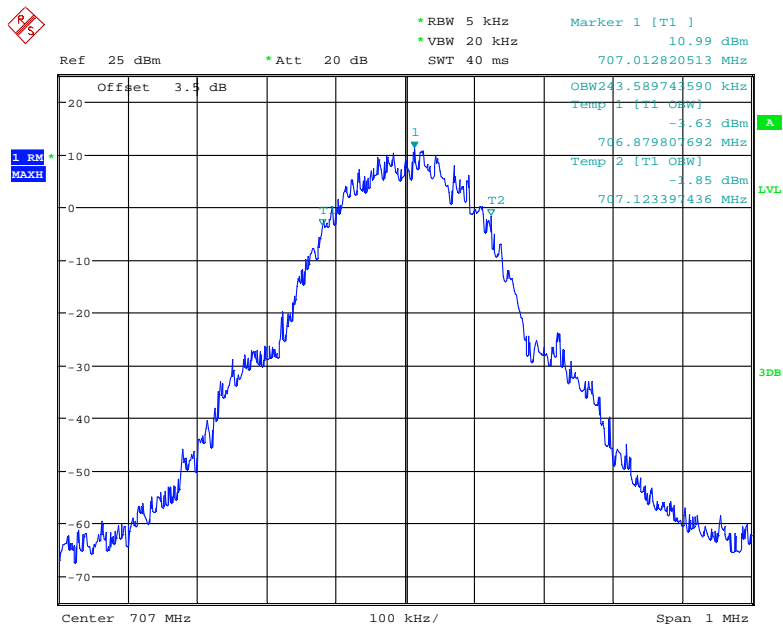

Date: 2.AUG.2019 06:35:23

### Uplink, 707MHz –WCDMA (Input)

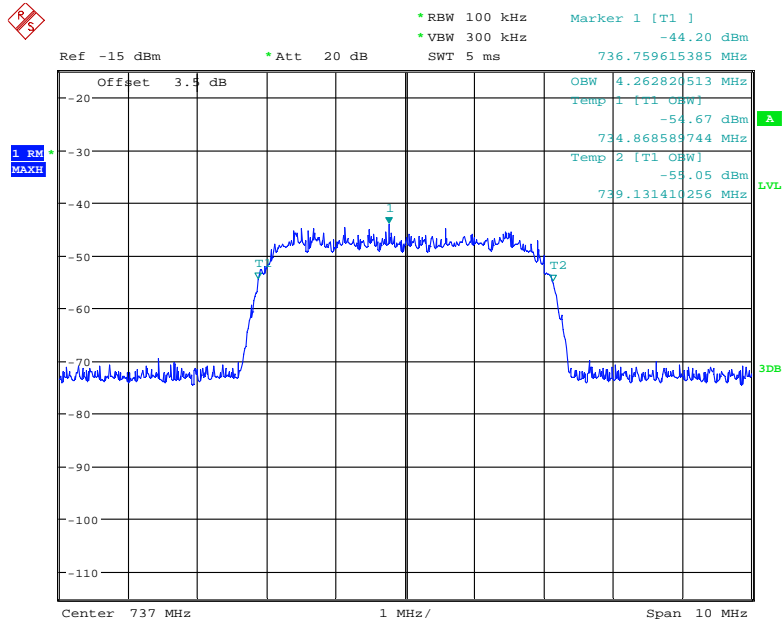

Date: 2.AUG.2019 07:00:28

### Uplink, 707MHz –WCDMA (Output)

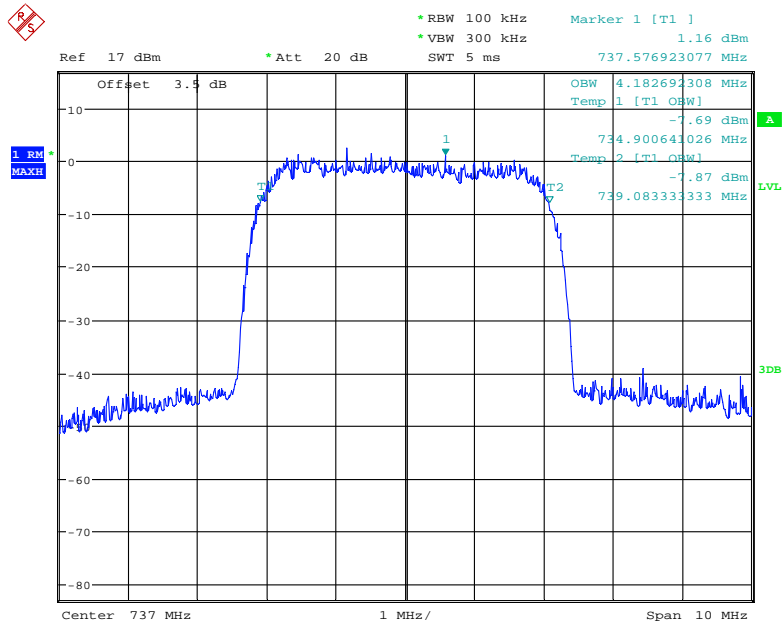

Date: 2.AUG.2019 07:11:37

### Uplink, 781.5MHz-CDMA (Input)

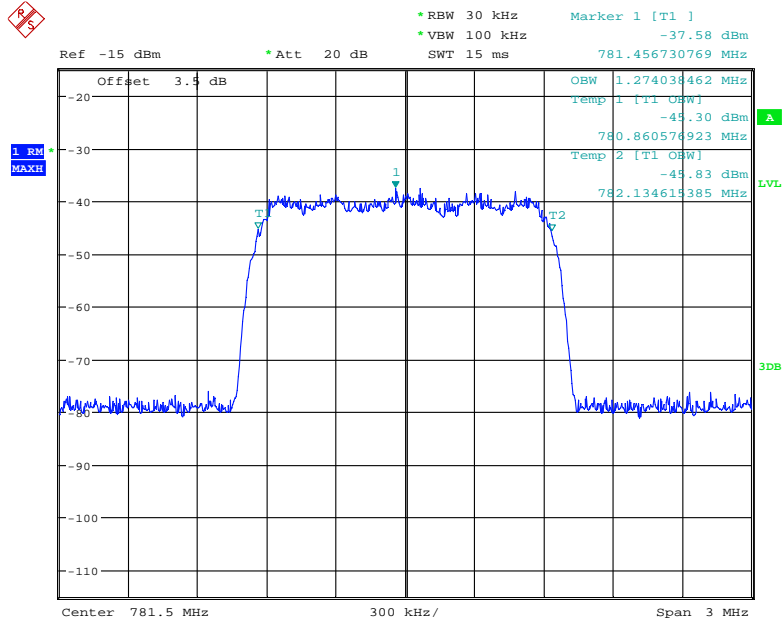

Date: 2.AUG.2019 06:54:23

### Uplink, 781.5MHz-CDMA (Output)

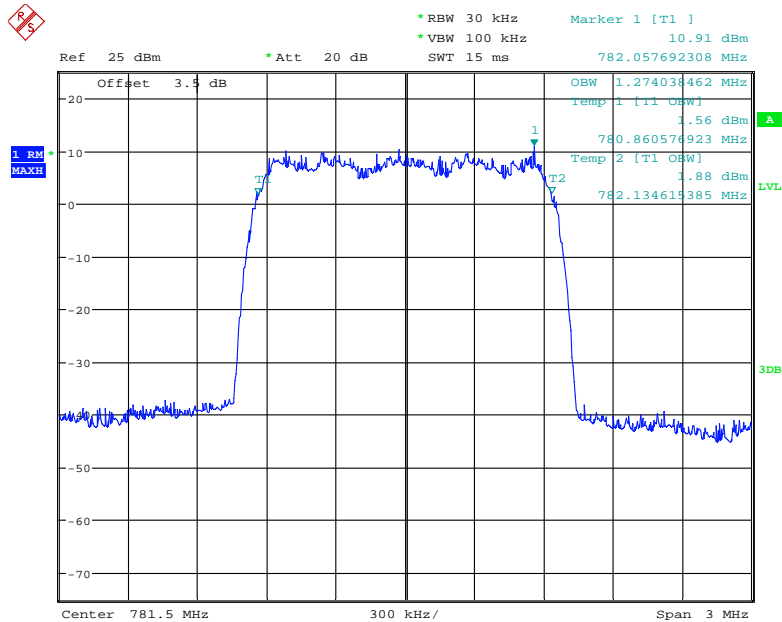

Date: 2.AUG.2019 07:06:16

### Uplink, 781.5MHz -GSM (Input)

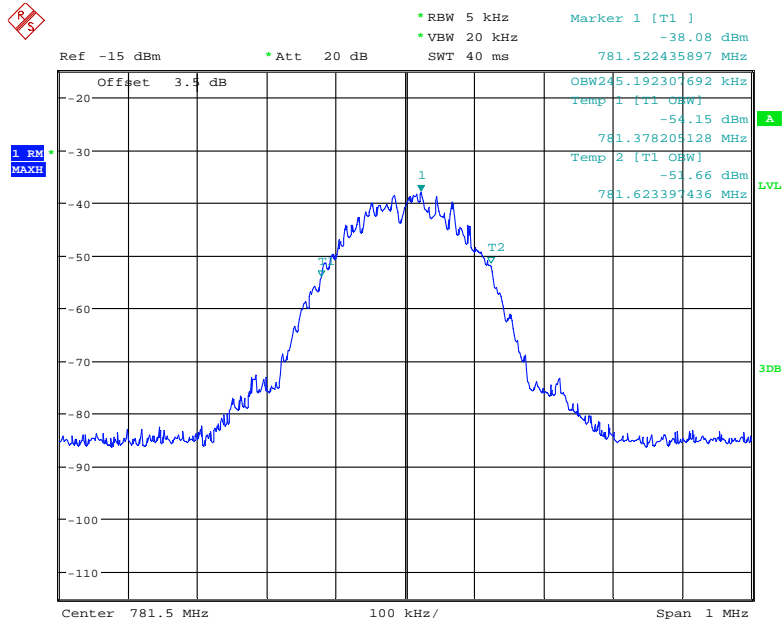

Date: 2.AUG.2019 06:38:43

### Uplink, 781.5MHz -GSM (Output)

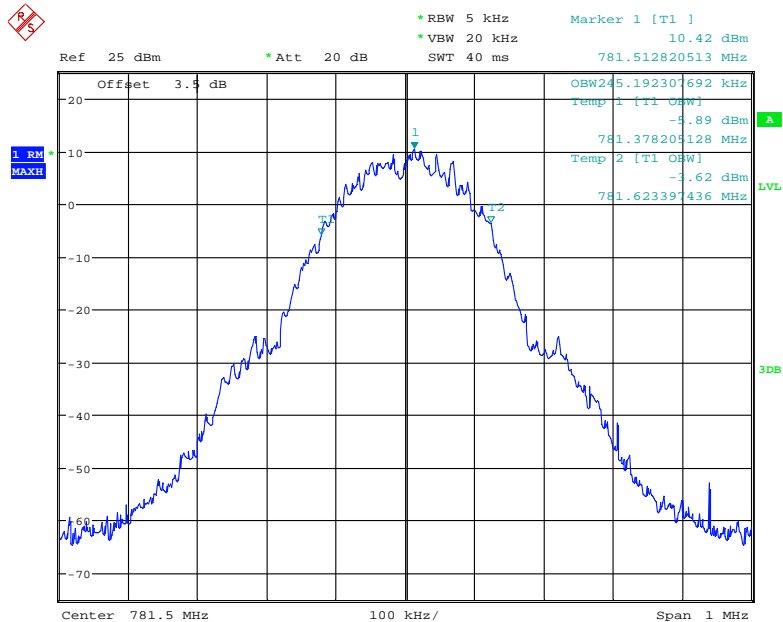

Date: 2.AUG.2019 06:36:32

### Uplink, 781.5MHz –WCDMA (Input)

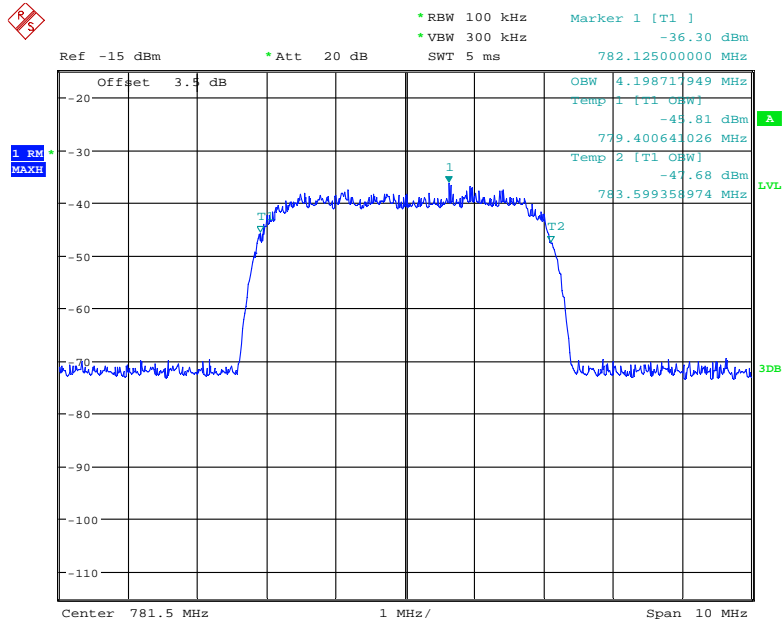

Date: 2.AUG.2019 06:57:07

### Uplink, 781.5MHz –WCDMA (Output)

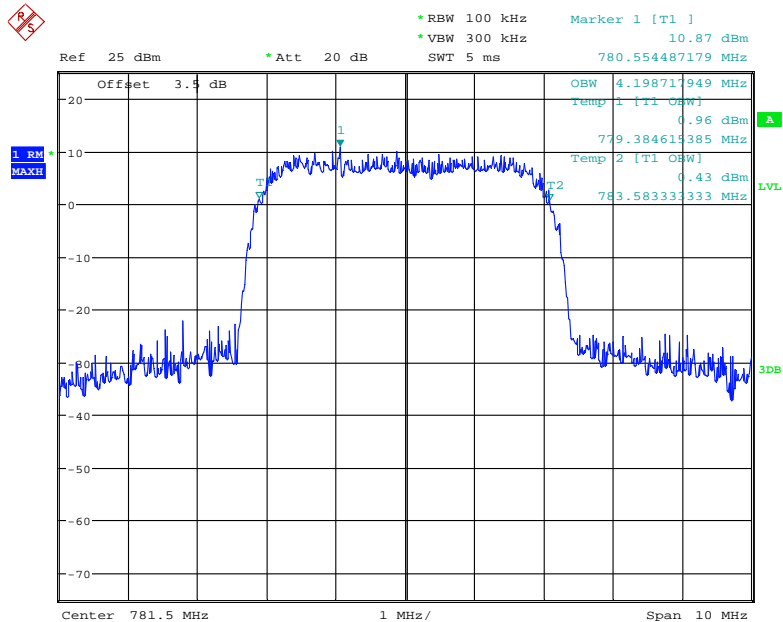

Date: 2.AUG.2019 07:05:15



### Downlink, 881.5MHz -CDMA (Input)

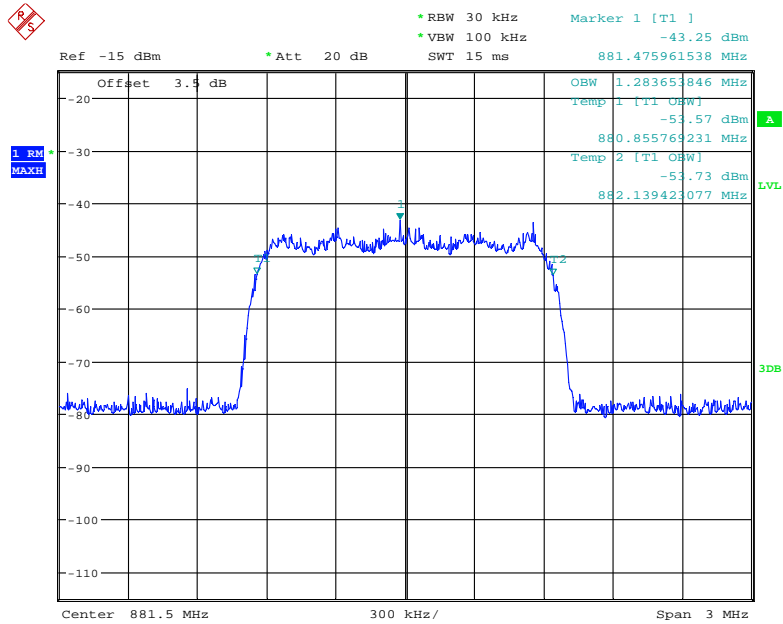

Date: 2.AUG.2019 06:51:37

### Downlink, 881.5MHz -CDMA (Output)

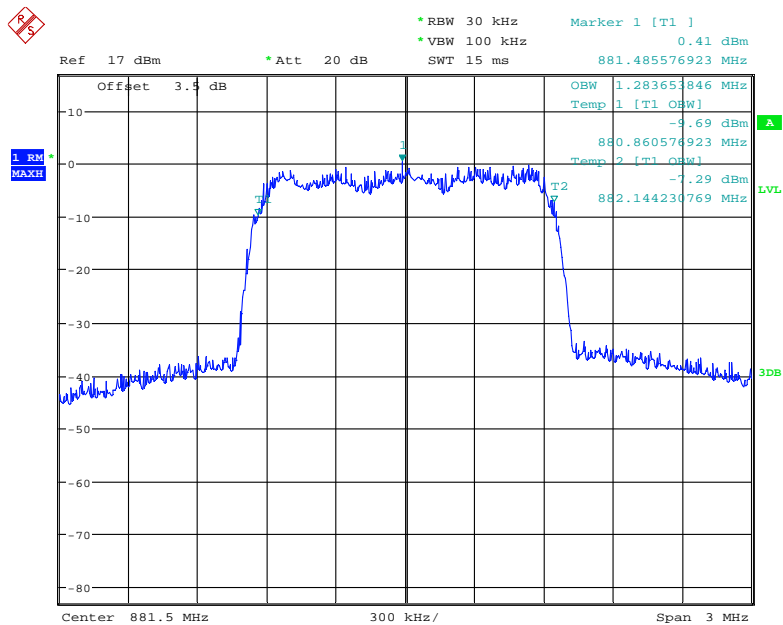

Date: 2.AUG.2019 07:09:21

**Downlink, 881.5MHz -GSM (Input)**

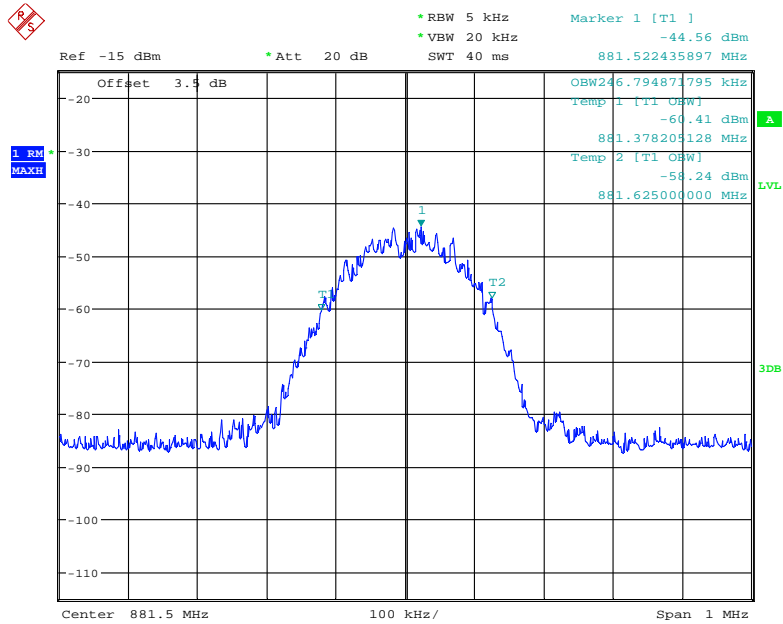

Date: 2.AUG.2019 06:42:38

**Downlink, 881.5MHz -GSM (Output)**

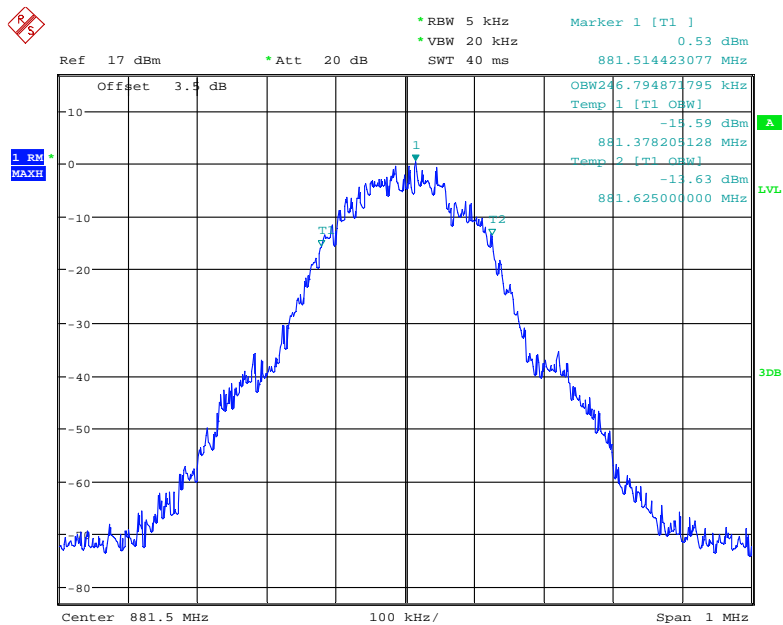

Date: 2.AUG.2019 07:14:48

### Downlink, 881.5MHz - WCDMA (Input)

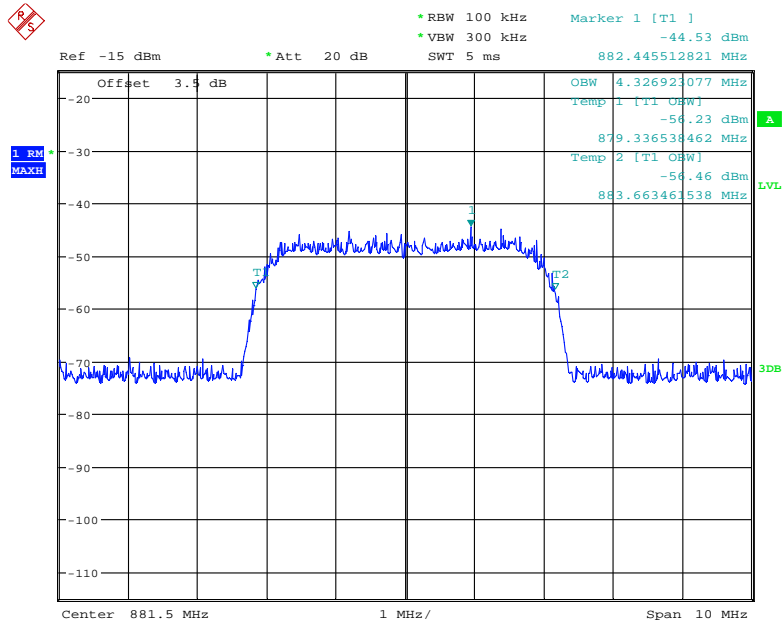

Date: 2.AUG.2019 06:59:46

### Downlink, 881.5MHz - WCDMA (Output)

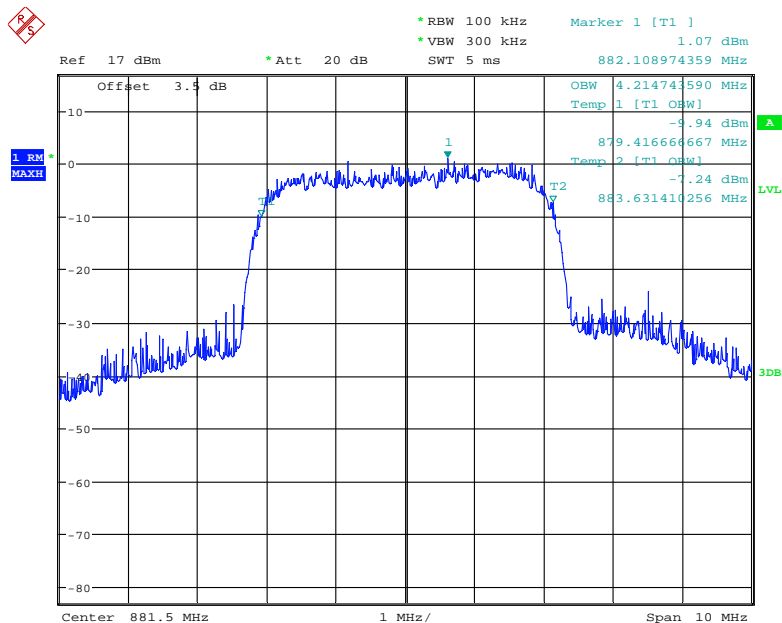

Date: 2.AUG.2019 07:12:14

**Downlink, 1962.5MHz -CDMA (Input)**

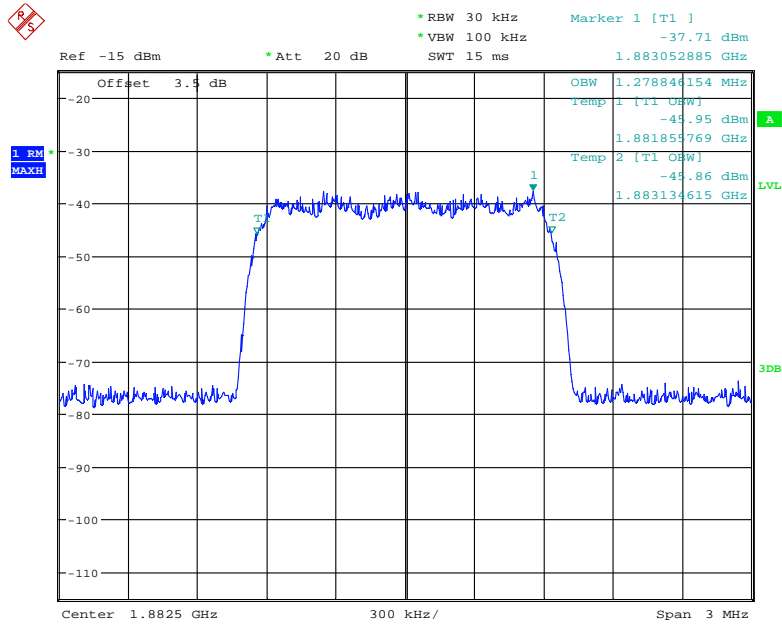

Date: 2.AUG.2019 06:52:27

**Downlink, 1962.5MHz -CDMA (Output)**

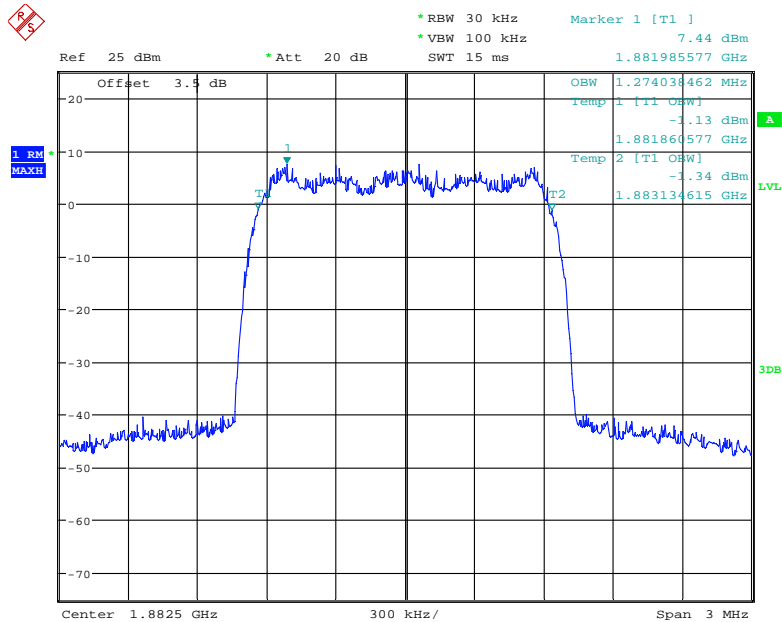

Date: 2.AUG.2019 07:07:33

**Downlink, 1962.5MHz –GSM (Input)**

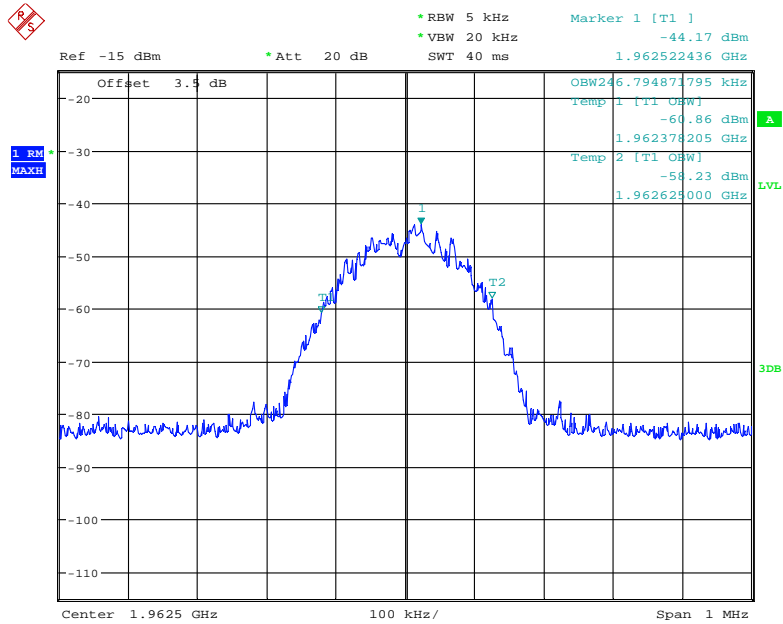

Date: 2.AUG.2019 06:42:03

**Downlink, 1962.5MHz -GSM (Output)**

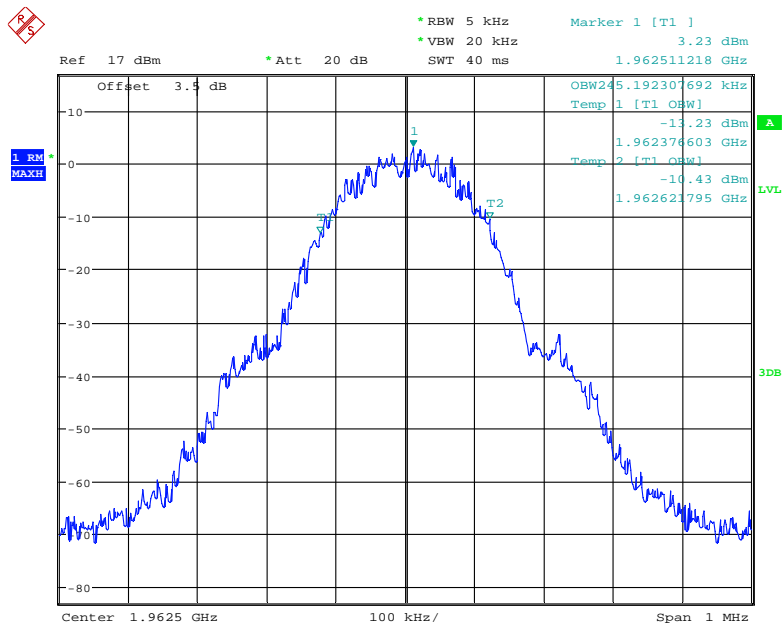

Date: 2.AUG.2019 07:14:20

**Downlink, 1962.5MHz -WCDMA (Input)**

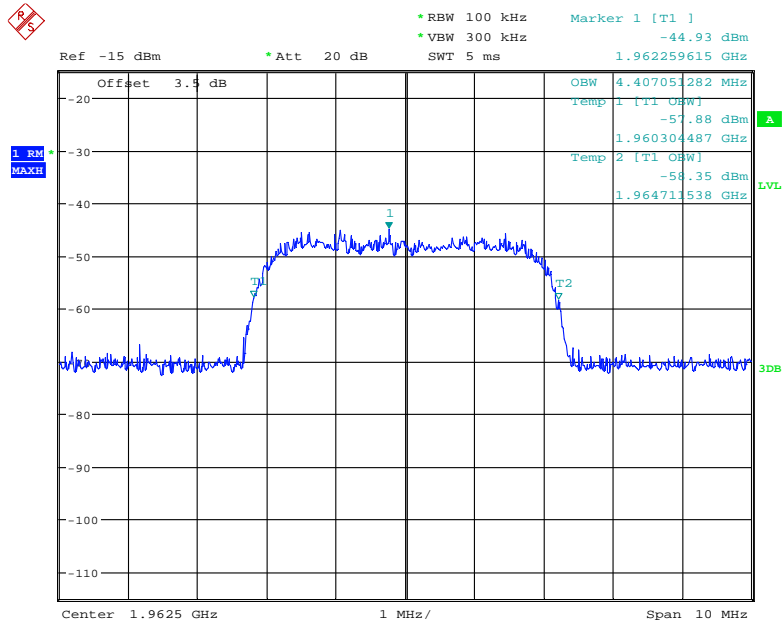

Date: 2.AUG.2019 06:59:22

**Downlink, 1962.5MHz -WCDMA (Output)**

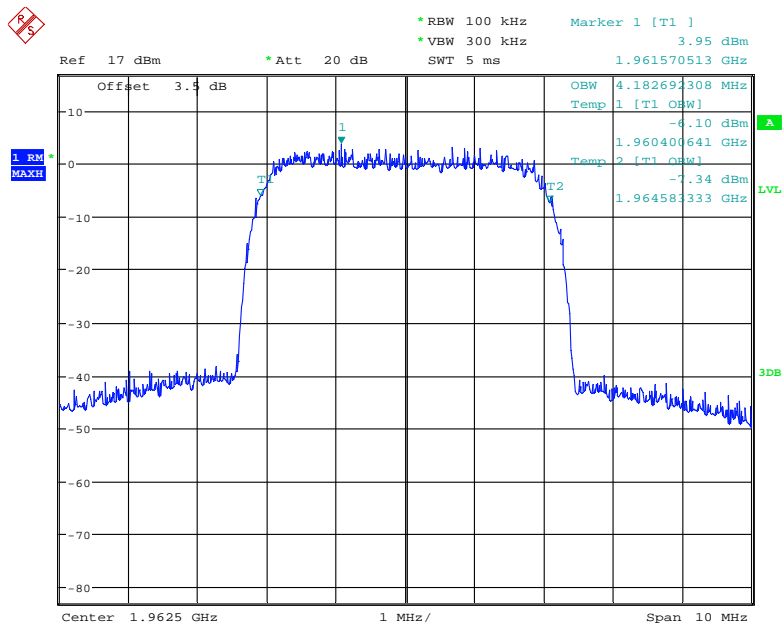

Date: 2.AUG.2019 07:12:31

### Downlink, 2132.5MHz -CDMA (Input)

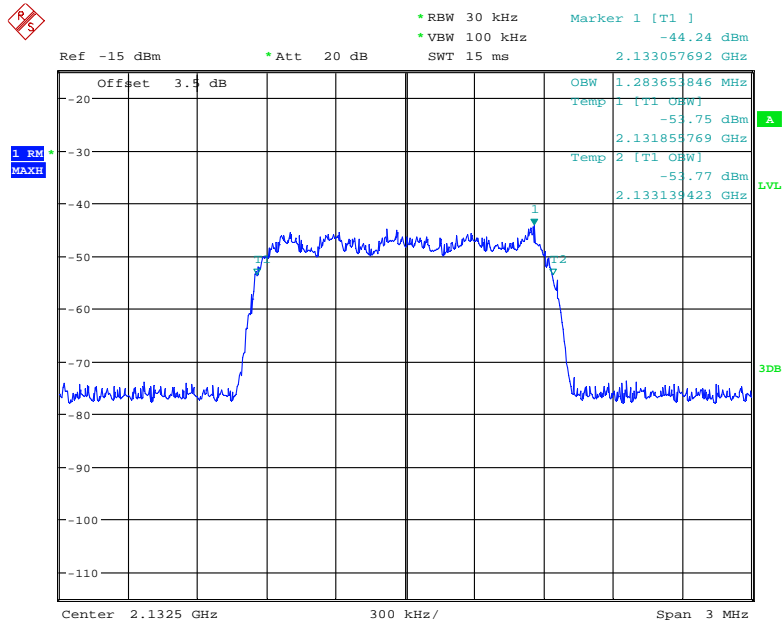

Date: 2.AUG.2019 06:51:04

### Downlink, 2132.5MHz -CDMA (Output)

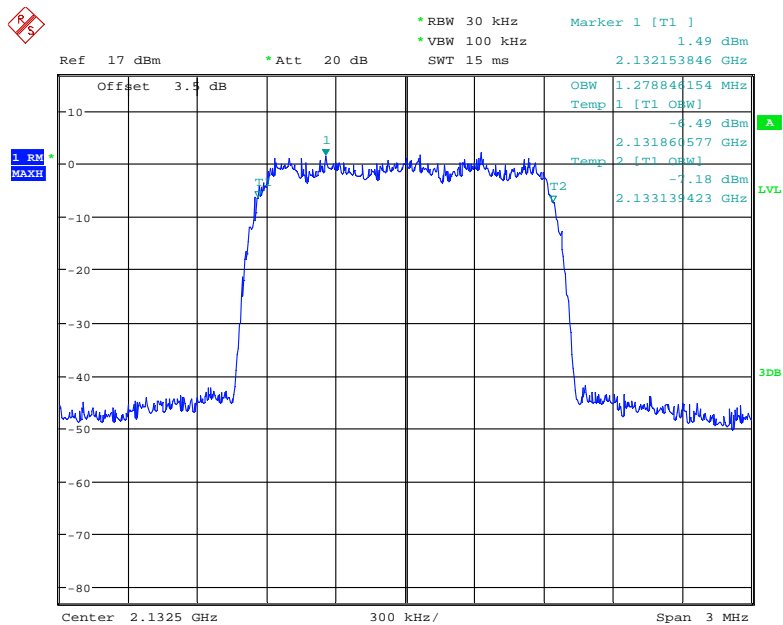

Date: 2.AUG.2019 07:09:45

**Downlink, 2132.5MHz –GSM (Input)**

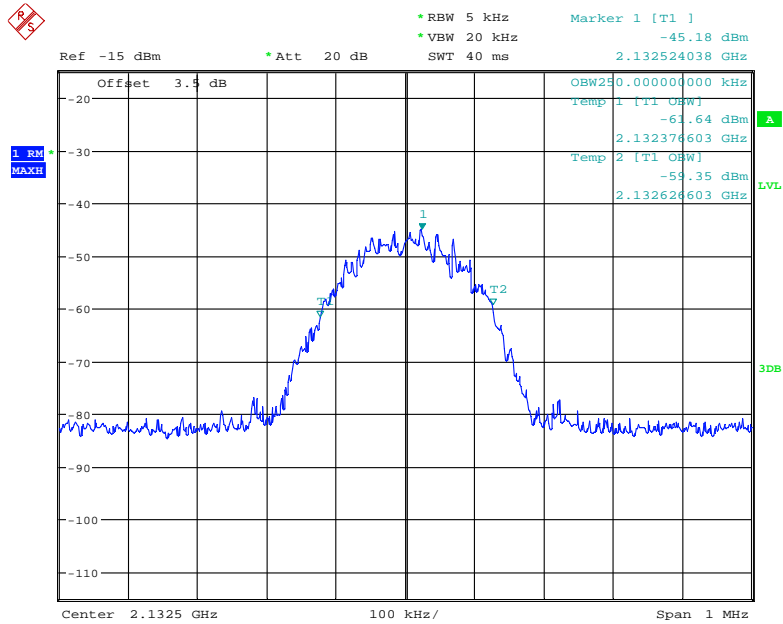

Date: 2.AUG.2019 06:43:14

**Downlink, 2132.5MHz -GSM (Output)**

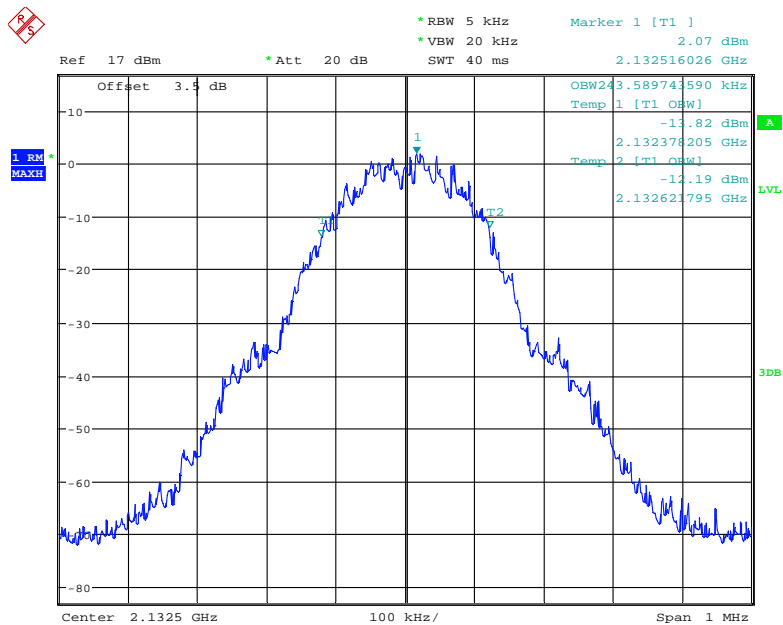

Date: 2.AUG.2019 07:15:36



**Downlink, 2132.5MHz -WCDMA (Input)**

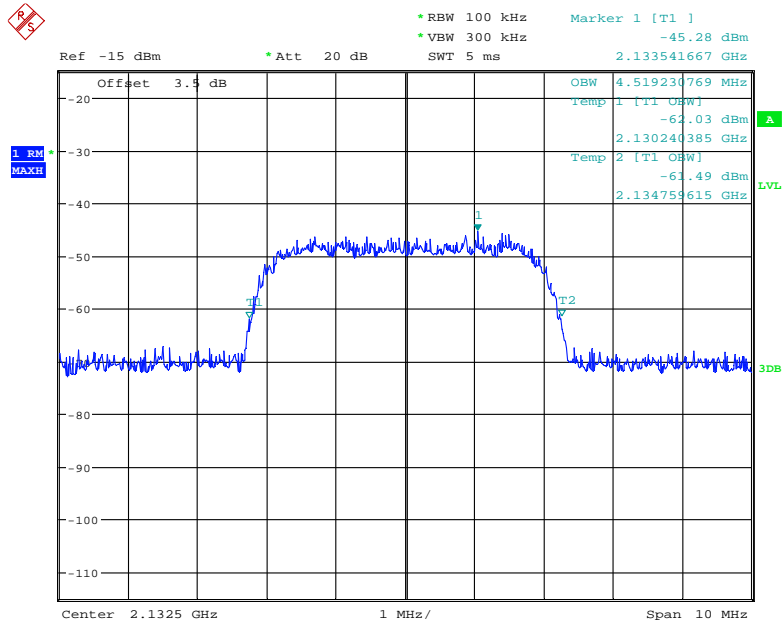

Date: 2.AUG.2019 07:00:08

**Downlink, 2132.5MHz -WCDMA (Output)**

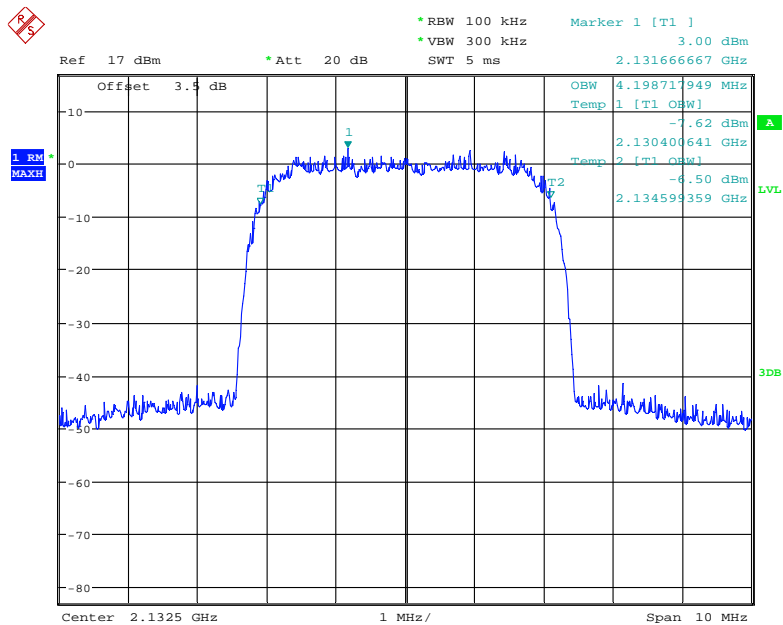

Date: 2.AUG.2019 07:11:56

**Downlink, 737MHz -CDMA (Input)**

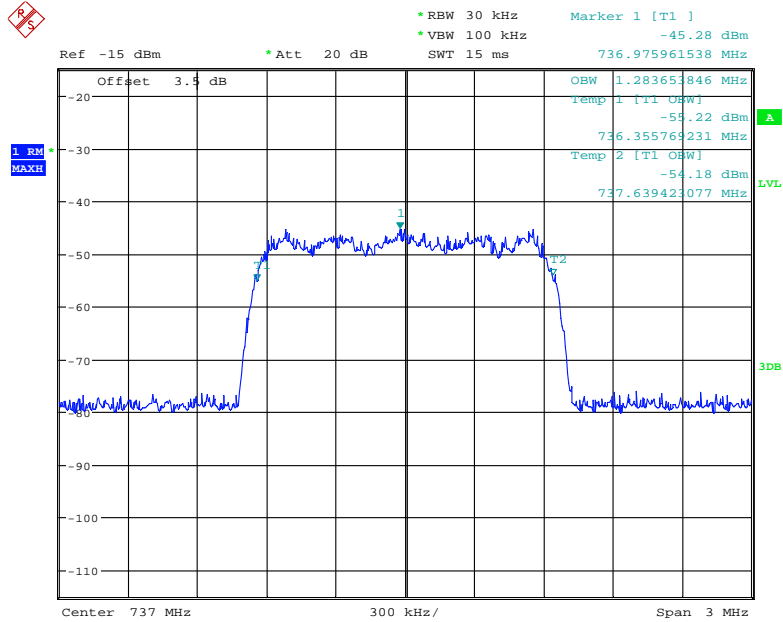

Date: 2.AUG.2019 06:50:40

**Downlink, 737MHz -CDMA (Output)**

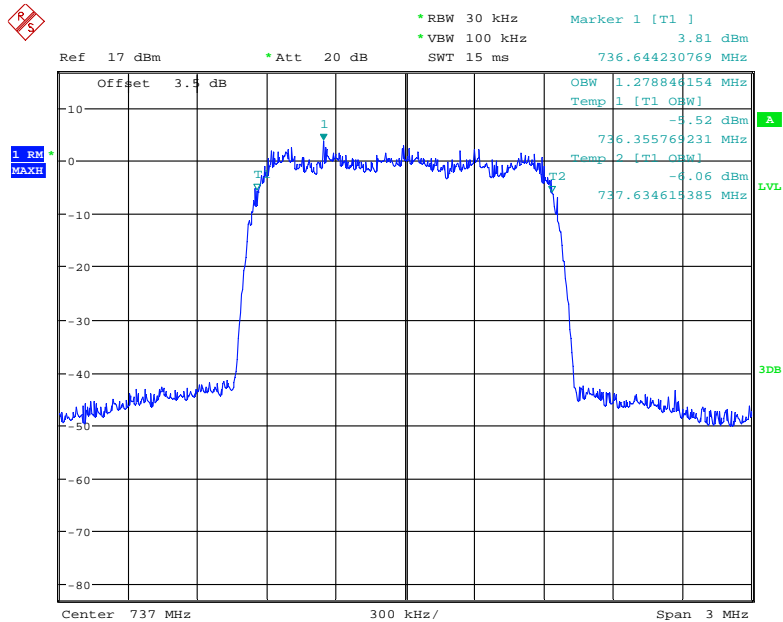

Date: 2.AUG.2019 07:10:03

**Downlink, 737MHz –GSM (Input)**

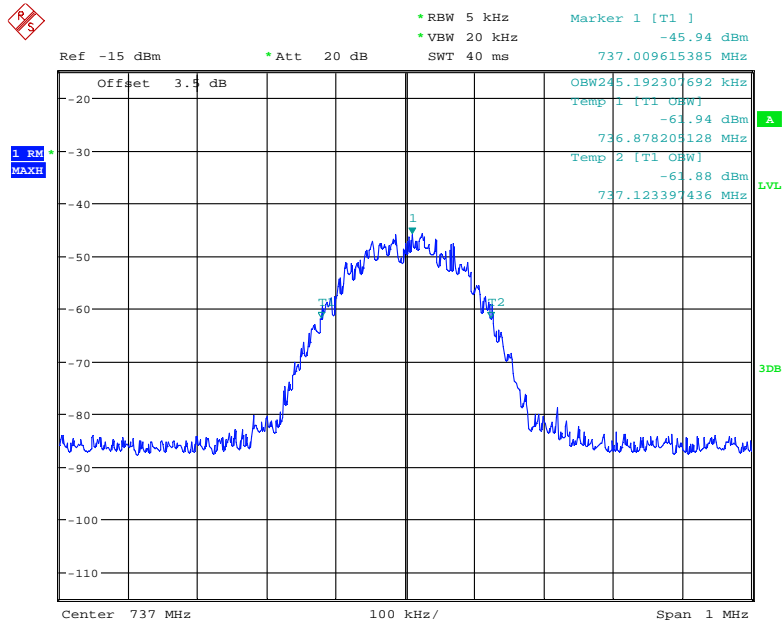

Date: 2.AUG.2019 06:43:49

**Downlink, 737MHz -GSM (Output)**

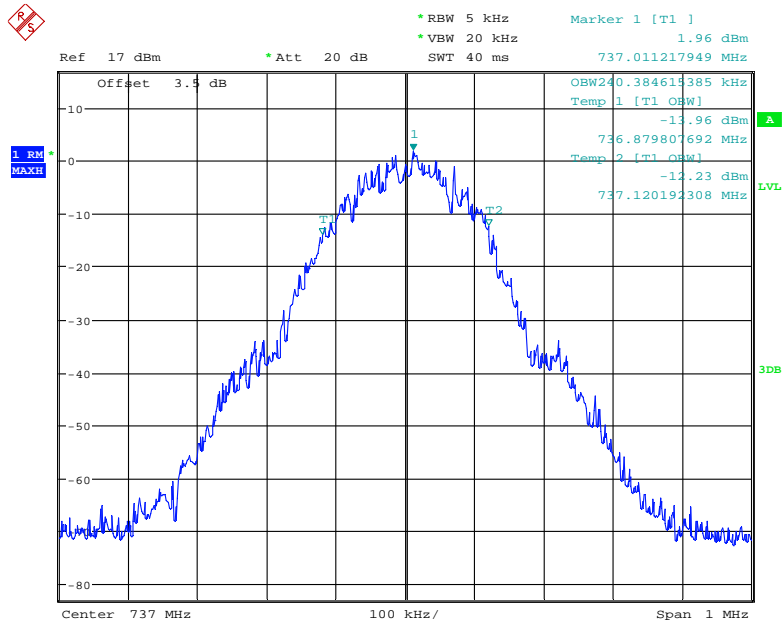

Date: 2.AUG.2019 07:16:02

### Downlink, 737MHz -WCDMA (Input)

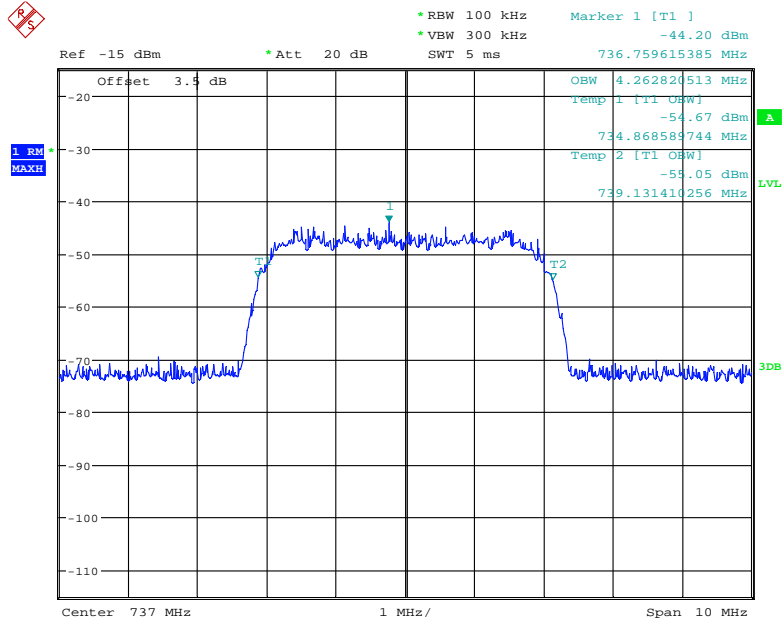

Date: 2.AUG.2019 07:00:28

### Downlink, 737MHz -WCDMA (Output)

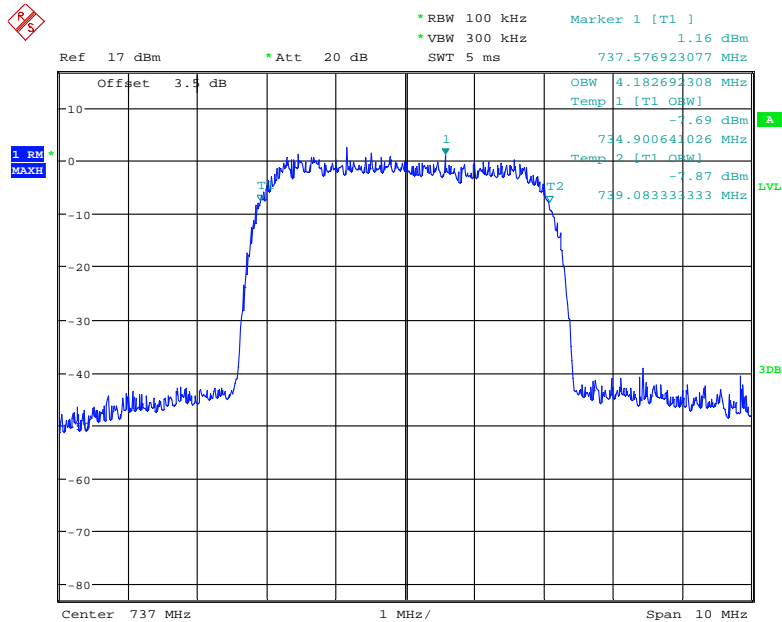

Date: 2.AUG.2019 07:11:37

### Downlink, 751.5MHz -CDMA (Input)

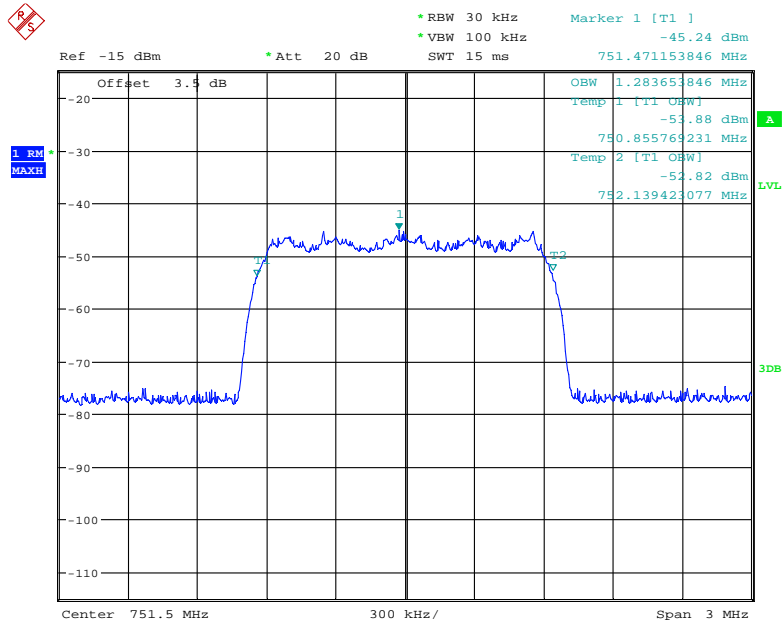

Date: 2.AUG.2019 06:49:49

### Downlink, 751.5MHz -CDMA (Output)

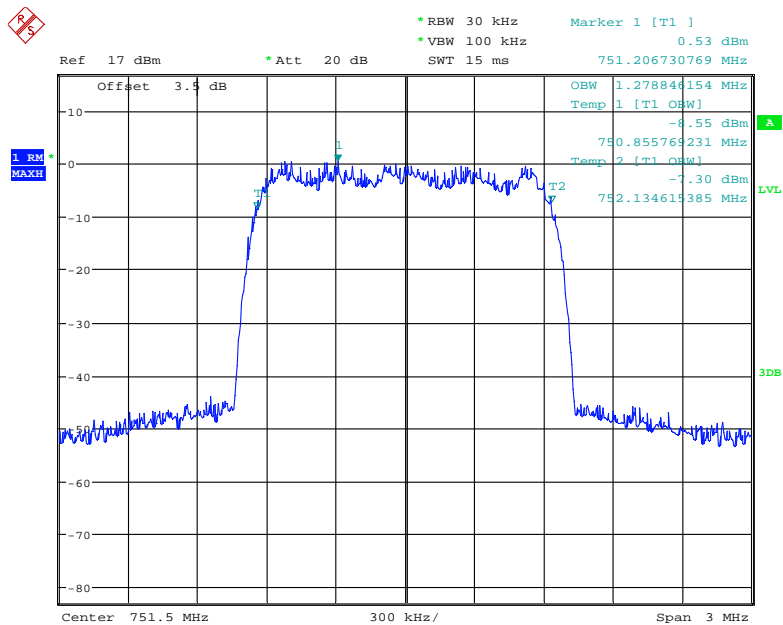

Date: 2.AUG.2019 07:10:23

### Downlink, 751.5MHz -GSM (Input)

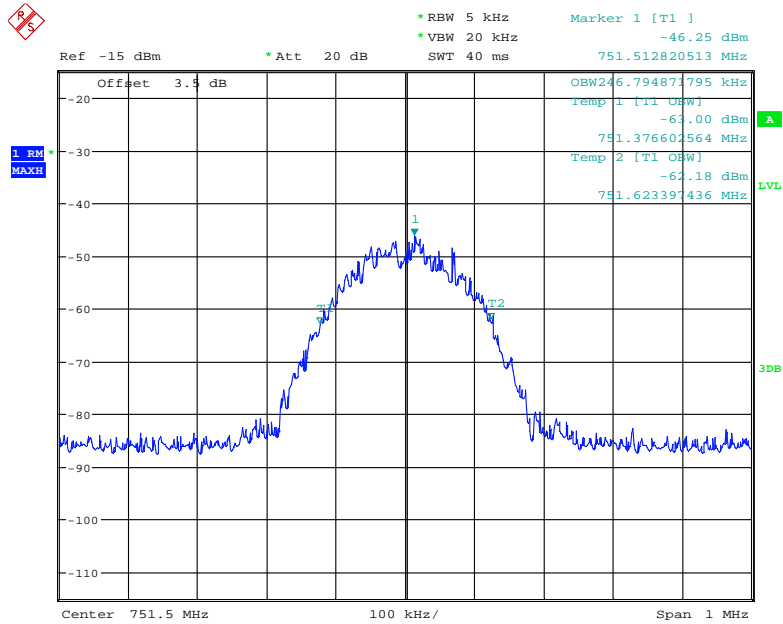

Date: 2.AUG.2019 06:44:21

### Downlink, 751.5MHz -GSM (Output)

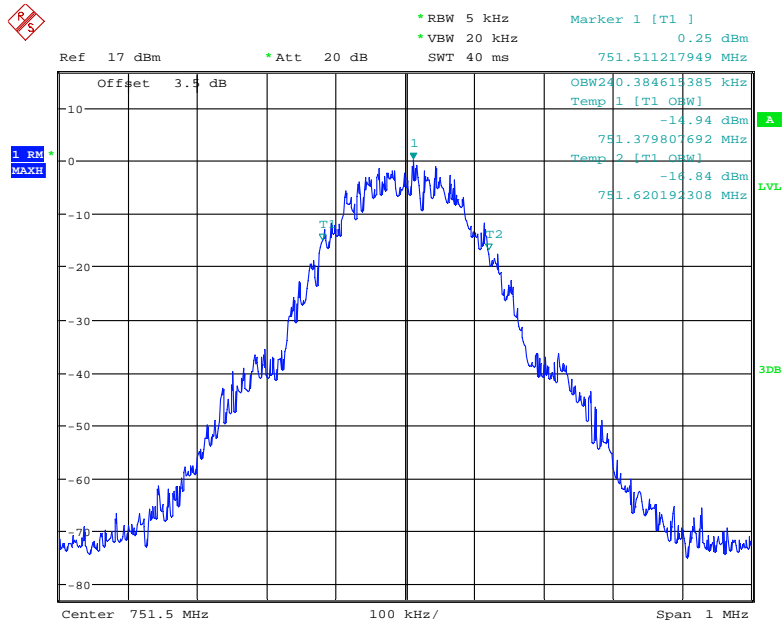

Date: 2.AUG.2019 07:16:26

**Downlink, 751.5MHz -WCDMA (Input)**

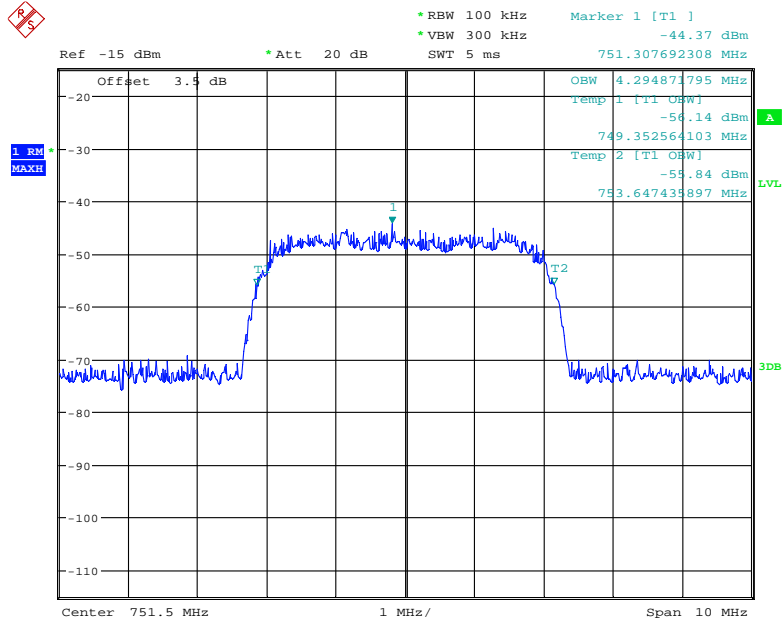

Date: 2.AUG.2019 07:00:48

**Downlink, 751.5MHz -WCDMA (Output)**

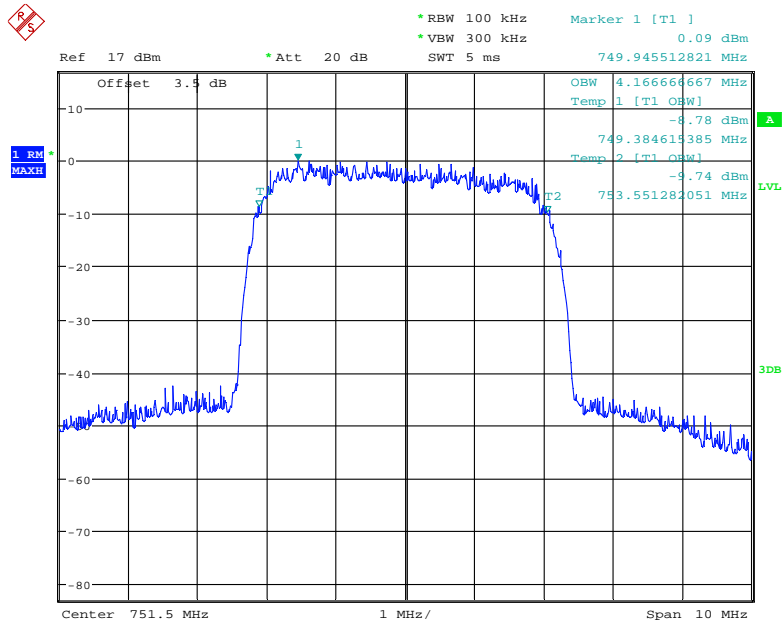

Date: 2.AUG.2019 07:11:14

**§ 20.21(e)(8)(ii)(A) & §20.21(e)(4) - OSCILLATION DETECTION**

**Applicable Standards**

Rule paragraph(s): § 20.21(e)(8)(ii)(A) Anti-Oscillation, §20.21(e)(4) Self-monitoring

For this measurement two EUTs will be permitted, one operating in a normal mode and the second operating in a test mode that is capable of disabling the uplink inactivity squelching and or a reduction of the time between restarts to 5 seconds. This will greatly decrease the test time required.

NOTE — Consumer boosters certified as direct connection mobile boosters having gain of less than or equal to 15 dB are exempt from compliance to testing procedures in 7.11.3 and 7.11.4.

**Test Procedure**

According to KDB 935210 D03 Signal Booster Measurements v04, §7.11.2 Oscillation restart tests and §7.11.3 Test procedure for measuring oscillation mitigation or shutdown

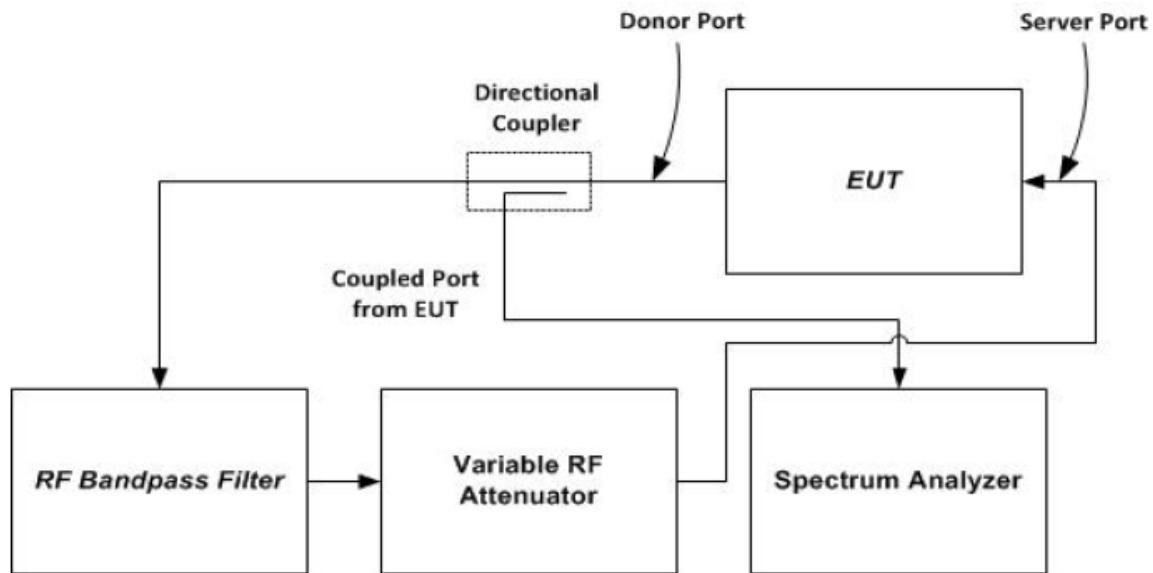

Figure 7 – Oscillation detection instrumentation test setup

**Test Data**

**Environmental Conditions**

<b>Temperature:</b>	23~25 °C
<b>Relative Humidity:</b>	50~52 %
<b>ATM Pressure:</b>	101.0~101.5 kPa

*The testing was performed by Kieron Luo from 2019-08-02 to 2019-08-08.*

**Test Result:** Compliance. Please refer to following table.



**Oscillation Restart Time:**

Mode	Operation Bands	Detection Time (s)		Power level	Between restart time (s)		Number of restart		Result		
		Reading	Limit	dBm	Reading	Limit	Reading	Limit			
Uplink	Cellular	0.144	0.3	28.73	62.02	60	4	5	Compliance		
	PCS	0.136		25.57					62.02	4	Compliance
	AWS	0.093		27.22					62.02	4	Compliance
	Lower 700	0.217		29.60					62.02	4	Compliance
	Upper 700	0.220		28.35					62.02	4	Compliance
Downlink	Cellular	0.080	1	20.38	62.02	60	4	5	Compliance		
	PCS	0.160		25.75					62.02	4	Compliance
	AWS	0.048		23.56					61.54	4	Compliance
	Lower 700	0.120		27.05					62.02	4	Compliance
	Upper 700	0.129		24.80					61.54	4	Compliance

**Oscillation Mitigation or Shutdown:**

Mode	Operation Band	Max gain dB	Isolation dB	Difference dB	Limit dB	Result
Uplink	PCS	49.5	+5	/	12.00	Compliance
			+4	/	12.00	Compliance
			+3	/	12.00	Compliance
			+2	/	12.00	Compliance
			+1	/	12.00	Compliance
			+0	/	12.00	Compliance
			-1	/	12.00	Compliance
			-2	/	12.00	Compliance
			-3	/	12.00	Compliance
	-4	/	12.00	Compliance		
	-5	/	12.00	Compliance		
	Cellular	49.95	+5	/	12.00	Compliance
			+4	/	12.00	Compliance
			+3	/	12.00	Compliance
			+2	/	12.00	Compliance
			+1	/	12.00	Compliance
			+0	/	12.00	Compliance
			-1	/	12.00	Compliance
			-2	/	12.00	Compliance
			-3	/	12.00	Compliance
	-4	/	12.00	Compliance		
	-5	/	12.00	Compliance		
	AWS	49.76	+5	/	12.00	Compliance
			+4	/	12.00	Compliance
			+3	/	12.00	Compliance
			+2	/	12.00	Compliance
			+1	/	12.00	Compliance
			+0	/	12.00	Compliance
			-1	/	12.00	Compliance
			-2	/	12.00	Compliance
			-3	/	12.00	Compliance
	-4	/	12.00	Compliance		
	-5	/	12.00	Compliance		
	Lower 700MHz	49.82	+5	/	12.00	Compliance
			+4	/	12.00	Compliance
			+3	/	12.00	Compliance
+2			/	12.00	Compliance	
+1			/	12.00	Compliance	
+0			/	12.00	Compliance	
-1			/	12.00	Compliance	
-2			/	12.00	Compliance	
-3			/	12.00	Compliance	
-4	/	12.00	Compliance			
-5	/	12.00	Compliance			

Mode	Operation Band	Max gain dB	Isolation dB	Difference dB	Limit dB	Result
Uplink	Upper 700MHz	49.14	+5	/	12.00	Compliance
			+4	/	12.00	Compliance
			+3	/	12.00	Compliance
			+2	/	12.00	Compliance
			+1	/	12.00	Compliance
			+0	/	12.00	Compliance
			-1	/	12.00	Compliance
			-2	/	12.00	Compliance
			-3	/	12.00	Compliance
			-4	/	12.00	Compliance
Downlink	PCS	48.8	+5	4.15	12.00	Compliance
			+4	/	12.00	Compliance
			+3	/	12.00	Compliance
			+2	/	12.00	Compliance
			+1	/	12.00	Compliance
			+0	/	12.00	Compliance
			-1	/	12.00	Compliance
			-2	/	12.00	Compliance
			-3	/	12.00	Compliance
			-4	/	12.00	Compliance
	-5	/	12.00	Compliance		
	Cellular	49.56	+5	7.00	12.00	Compliance
			+4	/	12.00	Compliance
			+3	/	12.00	Compliance
			+2	/	12.00	Compliance
			+1	/	12.00	Compliance
			+0	/	12.00	Compliance
			-1	/	12.00	Compliance
			-2	/	12.00	Compliance
			-3	/	12.00	Compliance
			-4	/	12.00	Compliance
	-5	/	12.00	Compliance		
	AWS	49.2	+5	5.49	12.00	Compliance
			+4	/	12.00	Compliance
			+3	/	12.00	Compliance
			+2	/	12.00	Compliance
			+1	/	12.00	Compliance
			+0	/	12.00	Compliance
			-1	/	12.00	Compliance
			-2	/	12.00	Compliance
-3			/	12.00	Compliance	
-4			/	12.00	Compliance	
-5	/	12.00	Compliance			

Mode	Operation Band	Max gain dB	Isolation dB	Difference dB	Limit dB	Result
Downlink	700MHz	49.75	+5	6.75	12.00	Compliance
			+4	5.11	12.00	Compliance
			+3	6.92	12.00	Compliance
			+2	/	12.00	Compliance
			+1	/	12.00	Compliance
			+0	/	12.00	Compliance
			-1	/	12.00	Compliance
			-2	/	12.00	Compliance
			-3	/	12.00	Compliance
			-4	/	12.00	Compliance
-5	/	12.00	Compliance			

**Oscillation restart tests:**

Downlink:

**Cellular Band**

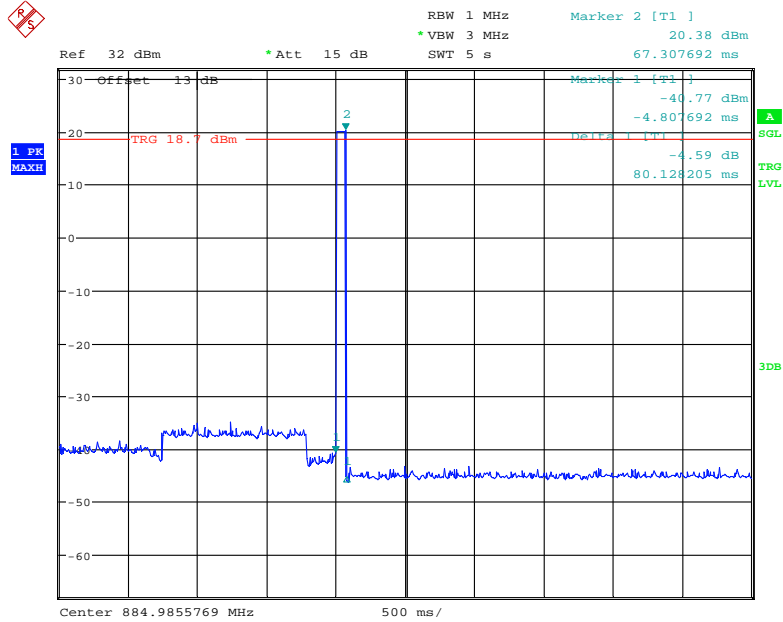

Date: 8.AUG.2019 05:58:28

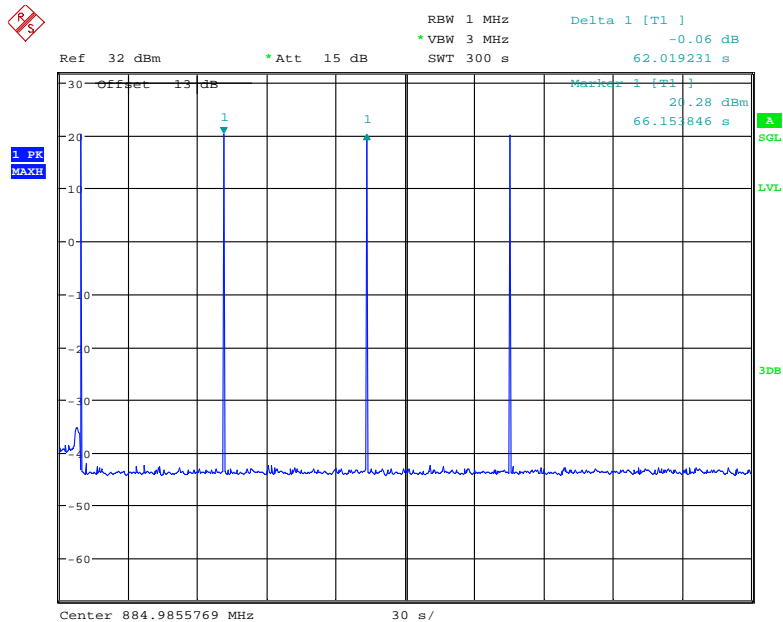

Date: 8.AUG.2019 06:05:18

### PCS Band

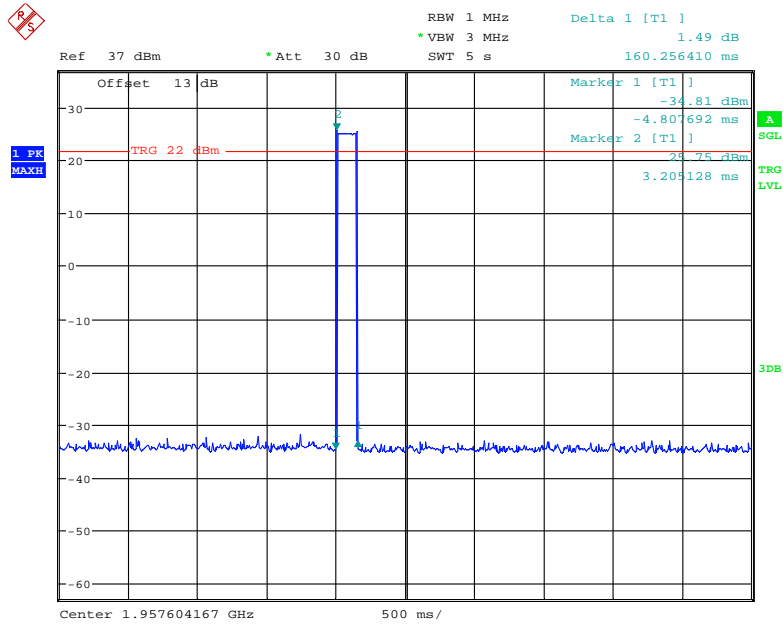

Date: 2.AUG.2019 10:51:17

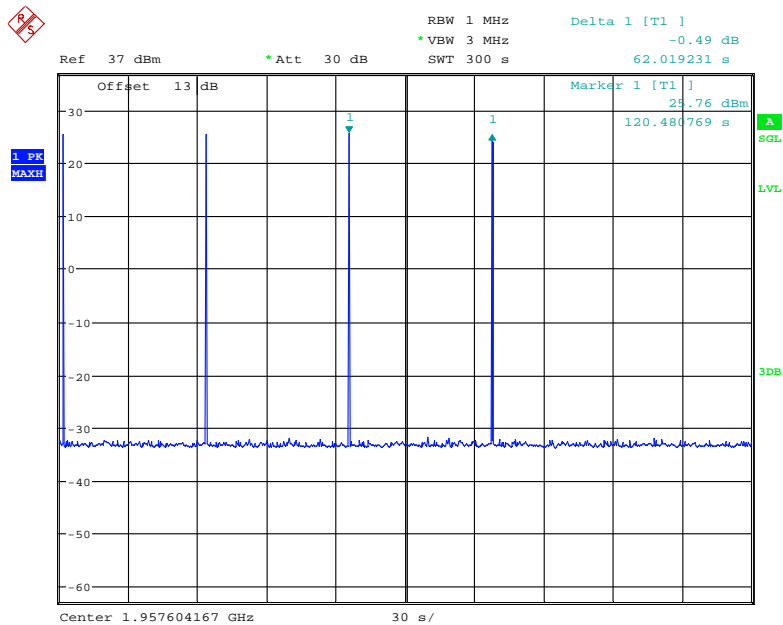

Date: 2.AUG.2019 11:06:23

### AWS Band

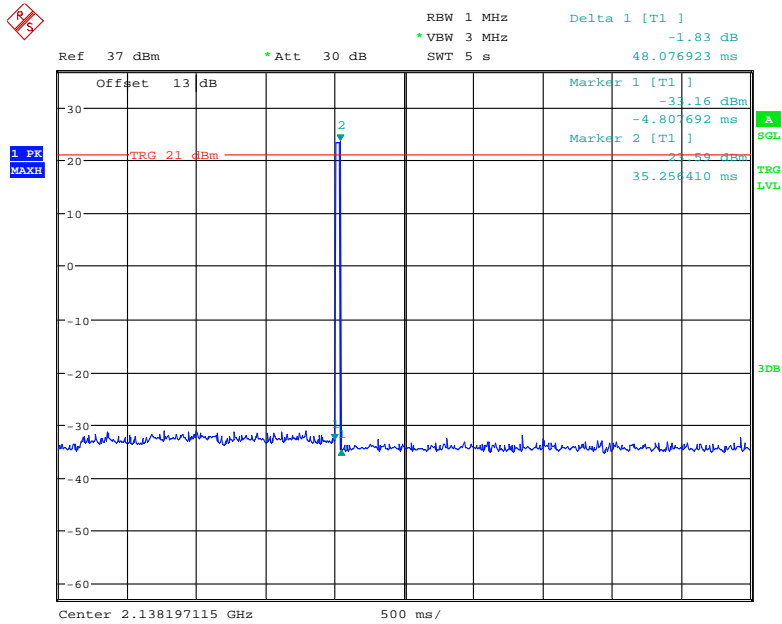

Date: 2.AUG.2019 11:10:46

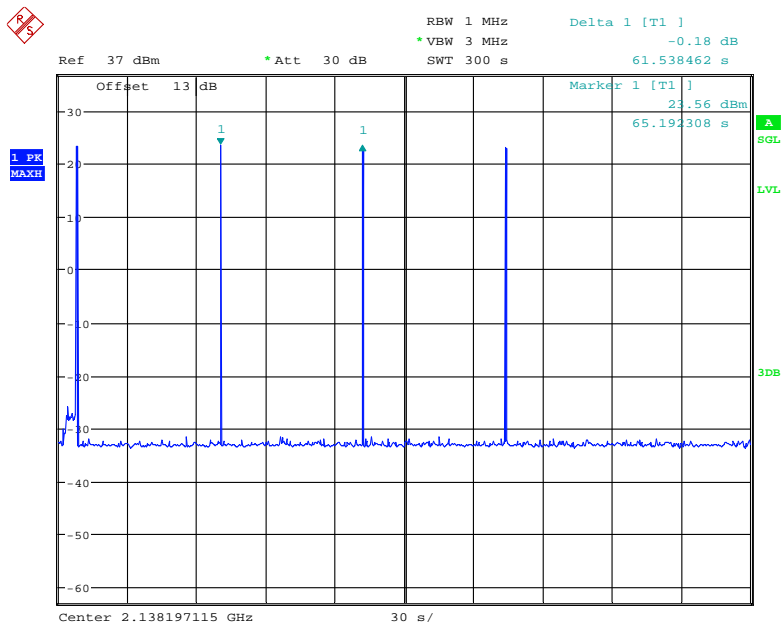

Date: 2.AUG.2019 11:16:55

Lower 700MHz

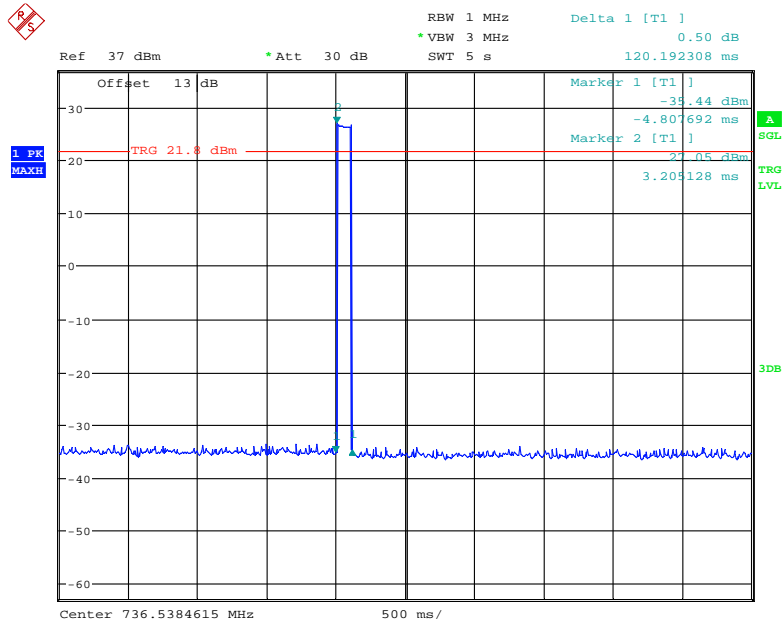

Date: 2.AUG.2019 09:55:02

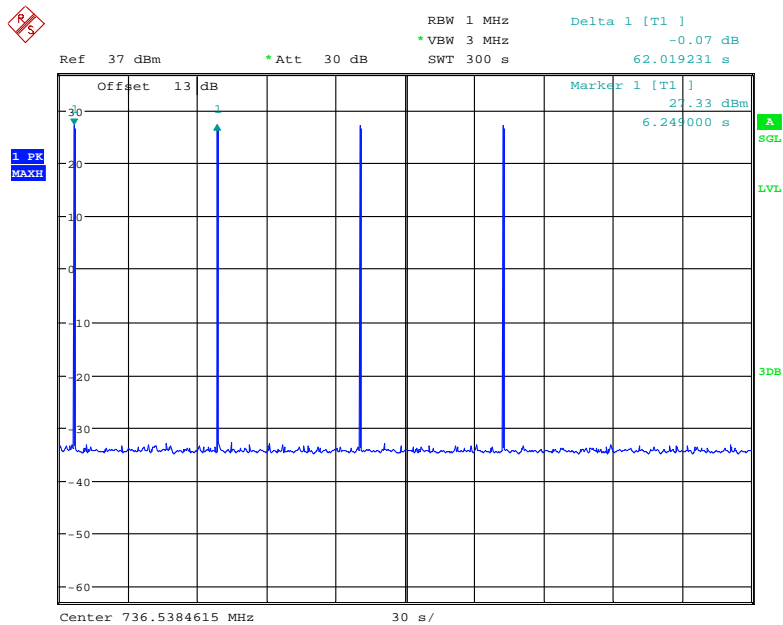

Date: 2.AUG.2019 10:01:15



### Upper 700MHz

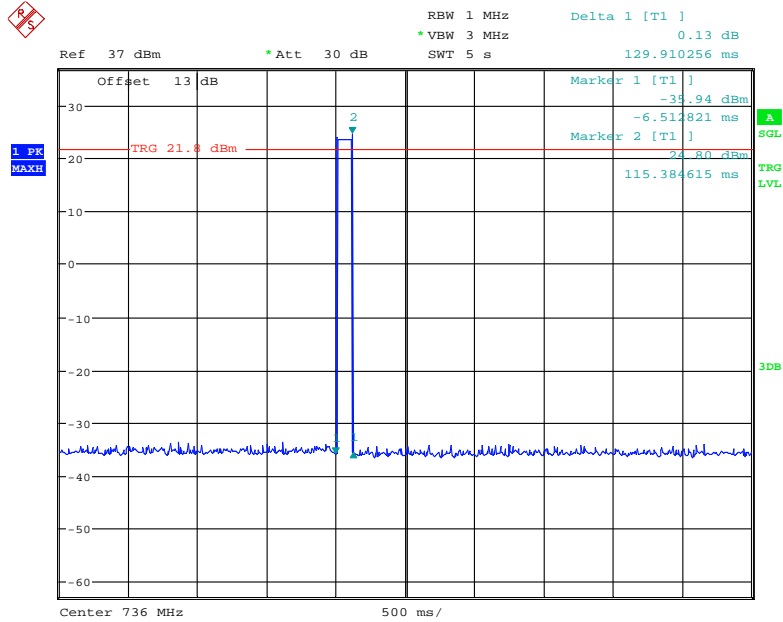

Date: 2.AUG.2019 10:09:37

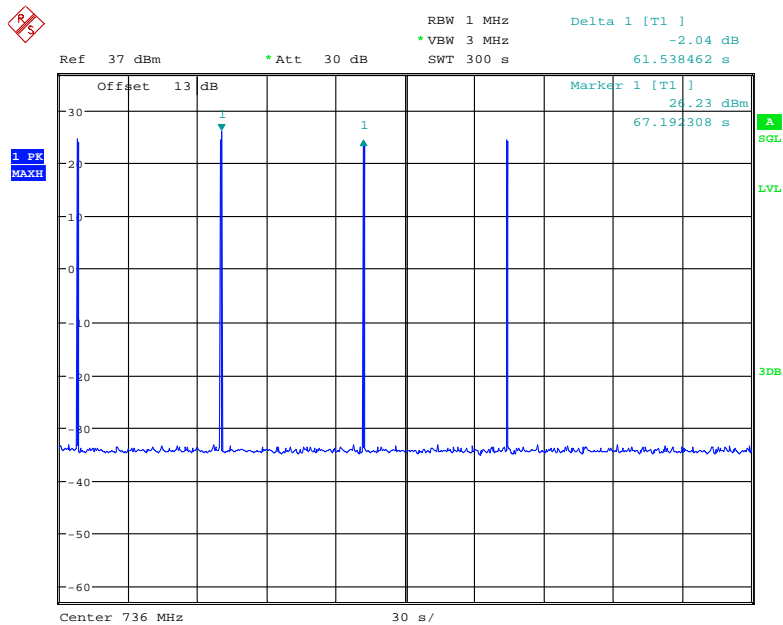

Date: 2.AUG.2019 10:17:30

Uplink:

**Cellular Band**

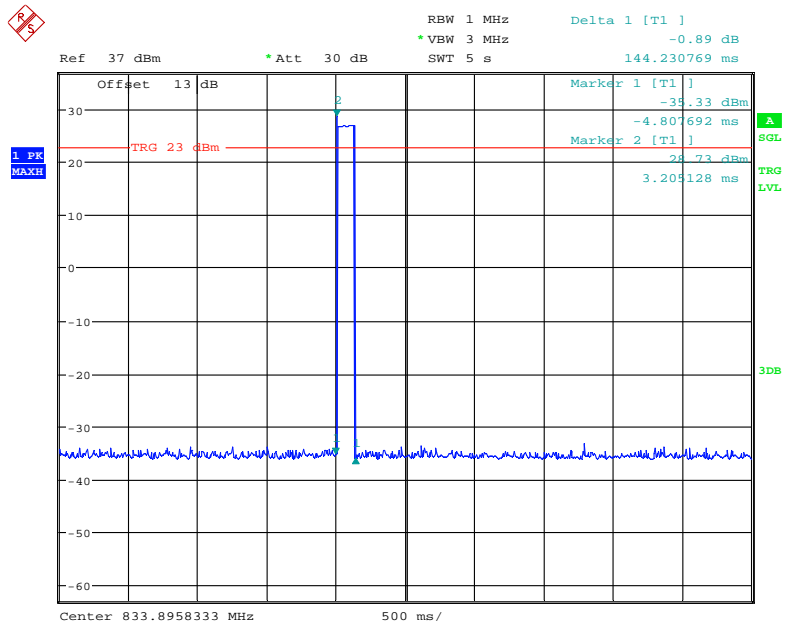

Date: 2.AUG.2019 12:29:45

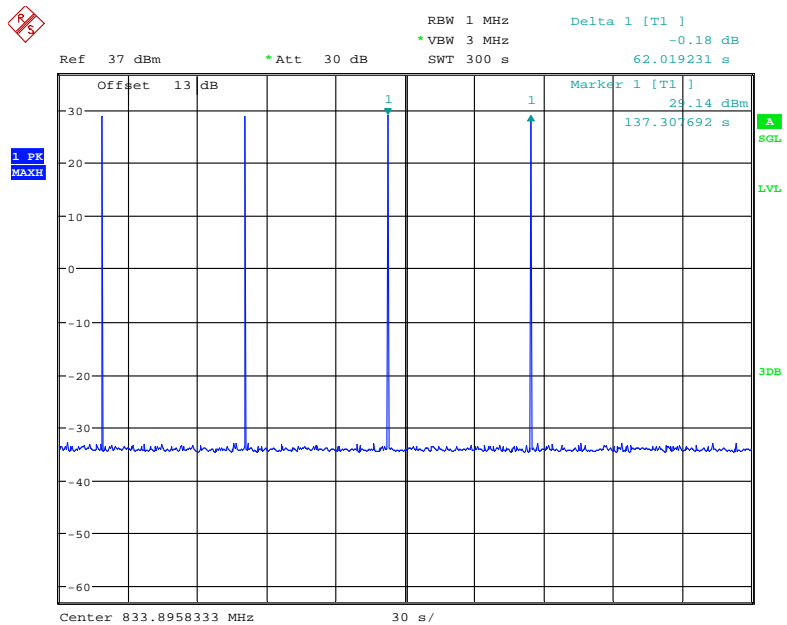

Date: 2.AUG.2019 12:35:42

### PCS Band

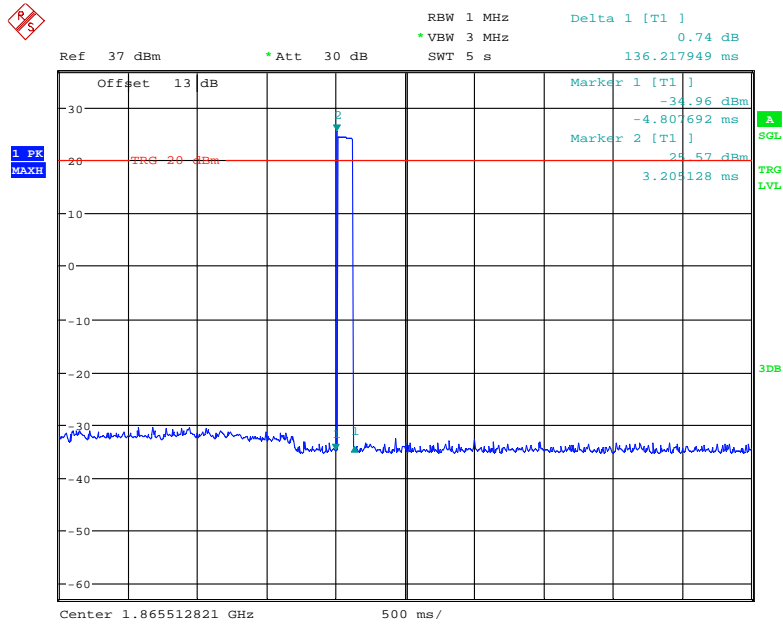

Date: 2.AUG.2019 12:14:32

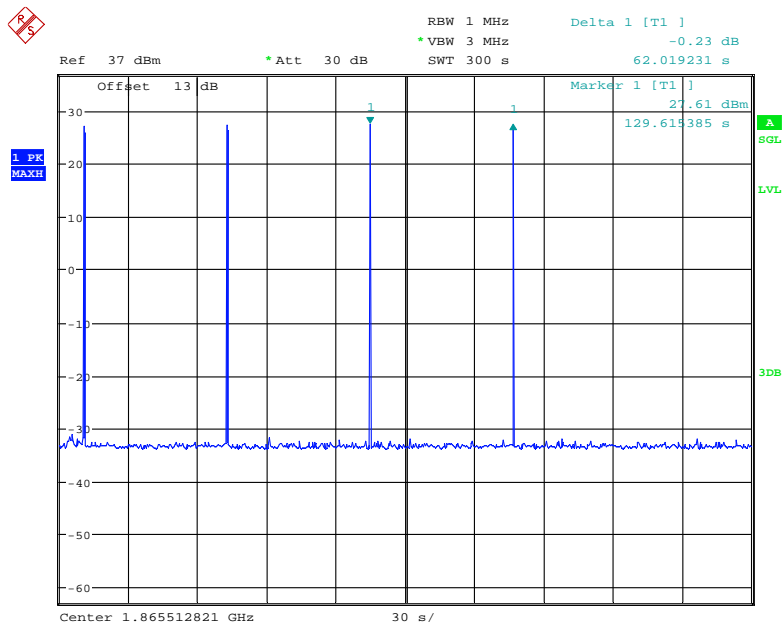

Date: 2.AUG.2019 12:21:28

### AWS Band

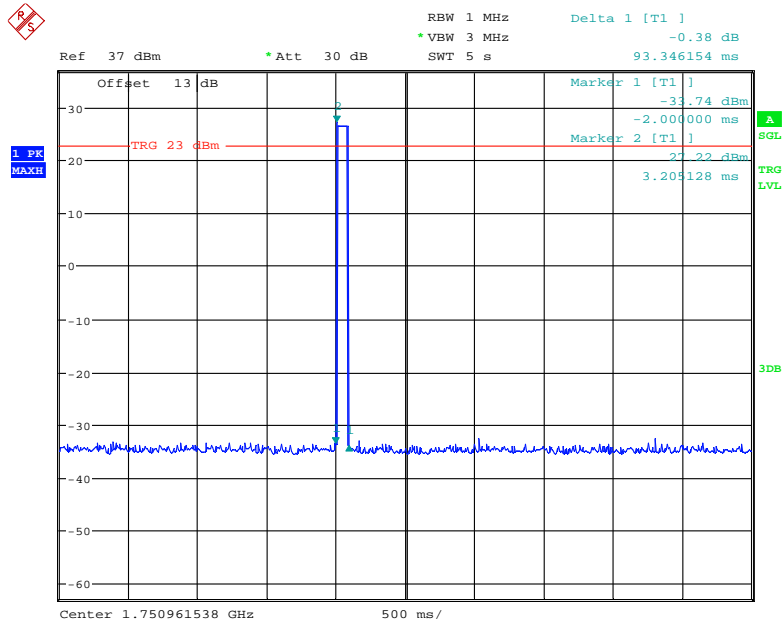

Date: 2.AUG.2019 12:39:19

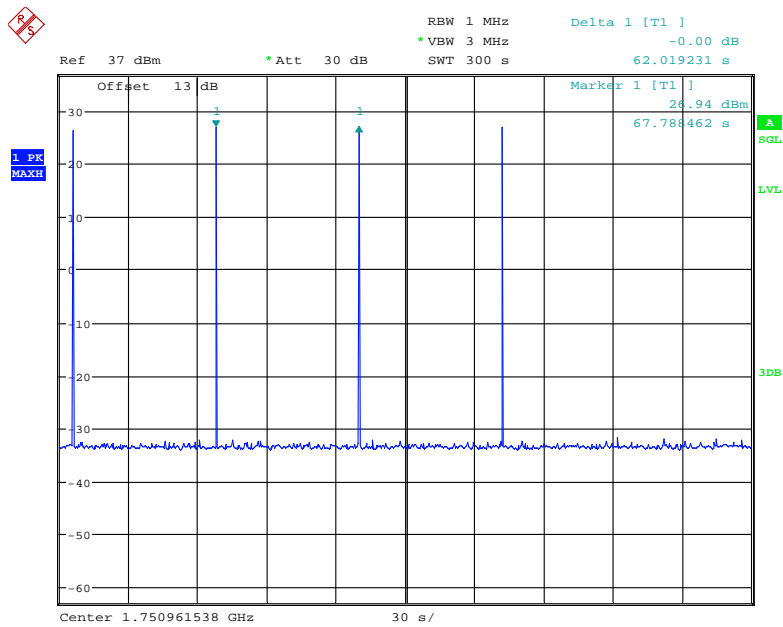

Date: 2.AUG.2019 12:58:58

### Lower 700MHz

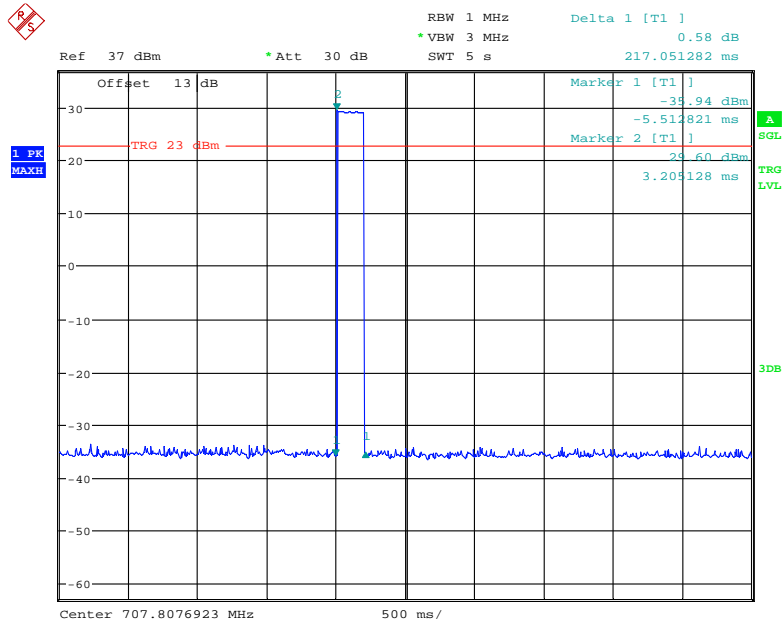

Date: 2.AUG.2019 13:05:39

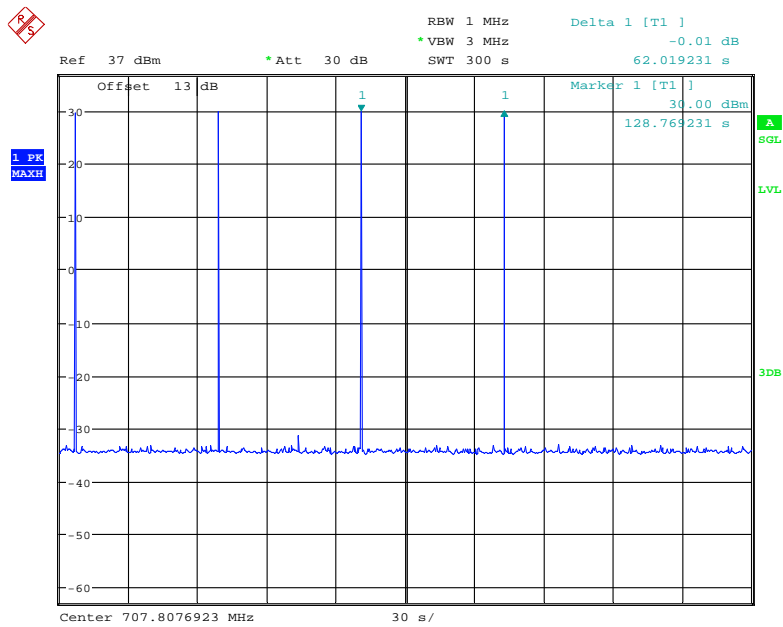

Date: 2.AUG.2019 13:11:43

### Upper 700MHz

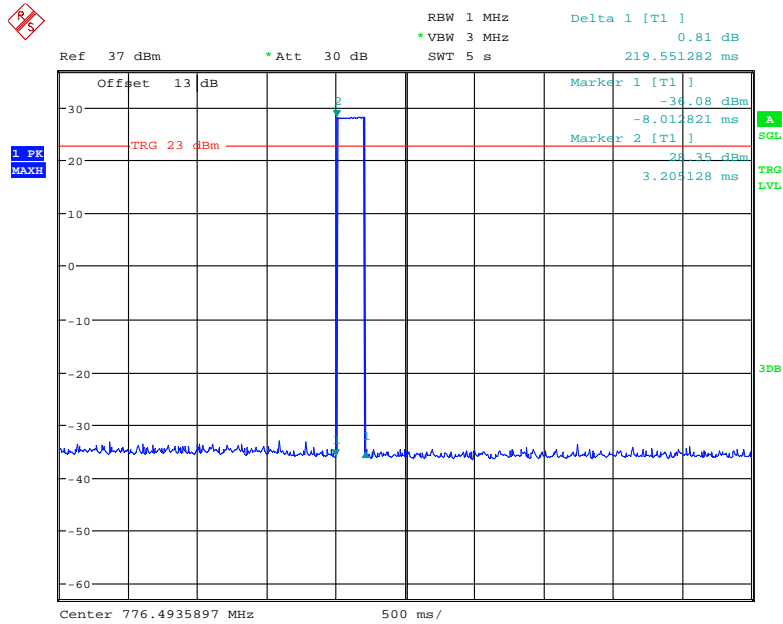

Date: 2.AUG.2019 13:14:03

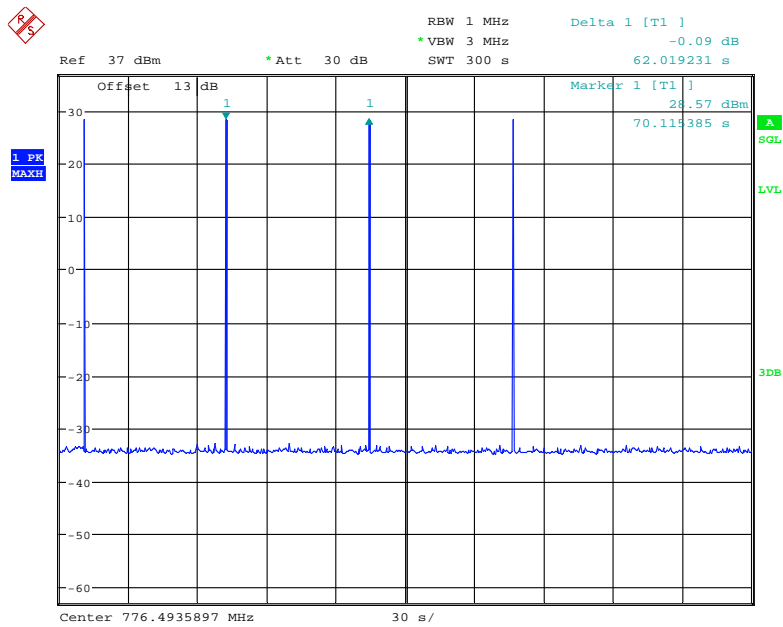

Date: 2.AUG.2019 13:20:09

## **§2.1051- SPURIOUS EMISSIONS AT ANTENNA TERMINALS**

### **Applicable Standards**

FCC §2.1051 *Measurements required: Spurious emissions at antenna terminals.*

§20.21(e)(8)(i)(E): Booster out of band emissions (OOBE) shall be at least 6 dB below the FCC's mobile emission limits for the supported bands of operation. Compliance to OOBE limits will utilize high peak-to-average CMRS signal types.

§22.917 (a) Out of band emissions. The power of any emission outside of the authorized operating frequency ranges must be attenuated below the transmitting power (P) by a factor of at least  $43 + 10 \log(P)$  dB.

§24.238 (a) Out of band emissions. The power of any emission outside of the authorized operating frequency ranges must be attenuated below the transmitting power (P) by a factor of at least  $43 + 10 \log(P)$  dB.

§27.53: the power of any emission shall be attenuated outside the band below the transmitter power (P) by at least  $43 + 10 \log(P)$  dB;

### **Test Procedure**

The following procedures shall be used to demonstrate compliance to the applicable conducted spurious emissions limits as per § 2.1051.

**Note:** *For frequencies below 1 GHz, an RBW of 1 MHz may be used in a preliminary measurement. If non-compliant emissions are detected, a final measurement shall be made with a 100 kHz RBW. Additionally, a peak detector may also be used for the preliminary measurement. If non-compliant emissions are detected then a final measurement of these emissions shall be made with the power averaging (RMS) detector.*

- a) Connect the EUT to the test equipment as shown in **Figure 1**. Begin with the uplink output connected to the spectrum analyzer.
- b) Configure the signal generator for AWGN with a 99% occupied bandwidth of 4.1 MHz with a center frequency corresponding to the center of the CMRS band under test.
- c) Set the signal generator amplitude to the level determined in the power measurement procedure in 7.2.
- d) Turn on the signal generator RF output and measure the spurious emission power levels with an appropriate measurement instrument as follows.
  - 1) Set RBW = measurement bandwidth specified in the applicable rule section for the operational frequency band under consideration (see Annex A for relevant cross-references). Note that many of the individual rule sections permit the use of a narrower RBW (typically  $\geq 1\%$  of the emission bandwidth) to enhance measurement accuracy, but the result must then be integrated over the specified measurement bandwidth.
  - 2) Set VBW =  $3 \times$  RBW.
  - 3) Select the power averaging (RMS) detector. (See above note regarding the use of a peak detector for preliminary measurements.)
  - 4) Sweep time = auto-couple.
  - 5) Set the analyzer start frequency to the lowest radio frequency signal generated in the equipment, without going below 9 kHz, and the stop frequency to the lower band/block edge frequency minus 100 kHz or 1 MHz, as specified in the applicable rule part. Note that the number of measurement points in each sweep

must be  $\geq (2 \times \text{span}/\text{RBW})$  which may require that the measurement range defined by the start and stop frequencies above be subdivided, depending on the available number of measurement points provided by the spectrum analyzer. Trace average at least 10 traces in power averaging (i.e., RMS) mode.

6) Use the peak marker function to identify the highest amplitude level over each measured frequency range. Record the frequency and amplitude and capture a plot for inclusion in the test report.

7) Reset the analyzer start frequency to the upper band/block edge frequency plus 100 kHz or 1 MHz, as specified in the applicable rule part, and the analyzer stop frequency to  $10 \times$  the highest frequency of the fundamental emission. Note that the number of measurement points in each sweep must be  $\geq (2 \times \text{span}/\text{RBW})$  which may require that the measurement range defined by the start and stop frequencies above be subdivided, depending on the available number of measurement points provided by the spectrum analyzer.

8) Use the peak marker function to identify the highest amplitude level over each of the measured frequency ranges. Record the frequency and amplitude and capture a plot for inclusion in the test report.

e) Repeat 7.6b) through 7.6d) for each supported frequency band of operation.

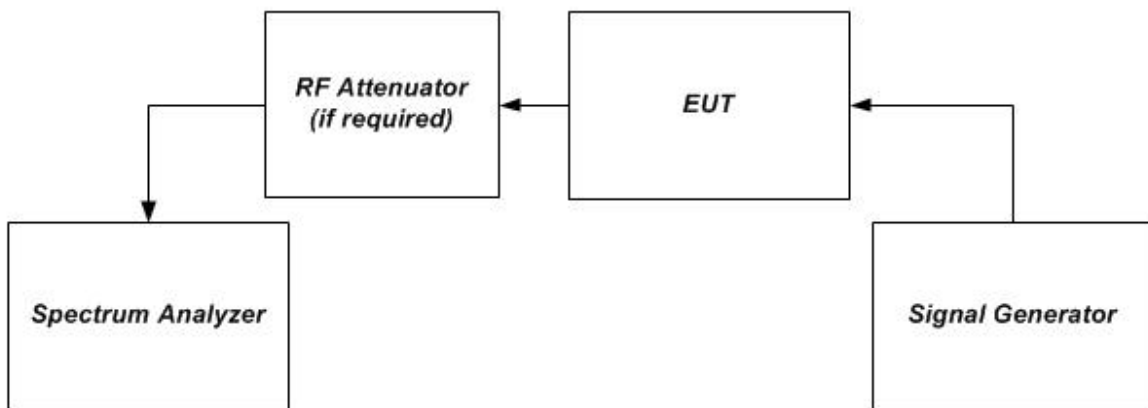

Figure 1 – Band verification test instrumentation setup

**Test Data**

**Environmental Conditions**

<b>Temperature:</b>	24 °C
<b>Relative Humidity:</b>	52 %
<b>ATM Pressure:</b>	101.2 kPa

*The testing was performed by Kieron Luo on 2019-08-15.*

*Test Mode: Transmitting, please refer to the following plots.*

*Test Result: Compliance.*



Downlink:

### Cellular Band

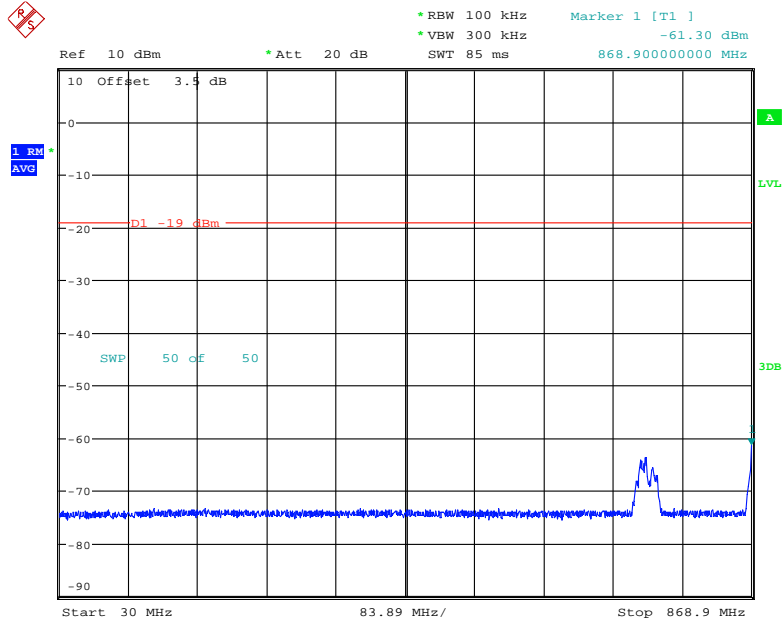

Date: 15.AUG.2019 07:03:31

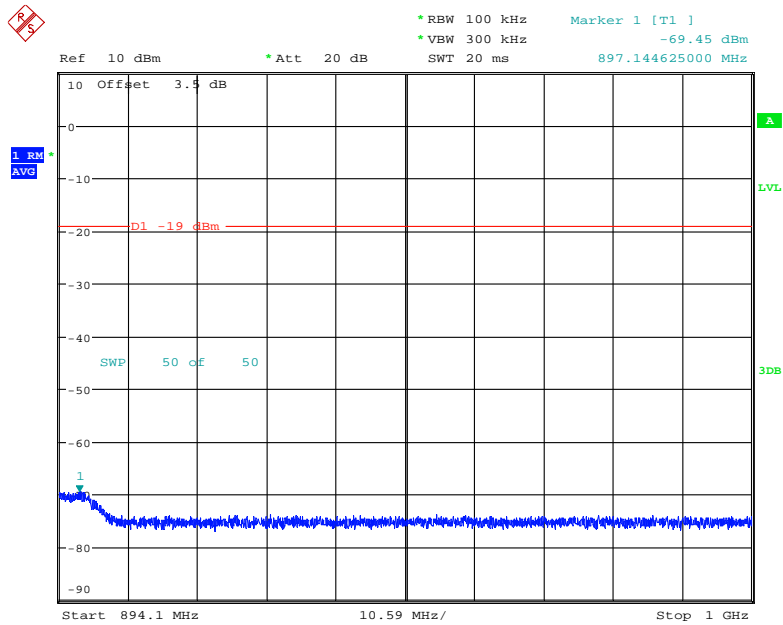

Date: 15.AUG.2019 07:04:29

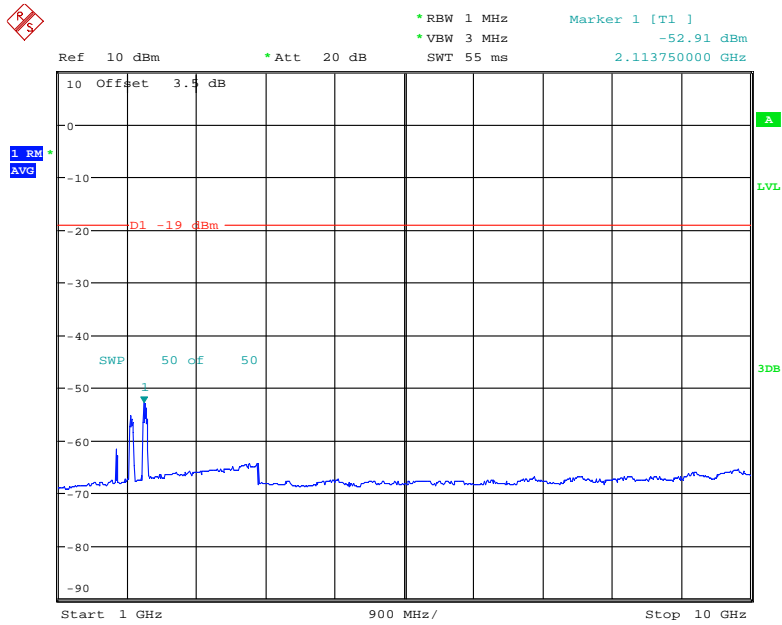

Date: 15.AUG.2019 07:02:30

### PCS Band

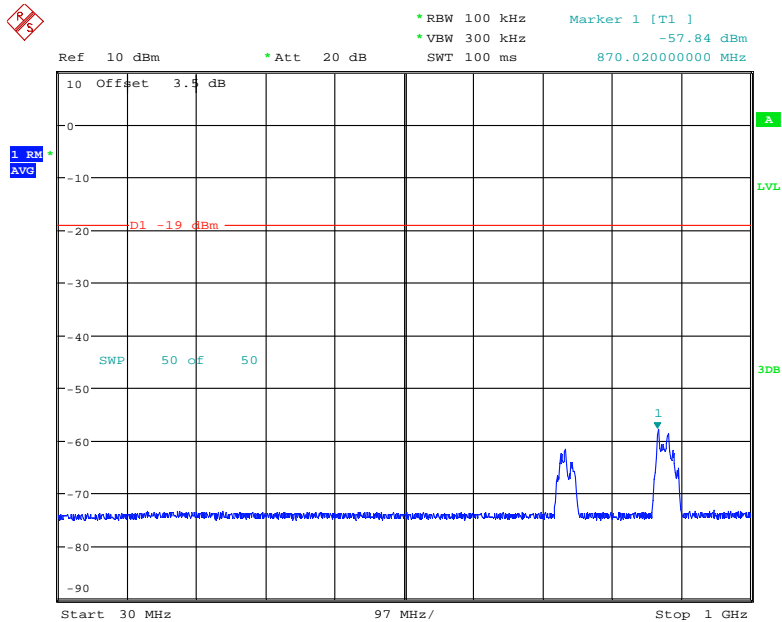

Date: 15.AUG.2019 06:59:30

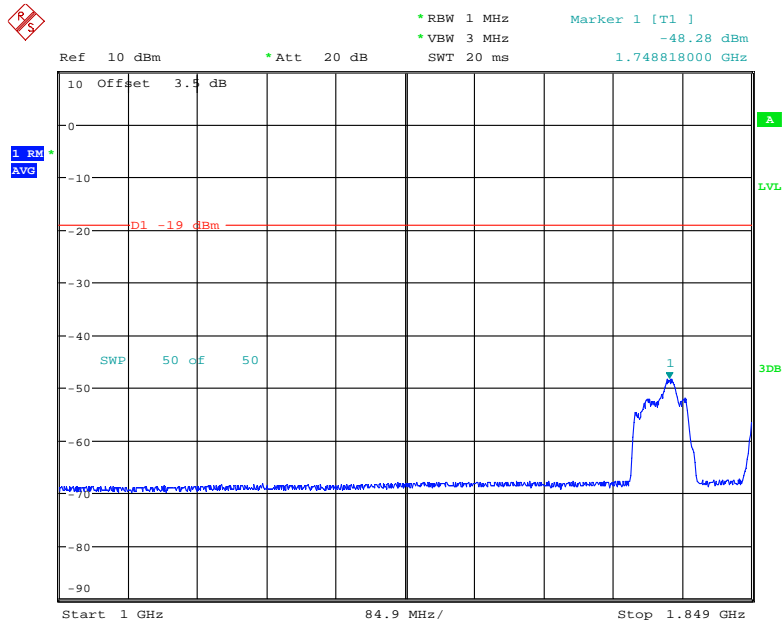

Date: 15.AUG.2019 06:33:10

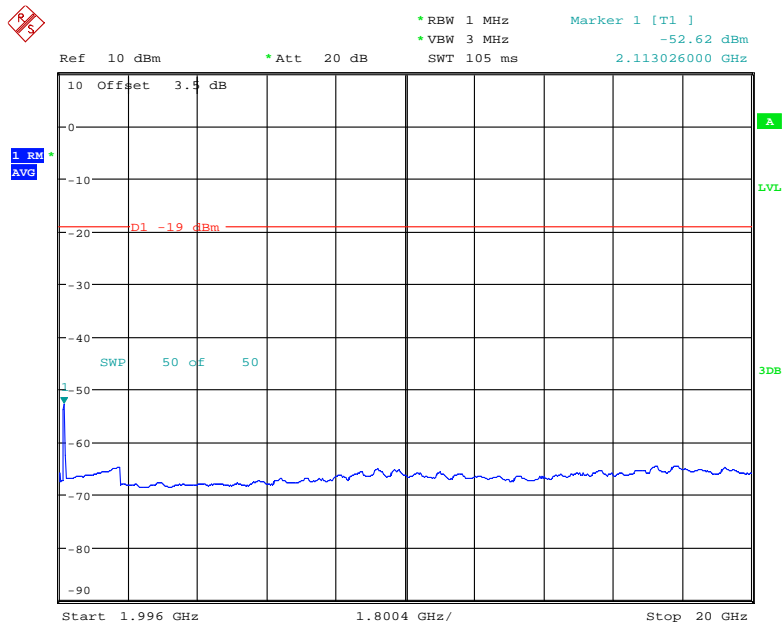

Date: 15.AUG.2019 07:01:17

### AWS Band

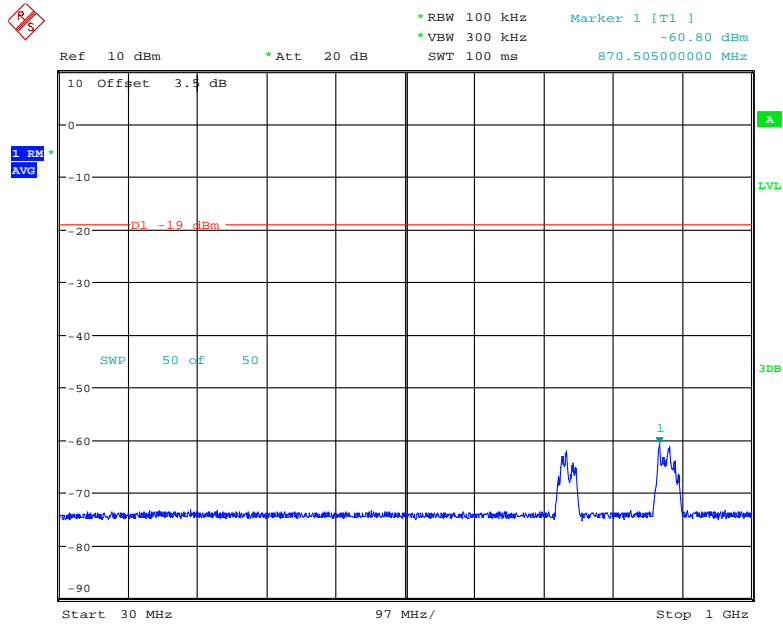

Date: 15.AUG.2019 07:05:51

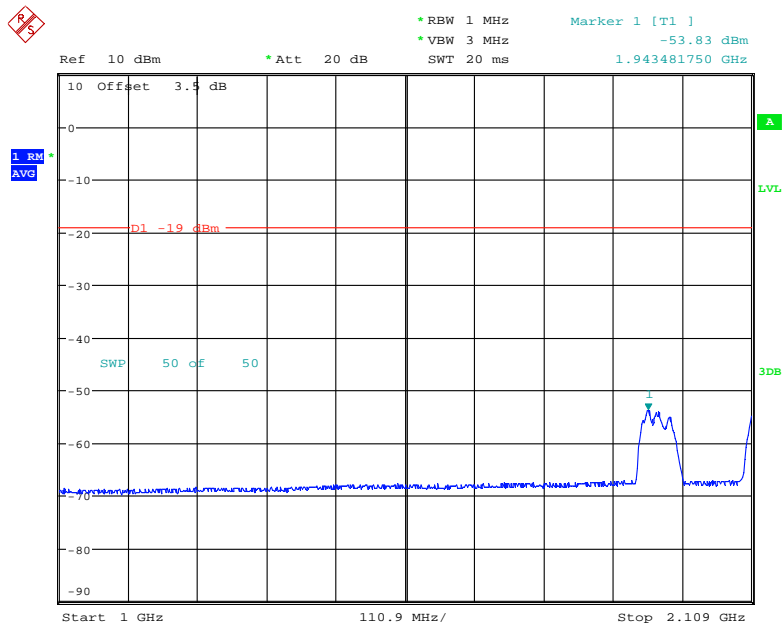

Date: 15.AUG.2019 07:06:40

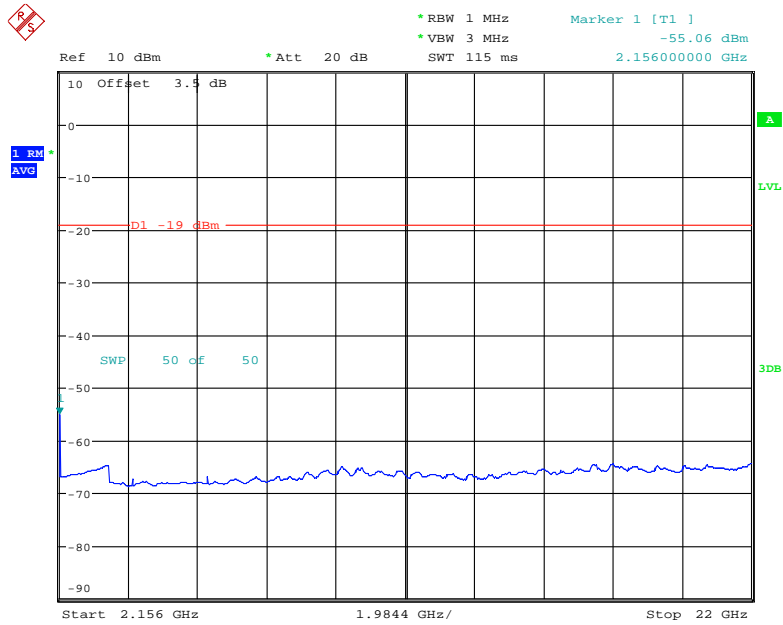

Date: 15.AUG.2019 07:07:34

### Lower 700MHz

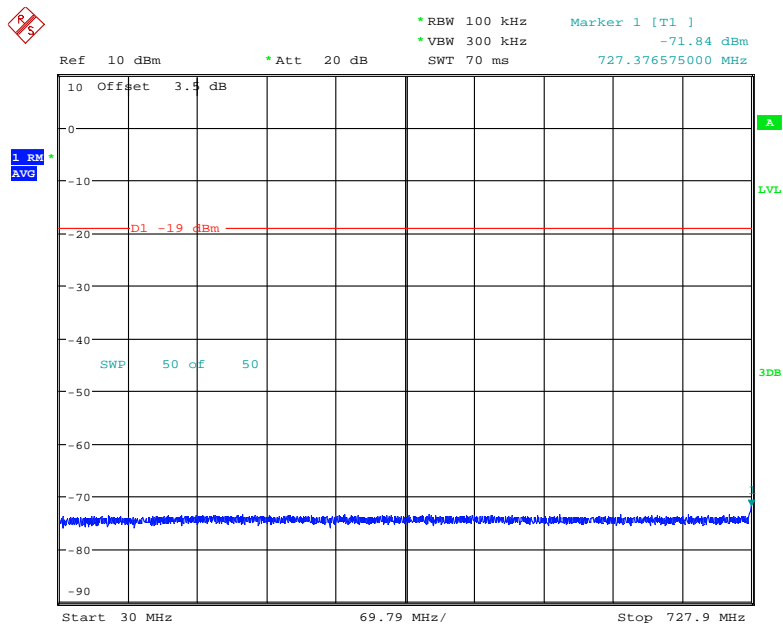

Date: 15.AUG.2019 07:09:43

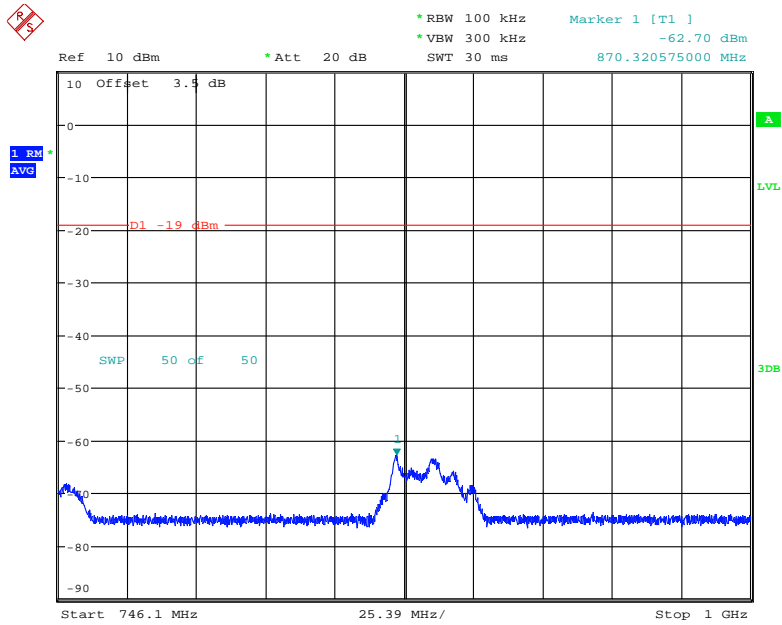

Date: 15.AUG.2019 07:10:24

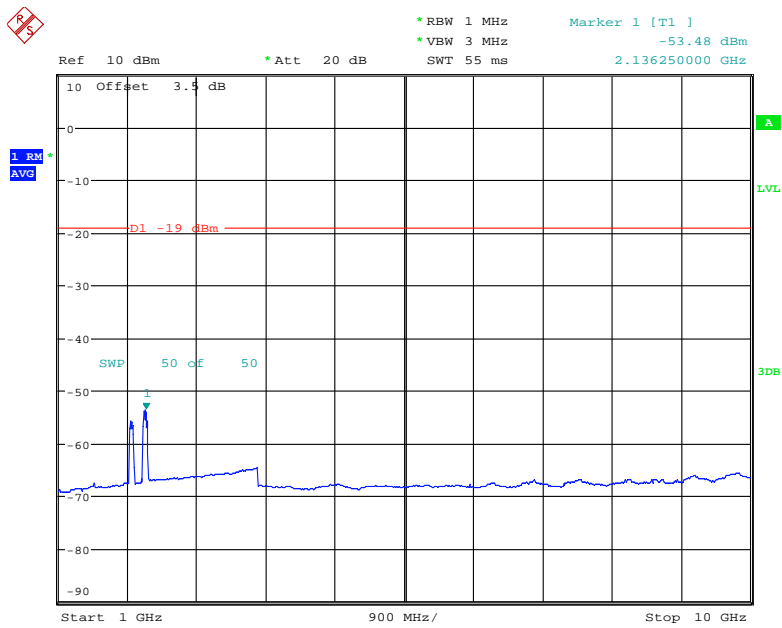

Date: 15.AUG.2019 07:08:48

### Upper 700MHz

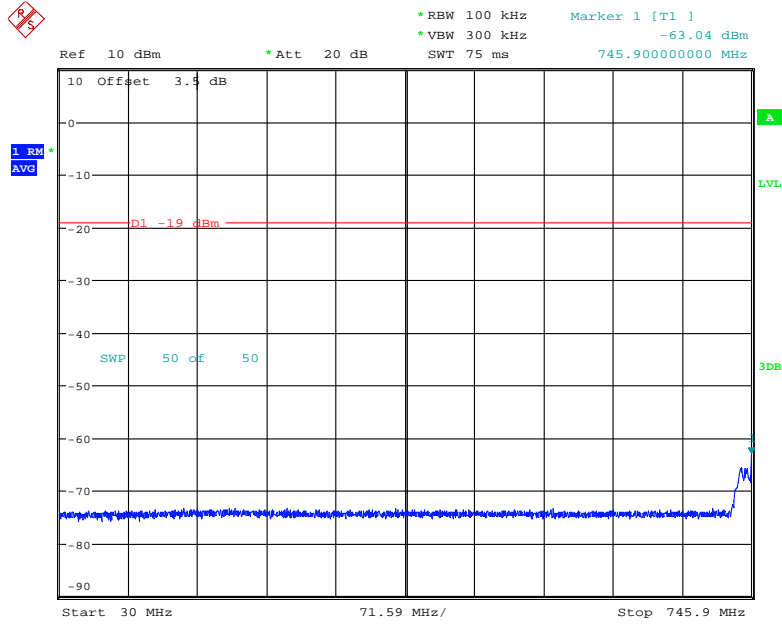

Date: 15.AUG.2019 07:11:37

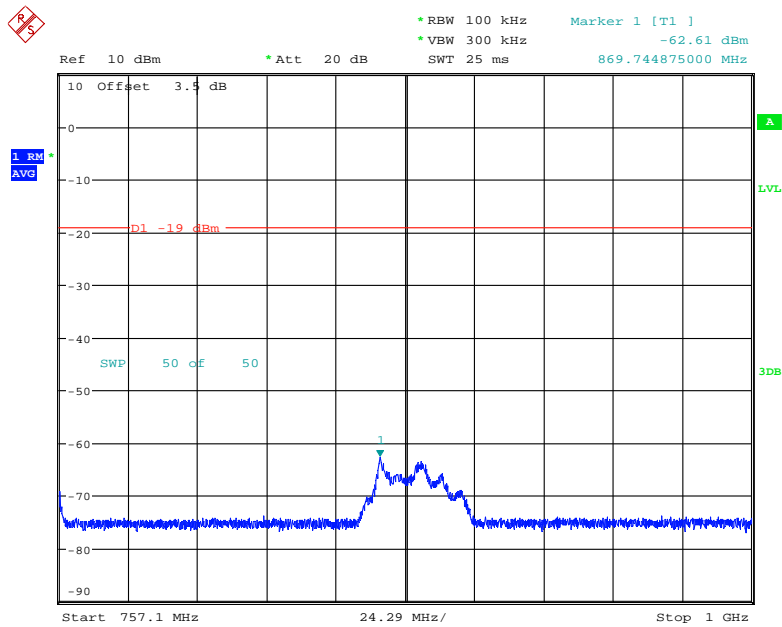

Date: 15.AUG.2019 07:12:40

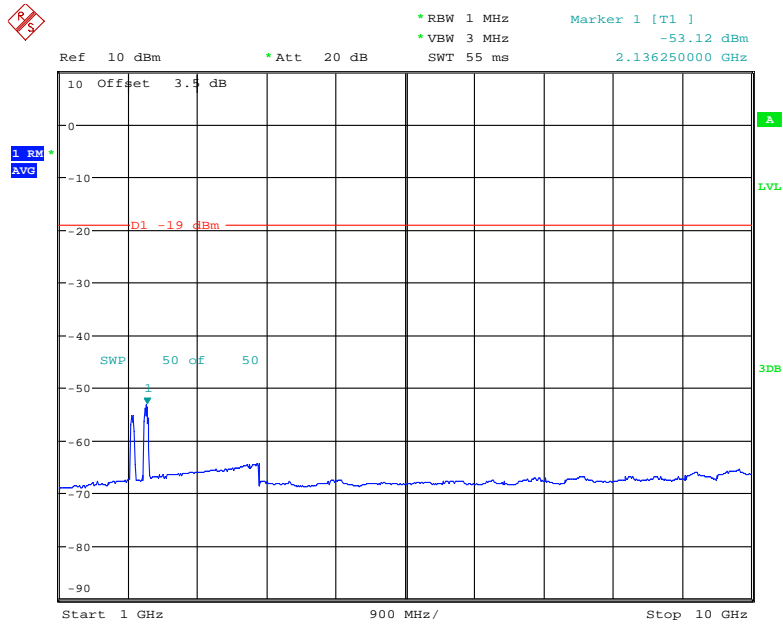

Date: 15.AUG.2019 07:13:20

Uplink:

### Cellular Band

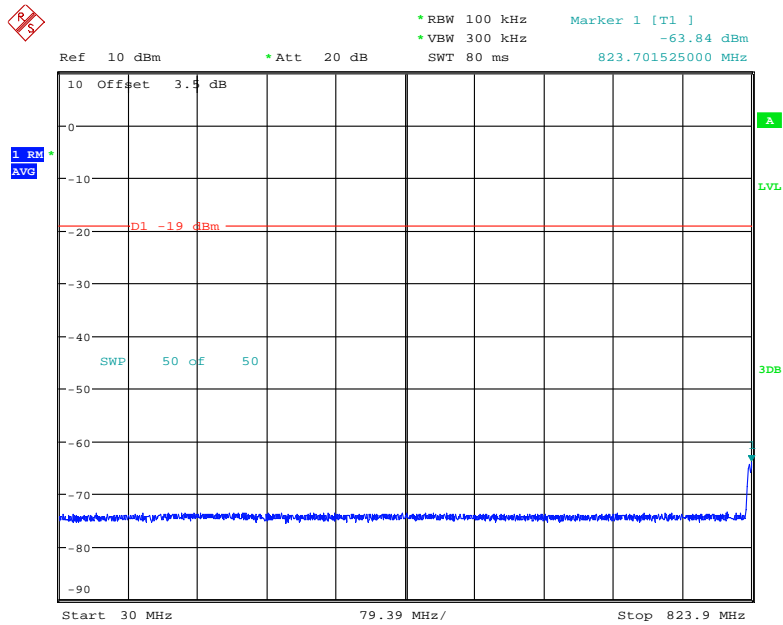

Date: 15.AUG.2019 06:37:56



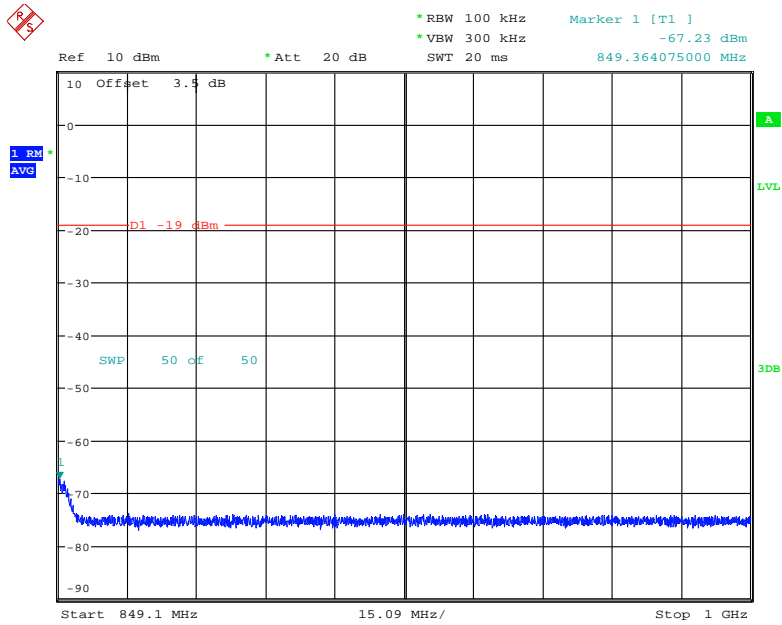

Date: 15.AUG.2019 06:39:16

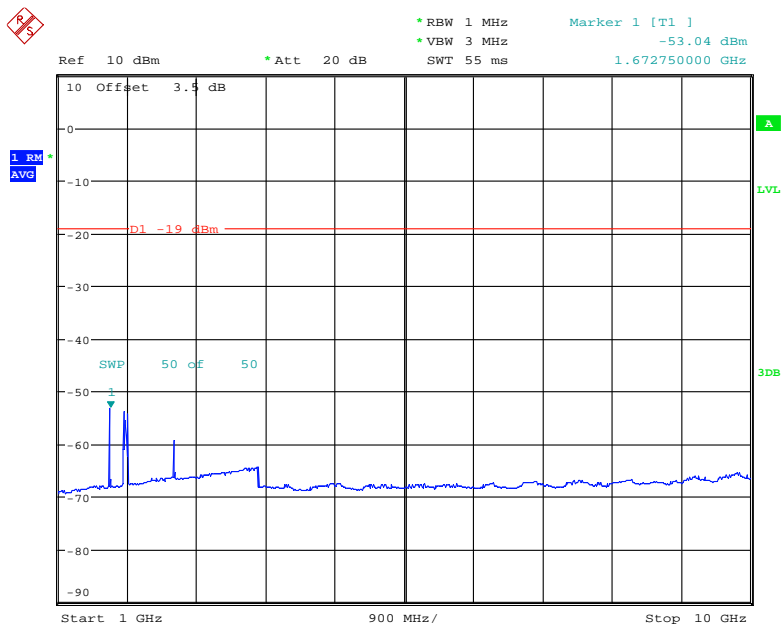

Date: 15.AUG.2019 06:41:03

### PCS Band

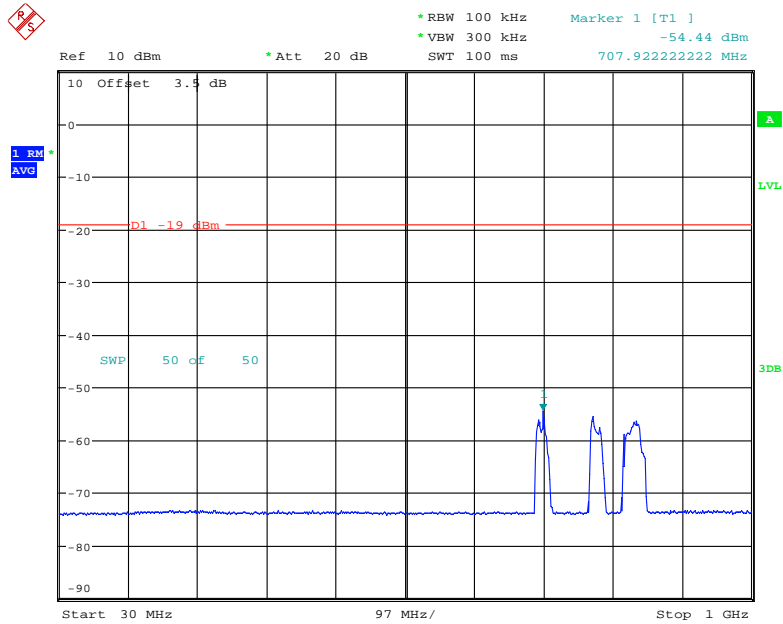

Date: 15.AUG.2019 06:27:11

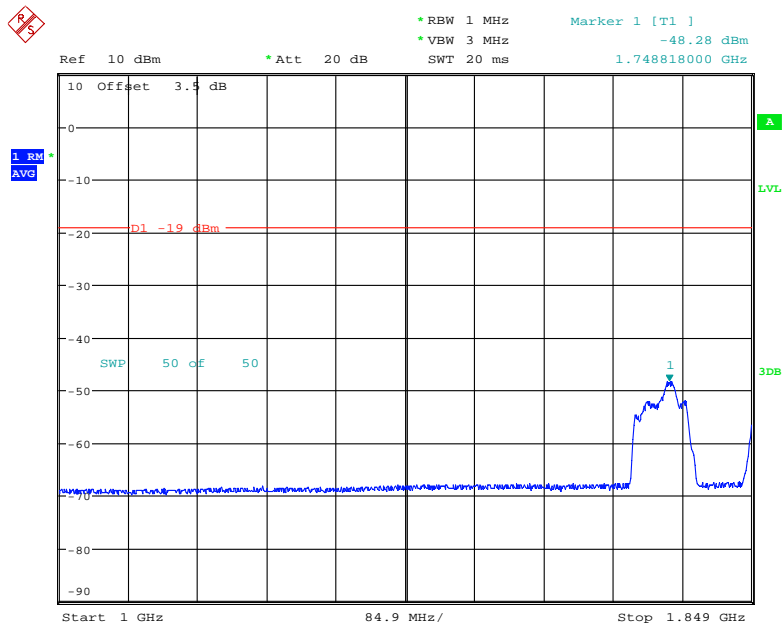

Date: 15.AUG.2019 06:33:10

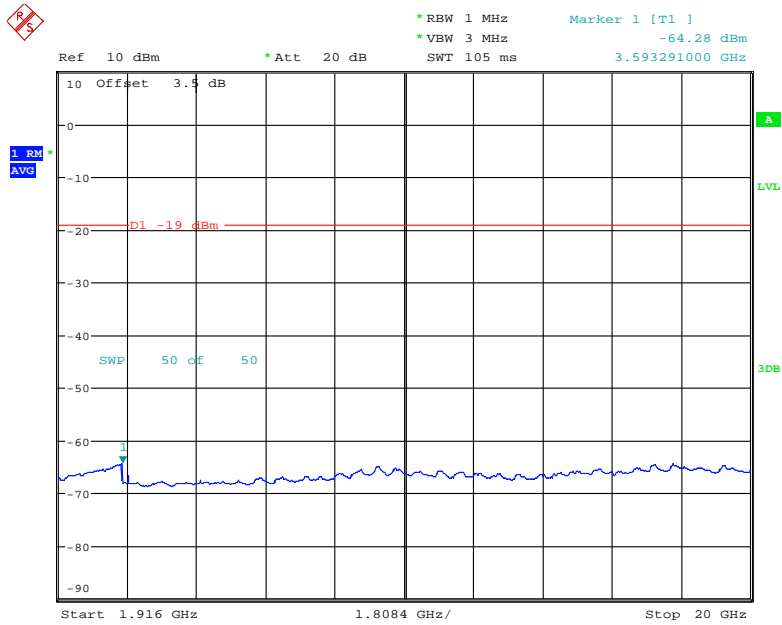

Date: 15.AUG.2019 06:33:53

### AWS Band

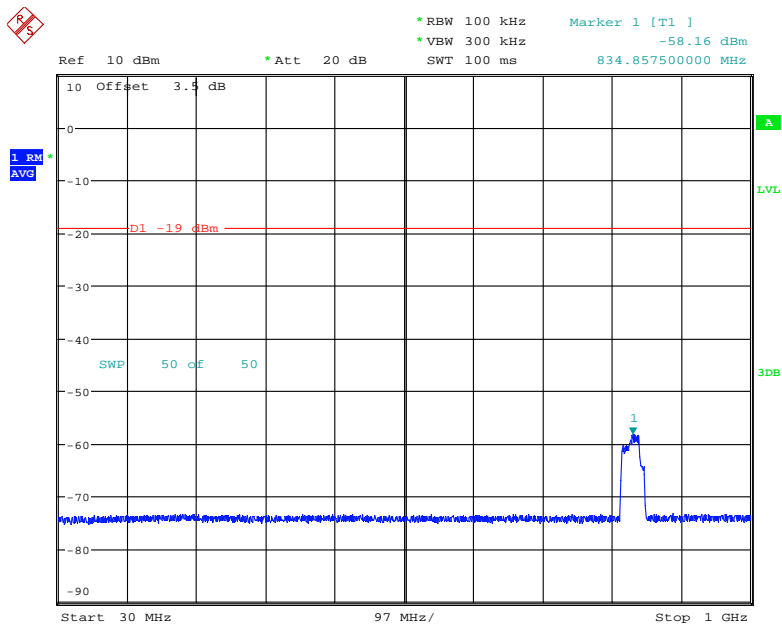

Date: 15.AUG.2019 06:45:12

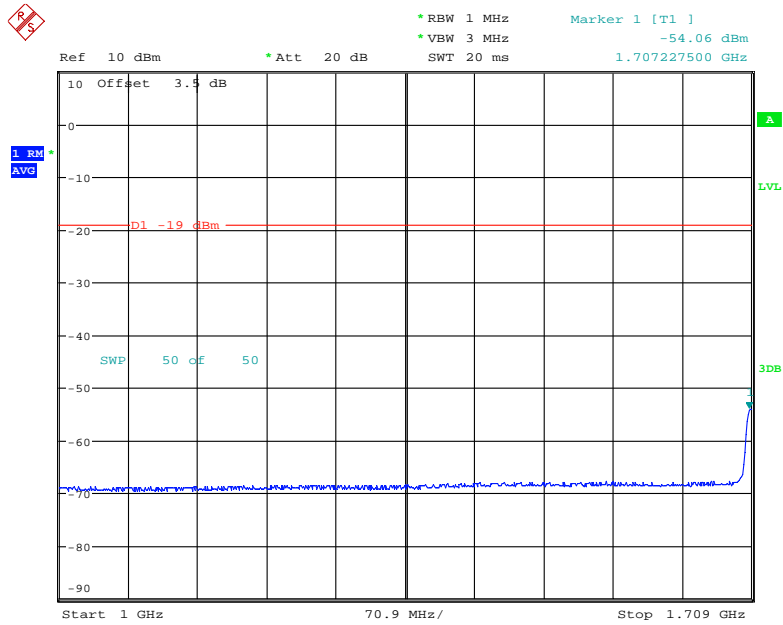

Date: 15.AUG.2019 06:42:33

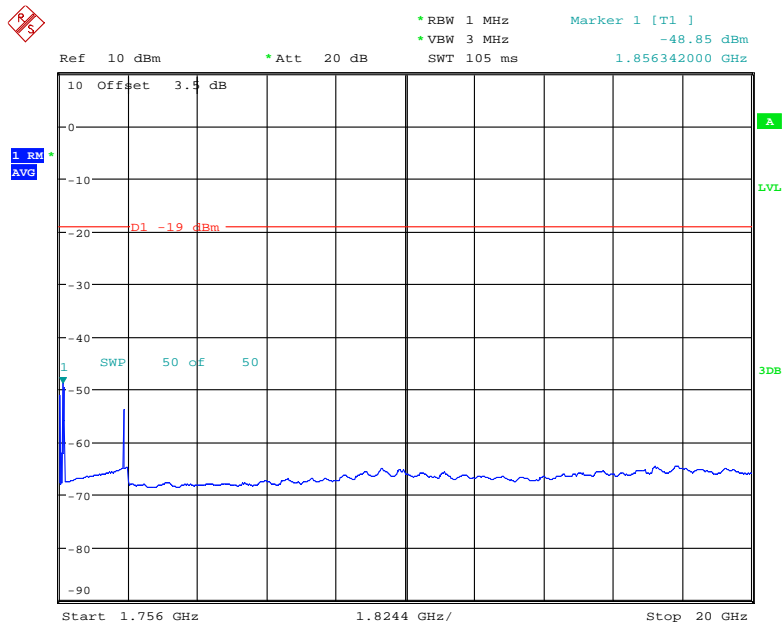

Date: 15.AUG.2019 06:44:29

### Lower 700MHz

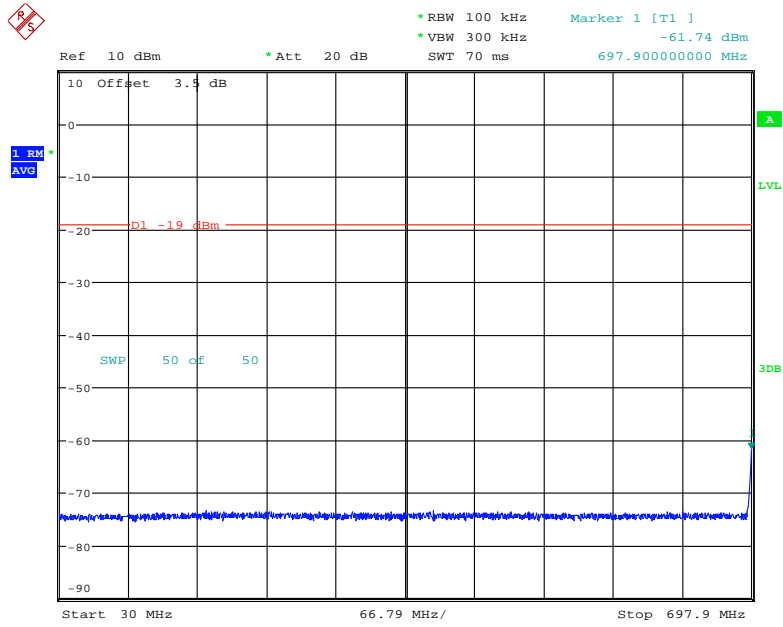

Date: 15.AUG.2019 06:47:14

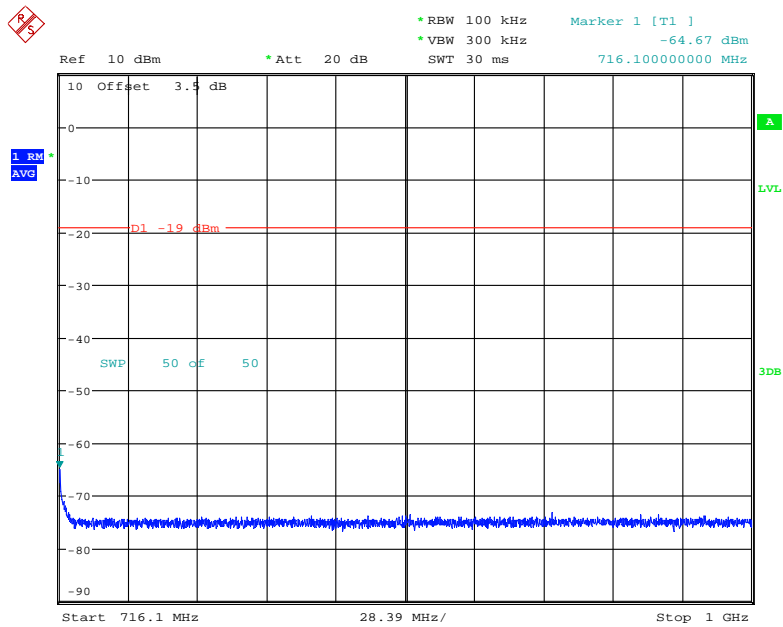

Date: 15.AUG.2019 06:48:39

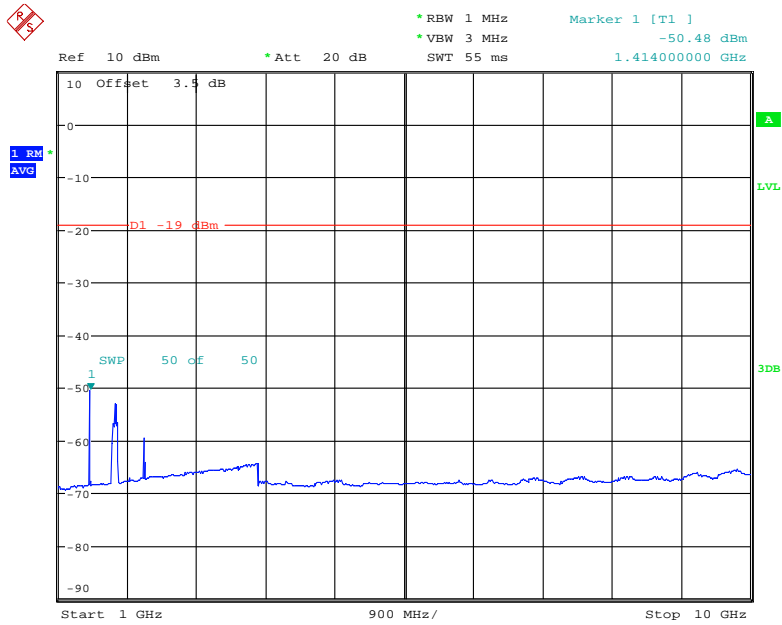

Date: 15.AUG.2019 06:49:27

### Upper 700MHz

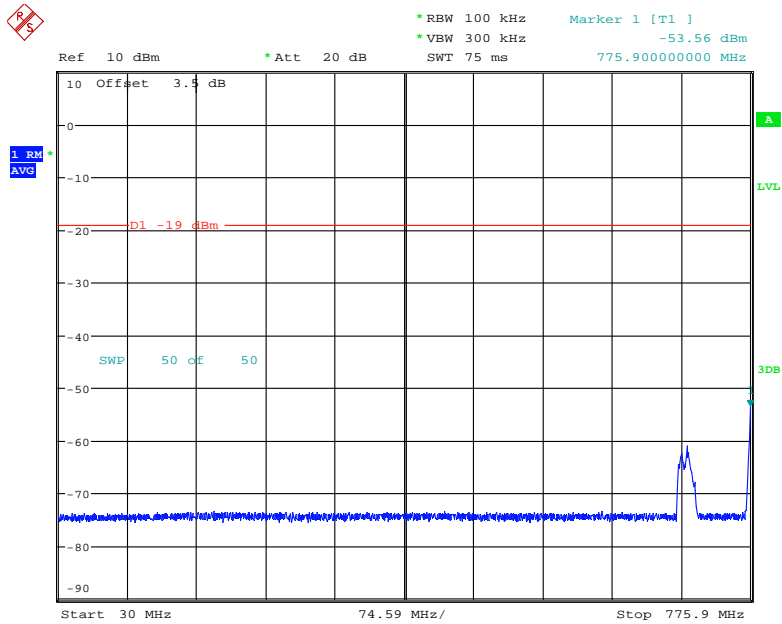

Date: 15.AUG.2019 06:51:53

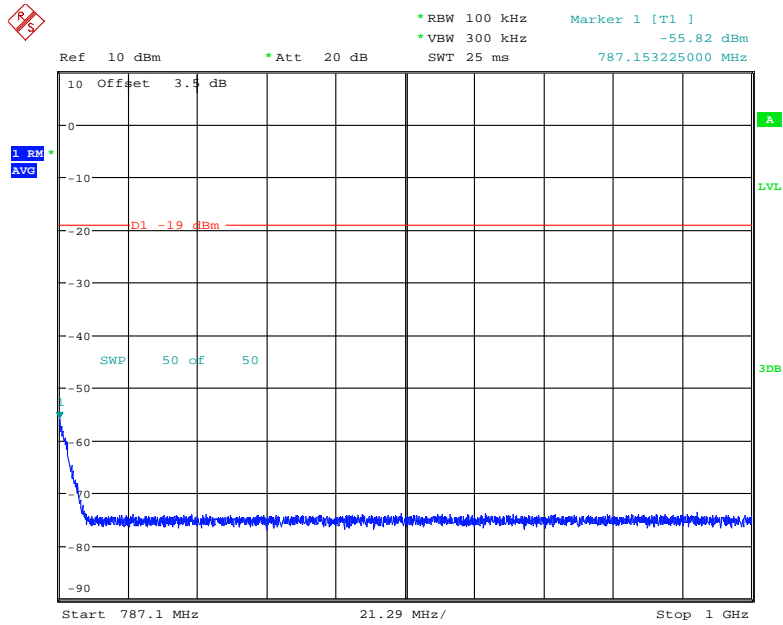

Date: 15.AUG.2019 06:52:42

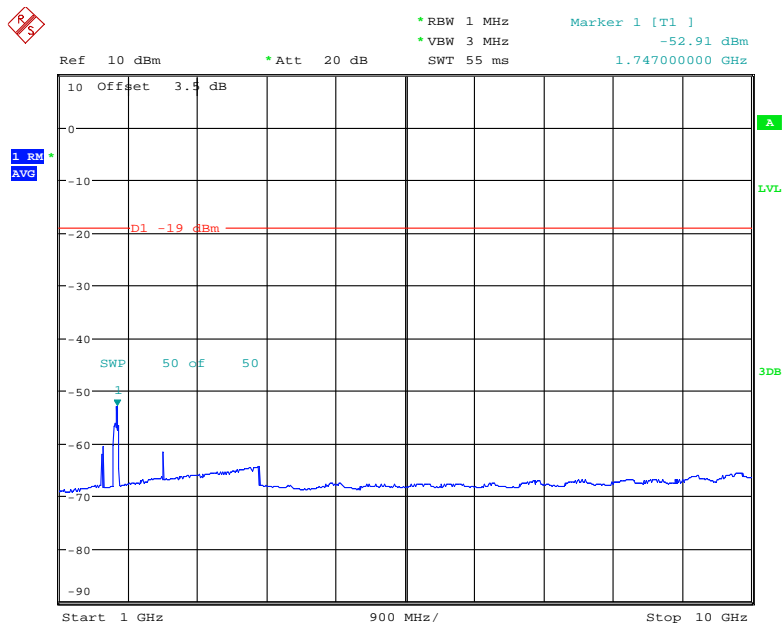

Date: 15.AUG.2019 06:50:47

**Additional requirement for upper 700MHz band**

**Uplink:**

**763 MHz~775 MHz**

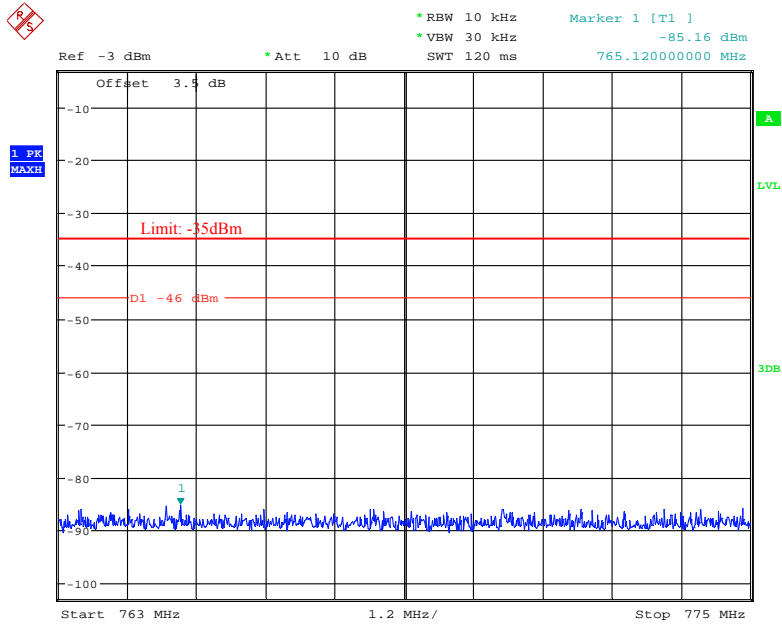

Date: 15.AUG.2019 11:41:08

**793 MHz~805 MHz**

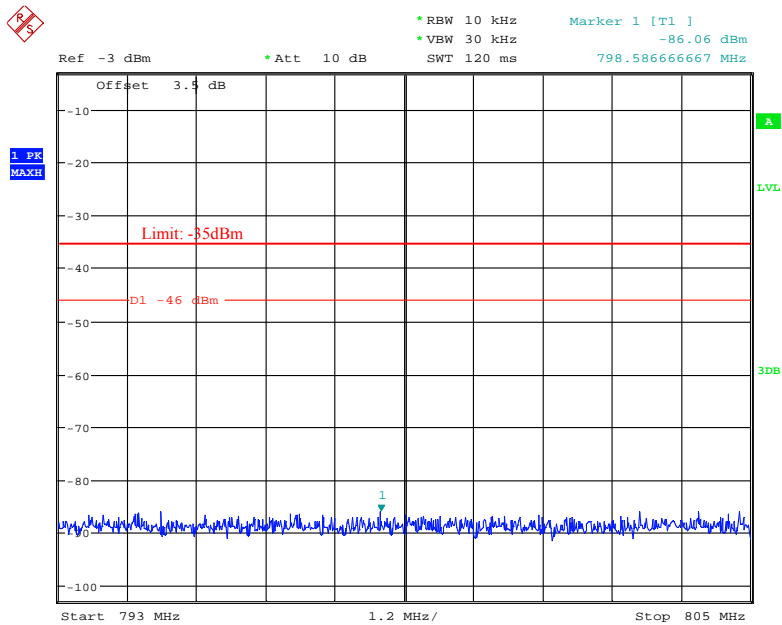

Date: 15.AUG.2019 11:40:34



### 1559 MHz~1610 MHz (wide band)

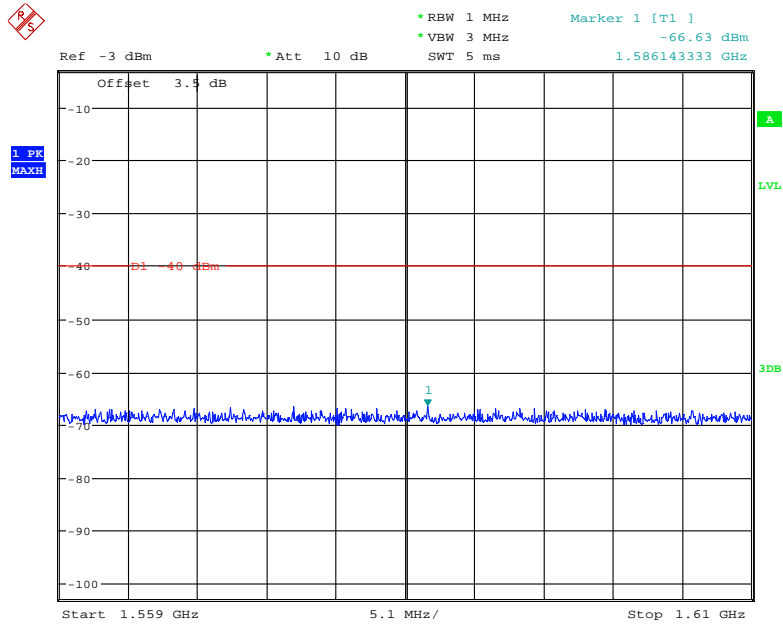

Date: 15.AUG.2019 11:42:16

### 1559 MHz~1610 MHz (narrow band)

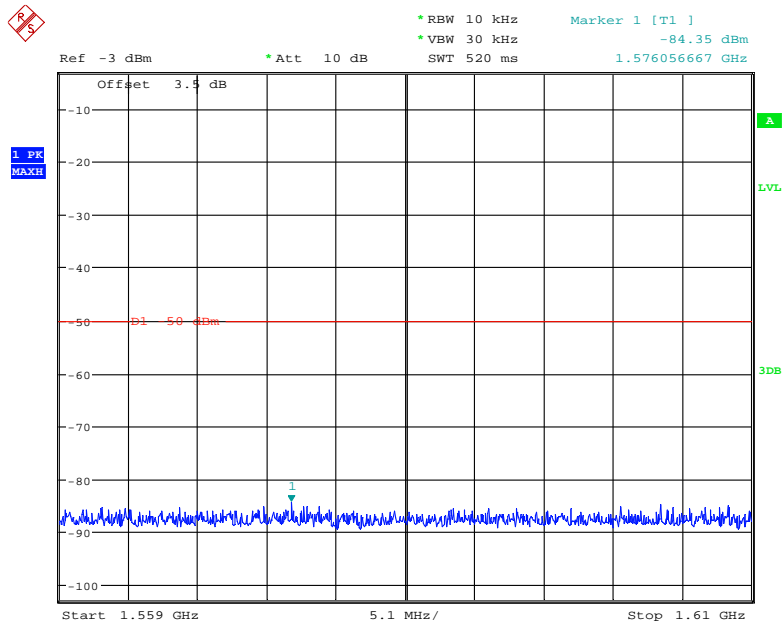

Date: 15.AUG.2019 11:41:44

Downlink:

763 MHz~775 MHz

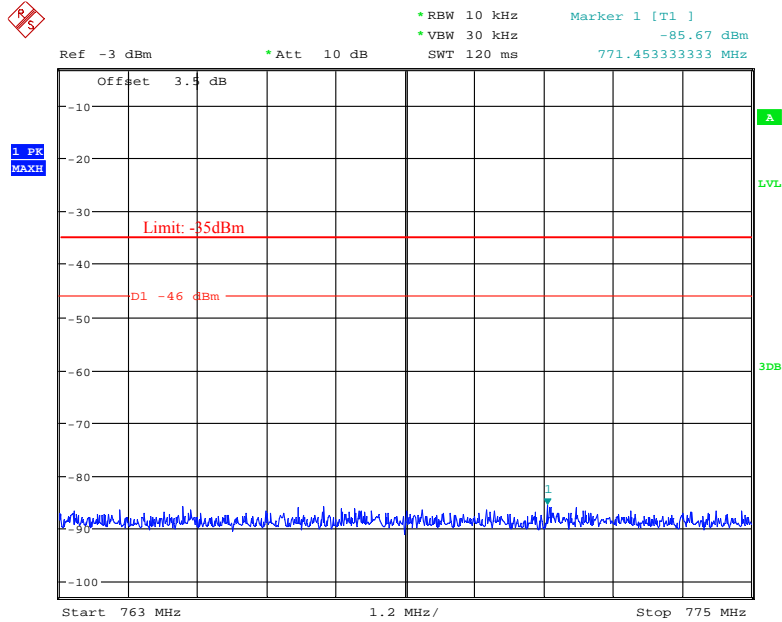

Date: 15.AUG.2019 11:37:38

793 MHz~805 MHz

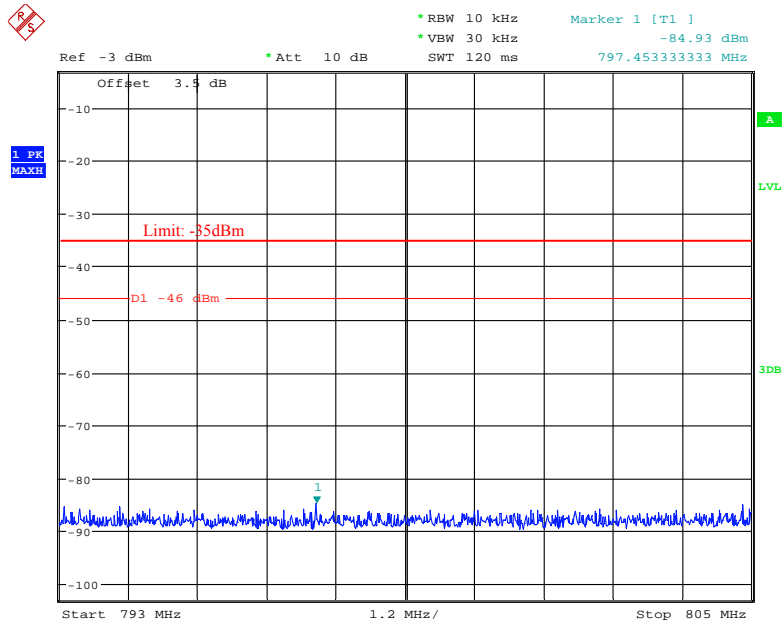

Date: 15.AUG.2019 11:38:40

### 1559 MHz~1610 MHz (wide band)

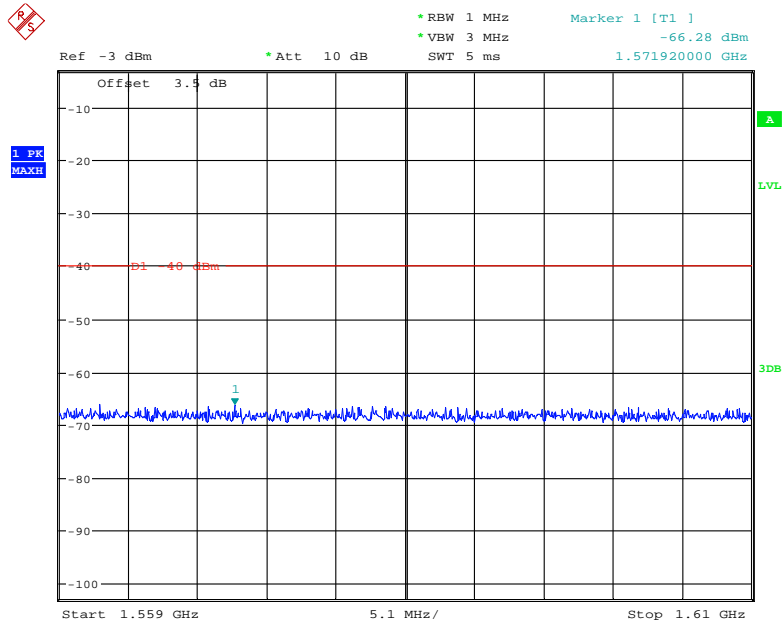

Date: 15.AUG.2019 11:34:52

### 1559 MHz~1610 MHz (narrow band)

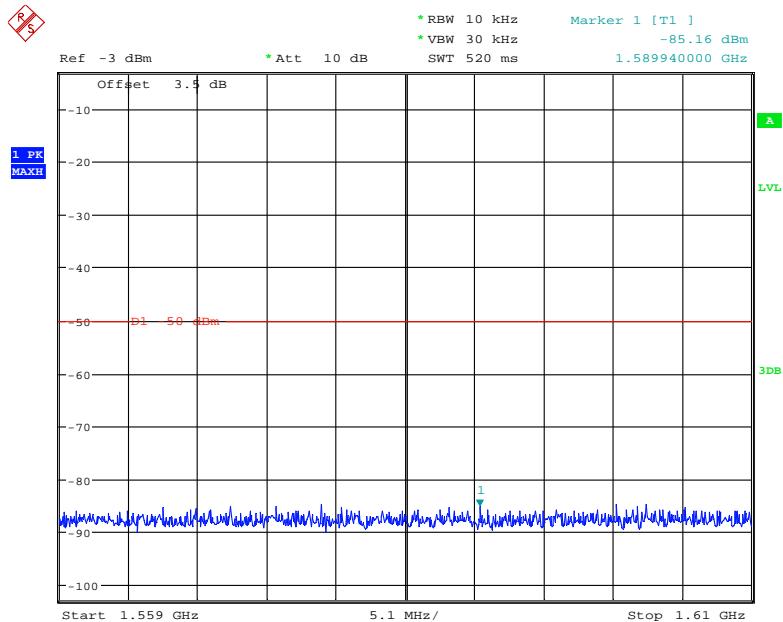

Date: 15.AUG.2019 11:35:25

## § 2.1053 - RADIATED SPURIOUS EMISSIONS

### Applicable Standards

§ 2.1053 *Measurements required: Field strength of spurious radiation.*

### Test Procedure

This procedure is intended to satisfy the requirements specified in § 2.1053. The applicable limits are those specified for mobile emissions in the rule part appropriate to the band of operation (see Annex A).

- Place the EUT on an OATS or semi-anechoic chamber turntable 3 m from the receiving antenna.
- Connect the EUT to the test equipment as shown in **Figure 10** beginning with the uplink output.
- Set the signal generator to produce a CW signal with the frequency set to the center of the operational band under test and the power level set at  $P_{IN}$  as determined from 7.2.
- Measure the radiated spurious emissions from the EUT from lowest to the highest frequencies as specified in § 2.1057. Maximize the radiated emissions by utilizing the procedures described in Clause 8 of ANSI C63.4-2014.
- Capture the peak emissions plots using a peak detector with Max-Hold for inclusion in the test report. Tabular data is acceptable in lieu of spectrum analyzer plots.
- Repeat 7.12c) through 7.12e) for all operational bands.

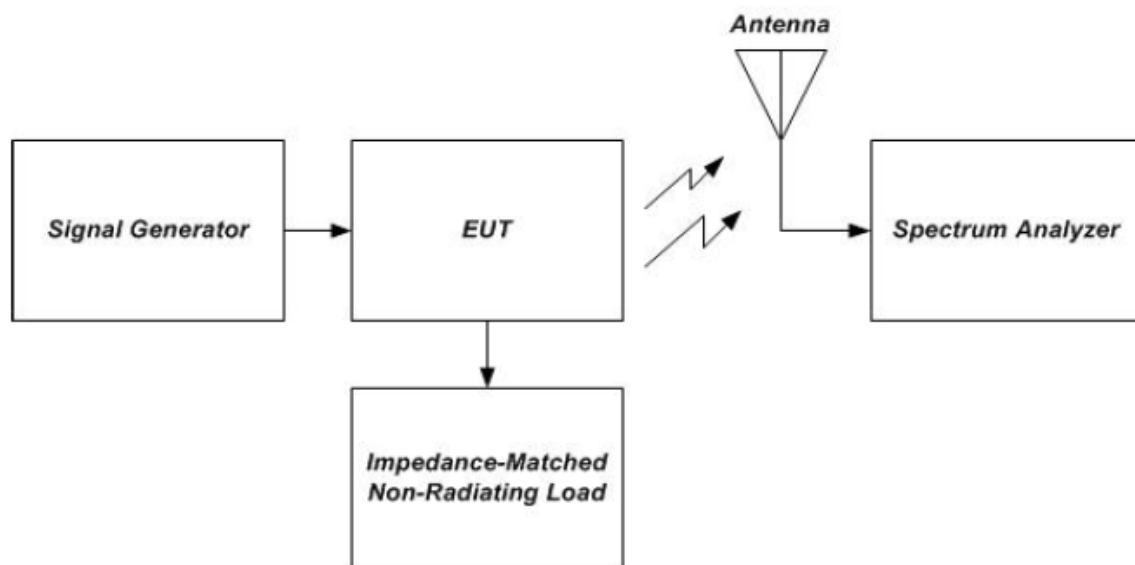

**Figure 10 – Radiated spurious emissions test instrumentation setup**

**Test Data**

**Environmental Conditions**

<b>Temperature:</b>	24 °C
<b>Relative Humidity:</b>	52 %
<b>ATM Pressure:</b>	101.2 kPa

The testing was performed by Andy Yu and Alan He on 2019-08-08.

**Test Result:** Compliance. Please refer to following table.

Test Mode: Transmitting

**Downlink:**

Frequency (MHz)	Receiver Reading (dBµV)	Polar (H / V)	Substituted Method			Absolute Level (dBm)	Limit (dBm)	Margin (dB)
			Level (dBm)	Cable loss(dB)	Antenna Gain(dBi)			
<b>Cellular Band, Test Frequency 881.5MHz</b>								
960.15	36.85	H	-63.7	1.37	0.0	-65.07	-19	46.07
960.15	35.98	V	-63.4	1.37	0.0	-64.77	-19	45.77
1763.00	43.54	H	-61.5	1.30	9.30	-53.50	-19	34.50
1763.00	44.48	V	-60.2	1.30	9.30	-52.20	-19	33.20
<b>PCS Band, Test Frequency 1962.5MHz</b>								
836.15	36.71	H	-66.0	1.35	0.0	-67.35	-19	48.35
836.15	35.80	V	-66.5	1.35	0.0	-67.85	-19	48.85
3925.00	51.27	H	-49.8	1.60	11.90	-39.50	-19	20.50
3925.00	51.30	V	-49.6	1.60	11.90	-39.30	-19	20.30
<b>AWS Band, Test Frequency 2132.5MHz</b>								
960.60	36.28	H	-64.3	1.37	0.0	-65.67	-19	46.67
960.60	36.37	V	-63.0	1.37	0.0	-64.37	-19	45.37
4265.00	44.74	H	-56.4	1.50	11.70	-46.20	-19	27.20
4265.00	43.50	V	-57.0	1.50	11.70	-46.80	-19	27.80
<b>Lower 700MHz, Test Frequency 737MHz</b>								
841.55	35.47	H	-67.2	1.35	0.0	-68.55	-19	49.55
841.55	35.18	V	-67.1	1.35	0.0	-68.45	-19	49.45
1474.00	43.02	H	-65.6	1.60	8.50	-58.70	-19	39.70
1474.00	42.15	V	-66.8	1.60	8.50	-59.90	-19	40.90
<b>Upper 700MHz, Test Frequency 751.5MHz</b>								
841.40	35.75	H	-67.0	1.35	0.0	-68.35	-19	49.35
841.40	35.09	V	-67.2	1.35	0.0	-68.55	-19	49.55
1503.00	45.70	H	-62.9	1.60	8.50	-56.00	-19	37.00
1503.00	45.96	V	-62.9	1.60	8.50	-56.00	-19	37.00

Uplink:

Frequency (MHz)	Receiver Reading (dBμV)	Polar (H / V)	Substituted Method			Absolute Level (dBm)	Limit (dBm)	Margin (dB)
			Level (dBm)	Antenna Gain (dBd/dBi)	Cable Loss (dB)			
<b>Cellular Band, Test Frequency 836.5MHz</b>								
958.36	36.74	H	-63.9	1.37	0.0	-65.27	-19	46.27
958.36	36.09	V	-63.3	1.37	0.0	-64.67	-19	45.67
1673.00	44.30	H	-62.0	1.30	8.90	-54.40	-19	35.40
1673.00	46.91	V	-58.8	1.30	8.90	-51.20	-19	32.20
<b>PCS Band, Test Frequency 1882.5MHz</b>								
835.65	36.42	H	-66.3	1.35	0.0	-67.65	-19	48.65
835.65	36.01	V	-66.3	1.35	0.0	-67.65	-19	48.65
3765.00	44.52	H	-57.9	1.50	11.80	-47.60	-19	28.60
3765.00	45.06	V	-56.9	1.50	11.80	-46.60	-19	27.60
<b>AWS Band, Test Frequency 1732.5MHz</b>								
959.50	36.85	H	-63.7	1.37	0.0	-65.07	-19	46.07
959.50	35.48	V	-63.9	1.37	0.0	-65.27	-19	46.27
3465.00	44.13	H	-56.7	1.50	12.00	-46.20	-19	27.20
3465.00	44.58	V	-57.1	1.50	12.00	-46.60	-19	27.60
<b>Lower 700MHz, Test Frequency 707MHz</b>								
841.52	36.10	H	-66.6	1.35	0.0	-67.95	-19	48.95
841.52	35.24	V	-67.0	1.35	0.0	-68.35	-19	49.35
1414.00	44.69	H	-63.5	1.60	7.90	-57.20	-19	38.20
1414.00	45.38	V	-63.1	1.60	7.90	-56.80	-19	37.80
<b>Upper 700MHz, Test Frequency 781.5MHz</b>								
841.59	36.24	H	-66.5	1.35	0.0	-67.85	-19	48.85
841.59	35.27	V	-67.0	1.35	0.0	-68.35	-19	49.35
1563.00	44.64	H	-63.4	1.40	8.70	-56.10	-46	10.10
1563.00	51.04	V	-56.8	1.40	8.70	-49.50	-46	3.50

**Note:**

- 1) Absolute Level = Substituted Level - Cable loss + Antenna Gain
- 2) Margin = Limit- Absolute Level

**\*\*\*\*\* END OF REPORT \*\*\*\*\***